

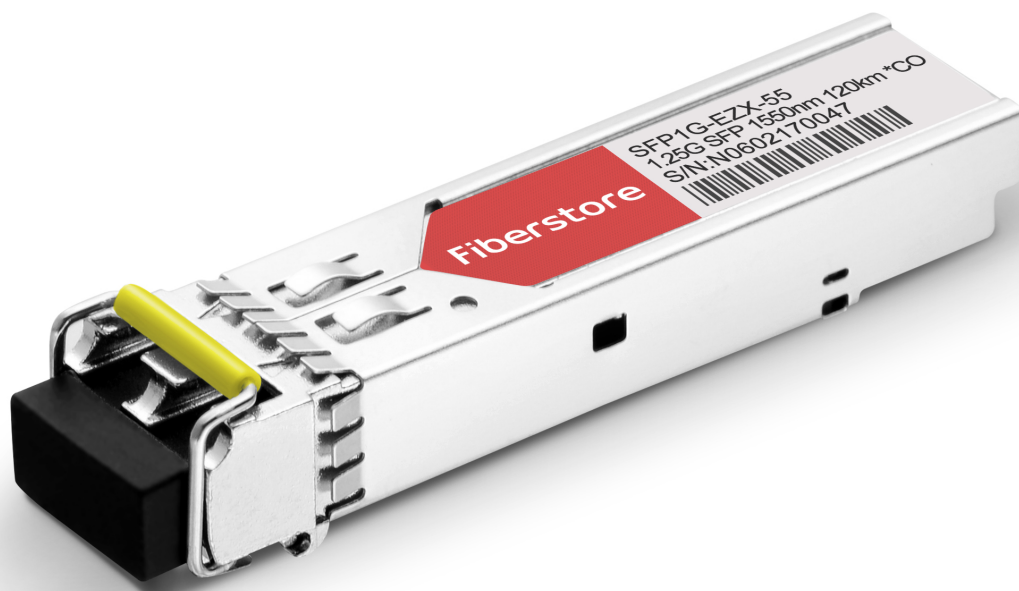

Datasheet

1000BASE-EZX SFP 1550nm 120km DOM Transceiver

SFP1G-EZX-55



Features

- Operating Data Rate up to 1.25Gbps
- 1550nm DFB Laser Transmitter
- 120km with 9/125 μm SMF
- Single 3.3V Power Supply and TTL Logic Interface
- Hot-Pluggable SFP Footprint Duplex LC Connector Interface
- Class 1 FDA and IEC60825-1 Laser Safety Compliant
- Built-in digital diagnostic functions, including optical power monitoring
- Commercial Temperature Range: 0~+70°C
- Compliant with MSA SFP Specification
- Compliant with SFF-8472

Application

- Gigabit Ethernet Switches and Routers
- Fiber Channel Switch Infrastructure
- Other Optical Links

Datasheet

Description

The SFP1G-EZX-55 series single-mode transceiver is small form factor pluggable module for serial optical data communications such as Gigabit Ethernet 1000BASE-ZX and Fiber Channel 1x SM-LC-L FC-PI. It is with the SFP 20-pin connector to allow hot plug capability. This module is designed for single mode fiber and operates at a nominal wavelength of 1550nm.

The transmitter section uses a multiple quantum well 1550nm DFB laser and is a class 1 laser compliant according to International Safety Standard IEC-60825. The receiver section uses an integrated InGaAs detector preamplifier (IDP) mounted in an optical header and a limiting post-amplifier IC. The SFP1G-EZX-55 series are designed to be compliant with SFF-8472 SFP Multi-Source Agreement (MSA).

Product Specifications

I. General Product Characteristics

Parameter	Symbol	Min	Typ.	Max	Unit
Bit Rate	BR			1.25	Gb/s
Max. Supported Link Length	L_{MAX}			120	km

II. Absolute Maximum Ratings

*Exceeding any one of these values may destroy the device immediately.

Parameter	Symbol	Min	Max	Unit
Storage Temperature	T_s	-40	+85	°C
Supply Voltage	V_{CC}	-0.5	3.6	V
Operating Relative Humidity		-	95	%



Datasheet

III. Optical and Electrical Characteristics

Parameter	Symbol	Min.	Typical	Max.	Unit
9 μ m Diameter MMF	L		120		km
Power Supply Voltage	V _{CC}	3.15	3.3	3.45	V
Power Supply Current	I _{CC}			300	Ma
Date Rate	GBE		1.25		Gbps
	FC		1.063		
Transmitter					
Center Wavelength	λ_c	1500	1550	1580	nm
Spectral Width (RMS)	$\Delta\lambda$			1	nm
Side Mode Suppression Ratio	SMSR	30			dB
Average Output Power ^{*(note1)}	P _{out}	0		5	dBm
Extinction Ratio ^{*(note2)}	ER	9			Db
Rise/Fall Time (20%~80%)	t _r /t _f			0.26	ps
Total Jitter ^{*(note2)}	TJ			0.43	UI
Output Optical Eye ^{*(note2)}	Compliant with IEEE 802.3ah-2004 ^{*(note5)}				
TX_Disable Assert Time	t _{off}			10	us
P _{out} @TX Disable Asserted	P _{out}			-45	dBm
Receiver					
Center Wavelength	λ_s	1260		1600	nm
Receiver Sensitivity ^{*(note3)}	P _{min}			-32	dBm



Datasheet

Receiver Overload	Pmax	-10			dBm
Return Loss		12			Db
Optical PathPenalty ^{*(note4)}				1	dB
LOS De-Assert	LOSD			-33	dB
LOS Assert	LOSA	-45			dBm
LOS Hysteresis ^{*(note6)}		0.5			dB

Notes:

1. Output is coupled into a 9/125μm single-mode fiber.
2. Filtered, measured with a PRBS 2⁷-1 test pattern @1.25Gbps
3. Minimum average optical power measured at BER less than 1E-12, with a 2⁷-1 PRBS and ER=9 Db.
4. Measured with a PRBS 2⁷-1 test pattern @1.25Gbps, G.652 SMF, BER≤1 × 10⁻¹⁰.
5. Eye Pattern Mask

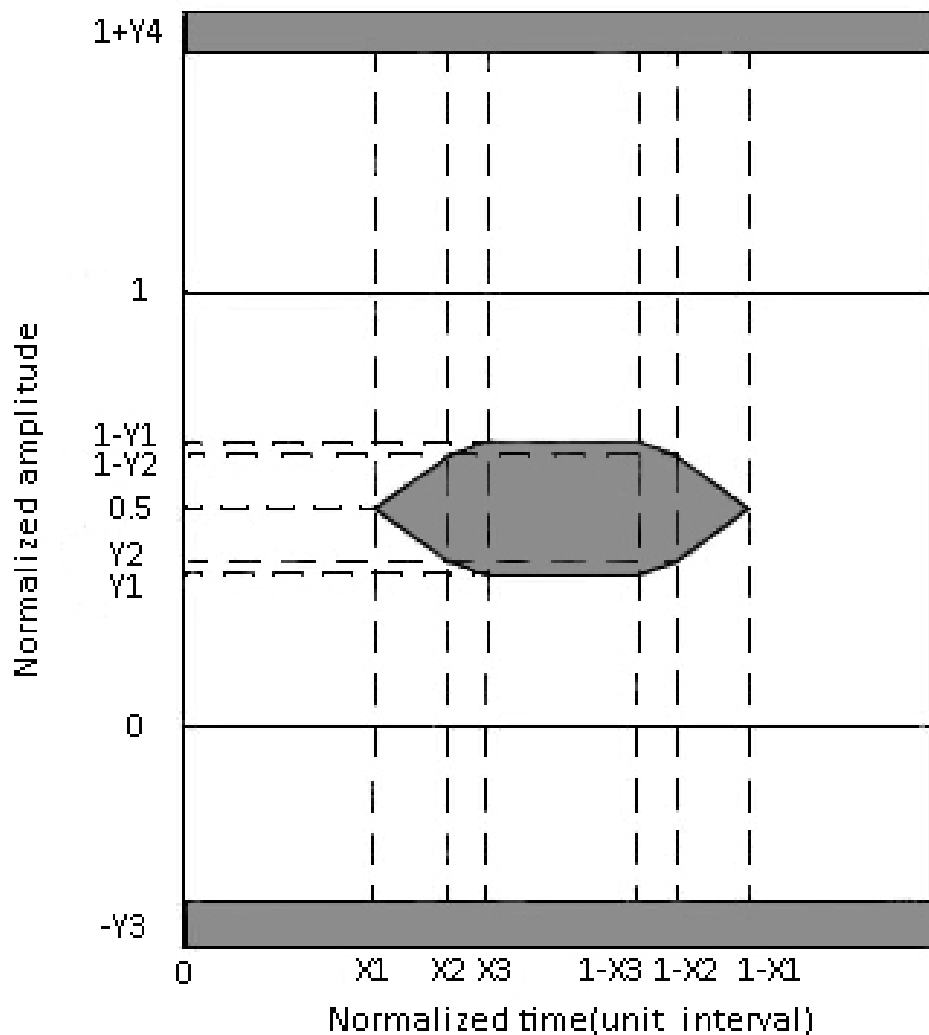



Datasheet

6. LOS Hysteresis

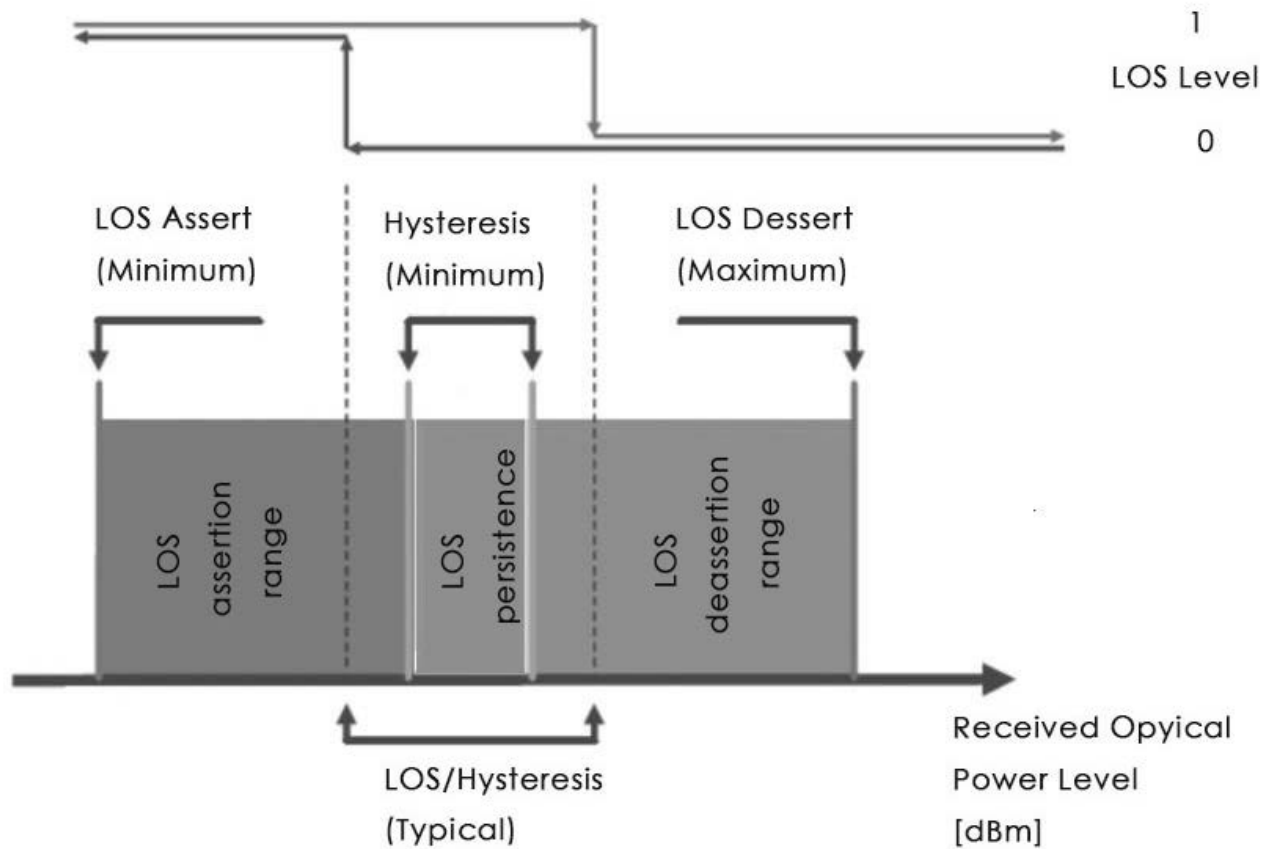

IV. Pin Description

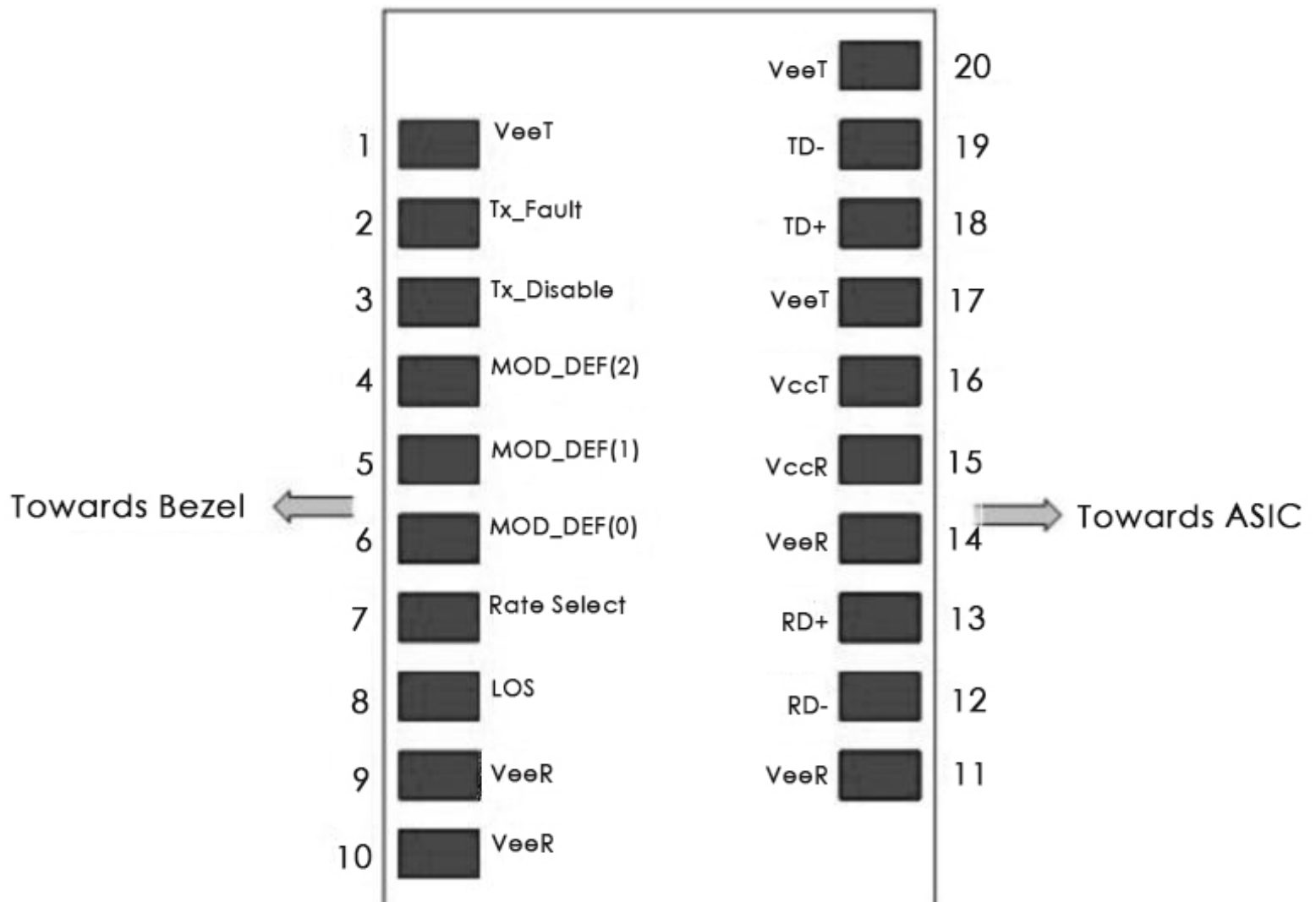

**Datasheet**

Pin Num.	Name	Function	Plug Seq.	Notes
1	VeeT	Transmitter Ground	1	Note 5
2	TX Fault	Transmitter Fault Indication	3	Note 1
3	TX Disable	Transmitter Disable	3	Note 2 Module disables on high or open
4	MOD-DEF2	SDA	3	Note 3 2 wire serial ID interface.
5	MOD-DEF1	SCL	3	Note 3 2 wire serial ID interface.
6	MOD-DEF0	MOD_ABS	3	Note 3 Grounded within the module.
7	Rate Select	Not Connect	3	Function not available
8	LOS	Loss of Signal	3	Note 4
9	VeeR	Receiver Ground	1	Note 5
10	VeeR	Receiver Ground	1	Note 5
11	VeeR	Receiver Ground	1	Note 5
12	RD-	Inv. Received Data Out	3	Note 6
13	RD+	Received Data Out	3	Note 7
14	VeeR	Receiver Ground	1	Note 5
15	VccR	Receiver Power	2	Note 7 3.3V ± 5%
16	VccT	Transmitter Power	2	Note 7 3.3V ± 5%

**Datasheet**

17	VeeT	Transmitter Ground	1	Note 5
18	TD+	Transmit Data In	3	Note 8
19	TD-	Inv. Transmit Data In	3	Note 8
20	VeeT	Transmitter Ground	1	Note 5

Notes:

1. TX Fault is an open collector/drain output, which should be pulled up with a 4.7K Ω – 10K Ω resistor on the host board. Pull up voltage between 2.0V and VccT, R+0.3V. When high, output indicates a laser fault of some kinds. Low indicates normal operation. In low state, the output will be pulled to < 0.8V.
2. TX disable is an input that is used to shut down the transmitter optical output. It is pulled up within the module with a 4.7K Ω – 10K Ω resistor. Its states are:
 Low (0 – 0.8V): Transmitter on
 (>0.8, < 2.0V): Undefined
 High (2.0 – 3.465V): Transmitter Disabled
 Open: Transmitter Disabled
3. Mod-Def 0,1,2. These are the module definition pins. They should be pulled up with a 4.7K Ω – 10K Ω resistor on the host board. The pull-up voltage shall be VccT or VccR .
 Mod-Def 0 is grounded by the module to indicate that the module is present
 Mod-Def 1 is the clock line of two wire serial interface for serial ID
 Mod-Def 2 is the data line of two wire serial interface for serial ID
4. LOS (Loss of Signal) is an open collector/drain output, which should be pulled up with a 4.7K Ω – 10K Ω resistor. Pull up voltage between 2.0V and VccT/R+0.3V. When high, this output indicates the received optical power is below the worst-case receiver sensitivity (as defined by the standard in use). Low indicates normal operation. In the low state, the output will be pulled to < 0.8V.
5. VeeR and VeeT may be internally connected within the SFP module.
6. RD-/+: These are the differential receiver outputs. They are AC coupled 100 Ω differential lines which should be terminated with 100 Ω (differential) at the user SERDES. The AC coupling is done inside the module and is thus not required on the host board. The voltage swing on these lines will be between 400 and 2000 mV differential (200 – 1000 mV single ended) when properly terminated.



Datasheet

7. VccR and VccT are the receiver and transmitter power supplies. They are defined as $3.3V \pm 5\%$ at the SFP connector pin. Maximum supply current is 300mA. Recommended host board power supply filtering is shown below. Inductors with DC resistance of less than 1 ohm should be used in order to maintain the required voltage at the SFP input pin with 3.3V supply voltage.

When the recommended supply-filtering network is used, hot plugging of the SFP transceiver module will result in an inrush current of no more than 30mA greater than the steady state value. VccR and VccT may be internally connected within the SFP transceiver module.

8. TD-/+: TD-/+: These are the differential transmitter inputs. They are AC-coupled, differential lines with 100Ω differential termination inside the module. The AC coupling is done inside the module and is thus not required on the host board. The inputs will accept differential swings of 400 – 2000mV (200 – 1000mV single-ended).

V. Mechanical Specifications

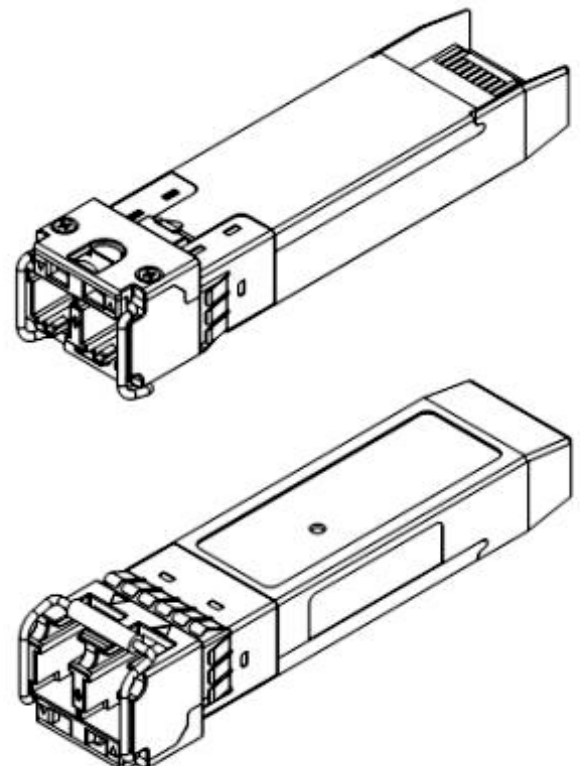
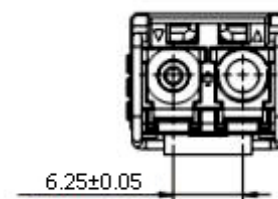
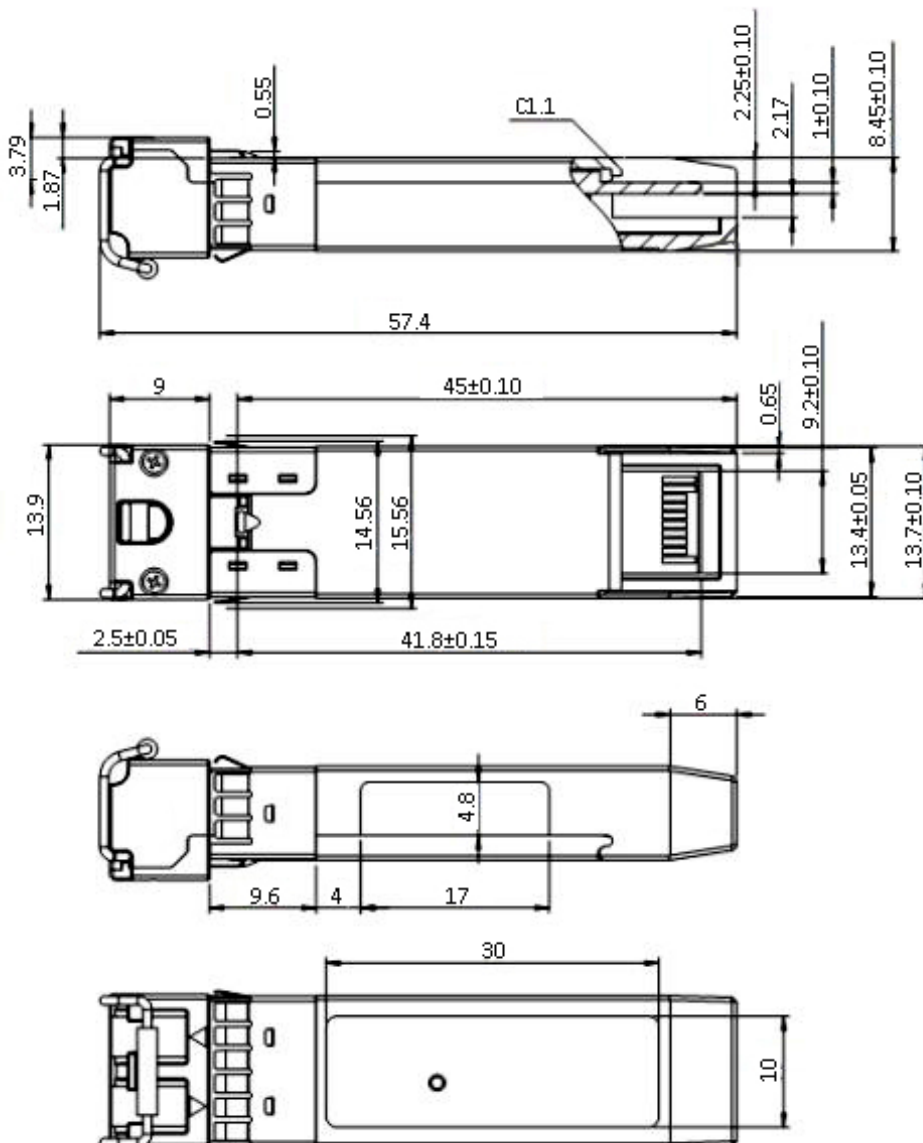



Datasheet

Test Center

Only when quality and 100% compatibility is verified and proved do our modules enter the market. This depends on FS.COM's test center which is supported by a variety of mainstream original brand switches and professional staff. We are proud of this test center and believe all of these devices worth the investments, because it brings the best to our customers.

The original switches could be found nowhere but at FS.COM's test center, eg: Juniper MX960 & EX 4300 series, Cisco Nexus 9396PX & Cisco ASR 9000 Series, HP 5900 Series & HP 5406R ZL2 V3(J9996A), Arista 7050S-64, Brocade ICX7750-26Q & ICX6610-48, Avaya VSP 7000 MDA 2, etc.



Cisco ASR 9000 Series(A9K-MPA-1X40GE)



ARISTA 7050S-64(DCS-7050S-64)



Juniper MX960



Brocade ICX 7750-26Q



Extreme Networks X670V VIM-40G4X



Mellanox M3601Q



Dell N4032F



HP 5406R ZL2 V3(J9996A)



AVAYA 7024XLS(7002QQ-MDA)

Datasheet

Test Assured Program

FS.COM truly understands the value of compatibility and interoperability to each optics. Every module FS.COM provides must run through programming and an extensive series of platform diagnostic tests to prove its performance and compatibility. In our test center, we care of every detail from staff to facilities—professionally trained staff, advanced test facilities and comprehensive original-brand switches, to ensure our customers to receive the optics with superior quality.



Our smart data system allows effective product management and quality control according to the unique serial number, properly tracing the order, shipment and every part.

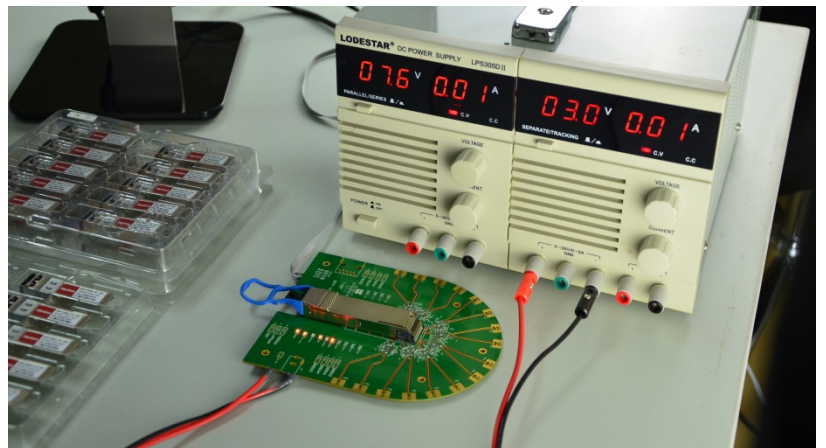

Our in-house coding facility programs all of our parts to standard OEM specs for compatibility on all major vendors and systems such as Cisco, Juniper, Brocade, HP, Dell, Arista and so on.



With a comprehensive line of original-brand switches, we can recreate an environment and test each optics in practical application to ensure quality and distance.



The last test assured step to ensure our products to be shipped with perfect package.

Datasheet

Order Information

Part Number	Description
SFP1G-SX-85	SFP, 1000BASE-SX, 850nm, MMF, 550m, LC, DOM
SFP1G-SX-31	SFP, 1000BASE-SX, 1310nm, SMF, 2km, LC, DOM
SFP1G-LX-31	SFP, 1000BASE-LX, 1310nm, SMF, 10km, LC, DOM
SFP1G-LX-31	SFP, 1000BASE-LX, 1310nm, SMF, 15km, LC, DOM
SFP1G-LX-31	SFP, 1000BASE-LX/LH, 1310nm, SMF, 20km, LC, DOM
SFP1G-LH-31	SFP, 1000BASE-EX, 1310nm, SMF, 40km, LC, DOM
SFP1G-EX-55	SFP, 1000BASE-EX, 1550nm, SMF, 40km, LC, DOM
SFP1G-ZX-55	SFP, 1000BASE-EX, 1550nm, SMF, 60km, LC, DOM
SFP1G-ZX-55	SFP, 1000BASE-ZX, 1550nm, SMF, 80km, LC, DOM
SFP1G-EZX-55	SFP, 1000BASE-EZX, 1550nm, SMF, 100km, LC, DOM
SFP1G-EZX-55	SFP, 1000BASE-EZX, 1550nm, SMF, 120km, LC, DOM
SFP-GB-T	SFP, 1000BASE-T, SERDES/SGMII Interface
SFP-GB-T	SFP, 10/100/1000BASE-T, SERDES Interface

Note:

Every transceiver is individually tested on corresponding equipment, walks through the testing challenges and 100% compatible with Cisco, Arista, Juniper, Dell, Brocade and other brands.

**Datasheet****Contact Us**

Fiberstore China
Room 301, Third Floor, Weiyong
Building, No. 10 Kefa Road,
Nanshan District, Shenzhen, 518057,
China
Tel: +86 (755) 8300 3611
Fax: +86 (755) 8326 9395

Fiberstore U.K.
Third Floor 207 Regent Street,
London, W1B 3HH,
United Kingdom
Tel: +44 (020) 3287 6810

Fiberstore Hong Kong
1220 Tung Chun Commercial
Centre, 438-444 Shanghai Street,
Kowloon, HongKong
Tel: +(852) 817 636 06
Fax: +(852) 817 636 06

Fiberstore U.S.
331 Andover Park East Ste330,
Tukwila, WA 98188,
United States
Tel: +1-425-226-2035
Fax: +1-253-246-7881

Addresses, phone number and fax number also have been listed at www.fs.com. Please e-mail us at sales@fs.com or call us for assistance.

All statements, technical information, and recommendations related to the products here are based upon information believed to be reliable or accurate. However, the accuracy or completeness thereof is not guaranteed, and no responsibility is assumed for any inaccuracies. Please contact FS for more information.