

PoE+ Series Switches STP Configuration Guide

Models: S3150-8T2FP
S3260-8T2FP
S3260-16T4FP
S3400-24T4FP
S3400-48T4SP

Contents

Chapter 1 Configuring STP.....	1
1.1 STP Introduction.....	1
1.2 SSTP Configuration Task List.....	2
1.3 SSTP Configuration Tasks.....	2
1.3.1 Choosing the STP Mode.....	2
1.3.2 Disabling/Enabling STP.....	2
1.3.3 Disabling/Enabling STP on a Port.....	3
1.3.4 Setting the Bridge Priority.....	3
1.3.5 Setting the Hello Time.....	4
1.3.6 Setting the Max Age.....	4
1.3.7 Setting the Forward Delay.....	4
1.3.8 Setting the Port Priority.....	4
1.3.9 Value of the path cost of a port.....	5
1.3.10 Monitoring the STP state.....	5
1.3.11 Setting the SNMP Trap.....	5
1.4 Setting the Spanning Tree of VLAN.....	6
1.4.1 Overview.....	6
1.4.2 VLAN STP Configuration Tasks.....	6
Chapter 2 Configuring RSTP.....	8
2.1 RSTP Configuration Task List.....	8
2.2 RSTP Configuration Tasks.....	8
2.2.1 Enabling/disabling RSTP of the Switch.....	8
2.2.2 Setting the Bridge Priority.....	8
2.2.3 Setting the Forward Time.....	9
2.2.4 Setting the Hello Time.....	9
2.2.5 Setting the Max Age.....	10
2.2.6 Value of the path cost of a port.....	10
2.2.7 Setting the Port Priority.....	10
2.2.8 Setting the Edge Port.....	11
2.2.9 Setting the Port Connection Type.....	11
2.2.10 Restarting the protocol conversion check.....	12
Chapter 3 Configuring MSTP.....	13
3.1 MSTP Introduction.....	13
3.1.1 Overview.....	13
3.1.2 MST Region.....	13
3.1.3 IST, CST, CIST and MSTI.....	13
3.1.4 Port Role.....	15
3.1.5 MSTP BPDU.....	18
3.1.6 Stable State.....	19
3.1.7 Hop Count.....	20
3.1.8 STP Compatibility.....	20
3.2 MSTP Configuration Task List.....	20
3.3 MSTP Configuration Tasks.....	21
3.3.1 Default MSTP Configuration.....	21

3.3.2 Enabling and disabling MSTP.....	22
3.3.3 Configuring MSTP region.....	22
3.3.4 Configuring network root.....	23
3.3.5 Configuring secondary root.....	24
3.3.6 Configuring Bridge Priority.....	25
3.3.7 Configuring time parameters of STP.....	25
3.3.8 Configuring network diameter.....	26
3.3.9 Configuring maximum hop count.....	27
3.3.10 Setting the Port Priority.....	27
3.3.11 Value of the path cost of a port.....	28
3.3.12 Setting the Edge Port.....	28
3.3.13 Setting the Port Connection Type.....	28
3.3.14 Activating MST-compatible mode.....	29
3.3.15 Restarting the protocol conversion check.....	30
3.3.16 Configuring role restriction of the port.....	30
3.3.17 Configuring TCN restriction of the port.....	30
3.3.18 Check MSTP information.....	31

Chapter 1 Configuring STP

1.1 STP Introduction

The standard Spanning Tree Protocol (STP) is based on the IEEE 802.1D standard. An OLT stack appears as a single spanning-tree node to the rest of the network, and all stack members use the same bridge ID.

The spanning-tree algorithm and the spanning-tree protocol can set any bridge LAN to be a simply connected mobile topology. In the mobile topology, some bridge ports can forward frames, while other ports are blocked and cannot forward data. A port in blocked state can also be contained in the mobile topology. When some network device is out of effect, added or removed, the port in blocked state will enter the forwarding state.

In the spanning-tree topology, a bridge is regarded as a root or a root bridge. Each LAN segment has a bridge port to take in charge of data forwarding from this network segment to the root. This bridge port is regarded as the designated port of this LAN segment, while the bridge where the bridge port locates is regarded as the designated bridge of LAN. The root is the designated bridge of each LAN segment that connects this root. In each bridge port, the port that is nearest to the root bridge is the root port of this bridge and only the root port and the designated port are in forwarding state; another kind of ports are open, but they are not root ports or designated ports but standby ports.

The following parameters decide the structure of the stable mobile topology:

- (1) Each unique bridge identifier
- (2) path cost of each port
- (3) ID of each bridge port

The bridge with the highest priority (the identifier value is the smallest) will be chosen as the root bridge. The ports of each bridge in the network all have root path cost, that is, the root path cost is the smallest value of the path cost sum of all ports between the root bridge and the bridge. The designated port of each LAN segment means the port that connect this LAN segment and has the smallest root path cost; if several ports have the same root path cost, their bridge identifiers will first be compared and then their port identifiers. According to this method, each LAN segment has only one designated port and each bridge has only one root port.

The spanning tree topology makes the loop in-existent in a network, guaranteeing the stability and fault recovery of the network. With the wide spread of Ethernet switch, STP plays a more and more important role. Therefore, STP is provided as a basic function of switches.

Rapid Spanning-Tree Protocol (RSTP) is an important update of 802.1D STP. When faults occur in the bridge, bridge port or LAN segment in a network, RSTP will realize the rapid convergence of the network topology. In this case, the new root port on the bridge will enter the forwarding state promptly, and at the same time the direct

acceptance between bridges can make a designated port to forward data immediately. Please refer to Chapter 2 for RSTP protocol [Configuring RSTP](#).

This chapter describes how to configure the standard STP of the switch.

Note:

802.1D STP and 802.1D RSTP mentioned in this text are simplified as SSTP and RSTP respectively. SSTP here is short for Single Spanning-Tree Protocol.

1.2 SSTP Configuration Task List

- [Choosing the STP Mode](#)
- [Disabling/Enabling STP](#)
- [Disabling/Enabling STP on a Port](#)
- [Setting the Bridge Priority](#)
- [Setting the Hello Time](#)
- [Setting the Max Age](#)
- [Setting the Forward Delay](#)
- [Setting the Port Priority](#)
- [Value of the path cost of a port](#)
- [Monitoring the STP state](#)
- [Setting the SNMP Trap](#)

1.3 SSTP Configuration Tasks

1.3.1 Choosing the STP Mode

Run the following command to set the STP mode:

Command	Purpose
spanning-tree mode {sstp pvst rstp mstp}	Selects the STP mode.

1.3.2 Disabling/Enabling STP

By default, when STP is started, the running mode is RSTP; if STP is not required, you can stop it from running.

Run the following command to disable STP:

Command	Purpose
---------	---------

no spanning-tree	Disables STP.
-------------------------	---------------

Run the following commands to enable STP:

Command	Purpose
spanning-tree	Enables STP that runs in default mode—RSTP.
spanning-tree mode {sstp pvst rstp mstp}	Selects a mode for the enabled STP.

1.3.3 Disabling/Enabling STP on a Port

By default, STP is running on all switch ports (physical ports and aggregation ports); if you want to disable STP, you can run the following command in port configuration mode.

Command	Purpose
no spanning-tree	Disables STP to run on the ports.

After STP is forbidden to run on a port, this port maintains a designated port and its forwarding state and stops to transmit BPDU again. However, each STP mode still has such operations as type checkup, numbering, edge information update and topology information update towards BPDU that a port receives.

Note:

When no spanning-tree is set and a port has served as a root port, alternate port, master port or backup port, the protocol information that this port receives in RSTP/MSTP mode will age immediately and transfer to be a designated port, while the protocol information that this port receives in SSTP/PVST mode will remain the original role for a certain period and then age after the timer times out.

Note:

Every STP mode supports the BPDU Guard function on the port on which no spanning-tree is set.

1.3.4 Setting the Bridge Priority

You can choose the spanning-tree root of the network topology by changing the bridge priority of a switch.

Run the following commands to set the bridge priority of SSTP:

Command	Purpose
spanning-tree sstp priority <i>value</i>	Modifies the bridge priority of the SSTP mode.
no spanning-tree sstp priority	Resumes the SSTP bridge priority to the default value, 32768.

1.3.5 Setting the Hello Time

You can configure the hello time of the SSTP to decide the packet transmission's interval when the switch works as the root.

Run the following commands to set the SSTP hello time.

Command	Purpose
spanning-tree sstp hello-time <i>value</i>	Modifies the hello time in SSTP mode.
no spanning-tree sstp hello-time	Resumes the Sstp hello time to the default value, 2 seconds.

1.3.6 Setting the Max Age

You can configure the Sstp max age to decide the maximum lifespan of the packet when the switch works as the root.

Run the following commands to configure the Sstp max age.

Command	Purpose
spanning-tree sstp max-age <i>value</i>	Modifies the Max Age of the Sstp mode.
no spanning-tree sstp max-age	Resumes the max age to the default value, 20 seconds.

1.3.7 Setting the Forward Delay

You can configure the forward delay time of the Sstp to decide the state change interval of all switches when these switches works as the root.

Run the following commands to configure the Sstp forward delay.

Command	Purpose
spanning-tree sstp forward-time <i>value</i>	Modifies the forward time of the Sstp mode.
no spanning-tree sstp forward-time	Resumes the default forward time, 15 seconds.

1.3.8 Setting the PortPriority

When a loop generates, STP will change the states of some ports to the blocking state to cut off the loop. You can control whether to block a port by setting the port priority and the port path cost.

Run the following commands to set the port priority of Sstp:

Command	Purpose
spanning-tree port-priority <i>value</i>	Sets the port priority in all modes.
spanning-tree sstp port-priority <i>value</i>	Modifies the port priority of the Sstp mode.
no spanning-tree sstp port-priority	Resumes the port priority to the default value,

	128.
--	------

1.3.9 Value of the path cost of a port

Run the following commands to set the port path cost of SSTP.

Command	Purpose
spanning-tree cost <i>value</i>	Sets the port priority in all modes.
spanning-tree sstp cost <i>value</i>	Modifies the port path cost in SSTP mode.
no spanning-tree sstp cost	Resumes the port path cost to the default value.

1.3.10 Monitoring the STP state

To monitor STP configuration and STP's state, run the following commands in EXEC mode:

Command	Purpose
show spanning-tree	Displays the state of STP in current mode.
show spanning-tree detail	Displays the detailed information about STP in current mode.
show spanning-tree interface	Displays the information about a port in STP in current mode.

1.3.11 Setting the SNMP Trap

You can monitor the change of STP in a switch remotely from the network management software of the host by configuring the trap function of STP.

STP protocols support two types of traps: newRoot and topologyChange. When a switch changes from a non-root to a root, the newRoot Trap message will be transmitted; when the topology change is detected, such as a non-edge port is changed from the non-forwarding state to the forwarding state, the topologyChange Trap message will be transmitted.

Note:

The STP trap can be received only when the network management software supports trap reception. The network management need be imported into the bridge MIB and OID is 1.3.6.1.2.1.17.

Run the following commands in global configuration mode to enable the STP trap:

Command	Purpose
spanning-tree management trap [newroot topologychange]	Enables the STP trap. If the trap type is not designated, two kinds of traps will be enabled at the same time.
no spanning-tree management trap	Disables the STP trap.

1.4 Setting the Spanning Tree of VLAN

1.4.1 Overview

In SSTP mode, the whole network only has one spanning-tree instance, and the state of a port in the spanning tree decides its state in all VLANs. When multiple VLANs exist in a network, the isolation between SSTP and VLAN topology may lead to the communication block of some network parts.

The switch supports that independent SSTP runs on a certain number of VLANs and guarantees that a port has different states in different VLANs. At the same time the flow balance can be realized between VLANs.

It should be noted that the VLAN number which can independently running STP protocol depends on the actual version. Other VLAN topology exceeding the number limit will not be affected by STP.

1.4.2 VLAN STP Configuration Tasks

Run the following commands to set the features of SSTP in VLAN:

Command	Purpose
spanning-tree mode pvst	Enables STP distribution according to VLAN.
spanning-tree vlan <i>vlan-list</i>	Distributes the STP instance for a designated VLAN. <i>vlan-list</i> means the VLAN list (similarly hereinafter).
no spanning-tree vlan <i>vlan-list</i>	Deletes the spanning-tree instance in a designated VLAN
spanning-tree vlan <i>vlan-list</i> priority <i>value</i>	Sets the spanning-tree priority in a designated VLAN.
no spanning-tree <i>vlan-list</i> priority	Resumes the spanning-tree priority in a VLAN to the default value.
spanning-tree vlan <i>vlan-list</i> forward-time <i>value</i>	Sets the Forward Delay of a designated VLAN.
no spanning-tree vlan <i>vlan-list</i> forward-time	Resumes the Forward Delay of a designated VLAN.
spanning-tree vlan <i>vlan-list</i> max-age <i>value</i>	Sets the max age of a designated VLAN.
no spanning-tree vlan <i>vlan-list</i> max-age	Resumes the Max-Age of a designated VLAN to the default value.
spanning-tree vlan <i>vlan-list</i> hello-time <i>value</i>	Sets the Hello-time of a designated VLAN.
no spanning-tree vlan <i>vlan-list</i> hello-time	Resumes the hello-time of a designated VLAN to the default value.

Run the following commands to set the port's features in switch port configuration mode:

Command	Purpose
spanning-tree vlan <i>vlan-list</i> cost	Sets the path cost of a port in a designated VLAN.
no spanning-tree vlan <i>vlan-list</i> cost	Resumes the path cost of a port in VLAN to the default value.
spanning-tree vlan <i>vlan-list</i> port-priority	Sets the port priority in VLAN.
no spanning-tree vlan <i>vlan-list</i> port-priority	Resumes the priority of a port in VLAN to the default value.

In monitor or configuration mode, run the following commands to browse the state of the spanning tree in a designated VLAN:

Command	Purpose
show spanning-tree vlan <i>vlan-list</i>	Browns the state of the spanning tree in a VLAN.
show spanning-tree pvst instance-list	To check the corresponding relation between PVST instances and VLAN, run this command.

Chapter 2 Configuring RSTP

2.1 RSTP Configuration Task List

- [Enabling/disabling RSTP of the Switch](#)
- [Setting the Bridge Priority](#)
- [Setting the Forward Time](#)
- [Setting the Hello Time](#)
- [Setting the Max Age](#)
- [Value of the path cost of a port](#)
- [Setting the Port Priority](#)
- [Setting the Edge Port](#)
- [Setting the Port Connection Type](#)
- [Restarting the protocol conversion check](#)

2.2 RSTP Configuration Tasks

2.2.1 Enabling/disabling RSTP of the Switch

Run the following commands in global configuration mode.

Command	Purpose
spanning-tree mode rstp	Enables RSTP.
no spanning-tree mode	Disables stp funciton.

2.2.2 Settingthe Bridge Priority

The bridge priority decides whether this bridge can be chosen as the root bridge of the whole spanning tree. Setting a comparatively low priority can make a bridge to be the root bridge of the spanning tree.

Run the following commands in global configuration mode.

Command	Purpose
spanning-tree rstp priority <i>value</i>	Sets the priority of a bridge.
no spanning-tree rstp priority	Resumes the bridge priority to be the default

	value.
--	--------

It is especially noted that if the priorities of all bridges in an entire OLT network have the same value the bridge with the smallest MAC address will be chosen as the root bridge. In case that RSTP is enabled, if the bridge priority is changed the spanning tree will be calculated again.

In the default settings, the bridge priority is set to 32768.

2.2.3 Setting the Forward Time

Link fault will trigger the recalculation of the spanning-tree structure, but the new configuration information, which is obtained through recalculation, cannot be sent to the whole network immediately; if the newly chosen root port and designated port starts data forwarding immediately, temporary loop may be caused. To solve this problem, RSTP adopts a state removal mechanism. Before the root port and the designated port begin to forward data, an intermediate state must be experienced. The intermediate state changes into the forwarding state after the forward delay that guarantees the new configuration information has spread all over the whole network. The Forward Delay of a bridge depends on the diameter of the OLT network. Generally speaking, the longer the network diameter is, the longer the forward delay should be set to be.

Run the following commands in global configuration mode.

Command	Purpose
spanning-tree rstp forward-time <i>value</i>	Sets the Forward Delay.
no spanning-tree rstp forward-time	Resumes the default forward delay, 15 seconds.

It is especially noted that if Forward Delay is set too small the temporary redundant path may occur in the network, but if Forward Delay is set too big the network may be disconnected for a long time. That's why users are recommended to take the default value.

In the default settings, the forward delay of a bridge is 15 seconds.

2.2.4 Setting the Hello Time

A suitable hello time not only guarantees that a bridge can detect a link fault in a network promptly but also occupies a few network resources.

Run the following commands in global configuration mode.

Command	Purpose
spanning-tree rstp hello-time <i>value</i>	Sets the Hello Time.
no spanning-tree rstp hello-time	Resumes the hello time to the default value.

It takes attention that if a long hello time is set, packet loss in the links may cause a bridge not to receive the hello packets for a long time and the bridge then regards the occurrence of link faults and starts spanning-tree recalculation, but if a too short hello time is set the bridge will frequently send the configuration information and then the network bandwidth will be heavily occupied and the network/CPU load will be increased. That's why users are recommended to take the default value.

In the default settings, the hello time of a bridge is 2 seconds.

2.2.5 Setting the Max Age

The max age is used to judge whether the configuration information expires. Users can set the max age according actual conditions.

Run the following commands in global configuration mode.

Command	Purpose
spanning-tree rstp max-age <i>value</i>	Setting the Max Age
no spanning-tree rstp max-age	Resumes the max age to the default value, 20 seconds.

Link fault, reduces the network auto-adaptivity. We recommend user to use the default value. Note: if you configure the Max Age to a relatively small value, then the calculation of the spanning tree will be relatively frequent, and the system may regard the network block as link failure. If you configure the Max Age to a relatively big value, then the link status will go unnoticed in time.

The Max Age of bridge is 20 seconds by default.

2.2.6 Value of the path cost of a port

The path cost is related with the link rate of the port. If the link rate is required to be high, the path cost should be set to a small value; when the path cost is set to its default value, RSTP can automatically check the link rate of the current Ethernet port and calculate the corresponding path cost.

Run the following commands in interface configuration mode.

Command	Purpose
spanning-tree rstp cost <i>value</i>	Sets the path cost of a port.
no spanning-tree rstp cost	Resumes the path cost of a port to the default value.

It is especially noted that the settings of the path cost will lead to the recalculation of the spanning tree, so users are recommended to take the default value and wait RSTP to calculate the path cost of the current Ethernet port automatically.

By default, the path costs of all Ethernet ports of a bridge are all set to 2000,000 at the 10Mbps port rate, or set to 200,000 at the 100Mbps port rate.

2.2.7 Setting the Port Priority

Port priority settings can be used to designate a specific Ethernet port to be contained in the spanning tree. In general, the smaller the value is, the higher the port priority is, and the Ethernet port has more possibility to be contained in the spanning tree. If all Ethernet ports of a bridge adopt the same priority value, the index number of an Ethernet port decides whether the Ethernet port has a high priority or not.

Run the following commands in interface configuration mode.

Command	Purpose
spanning-tree rstp port-priority <i>value</i>	Sets the port priority.
no spanning-tree rstp port-priority	Resumes the port priority to the default value.

It should be noted that the change of the priority of an Ethernet port can lead to the recalculation of the spanning tree.

The priority of all Ethernet ports of a bridge is 128 by default.

2.2.8 Setting the Edge Port

The edge port means this port connects terminal devices of a network. A mandatory edge port will enter the forwarding state after link-up. In port configuration mode, run the following command to set the edge port of RSTP:

Command	Purpose
spanning-tree rstp edge	Sets the edge port.

In auto mode, if a port has not received BPDU in a certain time this port is viewed as the edge port.

2.2.9 Setting the Port Connection Type

If switches, on which RSTP is run, are in the point-to-point connection, these switches can establish a topology rapidly through the handshake mechanism. When the port connection type is set, the connection of a port can be set point-to-point.

By default, RSTP will judge whether a port is in the point-to-point connection according to the duplex mode of this port. If this port works in full duplex mode, RSTP regards this port is in a point-to-point connection; if this port works in half duplex mode, RSTP regards this port's connection is shared.

If it is confirmed that RSTP or MSTP is running on the switches connected by a port, you should set this port's connection type to point-to-point so that fast handshake should be conducted.

In the port configuration mode, run the following command to set the connection type of a port.

Command	Purpose
spanning-tree rstp point-to-point [force-true force-false auto]	Sets the point to point interface. force-true: Mandatorily sets the connection to point-to-point. force-false: Mandatorily sets the connection to non-point-to-point. auto: Automatically checks the port type.

2.2.10 Restarting the protocol conversion check

RSTP makes a switch to work together with a traditional 802.1D STP switch through a protocol transfer mechanism. If one port of the switch receives the STP configuration message, the port then only transmits the STP message.

After a port enters the STP-compatible state, even if this port does not receive 802.1D STP BPDU again, this port will not resume the RSTP state. In this case, you can run `spanning-tree rstp migration-check` to enable the protocol transfer checkup process and resume this port to the RSTP mode.

In global mode run the following command to restart RSTP transfer checkup:

Command	Purpose
spanning-tree rstp migration-check	Restarts RSTP transfer checkup on all ports.

In switch port configuration mode, run the following command to conduct protocol transfer checkup on this port:

Command	Purpose
spanning-tree rstp migration-check	Restarts RSTP transfer checkup on the current port.

Chapter 3 Configuring MSTP

3.1 MSTP Introduction

3.1.1 Overview

Multiple Spanning Tree Protocol (MSTP) is used to establish a simple and complete topology in the bridge LAN. MSTP is compatible with STP (Spanning Tree Protocol) and RSTP (Rapid Spanning Tree Protocol).

Both STP and RSTP only construct a single spanning tree topology in a network and the packets of all VLANs are forwarded along with this unique topology. STP converges too slowly, while RSTP guarantees the a rapid and stable network topology through handshake.

MSTP keeps the fast handshake of RSTP to guarantee fast topology establishment, and at the same time MSTP allows different VLANs to be classified into different spanning trees to establish multiple tree topologies in the network. In a MSTP-constructing network, frames that belong to different VLANs can be forwarded on different paths to realize the load balance of VLAN data.

Different from PVST (per-VLAN Spanning Tree), MSTP permits multiple VLANs to be classified into the same spanning tree topology, effectively reducing spanning trees that are used to support VLANs.

3.1.2 MST Region

In MSTP, the relationship of VLAN and spanning tree is described through a MSTP. The MST configuration table, along with a configuration name and a configuration edit number, makes up of a MST configuration identifier.

In a network, the bridges that interconnect with others and possess the same MST configuration identifier are regarded that they are in the same MST region. The bridges in the same MST region generally have the same VLAN settings so that the frames of these VLANs can only be running at the inside of this MST region.

3.1.3 IST, CST, CIST and MSTI

Figure 2.1 shows an MSTP network, which consists of 3 MST regions and a switch running 802.1D STP protocol.

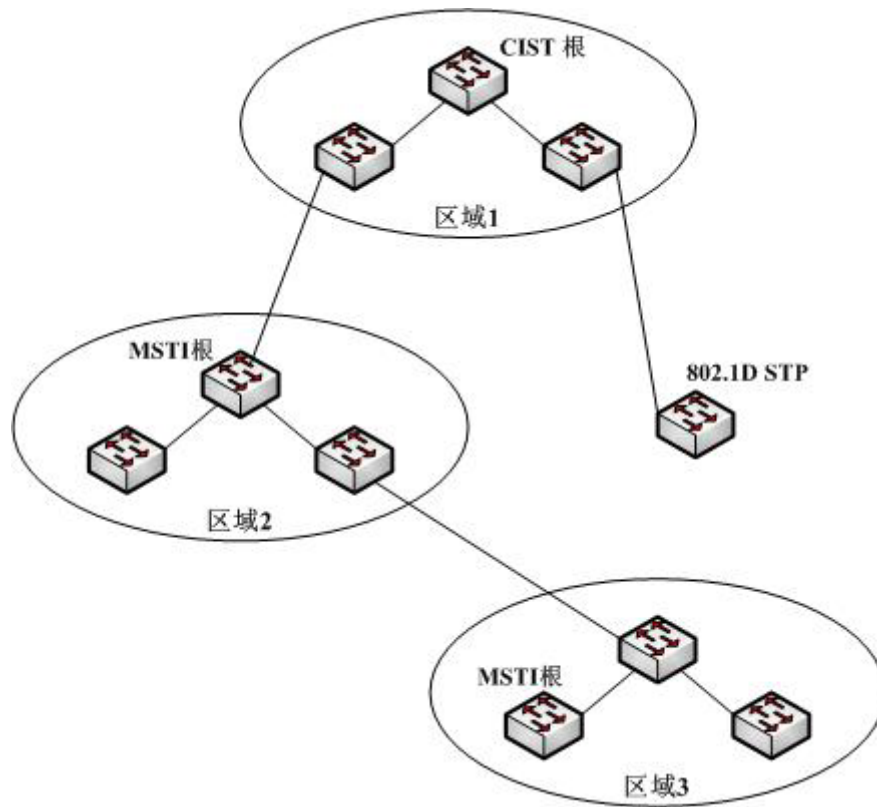

Figure 2.1 MSTP topology

1. CIST

CIST stands for Common and Internal Spanning Tree. Common and Internal Spanning Tree (CIST) means the spanning tree comprised by all single switches and interconnected LAN. These switches may belong to different MST regions. They may be switches running traditional STP or RSTP. Switches running STP or RSTP in the MST regions are considered to be in their own regions.

After the network topology is stable, the whole CIST chooses a CIST root bridge. An internal CIST root bridge will be selected in each region, which is the shortest path from the heart of the region to CIST root.

2. CST

CST stands for Common Spanning Tree. If each MST region is viewed as a single switch, CST is then the spanning tree that connects these "single switches". As shown in figure 2.1, regions 1-3 and the STP switch constitute a CST of this network.

3. IST

IST stands for Internal Spanning Tree. IST means a CIST part in a MST region, or be considered that IST and CST constitute CIST.

4. MSTI

MSTI stands for Multiple Spanning Tree Instance. MSTP permits different VLANs to be classified into different spanning trees to establish multiple MSTIs. In general, MSTI 0 means CIST, which can be expanded to the whole network, while other MSTIs are each in a region. Each MSTI can be distributed to multiple VLANs. Originally, all VLANs are distributed in CIST.

All MSTIs in the MST region are independent and they can choose different switches to be their roots. For example, in region 3 of figure 2.1, the root of MSTI01 may be the switch at the left bottom corner, while the root of MSTI00 (CIST) may be the switch in the middle.

3.1.4 Port Role

MSTP, like RSTP, has the similar function to conduct port role distribution.

1. Root Port

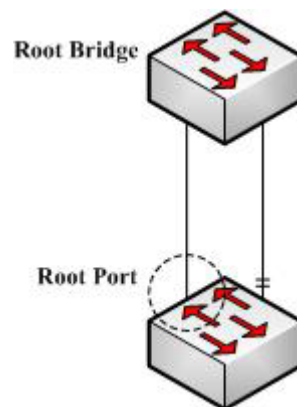

Figure 2.2 Root port

The root port means the path between the current switch to the root bridge. This path has the minimum root path cost.

2. Alternate Port

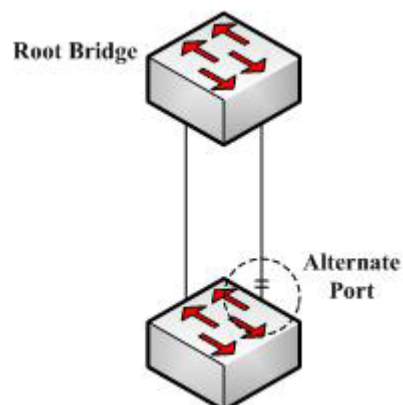

Figure 2.3 Alternate Port

The alternate port serves as path backup between the current switch and the root bridge. When the root port fails to connect, the alternate port can be immediately transferred to be a new root port and start work.

3. Designated Port

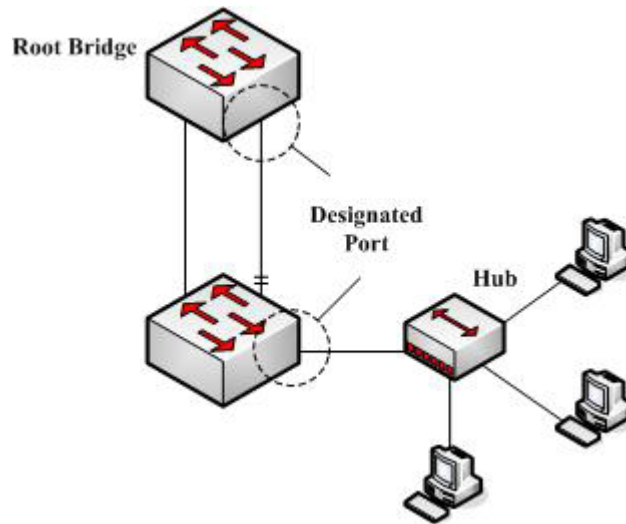

Figure 2.4 Designated port

The designated port can be used to connect the downstream switch or the downstream LAN and then runs as the path between LAN and thr root bridge.

4. Backup Port

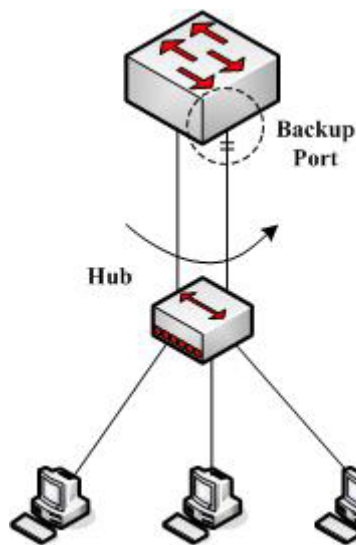

Figure 2.5 Backup port

When two ports of a switch connect directly or connect the same LAN, the port with relatively low priority will run as the backup port and the other port will run as the designated port. If the designated port invalidates, the backup port will serve as the designated port.

5. Master port

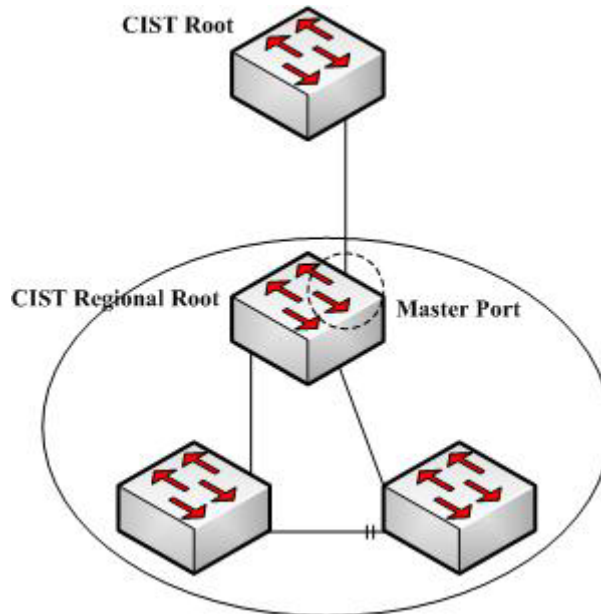

Figure 2.6 Master port

The master port is used as the shortest path between MST region and CIST root bridge. The master port is also the root port of the root bridge in CIST region.

6. Boundary Port

The concept of the boundary port is different from in CIST and in MSTI. In CIST, the boundary port means a port connecting another MST region; while in MSTI, the boundary port means that this spanning tree instance is not extended outside of this port.

7. Edge Port

In RSTP and MSTP, the edge port means a port directly connecting the host, and is capable of entering the forwarding state directly without waiting and loop.

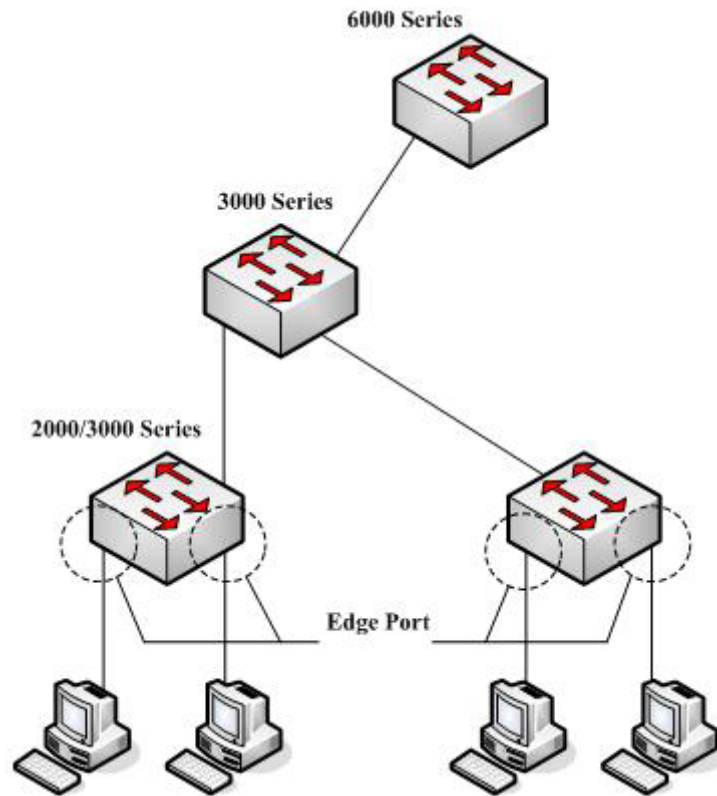

Figure 2.7 Edge port

Originally, MSTP, including RSTP, regards all ports are edge ports and therefore the network topology can be established swiftly. If a port in this case receives BPDU from another switch, the port will resume its edge state from its normal state; if it receives 802.1D STP BPDU, it has to wait for double forward delays and then enters its forwarding state.

3.1.5 MSTP BPDU

Similar to STP and RSTP, switches running MSTP can communicate with each other through Bridge Protocol Data Unit (BPDU). All configuration information about the CIST and MSTI can be carried by BPDU. Table 2.1 and Table 2.2 list the structure of BPDU used by the MSTP.

Table 2.1 MSTP BPDU

Field Name	Byte Number
Protocol Identifier	1 – 2
Protocol Version Identifier	3
BPDU Type	4
CIST Flags	5
CIST Root Identifier	6 – 13

CIST External Root Path Cost	14 – 17
CIST Regional Root Identifier	18 – 25
CIST Port Identifier	26 – 27
Message Age	28 – 29
Max Age	30 – 31
Hello Time	32 – 33
Forward Delay	34 – 35
Version 1 Length	36
Version 3 Length	37 – 38
Format Selector	39
Configuration Name	40 – 71
Revision	72 – 73
Configuration Digest	74 – 89
CIST Internal Root Path Cost	90 – 93
CIST Bridge Identifier	94 – 101
CIST Remaining Hops	102
MSTI Configuration Messages	103 ~

Table 2.2 MST configuration information

Field Name	Byte Number
MSTI FLAGS	1
MSTI Regional Root Identifier	2 – 9
MSTI Internal Root Path Cost	10 – 13
MSTI Bridge Priority	14
MSTI Port Priority	15
MSTI Remaining Hops	16

3.1.6 Stable State

The MSTP switch performs calculation and compares operations according to the received BPDU, and finally ensures that:

- (1) One switch is selected as the CIST root of the whole network.
- (2) Each switch and LAN segment can decide the minimum cost path to the CIST root, ensuring a complete connection and prevent loops.
- (3) Each region has a switch as the CIST regional root. The switch has the minimum cost path to the CIST root.
- (4) Each MSTI can independently choose a switch as the MSTI regional root.

- (5) Each switch in the region and the LAN segment can decide the minimum costpath to the MSTI root.
- (6) The root port of CIST provides the minimum-cost path between the CISTregional root and the CIST root.
- (7) The designated port of the CIST provided its LAN with the minimum-cost path tothe CIST root.
- (8) The Alternate port and the Backup port provides connection when the switch,port or the LAN does not work or is removed.
- (9) The MSTI root port provides the minimum cost path to the MSTI regional root.
- (10) The designated port of MSTI provides the minimum cost path to the MSTIregional root.
- (11) A master port provides the connection between the region and the CIST root. In the region, the CIST root port of the CIST regional root functions as the masterport of all MSTI in the region.

3.1.7 Hop Count

Different from STP and RSTP, the MSTP protocol does not use Message Age and Max Age in the BPDU configuration message to calculate the network topology. MSTP usesHop Count to calculate the network topology.

To prevent information from looping, MSTP relates the transmitted information to theattribute of hop count in each spanning tree. The attribute of hop count for BPDU is designated by the CIST regional root or the MSTI regional root and reduced in eachreceiving port. If the hop count becomes 0 in the port, the information will be dropped and then the port turns to be a designated port.

3.1.8 STP Compatibility

MSTP allows the switch to work with the traditional STP switch through protocolconversion mechanism. If one port of the switch receives the STP configuration message, the port then only transmits the STP message. At the same time, the portthat receives the STP information is then considered as a boundary port.

Note:

When a port is in the STP-compatible state, the port will not automatically resume to the MSTP state even if the port does not receive the STP message any more. In this case, you can run spanning-tree mstpmigration-check to clear the STP message that the port learned, and make the port to return to the MSTPstate.

The switch that runs the RSTP protocol can identify and handle the MSTP message. Therefore, the MSTP switch does not require protocol conversion when it works with the RSTP switch.

3.2 MSTP Configuration Task List

- [Default MSTP Configuration](#)

- [Enabling and disabling MSTP](#)
- [Configuring MSTP region](#)
- [Configuring network root](#)
- [Configuring secondary root](#)
- [Configuring bridge priority](#)
- [Configuring time parameters of STP](#)
- [Configuring network diameter](#)
- [Configuring maximum hop count](#)
- [Configuring port priority](#)
- [Configuring path cost for port](#)
- [Configuring the edge port](#)
- [Configuring port connection type](#)
- [Activating MST-compatible mode](#)
- [Restarting the protocol conversion check](#)
- [Configuring role restriction of the port](#)
- [Configuring TCN restriction of the port](#)
- [CheckMSTPinformation](#)

3.3 MSTP Configuration Tasks

3.3.1 Default MSTP Configuration

Attributes	Default Settings
STP mode	RSTP (PVST, SSTP and MSTP is not enabled)
Area name	Its default value is the MAC address of a switch.
Area edit level	0
MST configuration list	All VLANs are mapped to CIST (MST00).
Spanning-tree port priority (CIST and all MSTI)	32768
Spanning-tree port priority (CIST and all MSTI)	128
Path cost of the spanning-tree port (CIST and allMSTI)	1000 Mbps: 20000

	100 Mbps: 200000 10 Mbps: 2000000
Hello Time	2 seconds
Forward Delay	15 seconds
Maximum-aging Time	20 seconds
Maximum hop count	20

3.3.2 Enabling and disabling MSTP

The STP protocol can be started in RSTP mode by default. You can stop it running when the spanning-tree is not required.

Run the following command to set the STP to the MSTP mode:

Command	Purpose
spanning-tree	Enables STP in default mode.
spanning-tree mode mstp	Enables MSTP.

Run the following command to disable STP:

Command	Purpose
no spanning-tree	Disable the STP.

3.3.3 Configuring MSTP region

The MST area where the switch resides is decided by three attributes: configurationname, edit number, the mapping relation between VLAN and MSTI. You can configure them through area configuration commands. Note that the change of any of the three attributes will cause the change of the area where the switch resides.

In original state, the MST configuration name is the character string of the MAC address of the switch. The edit number is 0 and all VLANs are mapped in the CIST (MST00). Because different switch has different MAC address, switches that run MSTP are in different areas in original state. You can run `spanning-tree mstp instance instance-id vlan vlan-list` to create a new MSTI and map the esignated VLAN to it. If the MSTI is deleted, all these VLANs are mapped to the CIST again.

Run the following command to set the MST area information:

Command	Purpose
spanning-tree mstp name <i>string</i>	Configures the MST configuration name. string means the character string of the configurationname. It contains up to 32 characters, capital sensitive. The default value is the character string of the MAC address.
no spanning-tree mstp name	Sets the MST configuration name to the default value.
spanning-tree mstp revision <i>value</i>	Sets the MST edit number.

	value represents the edit number, ranging from 0 to 65535. The default value is 0.
no spanning-tree mstp revision	Sets the MST edit number to the default value.
spanning-tree mstp instance <i>instance-id vlan vlan-list</i>	Maps VLAN to MSTI. Instance ID of the spanning-tree, which stands for an MSTI Value range: 1-15 vlan-list: means the VLAN list that is mapped to the spanning tree. It ranges from 1 to 4094. Instance ID is an independent value which stands for an STP instance. vlan-list can represent a group of VLANs, such as "1,2,3", "1-5" and "1,2,5-10". "1,2: 5 -10"...
no spanning-tree mstp instance <i>instance-id</i>	Cancels the VLAN mapping of MSTI and disables the spanning tree instance. instance-id: Instance ID of the spanning-tree, which stands for a MSTI. Value range: 1-15

Run the following command to check the configuration of the MSTP area:

Command	Purpose
show spanning-tree mstp region	Displays the configuration of the MSTP area.

3.3.4 Configuring network root

In MSTP, each spanning tree instance has a Bridge ID, containing the priority value and MAC address of the switch. During the establishment of spanning tree topology, the switch with comparatively small bridge ID is selected as the network root.

MSTP can set the switch to the network root through configuration. You can run the command `Spanning-tree mstp instance-id root` to modify the priority value of the switch in a spanning tree instance from the default value (32768) to a sufficiently small value, ensuring the switch turns to be the root in the spanning tree instance.

In general, after the command to set the primary root is executed, the protocol automatically checks the bridge ID of the current network's root and then sets the priority of the bridge ID to 24576, which guarantees that the current switch serves as the root of the STP instance.

If the priority value of the network root is less than 24576, the protocol will automatically set the STP priority of the current bridge to a value which is 4096 smaller than the priority of the root. It deserves attention that 4096 is the step of the priority value of the bridge.

When setting the root, you can run the `diameter` subcommand to the network diameter of the spanning tree network. The keyword is effective only when the spanning tree instance ID is 0. After the network diameter is set, MSTP automatically calculates proper STP time parameters to ensure the stability of network convergence. Time

parameters include Forward Delay and Maximum Age. The subcommand `Hello-time` can be used to set a new hello time to replace the default settings.

Run the following command to set the switch to the network root:

Command	Purpose
spanning-tree mstp <i>instance-id</i> root primary [diameter <i>net-diameter</i> [hello-time <i>seconds</i>]]	Sets the switch to the root in the designated spanning tree instance. instance-id represents the number of the spanning tree instance, ranging from 0 to 15. net-diameter represents the network diameter, which is an optional parameter. It is effective when instance-id is 0. It ranges from 2 to 7. seconds represents the unit of the hello time, ranging from 1 to 10.
no spanning-tree mstp <i>instance-id</i> root	Cancels the root configuration of the switch in the spanning tree. instance-id represents the number of the spanning tree instance, ranging from 0 to 15.

Run the following command to check the MSTP message:

Command	Purpose
show spanning-tree mstp [instance <i>instance-id</i>]	Checks the MSTP message.

3.3.5 Configuring secondary root

After the network root is configured, you can run `spanning-tree mstp instance-id root secondary` to set one or multiple switches to the secondary roots or the backup roots. If the root does not function for certain reasons, the secondary roots will become the network root.

Different from primary root configuration, after the command to set the secondary root is executed, the protocol directly set the STP priority of the switch to 28672. In case that the priority value of other switches in the network is 32768 by default, the current switch serves as the secondary root.

When configuring the secondary root, you can run the subcommands `diameter` and `hello-time` to update the STP time parameters. When the secondary root becomes the primary root and starts working, all these parameters start functioning.

Run the following command to set the switch to the secondary root of the network:

Command	Purpose
spanning-tree mstp <i>instance-id</i> root secondary [diameter <i>net-diameter</i> [hello-time <i>seconds</i>]]	Sets the switch to the secondary root in the designated spanning tree instance. instance-id represents the number of the spanning tree instance, ranging from 0 to 15.

	<p>net-diameter represents the network diameter, which is an optional parameter. It is effective when instance-id is 0. It ranges from 2 to 7.</p> <p>seconds represents the unit of the hello time, ranging from 1 to 10.</p>
no spanning-tree mstp instance-id root	<p>Cancels the root configuration of the switch in the spanning tree.</p> <p>instance-id represents the number of the spanning tree instance, ranging from 0 to 15.</p>

Run the following command to check the MSTP message:

Command	Purpose
show spanning-tree mstp [instance instance-id]	Checks the MSTP message.

3.3.6 Configuring Bridge Priority

In some cases, you can directly set the switch to the network root by configuring the bridge priority. It means that you can set the switch to the network root without running the subcommand root. The priority value of the switch is independent in each spanning tree instance. Therefore, the priority of the switch can be set independently.

Run the following command to configure the priority of the spanning tree:

Command	Purpose
spanning-tree mstp instance-id priority value	<p>Sets the priority of the switch.</p> <p>instance-id represents the number of the spanning tree instance, ranging from 0 to 15.</p> <p>value represents the priority of the bridge. It can be one of the following values: 0, 4096, 8192, 12288, 16384, 20480, 24576, 28672, 32768, 36864, 40960, 45056, 49152, 53248, 57344, 61440.</p>
no spanning-tree mstp instance-id priority	<p>Resumes the bridge priority of the switch to the default value.</p> <p>instance-id represents the number of the spanning tree instance, ranging from 0 to 15.</p>

3.3.7 Configuring time parameters of STP

The following are STP time parameters:

- **Hello Time:**

The interval to send the configuration message to the designated port when the switch functions as the network root.

- **Forward Delay:**

Time that the port needs when it changes from the Blocking state to the Learning state and to the Forwarding state in STP mode.

- **Max Age:**

The maximum live period of the configuration information about the spanning tree.

To reduce the shock of the network topology, the following requirements for the time parameters must be satisfied:

- $2 \times (\text{fwd_delay} - 1.0) \geq \text{max_age}$
- $\text{max_age} \geq (\text{hello_time} + 1) \times 2$

Running the following command to set the time parameter of MSTP:

Command	Purpose
spanning-tree mstp hello-time <i>seconds</i>	Resumes Hello Time to the default value. seconds: value range: 1-10 seconds, Default value: 2 seconds
no spanning-tree mstp hello-time	Resumes the hello time to the default value.
spanning-tree mstp forward-time <i>seconds</i>	Sets the parameter Forward Delay. seconds: value range from 4 to 30 seconds, the default value is 15 seconds.
no spanning-tree mstp forward-time	Resumes Forward Delay to the default value.
spanning-tree mstp max-age <i>seconds</i>	Sets the parameter Max Age. seconds: value range from 6 to 40 seconds, the default value is 20 seconds.
no spanning-tree mstp max-age	Resumes the Max Age to the default value.

It is recommended to modify the time parameter of STP through setting the root or network diameter, ensuring the rationality of the time parameter.

The newly-set time parameters are valid even if they do not comply with the previous formula's requirements. Pay attention to the notification on the console when you perform configuration.

3.3.8 Configuring network diameter

Network diameter stands for the maximum number of switches between two hosts in the network, representing the scale of the network.

You can set the MSTP network diameter by running the command `spanning-tree mstp diameter net-diameter`. The parameter `net-diameter` is valid only to CIST. After configuration, three STP time parameters is automatically updated to comparatively better values.

Run the following command to configure `net-diameter`:

Command	Purpose
spanning-tree mstp diameter <i>net-diameter</i>	Configure net-diameter. net-diameter: value range: 2-7; default value: 7
no spanning-tree mstp diameter	Resumes net-diameter to the default value.

The net-diameter parameter is not saved as an independent configuration in the switch. Only the time parameter which is modified through network diameter configuration can be saved.

3.3.9 Configuring maximum hop count

Use the following command to configure the max hop-count.

Command	Purpose
spanning-tree mstp max-hops <i>hop-count</i>	Set the maximum hops. hop-count: value range: 6-40 Default value: 20
no spanning-tree mstp max-hops	Resume the maximum hop count to the default value.

3.3.10 Setting the Port Priority

If a loop occurs between two ports of the switch, the port with higher priority will enter the forwarding state and the port with lower priority is blocked. If all ports have the same priority, the port with smaller port number will first enter the forwarding state.

In port configuration mode, run the following command to set the priority of the STP port:

Command	Purpose
spanning-tree mstp <i>instance-id</i> port-priority <i>priority</i>	Sets the priority of the STP port. instance-id represents the number of the spanning tree instance, ranging from 0 to 15. priority stands for the port priority. It can be one of the following values: 0, 16, 32, 48, 64, 80, 96, 112 128, 144, 160, 176, 192, 208, 224, 240,
spanning-tree port-priority <i>value</i>	Sets the port priority in all spanning tree instances. value: value of the port priority, which can be one of the following values. 0, 16, 32, 48, 64, 80, 96, 112 128, 144, 160, 176, 192, 208, 224, 240,
no spanning-tree mstp <i>instance-id</i> port-priority	Resumes the port priority to the default value.
no spanning-tree port-priority	Resumes the port priority to the default value in all spanning tree instances.

3.3.11 Value of the path cost of a port

In MSTP, the default value of the port's path cost is based on the connection rate. If a loop occurs between two switches, the port with less path cost will enter the forwarding state. The less the path cost is, the higher rate the port is. If all ports have the same path cost, the port with smaller port number will first enter the forwarding state.

In port configuration mode, run the following command to set the path cost of the port:

Command	Purpose
spanning-tree mstp <i>instance-id</i> cost <i>cost</i>	Sets the path cost of the port. instance-id represents the number of the spanning tree instance, ranging from 0 to 15. cost stands for the path cost of the port, which ranges from 1 to 200000000.
spanning-tree cost <i>value</i>	Sets the path cost of the port in all spanning tree instances. value: Path cost of a port, which ranges between 1 and 200,000,000
no spanning-tree mstp <i>instance-id</i> cost	Resumes the port path cost to the default value.
no spanning-tree cost	Resumes the path cost of the port to the default value.

3.3.12 Setting the Edge Port

The edge port means this port connects terminal devices of a network. A mandatory edge port will enter the forwarding state after link-up. In port configuration mode, run following command to set the edge port of MSTP:

Command	Purpose
spanning-tree mstp edge	Sets the edge port.
no spanning-tree mstp edge	Resume the default setting.

3.3.13 Setting the Port Connection Type

If switches, on which RSTP is run, are in the point-to-point connection, these switches can establish a topology rapidly through the handshake mechanism. When the port connection type is set, the connection of a port can be set point-to-point.

By default, RSTP will judge whether a port is in the point-to-point connection according to the duplex mode of this port. If this port works in full duplex mode, RSTP regards this port is in a point-to-point connection; if this port works in half duplex mode, RSTP regards this port's connection is shared.

If it is confirmed that RSTP or MSTP is running on the switches connected by a port, you should set this port's connection type to point-to-point so that fast handshake should be conducted.

In the port configuration mode, run the following command to set the connection type of a port.

Command	Purpose
spanning-tree mstp point-to-point force-true	Sets the port connection mode to point-to-point.
spanning-tree mstp point-to-point force-false	Sets the port connection mode to non-point-to-point.
spanning-tree mstp point-to-point auto	Sets the port connection mode to auto-check (the default mode).
no spanning-tree mstp point-to-point	Resumes the port connection type to the default settings.

3.3.14 Activating MST-compatible mode

The MSTP protocol that our switches support is based on IEEE 802.1Q. In order to be compatible with other MSTPs, especially MSTP that the Cisco switches support, the MSTP protocol can work in MST-compatible mode. Switches running in MST-compatible mode can identify the message structure of other MSTPs, check the contained MST regional identifier and establish the MST region.

The MST-compatible mode and the STP-compatible mode are based on MSTP protocol conversion mechanism. If one port of the switch receives BPDU in compatible mode, the port automatically changes to the mode and sends BPDU in compatible mode. To resume the port to standard MST mode, you can run `spanning-tree mstp migration-check`.

In global configuration mode, run the following commands to enable or disable the MST-compatible mode:

Command	Purpose
spanning-tree mstp mst-compatible	Enable the MST-compatible mode of the switch.
no spanning-tree mstp mst-compatible	Disable the MST-compatible mode of the switch.

Note:

The main function of the compatible mode is to create the MST area for switches and other MSTP-running switches. In actual networking, make sure that the switch has the same configuration name and the same edit number. It is recommended to configure switches running other MSTP protocols to the CIST root, ensuring that the switch enters the compatible mode by receiving message.

If the MST-compatible mode is not activated, the switch will not resolve the whole BPDU-compatible content and take the content as the common RSTP BPDU. In this way, the switch cannot be in the same area with the MST-compatible switch that it connects.

A port in compatible mode cannot automatically resume to send standard MST BPDU even if the compatible mode is shut down in global configuration mode. In this case, run `migration-check`.

3.3.15 Restarting the protocol conversion check

MSTP allows the switch to work with the traditional STP switch through protocol conversion mechanism. If one port of the switch receives the STP configuration message, the port then only transmits the STP message. At the same time, the port that receives the STP information is then considered as a boundary port. Likewise, in MST compatible mode, if one interface receives the compatible BPDU, the interface will also forward compatible BPDU.

Note:

When a port is in the STP-compatible state, the port will not automatically resume to the MSTP state even if the port does not receive the STP message any more. In this case, you can run `spanning-tree mstp migration-check` to clear the STP message that the port learned, and make the port to return to the MSTP state.

The switch that runs the RSTP protocol can identify and handle the MSTP message. Therefore, the MSTP switch does not require protocol conversion when it works with the RSTP switch.

In global configuration mode, run the following command to clear all STP information that is detected by all ports of the switch:

Command	Purpose
spanning-tree mstp migration-check	Clears all STP information that is detected by all ports of the switch.

In port configuration mode, run the following command to clear STP information detected by the port.

Command	Purpose
spanning-tree mstp migration-check	Clears STP information detected by the port.

3.3.16 Configuring role restriction of the port

The port will not be selected as the root port if the role restriction of the port is enabled.

In the port configuration mode, run the following command to set the role restriction of a port.

Command	Purpose
spanning-tree mstp restricted-role	Sets the port not to be the root port

3.3.17 Configuring TCN restriction of the port

The topology change will not be transferred to other port if TCN restriction of the port is enabled.

In the port configuration mode, run the following command to set the TCN restriction of a port.

Command	Purpose
spanning-tree mstp restricted-tcn	Enable the topology changes on one port cannot

	be transmitted to other ports.
--	--------------------------------

3.3.18 Check MSTP information

In monitoring mode, global configuration mode or port configuration mode, run the following command to check all information about MSTP.

Command	Purpose
show spanning-tree	Checks MSTP information. (Information about SSTP, PVST, RSTP and MSTP can be checked)
show spanning-tree detail	Checks MSTP information. (Information about SSTP, PVST, RSTP and MSTP can be checked)
show spanning-tree interface <i>interface-id</i>	Checks the STP interface information. (Information about SSTP, PVST, RSTP and MSTP can be checked)
show spanning-tree mstp	Checks all MST instances.
show spanning-tree mstp region	Checks the MST area configuration.
show spanning-tree mstp instance <i>instance-id</i>	Checks information about a MST instance.
show spanning-tree mstp detail	Checks detailed MST information.
show spanning-tree mstp interface <i>interface-id</i>	Checks MST port configuration.
show spanning-tree mstp protocol-migration	Checks the protocol conversion state of the port.



 <https://www.fs.com>



The information in this document is subject to change without notice. FS has made all efforts to ensure the accuracy of the information, but all information in this document does not constitute any kind of warranty.