

N8560 Series Switches Configuration Guide

Models: N8560-48BC; N8560-32C; N8560-64C

Contents

System Configuration.....	1
1 Configuring CLI.....	2
2 Configuring Basic Management.....	12
3 Configuring R5.....	39
4 Configuring Lines.....	40
5 Configuring Time Range.....	46
6 Configuring USB.....	50
7 Configuring HTTP Service.....	56
8 Configuring UFT.....	70
9 Configuring TCAM Mode.....	78
10 Configuring ZAM.....	82
11 Configuring Module Hot Swapping.....	87
17 Configuring Supervisor Module Redundancy.....	93
18 Configuring Syslog.....	101
19 Configuring MONITOR.....	137
20 Configuring PKG_MGMT.....	138
21 Configuring Python Shell.....	156
Ethernet Switching Configuration.....	158
22 Configuring Interfaces.....	159
23 Configuring Single Fiber.....	204
24 Configuring MAC Address.....	206
25 Configuring Aggregate Port.....	228
26 Configuring VLAN.....	273
27 Configuring MAC VLAN.....	294
28 Configuring Super VLAN.....	302
30 Configuring Protocol VLAN.....	310
31 Configuring Private VLAN.....	320
32 Configuring MSTP.....	336

33 Configuring GVRP.....	406
35 Configuring LLDP.....	422
36 Configuring QinQ.....	460
37 Configuring HASH Simulator.....	497
38 Configuring L3-PKT-COUNTER ENABLE.....	511
39 Configuring Positioning Lamp.....	512
40 Configuring Port Module Type.....	515
IP Address & Application Configuration.....	518
1 Configuring IP Addresses and Services.....	519
2 Configuring ARP.....	542
3 Configuring IPv6.....	575
4 Configuring DHCP.....	616
5 Configuring DHCPv6.....	656
6 Configuring DNS.....	680
7 Configuring FTP Server.....	688
8 Configuring FTP Client.....	696
9 Configuring Tunnel Interfaces.....	706
10 Configuring Network Communication Test Tools.....	716
11 Configuring TCP.....	727
12 Configuring IPv4/IPv6 REF.....	738
13 Configuring ECMP CLUSTER.....	741
IP Routing Configuration.....	746
1 Configuring Routing Policies.....	747
2 Configuring Keys.....	784
3 Configuring RIP.....	791
4 Configuring OSPFv2.....	844
5 Configuring OSPFv3.....	935
6 Configuring IS-IS.....	1010
7 Configuring BGP.....	1096
8 Configuring RIPng.....	1256

9 Configuring PBR.....	1276
10 Managing Routes.....	1311
11 Configuring VRF.....	1352
12 Configuring L3MAC.....	1374
13 Configuring Hardware Capacity Query.....	1376
Multicast Configuration.....	1383
14 Configuring IP Multicasting.....	1384
15 Configuring IPv6 Multicast.....	1411
16 Configuring IGMP.....	1431
17 Configuring MLD.....	1453
18 Configuring PIM-DM.....	1474
19 Configuring PIM-SM.....	1490
20 Configuring PIM-SMv6.....	1546
21 Configuring MSDP.....	1596
22 Configuring IGMP Snooping.....	1629
23 Configuring MLD Snooping.....	1684
Security Configuration.....	1698
1 Configuring AAA.....	1699
2 Configuring RADIUS.....	1741
3 Configuring TACACS+.....	1761
4 Configuring SCC.....	1772
5 Configuring Password Policy.....	1789
6 Configuring Storm Control.....	1795
7 Configuring SSH.....	1801
8 Configuring URPF.....	1844
9 Configuring CPP.....	1857
10 Configuring DHCP Snooping.....	1869
11 Configuring NFPP.....	1884
12 Configuring Security Log.....	1937
ACL & QoS Configuration.....	1944

1 Configuring the ACL.....	1945
2 Configuring QoS.....	2005
3 Configuring MMU.....	2050
Reliability Configuration.....	2081
1 Configuring REUP.....	2082
2 Configuring RLDP.....	2108
3 Configuring DLDP.....	2119
4 Configuring VRRP.....	2126
5 Configuring VRRP Plus.....	2172
6 Configuring BFD.....	2186
7 Configuring IP Event Dampening.....	2205
8 Configuring VSU.....	2209
9 Configuring RNS.....	2251
10 Configuring PCAP.....	2276
11 Configuring HAM.....	2286
12 Configuring VAP (MLAG).....	2289
Network Management & Monitoring Configuration.....	2324
1 Configuring SNMP.....	2325
2 Configuring RMON.....	2354
3 Configuring NTP.....	2368
4 Configuring SNTP.....	2382
5 Configuring SPAN-RSPAN.....	2388
6 Configuring ERSPAN.....	2405
7 Configuring sFlow.....	2416
8 Configuring NETCONF.....	2430
9 Configuring gRPC.....	2451
10 Configuring IFA and PSR.....	2470
11 Configuring IPFIX.....	2480
Data Center Configuration.....	2496
1 Configuring DCB.....	2497

2 Configuring VXLAN..... 2520

System Configuration

1. Configuring Command Line Interface
2. Configuring Basic Management
3. Configuring R5
4. Configuring Lines
5. Configuring Time Range
6. Configuring USB
7. Configuring HTTP Service
8. Configuring UFT
9. Configuring TCAM-MODE
10. Configuring ZAM
11. Configuring Hot Swapping
12. Configuring Supervisor Module Redundancy
13. Configuring Syslog
14. Configuring MONITOR
15. Configuring Package Management
16. Configuring PYTHON SHELL

1 Configuring CLI

1.1 Overview

The command line interface (CLI) is a window used for text command interaction between users and network devices. You can enter commands in the CLI window to configure and manage network devices.

Protocols and Standards

N/A

1.2 Applications

Application	Description
Configuring and Managing Network Devices Through CLI	You can enter commands in the CLI window to configure and manage network devices

1.2.1 Configuring and Managing Network Devices Through CLI

Scenario

As shown in Figure 1-1, a user accesses network device A using a PC, and enter commands in the CLI window to configure and manage the network device.

Figure 1-1



Remarks	A is the network device to be managed. PC is a terminal.
----------------	---

Deployment

As shown in Figure 1-2, the user uses the Putty installed on a PC to set up a connection with network device A, and opens the CLI window to enter configuration commands.

Figure 1-2

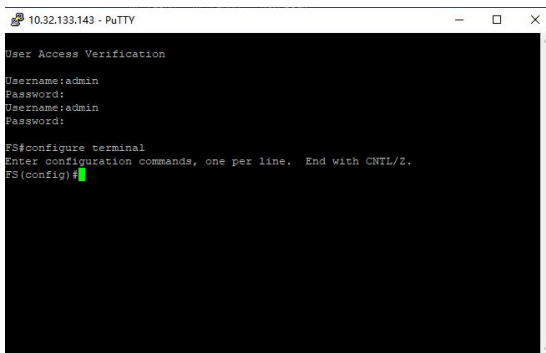

1.3 Features

Overview

Feature	Description
Accessing CLI	You can log in to a network device for configuration and management.
Command Modes	The CLI provides several command modes. Commands that can be used vary according to command modes.
System Help	You can obtain the help information of the system during CLI configuration.
Abbreviated Commands	If the entered string is sufficient to identify a unique command, you do not need to enter the full string of the command.
No and Default Options of Commands	You can use the no option of a command to disable a function or perform the operation opposite to the command, or use the default option of the command to restore default settings.
Prompts Indicating Incorrect Commands	An error prompt will be displayed if an incorrect command is entered.
History Commands	You can use short-cut keys to display or call history commands.
Featured Editing	The system provides short-cut keys for editing commands.
Searching and Filtering of the Show Command Output	You can run the show command to search or filter specified commands.
Command Alias	You can configure alias of a command to replace the command.

1.3.1 Accessing CLI

Before using the CLI, you need to connect a terminal or PC to a network device. You can use the CLI after starting the network device and finishing hardware and software initialization. When used for the first time, the network device can be connected only through the console port, which is called out band management. After performing relevant configuration, you can connect and manage the network device through Telnet.

1.3.2 Command Modes

Due to the large number of commands, these commands are classified by function to facilitate the use of commands. The CLI provides several commands modes, and all commands are registered in one or several command modes. You must first enter the command mode of a command before using this command. Different command modes are related with each other while distinguished from each other.

As soon as a new session is set up with the network device management interface, you enter User EXEC mode. In this mode, you can use only a small number of commands and the command functions are limited, such as the **show** commands. Execution results of commands in User EXEC mode are not saved.

To use more commands, you must first enter Privileged EXEC mode. Generally, you must enter a password to enter Privileged EXEC mode. In Privileged EXEC mode, you can use all commands registered in this command mode, and further enter global configuration mode.

Using commands of a certain configuration mode (such as global configuration mode and interface configuration mode) will affect configuration in use. If you save the configuration, these commands will be saved and executed next time the system is restarted. You must enter global configuration mode before entering another configuration mode, such as interface configuration mode.

The following table summarizes the command modes by assuming that the name of the network device is "FS".

Command Mode	Access Method	Prompt	Exit or Entering Another Mode	About
User EXEC (User EXEC mode)	Enter User EXEC mode by default when accessing a network device.	FS>	Run the exit command to exit User EXEC mode. Run the enable command to enter Privileged EXEC mode.	Use this command mode to conduct basic tests or display system information.
Privileged EXEC (Privileged EXEC mode)	In User EXEC mode, run the enable command to enter Privileged EXEC mode.	FS#	Run the disable command to return to User EXEC mode. Run the configure command to enter global configuration mode.	Use this command mode to check whether the configuration takes effect. This mode is password protected.
Global configuration (Global configuration mode)	In Privileged EXEC mode, run the configure command to enter global configuration mode.	FS(config)#	Run the exit or end command, or press Ctrl+C to return to Privileged EXEC mode. Run the interface command to enter interface configuration mode. When using the interface command, you must specify the interface. Run the vlan <i>vlan_id</i> command to enter VLAN configuration mode.	Using commands in this mode will affect the global parameters of the network device.
Interface configuration (Interface configuration mode)	In global configuration mode, run the interface command to enter interface configuration mode.	FS(config-if)#	Run the end command, or press Ctrl+C to return to Privileged EXEC mode. Run the exit command to return to global configuration mode. When using the interface command, you must specify the interface.	Use this configuration mode to configure various interfaces of the network device.
Config-vlan (VLAN configuration mode)	In global configuration mode, run the vlan <i>vlan_id</i> command to enter VLAN configuration mode.	FS(config-vlan)#	Run the end command, or press Ctrl+C to return to the Privileged EXEC mode. Run the exit command to return to global configuration mode.	Use this configuration mode to configure VLAN parameters.

1.3.3 System Help

When entering commands in the CLI window, you can obtain the help information using the following methods:

1. At the command prompt in any mode, enter a question mark (?) to list the commands supported by the current command mode and related command description.

For example

```
FS>?
```

Exec commands:

```
<1-99>      Session number to resume
disable     Turn off privileged commands
disconnect  Disconnect an existing network connection
enable     Turn on privileged commands
exit       Exit from the EXEC
help       Description of the interactive help system
lock       Lock the terminal
ping       Send echo messages
show       Show running system information
telnet     Open a telnet connection
traceroute Trace route to destination
```

2. Enter a space and a question mark (?) after a keyword of a command to list the next keyword or variable associated with the keyword.

For example

```
FS(config)#interface ?
```

```
Aggregateport  Aggregate port interface
Dialer         Dialer interface
GigabitEthernet Gigabit Ethernet interface
Loopback       Loopback interface
Multilink      Multilink-group interface
Null          Null interface
Tunnel         Tunnel interface
Virtual-ppp    Virtual PPP interface
Virtual-template Virtual Template interface
Vlan          Vlan interface
range         Interface range command
```



If the keyword is followed by a parameter value, the value range and description of this parameter are displayed as follows:

```
FS(config)#interface vlan ?
```

```
<1-4094>  Vlan port number
```

3. Enter a question mark (?) after an incomplete string of a command keyword to list all command keywords starting with the string.

For example

```
FS#d?  
debug delete diagnostic dir disable disconnect
```

4. After an incomplete command keyword is entered, if the suffix of this keyword is unique, press the **Tab** key to display the complete keyword.

For example

```
FS# show conf<Tab>  
FS# show configuration
```

5. In any command mode, run the **help** command to obtain brief description about the help system.

For example

```
FS(config)#help  
Help may be requested at any point in a command by entering  
a question mark '?'. If nothing matches, the help list will  
be empty and you must backup until entering a '?' shows the  
available options.  
Two styles of help are provided:  
1. Full help is available when you are ready to enter a  
command argument (e.g. 'show ?') and describes each possible  
argument.  
2. Partial help is provided when an abbreviated argument is entered  
and you want to know what arguments match the input  
(e.g. 'show pr?').
```

1.3.4 Abbreviated Commands

If a command is long, you can enter a part of the command that is sufficient to identify the command keyword.

For example, to run the **interface** *gigabitEthernet 0/1* command in GigabitEthernet 0/1 interface configuration mode, enter the abbreviated command as follows:

```
FS(config)#int g0/1  
FS(config-if-GigabitEthernet 0/1)#
```

1.3.5 No and Default Options of Commands

Most commands have the **no** option. Generally, the **no** option is used to disable a feature or function, or perform the operation opposite to the command. For example, run the **no shutdown** command to perform the operation opposite to the **shutdown**

command, that is, enabling the interface. The keyword without the **no** option is used to enable a disabled feature or a feature that is disabled by default.

Most configuration commands have the **default** option. The **default** option is used to restore default settings of the command. Default values of most commands are used to disable related functions. Therefore, the function of the **default** option is the same as that of the **no** option in most cases. For some commands, however, the default values are used to enable related functions. In this case, the function of the **default** option is opposite to that of the **no** option. At this time, the **default** option is used to enable the related function and set the variables to default values.

 For specific function of the **no** or **default** option of each command, see the command reference.

1.3.6 Prompts Indicating Incorrect Commands

When you enter an incorrect command, an error prompt is displayed.

The following table lists the common CLI error messages.

Error Message	Meaning	How to Obtain Help
% Ambiguous command: "show c"	The characters entered are insufficient for identifying a unique command.	Re-enter the command, and enter a question mark after the word that is ambiguous. All the possible keywords will be displayed.
% Incomplete command.	The mandatory keyword or variable is not entered in the command.	Re-enter the command, and enter a space and a question mark. All the possible keywords or variables will be displayed.
% Invalid input detected at '^' marker.	An incorrect command is entered. The sign (^) indicates the position of the word that causes the error.	At the current command mode prompt, enter a question mark. All the command keywords allowed in this command mode will be displayed.

1.3.7 History Commands

The system automatically saves commands that are entered recently. You can use short-cut keys to display or call history commands.

The methods are described in the following table.

Operation	Result
Ctrl+P or the UP key	Display the previous command in the history command list. Starting from the latest record, you can repeatedly perform this operation to query earlier records.
Ctrl+N or the DOWN key	After pressing Ctrl+N or the DOWN key, you can return to a command that is recently executed in the history command list. You can repeatedly perform this operation to query recently executed commands.

The standard terminals, such as the VT100 series, support the direction keys.

1.3.8 Featured Editing

When editing the command line, you can use the keys or short-cut keys listed in the following table:

Function	Key or Short-Cut Key	Description
Move the cursor on the editing line.	Left key or Ctrl+B	Move the cursor to the previous character.
	Right key or Ctrl+B	Move the cursor to the next character.
	Ctrl+A	Move the cursor to the head of the command line.
	Ctrl+E	Move the cursor to the end of the command line.

Function	Key or Short-Cut Key	Description
Delete an entered character.	Backspace key	Delete one character to the left of the cursor.
	Delete key	Delete one character to the right of the cursor.
Move the output by one line or one page.	Return key	When displaying contents, press the Return key to move the output one line upward and display the next line. This operation is performed when the output does not end yet.
	Space key	When displaying contents, press the Space key to page down and display the next page. This operation is performed when the output does not end yet.

When the editing cursor is close to the right boundary, the entire command line will move to the left by 20 characters, and the hidden front part is replaced by the dollar (\$) signs. You can use the related keys or short-cut keys to move the cursor to the characters in the front or return to the head of the command line.

For example, the whole **access-list** may exceed the screen width. When the cursor is close to the end of the command line for the first time, the entire command line moves to the left by 20 characters, and the hidden front part is replaced by the dollar signs (\$). Each time the cursor is close to the right boundary, the entire command line moves to the left by 20 characters.

```
access-list 199 permit ip host 192.168.180.220 host
$ost 192.168.180.220 host 202.101.99.12
$0.220 host 202.101.99.12 time-range tr
```

Press **Ctrl+A** to return to the head of the command line. At this time, the hidden tail part of the command line is replaced by the dollar signs (\$).

```
access-list 199 permit ip host 192.168.180.220 host 202.101.99.$
```

1.3.9 Searching and Filtering of the Show Command Output

To search specified contents from the output of the **show** command, run the following command:

Command	Description
show <i>any-command</i> begin <i>regular-expression</i>	Searches specified contents from the output of the show command. The first line containing the contents and all information that follows this line will be output.

- The **show** command can be executed in any mode.
- Searched contents are case sensitive.

To filter specified contents from the output of the **show** command, run the following commands:

Command	Description
show <i>any-command</i> exclude <i>regular-expression</i>	Filters the output of the show command. Except those containing the specified contents, all lines will be output.
show <i>any-command</i> include <i>regular-expression</i>	Filters the output of the show command. Only the lines containing the specified contents will be output.

To search or filter the output of the **show** command, you must enter a vertical line (|). After the vertical line, select the searching or filtering rules and contents (character or string). Searched and filtered contents are case sensitive.

```
FS#show running-config | include interface
```

```
interface GigabitEthernet 0/0
interface GigabitEthernet 0/1
interface GigabitEthernet 0/2
interface GigabitEthernet 0/3
interface GigabitEthernet 0/4
interface GigabitEthernet 0/5
interface GigabitEthernet 0/6
interface GigabitEthernet 0/7
interface Mgmt 0
```

1.3.10 Command Alias

You can configure any word as the alias of a command to simplify the command input.

Configuration Effect

1. Replace a command with a word.

For example, configure "mygateway" as the alias of the **ip route** *0.0.0.0 0.0.0.0 192.1.1.1* command. To run this command, you only need to enter "mygateway".

2. Replace the front part of a command with a word, and enter the later part.

For example, configure "ia" as the alias of the **ip address** command. To run this command, you need to enter "ia" and then the specified IP address and subnet mask.

Configuration Steps

📌 Displaying Default Alias

In User EXEC or Privileged EXEC mode, default alias are available for some commands. You can run the **show aliases** command to display these default aliases.

```
FS(config)#show aliases
Exec mode alias:
h          help
p          ping
s          show
u          undebug
un         undebug
```

 These default aliases cannot be deleted.

📌 Configuring a Command Alias

Command	alias <i>mode command-alias original-command</i>
Parameter	<i>mode</i> : indicates the command mode of the command represented by the alias.

Description	<i>command-alias</i> : indicates the command alias. <i>original-command</i> : indicates the command represented by the alias.
Command Mode	Global configuration mode
Usage Guide	In global configuration mode, run the alias ? command to list all command modes that can be configured with aliases.

📌 Displaying Settings of Command Aliases

Run the **show aliases** command to display alias settings in the system.

Notes

- The command replaced by an alias must start from the first character of the command line.
- The command replaced by an alias must be complete.
- The entire alias must be entered when the alias is used; otherwise, the alias cannot be identified.

Configuration Example

📌 Defining an Alias to Replace the Entire Command

Configuration Steps	In global configuration mode, configure the alias "ir" to represent the default route configuration command ip route 0.0.0.0 0.0.0.0 192.168.1.1 .
	<pre>FS#configure terminal FS(config)#alias config ir ip route 0.0.0.0 0.0.0.0 192.168.1.1</pre>
Verification	<ul style="list-style-type: none"> ● Run the show alias command to check whether the alias is configured successfully. <pre>FS(config)#show alias Exec mode alias: h help p ping s show u undebug un undebug Global configuration mode alias: ir ip route 0.0.0.0 0.0.0.0 192.168.1.1</pre>
	<ul style="list-style-type: none"> ● Use the configured alias to run the command, and run the show running-config command to check whether the alias is configured successfully.
	<pre>FS(config)#ir FS(config)#show running-config</pre>

	<pre>Building configuration... ! alias config ir ip route 0.0.0.0 0.0.0.0 192.168.1.1 //Configuring an alias ... ip route 0.0.0.0 0.0.0.0 192.168.1.1 //Configuration result after the alias "ir" is entered !</pre>
--	--

➤ **Defining an Alias to Replace the Front Part of a Command**

Configuration Steps	In global configuration mode, configure the alias "ir" to represent the front part "ip route" of the default route configuration command.
	<pre>FS#configure terminal FS(config)#alias config ir ip route</pre>
Verification	<ul style="list-style-type: none"> ● Run the show alias command to check whether the alias is configured successfully. <pre>FS(config)#show alias Exec mode alias: h help p ping s show u undebug un undebug Global configuration mode alias: ir ip route</pre>
	<ul style="list-style-type: none"> ● Enter the alias "ir" and then the later part of the command "0.0.0.0 0.0.0.0 192.168.1.1". ● Run the show ap-config running command to check whether the configuration is successful.
	<pre>FS(config)#ir 0.0.0.0 0.0.0.0 192.168.1.1 FS(config)#show running Building configuration... ! alias config ir ip route //Configuring an alias ! ip route 0.0.0.0 0.0.0.0 192.168.1.1 //Configuration result after the alias "ir" and the later part of the command are</pre>

	entered !

System Help

1. The system provides help information for command alias. An asterisk (*) will be displayed in front of an alias. The format is as follows:

```
*command-alias=original-command
```

For example, in Privileged EXEC mode, the default command alias "s" represents the **show** keyword. If you enter "s?", the keywords starting by "s" and alias information are displayed.

```
FS#s?
*s=show show start-chat start-terminal-service
```

2. If the command represented by an alias contains more than one word, the command is displayed in a pair of quotation marks.

For example, in Privileged EXEC mode, configure the alias "sv" to replace the **show version** command. If you enter "s?", the keywords starting by "s" and alias information are displayed.

```
FS#s?
*s=show *sv="show version" show start-chat
start-terminal-service
```

3. You can use the alias to obtain help information about the command represented by the alias.

For example, configure the alias "ia" to represent the **ip address** command in interface configuration mode. If you enter "ia?" in interface configuration mode, the help information on "ip address?" is displayed, and the alias is replaced by the command.

```
FS(config-if)#ia ?
A.B.C.D IP address
dhcp IP Address via DHCP
FS(config-if)#ip address
```

 If you enter a space in front of a command, the command represented by this alias will not be displayed.

2 Configuring Basic Management

2.1 Overview

This document is a getting started guide to network device management. It describes how to manage, monitor, and maintain network devices.

2.2 Applications

Application	Description
Network Device Management	A user logs in to a network device from a terminal and runs commands on a command line interface (CLI) to manage device configurations.

2.2.1 Network Device Management

Scenario

Network device management described in this document is performed through the CLI. A user logs in to Network Device A from a terminal and runs commands on the CLI to manage device configurations. See Figure 2- 1.

Figure 2- 1



2.3 Features

Basic Concepts

➤ TFTP

Trivial File Transfer Protocol (TFTP) is a TCP/IP protocol which allows a client to transfer a file to a server or get a file from a server.

➤ AAA

AAA is short for Authentication, Authorization and Accounting.

Authentication refers to the verification of user identities and the related network services.

Authorization refers to the granting of network services to users according to authentication results.

Accounting refers to the tracking of network service consumption by users. A billing system charges users based on consumption records.

AAA provides effective means of network management and security protection.

➤ RADIUS

Remote Authentication Dial In User Service (RADIUS) is the most widely used AAA protocol at present.

➤ Telnet

Telnet is a terminal emulation protocol in the TCP/IP protocol stack which provides access to a remote host through a virtual terminal connection. It is a standard protocol located at Layer 7 (application layer) of the Open System Interconnection (OSI) model and used on the internet for remote login. Telnet sets up a connection between the local PC and a remote host.

➤ System Information

System information includes the system description, power-on time, hardware and software versions, control-layer software version, and boot-layer software version.

Hardware Information

Hardware information includes the physical device information as well as slot and module information. The device information includes the device description and slot quantity. The slot information includes the slot ID, module description (which is empty if a slot does not have a module), and actual and maximum number of physical ports.

Overview

Feature	Description
User Access Control	Controls the terminal access to network devices on the internet based on passwords and privileges.
Login Authentication Control	Performs username-password authentication to grant access to network devices when AAA is enabled. (Authentication is performed by a dedicated server.)
Basic System Parameters	Refer to the parameters of a system, such as the clock, banner, and Console baud rate.
Displaying Configurations	Displays the system configurations, including the configurations that the system is currently running and the device configurations stored in the nonvolatile random access memory (NVRAM).
Telnet	Telnet is an application-layer protocol in the TCP/IP protocol stack. It provides the standard governing remote login and virtual terminal communication on the internet.
Restart	Introduces system restart.

2.3.1 User Access Control

User access control refers to the control of terminal access to network devices on the internet based on passwords and privileges.

Working Principle

Privilege Level

16 privilege levels are defined ranging from 0 to 15 for CLI on network devices to grant users access to different commands. Level 0 is the lowest level granting access to just a few commands, whereas level 15 is the highest level granting access to all commands. Levels 0 and 1 are common user levels without the device configuration permission (users are not allowed to enter global configuration mode by default). Levels 2–15 are privileged user levels with the device configuration permission.

Password Classification

Passwords are classified into two types: password and security. The first type refers to simple encrypted passwords at level 15. The second type refers to secure encrypted passwords at levels 0–15. If a level is configured with both simple and secure encrypted passwords, the simple encrypted password will not take effect. If you configure a non-15 level simple encrypted password, a warning is displayed and the password is automatically converted into a secure encrypted password. If you configure the same simple encrypted password and secure encrypted password at level 15, a warning is displayed.

Password Protection

Each privilege level on a network device has a password. An increase in privilege level requires the input of the target level password, whereas a reduction in privilege level does not require password input.

By default, only two privilege levels are password-protected, namely, level 1 (common user level) and level 15 (privileged user level). Sixteen privilege levels with password protection can be assigned to the commands in each mode to grant access to different commands.

If no password is configured for a privileged user level, access to this level does not require password input. It is recommended that a password be configured for security purposes.

↘ **Command Authorization**

Each command has its lowest execution level. A user with a privilege level lower than this level is not allowed to run the command. After the command is assigned a privilege level, users at this level and higher have access to the command.

Related Configuration

↘ **Configuring a Simple Encrypted Password**

- Run the **enable password** command.

↘ **Configuring a Secure Encrypted Password**

- Run the **enable secret** command.
- A secure encrypted password is used to control the switching between user levels. It has the same function as a simple encrypted password but uses an enhanced password encryption algorithm. Therefore, secure encrypted passwords are recommended out of security consideration.

↘ **Configuring Command Privilege Levels**

- Run the **privilege** command to assign a privilege level to a command.
- A command at a lower level is accessible by more users than a command at a higher level.

↘ **Raising/Lowering a User Privilege Level**

- Run the **enable** command or the **disable** command to raise or lower a user privilege level respectively.
- After logging in to a network device, the user can change his/her level to obtain access to commands at different privilege levels.
- To enable level increase logging, run the **login privilege log** command.

↘ **Enabling Line Password Protection**

- Line password protection is required for remote login (such as login through Telnet).
- Run the **password [0 | 7] line** command to configure a line password, and then run the **login** command to enable password protection.
- By default, terminals do not support the **lock** command.

2.3.2 Login Authentication Control

In login authentication with AAA disabled, the password entered by a user is checked against the configured line password. If they are consistent, the user can access the network device. In local authentication, the username and password entered by a user are checked against those stored in the local user database. If they are matched, the user can access the network device with proper management permissions.

In AAA, the username and password entered by a user are authenticated by a server. If authentication is successful, the user can access the network device and enjoy certain management permissions.

For example, a RADIUS server can be used to authenticate usernames and passwords and control users' management permissions on network devices. Network devices no longer store users' passwords, but send encrypted user information to the RADIUS server, including usernames, passwords, shared passwords, and access policies. This provides a convenient way to manage and control user access and improve user information security.

Working Principle

↳ Line Password

If AAA is disabled, you can configure a line password used to verify user identities during login. After AAA is enabled, line password verification does not take effect.

↳ Local Authentication

If AAA is disabled, you can configure local authentication to verify user identities and control management permissions by using the local user database. After AAA is enabled, local authentication does not take effect.

↳ AAA

AAA provides three independent security functions, namely, Authentication, Authorization and Accounting. A server (or the local user database) is used to perform authentication based on the configured login authentication method list and control users' management permissions. For details about AAA, see *Configuring AAA*.

Related Configuration

↳ Configuring Local User Information

- Run the **username** command to configure the account used for local identity authentication and authorization, including usernames, passwords, and optional authorization information.

↳ Configuring Local Authentication for Line-Based Login

- Run the **login local** command (in the case that AAA is disabled).
- Perform this configuration on every device.

↳ Configuring AAA Authentication for Line-Based Login

- The default authentication method is used after AAA is enabled.
- Run the **login authentication** command to configure a login authentication method list for a line.
- Perform this configuration when the local AAA authentication is required.

↳ Configuring the Connection Timeout Time

- The default connection timeout time is 10 minutes.
- Run the **exec-timeout** command to change the default connection timeout time. An established connection will be closed if no output is detected during the timeout time.
- Perform this configuration when you need to increase or reduce the connection timeout time.

↳ Configuring the Session Timeout Time

- The default session timeout time is 0 minutes, indicating no timeout.
- Run the **session-timeout** command to change the default session timeout time.
- The session established to a remote host through a line will be disconnected if no output is detected during the timeout time. Then the remote host is restored to Idle. Perform this configuration when you need to increase or reduce the session timeout time.

↘ Locking a Session

- By default, terminals do not support the **lock** command.
- Run the **lockable** command to lock the terminals connected to the current line.
- To lock a session, first enable terminal lock in line configuration mode, and then run the **lock** command in terminal EXEC mode to lock the terminal.

2.3.3 Basic System Parameters

↘ System Time

The network device system clock records the time of events on the device. For example, the time shown in system logs is obtained from the system clock. Time is recorded in the format of *year-month-day, hour:minute:second, day of the week*.

When you use a network device for the first time, set its system clock to the current date and time manually.

↘ Configuring a System Name and Command Prompt

You can configure a system name to identify a network device. The default system name is **FS**. A name with more than 32 characters will be truncated to keep only the first 32 characters. The command prompt keeps consistent with the system name.

↘ Banner

A banner is used to display login prompt information. There are two types of banner: Daily notification and login banner.

- Daily notification is displayed on all terminals connected to network devices soon after login. Urgent messages (such as immediate system shutdown) can be delivered to users through daily notification.
- A login banner appears after daily notification to display login information.

↘ Configuring the Console Baud Rate

You can manage network device through a Console port. The first configuration on the network device must be performed through the Console port. The serial port baud rate can be changed based on actual requirements. Note that the management terminal must have consistent baud rate setting with the device console.

↘ Configuring the Connection Timeout Time

The connection timeout time is used to control device connections (including established connections and sessions established to remote hosts). A connection will be closed when no input is detected during the timeout time.

Related Configuration

↘ Configuring the System Date and Clock

- Run the **clock set** command to configure the system time of a network device manually. The device clock starts from the configured time and keeps running even when the device is powered off.

↘ Updating the Hardware Clock

- If the hardware clock and software clock are not synchronized, run the **clock update-calendar** command to copy the date and time of the software clock to the hardware clock.

↘ Configuring a System Name

- Run the **hostname** command to change the default system name.
- The default host name is **FS**.

↘ Configuring a Command Prompt

- Run the **prompt** command.

↘ Configuring Daily Notification

- By default, no daily notification is configured.
- Run the **banner motd** command to configure daily notification.
- Daily notification is displayed on all terminals connected to network devices soon after login. Urgent messages (such as immediate system shutdown) can be delivered to users through daily notification.

↘ Configuring a Login Banner

- By default, no login banner is configured.
- Run the **banner login** command to configure a login banner to display login information.

↘ Configuring the Console Baud Rate

- Run the **speed** command.
- The default baud rate is 9,600 bps.

2.3.4 Displaying Configurations

Displays the system configurations, including the configurations that the system is currently running and the device configurations stored in the NVRAM.

Working Principle

↘ Running Configurations

Running configurations, namely, running-config, are the configurations that individual component modules run in real time. A request can be made to all running components to collect configurations, which will be orchestrated before being displayed to users. Only running components may provide real-time configurations, whereas unloaded components do not display configurations. In the case that the system is started, a component process is restarted, and a hot patch is executed, the configurations collected during this period may be inaccurate due to the component unstable state. For example, the configurations of a component may not be missing initially but can be displayed later.

↘ Startup Configurations

The configurations stored in the NVRAM, namely, startup-config, are the configurations executed during device startup. When the system is restarted, startup-config is loaded to become new running-config. To display permanent configurations, the system needs to read the **startup-config** file in the NVRAM.



The startup-config file copied to the device only supports UTF-8 encoding without BOM.

Related Configuration

▾ Displaying Running Configurations

Run the **show running-config [interface interface]** command to display the configurations that the system is currently running or the configurations on an interface.

▾ Displaying Startup Configurations

Run the **show startup-config** command.

▾ Storing Startup Configurations

Run the **write** or **copy running-config startup-config** command to store the current running configurations as new startup configurations.

2.3.5 Telnet

Working Principle

Telnet is an application-layer protocol in the TCP/IP protocol stack. It provides the standard governing remote login and virtual terminal communication on the internet.

The Telnet Client service allows a local or remote user who has logged in to a network device to use its Telnet Client program to access other remote system resources on the internet. In Figure 2-2, a user with a PC connects to Network Device A by using the terminal emulation or Telnet program and then logs in to Network Device B by using the **telnet** command to perform configuration management.

FS Telnet program supports the use of IPv4 and IPv6 addresses. A Telnet server accepts Telnet connection requests that carry IPv4 and IPv6 addresses. A Telnet client can send connection requests to hosts identified by IPv4 and IPv6 addresses.

Figure 2-2

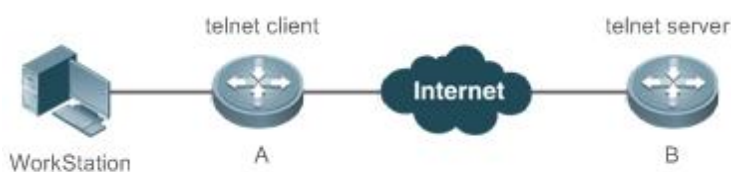

Related Configuration

▾ Enabling the Telnet Client Service

- Run the **telnet** command to log in to a remote device.

▾ Restoring a Telnet Client Session

- Run the **<1-99>** command.

➤ **Disconnecting a Suspended Telnet Client Session**

- Run the **disconnect** *session-id* command.

➤ **Enabling the Telnet Server Service**

- Run the **enable service telnet-server** command.
- Perform this configuration when you need to enable Telnet login.

2.3.6 Restart

The timed restart feature makes user operation easier in some scenarios (such as tests).

- If you configure a time interval, the system will restart after the interval. The interval is in the format of *mmm* or *hh:mm*, in the unit of minutes. You can specify the interval name to reflect the restart purpose.
- If you define a future time, the system will restart when the time is reached.

The clock feature must be supported by the system if you want to use the **at** option. It is recommended that you configure the system clock in advance. A new restart plan will overwrite the existing one. A restart plan will be invalid if the system is restarted before the plan takes effect.

The span between the restart time and current time must not exceed 31 days, and the restart time must be later than the current system time. After you configure a restart plan, do not to change the system clock; otherwise, the plan may fail (for example, the system time is changed to a time after the restart time.)

Related Configuration

➤ **Configuring Restart**

- Run the **reload** command to configure a restart policy.
- Perform this configuration when you need to restart a device at a specific time.

2.3.7 Telnet Service

Enable Telnet server on the device, and users can connect to the device securely via Telnet client.

Related Configuration

➤ **Configuring ACL for Telnet Server**

- No ACL is configured for the Telnet server by default.
- Run the { **ip | ipv6** } **telnet access-class** command to configure ACL for the Telnet server. Run the **no** { **ip | ipv6** } **telnet access-class** command to remove the ACL settings.

2.4 Configuration

Configuring Passwords and Privileges	(Optional) It is used to configure passwords and command privilege levels.	
	enable password	Configures a simple encrypted password.
	enable secret	Configures a secure encrypted password.

	enable	Raises a user privilege level.
	login privilege log	Outputs log information of user privilege level increase.
	disable	Lowers a user privilege level.
	privilege	Configures command privilege levels.
	password	Specifies a line password.
	login	Enables line password protection.
Configuring Login and Authentication	(Optional) It is used to configure different login modes and authentication methods.	
	username	Configures local user account information and optional authorization information.
	login local	Configures local authentication for line-based login.
	login authentication	Configures AAA authentication for line-based login.
	telnet	Enables the Telnet Client service.
	enable service telnet-server	Enables the Telnet Server service.
	exec-timeout	Configures the connection timeout time.
	session-timeout	Configures the session timeout time.
	lockable	Enables line-based terminal lock.
	lock	Locks a terminal connected to the current line.
Configuring Basic System Parameters	(Optional) It is used to configure basic system parameters.	
	clock set	Configures the system date and clock.
	clock update-calendar	Updates the hardware clock.
	hostname	Configures a system name.
	prompt	Configures a command prompt.
	banner motd	Configures daily notification.
	bannerlogin	Configures a login banner.
	speed	Configures the Console baud rate.
Enabling and Disabling a Specific Service	(Optional) It is used to enable and disable a specific service.	
	enable service	Enables a service.
Configuring a Restart Policy	(Optional) It is used to configure a system restart policy.	
	reload	Restarts a device.
Configuring Telnet Service	(Optional) It is used to configure the ACL for the Telnet server.	
	{ ip ipv6 } telnet access-class { access-list-number access-list-name }	Configures the ACL for the Telnet server.

2.4.1 Configuring Passwords and Privileges

Configuration Effect

- Configure passwords to control users' access to network devices.

- Assign a privilege level to a command to grant the command access to only the users at or higher than the level.
- Lower the command privilege level to grant more users access to the command.
- Raise the command privilege level to limit the command access to a few users.

Notes

- You can use the password configuration command with the **level** option to configure a password for a specific privilege level. After you specify the level and the password, the password works for the users who need to access this level.
- By default, no password is configured for any level. The default level is 15.
- If you configure a simple encrypted password with a non-15 level, a warning is displayed and the password is automatically converted into a secure encrypted password.
- The system chooses the secure encrypted password over the simple encrypted password if both of them are configured.

Configuration Steps

↘ **Configuring a Simple Encrypted Password**

- (Optional) Perform this configuration when you need to establish simple encrypted password verification when users switch between different privilege levels.
- Run the **enable password** command to configure a simple encrypted password.

↘ **Configuring a Secure Encrypted Password**

- (Optional) Perform this configuration when you need to establish secure encrypted password verification when users switch between different privilege levels.
- Run the **enable secret** command to configure a secure encrypted password.
- A secure encrypted password has the same function as a simple encrypted password but uses an enhanced password encryption algorithm. Therefore, secure encrypted passwords are recommended out of security consideration.

↘ **Configuring Command Privilege Levels**

- Optional.
- A command at a lower level is accessible by more users than a command at a higher level.

↘ **Raising/Lowering a User Privilege Level**

- After logging in to a network device, the user can change his/her level to obtain access to commands at different privilege levels.
- Run the **enable** command or the **disable** command to raise or lower a user privilege level respectively.

↘ **Enabling Line Password Protection**

- (Optional) Line password protection is required for remote login (such as login through Telnet).
- Run the **password [0 | 7] line** command to configure a line password, and then run the **login** command to enable login authentication.

 If a line password is configured but login authentication is not configured, the system does not display password prompt.

Verification

- Run the **show privilege** command to display the current user level.
- Run the **show running-config** command to display the configuration.

Related Commands

📌 **Configuring a Simple Encrypted Password**

Command	enable password [level <i>level</i>] { <i>password</i> [0 7] <i>encrypted-password</i> }
Parameter	<i>level</i> : Indicates a specific user level.
Description	<p><i>password</i>: Indicates the password used to enter privileged EXEC mode.</p> <p>0: Indicates that the password is entered in plaintext.</p> <p>7: Indicates that the password is entered in cyphertext.</p> <p><i>encrypted-password</i>: Indicates the password text, which must contain case-sensitive English letters and digits.</p> <p> Leading spaces are allowed, but will be ignored. However, intermediate and trailing spaces are recognized.</p>
Command Mode	Global configuration mode
Usage Guide	<p>Currently, simple encrypted passwords can be configured with only level 15 and take effect only when no secure encrypted password is configured.</p> <p>If you configure a simple encrypted password with a non-15 level, a warning is displayed and the password is automatically converted into a secure encrypted password.</p> <p>If the level 15 simple encrypted password and secure encrypted password are configured the same, a warning is displayed.</p> <p> If you specify an encryption type and enter a password in plaintext, you cannot re-enter privileged EXEC mode. An encrypted password cannot be retrieved once lost. You have to configure a new password.</p>

📌 **Configuring a Secure Encrypted Password**

Command	enable secret [level <i>level</i>] { <i>secret</i> [0 5] <i>encrypted-secret</i> }
Parameter	<i>level</i> : Indicates a specific user level.
Description	<p><i>secret</i>: Indicates the password used to enter privileged EXEC mode.</p> <p>0 5: Indicates the password encryption type. 0 indicates no encryption, and 5 indicates secure encryption.</p> <p><i>encrypted-password</i>: Indicates the password text.</p>
Command Mode	Global configuration mode
Usage Guide	Use this command to configure passwords for different privilege levels.

📌 **Raising a User Privilege Level**

Command	enable [<i>privilege-level</i>]
Parameter	<i>privilege-level</i> : Indicates a specific privilege level.
Description	
Command Mode	Privileged EXEC mode
Usage Guide	An increase in privilege level requires the input of the target level password.

📌 **Lowering a User Privilege Level**

Command	disable [<i>privilege-level</i>]
Parameter	<i>privilege-level</i> : Indicates a specific privilege level.
Description	
Command Mode	Privileged EXEC mode
Usage Guide	<p>A reduction in privilege level does not require password input.</p> <p>Use this command to exit Privileged EXEC mode and return to user EXEC mode. If <i>privilege-level</i> is specified, the current privilege level is reduced to the specified level.</p> <p> <i>privilege-level</i> must be lower than the current level.</p>

↘ **Enabling Level Increase Logging**

Command	login privilege log
Parameter	N/A
Description	
Command Mode	Global configuration mode
Usage Guide	Use this command to enable logging of privilege level increase. The configuration takes effect for all terminals.

↘ **Configuring Command Privilege Levels**

Command	privilege mode [all] { level level reset } <i>command-string</i>
Parameter	<i>mode</i> : Indicates the CLI mode of the command. For example, config indicates the global configuration mode, EXEC indicates the privileged command mode, and interface indicates the interface configuration mode.
Description	<p>all: Changes the subcommand privilege levels of a specific command to the same level.</p> <p>level level: Indicates a privilege level, ranging from 0 to 15.</p> <p>reset: Restores the command privilege level to the default.</p> <p><i>command-string</i>: Indicates the command to be assigned a privilege level.</p>
Command Mode	Global configuration mode
Usage Guide	To restore a command privilege level, run the no privilege mode [all] level level command command in global configuration mode.

↘ **Specifying a Line Password**

Command	password [0 7] <i>line</i>
Parameter	0 : Indicates to configure a password in plaintext.
Description	<p>7: Indicates to configure a password in cyphertext.</p> <p><i>line</i>: Indicates the password string.</p>
Command Mode	Line configuration mode
Usage Guide	N/A

↘ **Enabling Line Password Protection**

Command	login
Parameter	N/A

Description	
Command	Line configuration mode
Mode	
Usage Guide	N/A

Configuration Example

📌 **Configuring Command Authorization**

Scenario	Assign privilege level 1 to the reload command and its subcommands and configure level 1 as the valid level (by configuring the test password).
Configuration Steps	<ul style="list-style-type: none"> ● Assign privilege level 1 to the reload command and its subcommands. <pre>FS# configure terminal FS(config)# privilege exec all level 1 reload FS(config)# enable secret level 1 0 test FS(config)# end</pre>
Verification	<ul style="list-style-type: none"> ● Check whether the reload command and its subcommands are accessible at level 1. <pre>FS# disable 1 FS> reload ? at reload at <cr></pre>

2.4.2 Configuring Login and Authentication

Configuration Effect

- Establish line-based login identity authentication.
- Run the **telnet** command on a network device to log in to a remote device.
- Close an established connection if no output is detected during the timeout time.
- Disconnect an established session connecting to a remote host and restore the host to Idle if no output is detected during the timeout time.
- Lock a terminal to deny access. When a user enters any character on the locked terminal, the password prompt is displayed. The terminal will be automatically unlocked if the entered password is correct.

Configuration Steps

📌 **Configuring Local User Information**

- Mandatory.

- Run the **username** command to configure the account used for local identity authentication and authorization, including usernames, passwords, and optional authorization information.
- Perform this configuration on every device.
- ▼ **Configuring Local Authentication for Line-Based Login**
 - Mandatory.
 - Configure local authentication for line-based login in the case that AAA is disabled.
 - Perform this configuration on every device.
- ▼ **Configuring AAA Authentication for Line-Based Login**
 - (Optional) Perform this configuration to configure AAA authentication for line-based login.
 - Configure AAA authentication for line-based login in the case that AAA is enabled.
 - Perform this configuration on every device.
- ▼ **Enabling the Telnet Client Service**
 - Run the **telnet** command to log in to a remote device.
- ▼ **Restoring a Telnet Client Connection**
 - (Optional) Perform this configuration to restore the connection on a Telnet client.
- ▼ **Closing a Suspended Telnet Client Connection**
 - (Optional) Perform this configuration to close the suspended connection on a Telnet client.
- ▼ **Enabling the Telnet Server Service**
 - Optional.
 - Enable the Telnet Server service when you need to enable Telnet login.
- ▼ **Configuring the Connection Timeout Time**
 - Optional.
 - An established connection will be closed if no output is detected during the timeout time.
 - Perform this configuration when you need to increase or reduce the connection timeout time.
- ▼ **Configuring the Session Timeout Time**
 - Optional.
 - The session connecting to a remote host will be disconnected and the host be restored to Idle if no output is detected during the timeout time.
 - Perform this configuration when you need to increase or reduce the session timeout time.
- ▼ **Locking a Session**
 - (Optional) Perform this configuration when you need to temporarily exit a session on a device.
 - To lock a session, first enable terminal lock in line configuration mode, and then run the **lock** command to lock the terminal.

Verification

- Run the **show running-config** command to display the configuration.
- In the case that AAA is disabled, after local user information and line-based local authentication are configured, check whether users are prompted for username and password input for access to the CLI.
- In the case that AAA is enabled, after local user information and local AAA authentication are configured, check whether users are prompted for username and password input for access to the CLI.
- Run the **show user** command to display the information about the users who have logged in to the CLI.
- Telnet clients can connect to devices enabled with the Telnet Server service.
- When a user presses **Enter** on a locked CLI, the user is prompted for password input. The session is unlocked only when the entered password is the same as the configured one.
- Run the **show sessions** command to display every established Telnet client instance.

Related Commands

📄 **Configuring Local User Information**

Command	username <i>name</i> [login mode { aux console ssh telnet }] [online amount <i>number</i>] [permission <i>oper-mode path</i>] [privilege <i>privilege-level</i>] [reject remote-login] [web-auth] [pwd-modify] [nopassword password [0 7] <i>text-string</i> secret [0 5] <i>text-string</i>]
Parameter Description	<p><i>name</i>: Indicates a user name.</p> <p>login mode: Indicates the login mode.</p> <p>aux: Sets the login mode to AUX.</p> <p>console: Sets the login mode to Console.</p> <p>ssh: Sets the login mode to SSH.</p> <p>telnet: Sets the login mode to Telnet.</p> <p>online amount <i>number</i>: Indicates the maximum number of online accounts.</p> <p>permission <i>oper-mode path</i>: Configures the file operation permission. <i>op-mode</i> indicates the operation mode, and <i>path</i> indicates the directory or path of a specific file.</p> <p>privilege <i>privilege-level</i>: Indicates the account privilege level, ranging from 0 to 15.</p> <p>reject remote-login: Rejects remote login by using the account.</p> <p>web-auth: Allows only Web authentication for the account.</p> <p>pwd-modify: Allows the account owner to change the password. This option is available only when web-auth is configured.</p> <p>nopassword: Indicates that no password is configured for the account.</p> <p>password [0 7] <i>text-string</i>: Indicates the password configured for the account. 0 indicates that the password is input in plaintext, and 7 indicates that the password is input in cyphertext. The default is plaintext.</p> <p>secret [0 5] <i>text-string</i>: Configures an irreversibly encrypted password. If the password type is 0, the password is in plain text. If the type is 7, the password is encrypted. The password is in plain text by default.</p>
Command Mode	Global configuration mode
Usage Guide	<p>Use this command to create a local user database to be used by authentication.</p> <p>If the value 7 is selected for the encryption type, the entered cyphertext string must consist of an even number of characters.</p>

	This setting is applicable to the scenario where encrypted passwords may be copied and pasted. In other cases, the value 7 is not selected.
--	---

➤ **Configuring Local Authentication for Line-Based Login**

Command	login local
Parameter	N/A
Description	
Command Mode	Line configuration mode
Usage Guide	Use this command to configure local authentication for line-based login in the case that AAA is disabled. Local user information is configured by using the username command.

➤ **Configuring AAA Authentication for Line-Based Login**

Command	login authentication { default list-name }
Parameter	default: Indicates the default authentication method list name.
Description	<i>list-name:</i> Indicates the optional method list name.
Command Mode	Line configuration mode
Usage Guide	Use this command to configure AAA authentication for line-based login in the case that AAA is enabled. The AAA authentication methods, including RADIUS authentication, local authentication, and no authentication, are used during the authentication process.

➤ **Enabling the Telnet Client Service**

Command	telnet [oob] host [port] [/source { ip A.B.C.D ipv6 X:X:X::X interface interface-name }] [/vrf vrf-name] [via mgmt-name]
Parameter Description	<p>oob: Remotely connects to a Telnet server through out-of-band communication (by using a management port). This option is available only when the device has a management port.</p> <p><i>host:</i> Indicates the IPv4 address, IPv6 address, or host name of the Telnet server.</p> <p><i>port:</i> Indicates the TCP port number of the Telnet server. The default value is 23.</p> <p>/source: Indicates the source IP address or source port used by a Telnet client.</p> <p>ip A.B.C.D: Indicates the source IPv4 address used by the Telnet client.</p> <p>ipv6 X:X:X::X: Indicates the source IPv6 address used by the Telnet client.</p> <p>interface interface-name: Indicates the source port used by the Telnet client.</p> <p>/vrf vrf-name: Indicates the name of the virtual routing and forwarding (VRF) table to be queried.</p> <p>via mgmt-name: Indicates the management port used by the Telnet client when the oob option is specified.</p>
Command Mode	Privileged EXEC mode
Usage Guide	A user can telnet to a remote device identified by an IPv4 host name, IPv6 host name, IPv4 address, or IPv6 address.

➤ **Restoring a Telnet Client Session**

Command	<1-99>
Parameter	N/A
Description	

Command Mode	User EXEC mode
Usage Guide	Use this command to restore a Telnet client session. A user can press the shortcut key Ctrl+Shift+6 X to temporarily exit the Telnet client session that is established using the telnet command, run the <1-99> command to restore the session, and run the show sessions command to display the session information.

↘ Closing a Suspended Telnet Client Connection

Command	disconnect <i>session-id</i>
Parameter Description	<i>session-id</i> : Indicates the suspended Telnet client session ID.
Command Mode	User EXEC mode
Usage Guide	Use this command to close a specific Telnet client session by entering the session ID.

↘ Enabling the Telnet Server Service

Command	enable service telnet-server
Parameter Description	N/A
Command Mode	Global configuration mode
Usage Guide	Use this command to enable the Telnet Server service. The IPv4 and IPv6 services are also enabled after the command is executed.

↘ Configuring the Connection Timeout Time

Command	exec-timeout <i>minutes</i> [<i>seconds</i>]
Parameter Description	<i>minutes</i> : Indicates the connection timeout time in the unit of minutes. <i>seconds</i> : Indicates the connection timeout time in the unit of seconds.
Command Mode	Line configuration mode
Usage Guide	Use this command to configure the timeout time for the established connections on a line. A connection will be closed when no input is detected during the timeout time. To remove the connection timeout configuration, run the no exec-timeout command in line configuration mode.

↘ Configuring the Session Timeout Time

Command	session-timeout <i>minutes</i> [output]
Parameter Description	<i>minutes</i> : Indicates the session timeout time in the unit of minutes. output : Indicates whether to add data output as a timeout criterion.
Command Mode	Line configuration mode
Usage Guide	Use this command to configure the timeout time for the remote host sessions on a line. A session will be disconnected when no input is detected during the timeout time. To cancel the session timeout time, run the no session-timeout command in line configuration mode.

↘ Enabling Line-Based Terminal Lock

Command	lockable
Parameter	N/A
Description	
Command Mode	Line configuration mode
Usage Guide	N/A

📌 **Locking a Terminal Connected to the Current Line**

Command	lock
Parameter	N/A
Description	
Command Mode	Line configuration mode
Usage Guide	N/A

Configuration Example

📌 **Establishing a Telnet Session to a Remote Network Device**

Configuration Steps	<ul style="list-style-type: none"> Establish a Telnet session to a remote network device with the IP address 192.168.65.119. Establish a Telnet session to a remote network device with the IPv6 address 2AAA:BBBB::CCCC. Run the telnet command in privileged EXEC mode,
	<pre>FS# telnet 192.168.65.119 Trying 192.168.65.119 ... Open User Access Verification Password:</pre>
	<pre>FS# telnet 2AAA:BBBB::CCCC Trying 2AAA:BBBB::CCCC ... Open User Access Verification Password:</pre>
Verification	<ul style="list-style-type: none"> Check whether the Telnet sessions are established to the remote network devices.

📌 **Configuring the Connection Timeout Time**

Configuration Steps	<ul style="list-style-type: none"> Set the connection timeout time to 20 minutes.
	<pre>FS# configure terminal //Enter global configuration mode. FS# line vty 0 //Enter line configuration mode. FS(config-line)#exec-timeout 20 //Set the connection timeout time to 20 minutes.</pre>

Verification	<ul style="list-style-type: none"> ● Check whether the connection between a terminal and the local device is closed when no input is detected during the timeout time.
---------------------	---

➤ **Configuring the Session Timeout Time**

Configuration Steps	<ul style="list-style-type: none"> ● Set the session timeout time to 20 minutes. <pre style="background-color: #f0f0f0; padding: 5px;"> FS# configure terminal//Enter global configuration mode. FS(config)# line vty 0 //Enter line configuration mode. FS(config-line)#session-timeout 20//Set the session timeout time to 20 minutes.</pre>
Verification	<ul style="list-style-type: none"> ● Check whether the session between a terminal and the local device is disconnected when no input is detected during the timeout time.

2.4.3 Configuring Basic System Parameters

Configuration Effect

- Configure basic system parameters.

Configuration Steps

➤ **Configuring the System Date and Clock**

- Mandatory.
- Configure the system time of a network device manually. The device clock starts from the configured time and keeps running even when the device is powered off.

 The time configuration is applied only to the software clock if the network device does not provide a hardware clock. The configuration will be invalid when the device is powered off.

➤ **Updating the Hardware Clock**

- Optional.
- Perform this configuration when you need to copy the date and time of the software clock to the hardware clock so that the hardware clock is synchronized with the software clock.

➤ **Configuring a System Name**

- (Optional) Perform this configuration to change the default system name.

➤ **Configuring a Command Prompt**

- (Optional) Perform this configuration to change the default command prompt.

➤ **Configuring Daily Notification**

- (Optional) Perform this configuration when you need to display important prompts or warnings to users.
- You can configure notification in one or multiple lines, which will be displayed to users after login.

➤ **Configuring a Login Banner**

- (Optional) Perform this configuration when you need to display important messages to users upon login or logout.

✚ Configuring the Console Baud Rate

- (Optional) Perform this configuration to change the default Console baud rate.

Verification

- Run the **show clock** command to display the system time.
- Check whether a login banner is displayed after login.
- Run the **show version** command to display the system information and version.

Related Commands

✚ Configuring the System Date and Clock

Command	clock set <i>hh:mm:ss month day year</i>
Parameter	<i>hh:mm:ss</i> : Indicates the current time, in the format of <i>hour</i> (24-hour format): <i>minute</i> : <i>second</i> .
Description	<i>day</i> : Indicates a day (1–31) of the month. <i>month</i> : Indicates a month (from January to December) of the year. <i>year</i> : Indicates a year, ranging from 1993 to 2035. Abbreviation is not supported.
Command Mode	Privileged EXEC mode
Usage Guide	Use this command to configure the system time. If the device does not provide a hardware clock, the time configuration will be invalid when the device is powered off.

✚ Updating the Hardware Clock

Command	clock update-calendar
Parameter	N/A
Description	
Command Mode	Privileged EXEC mode
Usage Guide	After the configuration, the time of the software clock will overwrite that of the hardware clock.

✚ Configuring a System Name

Command	hostname <i>name</i>
Parameter	<i>name</i> : Indicates the system name, which must consist of printable characters and must not exceed 63 bytes.
Description	
Command Mode	Global configuration mode
Usage Guide	To restore the system name to the default, run the no hostname command in global configuration mode.

✚ Configuring a Command Prompt

Command	prompt <i>string</i>
Parameter	<i>string</i> : Indicates the command prompt name. A name with more than 32 characters will be truncated to keep only

Description	the first 32 characters.
Command Mode	Privileged EXEC mode
Usage Guide	To restore the command prompt to the default settings, run the no prompt command in global configuration mode.

↘ **Configuring Daily Notification**

Command	banner motd <i>c message c</i>
Parameter Description	<i>c</i> : Indicates a delimiter, which can be any character, such as "&".
Command Mode	Global configuration mode
Usage Guide	A message must start and end with delimiter+carriage return respectively. Any characters following the ending delimiter will be dropped. Any letter contained in the message must not be used as the delimiter. The message must not exceed 2047 bytes.

↘ **Configuring a Login Banner**

Command	banner login <i>c message c</i>
Parameter Description	<i>c</i> : Indicates a delimiter, which can be any character, such as "&".
Command Mode	Global configuration mode
Usage Guide	A message must start and end with delimiter+carriage return respectively. Any characters following the ending delimiter will be dropped. Any letter contained in the message must not be used as the delimiter. The message must not exceed 2047 bytes. To remove the login banner configuration, run the no banner login command in global configuration mode.

↘ **Configuring the Console Baud Rate**

Command	speed <i>speed</i>
Parameter Description	<i>speed</i> : Indicates the console baud rate, in the unit of bps. The serial port baud rate can be set to 9,600 bps, 19,200 bps, 38,400 bps, 57,600 bps, or 115,200 bps. The default is 9,600 bps.
Command Mode	Line configuration mode
Usage Guide	You can configure the asynchronous line baud rate based on requirements. The speed command is used to configure receive and transmit rates for the asynchronous line.

Configuration Example

↘ **Configuring the System Time**

Configuration Steps	<ul style="list-style-type: none"> Change the system time to 2003-6-20, 10:10:12.
	<pre>FS# clock set 10:10:12 6 20 2003 //Configure the system time and date.</pre>
Verification	<ul style="list-style-type: none"> Run the show clock command in privileged EXEC mode to display the system time.

Configuration Steps	<ul style="list-style-type: none"> Change the system time to 2003-6-20, 10:10:12.
	<pre>FS# clock set 10:10:12 6 20 2003 //Configure the system time and date.</pre>
Verification	<ul style="list-style-type: none"> Run the show clock command in privileged EXEC mode to display the system time.
	<pre>FS# show clock //Confirm that the changed system time takes effect. clock: 2003-6-20 10:10:54</pre>

➤ **Configuring Daily Notification**

Configuration Steps	<ul style="list-style-type: none"> Configure the daily notification message "Notice: system will shutdown on July 6th." with the pound key (#) as the delimiter.
	<pre>FS(config)# banner motd #//Starting delimiter Enter TEXT message. End with the character '#'. Notice: system will shutdown on July 6th.# //Ending delimiter FS(config)#</pre>
Verification	<ul style="list-style-type: none"> Run the show running-config command to display the configuration. Connect to the local device through the Console, Telnet or SSH, and check whether daily notification is displayed before the CLI appears.
	<pre>C:\>telnet 192.168.65.236 Notice: system will shutdown on July 6th. Access for authorized users only. Please enter your password. User Access Verification Password:</pre>

➤ **Configuring a Login Banner**

Configuration Steps	<ul style="list-style-type: none"> Configure the login banner message "Access for authorized users only. Please enter your password." with the pound key (#) as the delimiter.
	<pre>FS(config)# banner login #//Starting delimiter Enter TEXT message. End with the character '#'. Access for authorized users only. Please enter your password. # //Ending delimiter FS(config)#</pre>
Verification	<ul style="list-style-type: none"> Run the show running-config command to display the configuration. Connect to the local device through the Console, Telnet or SSH, and check whether the login banner is displayed before the CLI appears.

Configuration Steps	<ul style="list-style-type: none"> Configure the login banner message "Access for authorized users only. Please enter your password." with the pound key (#) as the delimiter.
	<pre>FS(config)# banner login #//Starting delimiter Enter TEXT message. End with the character '#'. Access for authorized users only. Please enter your password. # //Ending delimiter FS(config)#</pre>
Verification	<ul style="list-style-type: none"> Run the show running-config command to display the configuration. Connect to the local device through the Console, Telnet or SSH, and check whether the login banner is displayed before the CLI appears.
	<pre>C:\>telnet 192.168.65.236 Notice: system will shutdown on July 6th. Access for authorized users only. Please enter your password. User Access Verification Password:</pre>

⏏ Configuring the Serial Port Baud Rate

Configuration Steps	<ul style="list-style-type: none"> Set the serial port baud rate to 57,600 bps.
	<pre>FS# configure terminal //Enter global configuration mode. FS(config)# line console 0 //Enter console line configuration mode. FS(config-line)# speed 57600 //Set the console baud rate to 57,600 bps. FS(config-line)# end //Returns to privileged mode.</pre>
Verification	<ul style="list-style-type: none"> Run the show command to display the configuration.
	<pre>FS# show line console 0 //Displays the console configuration. CON Type speed Overruns * 0 CON 57600 0 Line 0, Location: "", Type: "vt100" Length: 25 lines, Width: 80 columns Special Chars: Escape Disconnect Activation ^^x none ^M Timeouts: Idle EXEC Idle Session never never</pre>

Configuration Steps	<ul style="list-style-type: none"> ● Set the serial port baud rate to 57,600 bps.
	<pre>FS# configure terminal //Enter global configuration mode. FS(config)# line console 0 //Enter console line configuration mode. FS(config-line)# speed 57600 //Set the console baud rate to 57,600 bps. FS(config-line)# end //Returns to privileged mode.</pre>
Verification	<ul style="list-style-type: none"> ● Run the show command to display the configuration.
	<pre>History is enabled, history size is 10. Total input: 22 bytes Total output: 115 bytes Data overflow: 0 bytes stop rx interrupt: 0 times Modem: READY</pre>

2.4.4 Enabling and Disabling a Specific Service

Configuration Effect

- Dynamically adjust system services when the system is running, and enable and disable specific services (SNMP Agent, SSH Server, and Telnet Server).

Configuration Steps

📌 Enabling the SNMP Agent, SSH Server, and Telnet Server Services

- (Optional) Perform this configuration when you need to use these services.

Verification

- Run the **show running-config** command to display the configuration.
- Run the **show services** command to display the service Enabled/Disable state.

Related Commands

📌 Enabling the SSH Server, Telnet Server, and SNMP Agent Services

Command	enable service { ssh-server telnet-server snmp-agent }
Parameter Description	<p>ssh-server: Enables or disables the SSH Server service. The IPv4 and IPv6 services are also enabled together with this service.</p> <p>telnet-server: Enables or disables the Telnet Server service. The IPv4 and IPv6 services are also enabled together with this service.</p> <p>snmp-agent: Enables or disables the SNMP Agent service. The IPv4 and IPv6 services are also enabled together with this service.</p>

Command	Global configuration mode
Mode	
Usage Guide	Use this command to enable and disable specific services.

Configuration Example

↘ **Enabling the SSH Server Service**

Configuration Steps	<ul style="list-style-type: none"> ● Enable the SSH Server service.
	<pre>FS# configure terminal //Enter global configuration mode. FS(config)#enable service ssh-server //Enable the SSH Server service.</pre>
Verification	<ul style="list-style-type: none"> ● Run the show running-config command to display the configuration. ● Run the show ip ssh command to display the configuration and running state of the SSH Server service.

2.4.5 Configuring a Restart Policy

Configuration Effect

Configure a restart policy to restart a device as scheduled.

Configuration Steps

↘ **Configuring Direct Restart**

Run the **reload** command in privileged EXEC mode to restart the system immediately.

↘ **Configuring Timed Restart**

```
reload at hh:mm:ss month day year [string]
```

If you configure a specific time, the system will restart at the time. The time must be a time in the future. The **month**, **day** and **year** parameters are optional. If they are not specified, the time of the system clock is used by default.

 The clock feature must be supported by the system if you want to use the **at** option. It is recommended that you configure the system clock in advance. A new restart plan will overwrite the existing one. A restart plan will be invalid if the system is restarted before the plan takes effect.

 The restart time must be later than the current system time. After you configure a restart plan, do not change the system clock; otherwise, the plan may fail (for example, the system time is changed to a time after the restart time.)

Related Commands

↘ **Restarting a Device**

Command	reload [at { hh [:mm [:ss]] } [month [day [year]]]]
Parameter	at hh:mm:ss: Indicates the time when the system will restart.
Description	<p><i>month:</i> Indicates a month of the year, ranging from 1 to 12.</p> <p><i>day:</i> Indicates a date, ranging from 1 to 31.</p> <p><i>year:</i> Indicates a year, ranging from 1993 to 2035. Abbreviation is not supported.</p>

Command	Privileged EXEC mode
Mode	
Usage Guide	Use this command to enable a device to restart at a specific time.

2.4.6 Configuring Telnet Service

Configuration Effect

Configure an ACL for the Telnet server.

Notes

N/A

Configuration Steps

▾ Configuring ACL for Telnet Server

- Optional
- Configure an ACL for all Telnet connections

Verification

N/A

Related Commands

▾ Configuring ACL for Telnet Server

Command	{ ip ipv6 } telnet access-class { access-list-number access-list-name }
Parameter Description	<p><i>access-list-number</i>: Configures ACL number, supported by IPv4 only.</p> <ul style="list-style-type: none"> ● Standard ACL: 1-99, 1300-1999 ● Extended ACL: 100-199, 2000-2699 <p><i>access-list-name</i>: Configures ACL name, supported by both IPv4 and IPv6.</p>
Command Mode	Global configuration mode
Usage Guide	Run this command to configure the ACL for the Telnet connections.

Common Errors

N/A

2.5 Monitoring

Displaying

Description	Command
Displays the current system time.	show clock
Displays line configurations.	show line { console <i>line-num</i> vty <i>line-num</i> <i>line-num</i> }
Displays system restart settings.	show reload
Displays the current running configurations of the device or	show running-config [interface <i>interface</i>]

the configurations on an interface.	
Displays the device configurations stored in the NVRAM.	show startup-config
Displays the current system configurations.	show this
Displays system information.	show version [devices module slots]
Displays the information of each established Telnet client instance.	show sessions

3 Configuring R5

3.1 Overview

R5 is a dual-core ARM CPU and will bring different features by running different firmware on its core. e.g., IFA. The commands in this module are all used for maintenance.

3.2 Applications

Application	Description
Outputting R5_CPU Data to Console	Monitors R5_CPU status by console.

3.3 Features

Basic Concepts

↘ r5-cpu core ID

R5-CPU core ID includes 0 and 1, representing a core respectively (Default: 0). The service module should be registered with a core before use. If there is no service module registered, the output of the **show R5-cpu** command shows that no core is in use.

↘ r5-cpu core ID status

R5-CPU core status includes OK, Reload and Crashed.

Overview

Feature	Description
Reload R5-CPU core	Enables or disables the syslog function.

3.3.1 Reloading R5-CPU Core

Reload the specified R5-CPU core.

Related Configuration

↘ Reload R5-CPU Core

By default, R5_CPU core will not be reloaded automatically.

Run the **r5-cpu core coreid reload** command to reload R5_CPU core. The R5_CPU status will be **Reload** when reloading starts and will turn **OK** when reloading finishes.

3.4 Configuration

R5_CPU data can be output to the console for the administrator to monitor R5_CPU status.

- The device must be provisioned with a R5_CPU chip.
- CLI information can be output to the console.

Figure 3- 1 Networking Environment



3.5 Monitoring

Clearing

Description	Command
Displays time range configuration.	clear r5-cpu core <i>coreid</i> statistics
Displays the R5 reboot history.	clear r5-cpu core <i>coreid</i> boot-history
Displays the mmu-buffer usage,	clear r5-cpu core <i>coreid</i> queue-buffer counter

Displaying

Description	Command
Displays the R5 status.	show r5-cpu core <i>coreid</i> status
Displays the R5 statistics.	show r5-cpu core <i>coreid</i> statistics
Displays the R5 reboot history.	show r5-cpu core <i>coreid</i> boot-history
Displays the mmu-buffer usage.	show r5-cpu core <i>coreid</i> queue-buffer

4 Configuring Lines

4.1 Overview

There are various types of terminal lines on network devices. You can manage terminal lines in groups based on their types. Configurations on these terminal lines are called line configurations. On network devices, terminal lines are classified into multiple types such as CTY and VTY.

4.2 Applications

Application	Description
Accessing a Device Through Console	Enter the command-line interface (CLI) of a network device through the Console.
Accessing a Device Through VTY	Enter the CLI of a network device through Telnet or SSH.

4.2.1 Accessing a Device Through Console

Scenario

Figure 4- 1



Remarks	A is a network device to be managed. PC is a network management station.
----------------	---

Deployment

The network management station connects to the Console port of a network device through a serial cable. Using the Console software (Hyper Terminal or other terminal simulation software) on the network management station, you can access the Console of the network device and enter the CLI to configure and manage the network device.

4.2.2 Accessing a Device Through VTY

Scenario

Figure 4- 2



Remarks	A is a network device to be managed. PC is a network management station.
----------------	---

Deployment

The network management station connects to a network device through the network. Using a VTY client (such as Putty) on the network management station, you can access the network device through Telnet or SSH and enter the CLI to configure and manage the network device.

4.3 Features

Basic Concepts

↳ CTY

The CTY line refers to the line connected to the Console port. Most network devices have a Console port. You can access the local system through the Console port.

↳ VTY

The VTY line is a virtual terminal line that does not correspond to any hardware. It is used for Telnet or SSH connection.

Overview

Feature	Description
Basic Features	Configures a terminal, displays and clears terminal connection information.

4.3.1 Basic Features

Related Configuration

➤ **Configuring Terminal Lines**

Run the **line** command in global configuration mode to enter the configuration mode of a specified line.

Configure the line attributes.

➤ **Clearing Terminal Connections**

When a terminal connects to the network device, the corresponding terminal line is occupied. Run the **show user** command to display the connection status of these terminal lines. If you want to disconnect the terminal from the network device, run the **clear line** command to clear the terminal line. After the terminal lines are cleared, the related connections (such as Telnet and SSH) are interrupted, the CLI exits, and the terminal lines restore to the unoccupied status. Users can re-establish connections.

➤ **Specifying the Number of VTY Terminals**

Run the **line vty** command to enter the VTY line configuration mode and specify the number of VTY terminals.

By default, there are 5 VTY terminals, numbered from 0 to 4. You can increase the number of VTY terminals to 36, with new ones numbered from 5 to 35. Only new terminals can be removed.

4.4 Configuration

Configuration	Description and Command
	 (Mandatory) It is used to enter the line configuration mode.
line [console vty] first-line [last-line]	Enters the specified line configuration mode.
line vty line-number	Increases or reduces the number of available VTY lines.

4.4.1 Entering Line Configuration Mode

Configuration Effect

Enter line configuration mode to configure other functions.

Configuration Steps

➤ **Entering Line Configuration Mode**

- Mandatory.
- Unless otherwise specified, enter line configuration mode on each device to configure line attributes.

➤ **Increasing/Reducing the Number of VTY Lines**

- Optional.
- Run the **(no) line vty** *line-number* command to increase or reduce the number of VTY lines.

Verification

Run the **show line** command to display line configuration.

Related Commands

➤ **Entering Line Configuration Mode**

Command	line [aux console tty vty] <i>first-line</i> [<i>last-line</i>]
Parameter Description	<p>console: Indicates the Console port.</p> <p>vty: Indicates a virtual terminal line, which supports Telnet or SSH.</p> <p><i>first-line:</i> Indicates the number of the first line.</p> <p><i>last-line:</i> Indicates the number of the last line.</p>
Command Mode	Global configuration mode
Usage Guide	N/A

➤ **Increasing/Reducing the Number of VTY Lines**

Command	line vty <i>line-number</i>
Parameter Description	<i>line-number:</i> Indicates the number of VTY lines. The value ranges from 0 to 35.
Command Mode	Global configuration mode
Usage Guide	Run the no line vty <i>line-number</i> command to reduce the number of available VTY lines.

➤ **Displaying Line Configuration**

Command	show line { console <i>line-num</i> vty <i>line-num</i> <i>line-num</i> }
Parameter Description	<p>console: Indicates the Console port.</p> <p>vty: Indicates a virtual terminal line, which supports Telnet or SSH.</p> <p><i>line-num:</i> Indicates the line to be displayed.</p>
Command Mode	Privileged EXEC mode
Usage Guide	N/A

Configuration Example

<p>Scenario Figure 4-3</p>	
<p>Configuration Steps</p>	<ul style="list-style-type: none"> ● Connect the PC to network device A through the Console line and enter the CLI on the PC. ● Run the show user command to display the connection status of the terminal line. ● Run the show line console 0 command to display the status of the Console line. ● Enter global configuration mode and run the line vty command to increase the number of VTY terminals to 36.
<p>A</p>	<pre> FS#show user Line User Host(s) Idle Location ----- * 0 con 0 --- idle 00:00:00 --- FS#show line console 0 CON Type speed Overruns *0 CON 9600 0 Line 0, Location: "", Type: "vt100" Length: 24 lines, Width: 79 columns Special Chars: Escape Disconnect Activation ^^x ^D ^M Timeouts: Idle EXEC Idle Session 00:10:00 never History is enabled, history size is 10. Total input: 490 bytes Total output: 59366 bytes Data overflow: 0 bytes stop rx interrupt: 0 times FS#show line vty ? <0-5> Line number FS#configure terminal </pre>

	<p>Enter configuration commands, one per line. End with CNTL/Z.</p> <pre> FS(config)#line vty 35 FS(config-line)# *Oct 31 18:56:43: %SYS-5-CONFIG_I: Configured from console by console </pre>
<p>Verification</p>	<ul style="list-style-type: none"> ● After running the show line command, you can find that the number of terminals increases. ● Run the show running-config command to display the configuration.
<p>A</p>	<pre> FS#show line vty ? <0-35> Line number FS#show running-config Building configuration... Current configuration : 761 bytes version 11.0(1C2B1)(10/16/13 04:23:54 CST -ngcf78) ip tcp not-send-rst vlan 1 ! interface GigabitEthernet 0/0 ! interface GigabitEthernet 0/1 ip address 192.168.23.164 255.255.255.0 ! interface GigabitEthernet 0/2 ! interface GigabitEthernet 0/3 ! interface GigabitEthernet 0/4 ! interface GigabitEthernet 0/5 ! interface GigabitEthernet 0/6 </pre>

```

!
interface GigabitEthernet 0/7
!
interface Mgmt 0
!
line con 0
line vty 0 35
  login
!
end
    
```

4.5 Monitoring

Clearing



Running the **clear** commands may lose vital information and thus interrupt services.

Description	Command
Clears the line connection status.	clear line { console <i>line-num</i> vty <i>line-num</i> <i>line-num</i> }

Displaying

Description	Command
Displays the line configuration.	show line { console <i>line-num</i> vty <i>line-num</i> <i>line-num</i> }
Displays historical records of a line.	show history
Displays the privilege level of a line.	show privilege
Displays users on a line.	show user [all]

5 Configuring Time Range

5.1 Overview

Time Range is a time-based control service that provides some applications with time control. For example, you can configure a time range and associate it with an access control list (ACL) so that the ACL takes effect within certain time periods of a week.

5.2 Typical Application

Typical Application	Scenario
Applying Time Range to an ACL	Apply a time range to an ACL module so that the time-based ACL takes effect

5.2.1 Applying Time Range to an ACL

Application Scenario

An organization allows users to access the Telnet service on a remote Unix host during working hours only, as shown in Figure 5- 1.

Figure 5- 1

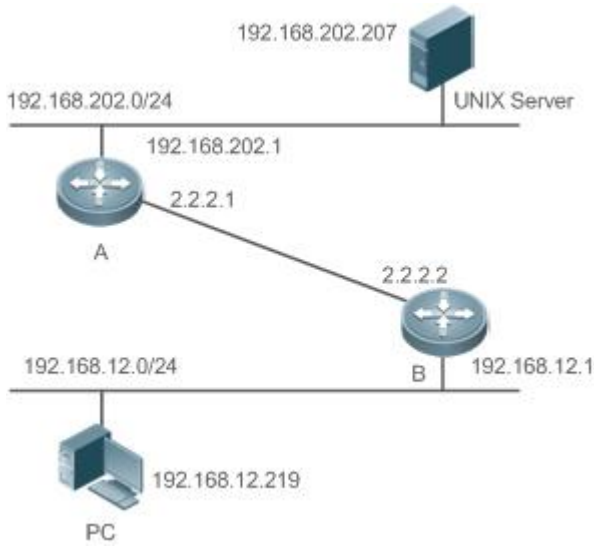

Note	<p>Configure an ACL on device B to implement the following security function:</p> <p>Hosts in network segment 192.168.12.0/24 can access the Telnet service on a remote Unix host during normal working hours only.</p>
------	---

Functional Deployment

- On device B, apply an ACL to control Telnet service access of users in network segment 192.168.12.0/24. Associate the ACL with a time range, so that the users' access to the Unix host is allowed only during working hours.

5.3Function Details

Basic Concepts

➤ **Absolute Time Range**

The absolute time range is a time period between a start time and an end time. For example, [12:00 January 1 2000, 12:00 January 1 2001] is a typical absolute time range. When an application based on a time range is associated with the time range, a certain function can be effective within this time range.

➤ **Periodic Time**

Periodic time refers to a periodical interval in the time range. For example, “from 8:00 every Monday to 17:00 every Friday” is a typical periodic time interval. When a time-based application is associated with the time range, a certain function can be effective periodically from every Monday to Friday.

Features

Feature	Function
Using Absolute Time	Sets an absolute time range for a time-based application, so that a certain function takes effect within the

Range	absolute time range.
Using Periodic Time	Sets periodic time or a time-based application, so that a certain function takes effect within the periodic time.

5.3.1 Using Absolute Time Range

Working Principle

When a time-based application enables a certain function, it determines whether current time is within the absolute time range. If yes, the function is effective or ineffective at the current time depending on specific configuration.

Related Configuration

⤵ Configuring Time Range

No time range is configured by default.

Use the **time-range** *time-range-name* command to configure a time range.

⤵ Configuring Absolute Time Range

The absolute time range is [00:00 January 1, 0, 23:59 December 31, 9999] by default.

Use the **absolute** { [start time date] | [end time date] } command to configure the absolute time range.

5.3.2 Using Periodic Time

Working Principle

When a time-based application enables a certain function, it determines whether current time is within the period time. If yes, the function is effective or ineffective at the current time depending on specific configuration.

Related Configuration

⤵ Configuring Time Range

No time range is configured by default.



Use the **time-range** *time-range-name* command to configure a time range.

⤵ Configure Periodic Time

No periodic time is configured by default.

Use the **periodic** *day-of-the-week time to* [day-of-the-week] *time* command to configure periodic time.

5.4 Configuration Details

Configuration Item	Suggestions and Related Commands	
Configuring Time Range	 Mandatory configuration. Time range configuration is required so as to use the time range function.	
	time-range <i>time-range-name</i>	Configures a time range.
	 Optional configuration. You can configure various parameters as necessary.	
	absolute { [start time date] [end time date] }	Configures an absolute time range.

	periodic <i>day-of-the-week</i> <i>time</i> to <i>[day-of-the-week] time</i>	Configures periodic time.
--	---	---------------------------

5.4.1 Configuring Time Range

Configuration Effect

- Configure a time range, which may be an absolute time range or a periodic time interval, so that a time-range-based application can enable a certain function within the time range.

Configuration Method

↘ Configuring Time Range

- Mandatory configuration.
- Perform the configuration on a device to which a time range applies.

↘ Configuring Absolute Time Range

- Optional configuration.

↘ Configuring Periodic Time

- Optional configuration.

Verification

- Use the **show time-range** *[time-range-name]* command to check time range configuration information.

Related Commands

↘ Configuring Time Range

Command	time-range <i>time-range-name</i>
Parameter Description	<i>time-range-name</i> : name of the time range to be created.
Command Mode	Global configuration mode
Usage Guide	Some applications (such as ACL) may run based on time. For example, an ACL can be effective within certain time ranges of a week. To this end, first you must configure a time range, then you can configure relevant time control in time range configuration mode.

↘ Configuring Absolute Time Range

Command	absolute { [start <i>time date</i>] [end <i>time date</i>] }
Parameter Description	start <i>time date</i> : start time of the range. end <i>time date</i> : end time of the range.
Command Mode	Time range configuration mode
Usage Guide	Use the absolute command to configure a time absolute time range between a start time and an end time to allow a certain function to take effect within the absolute time range.

↘ **Configuring Periodic Time**

Command	periodic <i>day-of-the-week time to [day-of-the-week] time</i>
Parameter	<i>day-of-the-week</i> : the week day when the periodic time starts or ends
Description	<i>time</i> : the exact time when the periodic time starts or ends
Command Mode	Time range configuration mode
Usage Guide	Use the periodic command to configure a periodic time interval to allow a certain function to take effect within the periodic time. If you want to modify the periodic time, it is recommended to disassociate the time range first and associate the time range after the periodic time is modified.

5.5 Monitoring

Displaying the Running Status

Description	Command
Displays time range configuration.	show time-range [<i>time-range-name</i>]

6 Configuring USB

6.1 Overview

Universal serial bus (USB) is an external bus standard. In this document, USB refers to a USB-compliant peripheral device, for example, a USB flash drive.

USB is a hot swappable device. You can use it to copy files (such as configuration and log files) from a communication device, or copy external data (such as system upgrade files) to the flash of the communication device.

Specific application scenarios of the USB are detailed in configuration guides of related functions. This document describes only how to identify, use, and remove the USB and view information about the USB.

6.2 Applications

Application	Description
Using a USB Flash Drive to Upgrade a Device	Upgrade files are stored on a USB flash drive. After a device is powered on, the device detects the USB flash drive and runs the upgrade command to load the upgrade files. After loading is completed, the device is reset and runs the upgraded version.

6.2.1 Using a USB Flash Drive to Upgrade a Device

Scenario

Upgrade files are stored on a USB flash drive. After a device is powered on, the device detects the USB flash drive and runs the upgrade command to load the upgrade files. After loading is completed, the device is reset and runs the upgraded version. An example of the upgrade command is as follows:

```
upgrade usb0:/s12k-ppc_11.0(1B2)_20131025_main_install.bin
```

If the file is valid and execution of this command succeeds, the device will be automatically reset and run the upgraded version.

Deployment

- Use the prefix "usb0:/" to access USB 0. Run the **show usb** command to display information about the USB with the ID 0.
- Run the **upgrade** command to perform upgrade.

6.3 Features

Using the USB

Insert a USB into the USB slot. The system automatically searches for the USB. After the USB is located, the driver module automatically initializes the driver of the USB. After initialization, the system automatically loads the file system on the USB. Later, the system can read or write this USB.

- If the system finds a USB and successfully loads the driver, the following information will be displayed:

```
*Jan 1 00:09:42: %USB-5-USB_DISK_FOUND: USB Disk <Mass Storage> has been inserted to USB port 0!
*Jan 1 00:09:42: %USB-5-USB_DISK_PARTITION_MOUNT: Mount usb0(type:FAT32),size : 1050673152B(1002MB)
```

 "Mass Storage" indicates the name of the searched device, and "usb0:" indicates the first USB. "Size" indicates the size of the partition. For example, according to the preceding information displayed, the USB flash drive has a space of 1002 MB.

 "Size" indicates the size of the partition.

Removing the USB



Use a command line interface (CLI) command to remove the USB first; otherwise, an error may occur if the system is currently using the USB.

- If the USB is successfully removed, the following information will be displayed:

```
OK, now you can pull out the device 0.
```

You can remove the USB only after the preceding information is displayed.

6.4 Configuration

Configuration	Description and Command
Using a USB	 Mandatory.
	N/A
Removing a USB	 (Mandatory) It is used to remove a USB.
	usb remove Removes a USB.

6.4.1 Using a USB

Configuration Effect

After a USB is loaded, you can run the file system commands (such as **dir**, **copy**, and **del**) to perform operations on the USB.

Notes

- The FS General Operating System (FSOS) is applicable only to devices (generally common USB flash drives) that support standard Small Computer System Interface (SCSI) commands. Other devices, such as the USB flash drive embedded in the USB network interface card (NIC) and USB flash drive with the virtual CD-ROM drive, cannot be used in the FSOS. Some devices are configured with the function of converting a USB port to the serial port.
- The USB supports only the FAT file system. Other file systems on the USB must be formatted to the FAT file system on a PC before the USB can be used on a device.
- The FSOS supports the hub. When a USB flash drive is inserted to a port on a hub, the access path becomes different. If the USB flash drive is inserted to a USB port on a device, the access path is **usbX:/**, where **X** indicates the device ID. You can run the **show usb** command to display this path. If the USB flash drive is inserted to a USB port through a hub, the access path is **usbX-Y:/**, where **X** indicates the device ID, and **Y** indicates the hub port ID. For example, **usb0-3:/** indicates port 3 on the hub that is connected to USB port 0 on the device.

Configuration Steps

📌 **Identifying a USB**

A USB can be directly inserted to the USB slot without a CLI operation.

📌 **Using a USB**

Perform the following operations to copy files from a USB to the flash:

- Run the **cd** command to enter the partition of the USB.
- Run the **copy** command to copy files on the USB to the flash on the device.
- Run the **dir** command to check whether the files are copied to the device.
- 📘 If the USB has multiple partitions, you can access only the first FAT partition on the device.
- 📘 The path of the USB does not contain any upper-level directory. After running the **cd usbX:** command to access a USB, you can run the **cd flash:** command to return to the flash file system.

Verification

Run the **show usb** command to display information about the USB inserted to the device.

Configuration Example

📌 **Using a USB Flash Drive**

Scenario	Standalone environment
Configuration Steps	<ul style="list-style-type: none"> ● Insert the USB flash drive into the USB slot of the device. ● Run the show usb command on the device console. ● Copy the config.txt file from the USB flash drive to the flash on the device.
	<pre>FS#show usb Device: Mass Storage ID: 0 URL prefix: usb0</pre>

```

Disk Partitions:

usb0(type:vfat)

Size:15789711360B(15789.7MB)

Available size:15789686784B(15789.6MB)

FS#
FS#
FS#dir usb0:/

Directory of usb0:/

  1 -rwx          4  Tue Jan   1 00:00:00 1980  fac_test
  2 -rwx          1  Mon Sep 30 13:15:48 2013  config.txt

2 files, 0 directories

15,789,711,360 bytes total (15,789,686,784 bytes free)

FS#
FS#
FS#copy usb0:/config.txt flash:/

Copying: !

Accessing usb0:/config.txt finished, 1 bytes prepared

Flushing data to flash:/config.txt...

Flush data done

FS#
FS#
    
```

Verification ● Check whether the **config.txt** file exists on the flash.

```

FS#
FS#dir flash:/

Directory of flash:/

  1 drw-          160  Wed Mar 31 08:40:01 2010  at
  2 drwx          160  Thu Jan   1 00:00:11 1970  dm
  3 drwx          160  Thu Jan   1 00:00:05 1970  rep
  4 drwx          160  Mon Apr 26 03:42:00 2010  scc
  5 drwx          160  Wed Mar 31 08:39:52 2010  ssh
  6 drwx          224  Thu Jan   1 00:00:06 1970  var
  7 d---          288  Sat May 29 06:07:45 2010  web
  8 drwx          160  Thu Jan   1 00:00:11 1970  addr
    
```

```

 9 drwx          160  Sat May 29 06:07:44 2010  cwmpr
10 drwx          784  Sat May 29 06:07:47 2010  sync
11 --w-          92   Tue Feb   2 01:06:55 2010  config_vsudat
12 -rw-         244  Sat Apr   3 04:56:52 2010  configtext
13 -rwx           1   Thu Jan   1 00:00:30 1970  .issu_state
14 -rw-           0   Tue Feb   2 01:07:03 2010  ss_ds_debugtxt
15 -rw-        8448  Thu Jan   1 00:01:41 1970  .shadow
16 -rwx          268  Thu Jan   1 00:01:41 1970  .pswdinfo
17 -rw-           4   Tue May 25 09:12:01 2010  reload
18 drwx          232  Wed Mar 31 08:40:00 2010  snpv4
19 drwx        6104  Sat May 29 06:10:45 2010  .config
20 ----           1   Thu Jan   1 00:04:51 1970  configtxt
21 d---         160  Thu Jan   1 00:00:12 1970  syslog
22 drwx          160  Tue May 25 03:05:01 2010  upgrade_ram
23 drwx          160  Tue Feb   2 01:06:54 2010  dm_vdu
24 -rwx          16  Thu Jan   1 00:01:41 1970  .username.data

9 files, 15 directories

5,095,424 bytes total (4,960,256 bytes free)

FS#
    
```

Common Errors

- Insert a USB flash drive that supports non-SCSI commands to the device.
- The USB does not use the FAT file system, and cannot be identified by the system.

6.4.2 Removing a USB

Configuration Effect

Remove the USB and ensure that the USB and the device are intact.

Notes

- Run the **usb remove** command before removing the USB; otherwise, a system error occurs.

Configuration Steps

➤ **Running the Remove Command**

- Mandatory.
- Run the **usb remove** command before removing the USB.

➤ **Removing the USB**

After the remove command is executed, remove the USB.

Verification

Run the **show usb** command to display information about the USB inserted to the device.

Related Commands

↘ **Removing a USB**

Command	usb remove <i>device-id</i>
Parameter Description	<i>device-id</i> : Indicates the ID of the USB port on the device. You can run the show usb command to display this ID.
Command Mode	Privileged EXEC mode
Usage Guide	Before removing a USB, run the usb remove command; otherwise, an error occurs if the USB is in use. If the command is executed, related information will be displayed, and you can remove the USB. If the command execution fails, the USB is in use. In this case, do not remove the USB until it is not in use.

Configuration Example

↘ **Removing a USB**

Scenario	Standalone environment
Configuration Steps	<ul style="list-style-type: none"> ● Run the show usb command to display the ID of the USB. ● Run the usb remove command to remove the USB.
	<pre> FS#show usb Device: Mass Storage ID: 0 URL prefix: usb0 Disk Partitions: usb0(type:vfat) Size:15789711360B(15789.7MB) Available size:15789686784B(15789.6MB) FS# FS# FS#usb remove 0 OK, now you can pull out the device 0. </pre>
Verification	<ul style="list-style-type: none"> ● Run the show usb command again to check whether the USB is removed. If the device with ID 0 is not displayed in output of the show usb command, the USB is removed.
	<pre> FS#show usb </pre>

	FS#
--	-----

6.5 Monitoring

Displaying

Description	Command
Displays information about the inserted USB.	show usb

7 Configuring HTTP Service

7.1 Overview

Hypertext Transfer Protocol (HTTP) is used to transmit Web page information on the Internet. It is at the application layer of the TCP/IP protocol stack. The transport layer adopts connection-oriented Transmission Control Protocol (TCP).

Hypertext Transfer Protocol Secure (HTTPS) is an HTTP supporting the Secure Sockets Layer (SSL) protocol. HTTPS is mainly used to create a secure channel on an insecure network, ensure that information can hardly be intercepted, and provide certain reasonable protection against main-in-the-middle attacks. At present, HTTPS is widely used for secure and sensitive communication on the Internet, for example, electronic transactions.

Protocols and Standards

- RFC1945: Hypertext Transfer Protocol -- HTTP/1.0
- RFC2616: Hypertext Transfer Protocol -- HTTP/1.1
- RFC2818: Hypertext Transfer Protocol Over TLS -- HTTPS

7.2 Applications

Application	Description
HTTP Application Service	Users manage devices based on Web.

7.2.1 HTTP Application Service

Scenario

After the HTTP service is enabled, users can access the Web management page after passing authentication by only entering **http://IP address of a device** in the browser of a PC. On the Web page, users you can monitor the device status, configure devices, upload and download files.

Take the following figure as an example to describe Web management.

- Users can remotely access devices on the Internet or configure and manage devices on the Local Area Network (LAN) by logging in to the Web server.
- According to actual conditions, users can choose to enable the HTTPS or HTTP service or enable the HTTPS and HTTP services at the same time.

- Users can also access the HTTP service of devices by setting and using HTTP/1.0 or HTTP/1.1 in the browser.

Figure 7- 1

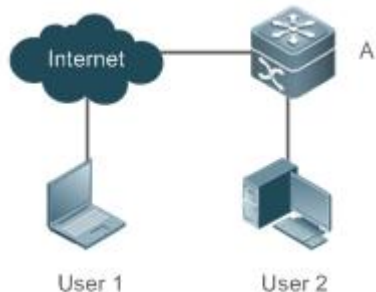

Remarks	A is a FS device. User 1 accesses the device through the Internet. User 2 accesses the device through a LAN.
----------------	--

Deployment

- When a device runs HTTP, users can access the device by entering **http://IP address of the device** in the browser of a PC.
- When a device runs HTTPS, users can access the device by entering **https://IP address of the device** in the browser of a PC.

7.3 Features

Basic Concepts

📌 **HTTP Service**

The HTTP service refers to transmission of Web page information on the Internet by using HTTP. HTTP/1.0 is currently an HTTP version that is the most widely used. As one Web server may receive thousands or even millions of access requests, HTTP/1.0 adopts the short connection mode to facilitate connection management. One TCP connection is established for each request. After a request is completed, the TCP connection is released. The server does not need to record or trace previous requests. Although HTTP/1.0 simplifies connection management, HTTP/1.0 introduces performance defects.

For example, a web page may need lots of pictures. However, the web page contains not real picture contents but URL connection addresses of the pictures. In this case, the browser sends multiple requests during access. Each request requires establishing an independent connection and each connection is completely isolated. Establishing and releasing connections is a relatively troublesome process, which severely affects the performance of the client and server, as shown in the following figure:

Figure 7- 2

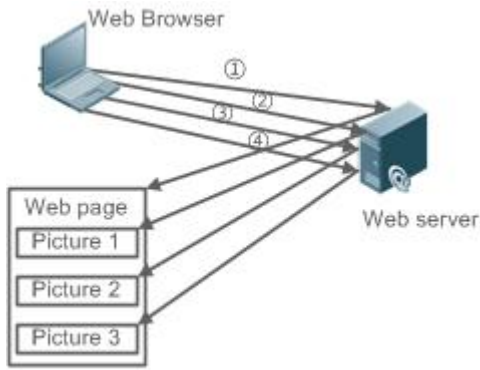

HTTP/1.1 overcomes the defect. It supports persistent connection, that is, one connection can be used to transmit multiple requests and response messages. In this way, a client can send a second request without waiting for completion of the previous request. This reduces network delay and improves performance. See the following figure:

Figure 7-3

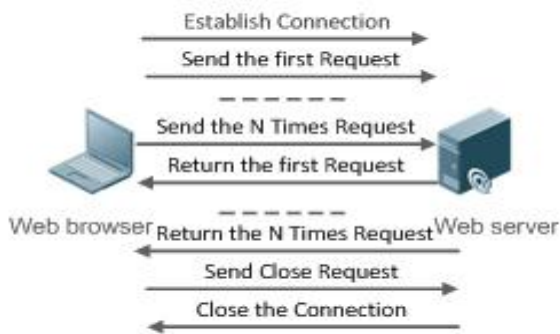

At present, FS devices support both HTTP/1.0 and HTTP/1.1.

i Which HTTP version will be used by a device is decided by the Web browser.

↘ HTTPS Service

The HTTPS service adds the SSL based on the HTTP service. Its security basis is the SSL. To run HTTPS properly, a server must have a Public Key Infrastructure (PKI) certificate while a client may not necessarily need one. The SSL protocol provides the following services:

- Authenticating users and servers and ensuring that data is sent to the correct client and server.
- Encrypting data to prevent data from being stolen midway.
- Maintaining data integrity and ensuring that data is not changed during transmission.

Figure 7-4

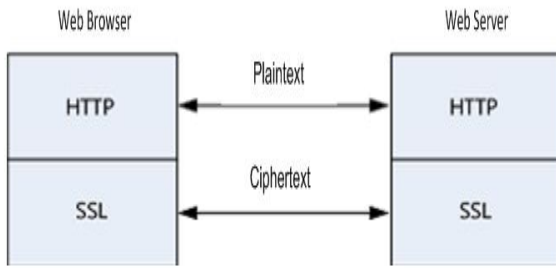

➤ **HTTP Upgrade Service**

HTTP upgrade includes local HTTP upgrade and remote HTTP upgrade.

- During a local upgrade, a device serves as an HTTP server. Users can log in to the device through a Web browser and upload upgrade files to the device to realize file upgrade on the device.
- During a remote upgrade, a device is connected to a remote HTTP server as a client and realizes local file upgrade by obtaining files from the server.

Features

Feature	Description
HTTP Service	Users log in to devices through Web pages to configure and manage devices.
Remote HTTP Upgrade Service	A device is connected to a remote HTTP server as a client and realizes local file upgrade by obtaining files from the server.
Local HTTP Upgrade Service	Upgrade files are uploaded to a device to realize file upgrade on the device.

7.3.1 HTTP Service

HTTP is a service provided for Web management. Users log in to devices through Web pages to configure and manage devices.

Working Principle

Web management covers Web clients and Web servers. Similarly, the HTTP service also adopts the client/server mode. The HTTP client is embedded in the Web browser of the Web management client. It can send HTTP packets and receive HTTP response packets. The Web server (namely HTTP server) is embedded in devices. The information exchange between the client and the server is as follows:

- A TCP connection is established between the client and the server. The default port ID of the HTTP service is 80 and the default port ID of the HTTPS service is 443.
- The client sends a request message to the server.
- The server resolves the request message sent by the client. The request content includes obtaining a Web page, executing a CLI command, and uploading a file.
- After executing the request content, the server sends a response message to the client.

7.3.2 HTTPS Certificate

An HTTPS certificate is used for authentication and encryption. The user can generate a new self-signed certificate or install a trusted certificate issued by the certificate authority. If the HTTPS certificate is not trusted by the browser, the browser will display a security prompt, asking for user’s approval before accessing Web.

Working Principle

- The device will generate a self-signed certificate as the HTTPS certificate upon first startup. The user can generate a new certificate or install a trusted certificate issued by the certificate authority.
- The server will deliver a certificate to the browser after the browser connects to the server via HTTPS.
- The browser checks the certificate delivered by the server. If the HTTPS certificate is not trusted by the browser, the browser will display a security prompt, asking for user’s approval before accessing the server.



7.3.3 Local HTTP Upgrade Service

When a device serves as the HTTP server, users can log in to the device through a Web browser and upload upgrade files (including component package and Web package) to the device or directly upload files to the device through Trivial File Transfer Protocol (TFTP).

Working Principle

- A component package or Web package is uploaded through the local upgrade function provided by Web.
- After successfully receiving a file, the device checks the version for its validity.
- After the file check is successful, if the file is a Web package, perform the upgrade directly; if the file is a component package, decide whether to perform the upgrade in the browser by restarting the device.

7.4 Configuration

Configuration	Description and Command
Configuring the HTTP Service	 (Mandatory) It is used to enable the HTTP service.
	enable service web-server Enables the HTTP service.
	webmaster level Configures HTTP authentication information.
	http port Configures an HTTP service port.
	http secure-port Configures an HTTPS service port.
Configuring HTTP redirection to HTTPS	 (Optional) It is used to configure HTTP redirection to HTTPS.
	web-server http redirect-to-https Configures HTTP redirection to HTTPS.
Configuring HTTPS Certificate	 (Optional) It is used to configure HTTPS certificate.
	web-server https generate self-signed-certificate Re-generates HTTP self-signed certificate.
	web-server https certificate Installs HTTPS certificate.

Configuration	Description and Command	
Configuring a Local HTTP Upgrade	 (Mandatory) It is used to realize a local HTTP upgrade.	
	upgrade web	Upgrades a Web package stored on a device.
	upgrade web download	Automatically downloads a Web package from a server and automatically upgrades the package.

7.4.1 Configuring HTTP Service

Configuration Effect

After the HTTP service is enabled on a device, users can log in to the Web management page after passing authentication and monitor the device status, configure devices, upload and download files.

Configuration Steps

➤ Enabling the HTTP Service

- Mandatory
- If there is no special requirement, enable the HTTP service on FS devices. Otherwise, the Web service is inaccessible.

➤ Configuring HTTP Authentication Information

- By default, the user name **admin** and the password **admin** are configured.
- If there is no special requirement, you can log in to the Web page by using the default user name and directly update authentication information through the Web browser. If you always use the default account, security risks may exist because unauthorized personnel can obtain device configuration information once the IP address is disclosed.

➤ Configuring an HTTP Service Port

- If an HTTP service port needs to be changed, the HTTP service port must be configured.
- If there is no special requirement, the default HTTP service port 80 can be used for access.

➤ Configuring an HTTPS Service Port

- If an HTTPS service port needs to be changed, the HTTPS service port must be configured.
- If there is no special requirement, the default HTTPS service port 443 can be used for access.

Verification

- Enter **http://IP address of the device: service port** to check whether the browser skips to the authentication page.
- Enter **https://IP address of the device: service port** to check whether the browser skips to the authentication page.

Related Commands

➤ Enabling the HTTP Service

Command	enable service web-server [http https all]
Parameter	http https all: Enables the corresponding service. http indicates enabling the HTTP service, https indicates enabling the HTTPS service, and all indicates enabling the HTTP and HTTPS services at the same time. By default, the HTTP and HTTPS services are enabled at the same time.
Description	

Command Mode	Global configuration mode.
Usage Guide	<p>If no key word or all is put at the end of the command when the command is run, the HTTP and HTTPS services are enabled at the same time. If the key word http is put at the end of the command, only the HTTP service is enabled; if the key word https is put at the end of the command, only the HTTPS service is enabled.</p> <p>The no enable service web-server or default enable service web-server command is used to disable the corresponding HTTP service. If no key word is put at the end of the no enable service web-server or default enable service web-server command, the HTTP and HTTPS services are disabled.</p>

↘ **Configuring HTTP Authentication Information.**

Command	webmaster level privilege-level username name password { password [0 7] encrypted-password }
Parameter Description	<p><i>privilege-level</i>: Permission level bound to a user.</p> <p><i>name</i>: User name.</p> <p><i>password</i>: User password.</p> <p>0 7: Password encryption type. 0: no encryption; 7: simple encryption. The default value is 0.</p> <p><i>encrypted-password</i>: Password text.</p>
Command Mode	Global configuration mode.
Usage Guide	<p>When the HTTP server is used, you need to be authenticated before logging in to the Web page. The webmaster level command is used to configure a user name and a password for logging in to the Web page.</p> <p>Run the no webmaster level privilege-level command to delete all user names and passwords of the specified permission level.</p> <p>Run the no webmaster level privilege-level username name command to delete the specified user name and password.</p> <ul style="list-style-type: none"> User names and passwords involve three permission levels: Up to 10 user names and passwords can be configured for each permission level. By default, the system creates the admin account. The account cannot be deleted and only the password of the account can be changed. The administrator account is the admin account, which corresponds to the level 0 permission. The administrator account owns all permissions on the Web client and can edit other management accounts and authorize the accounts to access pages. The new accounts that are added correspond to the level 1 permission.

↘ **Configuring an HTTP Service Port**

Command	http port port-number
Parameter Description	<i>port-number</i> : Configures an HTTP service port. The value range is 80 and 1025 to 65535.
Command Mode	Global configuration mode.
Usage Guide	Run the command to set an HTTP service port.

↘ **Configuring an HTTPS Service Port**

Command	http secure-port port-number
Parameter Description	<i>port-number</i> : Configures an HTTPS service port. The value range is 443 and 1025 to 65535.

Command	Global configuration mode.
Mode	
Usage Guide	Run the command to set an HTTPS service port.

Configuration Example

📌 **Managing one FS Device by Using Web and Logging in to the Device through a Web Browser to Configure Related Functions**

- Log in to the device by using the **admin** account configured by default.
- To improve security, the Web browser is required to support both HTTP and HTTPS for access.
- The user is required to configure an HTTP service port to reduce the number of attacks initiated by illegal users on HTTP.

Scenario Figure 7-5	
Configuration Steps	<ul style="list-style-type: none"> ● Enable the HTTP and HTTPS services at the same time. ● Set the HTTP service port ID to 8080 and the HTTPS service port ID to 4430.
A	<pre>A#configure terminal A(config)# enable service web-server A(config)# http port 8080 A(config)# http secure-port 4430</pre>
Verification	Check HTTP configurations.
A	<pre>A# show web-server status http server status: enabled http server port: 8080 https server status:enabled https server port: 4430</pre>

Common Errors

- If the HTTP service port is not the default port 80 or 443, you must enter a specific configured service port in the browser. Otherwise, you cannot access devices on the Web client.

7.4.2Configuring HTTPS Certificate

Configuration Effect

Configure HTTPS certificate to re-generate the self-signed certificate or the certificate assigned by Certificate Authority.

Configuration Steps

📌 **Re-generating HTTPS Self-signed Certificate**

- HTTPS self-signed certificate is used by default.
- Run the **web-server https generate self-signed-certificate** command to re-generate the HTTPS certificate.

Command **web-server https generate self-signed-certificate**

Parameter N/A

Description

Command Mode Global configuration mode

Usage Guide This command is an interactive command. After running this command, please enter the information required or press Ctrl+C to abort the task.

If the HTTPS certificate is installed, the HTTPS certificate will be used preferentially. The re-generated self-signed certificate will not replace the HTTPS certificate.

 This command is not displayed in running-config.

 It is recommended to open the Web management page again after closing the browser.

🔽 Installing HTTPS Certificate

- HTTPS self-signed certificate is used by default.
- Run the **web-server https certificate** command to install the HTTPS certificate.
- Installing the HTTPS certificate assigned by the Certificate Authority will prevent distrust prompt popping up during HTTPS access.

Command **web-server https certificate** { **pem** *cert-filename* **private-key** *key-filename* } | { **pfx** *cert-filename* } [**password** *password-text*]

Parameter **pem**: Imports the certificate and private key file in pem format.

Description **pfx**: Imports the certificate file in pfx format.

cert-filename: Specifies the name of the certificate file under the flash: directory.

key-filename: Specifies the name of the private key file under the flash: directory.

password *password-text*: Configures the decryption password.

Command Mode Global configuration mode

Usage Guide Run the **copy** command to copy the certificate/private key file to the **flash:** partition. After installation finishes, the certificate/private key file can be deleted.

You can run the **no web-server https certificate** command to delete the HTTPS certificate. Afterwards, the auto-signed HTTPS certificate will be used.

 This command is not displayed in running-config.

 It is recommended to open the Web management page again after closing the browser.

Verification

- Run the **show web-server https certificate information** command to display HTTPS certificate.

Configuration Example

↘ Re-generating HTTPS Self-signed Certificate

Scenario

Figure 7-7



- Configuration**
- Re-generate the self-signed certificate.

Steps

```
A
A#configure terminal
A(config)# web-server https generate self-signed-certificate
RSA key modulus bits (1024~4096) [2048]:
Common Name (e.g. server IP) [Self-Signed-600B16C2]:
% Generate self-signed certificate successfully
```

- Verification**
- Run the **show web-server https certificate information** command to display certificate.

```
A
A#show web-server https certificate information
Source: Default
Certificate:
  Data:
    Version: 3 (0x2)
    Serial Number: 1 (0x1)
  Signature Algorithm: sha256WithRSAEncryption
  Issuer: CN=Self-Signed-600B16C2
  Validity
    Not Before: Feb 28 05:49:39 2019 GMT
    Not After : Feb 25 05:49:39 2029 GMT
  Subject: CN=Self-Signed-600B16C2
  Subject Public Key Info:
    Public Key Algorithm: rsaEncryption
    Public-Key: (2048 bit)
```

```

Modulus:
.....
A#
    
```

➤ Installing Third-party HTTPS Certificate

- The certificate file name is usercert.pfx and the key is 123456. Enable the TFTP server and place the certificate file under the TFTP server directory.

Scenario

Figure 7-8



Configuration

Steps

- Run the **copy** command to copy the certificate/private key file to the **flash:** partition.
- Run the **web-server https certificate** command to install HTTPS certificate.

```

A
A# copy tftp://192.168.1.1/usercert.pfx flash:usercert.pfx

Press Ctrl+C to quit
!
Copy success.

A#configure terminal
A(config)# web-server https certificate pfx usercert.pfx password 123456
*Feb 28 14:38:37: %HTTPD-4-CERT_CHANGE: HTTPS certificate changed.
% The certificate was successfully installed.
    
```

Verification

- Run the **show web-server https certificate information** command to display certificate.

```

A
A#show web-server https certificate information

Source: Installed

Certificate:

  Data:
    Version: 3 (0x2)
    Serial Number: 4 (0x4)

  Signature Algorithm: sha1WithRSAEncryption

  Issuer: C=CN, CN=mytestCA

  Validity
    
```



```

Not Before: Jan 23 08:36:21 2019 GMT
Not After : Jan 23 08:36:21 2020 GMT
Subject: C=CN, CN=test-cert-2
Subject Public Key Info:
    Public Key Algorithm: rsaEncryption
        Public-Key: (2048 bit)
        Modulus:
.....
A#
    
```

7.4.3 Configuring Local HTTP Upgrade

Configuration Effect

Perform an HTTP upgrade through the browser or the **upgrade web** command.

Notes

- So long as a Web package is uploaded successfully and passes the version check, the device directly performs an upgrade based on the latest Web package.
- The **upgrade web download** command is used to automatically download files from the TFTP server and automatically perform an upgrade.
- The **upgrade web** command is used to automatically upgrade the Web package in the local file system.

Configuration Steps

N/A

Verification

- Access and view the latest Web page through the browser.

Related Commands

📄 Downloading a Web Package from the TFTP Server

Command	upgrade web download { oob_tftp: /path tftp: /path }
Parameter Description	<i>oob_tftp</i> : Connects to the TFTP server through the management port and downloads a Web package. Only the devices that support the management port support the parameter. <i>tftp</i> : Connects the TFTP server through a common data port and downloads a Web package. <i>path</i> : Path of a Web package on the TFTP server.
Command Mode	Privileged mode
Usage Guide	This command is used to download a Web package from the TFTP server and automatically perform an upgrade.

📄 Upgrading a Web Package Stored on a Local Device

Command	upgrade web uri
Parameter	<i>uri</i> : Local path for storing a Web package.
Description	
Command Mode	Privileged mode
Usage Guide	This command is used to upgrade a Web package stored on a device and automatically perform an upgrade.

Configuration Example

📌 **Obtaining the Latest Web Package from the Official Website and Running the Web Package**

Scenario Figure 7-6	
Configuration Steps	<ul style="list-style-type: none"> ● Connect to a local PC whose IP address is 10.10.10.13 and assign an IP address 10.10.10.131 in the same network segment to the device. ● Log in to the device through Web and upload the latest Web package to the device.
A	<pre>A#configure terminal A(config)# vlan 1 A(config-vlan)# exit A(config)# interface vlan 1 A(config-VLAN 1)# ip address 10.10.10.131 255.255.255.0 A(config-VLAN 1)# exit A(config)# enable service web-server</pre>
	On a PC, use the local upgrade function on the Web page to upload a Web package for upgrade.
Verification	On the PC, log in to the device through Web again and check whether the latest Web page is displayed.

📌 **Upgrading a Web Package by Running the upgrade web download Command**

Scenario Figure 7-7	
Configuration Steps	<ul style="list-style-type: none"> ● Connect to a local PC whose IP address is 10.10.10.13 and assign an IP address 10.10.10.131 in the same network segment to the device. ● Start the TFTP server.
A	<pre>A#configure terminal A(config)# vlan 1 A(config-vlan)# exit A(config)# interface vlan 1</pre>

	<pre>A(config-VLAN 1)# ip address 10.10.10.131 255.255.255.0 A(config-VLAN 1)# end A#upgrade web download tftp:// 10.10.10.13/web.upd Press Ctrl+C to quit !!!!!!! download 3896704 bytes Begin to upgrade the web package... Web package upgrade successfully.</pre>
Verification	On the PC, log in to the device through Web again and check whether the latest Web page is displayed.

📌 Upgrading a Web Package by Running the upgrade web Command

Scenario Figure 7-8	
Configuration Steps	<ul style="list-style-type: none"> ● Connect to a local PC whose IP address is 10.10.10.13 and assign an IP address 10.10.10.131 in the same network segment to the device. ● Start the TFTP server.
A	<pre>A#configure terminal A(config)# vlan 1 A(config-vlan)# exit A(config)# interface vlan 1 A(config-VLAN 1)# ip address 10.10.10.131 255.255.255.0 A(config-VLAN 1)# end A#copy tftp://10.10.10.13/web.upd flash:/web.upd Press Ctrl+C to quit !!!!!!! Accessing tftp:// 10.10.10.13/web.upd finished, 3896704 bytes prepared Flushing data to flash:/web.upd... Flush data done A #upgrade web flash:/web.upd Web package upgrade successfully. A #</pre>
Verification	On the PC, log in to the device through Web again and check whether the latest Web page is displayed.

Common Errors

- Access to the web page through the browser shows that the web page is not updated based on the latest Web package. This is possibly because the local browser has a cache. Clear the cache of the local browser and access the Web page again.

7.5 Monitoring

Displaying

Description	Command
Displays the configuration and status of the Web service.	show web-server status
Displays the HTTPS certificate information	show web-server https certificate information

8 Configuring UFT

8.1 Overview

The unified forwarding table (UFT) enables the switch to dynamically allocate the hardware forwarding entries..

Protocols and Standards

N/A

8.2 Features

Basic Concepts

N/A

Overview

Feature	Function
UFT operating mode	The UFT provides a mechanism for users to select an operating mode to meet the application scenario needs.

8.2.1 UFT Operating Mode

Working Principle

The UFT provides a mechanism for users to select an operating mode to meet the application scenario needs.

The UFT supports up to eight operating modes. The selected operating mode can take effect after it is saved and the device is restarted.

📌 Default

By default, the UFT mode of the switch is Default. In Default mode, each hardware entry of the switch is applied to most of application scenarios.

➤ **Bridge**

The Bridge mode is the Layer 2 forwarding mode. It is applied to the application scenarios in which pure Layer 2 services dominate. In Bridge mode, ARP,ND and MPLS capacity is greatly reduced and most of capacity is allocated to the MAC address table.

➤ **Gateway**

The Gateway mode is classified into three modes: gateway mode, gateway-max mode, and gateway-ndmax mode.

Gateway mode is applied to the application scenarios in which Layer 3 services dominate. Gateway-max mode is applied to the application scenarios in which a large number of terminals are deployed. Gateway-ndmax mode is applied to the application scenarios in which a large number of IPv6 terminals are deployed.

➤ **Route**

The Route mode is the network routing mode. It is applied to the application scenarios in which a great amount of routing and forwarding dominate.

The Route mode is classified into route-v4max and route-v6max modes. In these two modes, the IPv4 and IPv6 network routing table capacity are respectively allocated to maximum extent.

➤ **ACL**

The ACL mode is classified into ACL mode and ACL-IPv4 mode. The ACL-IPv4 mode has greater ACL capacity and smaller IPv6 capacity than the ACL mode.

➤ **MC**

The MC mode is the multicast mode. It is applied to the multicast routing scenarios.

➤ **VXLAN**

➤ **It is applied to the VXLAN scenarios.ALPM**

The vxlan mode is applied to the ALPM scenarios.

➤ **dual-stack-alpm**

It is applied to the application scenarios that require a great number of IPv4 and IPv6 routes.

➤ **ipv6-64-alpm**

It is applied to the application scenarios that require a great number of IPv4 and IPv6 routes with subnet mask shorter than 64 bits.

➤ **fpem-alpm**

It is applied to the application scenarios that require a great number of FP tables and routing tables.

8.3 Applications

Typical Application	Scenario
Dynamic Entry Allocation	When a device operates in common routing mode, the MPLS label is not required for forwarding and the corresponding entry capacity is not used. If the entry capacity of the MPLS label can be used by other entries, such as ARP/ND entries, the device can learn more ARP/ND entries.

8.3.1 Dynamic Entry Allocation

Scenario

The following figure shows the simple and common topology of the campus network. The core device may be deployed in the small convergence area as a small convergence device. Layer 2 functions of the core device are mainly enabled. The core device can also be deployed in the large convergence area as a large convergence device. In this case, the core device works as a gateway. When the core device acts as a small convergence device, it requires a large enough size of the MAC address table.

Another application scenario of the core device is acting as a large convergence device, namely, a large gateway. Its access capability depends on the ARP and ND capacity, namely, the number of IPv4 and IPv6 terminals that can be accessed. Take the device installed with Windows7 operating system as an example. Such a device supports IPv4 and IPv6 dual-stack. When a terminal accesses the device, the terminal occupies one ARP entry and one ND entry. In this application scenario, a great number of ARP and ND entries are required.

Figure 8- 1

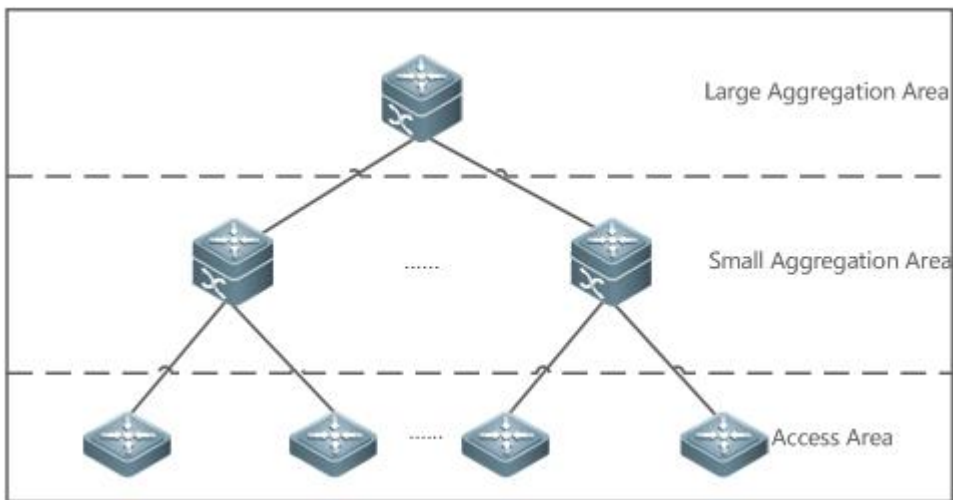

Deployment

- Enable the switch to operate in Bridge mode of UFT to increase the MAC address table capacity.
- Enable the switch to operate in Gateway mode of UFT to increase the ARP and ND entry capacity.

8.4 Configuration

Configuration Item	Suggestions and Related Commands	
Configuring UFT Operating Mode	Optional configuration. Switch over the current UFT operating mode of the switch.	
	<code>switch-mode mode_type slot slot_num</code>	Switches the UFT operating mode in stand-alone mode.
	<code>switch-mode mode_type switch switch_num slot slot_num</code>	Switches the UFT operating mode in VSU mode.

8.4.1 Configuring UFT Operating Mode

Configuration Effect

- Configure the Bridge mode to increase the Layer 2 entry size. The Bridge mode is applied to the application scenarios in which Layer 2 services dominate.
- Configure the Gateway mode to increase the ARP and ND table size. The Gateway mode is applied to the application scenarios in which Layer3 services dominate.
- Configure the Route mode to increase the routing table size. The Route mode is applied to the application scenarios that require a great amount of routing and forwarding.

Notes

- After configuration is complete, save it and restart the device to validate configuration.
- Change the UFT mode and save the change. When the device is restarted for the first time after being upgraded, the UFT function may result in automatic restart of the line card once.
- Different devices support different UFT modes.

Configuration Method

Switching the UFT Operating Mode in Stand-Alone Mode

Mandatory configuration.

Use the **switch-mode mode_type slot slot_num** command to switch the UFT mode of the switch.

Command Syntax	switch-mode mode_type slot slot_num
Parameter Description	<i>mode_type</i> : UFT operating mode. <i>slot_num</i> : indicates the corresponding line card installed in the chassis.
Defaults	Default mode
Command Mode	Global configuration mode
Usage Guide	<ul style="list-style-type: none"> ● In stand-alone mode, the line card can operate in the following modes: ● default: Default mode, which is applied to most of application scenarios. ● bridge: Bridge mode, which is applied to the application scenarios where pure Layer 2 services dominate. ● gateway: Gateway mode, which is applied to the application scenario in which Layer 3 services dominate. ● gateway-max: Gateway-max mode, which is applied to the application scenarios in which a large number of terminals are deployed. ● gateway-ndmax: Gateway-ndmax mode, which is applied to the application scenarios in which a large number of IPv6 terminals are deployed. ● label: Label mode, which is applied to the application scenarios that require a great amount of MPLS. ● route-v4max: IPv4 routing mode, which is applied to the application scenarios that require a great number of IPv4 routes. ● route-v6max: IPv6 routing mode, which is applied to the application scenarios that require a great number of IPv6 routes. ● acl: ACL mode, which is applied to the ACL and other security scenarios. ● acl-ipv4: ACL-IPv4 mode, which is applied to the scenarios that require great ACL capacity and small IPv6 route

	<p>capacity.</p> <ul style="list-style-type: none"> ● mc: Multicast mode, which is applied to the multicast routing scenarios. ● vxlan: vxlan mode, which is applied to the vxlan scenarios. ● alpm: alpm mode, which is applied to the vxlan scenarios. ● dual-stack-alpm: dual-stack-alpm mode, which is applied to the application scenarios that require a great number of IPv4 and IPv6 routes. ● ipv6-64-alpm: ipv6-64-alpm mode, which is applied to the application scenarios that require a great number of IPv4 and IPv6 routes with subnet mask shorter than 64 bits. ● fpem-alpm: fpem-alpm mode, which is applied to the application scenarios that require a great number of FP tables and routing tables.
--	--

Switching the UFT Operating Mode in VSU Mode

Mandatory configuration.

Use the **switch-mode mode_type switch switch_num slot slot_num** command to switch the UFT mode of the switch.

Command	switch-mode mode_type switch switch_num slot slot_num
Syntax	
Parameter Description	<p><i>mode_type</i>: UFT operating mode.</p> <p><i>switch_num</i>: In stand-alone mode, the switch keyword is invisible. In VSU mode, the switch keyword indicates the chassis or box device.</p> <p><i>slot_num</i>: indicates the line card installed in the chassis device.</p>
Defaults	Default mode
Command Mode	Global configuration mode
Usage Guide	<ul style="list-style-type: none"> ● In VSU mode, the line card can operate in the following modes: ● default: Default mode, which is applied to most of application scenarios. ● bridge: Bridge mode, which is applied to the application scenarios where pure Layer 2 services dominate. ● gateway: Gateway mode, which is applied to the application scenarios in which Layer 3 services dominate. ● gateway-max: Gateway-max mode, which is applied to the application scenarios in which a large number of terminals are deployed. ● gateway-ndmax: Gateway_ndmax mode, which is applied to the application scenarios in which a large number of IPv6 terminals are deployed. ● label: Label mode, which is applied to the application scenarios that require a great amount of MPLS. ● route-v4max: IPv4 routing mode, which is applied to the application scenarios that require a great number of IPv4 routes. ● route-v6max: IPv6 routing mode, which is applied to the application scenarios that require a great number of IPv6 routes. ● acl: ACL mode, which is applied to the ACL and other security scenarios. ● acl-ipv4: ACL-IPv4 mode, which is applied to the scenarios that require great ACL capacity and small IPv6 route capacity.

- **mc**: Multicast mode, which is applied to the multicast routing scenarios.
- **vxlan**: vxlan mode, which is applied to the vxlan scenarios.
- **alpm**: alpm mode.
- **dual-stack-alpm**: dual-stack-alpm mode, which is applied to the application scenarios that require a great number of IPv4 and IPv6 routes.
- **ipv6-64-alpm**: ipv6-64-alpm mode, which is applied to the application scenarios that require a great number of IPv4 and IPv6 routes with subnet mask shorter than 64 bits.
- **fpem-alpm**: fpem-alpm mode, which is applied to the application scenarios that require a great number of FP tables and routing tables.

Verification

- After the device is restarted, use the **show run** command to display the current line card status and check whether the configuration takes effect.
- Use the **show switch-mode status** command to display the UFT mode status.

Command	show switch-mode status
Syntax	
Parameter	N/A
Description	
Command Mode	Privileged EXEC mode, global configuration mode, interface configuration mode
Usage Guide	N/A
Configuration	FS(config)##show switch-mode status
Example	<pre>Slot No Switch-Mode-Next Switch-Mode-Current switch 1 slot 3----- 0 bridge bridge</pre>

- Use the **show switch-mode all** command to display the software and hardware resource in a mode or in all modes.

Command	show switch-mode all
Syntax	
Parameter	N/A
Description	
Command Mode	Privileged EXEC mode, global configuration mode, interface configuration mode
Usage Guide	N/A
Configuration	FS#show switch-mode all
Example	<pre>Current mode is marked by * : Hardware: ----- Switch Mode L2_ENTRY L3_ENTRY L3_DEFIP L3_DEFIP_128 ALPM-V4 ALPM-V6 ----- default 98304 212992 6144 1024 0 0 (*) bridge 294912 16384 6144 1024 0 0 gateway 98304 212992 6144 1024 0 0</pre>

route-v4max	98304	212992	8192	0	0	0	
route-v6max	98304	212992	6144	1024	0	0	
alpm	32768	16384	4096	2048	196608	65536	
vxlan	98304	212992	6144	1024	0	0	
vxlan-border	98304	212992	6144	1024	0	0	
default-overlay	98304	212992	6144	1024	0	0	
bridge-overlay	294912	16384	6144	1024	0	0	
gateway-overlay	98304	212992	6144	1024	0	0	
gateway-max-overla	98304	212992	6144	1024	0	0	
gateway-ndmax-over	98304	212992	6144	1024	0	0	
route-v4max-overla	98304	212992	8192	0	0	0	
route-v6max-overla	98304	212992	6144	1024	0	0	
alpm-overlay	32768	16384	4096	2048	196608	65536	
Software:							

Switch Mode	Ipv4_host	Ipv6_host	Ipv4_lpm	Ipv6_lpm	Arp	Nd	

default	160000	70000	20000	10000	40000	40000	(*)
bridge	30000	12000	20000	10000	7000	7000	
gateway	160000	70000	20000	10000	40000	40000	
route-v4max	160000	70000	20000	10000	128000	40000	
route-v6max	160000	70000	20000	10000	40000	40000	
alpm	138000	25000	130000	17000	8000	8000	
vxlan	160000	70000	20000	10000	121000	8000	
vxlan-border	160000	70000	20000	10000	121000	8000	
default-overlay	160000	70000	20000	10000	40000	40000	
bridge-overlay	30000	12000	20000	10000	7000	7000	
gateway-overlay	160000	70000	20000	10000	40000	8000	
gateway-max-overla	160000	70000	20000	10000	106496	77824	
gateway-ndmax-over	160000	70000	20000	10000	106496	77824	
route-v4max-overla	160000	70000	20000	10000	40000	8000	
route-v6max-overla	160000	70000	20000	10000	40000	8000	
alpm-overlay	138000	25000	138000	17000	121000	16000	

Configuration Examples

Switching UFT Operating Mode in Stand-Alone Mode

Network Environment	N/A
Configuration Method	Switch the UFT operating mode of the line card in slot3 of the switch to Bridge mode.
	<pre>FS(config)#switch-mode bridge slot 3 Please save current config and restart your device! FS(config)#show run</pre>

	<pre> Building configuration... Current configuration : 1366 bytes version 11.0(1B2) ! cwmp ! install 3 M8600E-24XS4QXS-DB ! sysmac 1414.4b34.5624 ! nfpp ! switch-mode bridge slot 3 </pre>
<p>Check Method</p>	<p>Use the show switch-mode status command to display configuration information and UFT mode..</p>
	<pre> FS#show switch-mode status Slot No Switch-Mode-Next Switch-Mode-Current ----- - 0 bridge bridge </pre>

Common Errors

-

8.5 Monitoring

Clearing



N/A

Displaying the Running Status

Description	Command
Displays UFT operating mode of the switch	show switch-mode status
Displays software and hardware resource in UFT mode.	show switch-mode all

Displaying Debugging Information

-

-  The preceding monitoring and maintaining commands are also valid to the chassis devices and box devices, in stand-alone mode.
-  In stand-alone mode, the **switch** keyword is invisible. For the chassis device, **slot** keyword indicates a specified line card.

9 Configuring TCAM Mode

9.1 Overview

Ternary content addressable memory (TCAM) is content addressable memory (CAM) that can match a third state of "don't care". It is designed for rapid lookup of ACL and routing table entries. In this chapter, TCAM resources are used for rapid ACL entry lookup. Various services use hardware TCAM resources of the switch in different ways. When most service resources are dynamically allocated, services need to be integrated in specific scenarios due to limited TCAM resources. The TCAM mode ensures flexible TCAM resource allocation.

9.2 Applications

Application	Description
Allocating TCAM Resources	In specific scenarios, a switch will use various ACL-related services (TCAM services for short). In such scenarios, TCAM resources may be insufficient, and multiple service applications need to be integrated to the same group to share the same TCAM resources. For example, in dual-stack scenarios, the security ACL traffic statistics collection (counter-only) service and the QoS remark service are integrated to the same group to share the same TCAM resources. In this way, more TCAM services can be deployed.

9.2.1 Allocating TCAM Resources

Scenario

By default, TCAM services are not integrated. One service occupies at least one or two TCAM resources. In dual-stack scenarios, multiple TCAM services cannot be used due to limited TCAM resources. If many TCAM services are required, TCAM services that do not conflict need to be integrated to fully utilize TCAM resources.

For example, the following services can be integrated: (Non-IPv6 CPP services are called CPP v4 services for short, and IPv6 CPP services are called CPP v6 services for short. Keywords "in" and "out" in services indicate services that take effect to inbound and outbound traffic respectively.)

- (1) CPP v4 services and sub-interface route-sample v4 in services
- (2) CPP v6 services and sub-interface route-sample v6 in services
- (3) ACL v4 in traffic statistics collection (counter-only) and QoS remark v4 in services
- (4) ACL v6 in traffic statistics collection (counter-only) and QoS remark v6 in services
- (5) ACL v4 out traffic statistics collection (counter-only) and sub-interface route-sample v4 out services
- (6) ACL v6 out traffic statistics collection (counter-only) and sub-interface route-sample v6 out services

Deployment

- Configure the TCAM mode of a switch to **acl-max** or **acl-slices_all** to integrate TCAM services that do not conflict to share the same TCAM resources, and therefore to fully utilize TCAM resources.

9.3 Features

Basic Concepts

N/A

Overview

Feature	Description
TCAM Mode	Users can select a TCAM mode for a scenario based on TCAM resource requirements of the scenario.

9.3.1 TCAM Mode

Working Principle

Users can select a TCAM mode for a scenario based on TCAM resource requirements of the scenario.

Two TCAM modes are supported, and both modes take effect after the configuration is saved and the switch is restarted.

↘ default

The default TCAM mode of a switch is **default**. In this mode, TCAM services will not be integrated to share the same TCAM resources. This mode applies to scenarios in which few TCAM services are used.

↘ acl-max

The **acl-max** mode enables TCAM services to fully utilize TCAM resources. In this mode, TCAM services that do not conflict will be integrated to share the same TCAM resources.

↘ acl-slices_all

The **acl-slices_all** mode enables TCAM service to use as much TCAM resource as possible.

9.4 Configuration

Configuration	Description and Command	
Configuring the TCAM Mode	 (Optional) By default, a TCAM mode is configured. It is used to configure the TCAM mode of a switch.	
	tcam-mode <i>mode-type</i>	Configures a TCAM mode.

9.4.1 Configuring the TCAM Mode

Configuration Effect

- Configure the **acl-max** mode to enable TCAM services to fully utilize TCAM resources. In this mode, TCAM services that do not conflict will be integrated to share the same TCAM resources.

Notes

- After the TCAM mode is set to **default** or **acl-max**, the configuration needs to be saved and the switch needs to be restarted for the configuration to take effect.
- When the TCAM mode is changed to **acl-max** and the configuration is saved, the switch will be upgraded. If the switch is restarted for the first time, the line card will be restarted once automatically.

Configuration Steps

▾ Configuring the ACL-MAX Mode

- The default TCAM mode of a switch is **default**.
- Optional. By default, a TCAM mode is configured and cannot be disabled.

Command	tcam-mode <i>mode-type</i>
Parameter	<i>mode -type</i> : specifies the TCAM mode.
Description	
Defaults	By default, the TCAM mode is set to default .
Command Mode	Global configuration mode
Usage Guide	Configure the TCAM mode of a switch to either of the following modes: <ul style="list-style-type: none"> ● default: applies to most scenarios. ● acl-max: ACL-MAX mode, applies to scenarios in which TCAM services that do not conflict need to be integrated to share the same TCAM resources, and therefore to fully utilize TCAM resources. ● acl-slices-all: ACL-SLICES-ALL mode, applies to scenarios in which TCAM services that do not conflict need to be integrated to share the same TCAM resources, and therefore to fully utilize TCAM resources.

Verification

- After the switch is restarted, run the **show run** command to check whether the current configuration takes effect.
- Run the **show tcam-mode status** command to display the TCAM mode status.

Command	show tcam-mode status
Parameter	N/A
Description	

Command Mode	Privileged EXEC mode, global configuration mode, and interface configuration mode
Usage Guide	N/A
Command Presentation	<p>The following example displays ACL-MAX mode.</p> <pre>FS(config)# show tcam-mode status TCAM-Mode config-mode: acl-max save-mode: acl-max running-mode: acl-max</pre> <p>The following example displays ACL-SLICES-ALL mode.</p> <pre>FS(config)# show tcam-mode status config-mode: acl-slices-all save-mode: acl-slices-all running-mode: acl-slices-all</pre>

Configuration Example

📌 **Configuring the ACL-MAX Mode**

Scenario	N/A
Configuration Steps	<p>Set the TCAM mode of a switch to ACL-MAX.</p> <pre>FS# configure terminal FS(config)# tcam-mode acl-max Please remove ACL related config,save current config and restart your device! FS(config)# show run Building configuration... Current configuration : 2597 bytes ... tcam-mode acl-max</pre>
Verification	<p>Run the show tcam-mode status command to display the configuration information.</p> <pre>FS(config)# show tcam-mode status TCAM-Mode ----- acl-max</pre>

📌 **Configuring the ACL-SLICES-ALL Mode**

Scenario	N/A
Configuration Steps	<p>Set the TCAM mode of a switch to ACL-SLICES-ALL.</p> <pre>FS# configure terminal FS(config)# tcam-mode acl-max Please remove ACL related config,save current config and restart your device! FS(config)# show run</pre>

	<pre>Building configuration... Current configuration : 2597 bytes ... tcam-mode acl-max</pre>
Verification	Run the show tcam-mode status command to display the configuration information.
	<pre>FS(config)# show tcam-mode status config-mode: acl-slices-all save-mode: acl-slices-all running-mode: acl-slices-all</pre>

Common Errors

N/A

9.5 Monitoring

Clearing

N/A

Displaying

Description	Command
Displays the TCAM mode of a switch.	show tcam-mode status

Debugging

10 Configuring ZAM

10.1 Overview

Manual deployment of all required devices for go-online on a network consumes a lot of labor and material resources, and has the following problems or defects:

- Manual deployment of a massive number of devices for go-online on a network imposes a high technical requirement on deployment personnel. It requires a long period, resulting in high labor and material costs.
- Manual deployment of a massive number of devices may cause fatigue, and consequently, may easily cause deployment inconsistency or errors, resulting in network malfunction.
- Manual deployment does not support control and unified management, easily causing difference and inconsistency.
- It is hard to track an event and network device deployment. The entire deployment process cannot be controlled and easily results in problems or missing.
- It is hard to manage device go-online in a unified manner. Online statuses of devices cannot be tracked and thus administrators cannot learn about the online and running statuses of the devices on the network.
- Device extensibility is poor. Automatic deployment of extensible devices and even the extensible network is not supported.

To address the preceding problems, FS launches the ZAM solution to enable zero configuration of network devices, support plug-and-play, and realize unified and automatic deployment. The ZAM solution imposes few technical requirement on deployment personnel and helps reduce workload and costs. It avoids inconsistent deployment, supports unified deployment and management, tracks online statuses of devices, and simplifies operation, maintenance, and deployment of a massive number of devices.

Protocols and Standards

- RFC1541: DHCP standard

10.2 Application

Application	Description
ZAM Automatic Deployment	Implements unified management on device deployment for go-online.

10.2.1 ZAM Automatic Deployment

Scenario

Figure 10- 1 shows the network topology for ZAM solution. On the basis of the original network, a ZAM control server is added. DHCP and TFTP services are deployed on the ZAM server for managing and controlling device deployment in a unified manner for go-online, thus realizing unified management of all the deployed devices.

Figure 10- 1

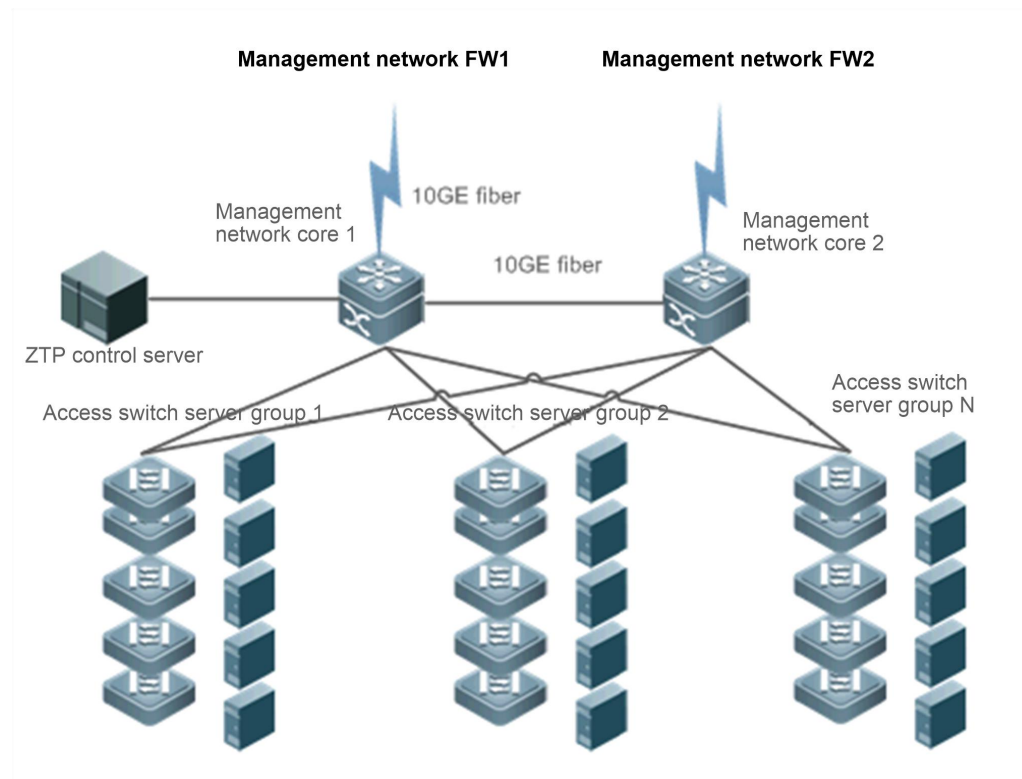

Deployment

- Deploy DHCP and TFTP services on the ZAM control server.
- Enable ZAM for access switch server groups 1, 2...N.

10.3 Features

Basic Concepts

↘ ZAM

Zero Automatic Manage

↘ IDC

Internet Data Center

↘ DHCP

Dynamic Host Configuration Protocol

↘ TFTP

Trivial File Transfer Protocol

Feature

Feature	Description
Device Go-online via ZAM	Uses the ZAM solution to enable zero configuration of network devices.

10.3.1 Device Go-online via ZAM

The ZAM solution is implemented via three steps.

Step 1: A device without configurations accesses a network. The device applies for a fixed IP address from the ZAM control server via DHCP. The ZAM control server responds to the application by returning an IP address and the response also carries the TFTP server IP address and the configuration file name corresponding to the device. The device automatically applies the IP address, and resolves the TFTP server IP address and the configuration file name carried in the response.

Step 2: The device downloads the corresponding configuration file from the ZAM control server via TFTP (a TFTP server can be independently established).

Step 3: The device loads the configuration file.

The ZAM control server and device requiring go-online must meet the following requirements:

The ZAM control server must:

- Be capable of identifying a device requiring go-online, IP address of a specific device, the TFTP server IP address, and configuration file name of this device saved on the TFTP server.
- Be capable of allocating IP addresses to a device requiring go-online, that is, be capable of providing the DHCP service to pre-allocate an IP address, a TFTP server IP address, and a configuration file name, and enabling matching between the device and the preceding pre-allocated information.
- Provide the TFTP function and support configuration file download and storage if the TFTP function is deployed on the ZAM control server (recommended).

The device requiring go-online must:

- Be capable of automatically determining whether to go online via the ZAM solution after being powered on, that is, determining whether to go online without configuration via the ZAM solution.
- Be capable of applying to the DHCP server for an IP address, and obtaining the TFTP server IP address and configures file name.
- Be capable of downloading the specified configuration scripts from the TFTP server via TFTP.
- Be capable of automatically loading the configuration script.
- Provide a retry mechanism upon a ZAM deployment failure and provide a ZAM exit mechanism.

Working Principle

Device go-online via ZAM is divided into four stages:

↘ Initialization

At this stage, a device without configurations is powered on and accesses a network. After loading is completed, the device automatically pre-deploys the ZAM environment. The pre-deployment requirement is as follows:

- Use the MGMT port for ZTP management and retain all default configurations without extra operation.

↘ DHCP

After the pre-deployment, the device obtains the ZAM management IP address, TFTP server IP address, configuration file name of the device via DHCP. Requirements are as follows:

- On the MGMT port, enable DHCP.
- Trigger DHCP to obtain the ZAM management IP address. Add request identifiers of Option 67 (boot file name) and Option 150 (TFTP server IP address) to the requested parameter list.
- Resolve and deploy ZAM management IP address. Resolve Option 67 and Option 150 in the response.

↘ TFTP

Download the corresponding configuration script according to the configuration file name and TFTP server IP address obtained at the DHCP stage.

After the configuration script is downloaded successfully, execute the configuration script to download the corresponding configuration file or bin file from the TFTP server.

↘ Configuration loading

Load the configuration file or bin file obtained at the TFTP stage and restart the device.

Related Configuration

↘ Enabling ZAM

This function is enabled by default.

Run the ZAM command to enable or disable ZAM.

ZAM must be enabled on the device to implement automatic deployment via ZAM.

10.4 Configuration

Configuration	Description and Command	
Configuring Device Go-online via ZAM	(Mandatory) It is used to enable ZAM.	
	<table border="1"> <tr> <td>zam</td> <td>Enables ZAM.</td> </tr> </table>	zam
zam	Enables ZAM.	

10.4.1 Configuring Device Go-online via ZAM

Configuration Effect

- Configure device go-online via ZAM, so that a device without configurations enters the go-online process and implements automatic deployment.

Notes

- Deploy a ZTP control server that supports device go-online via ZAM.

Configuration Steps

↳ Enabling ZAM

- Mandatory.
- Enable ZAM on each switch, unless otherwise specified.

Verification

Run the **show zam** command to check whether ZAM is enabled and to check configuration of the MGMT port.

Related Commands

↳ Enabling ZAM

Command	zam
Parameter	N/A
Description	
Command Mode	Global configuration mode
Usage Guide	Configure ZAM.

Configuration Example

The following configuration example describes ZAM-related configuration only.

↳ Configuring Device Go-online via ZAM

Configuration Steps	Configure device go-online via ZAM as follows: <ul style="list-style-type: none"> ● Enable ZAM.
Online device via ZAM	<pre>A# configure terminal A(config)# zam A(config)# exit</pre>

Verification	<ul style="list-style-type: none"> Run the show zam command to display the current configuration and status of ZAM.
FS	<pre> FS#show zam ZTP state : disable ZTP status : Now is idle ZTP manage interface: Mgmt 0 FS# </pre>

Common Errors

- The network connection between a device requiring go-online and the ZAM control server is abnormal.
- The device requiring go-online is not in the zero-configuration state.

10.5 Monitoring

Displaying

Description	Command
Displays the current configuration and status of ZAM.	show zam

Debugging

 System resources are occupied when debugging information is output. Therefore, disable the debugging switch immediately after use.

Description	Command
Debugs the ZAM framework event.	debug zam

11 Configuring Module Hot Swapping

12 Overview

Module Hot Swapping is a common maintenance function provided by chassis-based devices.

Module Hot Swapping automates the installation, uninstallation, reset, and information check of hot-swappable modules (management cards, line cards, cross-connect and synchronous timing boards [XCSs], and multi-service cards) after they are inserted into chassis-based devices.

13 Applications

Application	Description
Resetting Online Modules	During routine maintenance, you can reset an abnormally running module to troubleshoot the fault.
Clearing the Configuration of a Module	During routine maintenance, you can replace the module in a slot with a different type of module.
Deleting a MAC Address from the Configuration File	During routine maintenance, you can delete the MAC addresses of VSU member devices to perform MAC address reelection.

Isolating an Online Module	During routine maintenance, you can isolate a module before removing it for replacement to reduce the impact on system running.
----------------------------	---

13.1.1 Resetting Online Modules

Scenario

During routine maintenance, you can reset an abnormally running module in a slot to troubleshoot the fault.

Deployment

Run the **reset module** command on the console to reset a module.

13.1.2 Clearing the Configuration of a Module

Scenario

During routine maintenance, you can replace the module in a slot on a chassis-based device with a different type of module without affecting other modules.

Deployment

Perform the following operations in sequence:

1. Remove the module from the target slot.
2. Run the **remove configuration module** command on the device to remove the module configuration.
3. Insert a new module into the slot.

13.1.3 Deleting a MAC Address from the Configuration File

Scenario

In general, the MAC address used by a system is written in the management card or the flash memory of the chassis. In VSU mode, to avoid service interruption due to the change of the MAC address, the system automatically saves the MAC address to the configuration file. After the system restarts, the valid MAC address (if any) in the configuration file is used in preference. The **no sysmac** command can be used to delete the MAC address from the configuration file. Then the MAC address written in the flash memory is used by default.

Deployment

Perform the following operations in sequence:

1. Run the **no sysmac** command on the target device to delete its MAC address.
2. Save the configuration.
3. Restart the VSU and check whether the MAC address of the device is reelected.

13.1.4 Isolating an Online Module

Scenario

During routine maintenance, you can isolate a module before removing it for replacement to reduce the impact on system running.

Deployment

Enter the module isolation command on the console to isolate a module.

14 Features

Feature

Feature	Description
Automatically Installing the Inserted Module	After a new module is inserted into a chassis-based device, the device's management software will automatically install the module driver.
Resetting Online Modules	Online modules can be reset.

14.1 Automatically Installing the Inserted Module

You can hot-swap (insert and remove) a module on a device in running state without impact on other modules. After the module is inserted into a slot, the device's management software will automatically install the module driver. The configuration of the removed module is retained for subsequent configuration. If the removed module is inserted again, the module will be automatically started with its configuration effective.

- ! The module mentioned here can be a management card, a line card, an XCS, or a multi-service card. A management card can only be inserted in a management card slot (M1 or M2). A line card or multi-service card can be inserted in a line card slot. An XCS can only be inserted in an XCS slot.

Working Principle

After a module is inserted, the device's management software will automatically install the module driver and save the module information (such as the quantity of ports on the module and port type) to the device, which will be used for subsequent configuration. After the module is removed, its information is not cleared by the management software. You can continue to configure the module information. When the module is inserted again, the management software assigns the user's module configuration to the module and make it take effect.

14.2 Resetting Online Modules

The management software of a device provides the online module reset feature for module software troubleshooting.

- i Resetting an online module may interrupt some services on the device.

Working Principle

After you run the **reset module** command, the device's management software uses a hardware or software interface of the device to restart the software on the target module and restores the hardware chip to the post-power-on state. The software failure of the module will be rectified after the module is reset.

14.2.1 Isolating Online Module

The device management software provides the online module isolation function. By using the function, you can isolate online modules to reduce the impact of module removal on system running.



Isolating an online module will result in service interruption on the module. However, system running and services on other modules are not affected.

Working Principle

After receiving an online module isolation command entered by a user, the device management software sets the target module to the offline state over a hardware or software interface on the device. In this case, the impact on system running is reduced when the module is removed.

15 Configuration



The module Hot Swapping feature is automatically implemented without manual configuration.

Configuration	Description and Command	
Clearing Module and Device Configuration	(Optional) It is used to clear configuration in global configuration mode. After you run the following commands, you need to save the command configuration so that it can take effect after system restart.	
	no sysmac	Deletes a MAC address from the configuration file.
	sysmac	Modifies a MAC address in the configuration file.
Isolating an Online Module	module-offline slot-num	Isolates an online module.

15.1 Clearing Module and Device Configuration

Configuration Effect

- Clear the configuration of a module.
- Delete a MAC address from the configuration file.

Configuration Steps



Deleting a MAC Address from the Configuration File

- (Optional) Perform this configuration when you need to change the MAC address of a system to the reelected MAC address.
- In general, the MAC address used by a system is written in the management card or the flash memory of the chassis. In VSU mode, to avoid service interruption due to the change of the MAC address, the system automatically saves the MAC address to the configuration file. After the system restarts, the valid MAC address (if any) in the configuration file is used in preference.

Command	no sysmac
Parameter	N/A
Description	
Defaults	N/A
Command Mode	Global configuration mode
Usage Guide	Use this command to delete a MAC address from the configuration file. Then the MAC address written in the flash memory is used by default.

Verification

Run the **show version slot** command to display the installation information of a line card.

Command	show version slots [<i>device-id</i> / <i>slot-num</i>]
Parameter	<i>device-id</i> : (Optional) Indicates the ID of a chassis.
Description	<i>slot-num</i> : (Optional) Indicates the number of a slot.
Command Mode	Privileged EXEC mode
Usage Guide	Use this command to display the online state of a module. The Configured Module column shows the information of the installed module. After you run the remove configuration module command, the installation information of the removed module is deleted from this column.
	<pre>Show the module online status information FS# show version slots Dev Slot Port Configured Module Online Module Software Status ----- 1 1 0 none none none 1 2 24 M8606-24SFP/12GT M8606-24SFP/12GT none 1 3 2 M8606-2XFP M8606-2XFP cannot startup 1 4 24 M8606-24GT/12SFP M8606-24GT/12SFP ok 1 M1 0 N/A M8606-CM master 1 M2 0 N/A none none</pre>

15.2 Isolating Online Modules

Configuration Effect

- Isolate online modules.

Configuration Steps

📌 Isolating Online Modules

Command	module-offline [<i>device-id</i> / <i>slot-num</i>]
Parameter	<i>device-id</i> : Indicates the ID of a chassis (in VSU mode, you must input the ID of the chassis housing the module to be removed. In stand-alone, the input is not required).
Description	<i>slot-num</i> : Indicates the number of the slot for the module.
Defaults	N/A
Command Mode	Global configuration mode
Usage Guide	Use this command to reduce the impact on the system before removing a module.  This command is forbidden for VSL module or the last FE module.

Verification

Run the **show version slot** command to display the information of a module.

Command	show version slots [<i>device-id</i> / <i>slot-num</i>]
Parameter Description	<i>device-id</i> : (Optional) Indicates the ID of a chassis (in VSU mode, when you input a slot number, you also need to input the ID of the chassis where the module is located). <i>slot-num</i> : (Optional) Indicates the number of a slot.
Command Mode	Privileged EXEC mode
Usage Guide	Use this command to display the online state of a module. The Software Status column shows the information of the installed module. After you run the module-offline command, the software status is offline.
	<pre> FS# show version slots Dev Slot Port Configured Module Online Module Software Status ----- 1 1 0 none none none 1 2 24 M8606-24SFP/12GT M8606-24SFP/12GT none 1 3 2 M8606-2XFP M8606-2XFP offline 1 4 24 M8606-24GT/12SFP M8606-24GT/12SFP ok 1 M1 0 N/A M8606-CM master 1 M2 0 N/A none none </pre>

Configuration Example

Isolating Offline Modules

Scenario	<ul style="list-style-type: none"> The module in slot 3 needs to be isolated before being removed.
Configuration Steps	<ul style="list-style-type: none"> Run the show version slots command to delete the card configuration.
	<pre> FS# module-offline 3 </pre>
	<ul style="list-style-type: none"> Run the show version slots command to verify that the module in slot 3 is offline. <pre> FS# show version slots Dev Slot Port Configured Module Online Module Software Status ----- 1 1 0 none none none 1 2 24 M8606-24SFP/12GT M8606-24SFP/12GT none 1 3 2 M8606-2XFP M8606-2XFP offline 1 4 24 M8606-24GT/12SFP M8606-24GT/12SFP ok 1 M1 0 N/A M8606-CM master 1 M2 0 N/A none none </pre>

16Monitoring

Displaying

Description	Command
Displays the details of a module.	show version module detail [<i>slot-num</i>]
Displays the online state of a module.	show version slots [<i>slot-num</i>]
Displays the current MAC address of a device.	show sysmac
Displays system-level alarm information.	show alarm

17 Configuring Supervisor Module Redundancy

17.1 Overview

Supervisor module redundancy is a mechanism that adopts real-time backup (also called hot backup) of the service running status of supervisor modules to improve the device availability.

In a network device with the control plane separated from the forwarding plane, the control plane runs on a supervisor module and the forwarding plane runs on cards. The control plane information of the master supervisor module is backed up to the slave supervisor module in real time during device running. When the master supervisor module is shut down as expected (for example, due to software upgrade) or unexpectedly (for example, due to software or hardware exception), the device can automatically and rapidly switch to the slave supervisor module without losing user configuration, thereby ensuring the normal operation of the network. The forwarding plane continues with packet forwarding during switching. The forwarding is not stopped and no topology fluctuation occurs during the restart of the control plane.

The supervisor module redundancy technology provides the following conveniences for network services:

1. Improving the network availability

The supervisor module redundancy technology sustains data forwarding and the status information about user sessions during switching.

2. Preventing neighbors from detecting link flaps

The forwarding plane is not restarted during switching. Therefore, neighbors cannot detect the status change of a link from Down to Up.

3. Preventing route flaps

The forwarding plane sustains forwarding communication during switching, and the control plane rapidly constructs a new forwarding table. The process of replacing the old forwarding table with the new one is unobvious, preventing route flaps.

4. Preventing loss of user sessions

Thanks to real-time status synchronization, user sessions that are created prior to switching are not lost.

17.2 Applications

Application	Description
Redundancy of Supervisor Modules	On a core switch where two supervisor modules are installed, the redundancy technology can improve the network stability and system availability.

17.2.1 Redundancy of Supervisor Modules

Scenario

As shown in the following figure, in this network topology, if the core switch malfunctions, networks connected to the core switch break down. In order to improve the network stability, two supervisor modules need to be configured on the core switch to implement redundancy. The master supervisor module manages the entire system and the slave supervisor module backs up information about service running status of the master supervisor module in real time. When manual switching is performed or forcible switching is performed due to a failure occurring on the master supervisor module, the slave supervisor module immediately takes over functions of the master supervisor module. The forwarding plane can proceed with data forwarding and the system availability is enhanced.

Figure 12- 1

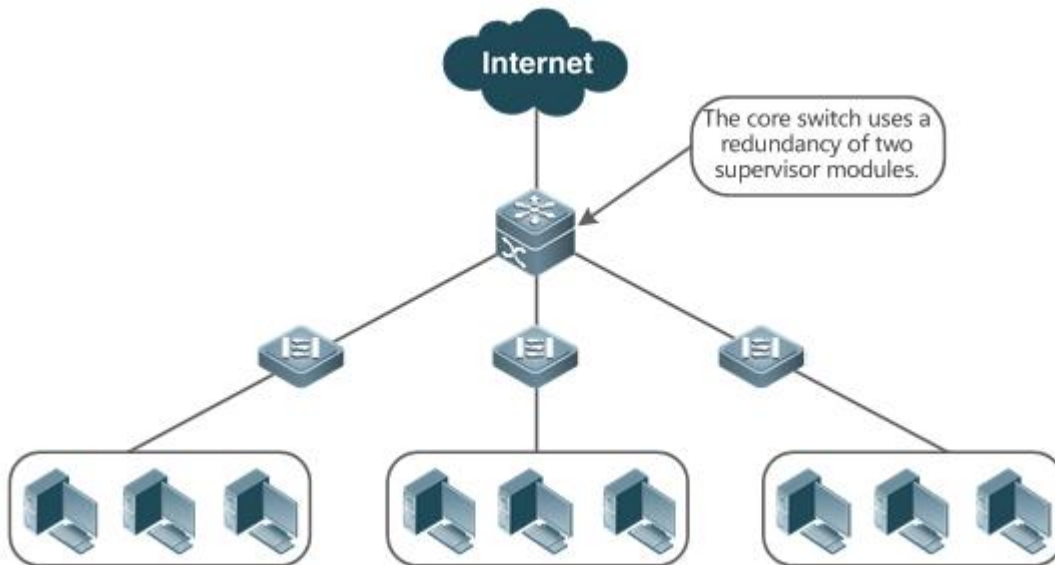

Deployment

For chassis-type devices, the system is equipped with the master/slave backup mechanism. The system supports plug-and-play as long as master and slave supervisor modules conform to redundancy conditions.

For case-type devices, each device is equivalent to one supervisor module and one line card.

17.3 Features

Basic Concepts

↘ Master Supervisor Module, Slave Supervisor Module

On a device where two supervisor modules are installed, the system elects one supervisor module as active, which is called the master supervisor module. The other supervisor module functions as a backup supervisor module. When the master supervisor module malfunctions or actively requests switching, the backup supervisor module takes over the functions of the master supervisor module and becomes the new master supervisor module, which is called the slave supervisor module. In general, the slave supervisor module does not participate in switch management but monitors the running status of the master supervisor module.

↘ Prerequisites for Redundancy of Supervisor Modules

In a device system, the hardware and software of all supervisor modules must be compatible so that the redundancy of supervisor modules functions properly.

Batch synchronization is required between the master and slave supervisor modules during startup so that the two supervisor modules are in the same state. The redundancy of supervisor modules is ineffective prior to synchronization.

▾ Redundancy Status of Supervisor Modules

The master supervisor module experiences the following status changes during master/slave backup:

- alone state: In this state, only one supervisor module is running in the system, or the master/slave switching is not complete, and redundancy is not established between the new master supervisor module and the new slave supervisor module.
- batch state: In this state, redundancy is established between the master and slave supervisor modules and batch backup is being performed.
- realtime state: The master supervisor module enters this state after the batch backup between the master and slave supervisor modules is complete. Real-time backup is performed between the master and slave supervisor modules, and manual switching can be performed only in this state.

Overview

Feature	Description
Election of Master and Slave Supervisor Modules	The device can automatically select the master and slave supervisor modules based on the current status of the system. Manual selection is also supported.
Information Synchronization of Supervisor Modules	In the redundancy environment of supervisor modules, the master supervisor module synchronizes status information and configuration files to the slave supervisor module in real time.

17.3.1 Election of Master and Slave Supervisor Modules

Working Principle

▾ Automatically Selecting Master and Slave Supervisor Modules for Chassis-type Devices

Users are allowed to insert or remove supervisor modules during device running. The device, based on the current condition of the system, automatically selects an engine for running, without affecting the normal data switching. The following cases may occur and the master supervisor module is selected accordingly:

- If only one supervisor module is inserted during device startup, the device selects this supervisor module as the master supervisor module regardless of whether it is inserted into the M1 slot or M2 slot.
- If two supervisor modules are inserted during device startup, by default, the supervisor module in the M1 slot is selected as the master supervisor module and the supervisor module in the M2 slot is selected as the slave supervisor module to serve as a backup, and relevant prompts are output.
- If one supervisor module is inserted during device startup and another supervisor module is inserted during device running, the supervisor module that is inserted later is used as the slave supervisor module to serve as a backup regardless of whether it is inserted into the M1 slot or M2 slot, and relevant prompts are output.
- Assume that two supervisor modules are inserted during device startup and one supervisor module is removed during device running (or one supervisor module malfunctions). If the removed supervisor module is the slave supervisor module prior to removal (or failure), only a prompt is displayed after removal (or malfunction), indicating that the slave supervisor module is

removed (or fails to run). If the removed supervisor module is the master supervisor module prior to removal (or failure), the other supervisor module becomes the master supervisor module and relevant prompts are output.

↘ Manually Selecting the Master and Slave Supervisor Modules

Users can manually make configuration to select the master and slave supervisor modules, which are selected based on the environment as follows:

- In standalone mode, users can manually perform master/slave switching. The supervisor modules take effect after reset.

Related Configuration

↘ Manually Performing Master/Slave Switching

- By default, the device can automatically select the master supervisor module.
- In the standalone modes, users can run the **redundancy forceswitch** command to perform manual switching.

17.3.2 Information Synchronization of Supervisor Modules

Working Principle

- Status synchronization

The master supervisor module synchronizes its running status to the slave supervisor module in real time so that the slave supervisor module can take over the functions of the master supervisor module at any time, without causing any perceivable changes.

- Configuration synchronization

There are two system configuration files during device running: running-config and startup-config. running-config is a system configuration file dynamically generated during running and changes with the service configuration. startup-config is a system configuration file imported during device startup. You can run the **write** command to write running-config into startup-config or run the **copy** command to perform the copy operation.

For some functions that are not directly related to non-stop forwarding, the synchronization of system configuration files can ensure consistent user configuration during switching.

In the case of redundancy of dual supervisor modules, the master supervisor module periodically synchronizes the startup-config and running-config files to the slave supervisor module and all candidate supervisor modules. The configuration synchronization is also triggered in the following operations:

1. The running-config file is synchronized when the device switches from the global configuration mode to privileged EXEC mode.
2. The startup-config file is synchronized when the **write** or **copy** command is executed to save the configuration.
3. Information configured over the Simple Network Management Protocol (SNMP) is not automatically synchronized and the synchronization of the running-config file needs to be triggered by running commands on the CLI.

Related Configuration

- By default, the startup-config and running-config files are automatically synchronized once per hour.
- Run the **auto-sync time-period** command to adjust the interval for the master supervisor module to synchronize configuration files.

17.4 Configuration

Configuration	Description and Command	
Configuring Manual Master/Slave Switching	Optional.	
	show redundancy states	Displays the hot backup status.
	redundancy forceswitch	Manually performs master/slave switching.
Configuring the Automatic Synchronization Interval	Optional.	
	redundancy	Enters the redundancy configuration mode.
	auto-sync time-period	Configures the automatic synchronization interval of configuration files in the case of redundancy of dual supervisor modules.
Resetting Supervisor Modules	Optional.	
	redundancy reload	Resets the slave supervisor module or resets both the master and slave supervisor modules at the same time.

17.4.1 Configuring Manual Master/Slave Switching

Configuration Effect

The original master supervisor module is reset and the slave supervisor module becomes the new master supervisor module.

If there are more than two supervisor modules in the system, the original slave supervisor module becomes the master supervisor module, one supervisor module is elected out of candidate supervisor modules to serve as the new slave supervisor module, and the original master supervisor module becomes a candidate supervisor module after reset.

Notes

To ensure that data forwarding is not affected during switching, batch synchronization needs to be first performed between the master and slave supervisor modules so that the two supervisor modules are in the same state. That is, manual switching can be performed only when the redundancy of supervisor modules is in the real-time backup state. In addition, to ensure synchronization completeness of configuration files, service modules temporarily forbid manual master/slave switching during synchronization. Therefore, the following conditions need to be met simultaneously for manual switching:

- Manual master/slave switching is performed on the master supervisor module and a slave supervisor module is available.
- All virtual switching devices (VSDs) in the system are in the real-time hot backup state.
- The hot-backup switching of all VSDs in the system is not temporarily forbidden by service modules.

If devices are virtualized as multiple VSDs, manual switching can be successfully performed only when the supervisor modules of all the VSDs are in the real-time backup state.

Configuration Steps

- Optional.
- Make the configuration on the master supervisor module.

Verification

Run the **show redundancy states** command to check whether the master and slave supervisor modules are switched.

Related Commands

➤ **Checking the Hot Backup Status**

Command	show redundancy states
Parameter	N/A
Description	
Command Mode	Privileged EXEC mode or global configuration mode
Usage Guide	N/A

➤ **Manually Performing Master/Slave Switching**

Command	redundancy forceswitch
Parameter	N/A
Description	
Command Mode	Privileged EXEC mode
Usage Guide	N/A

Configuration Example

➤ **Manually Performing Master/Slave Switching**

Configuration Steps	<p>In the VSD environment where the name of one VSD is staff, perform master/slave switching.</p> <pre> FS> enable FS# show redundancy states Redundancy role: master Redundancy state: realtime Auto-sync time-period: 3600 s VSD staff redundancy state: realtime FS# redundancy forceswitch This operation will reload the master unit and force switchover to the slave unit. Are you sure to continue? [N/y] y </pre>
Verification	<p>On the original slave supervisor module, run the show redundancy states command to check the redundancy status.</p> <pre> FS# show redundancy states Redundancy role: master Redundancy state: realtime Auto-sync time-period: 3600 s </pre>

	VSD staff redundancy state: realtime
--	--------------------------------------

17.4.2 Configuring the Automatic Synchronization Interval

Configuration Effect

Change the automatic synchronization interval of the startup-config and running-config files. If the automatic synchronization interval is set to a smaller value, changed configuration is frequently synchronized to other supervisor modules, preventing the configuration loss incurred when services and data are forcibly switched to the slave supervisor module when the master supervisor module malfunctions.

Configuration Steps

- Optional. Make the configuration when the synchronization interval needs to be changed.
- Make the configuration on the master supervisor module.

Verification

- View the output syslogs to check whether timed synchronization is performed.

Related Commands

↘ Entering the Redundancy Configuration Mode

Command	redundancy
Parameter	N/A
Description	
Command Mode	Global configuration mode
Usage Guide	N/A

↘ Configuring the Automatic Synchronization Interval of Configuration Files

Command	Auto-sync time-period <i>value</i>
Parameter Description	time-period value: Indicates the automatic synchronization interval, with the unit of seconds. The value ranges from 1 second to 1 month (2,678,400 seconds).
Command Mode	Redundancy configuration mode
Usage Guide	Configure the automatic synchronization interval of the startup-config and running-config files in the case of redundancy of dual supervisor modules.

Configuration Example

↘ Configuring the Automatic Synchronization Interval

Configuration Steps	In redundancy configuration mode of the master supervisor module, configure the automatic synchronization interval to 60 seconds.
	<pre>FS(config)# redundancy FS(config-red)# auto-sync time-period 60</pre>

	Redundancy auto-sync time-period: enabled (60 seconds). FS(config-red)# exit
Verification	Run the show redundancy states command to check the configuration.
	FS# show redundancy states Redundancy role: master Redundancy state: realtime Auto-sync time-period: 3600 s

17.4.3 Resetting Supervisor Modules

Configuration Effect

Resetting only the slave supervisor module does not affect data forwarding, and the forwarding is not interrupted or user session information is not lost during reset of the slave supervisor module.

In standalone mode, running the **redundancy reload shelf** command will cause simultaneous reset of all supervisor modules and line cards in the chassis.

Notes

N/A

Configuration Steps

- Optional. Perform the reset when the supervisor modules or device runs abnormally.

Related Commands

Command	redundancy reload {peer shelf [switchid]}
Parameter Description	peer: Only resets the slave supervisor module. shelf [switchid]: Indicates that the master and slave supervisor modules are set in standalone mode.
Command Mode	Privileged EXEC mode
Usage Guide	In standalone mode, the device reset command is redundancy reload shelf , that is, the entire device is reset.

Configuration Example

17.5 Monitoring

Displaying

Description	Command
Displays the current redundancy status of dual supervisor modules.	show redundancy states

18 Configuring Syslog

18.1 Overview

Status changes (such as link up and down) or abnormal events may occur anytime. FS products provide the syslog mechanism to automatically generate messages (log packets) in fixed format upon status changes or occurrence of events. These messages are displayed on the related windows such as the Console or monitoring terminal, recorded on media such as the memory buffer or log files, or sent to a group of log servers on the network so that the administrator can analyze network performance and identify faults based on these log packets. Log packets can be added with the timestamps and sequence numbers and classified by severity level so that the administrator can conveniently read and manage log packets.

Protocols and Standards

- RFC3164: The BSD syslog Protocol

18.2 Applications

Application	Description
Sending Syslogs to the Console	Monitor syslogs through the Console.
Sending Syslogs to the Log Server	Monitor syslogs through the server.

18.2.1 Sending Syslogs to the Console

Scenario

Send syslogs to the Console to facilitate the administrator to monitor the performance of the system. The requirements are as follows:

1. Send logs of Level 6 or higher to the Console.
2. Send logs of only the ARP and IP modules to the Console.

Figure 13- 1 shows the network topology.

Figure 13- 1 Network topology

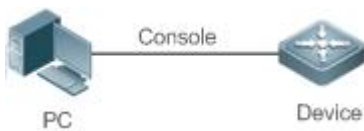

Deployment

Configure the device as follows:

1. Set the level of logs that can be sent to the Console to informational (Level 6).
2. Set the filtering direction of logs to terminal.
3. Set log filtering mode of logs to contains-only.
4. Set the filtering rule of logs to single-match. The module name contains only ARP or IP.

18.2.2 Sending Syslogs to the Log Server

Scenario

Send syslogs to the log server to facilitate the administrator to monitor the logs of devices on the server. The requirements are as follows:

1. Send syslogs to the log server 10.1.1.1.
2. Send logs of Level 7 or higher to the log server.
3. Send syslogs from the source interface Loopback 0 to the log server.

Figure 13- 2 shows the network topology.

Figure 13- 2 Network topology



Deployment

Configure the device as follows:

1. Set the IPv4 address of the server to 10.1.1.1.
2. Set the level of logs that can be sent to the log server to debugging (Level 7).
3. Set the source interface of logs sent to the log server to Loopback 0.

18.3 Features

Basic Concepts

Classification of Syslogs

Syslogs can be classified into two types:

- Log type
- Debug type

Levels of Syslogs

Eight severity levels of syslogs are defined in descending order, including emergency, alert, critical, error, warning, notification, informational, and debugging. These levels correspond to eight numerical values from 0 to 7. A smaller value indicates a higher level.

Only logs with a level equaling to or higher than the specified level can be output. For example, if the level of logs is set to informational (Level 6), logs of Level 6 or higher will be output.

The following table describes the log levels.

Level	Numerical Value	Description
emergencies	0	Indicates that the system cannot run normally.
alerts	1	Indicates that the measures must be taken immediately.
critical	2	Indicates a critical condition.

errors	3	Indicates an error.
warnings	4	Indicates a warning.
notifications	5	Indicates a notification message that requires attention.
informational	6	Indicates an informational message.
debugging	7	Indicates a debugging message.

Output Direction of Syslogs

Output directions of syslogs include Console, monitor, server, buffer, and file. The default level and type of logs vary with the output direction. You can customize filtering rules for different output directions.

The following table describes output directions of syslogs.

Output Direction	Description	Default Output Level	Description
Console	Console	Debugging (Level 7)	Logs and debugging information are output.
monitor	Monitoring terminal	Debugging (Level 7)	Logs and debugging information are output.
server	Log server	Informational (Level 6)	Logs and debugging information are output.
buffer	Log buffer	Debugging (Level 7)	Logs and debugging information are output. The log buffer is used to store syslogs.
file	Log file	Informational (Level 6)	Logs and debugging information are output. Logs in the log buffer are periodically written into files.

RFC3164 Log Format

Formats of syslogs may vary with the syslog output direction.

- If the output direction is the Console, monitor, buffer, or file, the syslog format is as follows:

```
seq no: *timestamp: sysname %module-level-mnemonic: content
```

For example, if you exit configuration mode, the following log is displayed on the Console:

```
001233: *May 22 09:44:36: FS %SYS-5-CONFIG_I: Configured from console by console
```

- If the output direction is the log server, the syslog format is as follows:

```
<priority>seq no: *timestamp: sysname %module-level-mnemonic: content
```

For example, if you exit configuration mode, the following log is displayed on the log server:

```
<189>001233: *May 22 09:44:36: FS %SYS-5-CONFIG_I: Configured from console by console
```

The following describes each field in the log in details:

1. Priority

This field is valid only when logs are sent to the log server.

The priority is calculated using the following formula: Facility x 8 + Level. Level indicates the numerical code of the log level and Facility indicates the numerical code of the facility. The default facility value is local7 (23). The following table lists the value range of the facility.

Numerical Code	Facility Keyword	Facility Description
0	kern	kernel messages
1	user	user-level messages
2	mail	mail system

Numerical Code	Facility Keyword	Facility Description
3	daemon	system daemons
4	auth1	security/authorization messages
5	syslog	messages generated internally by syslogs
6	lpr	line printer subsystem
7	news	network news subsystem
8	uucp	UUCP subsystem
9	clock1	clock daemon
10	auth2	security/authorization messages
11	ftp	FTP daemon
12	ntp	NTP subsystem
13	logaudit	log audit
14	logalert	log alert
15	clock2	clock daemon
16	local0	local use 0 (local0)
17	local1	local use 1 (local1)
18	local2	local use 2 (local2)
19	local3	local use 3 (local3)
20	local4	local use 4 (local4)
21	local5	local use 5 (local5)
22	local6	local use 6 (local6)
23	local7	local use 7 (local7)

2. Sequence Number

The sequence number of a syslog is a 6-digit integer, and increases sequentially. By default, the sequence number is not displayed. You can run a command to display or hide this field.

3. Timestamp

The timestamp records the time when a syslog is generated so that you can display and check the system event conveniently. FS devices support two syslog timestamp formats: datetime and uptime.

-  If the device does not have the real time clock (RTC), which is used to record the system absolute time, the device uses its startup time (uptime) as the syslog timestamp by default. If the device has the RTC, the device uses its absolute time (datetime) as the syslog timestamp by default.

The two timestamp formats are described as follows:

-  Datetime format

The datetime format is as follows:

```
Mmm dd yyyy hh:mm:ss.msec
```

The following table describes each parameter of the datetime.

Timestamp Parameter	Parameter Name	Description
Mmm	Month	Mmm refers to abbreviation of the current month. The 12 months in a year are written as Jan, Feb, Mar, Apr, May, Jun, Jul, Aug, Sep, Oct, Nov, and Dec.

dd	Day	dd indicates the current date.
yyyy	Year	yyyy indicates the current year, and is not displayed by default.
hh	Hour	hh indicates the current hour.
mm	Minute	mm indicates the current minute.
ss	Second	ss indicates the current second.
msec	Millisecond	msec indicates the current millisecond.

By default, the datetime timestamp displayed in the syslog does not contain the year and millisecond. You can run a command to display or hide the year and millisecond of the datetime timestamp.

● Uptime format

The uptime format is as follows:

```
dd:hh:mm:ss
```

The timestamp string indicates the accumulated days, hours, minutes, and seconds since the system is started.

1. Sysname

This field indicates the name of the device that generates the log so that the log server can identify the host that sends the log. By default, this field is not displayed. You can run a command to display or hide this field.

2. Module

This field indicates the name of the module that generates the log. The module name is an upper-case string of 2 to 20 characters, which contain upper-case letters, digits, or underscores. The module field is mandatory in the log-type information, and optional in the debug-type information.

3. Level

Eight syslog levels from 0 to 7 are defined. The level of syslogs generated by each module is fixed and cannot be modified.

4. Mnemonic

This field indicates the brief information about the log. The mnemonic is an upper-case string of 4 to 32 characters, which may include upper-case letters, digits, or underscore. The mnemonic field is mandatory in the log-type information, and optional in the debug-type information.

5. Content

This field indicates the detailed content of the syslog.

Overview

Feature	Description
Logging	Enable or disable the system logging functions.
Syslog Format	Configure the syslog format.
Logging Direction	Configure the parameters to send syslogs in different directions.
Syslog Filtering	Configure parameters of the syslog filtering function.
Featured Logging	Configure parameters of the featured logging function.
Syslog Monitoring	Configure parameters of the syslog monitoring function.

18.3.1 Logging

Enable or disable the logging, log redirection, and log statistics functions.

Related Configuration

↳ Enable Logging

By default, logging is enabled.

Run the **logging on** command to enable logging in global configuration mode. After logging is enabled, logs generated by the system are sent in various directions for the administrator to monitor the performance of the system.

↳ Enabling Log Redirection

By default, log redirection is enabled on the Virtual Switching Unit (VSU).

Run the **logging rd on** command to enable log redirection in global configuration mode. After log redirection is enabled, logs generated by the standby device or standby supervisor module are redirected to the active device or active supervisor module on the VSU to facilitate the administrator to manage logs.

↳ Enabling Log Statistics

By default, log statistics is disabled.

Run the **logging count** command to enable log statistics in global configuration mode. After log statistics is enabled, the system records the number of times a log is generated and the last time when the log is generated.

18.3.2 Syslog Format

Configure the syslog format, including the RFC5424 log format, timestamp format, sysname, and sequence number.

Related Configuration

↳ Configuring the Timestamp Format

By default, the syslog uses the datetime timestamp format, and the timestamp does not contain the year and millisecond.

Run the **service timestamps** command in global configuration mode to use the datetime timestamp format that contains the year and millisecond in the syslog, or change the datetime format to the uptime format.

↳ Adding Sysname to the Syslog

By default, the syslog does not contain sysname.

Run the **service sysname** command in global configuration mode to add sysname to the syslog.

↳ Adding the Sequence Number to the Syslog

By default, the syslog does not contain the sequence number.

Run the **service sequence-numbers** command in global configuration mode to add the sequence number to the syslog.

↳ Enabling the Standard Log Format

By default, logs are displayed in the following format:

```
*timestamp: %module-level-mnemonic: content
```

Run the **service standard-syslog** command in global configuration mode to enable the standard log format and logs are displayed in the following format:

```
timestamp %module-level-mnemonic: content
```

Compared with the default log format, an asterisk (*) is missing in front of the timestamp, and a colon (:) is missing at the end of the timestamp in the standard log format.

✚ Enabling the Private Log Format

By default, logs are displayed in the following format:

```
*timestamp: %module-level-mnemonic: content
```

Run the **service private-syslog** command in global configuration mode to enable the private log format and logs are displayed in the following format:

```
timestamp module-level-mnemonic: content
```

Compared with the default log format, an asterisk (*) is missing in front of the timestamp, a colon (:) is missing at the end of the timestamp, and a percent sign (%) is missing at the end of the module name in the private log format.

18.3.3 Logging Direction

Configure parameters for sending syslogs in different directions, including the Console, monitor terminal, buffer, the log server, and log files.

Related Configuration

✚ Synchronizing User Input with Log Output

By default, this function is disabled.

Run the **logging synchronous** command in line configuration mode to synchronize user input with log output. After this function is enabled, user input will not be interrupted.

✚ Configuring the Log Rate Limit

By default, no log rate limit is configured.

Run the **logging rate-limit** { *number* | **all** *number* | **console** {*number* | **all** *number* } } [**except** [*severity*]] command in global configuration mode to configure the log rate limit.

✚ Configuring the Log Redirection Rate Limit

By default, a maximum of 200 logs are redirected from the standby device to the active device of VSU per second.

Run the **logging rd rate-limit** *number* [**except** *severity*] command in global configuration mode to configure the log redirection rate limit, that is, the maximum number of logs that are redirected from the standby device to the active device or from the standby supervisor module to the active supervisor module per second.

✚ Configuring the Level of Logs Sent to the Console

By default, the level of logs sent to the Console is debugging (Level 7).

Run the **logging console** [*level*] command in global configuration mode to configure the level of logs that can be sent to the Console.

➤ Sending Logs to the Monitor Terminal

By default, it is not allowed to send logs to the monitor terminal.

Run the **terminal monitor** command in the privileged EXEC mode to send logs to the monitor terminal.

➤ Configuring the Level of Logs Sent to the Monitor Terminal

By default, the level of logs sent to the monitor terminal is debugging (Level 7).

Run the **logging monitor [level]** command in global configuration mode to configure the level of logs that can be sent to the monitor terminal.

➤ Writing Logs into the Memory Buffer

By default, logs are written into the memory buffer, and the default level of logs is debugging (Level 7).

Run the **logging buffered [buffer-size] [level]** command in global configuration mode to configure parameters for writing logs into the memory buffer, including the buffer size and log level.

➤ Sending Logs to the Log Server

By default, logs are not sent to the log server.

Run the **logging server [oob] { ip-address | ipv6 ipv6-address } [via mgmt-name] [udp-port port]** command in global configuration mode to send logs to a specified log server.

Run the **logging server [oob] hostname [via mgmt-name] [udp-port port]** command in global configuration mode to send logs to a specified log server by configuring the hostname.

➤ Configuring the Level of Logs Sent to the Log Server

By default, the level of logs sent to the log server is informational (Level 6).

Run the **logging trap [level]** command in global configuration mode to configure the level of logs that can be sent to the log server.

➤ Configuring the Facility Value of Logs Sent to the Log Server

Run the **logging facility facility-type** command in global configuration mode to configure the facility value of logs sent to the log server.

➤ Configuring the Source Address of Logs Sent to the Log Server

By default, the source address of logs sent to the log server is the IP address of the interface sending logs.

Run the **logging source [interface] interface-type interface-number** command to configure the source interface of logs. If this source interface is not configured, or the IP address is not configured for this source interface, the source address of logs is the IP address of the interface sending logs.

Run the **logging source { ip ip-address | ipv6 ipv6-address }** command to configure the source IP address of logs. If this IP address is not configured on the device, the source address of logs is the IP address of the interface sending logs.

➤ Writing Logs into Log Files

By default, logs are not written into log files. After the function of writing logs into log files is enabled, the level of logs written into log files is informational (Level 6) by default.

Run the **logging file** `{flash:filename | usb0:filename | usb1:filename } [max-file-size] [level]` command in global configuration mode to configure parameters for writing logs into log files, including the type of device where the file is stored, file name, file size, and log level.

↘ **Configuring the Number of Log Files**

By default, the number of log files is 16.

Run the **logging file numbers** `numbers` command in global configuration mode to configure the number of log files.

↘ **Configuring the Interval at Which Logs Are Written into Log Files**

By default, logs are written into log files at the interval of 3600s (one hour).

Run the **logging flash interval** `seconds` command in global configuration mode to configure the interval at which logs are written into log files.

↘ **Configuring the Storage Time of Log Files**

By default, the storage time is not configured.

Run the **logging life-time level** `level days` command in global configuration mode to configure the storage time of logs. The administrator can specify different storage days for logs of different levels.

↘ **Immediately Writing Logs in the Buffer into Log Files**

By default, syslog messages are stored in the syslog buffer and then written into log files periodically or when the buffer is full.

Run the **logging flash flush** command in global configuration mode to immediately write logs in the buffer into log files so that you can collect logs conveniently.

18.3.4 Syslog Filtering

By default, logs generated by the system are sent in all directions.

Working Principle

↘ **Filtering Direction**

Five log filtering directions are defined:

- **buffer:** Filters out logs sent to the log buffer, that is, logs displayed by the **show logging** command.
- **file:** Filters out logs written into log files.
- **server:** Filters out logs sent to the log server.
- **terminal:** Filters out logs sent to the Console and monitor terminal (including Telnet and SSH).

The four filtering directions can be used either in combinations to filter out logs sent in various directions, or separately to filter out logs sent in a single direction.

↘ **Filtering Mode**

Two filtering modes are available:

- **contains-only:** Indicates that only logs that contain keywords specified in the filtering rules are output. You may be interested in only a specified type of logs. In this case, you can apply the contains-only mode on the device to display only logs that match filtering rules on the terminal, helping you check whether any event occurs.
- **filter-only:** Indicates that logs that contain keywords specified in the filtering rules are filtered out and will not be output. If a module generates too many logs, spamming may occur on the terminal interface. If you do not care about this type of logs, you can apply the filter-only mode and configure related filtering rules to filter out logs that may cause spamming.

The two filtering modes are mutually exclusive, that is, you can configure only one filtering mode at a time.

📌 Filter Rule

Two filtering rules are available:

- **exact-match:** If exact-match is selected, you must select all the three filtering options (module, level, and mnemonic). If you want to filter out a specified log, use the exact-match filtering rule.
- **single-match:** If exact-match is selected, you only need to select one of the three filtering options (module, level, and mnemonic). If you want to filter out a specified type of logs, use the single-match filtering rule.

If the same module, level, or mnemonic is configured in both the single-match and exact-match rules, the single-match rule prevails over the exact-match rule.

Related Configuration

📌 Configuring the Log Filtering Direction

By default, the log filtering direction is all, that is, logs sent in all directions are filtered.

Run the **logging filter direction { all | buffer | file | server | terminal }** command in global configuration mode to configure the log filtering direction to filter out logs in the specified directions.

📌 Configuring the Log Filtering Mode

By default, the log filtering mode is filter-only.

Run the **logging filter type { contains-only | filter-only }** command in global configuration mode to configure the log filtering mode.

📌 Configuring the Log Filtering Rule

By default, no log filtering rule is configured on a device, that is, logs are not filtered out.

Run the **logging filter rule exact-match module *module-name* mnemonic *mnemonic-name* level *level*** command in global configuration mode to configure the exact-match rule.

Run the **logging filter rule single-match { level *level* | mnemonic *mnemonic-name* | module *module-name* }** command in global configuration mode to configure the single-match rule.

18.3.5 Syslog Monitoring

After syslog monitoring is enabled, the system monitors the access attempts of users and generates the related logs.

Working Principle

After logging of login/exit attempts is enabled, the system records the access attempts of users. The log contains user name and source address.

After logging of operations is enabled, the system records changes in device configurations, The log contains user name, source address, and operation.

Related Configuration

📌 **Enabling Logging of Login or Exit Attempts**

By default, a device does not generate logs when users access or exit the device.

Run the **logging userinfo** command in global configuration mode to enable logging of login/exit attempts. After this function is enabled, the device displays logs when users access the devices through Telnet, SSH, or HTTP so that the administrator can monitor the device connections.

📌 **Enabling Logging of Operations**

By default, a device does not generate logs when users modify device configurations.

Run the **logging userinfo command-log** command in global configuration mode to enable logging of operations. After this function is enabled, the system displays related logs to notify the administrator of configuration changes.

18.4 Configuration

Configuration	Description and Command	
Configuring Syslog Format	⚠️ (Optional) It is used to configure the syslog format.	
	service timestamps [message-type [uptime] datetime [msec] [year]]	Configures the timestamp format of syslogs.
	service sysname	Adds the sysname to the syslog.
	service sequence-numbers	Adds the sequence number to the syslog.
	service standard-syslog	Enables the standard syslog format.
	service private-syslog	Enables the private syslog format.
Sending Syslogs to the Console	⚠️ (Optional) It is used to configure parameters for sending syslogs to the Console.	
	logging on	Enables logging.
	logging count	Enables log statistics.
	logging console [level]	Configures the level of logs displayed on the Console.
	logging rate-limit { number all number console {number all number } } [except [severity]]	Configures the log rate limit.
Sending Syslogs to the Monitor Terminal	⚠️ (Optional) It is used to configure parameters for sending syslogs to the monitor terminal.	
	terminal monitor	Enables the monitor terminal to display logs.
	logging monitor [level]	Configures the level of logs displayed on the monitor terminal.
Writing Syslogs into the Memory Buffer	⚠️ (Optional) It is used to configure parameters for writing syslogs into the memory buffer.	
	logging buffered [buffer-size] [level]	Configures parameters for writing syslogs into the memory buffer, including the buffer size

Configuration	Description and Command	
		and log level.
Sending Syslogs to the Log Server	(Optional) It is used to configure parameters for sending syslogs to the log server.	
	logging server [oob] { ip-address ipv6 ipv6-address } [via mgmt-name] [udp-port port]	Sends logs to a specified log server.
	logging server [oob] hostname [via mgmt-name] [udp-port port]	
	logging trap [level]	Configures the level of logs sent to the log server.
	logging facility facility-type	Configures the facility value of logs sent to the log server.
	logging source [interface] interface-type interface-number	Configures the source interface of logs sent to the log server.
	logging source { ip ip-address ipv6 ipv6-address }	Configures the source address of logs sent to the log server.
Writing Syslogs into Log Files	(Optional) It is used to configure parameters for writing syslogs into a file.	
	logging file { flash:filename usb0:filename usb1:filename } [max-file-size] [level]	Configures parameters for writing syslogs into a file, including the file storage type, file name, file size, and log level.
	logging file numbers numbers	Configures the number of files which logs are written into. The default value is 16.
	logging flash interval seconds	Configures the interval at which logs are written into log files. The default value is 3600.
	logging life-time level level days	Configures the storage time of log files.
Configuring Syslog Filtering	(Optional) It is used to enable the syslog filtering function.	
	logging filter direction { all buffer file server terminal }	Configures the log filtering direction.
	logging filter type { contains-only filter-only }	Configures the log filtering mode.
	logging filter rule exact-match module module-name mnemonic mnemonic-name level level	Configures the exact-match filtering rule.
	logging filter rule single-match { level level mnemonic mnemonic-name module module-name }	Configures the single-match filtering rule.
Configuring Syslog Redirection	(Optional) It is used to enable the log redirection function.	
	logging rd on	Enables the log redirection function.
	logging rd rate-limit number [except severity]	Configures the log redirection rate limit.
Configuring Syslog Monitoring	(Optional) It is used to configure parameters of the syslog monitoring function .	
	logging userinfo	Enables logging of login/exit attempts.

Configuration	Description and Command	
	logging userinfo command-log	Enables logging of operations.
Synchronizing User Input with Log Output	 (Optional) It is used to synchronize the user input with log output.	
	logging synchronous	Synchronizes user input with log output.

18.4.1 Configuring Syslog Format

Configuration Effect

- Configure the format of syslogs.

Notes

↘ RFC3164 Log Format

- If the device does not have the real time clock (RTC), which is used to record the system absolute time, the device uses its startup time (uptime) as the syslog timestamp by default. If the device has the RTC, the device uses its absolute time (datetime) as the syslog timestamp by default.
- The log sequence number is a 6-digit integer. Each time a log is generated, the sequence number increases by one. Each time the sequence number increases from 000000 to 1,000,000, or reaches 2³², the sequence number starts from 000000 again.

Configuration Steps

↘ Configuring the Timestamp Format of Syslogs

- (Optional) By default, the datetime timestamp format is used.
- Unless otherwise specified, perform this configuration on the device to configure the timestamp format.

↘ Adding the Sysname to the Syslog

- (Optional) By default, the syslog does not contain the sysname.
- Unless otherwise specified, perform this configuration on the device to add the sysname to the syslog.

↘ Adding the Sequence Number to the Syslog

- (Optional) By default, the syslog does not contain the sequence number.
- Unless otherwise specified, perform this configuration on the device to add the sequence number to the syslog.

↘ Enabling the Standard Log Format

- (Optional) By default, the default log format is used.
- Unless otherwise specified, perform this configuration on the device to enable the standard log format.

↘ Enabling the Private Log Format

- (Optional) By default, the default log format is used.
- Unless otherwise specified, perform this configuration on the device to enable the private log format.

Verification

- Generate a syslog, and check the log format.

Related Commands

➤ **Configuring the Timestamp Format of Syslogs**

Command	service timestamps [<i>message-type</i> [uptime datetime [msec] [year]]]
Parameter	<i>message-type</i> : Indicates the log type. There are two log types: log and debug.
Description	uptime : Indicates the device startup time in the format of dd:hh:mm:ss, for example, 07:00:10:41. datetime : Indicates the current device time in the format of MM DD hh:mm:ss, for example, Jul 27 16:53:07. msec : Indicates that the current device time contains millisecond. year : Indicates that the current device time contains year.
Command Mode	Global configuration mode
Configuration Usage	Two syslog timestamp formats are available, namely, uptime and datetime. You can select a timestamp format as required.

➤ **Adding the Sysname to the Syslog**

Command	service sysname
Parameter	N/A
Description	
Command Mode	Global configuration mode
Configuration Usage	This command is used to add the sysname to the log to enable you to learn about the device that sends syslogs to the server.

➤ **Adding the Sequence Number to the Syslog**

Command	service sequence-numbers
Parameter	N/A
Description	
Command Mode	Global configuration mode
Configuration Usage	This command is used to add the sequence number to the log. The sequence number starts from 1. After the sequence number is added, you can learn clearly whether any log is lost and the generation sequence of logs.

➤ **Enabling the Standard Syslog Format**

Command	service standard-syslog
Parameter	N/A
Description	
Command Mode	Global configuration mode
Configuration Usage	By default, logs are displayed in the following format (default format): <div style="background-color: #f0f0f0; padding: 5px; margin: 5px 0;">*timestamp: %module-level-mnemonic: content</div> If the standard syslog format is enabled, logs are displayed in the following format: <div style="background-color: #f0f0f0; padding: 5px; margin: 5px 0;">timestamp %module-level-mnemonic: content</div>

	Compared with the default format, an asterisk (*) is missing in front of the timestamp, and a colon (:) is missing at the end of the timestamp in the standard log format.
--	--

➤ **Enabling the Private Syslog Format**

Command	service private-syslog
Parameter	N/A
Description	
Command Mode	Global configuration mode
Configuration Usage	<p>By default, logs are displayed in the following format (default format):</p> <pre>*timestamp: %module-level-mnemonic: content</pre> <p>If the private syslog format is enabled, logs are displayed in the following format:</p> <pre>timestamp module-level-mnemonic: content</pre> <p>Compared with the default format, an asterisk (*) is missing in front of the timestamp, a colon (:) is missing at the end of the timestamp, and a percent sign (%) is missing in front of the module name in the private log format.</p>

Configuration Example

➤ **Enabling the RFC3164 Log Format**

Scenario	<p>It is required to configure the timestamp format as follows:</p> <ol style="list-style-type: none"> 1. Enable the RFC3164 format. 2. Change the timestamp format to datetime and add the millisecond and year to the timestamp. 3. Add the sysname to the log. 4. Add the sequence number to the log.
Configuration Steps	<ul style="list-style-type: none"> ● Configure the syslog format. <pre>FS# configure terminal FS(config)# service timestamps log datetime year msec FS(config)# service timestamps debug datetime year msec FS(config)# service sysname FS(config)# service sequence-numbers</pre>
Verification	<p>After the timestamp format is configured, verify that new syslogs are displayed in the RFC3164 format.</p> <ul style="list-style-type: none"> ● Run the show logging config command to display the configuration. ● Enter or exit global configuration mode to generate a new log, and check the format of the timestamp in the new log. <pre>FS(config)#exit 001302: *Jun 14 2013 19:01:40.293: FS %SYS-5-CONFIG_I: Configured from console by admin on console FS#show logging config</pre>

	<pre> Syslog logging: enabled Console logging: level informational, 1306 messages logged Monitor logging: level informational, 0 messages logged Buffer logging: level informational, 1306 messages logged File logging: level informational, 121 messages logged File name:syslog_test.txt, size 128 Kbytes, have written 5 files Standard format:false Timestamp debug messages: datetime Timestamp log messages: datetime Sequence-number log messages: enable Sysname log messages: enable Count log messages: enable Trap logging: level informational, 121 message lines logged,0 fail </pre>
--	---

18.4.2 Sending Syslogs to the Console

Configuration Effect

- Send syslogs to the Console to facilitate the administrator to monitor the performance of the system.

Notes

- If too many syslogs are generated, you can limit the log rate to reduce the number of logs displayed on the Console.

Configuration Steps

↘ Enabling Logging

- (Optional) By default, the logging function is enabled.

↘ Enabling Log Statistics

- (Optional) By default, log statistics is disabled.
- Unless otherwise specified, perform this configuration on the device to enable log statistics.

↘ Configuring the Level of Logs Displayed on the Console

- (Optional) By default, the level of logs displayed on the Console is debugging (Level 7).
- Unless otherwise specified, perform this configuration on the device to configure the level of logs displayed on the Console.

↘ Configuring the Log Rate Limit

- (Optional) By default, the no rate limit is configured.
- Unless otherwise specified, perform this configuration on the device to limit the log rate.

Verification

- Run the **show logging config** command to display the level of logs displayed on the Console.

Related Commands

↘ **Enabling Logging**

Command	logging on
Parameter	N/A
Description	
Command Mode	Global configuration mode
Configuration Usage	By default, logging is enabled. Do not disable logging in general cases. If too many syslogs are generated, you can configure log levels to reduce the number of logs.

↘ **Enabling Log Statistics**

Command	logging count
Parameter	N/A
Description	
Command Mode	Global configuration mode
Configuration Usage	By default, log statistics is disabled. If log statistics is enabled, syslogs will be classified and counted. The system records the number of times a log is generated and the last time when the log is generated.

↘ **Configuring the Level of Logs Displayed on the Console**

Command	logging console [level]
Parameter	<i>level</i> : Indicates the log level.
Description	
Command Mode	Global configuration mode
Configuration Usage	By default, the level of logs displayed on the Console is debugging (Level 7). You can run the show logging config command in privileged EXEC mode to display the level of logs displayed on the Console.

↘ **Configuring the Log Rate Limit**

Command	logging rate-limit { number all number console {number all number} } [except [severity]]
Parameter	<i>number</i> : Indicates the maximum number of logs processed per second. The value ranges from 1 to 10,000.
Description	all : Indicates that rate limit is applied to all logs ranging from Level 0 to Level 7. console : Indicates the number of logs displayed on the Console per second. except severity : Rate limit is not applied to logs with a level equaling to or lower than the specified severity level. By default, the severity level is error (Level 3), that is, rate limit is not applied to logs of Level 3 or lower.
Command Mode	Global configuration mode
Configuration Usage	By default, no rate limit is configured.

Configuration Example

➤ **Sending Syslogs to the Console**

Scenario	<p>It is required to configure the function of displaying syslogs on the Console as follows:</p> <ol style="list-style-type: none"> 1. Enable log statistics. 2. Set the level of logs that can be displayed on the Console to informational (Level 6). 3. Set the log rate limit to 50.
Configuration Steps	<ul style="list-style-type: none"> ● Configure parameters for displaying syslogs on the Console.
	<pre style="background-color: #f0f0f0; padding: 5px;"> FS# configure terminal FS(config)# logging count FS(config)# logging console informational FS(config)# logging rate-limit console 50 </pre>
Verification	<ul style="list-style-type: none"> ● Run the show logging config command to display the configuration.
	<pre style="background-color: #f0f0f0; padding: 5px;"> FS(config)#show logging config Syslog logging: enabled Console logging: level informational, 1303 messages logged Monitor logging: level debugging, 0 messages logged Buffer logging: level debugging, 1303 messages logged File logging: level informational, 118 messages logged File name:syslog_test.txt, size 128 Kbytes, have written 5 files Standard format:false Timestamp debug messages: datetime Timestamp log messages: datetime Sequence-number log messages: enable Sysname log messages: enable Count log messages: enable Trap logging: level informational, 118 message lines logged,0 fail </pre>

18.4.3 Sending Syslogs to the Monitor Terminal

Configuration Effect

- Send syslogs to a remote monitor terminal to facilitate the administrator to monitor the performance of the system.

Notes

- If too many syslogs are generated, you can limit the log rate to reduce the number of logs displayed on the monitor terminal.

- By default, the current monitor terminal is not allowed to display logs after you access the device remotely. You need to manually run the **terminal monitor** command to allow the current monitor terminal to display logs.

Configuration Steps

➤ **Allowing the Monitor Terminal to Display Logs**

- (Mandatory) By default, the monitor terminal is not allowed to display logs.
- Unless otherwise specified, perform this operation on every monitor terminal connected to the device.

➤ **Configuring the Level of Logs Displayed on the Monitor Terminal**

- (Optional) By default, the level of logs displayed on the monitor terminal is debugging (Level 7).
- Unless otherwise specified, perform this configuration on the device to configure the level of logs displayed on the monitor terminal.

Verification

- Run the **show logging config** command to display the level of logs displayed on the monitor terminal.

Related Commands

➤ **Allowing the Monitor Terminal to Display Logs**

Command	terminal monitor
Parameter	N/A
Description	
Command Mode	Privileged EXEC mode
Configuration Usage	By default, the current monitor terminal is not allowed to display logs after you access the device remotely. You need to manually run the terminal monitor command to allow the current monitor terminal to display logs.

➤ **Configuring the Level of Logs Displayed on the Monitor Terminal**

Command	logging monitor [level]
Parameter Description	<i>level</i> : Indicates the log level.
Command Mode	Global configuration mode
Configuration Usage	By default, the level of logs displayed on the monitor terminal is debugging (Level 7). You can run the show logging config command in privileged EXEC mode to display the level of logs displayed on the monitor terminal.

Configuration Example

➤ **Sending Syslogs to the Monitor Terminal**

Scenario	It is required to configure the function of displaying syslog on the monitor terminal as follows: 1. Display logs on the monitor terminal. 2. Set the level of logs that can be displayed on the monitor terminal to informational (Level 6).

Configuration Steps	<ul style="list-style-type: none"> Configure parameters for displaying syslogs on the monitor terminal. <pre> FS# configure terminal FS(config)# logging monitor informational FS(config)# line vty 0 4 FS(config-line)# monitor </pre>
Verification	<ul style="list-style-type: none"> Run the show logging config command to display the configuration. <pre> FS#show logging config Syslog logging: enabled Console logging: level informational, 1304 messages logged Monitor logging: level informational, 0 messages logged Buffer logging: level debugging, 1304 messages logged File logging: level informational, 119 messages logged File name:syslog_test.txt, size 128 Kbytes, have written 5 files Standard format:false Timestamp debug messages: datetime Timestamp log messages: datetime Sequence-number log messages: enable Sysname log messages: enable Count log messages: enable Trap logging: level informational, 119 message lines logged,0 fail </pre>

Common Errors

- To disable this function, run the **terminal no monitor** command, instead of the **no terminal monitor** command.

18.4.4 Writing Syslogs into the Memory Buffer

Configuration Effect

- Write syslogs into the memory buffer so that the administrator can view recent syslogs by running the **show logging** command.

Notes

- If the buffer is full, old logs will be overwritten by new logs that are written into the memory buffer.

Configuration Steps

✚ Writing Logs into the Memory Buffer

- (Optional) By default, the system writes logs into the memory buffer, and the default level of logs is debugging (Level 7).

- Unless otherwise specified, perform this configuration on the device to write logs into the memory buffer.

Verification

- Run the **show logging config** command to display the level of logs written into the memory buffer.
- Run the **show logging** command to display the level of logs written into the memory buffer.

Related Commands

📄 **Writing Logs into the Memory Buffer**

Command	logging buffered [<i>buffer-size</i>] [<i>level</i>]
Parameter	<i>buffer-size</i> : Indicates the size of the memory buffer.
Description	<i>level</i> : Indicates the level of logs that can be written into the memory buffer.
Command Mode	Global configuration mode
Configuration	By default, the level of logs written into the memory buffer is debugging (Level 7).
Usage	Run the show logging command in privileged EXEC mode to display the level of logs written into the memory buffer and the buffer size.

Configuration Example

📄 **Writing Syslogs into the Memory Buffer**

Scenario	It is required to configure the function of writing syslogs into the memory buffer as follows: 1. Set the log buffer size to 128 KB (131,072 bytes). 2. Set the information level of logs that can be written into the memory buffer to informational (Level 6).
Configuration Steps	<ul style="list-style-type: none"> ● Configure parameters for writing syslogs into the memory buffer. <pre>FS# configure terminal FS(config)# logging buffered 131072 informational</pre>
Verification	<ul style="list-style-type: none"> ● Run the show logging config command to display the configuration and recent syslogs. <pre>FS#show logging Syslog logging: enabled Console logging: level informational, 1306 messages logged Monitor logging: level informational, 0 messages logged Buffer logging: level informational, 1306 messages logged File logging: level informational, 121 messages logged File name:syslog_test.txt, size 128 Kbytes, have written 5 files Standard format:false Timestamp debug messages: datetime</pre>

Scenario	It is required to configure the function of writing syslog into the memory buffer as follows: 1. Set the log buffer size to 128 KB (131,072 bytes). 2. Set the information level of logs that can be written into the memory buffer to informational (Level 6).
Configuration Steps	<ul style="list-style-type: none"> Configure parameters for writing syslog into the memory buffer.
	<pre>FS# configure terminal FS(config)# logging buffered 131072 informational</pre>
Verification	<ul style="list-style-type: none"> Run the show logging config command to display the configuration and recent syslog.
	<pre>Timestamp log messages: datetime Sequence-number log messages: enable Sysname log messages: enable Count log messages: enable Trap logging: level informational, 121 message lines logged,0 fail Log Buffer (Total 131072 Bytes): have written 4200 001301: *Jun 14 2013 19:01:09.488: FS %SYS-5-CONFIG_I: Configured from console by admin on console 001302: *Jun 14 2013 19:01:40.293: FS %SYS-5-CONFIG_I: Configured from console by admin on console //Logs displayed are subject to the actual output of the show logging command.</pre>

18.4.5 Sending Syslogs to the Log Server

Configuration Effect

- Send syslog to the log server to facilitate the administrator to monitor logs on the server.

Notes

- If the device has a MGMT interface and is connected to the log server through the MGMT interface, you must add the **oob** option (indicating that syslog are sent to the log server through the MGMT interface) when configuring the **logging server** command.
- To send logs to the log server, you must add the timestamp and sequence number to logs. Otherwise, the logs are not sent to the log server.

Configuration Steps

➤ Sending Logs to a Specified Log Server

- (Mandatory) By default, syslog are not sent to any log server.
- Unless otherwise specified, perform this configuration on every device.

➤ Configuring the Level of Logs Sent to the Log Server

- (Optional) By default, the level of logs sent to the log server is informational (Level 6).

- Unless otherwise specified, perform this configuration on the device to configure the level of logs sent to the log server.

➤ **Configuring the Facility Value of Logs Sent to the Log Server**

- Unless otherwise specified, perform this configuration on the device to configure the facility value of logs sent to the log server.

➤ **Configuring the Source Interface of Logs Sent to the Log Server**

- (Optional) By default, the source interface of logs sent to the log server is the interface sending the logs.
- Unless otherwise specified, perform this configuration on the device to configure the source interface of logs sent to the log server.

➤ **Configuring the Source Address of Logs Sent to the Log Server**

- (Optional) By default, the source address of logs sent to the log server is the IP address of the interface sending the logs.
- Unless otherwise specified, perform this configuration on the device to configure the source address of logs sent to the log server.

Verification

- Run the **show logging config** command to display the configurations related to the log server.

Related Commands

➤ **Sending Logs to a Specified Log Server**

Command	logging server [oob] { <i>hostname</i> <i>ip-address</i> ipv6 <i>ipv6-address</i> } [via <i>mgmt-name</i>] [udp-port <i>port</i>] [vrf <i>vrf-name</i>] [facility <i>facility-type</i>] [level <i>level</i>] Or logging { <i>ip-address</i> ipv6 <i>ipv6-address</i> } [udp-prot <i>port</i>] [vrf <i>vrf-name</i>]
Parameter Description	oob : Indicates that logs are sent to the log server through the MGMT interface. <i>hostname</i> : Specifies the hostname of the host that receives log information. <i>ip-address</i> : Specifies the IP address of the host that receives logs. ipv6 <i>ipv6-address</i> : Specifies the IPv6 address of the host that receives logs. via <i>mgmt-name</i> : Specifies the MGMT interface used by the log server when the oob option is included in the command. vrf <i>vrf-name</i> : Specifies the VPN routing and forwarding (VRF) instance connected to the log server. udp-port <i>port</i> : Specifies the port ID of the log server. The default port ID is 514. facility <i>facility-type</i> : If the RFC5424 log format is disabled, the facility value of logs sent to the log server is local7 (23) by default. If the RFC5424 log format is enabled, the facility value of logs sent to the log server is local0 (16) by default. level <i>level</i> : Level of the logs allowed to be received by the host (Default level: informational).
Command Mode	Global configuration mode
Configuration Usage	This command is used to specify the address of the log server that receives logs. You can specify multiple log servers, and logs will be sent simultaneously to all these log servers. You can specify via only when oob is included in the command. In this case, vrf cannot be used. You cannot configure the server by running the logging <i>hostname</i> name. You can configure up to five log servers on a FS product.

✚ Configuring the Level of Logs Sent to the Log Server

Command	logging trap [<i>level</i>]
Parameter	<i>level</i> : Indicates the log level.
Description	
Command Mode	Global configuration mode
Configuration Usage	By default, the level of logs sent to the log server is informational (Level 6). You can run the show logging config command in privileged EXEC mode to display the level of logs sent to the log server. If the device supports log level settings on the server, the sever settings will prevail.

✚ Configuring the Facility Value of Logs Sent to the Log Server

Command	logging facility <i>facility-type</i>
Parameter	<i>facility-type</i> : Indicates the facility value of logs.
Description	
Command Mode	Global configuration mode
Configuration Usage	N/A

✚ Configuring the Source Interface of Logs Sent to the Log Server

Command	logging source [interface] <i>interface-type interface-number</i>
Parameter	<i>interface-type</i> : Indicates the interface type.
Description	<i>interface-number</i> : Indicates the interface number.
Command Mode	Global configuration mode
Configuration Usage	By default, the source interface of logs sent to the log server is the interface sending the logs. To facilitate management, you can use this command to set the source interface of all logs to an interface so that the administrator can identify the device that sends the logs based on the unique address.

✚ Configuring the Source Address of Logs Sent to the Log Server

Command	logging source { ip <i>ip-address</i> ipv6 <i>ipv6-address</i> }
Parameter	ip <i>ip-address</i> : Specifies the source IPv4 address of logs sent to the IPv4 log server.
Description	ipv6 <i>ipv6-address</i> : Specifies the source IPv6 address of logs sent to the IPv6 log server.
Command Mode	Global configuration mode
Configuration Usage	By default, the source IP address of logs sent to the log server is the IP address of the interface sending the logs. To facilitate management, you can use this command to set the source IP address of all logs to the IP address of an interface so that the administrator can identify the device that sends the logs based on the unique address..

Configuration Example

✚ Sending Syslogs to the Log Server

<p>Scenario</p>	<p>It is required to configure the function of sending syslogs to the log server as follows:</p> <ol style="list-style-type: none"> 1. Set the IPv4 address of the log server to 10.1.1.100. 2. Set the level of logs that can be sent to the log server to debugging (Level 7). 3. Set the source interface to Loopback 0.
<p>Configuration Steps</p>	<ul style="list-style-type: none"> ● Configure parameters for sending syslogs to the log server.
	<pre style="background-color: #f0f0f0; padding: 5px;"> FS# configure terminal FS(config)# logging server 10.1.1.100 FS(config)# logging trap debugging FS(config)# logging source interface Loopback 0 </pre>
<p>Verification</p>	<ul style="list-style-type: none"> ● Run the show logging config command to display the configuration.
	<pre style="background-color: #f0f0f0; padding: 5px;"> FS#show logging config Syslog logging: enabled Console logging: level informational, 1307 messages logged Monitor logging: level informational, 0 messages logged Buffer logging: level informational, 1307 messages logged File logging: level informational, 122 messages logged File name:syslog_test.txt, size 128 Kbytes, have written 5 files Standard format:false Timestamp debug messages: datetime Timestamp log messages: datetime Sequence-number log messages: enable Sysname log messages: enable Count log messages: enable Trap logging: level debugging, 122 message lines logged,0 fail logging to 10.1.1.100 </pre>

18.4.6 Writing Syslogs into Log Files

Configuration Effect

- Write syslogs into log files at the specified interval so that the administrator can view history logs anytime on the local device.

Notes

- Syslogs are not immediately written into log files. They are first buffered in the memory buffer, and then written into log files either periodically (at the interval of one hour by default) or when the buffer is full.

Configuration Steps

➤ **Writing Logs into Log Files**

- (Mandatory) By default, syslogs are not written to any log file.
- Unless otherwise specified, perform this configuration on every device.

➤ **Configuring the Number of Log Files**

- (Optional) By default, syslogs are written to 16 log files.

➤ **Unless otherwise specified, perform this configuration on the device to configure the number of files which logs are written into. Configuring the Interval at Which Logs Are Written into Log Files**

- (Optional) By default, syslogs are written to log files every hour.
- Unless otherwise specified, perform this configuration on the device to configure the interval at which logs are written into log files.

➤ **Configuring the Storage Time of Log Files**

- (Optional) By default, no storage time is configured.
- Unless otherwise specified, perform this configuration on the device to configure the storage time of log files.

➤ **Immediately Writing Logs in the Buffer into Log Files**

- (Optional) By default, syslogs are stored in the buffer and then written into log files periodically or when the buffer is full.
- Unless otherwise specified, perform this configuration to write logs in the buffer into log files immediately. This command takes effect only once after it is configured.

Verification

- Run the **show logging config** command to display the configurations related to the log server.

Related Commands

➤ **Writing Logs into Log Files**

Command	logging file { flash:filename usb0:filename usb1:filename } [<i>max-file-size</i>] [<i>level</i>]
Parameter Description	<p>flash: Indicates that log files will be stored on the extended Flash.</p> <p>usb0: Indicates that log files will be stored on USB 0. This option is supported only when the device has one USB port and a USB flash drive is inserted into the USB port.</p> <p>usb1: Indicates that log files will be stored on USB 1. This option is supported only when the device has two USB ports and USB flash drives are inserted into the USB ports.</p> <p><i>filename:</i> Indicates the log file name, which does not contain a file name extension. The file name extension is always txt.</p> <p><i>max-file-size:</i> Indicates the maximum size of a log file. The value ranges from 128 KB to 6 MB. The default value is 128 KB.</p> <p><i>level:</i> Indicates the level of logs that can be written into a log file.</p>
Command	Global configuration mode

Mode	
Configuration Usage	<p>This command is used to create a log file with the specified file name on the specified file storage device. The file size increases with the amount of logs, but cannot exceed the configured maximum size. If not specified, the maximum size of a log file is 128 KB by default.</p> <p>After this command is configured, the system saves logs to log files. A log file name does not contain any file name extension. The file name extension is always txt, which cannot be changed.</p> <p>After this command is configured, logs will be written into log files every hour. If you run the logging file flash:syslog command, a total of 16 log files will be created, namely, syslog.txt, syslog_1.txt, syslog_2.txt, ..., syslog_14.txt, and syslog_15.txt. Logs are written into the 16 log files in sequence. For example, the system writes logs into syslog_1.txt after syslog.txt is full. When syslog_15.txt is full, logs are written into syslog.txt again,</p>

📌 **Configuring the Number of Log Files**

Command	logging file numbers <i>numbers</i>
Parameter Description	<i>numbers</i> : Indicates the number of log files. The value ranges from 2 to 32.
Command Mode	Global configuration mode
Configuration Usage	<p>This command is used to configure the number of log files.</p> <p>If the number of log files is modified, the system will not delete the log files that have been generated. Therefore, you need to manually delete the existing log files to save the space of the extended flash. (Before deleting existing log files, you can transfer these log files to an external server through TFTP.) For example, after the function of writing logs into log files is enabled, 16 log files will be created by default. If the device has generated 16 log files and you change the number of log files to 2, new logs will be written into syslog.txt and syslog_1.txt by turns. The existing log files from syslog_2.txt to syslog_15.txt will be preserved. You can manually delete these log files.</p>

📌 **Configuring the Interval at Which Logs Are Written into Log Files**

Command	logging flash interval <i>seconds</i>
Parameter Description	<i>seconds</i> : Indicates the interval at which logs are written into log files. The value ranges from 1s to 51,840s.
Command Mode	Global configuration mode
Configuration Usage	This command is used to configure the interval at which logs are written into log files. The countdown starts after the command is configured.

📌 **Configuring the Storage Time of Log Files**

Command	logging life-time level <i>level days</i>
Parameter Description	<p><i>level</i>: Indicates the log level.</p> <p><i>days</i>: Indicates the storage time of log files. The unit is day. The storage time is not less than seven days.</p>
Command Mode	Global configuration mode
Configuration Usage	After the log storage time is configured, the system writes logs of the same level that are generated in the same day into the same log file. The log file is named yyyy-mm-dd_filename_level.txt , where yyyy-mm-dd is the absolute time of the day when the logs are generated, filename is the log file named configured by the logging file flash command, and level is the log level.

	<p>After you specify the storage time for logs of a certain level, the system deletes the logs after the storage time expires. Currently, the storage time ranges from 7days to 365 days.</p> <p>If the log storage time is not configured, logs are stored based on the file size to ensure compatibility with old configuration commands.</p>
--	---

➤ **Immediately Writing Logs in the Buffer into Log Files**

Command	logging flash flush
Parameter	N/A
Description	
Command Mode	Global configuration mode
Configuration Usage	<p>After this command is configured, syslogs are stored in the buffer and then written into log files periodically or when the buffer is full. You can run this command to immediately write logs into log files.</p> <p> The logging flash flush command takes effect once after it is configured. That is, after this command is configured, logs in the buffer are immediately written to log files.</p>

Configuration Example

➤ **Writing Syslogs into Log Files**

Scenario	<p>It is required to configure the function of writing syslogs into log files as follows:</p> <ol style="list-style-type: none"> 1. Set the log file name to syslog. 2. Set the level of logs sent to the Console to debugging (Level 7). 3. Set the interval at which device logs are written into files to 10 minutes (600s).
Configuration Steps	<ul style="list-style-type: none"> ● Configure parameters for writing syslogs into log files. <pre> FS# configure terminal FS(config)# logging file flash:syslog debugging FS(config)# logging flash interval 600 </pre>
Verification	<ul style="list-style-type: none"> ● Run the show logging config command to display the configuration. <pre> FS(config)#show logging config Syslog logging: enabled Console logging: level informational, 1307 messages logged Monitor logging: level informational, 0 messages logged Buffer logging: level informational, 1307 messages logged File logging: level debugging, 122 messages logged File name:syslog.txt, size 128 Kbytes, have written 1 files Standard format:false </pre>

Scenario	<p>It is required to configure the function of writing syslogs into log files as follows:</p> <ol style="list-style-type: none"> 1. Set the log file name to syslog. 2. Set the level of logs sent to the Console to debugging (Level 7). 3. Set the interval at which device logs are written into files to 10 minutes (600s).
Configuration Steps	<ul style="list-style-type: none"> ● Configure parameters for writing syslogs into log files.
	<pre style="background-color: #f0f0f0; padding: 5px;"> FS# configure terminal FS(config)# logging file flash:syslog debugging FS(config)# logging flash interval 600 </pre>
Verification	<ul style="list-style-type: none"> ● Run the show logging config command to display the configuration.
	<pre style="background-color: #f0f0f0; padding: 5px;"> Timestamp debug messages: datetime Timestamp log messages: datetime Sequence-number log messages: enable Sysname log messages: enable Count log messages: enable Trap logging: level debugging, 122 message lines logged,0 fail logging to 10.1.1.100 </pre>

18.4.7 Configuring Syslog Filtering

Configuration Effect

- Filter out a specified type of syslogs if the administrator does not want to display these syslogs.
- By default, logs generated by all modules are displayed on the Console or other terminals. You can configure log filtering rules to display only desired logs.

Notes

- Two filtering modes are available: contains-only and filter-only. You can configure only one filtering mode at a time.
- If the same module, level, or mnemonic is configured in both the single-match and exact-match rules, the single-match rule prevails over the exact-match rule.

Configuration Steps

↘ Configuring the Log Filtering Direction

- (Optional) By default, the filtering direction is all, that is, all logs are filtered out.
- Unless otherwise specified, perform this configuration on the device to configure the log filtering direction.

↘ Configuring the Log Filtering Mode

- (Optional) By default, the log filtering mode is filter-only.

- Unless otherwise specified, perform this configuration on the device to configure the log filtering mode.

📌 Configuring the Log Filtering Rule

- (Mandatory) By default, no filtering rule is configured.
- Unless otherwise specified, perform this configuration on the device to configure the log filtering rule.

Verification

- Run the **show running** command to display the configuration.

Related Commands

📌 Configuring the Log Filtering Direction

Command	logging filter direction { all buffer file server terminal }
Parameter	all : Filters out all logs.
Description	buffer : Filters out logs sent to the log buffer, that is, the logs displayed by the show logging command. file : Filters out logs written into log files. server : Filters out logs sent to the log server. terminal : Filters out logs sent to the Console and VTY terminal (including Telnet and SSH).
Command Mode	Global configuration mode
Configuration	The default filtering direction is all , that is, all logs are filtered out.
Usage	Run the default logging filter direction command to restore the default filtering direction.

📌 Configuring the Log Filtering Mode

Command	logging filter type { contains-only filter-only }
Parameter	contains-only : Indicates that only logs that contain keywords specified in the filtering rules are displayed.
Description	filter-only : Indicates that logs that contain keywords specified in the filtering rules are filtered out and will not be displayed.
Command Mode	Global configuration mode
Configuration	Log filtering modes include contains-only and filter-only. The default filtering mode is filter-only.
Usage	

📌 Configuring the Log Filtering Rule

Command	logging filter rule { exact-match module <i>module-name</i> mnemonic <i>mnemonic-name</i> level <i>level</i> single-match { level <i>level</i> mnemonic <i>mnemonic-name</i> module <i>module-name</i> } }
Parameter	exact-match : If exact-match is selected, you must specify all three filtering options.
Description	single-match : If single-match is selected, you may specify only one of the three filtering options. module <i>module-name</i> : Indicates the module name. Logs of this module will be filtered out. mnemonic <i>mnemonic-name</i> : Indicates the mnemonic. Logs with this mnemonic will be filtered out. level <i>level</i> : Indicates the log level. Logs of this level will be filtered out.
Command Mode	Global configuration mode
Configuration	Log filtering rules include exact-match and single-match.

Usage	<p>The no logging filter rule exact-match [module <i>module-name</i> mnemonic <i>mnemonic-name</i> level <i>level</i>] command is used to delete the exact-match filtering rules. You can delete all exact-match filtering rules at a time or one by one.</p> <p>The no logging filter rule single-match [level <i>level</i> mnemonic <i>mnemonic-name</i> module <i>module-name</i>] command is used to delete the single-match filtering rules. You can delete all single-match filtering rules at a time or one by one.</p>
--------------	--

Configuration Example

▾ Configuring Syslog Filtering

Scenario	<p>It is required to configure the syslog filtering function as follows:</p> <ol style="list-style-type: none"> 1. Set the filtering directions of logs to terminal and server. 2. Set the log filtering mode to filter-only. 3. Set the log filtering rule to single-match to filter out logs that contain the module name "SYS".
Configuration Steps	<ul style="list-style-type: none"> ● Configure the syslog filtering function.
	<pre>FS# configure terminal FS(config)# logging filter direction server FS(config)# logging filter direction terminal FS(config)# logging filter type filter-only FS(config)# logging filter rule single-match module SYS</pre>
Verification	<ul style="list-style-type: none"> ● Run the show running-config include logging command to display the configuration. ● Enter and exit global configuration mode, and verify that the system displays logs accordingly.
	<pre>FS#configure Enter configuration commands, one per line. End with CNTL/Z. FS(config)#exit FS# FS#show running-config include logging logging filter direction server logging filter direction terminal logging filter rule single-match module SYS</pre>

18.4.8Configuring Syslog Redirection

Configuration Effect

- On the VSU, logs on the secondary or standby device are displayed on its Console window, and redirected to the active device for display on the Console or VTY window, or stored in the memory buffer, extended flash, or syslog server.
- On a box-type VSU, after the log redirection function is enabled, logs on the secondary or standby device will be redirected to the active device, and the role flag (*device ID) will be added to each log to indicate that the log is redirected. Assume that four

devices form a VSU. The ID of the active device is 1, the ID of the secondary device is 2, and the IDs of two standby devices are 3 and 4. The role flag is not added to logs generated by the active device. The role flag (*2) is added to logs redirected from the secondary device to the active device. The role flags (*3) and (*4) are added respectively to logs redirected from the two standby devices to the active device.

- On a card-type VSU, after the log redirection function is enabled, logs on the secondary or standby supervisor module will be redirected to the active supervisor module, and the role flag "(device ID/supervisor module name)" will be added to each log to indicate that the log is redirected. If four supervisor modules form a VSU, the role flags are listed as follows: (*1/M1), (*1/M2), (*2/M1), and (*2/M2).

Notes

- The syslog redirection function takes effect only on the VSU.
- You can limit the rate of logs redirected to the active device to prevent generating a large amount of logs on the secondary or standby device.

Configuration Steps

➤ **Enabling Log Redirection**

- (Optional) By default, log redirection is enabled on the VSU.
- Unless otherwise specified, perform this configuration on the active device of VSU or active supervisor module.

➤ **Configuring the Rate Limit**

- (Optional) By default, a maximum of 200 logs can be redirected from the standby device to the active device of VSU per second.
- Unless otherwise specified, perform this configuration on the active device of VSU or active supervisor module.

Verification

- Run the **show running** command to display the configuration.

Related Commands

➤ **Enabling Log Redirection**

Command	logging rd on
Parameter	N/A
Description	
Command Mode	Global configuration mode
Configuration Usage	By default, log redirection is enabled on the VSU.

➤ **Configuring the Rate Limit**

Command	logging rd rate-limit <i>number</i> [except <i>level</i>]
Parameter Description	rate-limit <i>number</i> : Indicates the maximum number of logs redirected per second. The value ranges from 1 to 10,000. except <i>level</i> : Rate limit is not applied to logs with a level equaling to or lower than the specified severity level. By default, the severity level is error (Level 3), that is, rate limit is not applied to logs of Level 3 or lower.
Command	Global configuration mode

Mode	
Configuration Usage	By default, a maximum of 200 logs can be redirected from the standby device to the active device of VSU per second.

Configuration Example

↘ Configuring Syslog Redirection

Scenario	It is required to configure the syslog redirection function on the VSU as follows: 1. Enable the log redirection function. 2. Set the maximum number of logs with a level higher than critical (Level 2) that can be redirected per second to 100.
Configuration Steps	<ul style="list-style-type: none"> ● Configure the syslog redirection function. <pre>FS# configure terminal FS(config)# logging rd on FS(config)# logging rd rate-limit 100 except critical</pre>
Verification	<ul style="list-style-type: none"> ● Run the show running-config include logging command to display the configuration. ● Generate a log on the standby device, and verify that the log is redirected to and displayed on the active device. <pre>FS#show running-config include logging logging rd rate-limit 100 except critical</pre>

18.4.9 Configuring Syslog Monitoring

Configuration Effect

- Record login/exit attempts. After logging of login/exit attempts is enabled, the related logs are displayed on the device when users access the device through Telnet or SSH. This helps the administrator monitor the device connections.
- Record modification of device configurations. After logging of operations is enabled, the related logs are displayed on the device when users modify the device configurations. This helps the administrator monitor the changes in device configurations.

Notes

- If both the **logging userinfo** command and the **logging userinfo command-log** command are configured on the device, only the configuration result of the **logging userinfo command-log** command is displayed when you run the **show running-config** command.

Configuration Steps

↘ Enabling Logging of Login/Exit Attempts

- (Optional) By default, logging of login/exit attempts is disabled.
- Unless otherwise specified, perform this configuration on every line of the device to enable logging of login/exit attempts.

➤ **Enabling logging of Operations**

- (Optional) By default, logging of operations is disabled.
- Unless otherwise specified, perform this configuration on every line of the device to enable logging of operations.

Verification

- Run the **show running** command to display the configuration.

Related Commands

➤ **Enabling Logging of Login/Exit Attempts**

Command	logging userinfo
Parameter	N/A
Description	
Command Mode	Global configuration mode
Configuration Usage	By default, a device does not generate related logs when users log into or exit the device.

➤ **Enabling Logging of Operations**

Command	logging userinfo command-log
Parameter	N/A
Description	
Command Mode	Global configuration mode
Configuration Usage	The system generates related logs when users run configuration commands. By default, a device does not generate logs when users modify device configurations.

Configuration Example

➤ **Configuring Syslog Monitoring**

Scenario	It is required to configure the syslog monitoring function as follows: 1. Enable logging of login/exit attempts. 2. Enable logging of operations.
Configuration Steps	<ul style="list-style-type: none"> ● Configure the syslog monitoring function.
	<pre>FS# configure terminal FS(config)# logging userinfo FS(config)# logging userinfo command-log</pre>
Verification	<ul style="list-style-type: none"> ● Run the show running-config include logging command to display the configuration. ● Run a command in global configuration mode, and verify that the system generates a log.

Scenario	It is required to configure the syslog monitoring function as follows: <ol style="list-style-type: none"> 1. Enable logging of login/exit attempts. 2. Enable logging of operations.
Configuration Steps	<ul style="list-style-type: none"> ● Configure the syslog monitoring function.
	<pre>FS# configure terminal FS(config)# logging userinfo FS(config)# logging userinfo command-log</pre>
Verification	<ul style="list-style-type: none"> ● Run the show running-config include logging command to display the configuration. ● Run a command in global configuration mode, and verify that the system generates a log.
	<pre>FS#configure terminal Enter configuration commands, one per line. End with CNTL/Z. FS(config)#interface gigabitEthernet 0/0 *Jun 16 15:03:43: %CLI-5-EXEC_CMD: Configured from console by admin command: interface GigabitEthernet 0/0 FS#show running-config include logging logging userinfo command-log</pre>

18.4.10 Synchronizing User Input with Log Output

Configuration Effect

- By default, the user input is not synchronized with the log output. After this function is enabled, the content input during log output is displayed after log output is completed, ensuring integrity and continuity of the input.

Notes

- This command is executed in line configuration mode. You need to configure this command on every line as required.

Configuration Steps

↘ Synchronizing User Input with Log Output

- (Optional) By default, the synchronization function is disabled.
- Unless otherwise specified, perform this configuration on every line to synchronize user input with log output.

Verification

- Run the **show running** command to display the configuration.

Related Commands

↘ Synchronizing User Input with Log Output

Command	logging synchronous
----------------	----------------------------

Parameter	N/A
Description	
Command Mode	Line configuration mode
Configuration Usage	This command is used to synchronize the user input with log output to prevent interrupting the user input.

Configuration Example

📌 **Synchronizing User Input with Log Output**

Scenario	It is required to synchronize the user input with log output as follows: 1. Enable the synchronization function.
Configuration Steps	<ul style="list-style-type: none"> ● Configure the synchronization function. <pre>FS# configure terminal FS(config)# line console 0 FS(config-line)# logging synchronous</pre>
Verification	<ul style="list-style-type: none"> ● Run the show running-config begin line command to display the configuration. <pre>FS#show running-config begin line line con 0 logging synchronous login local</pre> <p>As shown in the following output, when a user types in "vlan", the state of interface 0/1 changes and the related log is output. After log output is completed, the log module automatically displays the user input "vlan" so that the user can continue typing.</p> <pre>FS(config)#vlan *Aug 20 10:05:19: %LINK-5-CHANGED: Interface GigabitEthernet 0/1, changed state to up *Aug 20 10:05:19: %LINEPROTO-5-UPDOWN: Line protocol on Interface GigabitEthernet 0/1, changed state to up FS(config)#vlan</pre>

18.5 Monitoring

Clearing

 Running the **clear** commands may lose vital information and thus interrupt services.

Description	Command
Clears logs in the memory buffer.	clear logging

Displaying

Description	Command
Displays log statistics and logs in the memory buffer based on the timestamp from oldest to latest.	show logging
Displays log statistics and logs in the memory buffer based on the timestamp from latest to oldest.	show logging reverse
Displays syslog configurations and statistics.	show logging config
Displays log statistics of each module in the system.	show logging count
Displays the last N logs.	show logging last

19 Configuring MONITOR

19.1 Overview

Smart monitoring is the smart hardware management of FS Network devices, including fan speed adjustment, and peripheral monitoring. The smart monitoring performs the following tasks:

- Automatic fan speed adjustment based on ambient temperature changes
- Real-time peripheral monitoring of boards to alert users, including fan status, power status and temperature monitoring.

By default, the smart monitoring function is enabled after the device is powered on. It does not require any manual configuration.

Protocol Specification

19.2N/Features

Basic Concepts

N/A

Features

Feature	Function
Smart Speed Adjustment of Fans and Monitoring	The rotating speed of fans is automatically adjusted as the temperature changes to address the heat dissipation needs of the system. The system monitors the fan status.
Smart Temperature Monitoring	The system automatically monitors the temperature. When the temperature exceeds a certain threshold, the system automatically generates an alarm. When the temperature exceeds the threshold greatly, the system will reboot.
Power Monitoring	The system automatically monitors the power. When the power is insufficient or cannot be identified, the system automatically generates an alarm.
Power Input Mode	DC/AC input mode is configured

19.2.1 Smart Speed Adjustment of Fans and Monitoring

As the ambient temperature rises or drops, the fans automatically raise or reduce their rotating speed to dissipate heat and ensure that the noise is low. The system monitors the fan status and displays fan status.

Working Principle

The system specifies a fan rotating speed. As the ambient temperature rises or drops, the fans automatically raise or reduce their rotating speed to dissipate heat and ensure that the noise is low.

The system checks the fan status periodically and displays fan status.

Verification

- Run the **show fan** command to display working status of all fans.
- Run the **show fan speed** command to display rotating speed.
- Run the **show fan attribute** command to display fan attribute.

19.2.2 Smart Temperature Monitoring

The system automatically monitors the temperature. When the temperature changes, the system automatically notifies users. When the temperature exceeds the threshold greatly, the system will reboot.

Working Principle

The system monitors the temperature once per minute. When the temperature exceeds a certain threshold, the system takes a certain action. The temperature and action vary with different devices.

Verification

Run the **show temperature** command to display system temperature.

19.2.3 Power Monitoring

The system checks power status periodically and displays power status.

Working Principle

The system checks power status periodically. If there is a power failure, an alarm will be generated.

The system checks fan channel of the power module. If the fan channel of the power module does not match with the fan channel of the system, an alarm will be generated.

Verification

Run the **show power** command to display power status.

20 Configuring PKG_MGMT

20.1 Overview

Package management (pkg_mgmt) is a package management and upgrade module. This module is responsible for installing, upgrading/degrading, querying and maintaining various components of the device, among which upgrade is the main function. Through upgrade, users can install new version of software that is more stable or powerful. Adopting a modular structure, the FSOS system not only supports overall upgrade and subsystem upgrade but also supports separate upgrade of a feature package. In addition, the FSOS system supports upgrade through hot patches.

✔ This document is for only version 11.0 and later, excluding those upgraded from earlier versions.

Protocols and Standards

N/A

20.2 Applications

Application	Scenario
Upgrading/Degrading Subsystem	Upgrade subsystem firmware like boot, kernel, and rootfs on the device.
Upgrading/Degrading a Single Feature Package	Upgrade a single feature package on the device.
Installing a Hot Patch Package	Install a hot patch, and repair a certain part of the feature component.
Auto-Sync for Upgrade	Configure the auto sync policy, range and path.

20.2.1 Upgrading/Degrading Subsystem

Scenario

After the upgrade of a subsystem firmware is complete, all system software on the device is updated, and the overall software is enhanced. Generally, the subsystem firmware of the box-type device is called main package.

The main features of this upgrade mode are as follows: All software on the device is updated after the upgrade is completed; all known software bugs are fixed. It takes a long time to finish upgrade.

Deployment

You can store the main package in the root directory of the TFTP server, download the package to the device, and then run an upgrade command to upgrade the package locally. You can also store the main package in a USB flash drive or SD card, connect the USB flash drive to the device, and then run an upgrade command to upgrade the package.

You must store the rack package in a USB flash drive before performing the upgrade because the rack package is too large to be stored in the memory space of the device.

20.2.2 Upgrading Subsystem by One-click

Scenario

Upgrade the firmware automatically without interrupting services on a dual-device VSU system. While either in VSU mode or in standalone mode, one single device will restart after this configuration, thus interrupting services.

Deployment

You can store the main package in the root directory of the TFTP server, download the package to the device, and then run an upgrade command to upgrade the package locally. You can also store the main package in a USB flash drive or SD card, connect the USB flash drive or SD card to the device, and then run an upgrade command to upgrade the package.

20.2.3 Upgrading/Degrading a Single Feature Package

Scenario

Device software consists of several components, and each component is an independent feature module. After an independent

feature package is upgraded, only the feature bug corresponding to this package is fixed. Besides, this feature is enhanced with the other features unchanged.

The features of this upgrade mode are as follows: Generally, a feature package is small and the upgrade speed is high. After the upgrade is completed, only the corresponding functional module is improved, and other functional modules remain unchanged.

Deployment

You can store this package in the root directory of the TFTP server, download the package to the local device, and then complete the upgrade. You can also store the package in a USB flash drive or SD card, connect the USB flash drive or SD card to the device, and then complete the upgrade.

20.2.4 Installing a Hot Patch Package

Scenario

To fix software bugs without restarting the device, you can install hot patch packages. Hot patch packages are only applicable to fixing a specific software version. Generally, hot patch packages are released to fix the software of a certain version only when the device cannot be started in the user's environment.

The most significant feature of hot patch upgrade is that all bugs can be fixed without device restart after the upgrade is completed.

Deployment

You can store this package in the root directory of the TFTP server, download the package to the local device, and then complete the upgrade. You can also store the package in a USB flash drive or SD card, connect the USB flash drive or SD card to the device, and then complete the upgrade.

20.2.5 Auto-Sync for Upgrade

Scenario

Auto-sync upgrade aims to ensure the coordination of multiple modules (line cards and chassis) within a system on a rack-type device or VSU. Specifically, the upgrade firmware is pushed to all target members automatically and the software version of new members is upgraded automatically based on the auto-sync policy.



Deployment

- Configure the policy for auto-sync upgrade.
- Configure the path of firmware for auto-sync upgrade.

20.3 Features

Basic Concepts



Subsystem

A subsystem exists on a device in the form of images. The subsystems of the FSOS include:

- **boot:** After being powered on, the device loads and runs the boot subsystem first. This subsystem is responsible for initializing the device, and loading and running system images.

- kernel: kernel is the OS core part of the system. This subsystem shields hardware composition of the system and provides applications with abstract running environment.
- rootfs: rootfs is the collection of applications in the system.

➤ **Main Package**

Main package is often used to upgrade/degrade a subsystem of the box-type device. The main package is a combination package of the boot, kernel, and rootfs subsystems. The main package can be used for overall system upgrade/degradation.

➤ **Feature Package of FSOS**

The feature package of FSOS refers to a collection which enables a certain feature. When the device is delivered, all supported functions are contained in the rootfs subsystem. You can upgrade only a specific feature by upgrading a single feature package.

 "Firmware" in this document refers to an installation file that contains a subsystem or feature module.

Overview

Feature	Description
Upgrading/Degrading and Managing Subsystem Components	Upgrades/degrades a subsystem.
Upgrading/Degrading and Managing Functional Components	Upgrades/degrades a functional component.
Auto-Sync for Upgrade	Ensures uniform upgrade upon member change.

20.3.1 Upgrading/Degrading and Managing Subsystem Components

Subsystem upgrade/degradation aims to upgrade the software by replacing the subsystem components of the device with the subsystem components in the firmware. The subsystem component contains redundancy design. Subsystems of the device are not directly replaced with the subsystems in the package during upgrade/degradation in most cases. Instead, subsystems are added to the device and then activated during upgrade/degradation.

Working Principle

➤ **Upgrade/Degradation**

Various subsystems exist on the device in different forms. Therefore, upgrade/degradation varies with different subsystems.

- boot: Generally, this subsystem exists on the norflash device in the form of images. Therefore, upgrading/degrading this subsystem is to write the image into the norflash device.
- kernel: This subsystem exists in a specific partition in the form of files. Therefore, upgrading/degrading this subsystem is to write the file.
- rootfs: Generally, this subsystem exists on the nandflash device in the form of images. Therefore, upgrading/degrading this subsystem is to write the image into the nandflash device.

➤ **Management**

Query the subsystem components that are available currently and then load subsystem components as required.

Each subsystem component contains redundancy design. During the upgrade/degradation:

- boot: The boot subsystem always contains a master boot subsystem and a slave boot subsystem. Only the master boot subsystem is involved in the upgrade, and the slave boot subsystem serves as the redundancy backup all along.
- kernel: as the kernel subsystem contains at least one redundancy backup. More redundancy backups are allowed if there is enough space.
- rootfs: The rootfs subsystem always contains a redundancy backup.

The boot component is not included in the scope of subsystem management due to its particularity. During upgrade of the kernel or rootfs subsystem component, the upgrade/degradation module always records the subsystem component in use, the redundant subsystem component, and management information about various versions.

Relevant Configuration

↳ Upgrade

- Store the upgrade file on the local device, and then run the **upgrade** command for upgrade.

20.3.2 Upgrading/Degrading and Managing Functional Components

Working Principle

In fact, upgrading a feature is replacing feature files on the device with the feature files in the package.

Managing feature components and hot patches is aimed at recording the information of feature components and hot patches by using a database. In fact, installing, displaying and uninstalling a component is the result of performing the Add, Query and Delete operation on the database.

After package upgrade, component upgrade cannot be performed.

Relevant Configuration

↳ Upgrade

- Store the upgrade file on the local device, and then run the **upgrade** command for upgrade.

20.3.3 Upgrading/Degrading and Managing Hot Patch Packages

Working Principle

In fact, upgrading a feature component is replacing feature files on the device with the feature files in the package.

Upgrading hot patch packages is similar to upgrading features. The difference is that only files to be revised are replaced during hot patch package upgrade. In addition, after the files are replaced, the new files take effect automatically.

After package upgrade, component upgrade cannot be performed.

↳ Management

Similar to feature component management, hot patch management also includes the query, installation, and uninstallation operation, which is the result of adding, querying and deleting data respectively.

Hot patches and feature components are managed based on the same technology. The difference is that the hot patches involve three different states, that is, Not installed, Installed, and Activated. These states are described as follows:

The hot patch in Installed state only indicates that this hot patch exists on the device, but it has not taken effect yet.

Only the hot patch in Activated state is valid.

Relevant Configuration

➤ Upgrade

- Store the upgrade file in the local file system, and then run the **upgrade** command for upgrade.

➤ Activating a Hot Patch

- You can run the **patch active** command to activate a patch temporarily. The patch becomes invalid after device restart. To use this patch after device restart, you need to activate it again.
- You can also run the **patch running** command to activate a patch already permanently. The patch is still valid after device start.
- The patch not activated will never become valid.

➤ Deactivating a Hot Patch

- To deactivate an activated patch, run the **patch deactive** command.

➤ Uninstalling a Hot Patch

- You can run the **patch delete** command to uninstall a hot patch.

20.3.4 Auto-Sync for Upgrade

Working Principle

Auto-sync upgrade aims to ensure the coordination of multiple modules (line cards and chassis) within a system. Specifically, the upgrade firmware is pushed to all target members automatically and the software version of new members is upgraded automatically based on the auto-sync policy.

There are three policies available.

None: No auto-sync upgrade.

Compatible: Performs auto-synchronization based on the sequential order of versions.

Coordinate: Synchronizes with the version based on the firmware stored on the supervisor module.

Auto-sync is performed in the following scenarios:

If no upgrade target is specified, the firmware is pushed to all matching members(including line cards and chassis) for auto-sync.

Every member is checked when the device is restarted and auto-sync is performed accordingly.

Every new member is checked when added into the system and auto-sync is performed accordingly.

➤ Management

Auto-upgrade policy, range and path should be configured in advance.

Relevant Configuration

Configuring Auto-Sync Policy

To perform upgrade as expected, check the configuration in advance, such as the path.

If some line cards are not checked for upgrade because the system is not configured with auto-sync policy. You can upgrade them manually.

20.4 Configuration

Configuration	Description and Command	
Upgrading/Degrading Firmware	 The basic function of the configuration is installing and upgrading/degrading a subsystem firmware, feature package, and hot patch package. This command is valid on both the box-type device and rack-type device.	
	upgrade <i>url</i> [patch-active patch-running] [force]	<i>url</i> is a local path where the firmware is stored. This command is used to upgrade the firmware stored on the device.
	upgrade download tftp:// <i>path</i> [patch-active patch-running] [force] [vrf <i>vrf-name</i>]	<i>path</i> is the path of the firmware on the server. This command is used to download a firmware from the server and upgrade the package automatically.
	upgrade download oob_tftp:// <i>path</i> [patch-active patch-running] [force]	<i>path</i> is the path of the firmware on the server. via mgmt number: If the transfer mode is <i>oob_tftp</i> and there are multiple MGMT ports, you can select a specific port. This command is used to download a firmware from the server and upgrade the package automatically.
	patch active	Activates a patch temporarily.
	patch running	Activates a patch permanently.
Deactivating and Uninstalling a Hot Patch	(Optional) Deactivates or uninstalls a hot patch.	
	upgrade deactivate [slot { <i>num</i> M1 M2 all }]	Deactivates an activated patch.
	patch delete [slot { <i>num</i> M1 M2 all }]	Uninstalls a hot patch.
Auto-Sync for Upgrade	(Optional) Configures auto-sync policy.	
	upgrade auto-sync policy [none compatible coordinate]	Configures the auto-sync policy.
	upgrade auto-sync range [chassis]	Configures the auto-sync range.
	upgrade auto-sync package <i>url</i>	Configures the auto-sync path for package.
	upgrade auto-sync patch <i>url</i>	Configures the auto-sync path for path.

20.4.1 Upgrading/Degrading a Firmware

Configuration Effect

Available firmware includes the main package.

- After the upgrade of the main package is complete, all system software on the line card is updated, and the overall software is enhanced.
- After an independent feature package is upgraded, only the feature bug corresponding to this package is fixed. Besides, this feature is enhanced, with other features remain unchanged.

- Upgrading hot patch packages is aimed at fixing software bugs without restarting the device. Hot patch packages are only applicable to fixing bugs for a specific version of software.
- ✔ Generally a main package is released to upgrade a box-type device.

Notes

N/A

Configuration Steps

↳ Upgrading the Main Package for a Single Device

- Optional configuration. This configuration is required when all system software on the device needs to be upgraded.
- Download the firmware to the local device and run the **upgrade** command.
- ✔ Generally a main package is pushed to upgrade a box-type device.

↳ Upgrading a Main Package on a VSU

- Optional configuration. This configuration is required when all system software on a VSU needs to be upgraded without service interruption.
- Download the firmware to the local device and run the **upgrade auto** command.
- ✔ Generally a rack/main package is pushed to upgrade VSU member devices.

↳ Upgrading Each Feature Package

- Optional configuration. The configuration is used to fix bugs of a certain feature and enhance the function of this feature.
- Download the firmware to the local device and run the **upgrade** command.

↳ Upgrading a Hot Patch Package

- Optional configuration. The configuration is used to fix software bugs without restarting the device.
- Download the firmware to the local device and run the **upgrade** command.
- After being upgraded, the hot patch can be used after it is activated. The configuration in this step is mandatory. Two activation modes are available: Run the patch active command to activate a patch temporarily, or run the **patch running** command to activate a patch permanently.

⚠ Generally, the **patch running** command must be used to activate a patch permanently in the user scenario. The **patch active** command can be used to activate a patch only when a user intends to verify the patch.

Verification

- After upgrading a subsystem component, you can run the **show upgrade history** command to check whether the upgrade is successful.
- After upgrading a feature component, you can run the **show component** command to check whether the upgrade is successful.
- After upgrading a hot patch package, you can run the **show patch** command to check whether the upgrade is successful.

Commands

Upgrade

Command	upgrade <i>url</i> [patch-active patch-running] [[force]]
Parameter	force indicates forced upgrade.
Description	patch-active : Activates the patch actively. patch-running : Activates the patch actively and permanently.
Command Mode	Privileged EXEC mode
Usage Guide	N/A

Command	upgrade download tftp: <i>path</i> [patch-active patch-running] [force] [vrf <i>vrf-name</i>] upgrade download oob_tftp: <i>path</i> [patch-active patch-running] [force] [vrf <i>vrf-name</i>]
Parameter	force indicates forced upgrade.
Description	patch-active : Activates the patch actively. patch-running : Activates the patch actively and permanently. vrf vrf-name : Downloads an installation package from the specified VRF.
Command Mode	Privileged EXEC mode
Usage Guide	N/A

Displaying the Firmware Stored on the Device

Command	show upgrade file <i>url</i>
Parameter	<i>url</i> indicates the path of the firmware in the device file system.
Description	
Command Mode	Privileged EXEC mode
Usage Guide	N/A

Viewing the Device Upgrade Process

Command	show upgrade status
Parameter	N/A
Description	
Command Mode	Privileged EXEC mode
Usage Guide	This command is available on only the rack-type device, and it is used to display the upgrade status of each line card.

Displaying Upgrade History

Command	show upgrade history
Parameter	N/A
Description	
Command Mode	Privileged EXEC mode

Usage Guide	N/A
--------------------	-----

▾ Displaying the Feature Components Already Installed

Command	show component [slot { <i>num</i> M1 M2 all }]
Parameter Description	slot indicates that this command is executed on the device in the specified slot; <i>num</i> indicates the slot number of the specified line card; M1 and M2 indicate the supervisor modules; all indicates all devices.
Command Mode	Privileged EXEC mode
Usage Guide	N/A

▾ Displaying the Patch Packages Already Installed

Command	show patch [<i>package_name</i>]
Parameter Description	N/A
Command Mode	Privileged EXEC mode
Usage Guide	N/A

▾ Activating the Patches Temporarily

Command	patch active
Parameter Description	N/A
Command Mode	Privileged EXEC mode
Usage Guide	This operation can be performed only on the device already installed with a patch. This command can be used to activate a patch temporarily, and the activated patch becomes invalid after device restart.

▾ Activating the Patches Permanently

Command	patch running
Parameter Description	N/A
Command Mode	Privileged EXEC mode
Usage Guide	This operation can be performed only on the device already installed with a patch. This command can be used to activate a patch permanently.

--	--

Configuration Example

➤ **Example of Upgrading a Subsystem Firmware on the Box-Type Device**

Network Environment	<p>Before the upgrade, you must copy the firmware to the device. The upgrade module provides the following solutions.</p> <ul style="list-style-type: none"> ● Run some file system commands like copy tftp and copy xmodem to copy the firmware on the server to the device file system, and then run the upgrade url command to upgrade the firmware in the local file system. ● Run the upgrade download tftp://path command directly to upgrade the firmware file stored on the tftp server. ● Copy the firmware to a USB flash drive, insert the USB flash drive to the device, and then run the upgrade url command to upgrade the firmware in the USB flash drive or SD card.
Configuration Steps	<ul style="list-style-type: none"> ● Run the upgrade command. ● After upgrading the subsystem, restart the device.
Verification	<ul style="list-style-type: none"> ● Check the system version on the current device. If the version information changes, the upgrade is successful.

➤ **Example of Upgrading a Feature Package on the Box-Type Device**

Network Environment	<p>Before the upgrade, you must copy the firmware to the device. The upgrade module provides the following solutions.</p> <ul style="list-style-type: none"> ● Run some file system commands like copy tftp and copy xmodem to copy the firmware on the server to the device file system, and then run the upgrade url command to upgrade the firmware in the local file system. ● Run the upgrade download tftp://path command directly to upgrade the firmware file stored on the tftp server. ● Copy the firmware to a USB flash drive or SD card, connect the USB flash drive or SD card to the device, and then run the upgrade url command to upgrade the firmware in the USB flash drive or SD card.
Configuration Steps	<ul style="list-style-type: none"> ● Run the upgrade command. ● Check whether the device needs to be restarted based on the prompt displayed after the upgrade.
	<pre>FS#upgrade sata0://bridge_eg1000m_2.3.1.1252ea-1.mips.rpm FS#upgrade sata0://bridge_eg1000m_2.3.1.1252ea-1.mips.rpm Upgrade processing is 10% Upgrade processing is 60% Upgrade processing is 90% Upgrade info [OK] bridge version[2.0.1.37cd5cda ->2.3.1.1252ea] [OK] Upgrade processing is 100% Reload system to take effect! Reload system?(Y/N)y</pre>

	Restarting system.
Verification	<ul style="list-style-type: none"> ● Check the version of the feature component on the current device. If the version information changes, the upgrade is successful.
	<pre> FS# show component Package :sysmonit Version:1.0.1.23cd34aa Build time:Wed Dec 7 00:58:56 2011 Size:12877 Install time :Wed Mar 5 14:23:12 2012 Description:this is a system monit package Required packages: None ----- package:bridge Version: 2.3.1.1252ea Build time:Wed Dec 7 00:54:56 2011 Size:26945 Install time :Wed Mar 19:23:15 2012 Description:this is a bridge package Required packages: None </pre>

➤ **Example of Upgrading a Main Package for a VSU**

Network Environment	<p>Before the upgrade, you must copy the firmware to the device. The upgrade module provides the following solutions.</p> <ol style="list-style-type: none"> 1 Run some file system commands like copy tftp and copy xmodem to copy the firmware on the server to the device file system, and then run the upgrade auto url command to upgrade the firmware in the local file system. 2 Copy the firmware to a USB flash drive or SD card, Insert the USB flash drive or SD card to the device, and then run the upgrade auto url command to upgrade the firmware in the USB flash drive or SD card.
Configuration Steps	<p>Run the upgrade auto command.</p> <p>The VSU active and standby devices are restarted in sequence.</p> <pre> 2015-04-09_09-56-23 FS#upgrade auto usb0:S6220_FSOS11.0(5)B1_install.bin 2015-04-09_09-56-24 FS#*Jan 1 00:23:40: %7: 2015-04-09_09-56-24 *Jan 1 00:23:40: %7: [Slot 1/0]:Upgrade processing is 10% 2015-04-09_09-56-26 FS#show upgrade status 2015-04-09_09-56-26 [Slot 1/0] 2015-04-09_09-56-26 dev_type: s6k 2015-04-09_09-56-26 status : upgrading 2015-04-09_09-56-26 [Slot 2/0] 2015-04-09_09-56-26 dev_type: s6k 2015-04-09_09-56-26 status : transmission 2015-04-09_09-58-20 *Jan 1 00:25:36: %7: [Slot 2/0]:Upgrade processing is 10% 2015-04-09_09-58-30 FS#show upgrade status 2015-04-09_09-58-30 [Slot 1/0] 2015-04-09_09-58-30 dev_type: s6k 2015-04-09_09-58-30 status : upgrading 2015-04-09_09-58-30 [Slot 2/0] 2015-04-09_09-58-30 dev_type: s6k </pre>

```

2015-04-09_09-58-30      status  : upgrading
2015-04-09_09-58-39 *Jan 1 00:25:56: %7:
2015-04-09_09-58-39 *Jan 1 00:25:56: %7: [Slot 2/0]:Upgrade processing is 60%
2015-04-09_09-59-19 *Jan 1 00:26:35: %7:
2015-04-09_09-59-19 *Jan 1 00:26:35: %7: [Slot 2/0]:Upgrade processing is 90%
2015-04-09_09-59-19 *Jan 1 00:26:35: %7:
2015-04-09_09-59-19 *Jan 1 00:26:35: %7: [Slot 2/0]:
2015-04-09_09-59-19 *Jan 1 00:26:35: %7: Upgrade info [OK]
2015-04-09_09-59-19 *Jan 1 00:26:36: %7:   Kernel version[2.6.32.6b311610a8eb91->2.6.32.6b31161115502c]
2015-04-09_09-59-19 *Jan 1 00:26:36: %7:   Rootfs version[1.0.0.eb75cd01->1.0.0.3d978b6c]
2015-04-09_09-59-19 *Jan 1 00:26:36: %7:
2015-04-09_09-59-19 *Jan 1 00:26:36: %7: [Slot 2/0]:Reload system to take effect!
2015-04-09_09-59-21 *Jan 1 00:26:37: %7:
2015-04-09_09-59-21 *Jan 1 00:26:37: %7: [Slot 2/0]:Upgrade processing is 100%
2015-04-09_10-00-28 FS#show upgrade status
2015-04-09_10-00-28 [Slot 1/0]
2015-04-09_10-00-28      dev_type: s6k
2015-04-09_10-00-28      status  : upgrading
2015-04-09_10-00-28 [Slot 2/0]
2015-04-09_10-00-28      dev_type: s6k
2015-04-09_10-00-28      status  : success
2015-04-09_10-01-39 *Jan 1 00:28:56: %7:
2015-04-09_10-01-39 *Jan 1 00:28:56: %7: [Slot 1/0]:Upgrade processing is 60%
2015-04-09_10-02-17 *Jan 1 00:29:33: %7:
2015-04-09_10-02-17 *Jan 1 00:29:33: %7: [Slot 1/0]:Upgrade processing is 90%
2015-04-09_10-02-17 *Jan 1 00:29:33: %7:
2015-04-09_10-02-17 *Jan 1 00:29:33: %7: [Slot 1/0]:
2015-04-09_10-02-17 *Jan 1 00:29:34: %7: Upgrade info [OK]
2015-04-09_10-02-17 *Jan 1 00:29:34: %7:   Kernel version[2.6.32.6b311610a8eb91->2.6.32.6b31161115502c]
2015-04-09_10-02-17 *Jan 1 00:29:34: %7:   Rootfs version[1.0.0.eb75cd01->1.0.0.3d978b6c]
2015-04-09_10-02-17 *Jan 1 00:29:34: %7:
2015-04-09_10-02-18 *Jan 1 00:29:34: %7: [Slot 1/0]:Reload system to take effect!
2015-04-09_10-02-19 *Jan 1 00:29:35: %7:
2015-04-09_10-02-19 *Jan 1 00:29:35: %7: [Slot 1/0]:Upgrade processing is 100%
2015-04-09_10-02-19 *Jan 1 00:29:36: %7: %PKG_MGMT:auto-sync config synchronization, Please wait for a
moment....
2015-04-09_10-02-20 *Jan 1 00:29:36: %7:
2015-04-09_10-02-20 [ 1784.116069] rtc-pcf8563 6-0051: retrieved date/time is not valid.
2015-04-09_10-02-20 *Jan 1 00:29:36: %7: [Slot 2/0]:auto sync config: space not enough left 57229312, need
114597815
2015-04-09_10-02-20 *Jan 1 00:29:36: %7:
2015-04-09_10-02-20 *Jan 1 00:29:36: %7: [Slot 2/0]:auto sync package config err
2015-04-09_10-02-20 *Jan 1 00:29:37: %7: [Slot 1/0]
2015-04-09_10-02-21 *Jan 1 00:29:37: %7:   device_name: s6k
    
```

	<pre> 2015-04-09_10-02-21 *Jan 1 00:29:37: %7: status: SUCCESS 2015-04-09_10-02-21 *Jan 1 00:29:37: %7: [Slot 2/0] 2015-04-09_10-02-21 *Jan 1 00:29:37: %7: device_name: s6k 2015-04-09_10-02-21 *Jan 1 00:29:37: %7: status: SUCCESS 2015-04-09_10-02-21 *Jan 1 00:29:38: %7: %Do with dtm callback... 2015-04-09_10-02-21 *Jan 1 00:29:38: %VSU-5-DTM_AUTO_UPGRADE: Upgrading the system, wait a moment please. </pre>
Verification	If the version information changes, the upgrade is successful.
	<pre> FS-VSU#show version detail System description : FS Full 10G Routing Switch(S6220-48XS4QXS-II) By FS Networks System start time : 1970-02-07 00:33:24 System uptime : 0:00:47:28 System hardware version : 2.00 System software version : S6220_FSOS 11.0(5)B1 System patch number : NA System software number : M01181304092015 System serial number : 1234942570019 System boot version : 1.2.9.f23dcbe(150317) System core version : 2.6.32.6b31161115502c Module information: Slot 2/0 : RG-S6220-48XS4QXS-II Hardware version : 2.00 System start time : 1970-02-07 00:33:24 Boot version : 1.2.9.f23dcbe(150317) Software version : S6220_FSOS 11.0(5)B1 Software number : M01181304092015 Serial number : 1234942570019 Slot 1/0 : RG-S6220-48XS4QXS-II Hardware version : 2.00 System start time : 1970-02-07 00:33:47 Boot version : 1.2.9.f23dcbe(150317) Software version : S6220_FSOS 11.0(5)B1 Software number : M01181304092015 Serial number : 1234942570018 </pre>

Example of Installing a Patch Package on the Box-Type Device

Network Environment	<p>Before the upgrade, you must copy the firmware to the device. The upgrade module provides the following solutions.</p> <ul style="list-style-type: none"> ● Run some file system commands like copy tftp and copy xmodem to copy the firmware on the server to the device file system, and then run the upgrade url command to upgrade the firmware in the local file system. ● Run the upgrade download tftp://path command directly to upgrade the firmware file stored on the tftp server. ● Copy the firmware to a USB flash drive, connect the USB flash drive to the device, and then run the upgrade
----------------------------	--

	<i>url</i> command to upgrade the firmware in the USB flash drive.
Configuration Steps	<ul style="list-style-type: none"> ● Run the upgrade command. ● Activate the hot patch.
	<pre> FS#upgrade download tftp://192.168.201.98/eg1000m_FSOS11.0(1C2)_20131008_patch.bin Accessing tftp://192.168.201.98/eg1000m_FSOS11.0(1C2)_20131008_patch.bin... !! !! !!!!!!!!!!!!!!!!!!!! Transmission finished, file length 9868 bytes. Upgrade processing is 10% Upgrade processing is 60% Upgrade info [OK] patch_bridge version[1.0.0.1952] Upgrade processing is 90% Upgrade info [OK] patch_install version[1.0.0.192e35a] FS#patch running The patch on the system now is in running status </pre>
Verification	<ul style="list-style-type: none"> ● Check the hot patches installed on the current device.
	<pre> :patch package patch_install installed in the system, version:pa1 Package : patch_bridge Status: running Version: pa1 Build time: Mon May 13 09:03:07 2013 Size: 277 Install time: Tue May 21 03:07:17 2013 Description: a patch for bridge Required packages: None </pre>

Common Errors

If an error occurs during the upgrade, the upgrade module displays an error message. The following provides an example:

```

Upgrade info [ERR]
Reason:creat config file err(217)
                
```

The following describes several types of common error messages:

- Invalid firmware: The cause is that the firmware may be damaged or incorrect. It is recommended to obtain the firmware again and perform the upgrade operation.
- Firmware not supported by the device: The cause is that you may use the firmware of other devices by mistake. It is recommended to obtain the firmware again, verify the package, and perform the upgrade operation.
- Insufficient device space: It is recommended to check whether the device is supplied with a USB flash drive or SD card. Generally, this device has a USB flash drive.

20.4.2 Deactivating and Uninstalling a Hot Patch

Configuration Effect

An activated hot patch is deactivated or uninstalled.

Notes

A hot patch that is not activated does not take effect; therefore, you cannot deactivate it.

Configuration Steps

↳ Deactivating an Activated Patch

- Optional configuration. To deactivate an activated patch, run the **patch deactivate** command.

↳ Uninstalling a Hot Patch

- Optional configuration. To uninstall a hot patch already installed, run the **patch delete** command.

Verification

- You can run the **show patch** command to check whether a patch is activated or uninstalled.

Commands

↳ Deactivating an Activated Patch

Command	patch deactivate
Parameter Description	N/A
Command Mode	Privileged EXEC mode

↳ Deleting a Hot Patch

Command	patch delete
Parameter Description	N/A
Command Mode	Privileged EXEC mode
Usage Guide	This command is used to remove the hot patch package from the device.

Configuration Example

↳ Deactivating and Uninstalling a Patch on the Box Device

Configuration Steps	<ul style="list-style-type: none"> ● Run the patch deactivation command. ● Run the patch deletion command.
----------------------------	--

	<p>FS#patch deactivate Deactivate the patch package success</p> <p>FS# patch delete Clear the patch patch_bridge success Clear the patch success</p>
Verification	<ul style="list-style-type: none"> ● Display patch status.
	<p>FS#show patch No patch package installed in the system</p>

Common Errors

- Run the **patch deactivate** command when the patch is not activated. It is recommended to check the patch status. You can run the **patch deactivate** command only when the patch is in the **status:running** state.

20.4.3 Auto-Sync for Upgrade

Configuration Effect

Auto-sync policy, range and path is configured.

Notes

N/A

Configuration Steps

📌 **Configuring Auto-Sync Policy**

Run the **upgrade auto-sync policy command** to configure the auto-sync policy. There are three modes available:

None: No auto-sync upgrade.

- Compatible: Performs auto-synchronization based on the sequential order of versions.
- Coordinate: Synchronizes with the version based on the firmware stored on the supervisor module.

📌 **Configuring Auto-Sync Range**

Run the **upgrade auto-sync range command** to configure the auto-sync range. There are two ranges available:

- chassis: Performs auto-sync on a chassis.
- vsd: Performs auto-sync in the VSU system.

📌 **Configuring Auto-Sync Path for Package**

Every time the system is upgraded, the package path is recorded automatically for later auto-sync upgrade. Alternatively, use the **upgrade auto-sync package command** to set a path.

📌 **Configuring Auto-Sync Path for Patch**

Every time the system is upgraded, the patch path is recorded automatically for later auto-sync upgrade. Alternatively, use the **upgrade auto-sync patch command** to set a path.

Verification

Run the **upgrade auto-sync** command to check the configuration.

Commands

↘ **Configuring Auto-Sync Policy**

command	upgrade auto-sync policy [compatible coordinate]
Parameter Description	compatible: Performs auto-synchronization based on the sequential order of versions. coordinate: Synchronizes with the version based on the firmware stored on the supervisor module.
Command Mode	Privileged EXEC mode
Usage Guide	It is recommended to set coordinate .

↘ **Configuring Auto-Sync Range**

command	upgrade auto-sync range [chassis]
Parameter Description	chassis: Performs auto-sync on a chassis.
Command Mode	Privileged EXEC mode
Usage Guide	N/A

↘ **Configuring Auto-Sync Path for Package**

command	upgrade auto-sync package url
Parameter Description	<i>url</i> indicates the path of the firmware in the device file system.
Command Mode	Privileged EXEC mode
Usage Guide	The path is not set generally.

↘ **Configuring Auto-Sync Path for Patch**

command	upgrade auto-sync patch url
Parameter Description	<i>url</i> indicates the path of the firmware in the device file system.
Command Mode	Privileged EXEC mode
Usage Guide	The path is not set generally.

Configuration Example

↘ **Configuring Auto-Sync Policy**

Configuration Steps	Configure the auto-sync policy.
----------------------------	---------------------------------

	<pre>FS# upgrade auto-sync policy coordinate Upgrade auto-sync policy is set as coordinate</pre>
Verification	Check the auto-sync policy.
	<pre>FS#show upgrade auto-sync auto-sync policy: coordinate auto-sync range: vsu auto-sync package: flash:/eg1000m_main_1.0.0.0f328e91.bin</pre>

Configuring Auto-Sync Range

Configuration Steps	Configure the auto-sync range.
	<pre>FS# upgrade auto-sync range vsu Upgrade auto-sync range is set as vsu.</pre>
Verification	Check the auto-sync range.
	<pre>FS#show upgrade auto-sync auto-sync policy: coordinate auto-sync range: vsu auto-sync package: flash:/eg1000m_main_1.0.0.0f328e91.bin</pre>

Common Errors

url is not valid.

20.5 Monitoring

Clearing

Description	Command
Deletes a hot patch package already installed.	patch delete

Displaying

Description	Command
Displays all components already installed on the current device and their information.	show component [slot { <i>num</i> M1 M2 all }]
Displays the information about the hot patch packages already installed on the device.	show patch [<i>patch_name</i>]
Displays the upgrade status of various line cards on a rack-type device.	show upgrade status
Displays the upgrade history.	show upgrade history

21 Configuring Python Shell

21.1 Overview

Python is an object-oriented interpreted computer programming language. It is totally free software and its source code and

interpreter named CPython comply with the GNU General Public License (GPL) protocol. The Python shell component can implement simple debugging and Python script execution via CLI commands. It mainly provides the following functions:

- In privileged EXEC mode, you can run a Python CLI command to access the Python console to conduct debugging.
- In privileged EXEC mode, you can add a file name to a Python CLI command and run the command to run the script in the **flash:** and **tmp:** directories of the device.
- The Python commands and scripts can be executed only on files in the **flash:** and **tmp:** directories due to permission control.
- Highly risky functions such as popen and system functions cannot be executed in Python scripts due to permission control.

21.2 Applications

Application	Scenario
Debugging and Running a Python Script	Run the copy command to copy a local Python script to the device and then run the python flash:test.py command to run the Python script on the device.

21.2.1 Python Script Execution Application Scenario

Scenario

To debug and run a Python script, do as follows:

- Compile a Python script (such as **test.py**) on the local PC and set up a Trivial File Transfer Protocol (TFTP) server.
- Run the **copy tftp://xxx.xxx.xxx.xxx/test.py flash:** command to copy the script to the device.
- In privileged EXEC mode, run the **python flash:test.py** command to run the Python script on the device.

Deployment

- The PC can be pinged from the device and the TFTP server is installed on the PC.

21.3 Features

21.3.1 Python Script Debugging

Python script debugging is to test or execute a script that is to be uploaded to the device. The debugging can be performed by accessing the Python console or copying the script to the device.

Working Principle

Open-source Python commands are actually executed regardless of which debugging method is used, and all debugging methods are consistent with those for open-source Python commands on other platforms. The Python shell component only redirects the input and output of open-source Python processes to the current STA.

Run the **python file_name args** command to debug and run the Python script.

21.3.2 Permission Control

Permission control means that Python CLI commands can be executed only on files in the **flash:** and **tmp:** directories, and the execution of popen, system, and other highly risky functions is prohibited inside scripts.

Working Principle

Permission control is to conduct control at the Python ingress. Permissions are controlled for Python scripts executed on the device, to control risks brought by Python script execution.

21.4 Monitoring

N/A

Ethernet Switching Configuration

1. Configuring Interface
2. Configuring Single Fiber
3. Configuring MAC Address
4. Configuring Aggregate Port
5. Configuring VLAN
6. Configuring MAC VLAN
7. Configuring Super VLAN
8. Configuring Protocol VLAN
9. Configuring Private VLAN
10. Configuring MSTP
11. Configuring GVRP
12. Configuring LLDP
13. Configuring QinQ
14. Configuring HASH Simulator
15. Configuring L3-PKT-COUNTER ENABLE
16. Configuring Positioning Lamp
17. Configuring Port Module Type

22 Configuring Interfaces

22.1 Overview

Interfaces are important in implementing data switching on network devices. FS devices support two types of interfaces: physical ports and logical interfaces. A physical port is a hardware port on a device, such as the 100M Ethernet interface and gigabit Ethernet interface. A logical interface is not a hardware port on the device. A logical interface, such as the loopback interface and tunnel interface, can be associated with a physical port or independent of any physical port. For network protocols, physical ports and logical interfaces serve the same function.

22.2 Applications

Application	Description
L2 Data Switching Through the Physical Ethernet Interface	Implement Layer-2 (L2) data communication of network devices through the physical L2 Ethernet interface.
L3 Routing Through the Physical Ethernet Interface	Implement Layer-3 (L3) data communication of network devices through the physical L3 Ethernet interface.

22.2.1 L2 Data Switching Through the Physical Ethernet Interface

Scenario

Figure 1- 1

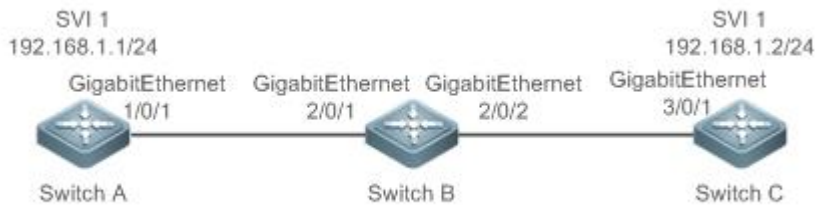

As shown in Figure 1- 1, Switch A, Switch B, and Switch C form a simple L2 data switching network.

Deployment

- Connect Switch A to Switch B through physical ports GigabitEthernet 1/0/1 and GigabitEthernet 2/0/1.
- Connect Switch B to Switch C through physical ports GigabitEthernet 2/0/2 and GigabitEthernet 3/0/1.
- Configure GigabitEthernet 1/0/1, GigabitEthernet 2/0/1, GigabitEthernet 2/0/2, and GigabitEthernet 3/0/1 as Trunk ports.
- Create a switch virtual interface (SVI), SVI 1, on Switch A and Switch C respectively, and configure IP addresses from a network segment for the two SVIs. The IP address of SVI 1 on Switch A is 192.168.1.1/24, and the IP address of SVI 1 on Switch C is 192.168.1.2/24.
- Run the **ping 192.168.1.2** command on Switch A and the **ping 192.168.1.1** command on Switch C to implement data switching through Switch B.

22.2.2L3 Routing Through the Physical Ethernet Interface

Scenario

Figure 1- 2



As shown in Figure 1- 2, Switch A, Switch B, and Switch C form a simple L3 data communication network.

Deployment

- Connect Switch A to Switch B through physical ports GigabitEthernet 1/0/1 and GigabitEthernet 2/0/1.
- Connect Switch B to Switch C through physical ports GigabitEthernet 2/0/2 and GigabitEthernet 3/0/1.
- Configure GigabitEthernet 1/0/1, GigabitEthernet 2/0/1, GigabitEthernet 2/0/2, and GigabitEthernet 3/0/1 as L3 routed ports.
- Configure IP addresses from a network segment for GigabitEthernet 1/0/1 and GigabitEthernet 2/0/1. The IP address of GigabitEthernet 1/0/1 is 192.168.1.1/24, and the IP address of GigabitEthernet 2/0/1 is 192.168.1.2/24.
- Configure IP addresses from a network segment for GigabitEthernet 2/0/2 and GigabitEthernet 3/0/1. The IP address of GigabitEthernet 2/0/2 is 192.168.2.1/24, and the IP address of GigabitEthernet 3/0/1 is 192.168.2.2/24.
- Configure a static route entry on Switch C so that Switch C can directly access the network segment 192.168.1.0/24. Configure a static route entry on Switch A so that Switch C can directly access the network segment 192.168.1.0/24.
- Run the **ping 192.168.2.2** command on Switch A and the **ping 192.168.1.1** command on Switch C to implement L3 routing through Switch B.

22.3 Features

Basic Concepts

📌 Interface Classification

6. Interfaces on FS devices fall into three categories:
 - L2 interface (Switches or gateway bridge)
 - L3 interface (supported by L3 devices)
7. Common L2 interfaces are classified into the following types:
 - Switch port
 - L2 aggregate port (AP)
8. Common L3 interfaces are classified into the following types:
 - Routed port
 - L3 AP port
 - SVI
 - Loopback interface

- Tunnel interface

Switch Port

A switch port is an individual physical port on the device, and implements only the L2 switching function. The switch port is used to manage physical ports and L2 protocols related to physical ports.

L2 AP Port

An AP port is formed by aggregating multiple physical ports. Multiple physical links can be bound together to form a simple logical link. This logical link is called an AP port.

For L2 switching, an AP port is equivalent to a switch port that combines bandwidths of multiple ports, thus expanding the link bandwidth. Frames sent over the L2 AP port are balanced among the L2 AP member ports. If one member link fails, the L2 AP port automatically transfers the traffic on the faulty link to other member links, improving reliability of connections.

SVI

The SVI can be used as the management interface of the local device, through which the administrator can manage the device. You can also create an SVI as a gateway interface, which is mapped to the virtual interface of each VLAN to implement routing across VLANs among L3 devices. You can run the **interface vlan** command to create an SVI and assign an IP address to this interface to set up a route between VLANs.

As shown in Figure 1- 3, hosts in VLAN 20 can directly communicate with each other without participation of L3 devices. If Host A in VLAN 20 wants to communicate with Host B in VLAN 30, SVI 1 of VLAN 20 and SVI 2 of VLAN 30 must be used.

Figure 1- 3

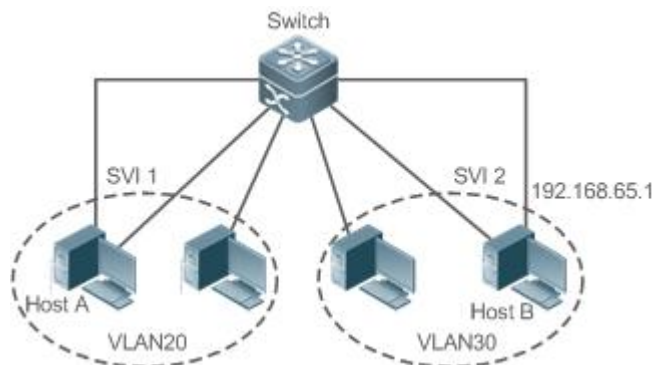

Routed Port

A physical port on a L3 device can be configured as a routed port, which functions as the gateway interface for L3 switching. A routed port is not related with a specific VLAN. Instead, it is just an access port. The routed port cannot be used for L2 switching. You can run the **no switchport** command to change a switch port to a routed port and assign an IP address to this port to set up a route. Note that you must delete all L2 features of a switch port before running the **no switchport** command.

- i** If a port is a L2 AP member port or a DOT1X port that is not authenticated, you cannot run the **switchport** or **no switchport** command to configure the switch port or routed port.

L3 AP Port

Like the L2 AP port, a L3 AP port is a logical port that aggregates multiple physical member ports. The aggregated ports must be the L3 ports of the same type. The AP port functions as a gateway interface for L3 switching. Multiple physical links are combined into one logical link, expanding the bandwidth of a link. Frames sent over the L3 AP port are balanced among the L3 AP member ports. If one

member link fails, the L3 AP port automatically transfers the traffic on the faulty link to other member links, improving reliability of connections.

A L3 AP port cannot be used for L2 switching. You can run the **no switchport** command to change a L2 AP port that does not contain any member port into a L3 AP port, add multiple routed ports to this L3 AP port, and then assign an IP address to this L3 AP port to set up a route.

↳ Loopback Interface

The loopback interface is a local L3 logical interface simulated by the software that is always UP. Packets sent to the loopback interface are processed on the device locally, including the route information. The IP address of the loopback interface can be used as the device ID of the Open Shortest Path First (OSPF) routing protocol, or as the source address used by Border Gateway Protocol (BGP) to set up a TCP connection. The procedure for configuring a loopback interface is similar to that for configuring an Ethernet interface, and you can treat the loopback interface as a virtual Ethernet interface.

↳ Tunnel Interface

The Tunnel interface implements the tunnel function. Over the Tunnel interface, transmission protocols (e.g., IP) can be used to transmit packets of any protocol. Like other logical interfaces, the tunnel interface is also a virtual interface of the system. Instead of specifying any transmission protocol or load protocol, the tunnel interface provides a standard point-to-point (P2P) transmission mode. Therefore, a tunnel interface must be configured for every individual link.

Overview

Feature	Description
Interface Configuration Commands	You can configure interface-related attributes in interface configuration mode. If you enter interface configuration mode of a non-existing logical interface, the interface will be created.
Interface Description and Administrative Status	You can configure a name for an interface to identify the interface and help you remember the functions of the interface. You can also configure the administrative status of the interface.
MTU	You can configure the maximum transmission unit (MTU) of a port to limit the length of a frame that can be received or sent over this port.
Bandwidth	You can configure the bandwidth of an interface.
Load Interval	You can specify the interval for load calculation of an interface.
Carrier Delay	You can configure the carrier delay of an interface to adjust the delay after which the status of an interface changes from Down to Up or from Up to Down.
Link Trap Policy	You can enable or disable the link trap function on an interface.
Interface Index Persistence	You can enable the interface index persistence function so that the interface index remains unchanged after the device is restarted.
Routed Port	You can configure a physical port on a L3 device as a routed port, which functions as the gateway interface for L3 switching.
L3 AP Port	You can configure an AP port on a L3 device as a L3 AP port, which functions as the gateway interface for L3 switching.
Interface Speed, Duplex Mode, Flow Control Mode, and Auto Negotiation Mode	You can configure the speed, duplex mode, flow control mode, and auto negotiation mode of an interface.
Automatic Module Detection	If the interface speed is set to auto, the interface speed can be automatically adjusted based on

Feature	Description
	the type of the inserted module.
<u>Protected Port</u>	You can configure some ports as protected ports to disable communication between these ports. You can also disable routing between protected ports.
<u>Port Errdisable Recovery</u>	After a port is shut down due to a violation, you can run the errdisable recovery command in global configuration mode to recover all the ports in errdisable state and enable these ports.
<u>Port Flapping Protection</u>	You can configure the port flapping protection function so that the system can automatically shut down the port when flapping occurs on the port.

22.3.1 Interface Configuration Commands

Run the **interface** command in global configuration mode to enter interface configuration mode. You can configure interface-related attributes in interface configuration mode.

Working Principle

Run the **interface** command in global configuration mode to enter interface configuration mode. If you enter interface configuration mode of a non-existing logical interface, the interface will be created. You can also run the **interface range** or **interface range macro** command in global configuration mode to configure the range (IDs) of interfaces. Interfaces defined in the same range must be of the same type and have the same features.

You can run the **no interface** command in global configuration mode to delete a specified logical interface.

↘ Interface Numbering Rules

In stand-alone mode, the ID of a physical port consists of two parts: slot ID and port ID on the slot. For example, if the slot ID of the port is 2, and port ID on the slot is 3, the interface ID is 2/3.

The slot number rules are as follows: The static slot ID is 0, whereas the ID of a dynamic slot (pluggable module or line card) ranges from 1 to the number of slots. Assume that you are facing the device panel. Dynamic slot are numbered from 1 sequentially from front to rear, from left to right, and from top to bottom.

The ID of a port on the slot ranges from 1 to the number of ports on the slot, and is numbered sequentially from left to right.

The ID of an AP port ranges from 1 to the number of AP ports supported by the device.

The ID of an SVI is the VID of the VLAN corresponding to this SVI.

↘ Configuring Interfaces Within a Range

You can run the **interface range** command in global configuration mode to configure multiple interfaces at a time. Attributes configured in interface configuration mode apply to all these interfaces.

The **interface range** command can be used to specify several interface ranges.

The **macro** parameter is used to configure the macro corresponding to a range. For details, see "Configuring Macros of Interface Ranges."

Ranges can be separated by commas (,).

The types of interfaces within all ranges specified in a command must be the same.

Pay attention to the format of the **range** parameter when you run the **interface range** command.

The following interface range formats are valid:

- **FastEthernet** device/slot/{first port} - {last port};
- **GigabitEthernet** device/slot/{first port} - {last port};
- **TenGigabitEthernet** device/slot/{first port} - {last port};
- **FortyGigabitEthernet** device/slot/{first port} - {last port};
- **AggregatePort** *Aggregate-port ID* (The AP ID ranges from 1 to the maximum number of AP ports supported by the device.)
- **vlan** vlan-ID-vlan-ID (The VLAN ID ranges from 1 to 4,094.)
- **Loopback** loopback-ID (The loopback ID ranges from 1 to 2,147,483,647.)
- **Tunnel** tunnel-ID (The tunnel ID ranges from 0 to the maximum number of tunnel interfaces supported by the device minus 1.)

Interfaces in an interface range must be of the same type, namely, FastEthernet or GigabitEthernet.

📌 **Configuring Macros of Interface Ranges**

You can define some macros to replace the interface ranges. Before using the **macro** parameter in the **interface range** command, you must first run the **define interface-range** command in global configuration mode to define these macros.

Run the **no define interface-range macro_name** command in global configuration mode to delete the configured macros.

22.3.2 Interface Description and Administrative Status

You can configure a name for an interface to identify the interface and help you remember the functions of the interface.

You can enter interface configuration mode to enable or disable an interface.

Working Principle

📌 **Interface Description**

You can configure the name of an interface based on the purpose of the interface. For example, if you want to assign GigabitEthernet 1/1 for exclusive use by user A, you can describe the interface as "Port for User A."

📌 **Interface Administrative Status**

You can configure the administrative status of an interface to disable the interface as required. If the interface is disabled, no frame will be received or sent on this interface, and the interface will lose all its functions. You can enable a disabled interface by configuring the administrative status of the interface. Two types of interface administrative status are defined: Up and Down. The administrative status of an interface is Down when the interface is disabled, and Up when the interface is enabled.

22.3.3 MTU

You can configure the MTU of a port to limit the length of a frame that can be received or sent over this port. Some chips do not support interface-based MTU configuration, but support only the global Ethernet interface-based MTU.

Working Principle

When a large amount of data is exchanged over a port, frames greater than the standard Ethernet frame may exist. This type of frame is called jumbo frame. The MTU is the length of the valid data segment in a frame. It does not include the Ethernet encapsulation overhead.

If a port receives or sends a frame with a length greater than the MTU, this frame will be discarded.

The MTU ranges from 64 bytes to 9,216 bytes, at a step of four bytes. The default MTU is 1500 bytes.

 The **mtu** command takes effect only on a physical or AP port.

22.3.4 Bandwidth

Working Principle

The **bandwidth** command can be configured so that some routing protocols (for example, OSPF) can calculate the route metric and the Resource Reservation Protocol (RSVP) can calculate the reserved bandwidth. Modifying the interface bandwidth will not affect the data transmission rate of the physical port.

 The **bandwidth** command is a routing parameter, and does not affect the bandwidth of a physical link.

22.3.5 Load Interval

Working Principle

You can run the **load-interval** command to specify the interval for load calculation of an interface. Generally, the interval is 10s.

22.3.6 Carrier Delay

Working Principle

The carrier delay refers to the delay after which the data carrier detect (DCD) signal changes from Down to Up or from Up to Down. If the DCD status changes during the delay, the system will ignore this change to avoid negotiation at the upper data link layer. If this parameter is set to a great value, nearly every DCD change is not detected. On the contrary, if the parameter is set to 0, every DCD signal change will be detected, resulting in poor stability.

 If the DCD carrier is interrupted for a long time, the carrier delay should be set to a smaller value to accelerate convergence of the topology or route. On the contrary, if the DCD carrier interruption time is shorter than the topology or route convergence time, the carrier delay should be set to a greater value to avoid topology or route flapping.

22.3.7 Link Trap Policy

You can enable or disable the link trap function on an interface.

Working Principle

When the link trap function on an interface is enabled, the Simple Network Management Protocol (SNMP) sends link traps when the link status changes on the interface.

22.3.8 Interface Index Persistence

Like the interface name, the interface index also identifies an interface. When an interface is created, the system automatically assigns a unique index to the interface. The index of an interface may change after the device is restarted. You can enable the interface index persistence function so that the interface index remains unchanged after the device is restarted.

Working Principle

After interface index persistence is enabled, the interface index remains unchanged after the device is restarted.

22.3.9 Routed Port

Working Principle

A physical port on a L3 device can be configured as a routed port, which functions as the gateway interface for L3 switching. The routed port cannot be used for L2 switching. You can run the **no switchport** command to change a switch port to a routed port and assign an IP address to this port to set up a route. Note that you must delete all L2 features of a switch port before running the **no switchport** command.

22.3.10 L3 AP Port

Working Principle

Like a L3 routed port, you can run the **no switchport** command to change a L2 AP port into a L3 AP port on a L3 device, and then assign an IP address to this AP port to set up a route. Note that you must delete all L2 features of the AP port before running the **no switchport** command.

-  A L2 AP port with one or more member ports cannot be configured as a L3 AP port. Similarly, a L3 AP port with one or more member ports cannot be changed to a L2 AP port.

22.3.11 Interface Speed, Duplex Mode, Flow Control Mode, and Auto Negotiation Mode

You can configure the interface speed, duplex mode, flow control mode, and auto negotiation mode of an Ethernet physical port or AP port.

Working Principle

⌵ Speed

Generally, the speed of an Ethernet physical port is determined through negotiation with the peer device. The negotiated speed can be any speed within the interface capability. You can also configure any speed within the interface capability for the Ethernet physical port.

When you configure the speed of an AP port, the configuration takes effect on all of its member ports. (All these member ports are Ethernet physical ports.)

⌵ Duplex Mode

- The duplex mode of an Ethernet physical port or AP port can be configured as follows:
- Set the duplex mode of the interface to full-duplex so that the interface can receive packets while sending packets.
- Set the duplex mode of the interface to half-duplex so that the interface can receive or send packets at a time.
- Set the duplex mode of the interface to auto-negotiation so that the duplex mode of the interface is determined through auto negotiation between the local interface and peer interface.
- When you configure the duplex mode of an AP port, the configuration takes effect on all of its member ports. (All these member ports are Ethernet physical ports.)

⌵ Flow Control

Two flow control modes are defined for an interface:

- Symmetric flow control mode: Generally, after flow control is enabled on an interface, the interface processes the received flow control frames, and sends the flow control frames when congestion occurs on the interface. The received and sent flow control frames are processed in the same way. This is called symmetric flow control mode.
- Asymmetric flow control mode: In some cases, an interface on a device is expected to process the received flow control frames to ensure that no packet is discarded due to congestion, and not to send the flow control frames to avoid decreasing the network speed. In this case, you need to configure asymmetric flow control mode to separate the procedure for receiving flow control frames from the procedure for sending flow control frames.
- When you configure the flow control mode of an AP port, the configuration takes effect on all of its member ports. (All these member ports are Ethernet physical ports.)

As shown in Figure 1- 4, Port A of the device is an uplink port, and Ports B, C and D are downlink ports. Assume that Port A is enabled with the functions of sending and receiving flow control frames. Port B and Port C are connected to different slow networks. If a large amount of data is sent on Port B and Port C, Port B and Port C will be congested, and consequently congestion occurs in the inbound direction of Port A. Therefore, Port A sends flow control frames. When the uplink device responds to the flow control frames, it reduces the data flow sent to Port A, which indirectly slows down the network speed on Port D. At this time, you can disable the function of sending flow control frames on Port A to ensure the bandwidth usage of the entire network.

Figure 1- 4

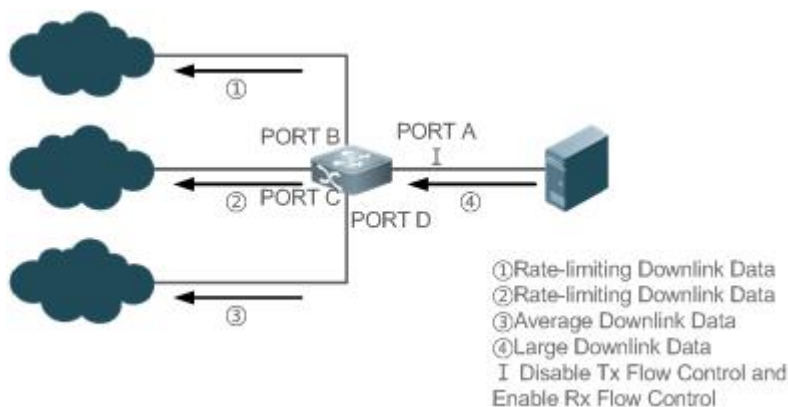

📌 Auto Negotiation Mode

- The auto negotiation mode of an interface can be On or Off. The auto negotiation state of an interface is not completely equivalent to the auto negotiation mode. The auto negotiation state of an interface is jointly determined by the interface speed, duplex mode, flow control mode, and auto negotiation mode.
- When you configure the auto negotiation mode of an AP port, the configuration takes effect on all of its member ports. (All these member ports are Ethernet physical ports.)
- ❗ Generally, if one of the interface speed, duplex mode, and flow control mode is set to auto, or the auto negotiation mode of an interface is On, the auto negotiation state of the interface is On, that is, the auto negotiation function of the interface is enabled. If none of the interface speed, duplex mode, and flow control mode is set to auto, and the auto negotiation mode of an interface is Off, the auto negotiation state of the interface is Off, that is, the auto negotiation function of the interface is disabled.
- ❗ For a 100M fiber port, the auto negotiation function is always disabled, that is, the auto negotiation state of a 100M fiber port is always Off. For a Gigabit copper port, the auto negotiation function is always enabled, that is, the auto negotiation state of a Gigabit copper port is always On.

22.3.12 Automatic Module Detection

If the interface speed is set to auto, the interface speed can be automatically adjusted based on the type of the inserted module.

Working Principle

Currently, the automatic module detection function can be used to detect only the SFP and SFP+ modules. The SFP is a Gigabit module, whereas SFP+ is a 10 Gigabit module. If the inserted module is SFP, the interface works in Gigabit mode. If the inserted module is SFP+, the interface works in 10 Gigabit mode.

 The automatic module detection function takes effect only when the interface speed is set to auto.

22.3.13 Protected Port

In some application environments, it is required that communication be disabled between some ports. For this purpose, you can configure some ports as protected ports. You can also disable routing between protected ports.

Working Principle

Protected Port

After ports are configured as protected ports, protected ports cannot communicate with each other, but can communicate with non-protected ports.

Protected ports work in either of the two modes. In the first mode, L2 switching is blocked but routing is allowed between protected ports. In the second mode, both L2 switching and routing are blocked between protected ports. If a protected port supports both modes, the first mode is used by default.

When two protected port are configured as a pair of mirroring ports, frames sent or received by the source port can be mirrored to the destination port.

Currently, only an Ethernet physical port or AP port can be configured as a protected port. When an AP port is configured as a protected port, all of its member ports are configured as protected ports.

Blocking L3 Routing Between Protected Ports

By default, L3 routing between protected ports is not blocked. In this case, you can run the **protected-ports route-deny** command to block routing between protected ports.

22.3.14 Port Errdisable Recovery

Some protocols support the port errdisable recovery function to ensure security and stability of the network. For example, in the port security protocol, when you enable port security and configure the maximum number of security addresses on the port, a port violation event is generated if the number of addresses learned on this port exceeds the maximum number of security addresses.

Other protocols, such as the Spanning Tree Protocol (STP), DOT1X and REUP, support the similar functions, and a violating port will be automatically shut down to ensure security.

Working Principle

After a port is shut down due to a violation, you can run the **errdisable recovery** command in global configuration mode to recovery all the ports in errdisable state and enable these ports. You can manually recover a port, or automatically recover a port at a scheduled time. On some models, you can run the **shutdown** or **no shutdown** command to recover all the ports in errdisable state and enable these ports.

22.3.15 Split and Combination of the 100G Port

Working Principle

For example, the 100G Ethernet port is a high-bandwidth port. It is mainly used on devices at the convergence layer or core layer to increase the port bandwidth. Port split means that a high-bandwidth port is split into multiple low-bandwidth ports. At this time, the 100G port becomes unavailable, and the low-bandwidth ports forward data independently. Port combination means that multiple low-bandwidth ports are combined into a 100G port. At this time, the low-bandwidth ports become unavailable, and only the 100G port forwards data. You can flexibly adjust the bandwidth by combining or splitting ports.

22.3.16 SVI or Sub-Interface Sampling

By default, the SVI or sub-interface does not support packet statistics. Information, such as the number of packets received or sent on the SVI or sub-interface and the packet sending/receiving rate, cannot be displayed. You can enable SVI or sub-interface sampling to display these statistics.

22.3.17 Enabling Statistics of IP Packets on Interfaces

By default, statistics of IP packets is disabled on physical ports, APs, and sub-interfaces. But by running the **show interface interface-type interface-number** command, you can enable statistics of IP packets and to display numbers and rates of input and output IP packets.

 This feature is not supported on all models.

Related Configuration

▾ Enabling Statistics of IP Packets on Interfaces

By default, statistics of IP packets are disabled.

In interface configuration mode, use the **ip-sample enable** command to enable statistics of IP packets on interfaces.

In interface configuration mode, use the **ip-sample enable brief** command to enable statistics of IP packets on interfaces. The **brief** parameter indicates that the IP packets including unicast and multicast are counted.

22.3.18 Port Flapping Protection

When flapping occurs on a port, a lot of hardware interruptions occur, consuming a lot of CPU resources. On the other hand, frequent port flapping damages the port. You can configure the flapping protection function to protect ports.

Working Principle

By default, the port flapping protection function is enabled. You can disable this function as required. When flapping occurs on a port, the port detects flapping every 2s or 10s. If flapping occurs six times within 2s on a port, the device displays a prompt. If 10 prompts are displayed continuously, that is, port flapping is detected continuously within 20s, the port is shut down (the violation cause shows Link Dither). If flapping occurs 10 times within 10s on a port, the device displays a prompt without shutting down the port.

22.3.19 Syslog

You can enable or disable the syslog function to determine whether to display information about the interface changes or exceptions.

Working Principle

You can enable or disable the syslog function as required. By default, this function is enabled. When an interface becomes abnormal, for example, the interface status changes, or the interface receives error frames, or flapping occurs, the system displays prompts to notify users.

22.3.20 Global MTU



Users can set the global MTU to control the maximum length of frames that can be sent and received over all ports.

Working Principle

When large-throughput data exchange is performed over a port, frames whose length is longer than that of a standard Ethernet frame may exist, and these frames are called jumbo frames. The MTU indicates the length of valid data fields in a frame, excluding the Ethernet encapsulation overhead.

If the length of a frame received or forwarded by a port exceeds the MTU value, the frame will be discarded.

The MTU value ranges from 64 to 9216 bytes. The granularity is four bytes. The default value is 1500 bytes.

-  The IP MTU automatically changes to the value of the link MTU of an interface when the globally set link MTU changes.
-  The MTU of an interface takes precedence over the global MTU. After the global MTU is configured, the MTU of an interface cannot be set to the default value.

22.3.21 Interface MAC Address

Working Principle

By default, each Ethernet interface has a globally unique MAC address. The MAC addresses of Ethernet interfaces can be modified if required. However, MAC addresses in the same LAN must be unique.

To configure the MAC address of an Ethernet interface, run the **mac-address** command in interface configuration mode:

-  Configuration of MAC addresses may affect internal communication in a LAN. Therefore, it is recommended that users do not configure MAC addresses by themselves if unnecessary.

Related Configuration

Configuring MAC Addresses for Interfaces

By default, each interface has a globally unique MAC address.

You can run the **mac-address mac-address** command in interface configuration mode to modify the MAC address of an interface.

22.3.22 VLAN Encapsulation Flag on Interfaces

Working Principle

Virtual local area network (VLAN) is a logical network divided on a physical network and corresponds to the layer-2 network in the ISO model. In 1999, IEEE released the 802.1Q protocol draft for standardizing the VLAN implementation solution.

The VLAN technology enables the network administrator to divide a physical LAN into multiple broadcast domains (or VLANs). Each VLAN contains a group of workstations with the same requirements and each VLAN has the same attributes as the physical LAN. As VLANs are logically divided, workstations in the same VLAN do not need to be placed in the same physical space, that is, these workstations may belong to different physical LAN network segments. Multicast and unicast traffic in a VLAN will not be forwarded to other VLANs. This helps control traffic, reduce device investment, simplify network management, and improve the network security.

VLAN is a protocol used to solve Ethernet broadcast and security problems. During packet transmission, a VLAN header is added to Ethernet frames. In addition, VLAN IDs are used to classify users to different work groups to restrict layer-2 exchange between users in different work groups. Each work group is a VLAN. VLANs can be used to restrict the broadcast scope and form virtual work groups to manage networks dynamically.

To ensure communication with hosts in a VLAN, users can configure the 802.1Q (VLAN protocol) VLAN encapsulation flag on the Ethernet interface or sub-interface. In this case, when packets are sent over the Ethernet interface, the corresponding VLAN header will be encapsulated. When packets are received, the VLAN header will be deleted from the packet.

Related Configuration

📌 Configuring the VLAN Encapsulation Flag for Interfaces

By default, the 802.1Q encapsulation protocol is disabled for interfaces.

You can run the **encapsulation dot1Q VlanID** command in interface mode for 802.1Q encapsulation for an interface. **VlanID** indicates the encapsulated VLAN ID.

22.3.23 Interface FEC Mode

Working Principle

Forward Error Correction (FEC) is an error code correction method employing the following working principle: The sender adds a redundancy error-correcting code to the data for sending. The receiver performs error detection on the data based on the error-correcting code. If an error is found, the receiver corrects the error. FEC improves signal quality but also causes signal delay. Users can enable or disable this function according to the actual situation.

There are three types of FEC modes: BASE-R mode, RS mode and Auto mode. Different types of ports support different FEC modes, which depends on the specific product.

Related Configuration

📌 Configuring Interface FEC Mode

By default, FEC mode is related with the port type and depends on the product model. And whether the FEC mode is enabled or disabled on a port is determined by the inserted optical module and rate.

Run the **fec mode {rs | base-r | none | auto}** command in interface mode to configure the FEC mode on an interface.

22.3.24 Statistics Sampling Cycle on Ethernet Ports

Working Principle

The default statistics sampling cycle of Ethernet ports is 5 seconds, which means that the interface statistics are updated every 5 seconds. In scenarios with high requirements for real-time statistics, you can prolong the sampling cycle.

 A shorter sampling cycle indicates higher system performance consumption. Therefore, the sampling cycle must be adjusted as required. If the number of physical port exceeds 500, it is recommended to set the sampling cycle to over 10s.

Related Configuration

📌 Configuring Statistics Sampling Cycle on Ethernet Ports

The default statistics sampling cycle of Ethernet ports is 5 seconds.

Run the **ethernet-port counter sample-period** [*seconds*] command in global configuration mode to adjust the sampling cycle on Ethernet ports.

22.3.25 Statistics Sampling Cycle on Ethernet Sub-Ports

Working Principle

The default statistics sampling cycle of Ethernet sub-ports is 5 seconds, which means that the interface statistics are updated every 5 seconds. In scenarios with high requirements for real-time statistics, you can prolong the sampling cycle.

-  A shorter sampling cycle indicates higher system performance consumption. Therefore, the sampling cycle must be adjusted as required.

Related Configuration

↘ **Configuring Statistics Sampling Cycle on Ethernet Sub-Ports**

The default statistics sampling cycle of Ethernet sub-ports is 5 seconds.

Run the **ethernet-subport counter route-sample-period** [*seconds*] command in global configuration mode to adjust the sampling cycle on Ethernet sub-ports.

22.3.26 Enhanced Name Display for Interfaces in the Standard MIB Node

Working Principle

By default, the interface name in the standard MIB node and syslog of port status and LACP status contain the space, and the ifName node shows the short name of the interface. After enhanced name display is enabled, no space is contained, and the full name of the interface is shown. The involved standard MIB modes include but are not limited to ifDescr and ifName nodes.

Related Configuration

↘ **Enabling Enhanced Name Display for Interfaces in the Standard MIB Node**

By default, the interface name in the standard MIB node contains the space, and the ifName node shows the short name of the interface.

Run the **snmp-server if-name enhance** global configuration command to enhance name display for interfaces.

22.3.27 Including the Interframe Gap in the Flow Statistics

Working Principle

By default, the interframe gap is not counted in the flow statistics. You can enable including of interframe gap in the flow statistics, if you want to view the flow statistics at the physical layer, which contains the number of bytes of packets and the interframe gap.

-  After this feature is enabled, the size of the interframe gap is fixed, which is 20 bytes. (The interframe gap is 12-byte and the preamble is 8-byte.)

Related Configuration

↘ **Including the Interframe Gap in the Flow Statistics**

By default, the interframe gap is not counted in the flow statistics.

Run the **flow-statistics include-interframe enable** global configuration command to include the interframe gap in the flow statistics.

22.4 Limitations



- Optical ports do not support the speed of 100 Mbps.



- 10G optical port: When a 10G optical transceiver is inserted into a 10G optical port, the auto-negotiation mode is disabled. When a 1000M optical transceiver is inserted into a 10G optical port, the auto-negotiation mode is enabled by default.
- 40G optical port: When an optical transceiver is inserted into a 40G optical port, the auto-negotiation mode is disabled. When a copper cable is connected to a 40G optical port, the auto-negotiation mode is enabled.



- The MTU is converted into a packet length for calculation in chips. The converted packet length used for calculation is 26 bytes (including a 14-byte Ethernet header, a 4-byte FCS, and two tags) greater than the configured MTU.



- When mode switching is configured on 25G ports of the S6510/S6250 (**port speed-mode 10G/25G**), the modes of four consecutive ports of the configured port are changed at the same time, and no speed can be configured for the 25G ports.



- Ensure that the IP MTU, IPv6 MTU, and link MTU of layer-3 interfaces are set properly and the IP/IPv6 MTU is not greater than the interface MTU. Layer-3 interfaces include routing ports, layer-3 APs, and SVIs.

22.5 Configuration

Configuration	Description and Command	
Performing Basic Configurations	(Optional) It is used to manage interface configurations, for example, creating/deleting an interface, or configuring the interface description.	
	interface	Creates an interface and enters configuration mode of the created interface or a specified interface.
	interface range	Enters an interface range, creates these interfaces (if not created), and enters interface configuration mode.
	define interface-range	Creates a macro to specify an interface range.
	snmp-server if-index persist	Enables the interface index persistence function so that the interface index remains unchanged after the device is restarted.
	description	Configures the interface description of up to 80 characters in

Configuration	Description and Command	
		interface configuration mode.
	snmp trap link-status	Configures whether to send the link traps of the interface.
	shutdown	Shuts down an interface in interface configuration mode.
	split interface	Splits a 40G port in global configuration mode.
	split compatible mode	Configures the compatible naming mode for split member ports in global configuration mode.
	physical-port dither protect	Configures interface flapping protection in global configuration mode.
	physical-port dither period	Configures port oscillation detection.
	logging [link-updown error-frame link-dither res-lack-frame]	Enables logging of status information on an interface in global configuration mode.
<u>Configuring Interface Attributes</u>	 (Optional) It is used to configure interface attributes.	
	bandwidth	Configures the bandwidth of an interface in interface configuration mode.
	carrier-delay	Configures the carrier delay of an interface in interface configuration mode.
	load-interval	Configures the interval for load calculation of an interface.
	duplex	Configures the duplex mode of an interface.
	flowcontrol	Enables or disables flow control of an interface.
	mtu	Configures the MTU of an interface.
	ethernet-port mtu	Configures the MTU of Ethernet interfaces globally.
	negotiation mode	Configures the auto negotiation mode of an interface.
	speed	Configures the speed of an interface.
	port speed-mode	Configures the speed mode for a 25G port.
	switchport	Configures an interface as a L2 interface in interface configuration mode. (Run the no switchport command to configure an interface as a L3 interface.)
	switchport protected	Configures a port as a protected port.
	protected-ports route-deny	Blocks L3 routing between protected ports in global configuration mode.
	errdisable recovery [cause link-state]	Recovers a port in errdisable state in global configuration mode or privileged EXEC mode.
	route-sample enable	Enables the sampling function of a SVI/subinterface in interface configuration mode.
	mtu forwarding	Sets the global MTU and IP MTU.
	mac-address	Sets the MAC address of an interface.
	encapsulation dot1Q	Sets the VLAN tag for an interface.
	fec mode	Configures the FEC mode for an interface.
	ethernet-port counter sample-period	Configures the statistics sampling period for an Ethernet port.
ethernet-subport	Configures statistics sampling cycle on Ethernet sub-ports.	

Configuration	Description and Command	
	counter route-sample-period	
	snmp-server if-name enhance	Configures enhanced name display for interfaces in the standard MIB node and syslog of port status and LACP status.
	flow-statistics include-interframe enable	Includes the interframe gap in the flow statistics.

22.5.1 Performing Basic Configurations

Configuration Effect

- Create a specified logical interface and enter configuration mode of this interface, or enter configuration mode of an existing physical or logical interface.
- Create multiple specified logical interfaces and enter interface configuration mode, or enter configuration mode of multiple existing physical or logical interfaces.
- The interface indexes remain unchanged after the device is restarted.
- Configure the interface description so that users can directly learn information about the interface.
- Enable or disable the link trap function of an interface.
- Enable or disable an interface.
- Split a 100G port or combine four 25G ports into a 100G port.

Notes

- The **no** form of the command can be used to delete a specified logical interface or logical interfaces in a specified range, but cannot be used to delete a physical port or physical ports in a specified range.
- The **default** form of the command can be used in interface configuration mode to restore default settings of a specified physical or logical interface, or interfaces in a specified range.

Configuration Steps

📌 Configuring a Specified Interface

- Optional.
- Run this command to create a logical interface or enter configuration mode of a physical port or an existing logical interface.

Command	interface <i>interface-type interface-number</i>
Parameter Description	<i>interface-type interface-number</i> : Indicates the type and number of the interface. The interface can be an Ethernet physical port, AP port, SVI, or loopback interface.
Defaults	N/A
Command Mode	Global configuration mode
Usage Guide	<ul style="list-style-type: none"> ● If a logical interface is not created yet, run this command to create this interface and enter configuration mode of this interface. ● For a physical port or an existing logical interface, run this command to enter configuration mode of this interface. ● Use the no form of the command to delete a specified logical interface.

	<ul style="list-style-type: none"> ● Use the default form of the command to restore default settings of the interface in interface configuration mode.
--	--

↘ **Configuring Interfaces Within a Range**

- Optional.
- Run this command to create multiple logical interfaces or enter configuration mode of multiple physical port or existing logical interfaces.

Command	interface range { <i>port-range</i> macro <i>macro_name</i> }
Parameter Description	<i>port-range</i> : Indicates the type and ID range of interfaces. These interfaces can be Ethernet physical ports, AP ports, SVIs, or loopback interfaces. <i>macro_name</i> : Indicates the name of the interface range macro.
Defaults	N/A
Command Mode	Global configuration mode
Usage Guide	<ul style="list-style-type: none"> ● If logical interfaces are not created yet, run this command to create these interfaces and enter interface configuration mode. ● For multiple physical ports or existing logical interfaces, run this command to enter interface configuration mode. ● Use the default form of the command to restore default settings of these interfaces in interface configuration mode. ● Before using a macro, run the define interface-range command to define the interface range as a macro name in global configuration mode, and then run the interface range macro <i>macro_name</i> command to apply the macro.

↘ **Configuring Interface Index Persistence**

- Optional.
- Run this command when the interface indexes must remain unchanged after the device is restarted.

Command	snmp-server if-index persist
Parameter Description	N/A
Defaults	By default, interface index persistence is disabled.
Command Mode	Global configuration mode
Usage Guide	After this command is executed, current indexes of all interfaces will be saved, and the indexes remain unchanged after the device is restarted. You can use the no or default form of the command to disable the interface index persistence function.

↘ **Configuring the Description of an Interface**

- Optional.
- Run this command to configure the description of an interface.

Command	description <i>string</i>
Parameter	<i>string</i> : Indicates a string of up to 80 characters.

Description	
Defaults	By default, no description is configured.
Command Mode	Interface configuration mode
Usage Guide	This command is used to configure the description of an interface. You can use the no or default form of the command to delete the description of an interface.-

📌 **Configuring the Link Trap Function of an Interface**

- Optional.
- Run this command to obtain the link traps through SNMP.

Command	snmp trap link-status
Parameter	N/A
Description	
Defaults	By default, the link trap function is enabled.
Command Mode	Interface configuration mode
Usage Guide	This command is used to configure the link trap function on an interface. When this function is enabled, the SNMP sends link traps when the link status changes on the interface. You can use the no or default form of the command to disable the link trap function.

📌 **Configuring the Administrative Status of an Interface**

- Optional.
- Run this command to enable or disable an interface.
- An interface cannot send or receive packets after it is disabled.

Command	shutdown
Parameter	N/A
Description	
Defaults	By default, the administrative status of an interface is Up.
Command Mode	Interface configuration mode
Usage Guide	<p>You can run the shutdown command to disable an interface, or the no shutdown command to enable an interface. You can use the no or default form of the command to enable the interface.</p> <p> According to the product model, when the port is in the errdisable state, there are two possible cases:</p> <ol style="list-style-type: none"> 1. The no shutdown command cannot be run on the port. 2. The errdisbale ports can be recovered by running the shutdown commands in the following sequence: 1. shutdown, 2. no shutdown.

📌 **Splitting or Combining Ports**

- Optional.
- Run this command to split a high-bandwidth port or combine multiple low-bandwidth ports into a high-bandwidth port.

Command	[no] split interface <i>interface-type interface-number</i> [split-type <i>split-type</i>]
----------------	--

Parameter	<i>interface-type interface-number</i> : Indicates the type and number of a port.
Description	<i>split-type</i> : Indicates the split type, for example, 4x25G, 4x10G and 2x50G.
Defaults	By default, the ports are combined.
Command Mode	Global configuration mode
Usage Guide	<p>You can run the split command to split a 40G/100G port, or the no split command to combine the split 40G/100G port.</p> <p>After this command is configured, you generally need to restart the line card or the entire device so that the configuration can take effect.</p>

⚡ **Configuring the Compatible Naming Mode for Split Member ports**

- Optional.
- Configure the compatible naming mode for split member ports.

Command	[no] split compatible mode
Parameter Description	N/A
Defaults	By default, the compatible naming mode is disabled.
Command Mode	Global configuration mode
Usage Guide	<p>The configuration takes effect after a device restart. After the device restart, the split member ports will lose their original configurations and need to be re-configured.</p> <p>Before the configuration takes effect, the port ID in a split member port's name is in the format of slot ID/port ID:split member port ID (for example: FortyGigabitEthernet 0/54:4) by default.</p> <p>After the configuration takes effect, the port ID is in the format of slot ID/port ID/split member port ID (for example: FortyGigabitEthernet 0/54/4).</p> <p>In VSU mode, this command is not supported and the configuration will not take effect.</p>

⚡ **Configuring the SVI or Sub-Interface Sampling Function**

- Optional.
- Run this command to enable the SVI or sub-interface sampling function.

Command	[no] route-sample enable
Parameter Description	N/A
Defaults	By default, the SVI or sub-interface does not support sampling.
Command Mode	Interface configuration mode
Usage Guide	N/A

⚡ **Configuring IP Packets Statistics on Interface**

- Optional.
- Run this command to enable statistics of IP packets on interfaces.

Command	[no] route-sample enable [brief]
----------------	---

Parameter Description	brief: Indicates that the IP packets including unicast and multicast are counted.
Defaults	By default, statistics of IP packets on interfaces is disabled.
Command Mode	Interface configuration mode
Usage Guide	N/A

⌵ **Configuring Port Flapping Protection**

- Optional.
- Run this command to protect the port against flapping.

Command	physical-port dither protect
Parameter Description	N/A
Defaults	By default, port flapping protection is enabled.
Command Mode	Global configuration mode
Usage Guide	N/A

⌵ **Configuring Oscillation Detection**

- Optional.
- Run this command to detect port oscillations.

Command	physical-port dither period seconds threshold number period-times times
Parameter Description	<p><i>seconds:</i> Specifies the duration of a period in the unit of second ranging from 2 to 60.</p> <p><i>number:</i> Specifies the amount of detected flapping for a period. Once the configured value is reached for certain consecutive periods, operations may be taken against the port. The configurable value is from 5 to 10.</p> <p><i>times:</i> Specifies the number of successive periods for which the threshold is reached. You can choose any number from 1 to 10.</p>
Defaults	The default value of <i>seconds</i> is 2, <i>threshold</i> 6, and <i>period times</i> 10.
Command Mode	Global configuration mode
Usage Guide	To shut down violating ports, you need to configure this command first.

⌵ **Configuring the Syslog Function**

- Optional.
- Run this command to enable or disable the syslog function on an interface.

Command	[no] logging [link-updown error-frame link-dither res-lack-frame crc-frame]
Parameter Description	<p>link-updown: prints the status change information.</p> <p>error-frame: prints the error frame information.</p> <p>link-dither: prints the port flapping information.</p> <p>res-lack-frame: prints the error frame information received by an interface due to lack of resource.</p> <p>crc-frame: prints information indicating CRC failures.</p>
Defaults	By default, the syslog function is enabled on an interface.

Command	Global configuration mode
Mode	
Usage Guide	N/A

↘ **Enabling Enhanced Name Display for Interfaces in the Standard MIB Node**

- Optional.
- Run this command to enable or disable enhanced name display for interfaces in the standard MIB mode and syslog of port status and LACP status.

Command	[no default] snmp-server if-name enhance
Parameter	N/A
Description	
Defaults	By default, name display for interfaces in the standard MIB node and syslog of port status and LACP status is not enhanced.
Command	Global configuration mode
Mode	
Usage Guide	N/A

Verification

↘ **Configuring a Specified Interface**

- Run the **interface** command. If you can enter interface configuration mode, the configuration is successful.
- For a logical interface, after the **no interface** command is executed, run the **show running** or **show interfaces** command to check whether the logical interface exists. If not, the logical interface is deleted.
- After the **default interface** command is executed, run the **show running** command to check whether the default settings of the corresponding interface are restored. If yes, the operation is successful.

↘ **Configuring Interfaces Within a Range**

- Run the **interface range** command. If you can enter interface configuration mode, the configuration is successful.
- After the **default interface range** command is executed, run the **show running** command to check whether the default settings of the corresponding interfaces are restored. If yes, the operation is successful.

↘ **Configuring Interface Index Persistence**

- After the **snmp-server if-index persist** command is executed, run the **write** command to save the configuration, restart the device, and run the **show interface** command to check the interface index. If the index of an interface remains the same after the restart, interface index persistence is enabled.

↘ **Configuring the Link Trap Function of an Interface**

- Remove and then insert the network cable on a physical port, and enable the SNMP server. If the SNMP server receives link traps, the link trap function is enabled.
- Run the **no** form of the **snmp trap link-status** command. Remove and then insert the network cable on a physical port. If the SNMP server does not receive link traps, the link trap function is disabled.

↘ **Configuring the Administrative Status of an Interface**

- Insert the network cable on a physical port, enable the port, and run the **shutdown** command on this port. If the syslog is displayed on the Console indicating that the state of the port changes to Down, and the indicator on the port is off, the port is disabled. Run the **show interfaces** command, and verify that the interface state changes to Administratively Down. Then, run the **no shutdown** command to enable the port. If the syslog is displayed on the Console indicating that the state of the port changes to Up, and the indicator on the port is on, the port is enabled.

↘ **Splitting or Combining a Port**

- Run the **split** command on a 100G port in global configuration mode. Verify that the related syslog is displayed on the Console. Run the **write** command to save the configuration, and restart the device or line card according to the method described in the syslog. The low-bandwidth ports can be configured as L2 or L3 ports, but the split 100G port cannot be configured as a L2 or L3 port. If the port supports hot splitting (splitting ports without restarting the device), run the **split** command and syslog is printed to suggest the ongoing splitting. Then, after a while, the syslog indicating successful splitting is generated. The split ports are automatically shut down.
- Run the **no split** command on a split 100G port. Verify that the related syslog is displayed on the Console. Run the **write** command to save the configuration, and restart the device or line card according to the method described in the syslog. The low-bandwidth ports cannot be configured as L2 or L3 ports, but the combined 100G port can be configured as a L2 or L3 port. If the port supports hot splitting, use the **no split** command and syslog is printed to suggest the ongoing combining. After a while, the syslog is generated to indicate that successful combining. And the combined port is automatically shut down.
- **i** To prevent loops, the split/combined ports are automatically shut down upon successful splitting/combining. During hot splitting, if the device restarts due to some exceptions, auto shutdown may not take effect.
- **i** With cold splitting, after the splitting type is switched and the new splitting type takes effect, an interface inherits previous configuration if the interface has the same name as a previous interface. Therefore, clear the interface configuration before restart.

↘ **Configuring the SVI or Sub-Interface Sampling Function**

- Run the **route-sample enable** command in SVI or sub-interface configuration mode. Then, run the **show interface** command and verify that the number of sent or received packets and the packet sending/receiving rate are displayed. Run the **no route-sample enable** command. Then, run the **show interface** command and verify that the number of sent or received packets and the packet sending/receiving rate are not displayed.

↘ **Configuring IP Packet Statistics on Interface**

- Run the **ip-sample enable** command in interface configuration mode. Then, run the **show interface** command and verify that the number of sent or received packets and the packet sending/receiving rate are displayed. Run the **no ip-sample enable** command. Then, run the **show interface** command and verify that the number of sent or received packets and the packet sending/receiving rate are not displayed.

↘ **Configuring Port Flapping Protection**

- Run the **physical-port dither protect** command in global configuration mode. Frequently remove and insert the network cable on a physical port to simulate port flapping. Verify that a syslog indicating port flapping is displayed on the Console. After such a syslog is displayed for several times, the system prompts that the port will be shutdown.

- Run the **physical-port dither period** command in global configuration mode to enable flapping detection. You can define violating ports by configuring detection period duration, threshold for flapping and the number of consecutive violating period.

➤ **Configuring the Syslog Function**

- Run the **logging link-updown** command in global configuration mode to display the interface status information. Remove and then insert the network cable on a physical port. The interface state will change twice. Verify that the information is displayed on the Console, indicating that the interface state changes from Up to Down, and then from Down to Up. Run the **no logging link-updown** command. Remove and then insert the network cable. Verify that the related information is no longer displayed on the Console. This indicates that the syslog function is normal.

➤ **Enabling Enhanced Name Display for Interfaces in the Standard MIB Node**

- Run the **snmp-server if-name enhance** global configuration command, and then use the SNMP tool to read interface names in the standard MIB node, such as ifDescr and ifName. And no space is contained in the result, like GigabitEthernet0/1. Use the **no snmp-server if-name enhance** command, and then read ifDescr again. This time, the result shows a space and the short name of the interface, which is GigabitEthernet 0/1. It indicates that the enhanced name display functionality is normal.
- Run the **snmp-server if-name enhance** command, then there is no space in the syslog of port status and LACP status. Then, perform the **no snmp-server if-name enhance** command, and spaces are contained in the syslog output. It indicates normal functionality.

Configuration Example

➤ **Configuring Basic Attributes of Interfaces**

<p>Scenario Figure 1- 5</p>	
<p>Configuration Steps</p>	<ul style="list-style-type: none"> ● Connect two devices through the switch ports. ● Configure an SVI respectively on two devices, and assign IP addresses from a network segment to the two SVIs. ● Enable interface index persistence on the two devices. ● Enable the link trap function on the two devices. ● Configure the interface administrative status on the two devices.
<p>A</p>	<pre>A# configure terminal A(config)# snmp-server if-index persist A(config)# interface vlan 1 A(config-if-VLAN 1)# ip address 192.168.1.1 255.255.255.0 A(config-if-VLAN 1)# exit A(config)# interface gigabitethernet 0/1 A(config-if-GigabitEthernet 0/1)# snmp trap link-status A(config-if-GigabitEthernet 0/1)# shutdown</pre>

	<pre>A(config-if-GigabitEthernet 0/1)# end A# write</pre>																									
<p>B</p>	<pre>B# configure terminal B(config)# snmp-server if-index persist B(config)# interface vlan 1 B(config-if-VLAN 1)# ip address 192.168.1.2 255.255.255.0 B(config-if-VLAN 1)# exit B(config)# interface gigabitethernet 0/1 B(config-if-GigabitEthernet 0/1)# snmp trap link-status B(config-if-GigabitEthernet 0/1)# shutdown B(config-if-GigabitEthernet 0/1)# end B# write</pre>																									
<p>Verification</p>	<p>Perform verification on Switch A and Switch B as follows:</p> <ul style="list-style-type: none"> ● Run the shutdown command on port GigabitEthernet 0/1, and check whether GigabitEthernet 0/1 and SVI 1 are Down. ● Run the shutdown command on port GigabitEthernet 0/1, and check whether a trap indicating that this interface is Down is sent. ● Restart the device, and check whether the index of GigabitEthernet 0/1 is the same as that before the restart. 																									
<p>A</p>	<pre>A# show interfaces gigabitEthernet 0/1 Index(dec):1 (hex):1 GigabitEthernet 0/1 is administratively down , line protocol is DOWN Hardware is GigabitEthernet, address is 00d0.f865.de9b (bia 00d0.f865.de9b) Interface address is: no ip address MTU 1500 bytes, BW 1000000 Kbit Encapsulation protocol is Bridge, loopback not set Keepalive interval is 10 sec , set Carrier delay is 2 sec Rxload is 1/255, Txload is 1/255</pre> <table border="1" data-bbox="330 1756 1414 2007"> <thead> <tr> <th>Queue</th> <th>Transmitted packets</th> <th>Transmitted bytes</th> <th>Dropped packets</th> <th>Dropped bytes</th> </tr> </thead> <tbody> <tr> <td>0</td> <td>0</td> <td>0</td> <td>0</td> <td>0</td> </tr> <tr> <td>1</td> <td>0</td> <td>0</td> <td>0</td> <td>0</td> </tr> <tr> <td>2</td> <td>0</td> <td>0</td> <td>0</td> <td>0</td> </tr> <tr> <td>3</td> <td>0</td> <td>0</td> <td>0</td> <td>0</td> </tr> </tbody> </table>	Queue	Transmitted packets	Transmitted bytes	Dropped packets	Dropped bytes	0	0	0	0	0	1	0	0	0	0	2	0	0	0	0	3	0	0	0	0
Queue	Transmitted packets	Transmitted bytes	Dropped packets	Dropped bytes																						
0	0	0	0	0																						
1	0	0	0	0																						
2	0	0	0	0																						
3	0	0	0	0																						

4	0	0	0	0
5	0	0	0	0
6	0	0	0	0
7	4	440	0	0
<p>Switchport attributes:</p> <p>interface's description:""</p> <p>lastchange time:0 Day:20 Hour:15 Minute:22 Second</p> <p>Priority is 0</p> <p>admin speed is AUTO, oper speed is Unknown</p> <p>flow control admin status is OFF, flow control oper status is Unknown</p> <p>admin negotiation mode is OFF, oper negotiation state is ON</p> <p>Storm Control: Broadcast is OFF, Multicast is OFF, Unicast is OFF</p> <p>Port-type: access</p> <p>Vlan id: 1</p> <p>10 seconds input rate 0 bits/sec, 0 packets/sec</p> <p>10 seconds output rate 0 bits/sec, 0 packets/sec</p> <p>4 packets input, 408 bytes, 0 no buffer, 0 dropped</p> <p>Received 0 broadcasts, 0 runts, 0 giants</p> <p>0 input errors, 0 CRC, 0 frame, 0 overrun, 0 abort</p> <p>4 packets output, 408 bytes, 0 underruns , 0 dropped</p> <p>0 output errors, 0 collisions, 0 interface resets</p> <p>A# show interfaces vlan 1</p> <p>Index(dec):4097 (hex):1001</p> <p>VLAN 1 is UP , line protocol is DOWN</p> <p>Hardware is VLAN, address is 00d0.f822.33af (bia 00d0.f822.33af)</p> <p>Interface address is: 192.168.1.1/24</p> <p>ARP type: ARPA, ARP Timeout: 3600 seconds</p> <p>MTU 1500 bytes, BW 1000000 Kbit</p> <p>Encapsulation protocol is Ethernet-II, loopback not set</p> <p>Keepalive interval is 10 sec , set</p> <p>Carrier delay is 2 sec</p> <p>Rxload is 0/255, Txload is 0/255</p>				
B	B# show interfaces gigabitEthernet 0/1			

```

Index(dec):1 (hex):1
GigabitEthernet 0/1 is administratively down , line protocol is DOWN
Hardware is GigabitEthernet
Interface address is: no ip address, address is 00d0.f865.de9b (bia 00d0.f865.de9b)
    MTU 1500 bytes, BW 1000000 Kbit
    Encapsulation protocol is Bridge, loopback not set
    Keepalive interval is 10 sec , set
    Carrier delay is 2 sec
    Rxload is 1/255, Txload is 1/255
    Queue    Transmitted packets    Transmitted bytes    Dropped packets    Dropped bytes
    0                0                0                0                0
    1                0                0                0                0
    2                0                0                0                0
    3                0                0                0                0
    4                0                0                0                0
    5                0                0                0                0
    6                0                0                0                0
    7                4                440                0                0
Switchport attributes:
    interface's description:""
    lastchange time:0 Day:20 Hour:15 Minute:22 Second
    Priority is 0
    admin duplex mode is AUTO, oper duplex is Unknown
    admin speed is AUTO, oper speed is Unknown
    flow control admin status is OFF, flow control oper status is Unknown
    admin negotiation mode is OFF, oper negotiation state is ON
    Storm Control: Broadcast is OFF, Multicast is OFF, Unicast is OFF
Port-type: access
    Vlan id: 1
    10 seconds input rate 0 bits/sec, 0 packets/sec
    10 seconds output rate 0 bits/sec, 0 packets/sec
    4 packets input, 408 bytes, 0 no buffer, 0 dropped
    Received 0 broadcasts, 0 runts, 0 giants
    
```

```

0 input errors, 0 CRC, 0 frame, 0 overrun, 0 abort
4 packets output, 408 bytes, 0 underruns , 0 dropped
0 output errors, 0 collisions, 0 interface resets
B# show interfaces vlan 1
Index(dec):4097 (hex):1001
VLAN 1 is UP , line protocol is DOWN
Hardware is VLAN, address is 00d0.f822.33af (bia 00d0.f822.33af)
Interface address is: 192.168.1.2/24
ARP type: ARPA, ARP Timeout: 3600 seconds
    MTU 1500 bytes, BW 1000000 Kbit
    Encapsulation protocol is Ethernet-II, loopback not set
    Keepalive interval is 10 sec , set
    Carrier delay is 2 sec
    Rxload is 0/255, Txload is 0/255
    
```

22.5.2 Configuring Interface Attributes

Configuration Effect

- Enable the device to connect and communicate with other devices through the switch port or routed port.
- Adjust various interface attributes on the device.

Configuration Steps

⌵ Configuring a Routed Port

- Optional.
- Run this command to configure a port as a L3 routed port.
- After a port is configured as a L3 routed port, L2 protocols running on the port do not take effect.
- This command is applicable to a L2 switch port.

Command	no switchport
Parameter	N/A
Description	
Defaults	By default, an Ethernet physical port is a L2 switch port.
Command Mode	Interface configuration mode
Usage Guide	On a L3 device, you can run this command to configure a L2 switch port as a L3 routed port. You can run the switchport command to change a L3 routed port into a L2 switch port.

⌵ Configuring a L3 AP Port

- Optional.



- Run the **no switchport** command in interface configuration mode to configure a L2 AP port as a L3 AP port. Run the **switchport** command to configure a L3 AP port as a L2 AP port.
- After a port is configured as a L3 routed port, L2 protocols running on the port do not take effect.
- This command is applicable to a L2 AP port.

Command	no switchport
Parameter	N/A
Description	
Defaults	By default, an AP port is a L2 AP port.
Command Mode	Interface configuration mode
Usage Guide	After entering configuration mode of a L2 AP port on a L3 device, you can run this command to configure a L2 AP port as a L3 AP port. After entering configuration mode of a L3 AP port, you can run the switchport command to change a L3 AP port into a L2 AP port.

↘ Configuring the Speed of an Interface

- Optional.
- Port flapping may occur if the configured speed of a port changes.
- This command is applicable to an Ethernet physical port or AP port.
- A same speed mode must be configured on four consecutive 25 Gbps ports.

Command	speed [10 100 1000 10G 40G 100G auto]
Parameter Description	<p>10: Indicates that the speed of the interface is 10 Mbps.</p> <p>100: Indicates that the speed of the interface is 100 Mbps.</p> <p>1000: Indicates that the speed of the interface is 1000 Mbps.</p> <p>10G: Indicates that the speed of the interface is 10 Gbps.</p> <p>40G: Indicates that the speed of the interface is 40 Gbps.</p> <p>100G: Indicates that the speed of the interface is 100 Gbps.</p>
Defaults	By default, the speed of an interface is auto.
Command Mode	Interface configuration mode
Usage Guide	<p>If an interface is an AP member port, the speed of this interface is determined by the speed of the AP port. When the interface exits the AP port, it uses its own speed configuration. You can run show interfaces to display the speed configurations. The speed options available to an interface vary with the type of the interface. For example, you cannot set the speed of an SFP interface to 10 Mbps.</p> <p> The speed of a 40G physical port can only be set to 40 Gbps or auto.</p>
Command	port speed-mode [10G 25G]
Parameter Description	<p>10G: Indicates that the speed of the interface is 10 Gbps.</p> <p>25G: Indicates that the speed of the interface is 25 Gbps.</p>
Defaults	The speed of the interface is 25G by default.
Command Mode	Interface configuration mode
Usage Guide	Only 25 Gbps ports support this speed mode. A same speed mode must be configured on four consecutive 25 Gbps ports.

	<ul style="list-style-type: none">  Only 25 Gbps ports with the same speed mode are allowed to join the same aggregation group.  Running the default interface command does not clear the speed mode configuration on 25 Gbps ports.
--	---

↘ **Configuring the Duplex Mode of an Interface**

- Optional.
- Port flapping may occur if the configured duplex mode of a port changes.
- This command is applicable to an Ethernet physical port or AP port.

Command	duplex { auto full half }
Parameter Description	<p>auto: Indicates automatic switching between full duplex and half duplex.</p> <p>full: Indicates full duplex.</p> <p>half: Indicates half duplex.</p>
Defaults	By default, the duplex mode of an interface is auto.
Command Mode	Interface configuration mode
Usage Guide	The duplex mode of an interface is related to the interface type. You can run show interfaces to display the configurations of the duplex mode.

↘ **Configuring the Flow Control Mode of an Interface**

- Optional.
- Generally, the flow control mode of an interface is off by default. For some products, the flow control mode is on by default.
- After flow control is enabled on an interface, the flow control frames will be sent or received to adjust the data volume when congestion occurs on the interface.
- Port flapping may occur if the configured flow control mode of a port changes.
- This command is applicable to an Ethernet physical port or AP port.

Command	flowcontrol { auto off on }
Parameter Description	<p>auto: Indicates automatic flow control.</p> <p>off: Indicates that flow control is disabled.</p> <p>on: Indicates that flow control is enabled.</p>
Defaults	By default, flow control is disabled on an interface.
Command Mode	Interface configuration mode

↘ **Configuring the Auto Negotiation Mode of an Interface**

- Optional.
- Port flapping may occur if the configured auto negotiation mode of a port changes.
- This command is applicable to an Ethernet physical port or AP port.

Command	negotiation mode { on off }
Parameter Description	<p>on: Indicates that the auto negotiation mode is on.</p> <p>off: Indicates that the auto negotiation mode is off.</p>
Defaults	By default, the auto negotiation mode is off.

Command	Interface configuration mode
Mode	
Usage Guide	N/A

↘ **Configuring the MTU of an Interface**

- Optional.
- You can configure the MTU of a port to limit the length of a frame that can be received or sent over this port.
- This command is applicable to an Ethernet physical port or SVI.

Command	mtu num
Parameter	<i>num: 64–9216</i>
Description	
Defaults	By default, the MTU of an interface is 1500 bytes.
Command	Interface configuration mode
Mode	
Usage Guide	This command is used to configure the interface MTU, that is, the maximum length of a data frame at the link layer. Currently, you can configure MTU for only a physical port or an AP port that contains one or more member ports.

↘ **Configuring the MTU of Ethernet Interface Globally**

- Optional.
- You can configure the MTU of a port to limit the length of a frame that can be received or sent over the Ethernet port.
- This command is applicable to an Ethernet physical port.

Command	ethernet-port mtu num
Parameter	<i>num: 64–9216</i>
Description	
Defaults	By default, the MTU of an interface is 1500 bytes.
Command	Interface configuration mode
Mode	
Usage Guide	This command is used to globally configure the Ethernet interface MTU, that is, the maximum length of a data frame at the link layer. Currently, you can configure MTU for only a physical port or an AP port that contains one or more member ports. Some chips do not support interface-based MTU configuration, but support only the global Ethernet interface-based MTU.

↘ **Configuring Global MTU**

- Optional.
- Users can set the global MTU and IP MTU to control the maximum length of frames that can be sent and received over all ports.
- Support physical Ethernet port.

Command	mtu forwarding num
Parameter	<i>num: 64–9216</i>
Description	
Defaults	By default, the MTU of an interface is 1500 bytes.
Command	Global configuration mode

Mode	
Usage Guide	The IP MTU automatically changes to the value of the link MTU of an interface when the globally set link MTU changes.

➤ **Configuring the Bandwidth of an Interface**

- Optional.
- Generally, the bandwidth of an interface is the same as the speed of the interface.

Command	bandwidth <i>kilobits</i>
Parameter Description	<i>kilobits</i> : The value ranges from 1 to 2,147,483,647. The unit is kilo bits.
Defaults	Generally, the bandwidth of an interface matches the type of the interface. For example, the default bandwidth of a gigabit Ethernet physical port is 1,000,000, and that of a 10G Ethernet physical port is 10,000,000.
Command Mode	Interface configuration mode
Usage Guide	N/A

➤ **Configuring the Carrier Delay of an Interface**

- Optional.
- If the configured carrier delay is long, it takes a long time to change the protocol status when the physical status of an interface changes. If the carrier delay is set to 0, the protocol status changes immediately after the physical status of an interface changes.

Command	carrier-delay {[<i>milliseconds</i>] <i>num</i> up [<i>milliseconds</i>] <i>num</i> down [<i>milliseconds</i>] <i>num</i> }
Parameter Description	<i>num</i> : The value ranges from 0 to 60. The unit is second. <i>milliseconds</i> : Indicates the carrier delay. The value ranges from 0 to 60,000. The unit is millisecond. up : Indicates the delay after which the state of the DCD changes from Down to Up. down : Indicates the delay after which the state of the DCD changes from Up to Down.
Defaults	By default, the carrier delay of an interface is 2s.
Command Mode	Interface configuration mode
Usage Guide	If millisecond is used as the unit, the configured carrier delay must be an integer multiple of 100 milliseconds.

➤ **Configuring the Load Interval of an Interface**

- Optional.
- The configured load interval affects computation of the average packet rate on an interface. If the configured load interval is short, the average packet rate can accurately reflect the changes of the real-time traffic.

Command	load-interval <i>seconds</i>
Parameter Description	<i>seconds</i> : The value ranges from 5 to 600. The unit is second.
Defaults	By default, the load interval of an interface is 10s.
Command Mode	Interface configuration mode
Usage Guide	N/A

➤ **Configuring a Protected Port**

- Optional.
- L2 packets cannot be forwarded between protected ports.
- This command is applicable to an Ethernet physical port or AP port.

Command	switchport protected
Parameter	N/A
Description	
Defaults	By default, no protected port is configured.
Command	Interface configuration mode
Mode	
Usage Guide	N/A

⌵ Blocking L3 Routing Between Protected Ports

- Optional.
- After this command is configured, L3 routing between protected ports are blocked.

Command	protected-ports route-deny
Parameter	N/A
Description	
Defaults	By default, the function of blocking L3 routing between protected ports is disabled.
Command	Global configuration mode
Mode	
Usage Guide	By default, L3 routing between protected ports is not blocked. In this case, you can run this command to block routing between protected ports.

⌵ Configuring Port Errdisable Recovery

- Optional.
- By default, a port will be disabled and will not be recovered after a violation occurs. After port errdisable recovery is configured, a port in errdisable state will be recovered and enabled.

Command	errdisable recovery [interval time cause link-state]
Parameter	<i>time</i> : Indicates the automatic recovery time. The value ranges from 30 to 86,400. The unit is second.
Description	<i>link-state</i> : Restores the port that is set to the errdisable state by the REUP link state tracking function.
Defaults	By default, port errdisable recovery is disabled.
Command	Global configuration mode, privileged EXEC mode
Mode	
Usage Guide	By default, a port in errdisable state is not recovered. You can recover the port manually or run this command to automatically recover the port.

⌵ Configuring MAC Addresses for Interfaces

- Optional. If this function is required, run the **mac-address** command in interface configuration mode.
- By default, MAC addresses of interfaces have fixed values.

Command	mac-address mac-address
Parameter	<i>mac-address</i> : Indicates a valid MAC address.
Description	

Command	Interface configuration mode
Mode	
Usage Guide	This feature is supported on L3 ports and SVIs (on some models).

📌 **Configuring the VLAN Encapsulation Flag for Interfaces**

- Optional. If this function is required, run the **encapsulation dot1Q** command in interface configuration mode.
- By default, the VLAN encapsulation protocol is disabled for interfaces.

Command	encapsulation dot1Q <i>VlanID</i>
Parameter	<i>vlanID</i> : Indicates the VLAN ID. The value range is from 1 to 4094 .
Description	
Command	Interface configuration mode
Mode	
Usage Guide	N/A

📌 **Configuring Interface FEC Mode**

- Optional.
- By default, FEC mode is related with the port type and depends on the product model.

Command	fec mode {rs base-r none auto}
Parameter	rs: Enable FEC mode by rs.
Description	base-r: Enable FEC mode by base-r. none: Disable FEC function. auto: Whether the FEC mode is enabled or disabled is determined by the inserted optical module.
Command	Interface configuration mode
Mode	
Usage Guide	When one end runs FEC function, the other end should enable it, too. On the premise of not affecting the negotiation status of the two ends, we suggest you NOT to: <ul style="list-style-type: none"> ● enable FEC function on the QSFP28-100G-LR4 optical module, on which FEC function is disabled by default. ● disable FEC function on QSFP28 modules (except QSFP28-100G-LR4), on which FEC function is enabled by default.

📌 **Configuring Statistics Sampling Cycle on Ethernet Port**

- Optional.
- The default statistics sampling cycle of Ethernet ports is 5 seconds.

Command	ethernet-port counter sample-period [seconds]
Parameter	seconds: Unit of the sampling cycle.
Description	
Defaults	rs: Enable FEC mode by rs. Supported by 100 Gbps port. base-r: Enable FEC mode by base-r. Supported by 25 Gbps port. none: Enable FEC function. auto: Whether the FEC mode is enabled or disabled is determined by the inserted optical module. Supported by 100 Gbps port.
Command	Interface configuration mode
Mode	

Usage Guide	A shorter sampling cycle indicates higher system performance consumption. Therefore, the sampling cycle must be adjusted as required.
--------------------	---

↘ **Configuring Statistics Sampling Cycle on Ethernet Sub-Port**

- Optional.
- The default statistics sampling cycle of Ethernet sub-ports is 5 seconds.

Command	ethernet-subport counter route-sample-period [<i>seconds</i>]
Parameter Description	<i>seconds</i> : Unit of the sampling cycle.
Command Mode	Global configuration mode
Usage Guide	A shorter sampling cycle indicates higher system performance consumption. Therefore, the sampling cycle must be adjusted as required.

↘ **Including the Interframe Gap in the Flow Statistics**

- Optional.
- By default, the interframe gap is not counted.

Command	flow-statistics include-interframe enable
Parameter Description	N/A
Command Mode	Global configuration mode
Usage Guide	After you run this command, all port rates are cleared and then recounted.

Verification

- Run the **show interfaces** command to display the attribute configurations of interfaces.

Command	show interfaces [<i>interface-type interface-number</i>] [description switchport trunk]
Parameter Description	<i>interface-type interface-number</i> : Indicates the type and number of the interface. description : Indicates the interface description, including the link status. switchport : Indicates the L2 interface information. This parameter is effective only for a L2 interface. trunk : Indicates the Trunk port information. This parameter is effective for a physical port or an AP port.
Command Mode	Privileged EXEC mode
Usage Guide	Use this command without any parameter to display the basic interface information.
	<pre>SwitchA#show interfaces GigabitEthernet 0/1 Index(dec):1 (hex):1 GigabitEthernet 0/1 is DOWN, line protocol is DOWN Hardware is Broadcom 5464 GigabitEthernet, address is 00d0.f865.de9b (bia 00d0.f865.de9b) Interface address is: no ip address Interface IPv6 address is:</pre>

```

No IPv6 address

MTU 1500 bytes, BW 1000000 Kbit

Encapsulation protocol is Ethernet-II, loopback not set

Keepalive interval is 10 sec, set

Carrier delay is 2 sec

Ethernet attributes:

  Last link state change time: 2012-12-22 14:00:48

  Time duration since last link state change: 3 days, 2 hours, 50 minutes, 50 seconds

  Priority is 0

  Medium-type is Copper

  Admin duplex mode is AUTO, oper duplex is Unknown

  Admin speed is AUTO, oper speed is Unknown

  Flow receive control admin status is OFF,flow send control admin status is OFF

  Flow receive control oper status is Unknown,flow send control oper status is Unknown

  Storm Control: Broadcast is OFF, Multicast is OFF, Unicast is OFF

Bridge attributes:

  Port-type: trunk

  Native vlan:1

  Allowed vlan lists:1-4094 //Allowed VLAN list of the Trunk port

  Active vlan lists:1, 3-4 //Active VLAN list (indicating that only VLAN 1, VLAN 3, and VLAN 4 are created on the
device)

  Rxload is 1/255,Txload is 1/255

  5 minutes input rate 0 bits/sec, 0 packets/sec

  5 minutes output rate 0 bits/sec, 0 packets/sec

  0 packets input, 0 bytes, 0 no buffer, 0 dropped

  Received 0 broadcasts, 0 runts, 0 giants

  0 input errors, 0 CRC, 0 frame, 0 overrun, 0 abort

  0 packets output, 0 bytes, 0 underruns, 0 dropped

  0 output errors, 0 collisions, 0 interface resets
    
```

- Run the **show eee interfaces status** command to display the EEE status of an interface.

Command	show eee interfaces { <i>interface-type interface-number</i> <i>status</i> }
Parameter	<i>interface-type interface-number</i> : Indicates the type and number of an interface.
Description	status : Indicates the EEE status of all interfaces.
Command Mode	Privileged EXEC mode

Usage Guide	If the interface is specified, the EEE status of the specified interface is displayed; otherwise, the EEE status of all interfaces is displayed.																				
	<p>1. Display the EEE status of GigabitEthernet 0/1.</p> <pre data-bbox="335 315 1470 703">FS#show eee interface gigabitEthernet 0/1 Interface : Gi0/1 EEE Support : Yes Admin Status : Enable Oper Status : Disable Remote Status : Disable Trouble Cause : Remote Disable</pre> <table border="1" data-bbox="335 703 1470 958"> <tr> <td>Interface</td> <td>Indicates the interface information.</td> </tr> <tr> <td>EEE Support</td> <td>Indicates whether EEE is supported.</td> </tr> <tr> <td>Admin Status</td> <td>Indicates the administrative status.</td> </tr> <tr> <td>Oper Status</td> <td>Indicates the operational status.</td> </tr> <tr> <td>Trouble Cause</td> <td>Indicates the reason why the EEE status of an interface is abnormal.</td> </tr> </table> <p>2. Display the EEE status of all interfaces.</p> <pre data-bbox="335 1003 1470 1771">FS#show eee interface status Interface EEE Admin Oper Remote Trouble Support Status Status Status Cause ----- Gi0/1 Yes Enable Disable Disable Remote Disable Gi0/2 Yes Enable Disable Unknown None Gi0/3 Yes Enable Enable Enable None Gi0/4 Yes Enable Enable Enable None Gi0/5 Yes Enable Enable Enable None Gi0/6 Yes Enable Enable Enable None Gi0/7 Yes Enable Enable Enable None Gi0/8 Yes Enable Enable Enable None Gi0/9 Yes Enable Enable Enable None Gi0/10 Yes Enable Enable Enable None</pre> <table border="1" data-bbox="335 1771 1470 2027"> <tr> <td>Interface</td> <td>Indicates the interface information.</td> </tr> <tr> <td>EEE Support</td> <td>Indicates whether EEE is supported.</td> </tr> <tr> <td>Admin Status</td> <td>Indicates the administrative status.</td> </tr> <tr> <td>Oper Status</td> <td>Indicates the operational status.</td> </tr> <tr> <td>Trouble Cause</td> <td>Indicates the reason why the EEE status of an interface is abnormal.</td> </tr> </table>	Interface	Indicates the interface information.	EEE Support	Indicates whether EEE is supported.	Admin Status	Indicates the administrative status.	Oper Status	Indicates the operational status.	Trouble Cause	Indicates the reason why the EEE status of an interface is abnormal.	Interface	Indicates the interface information.	EEE Support	Indicates whether EEE is supported.	Admin Status	Indicates the administrative status.	Oper Status	Indicates the operational status.	Trouble Cause	Indicates the reason why the EEE status of an interface is abnormal.
Interface	Indicates the interface information.																				
EEE Support	Indicates whether EEE is supported.																				
Admin Status	Indicates the administrative status.																				
Oper Status	Indicates the operational status.																				
Trouble Cause	Indicates the reason why the EEE status of an interface is abnormal.																				
Interface	Indicates the interface information.																				
EEE Support	Indicates whether EEE is supported.																				
Admin Status	Indicates the administrative status.																				
Oper Status	Indicates the operational status.																				
Trouble Cause	Indicates the reason why the EEE status of an interface is abnormal.																				

- Run the **show interfaces counters rate** command to display transmission rates of ports.

Command	show interfaces counters rate [up down]																																																
Parameter Description	up: Displays transmission rates of ports that are up. down: Displays transmission rates of ports that are down.																																																
Command Mode	Privileged EXEC mode																																																
Usage Guide	If the interface is not specified, the transmission rates of all physical ports and aggregation ports are displayed.																																																
	<p>1. Display the transmission rates of all up ports.</p> <pre>FS#show interfaces counters rate up</pre> <table border="1"> <thead> <tr> <th>Interface</th> <th>Sampling Time</th> <th>Input Rate (bits/sec)</th> <th>Input Rate (packets/sec)</th> <th>Output Rate (bits/sec)</th> <th>Output Rate (packets/sec)</th> </tr> </thead> <tbody> <tr> <td>Te1/21</td> <td>5 seconds</td> <td>0</td> <td>0</td> <td>762</td> <td>0</td> </tr> <tr> <td>Te1/22</td> <td>5 seconds</td> <td>0</td> <td>0</td> <td>212</td> <td>0</td> </tr> <tr> <td>Te1/23</td> <td>5 seconds</td> <td>511546</td> <td>999</td> <td>762</td> <td>0</td> </tr> <tr> <td>Te1/24</td> <td>5 seconds</td> <td>0</td> <td>0</td> <td>762</td> <td>0</td> </tr> <tr> <td>Te8/1</td> <td>5 seconds</td> <td>0</td> <td>0</td> <td>546946</td> <td></td> </tr> <tr> <td>1004</td> <td></td> <td></td> <td></td> <td></td> <td></td> </tr> <tr> <td>Ag4</td> <td>5 seconds</td> <td>0</td> <td>0</td> <td>834</td> <td>0</td> </tr> </tbody> </table>	Interface	Sampling Time	Input Rate (bits/sec)	Input Rate (packets/sec)	Output Rate (bits/sec)	Output Rate (packets/sec)	Te1/21	5 seconds	0	0	762	0	Te1/22	5 seconds	0	0	212	0	Te1/23	5 seconds	511546	999	762	0	Te1/24	5 seconds	0	0	762	0	Te8/1	5 seconds	0	0	546946		1004						Ag4	5 seconds	0	0	834	0
Interface	Sampling Time	Input Rate (bits/sec)	Input Rate (packets/sec)	Output Rate (bits/sec)	Output Rate (packets/sec)																																												
Te1/21	5 seconds	0	0	762	0																																												
Te1/22	5 seconds	0	0	212	0																																												
Te1/23	5 seconds	511546	999	762	0																																												
Te1/24	5 seconds	0	0	762	0																																												
Te8/1	5 seconds	0	0	546946																																													
1004																																																	
Ag4	5 seconds	0	0	834	0																																												

- Run the **show interfaces brief** command to display transmission rates of ports.

Command	show interfaces [<i>interface-type interface-number</i>] brief [up down]														
Parameter Description	<i>interface-type interface-number</i> : Specifies an interface. If this field is not specified, information of all ports are displayed. up: Indicates connected ports. down: indicates disconnected ports.														
Command Mode	Privileged EXEC mode														
Usage Guide	By running this command, brief information of ports is displayed, including port status, interface status, output and input bandwidth usage, and the number of output and input packet errors.														
	<p>1. Display the brief information of the TenGigabitEthernet 0/1 port.</p> <pre>FS#show interfaces TenGigabitEthernet 0/1 brief</pre> <pre>down: link down</pre> <pre>*down: administratively down</pre> <pre>disabled: err-disabled(Please reference to command [show interface status err-disabled] for detail.)</pre> <table border="1"> <thead> <tr> <th>Interface</th> <th>Link Stat</th> <th>Protocol Stat</th> <th>Output Usage</th> <th>Input Usage</th> <th>inErrors</th> <th>outErrors</th> </tr> </thead> <tbody> <tr> <td>Te0/1</td> <td>disabled</td> <td>down</td> <td>0.00%</td> <td>0.00%</td> <td>0</td> <td>0</td> </tr> </tbody> </table> <p>2. Display the brief information of all connected ports.</p> <pre>FS#show interfaces brief up</pre> <pre>down: link down</pre>	Interface	Link Stat	Protocol Stat	Output Usage	Input Usage	inErrors	outErrors	Te0/1	disabled	down	0.00%	0.00%	0	0
Interface	Link Stat	Protocol Stat	Output Usage	Input Usage	inErrors	outErrors									
Te0/1	disabled	down	0.00%	0.00%	0	0									

```
*down: administratively down
disabled: err-disabled(Please reference to command [show interface status err-disabled] for detail.)
Interface  Link Stat  Protocol Stat  Output Usage  Input Usage  inErrors  outErrors
-----
Te0/1      up         up             83.40%        78.20%        0         0
Te0/2      up         up             82.00%        73.40%        0         0
```

3. Displays the brief information of all the ports.

```
FS#show interfaces brief
down: link down
*down: administratively down
disabled: err-disabled(Please reference to command [show interface status err-disabled] for detail.)
Interface  Link Stat  Protocol Stat  Output Usage  Input Usage  inErrors  outErrors
-----
Te0/1      down      down           0.00%         0.00%         0         0
Te0/2      down      down           0.00%         0.00%         0         0
Te0/3      down      down           0.00%         0.00%         0         0
Te0/4      down      down           0.00%         0.00%         0         0
Te0/5      down      down           0.00%         0.00%         0         0
Te0/6      down      down           0.00%         0.00%         0         0
Te0/7      down      down           0.00%         0.00%         0         0
Te0/8      down      down           0.00%         0.00%         0         0
Te0/9      down      down           0.00%         0.00%         0         0
Te0/10     disabled  down           0.00%         0.00%         0         0
```

Configuration Example

➤ **Configuring Interface Attributes**

<p>Scenario Figure 1-6</p>	
<p>Configuration Steps</p>	<ul style="list-style-type: none"> ● On Switch A, configure GigabitEthernet 0/1 as an access mode, and the default VLAN ID is 1. Configure SVI 1, assign an IP address to SVI 1, and set up a route to Switch D. ● On Switch B, configure GigabitEthernet 0/1 and GigabitEthernet 0/2 as Trunk ports, and the default VLAN ID is 1. Configure SVI 1, and assign an IP address to SVI 1. Configure GigabitEthernet 0/3 as a routed port, and assign an IP address from another network segment to this port. ● On Switch C, configure GigabitEthernet 0/1 as an Access port, and the default VLAN ID is 1. Configure SVI 1, and assign an IP address to SVI 1. ● On Switch D, configure GigabitEthernet 0/1 as a routed port, assign an IP address to this port, and set up a route to Switch A.
<p>A</p>	<pre>A# configure terminal A(config)# interface GigabitEthernet 0/1 A(config-if-GigabitEthernet 0/1)# switchport mode access A(config-if-GigabitEthernet 0/1)# switchport access vlan 1 A(config-if-GigabitEthernet 0/1)# exit A(config)# interface vlan 1 A(config-if-VLAN 1)# ip address 192.168.1.1 255.255.255.0 A(config-if-VLAN 1)# exit A(config)# ip route 192.168.2.0 255.255.255.0 VLAN 1 192.168.1.2</pre>
<p>B</p>	<pre>B# configure terminal B(config)# interface GigabitEthernet 0/1 B(config-if-GigabitEthernet 0/1)# switchport mode trunk B(config-if-GigabitEthernet 0/1)# exit B(config)# interface GigabitEthernet 0/2 B(config-if-GigabitEthernet 0/2)# switchport mode trunk</pre>

	<pre> B(config-if-GigabitEthernet 0/2)# exit B(config)# interface vlan 1 B(config-if-VLAN 1)# ip address 192.168.1.2 255.255.255.0 B(config-if-VLAN 1)# exit B(config)# interface GigabitEthernet 0/3 B(config-if-GigabitEthernet 0/3)# no switchport B(config-if-GigabitEthernet 0/3)# ip address 192.168.2.2 255.255.255.0 B(config-if-GigabitEthernet 0/3)# exit </pre>
C	<pre> C# configure terminal C(config)# interface GigabitEthernet 0/1 C(config-if-GigabitEthernet 0/1)# port-group 1 C(config-if-GigabitEthernet 0/1)# exit C(config)# interface aggregateport 1 C(config-if-AggregatePort 1)# switchport mode access C(config-if-AggregatePort 1)# switchport access vlan 1 C(config-if-AggregatePort 1)# exit C(config)# interface vlan 1 C(config-if-VLAN 1)# ip address 192.168.1.3 255.255.255.0 C(config-if-VLAN 1)# exit </pre>
D	<pre> D# configure terminal D(config)# interface GigabitEthernet 0/1 D(config-if-GigabitEthernet 0/1)# no switchport D(config-if-GigabitEthernet 0/1)# ip address 192.168.2.1 255.255.255.0 D(config-if-GigabitEthernet 0/1)# exit A(config)# ip route 192.168.1.0 255.255.255.0 GigabitEthernet 0/1 192.168.2.2 </pre>
Verification	<p>Perform verification on Switch A, Switch B, Switch C, and Switch D as follows:</p> <ul style="list-style-type: none"> ● On Switch A, ping the IP addresses of interfaces of the other three switches. Verify that you can access the other three switches on Switch A.. ● Verify that switch B and Switch D can be pinged mutually. ● Verify that the interface status is correct.
A	<pre> A# show interfaces gigabitEthernet 0/1 Index(dec):1 (hex):1 GigabitEthernet 0/1 is UP, line protocol is UP </pre>

	<p>Hardware is GigabitEthernet, address is 00d0.f865.de90 (bia 00d0.f865.de90)</p> <p>Interface address is: no ip address</p> <p>MTU 1500 bytes, BW 100000 Kbit</p> <p>Encapsulation protocol is Ethernet-II, loopback not set</p> <p>Keepalive interval is 10 sec, set</p> <p>Carrier delay is 2 sec</p> <p>Ethernet attributes:</p> <p>Last link state change time: 2012-12-22 14:00:48</p> <p>Time duration since last link state change: 3 days, 2 hours, 50 minutes, 50 seconds</p> <p>Priority is 0</p> <p>Admin medium-type is Copper, oper medium-type is Copper</p> <p>Admin duplex mode is AUTO, oper duplex is Full</p> <p>Admin speed is AUTO, oper speed is 100M</p> <p>Flow control admin status is OFF, flow control oper status is OFF</p> <p>Admin negotiation mode is OFF, oper negotiation state is ON</p> <p>Storm Control: Broadcast is OFF, Multicast is OFF, Unicast is OFF</p> <p>Bridge attributes:</p> <p>Port-type: access</p> <p>Vlan id: 1</p> <p>Rxload is 1/255, Txload is 1/255</p> <p>10 seconds input rate 0 bits/sec, 0 packets/sec</p> <p>10 seconds output rate 67 bits/sec, 0 packets/sec</p> <p>362 packets input, 87760 bytes, 0 no buffer, 0 dropped</p> <p>Received 0 broadcasts, 0 runts, 0 giants</p> <p>0 input errors, 0 CRC, 0 frame, 0 overrun, 0 abort</p> <p>363 packets output, 82260 bytes, 0 underruns, 0 dropped</p> <p>0 output errors, 0 collisions, 0 interface resets</p>
<p>B</p>	<p>B# show interfaces gigabitEthernet 0/1</p> <p>Index(dec):1 (hex):1</p> <p>GigabitEthernet 0/1 is UP, line protocol is UP</p> <p>Hardware is GigabitEthernet, address is 00d0.f865.de91 (bia 00d0.f865.de91)</p> <p>Interface address is: no ip address</p> <p>MTU 1500 bytes, BW 100000 Kbit</p> <p>Encapsulation protocol is Ethernet-II, loopback not set</p>

	<p>Keepalive interval is 10 sec, set</p> <p>Carrier delay is 2 sec</p> <p>Ethernet attributes:</p> <p> Last link state change time: 2012-12-22 14:00:48</p> <p> Time duration since last link state change: 3 days, 2 hours, 50 minutes, 50 seconds</p> <p> Priority is 0</p> <p> Admin medium-type is Copper, oper medium-type is Copper</p> <p> Admin duplex mode is AUTO, oper duplex is Full</p> <p> Admin speed is AUTO, oper speed is 100M</p> <p> Flow control admin status is OFF, flow control oper status is OFF</p> <p> Admin negotiation mode is OFF, oper negotiation state is ON</p> <p> Storm Control: Broadcast is OFF, Multicast is OFF, Unicast is OFF</p> <p>Bridge attributes:</p> <p> Port-type: trunk</p> <p> Native vlan: 1</p> <p> Allowed vlan lists: 1-4094</p> <p> Active vlan lists: 1</p> <p>Rxload is 1/255, Txload is 1/255</p> <p>10 seconds input rate 0 bits/sec, 0 packets/sec</p> <p>10 seconds output rate 67 bits/sec, 0 packets/sec</p> <p> 362 packets input, 87760 bytes, 0 no buffer, 0 dropped</p> <p> Received 0 broadcasts, 0 runts, 0 giants</p> <p> 0 input errors, 0 CRC, 0 frame, 0 overrun, 0 abort</p> <p> 363 packets output, 82260 bytes, 0 underruns, 0 dropped</p> <p> 0 output errors, 0 collisions, 0 interface resets</p>
<p>C</p>	<pre>C# show interfaces gigabitEthernet 0/1 Index(dec):1 (hex):1 GigabitEthernet 0/1 is UP, line protocol is UP Hardware is GigabitEthernet, address is 00d0.f865.de92 (bia 00d0.f865.de92) Interface address is: no ip address MTU 1500 bytes, BW 100000 Kbit Encapsulation protocol is Ethernet-II, loopback not set Keepalive interval is 10 sec, set Carrier delay is 2 sec</pre>

	<p>Ethernet attributes:</p> <p>Last link state change time: 2012-12-22 14:00:48</p> <p>Time duration since last link state change: 3 days, 2 hours, 50 minutes, 50 seconds</p> <p>Priority is 0</p> <p>Admin medium-type is Copper, oper medium-type is Copper</p> <p>Admin duplex mode is AUTO, oper duplex is Full</p> <p>Admin speed is AUTO, oper speed is 100M</p> <p>Flow control admin status is OFF, flow control oper status is OFF</p> <p>Admin negotiation mode is OFF, oper negotiation state is ON</p> <p>Storm Control: Broadcast is OFF, Multicast is OFF, Unicast is OFF</p> <p>Rxload is 1/255, Txload is 1/255</p> <p>10 seconds input rate 0 bits/sec, 0 packets/sec</p> <p>10 seconds output rate 67 bits/sec, 0 packets/sec</p> <p>362 packets input, 87760 bytes, 0 no buffer, 0 dropped</p> <p>Received 0 broadcasts, 0 runts, 0 giants</p> <p>0 input errors, 0 CRC, 0 frame, 0 overrun, 0 abort</p> <p>363 packets output, 82260 bytes, 0 underruns, 0 dropped</p> <p>0 output errors, 0 collisions, 0 interface resets</p>
<p>D</p>	<p>D# show interfaces gigabitEthernet 0/1</p> <p>Index(dec):1 (hex):1</p> <p>GigabitEthernet 0/1 is UP, line protocol is UP</p> <p>Hardware is GigabitEthernet, address is 00d0.f865.de93 (bia 00d0.f865.de93)</p> <p>Interface address is: 192.168.2.1/24</p> <p>MTU 1500 bytes, BW 100000 Kbit</p> <p>Encapsulation protocol is Ethernet-II, loopback not set</p> <p>Keepalive interval is 10 sec, set</p> <p>Carrier delay is 2 sec</p> <p>Ethernet attributes:</p> <p>Last link state change time: 2012-12-22 14:00:48</p> <p>Time duration since last link state change: 3 days, 2 hours, 50 minutes, 50 seconds</p> <p>Priority is 0</p> <p>Admin medium-type is Copper, oper medium-type is Copper</p> <p>Admin duplex mode is AUTO, oper duplex is Full</p> <p>Admin speed is AUTO, oper speed is 100M</p>

	<p>Flow control admin status is OFF, flow control oper status is OFF</p> <p>Admin negotiation mode is OFF, oper negotiation state is ON</p> <p>Storm Control: Broadcast is OFF, Multicast is OFF, Unicast is OFF</p> <p>Rxload is 1/255, Txload is 1/255</p> <p>10 seconds input rate 0 bits/sec, 0 packets/sec</p> <p>10 seconds output rate 67 bits/sec, 0 packets/sec</p> <p>362 packets input, 87760 bytes, 0 no buffer, 0 dropped</p> <p>Received 0 broadcasts, 0 runts, 0 giants</p> <p>0 input errors, 0 CRC, 0 frame, 0 overrun, 0 abort</p> <p>363 packets output, 82260 bytes, 0 underruns, 0 dropped</p> <p>0 output errors, 0 collisions, 0 interface resets</p>
--	--

22.6 Monitoring

Clearing



Running the **clear** commands may lose vital information and thus interrupt services.

Description	Command
Clears the counters of a specified interface.	clear counters [<i>interface-type interface-number</i>]
Resets the interface hardware.	clear interface <i>interface-type interface-number</i>
Clears the statistics of link status change.	clear link-state-change statistics [<i>interface-type interface-number</i>]

Displaying



Displaying Interface Configurations and Status

Description	Command
Displays all the status and configuration information of a specified interface.	show interfaces [<i>interface-type interface-number</i>]
Displays the interface status.	show interfaces [<i>interface-type interface-number</i>] status
Displays the interface errdisable status.	show interfaces [<i>interface-type interface-number</i>] status err-disable
Displays the link status change time and count of a specified port.	show interfaces [<i>interface-type interface-number</i>] link-state-change statistics
Displays the administrative and operational states of switch ports (non-routed ports).	show interfaces [<i>interface-type interface-number</i>] switchport
Displays the description and status of a specified interface.	show interfaces [<i>interface-type interface-number</i>] description
Displays the counters of a specified port, among which the displayed speed may have an error of ±0.5%.	show interfaces [<i>interface-type interface-number</i>] counters

Description	Command
Displays the number of packets increased in a load interval.	show interfaces [<i>interface-type interface-number</i>] counters increment
Displays statistics about error packets.	show interfaces [<i>interface-type interface-number</i>] counters error
Displays the packet sending/receiving rate of an interface.	show interfaces [<i>interface-type interface-number</i>] counters rate
Displays the packet sending/receiving rate of an interface at the physical layer. The packet sending/receiving rate at the physical layer refers to the sending/receiving rate of packets that contain interframe spacing.	show interfaces [<i>interface-type interface-number</i>] counters rate physical-layer
Displays a summary of interface information.	show interfaces [<i>interface-type interface-number</i>] counters summary
Displays the bandwidth usage of an interface.	show interfaces [<i>interface-type interface-number</i>] usage [up down]
Displays brief information of ports.	show interfaces [<i>interface-type interface-number</i>] brief [up down]
Displays the global MTU information.	show interface [<i>interface-type interface-number</i>] mtu forwarding
Displays the sub VLAN interface information.	show vlans

📌 Displaying Optical Module Information

Description	Command
Displays basic information about the optical module of a specified interface.	show interfaces [<i>interface-type interface-number</i>] transceiver
Displays the fault alarms of the optical module on a specified interface. If no fault occurs, "None" is displayed.	show interfaces [<i>interface-type interface-number</i>] transceiver alarm
Displays the optical module diagnosis values of a specified interface.	show interfaces [<i>interface-type interface-number</i>] transceiver diagnosis

23 Configuring Single Fiber

23.1 Overview

Single Fiber (SF) is a function developed to meet the special requirement for only receiving packets but not sending packets. In normal cases, when Ethernet standard devices interwork with each other by using optical transceivers, dual-fiber optical transceivers must be used so that the link becomes up and packets are forwarded normally. The disadvantage, however, is that physical isolation cannot be smoothly achieved in the transmission direction when Ethernet standard devices send data through dual fibers. As a result, the peer switch may receive unpredictable packets, affecting the switch security. For this, the SF mode can be configured to physically isolate data in the transmission direction to ensure data security. The application of SF-mode ports does not conform to the link specifications of Ethernet device ports. Therefore, for the implementation of SF receiving, a single-core fiber needs to be connected to the Rx end of a switch port so that data from the Tx end of the peer optical transceiver can be received normally.

23.2 Applications

Application	Description
<u>SF Receiving</u>	The Rx end of a switch port is connected to the Tx end of an optical splitter through a single-core fiber.

23.2.1 SF Receiving

Scenario

The Rx end of a switch port is connected to the Tx end of an optical splitter through a single-core fiber, and the Rx end of the optical splitter is not connected to the Tx end of the connected switch, to ensure physical isolation.

Figure 2-1



Deployment

- The switch can only receive packets from the optical splitter but cannot send packets to the optical splitter.

23.3 Configuration

Configuration	Description and Command	
Configuring the SF Mode	(Mandatory) It is used to configure the SF mode.	
	transport mode { rx }	Configures the SF Rx mode.
	no transport mode	Restores the default mode, that is, dual-fiber bidirectional Rx/Tx mode.

23.3.1 Configuring the SF Mode

Configuration Effect

- Configure a port of the switch to support the SF mode and the Rx direction only.

Notes

Configuration Steps

1. **Configuring the SF Mode**

- Mandatory.
- The SF mode should be configured on the port that requires the SF Rx function unless otherwise stated.

Command	transport mode {rx}
Parameter Description	rx: Indicates the mode in which only packets are received.
Defaults	The SF mode is disabled by default.
Command Mode	Interface configuration mode
Usage Guide	N/A

Verification

Verify the SF configuration:

- Check whether the port on which the SF Rx function is configured can be up normally.
- Check whether the light emission function is disabled for the port on which the SF Rx function is configured.
- Verify that the port on which the SF Rx function is configured can only receive packets but cannot send packets.

23.4 Monitoring

Displaying

Description	Command
Displays information about the port on which the SF Rx function is configured.	show transport mode {rx}

24 Configuring MAC Address

24.1 Overview

A MAC address table contains the MAC addresses, interface numbers and VLAN IDs of the devices connected to the local device.

When a device forwards a packet, it finds an output port from its MAC address table according to the destination MAC address and the VLAN ID of the packet.

After that, the packet is unicast, multicast or broadcast.

i This document covers dynamic MAC addresses, static MAC addresses and filtered MAC addresses. For the management of multicast MAC addresses, please see *Configuring IGMP Snooping Configuration*.

Protocols and Standards

- IEEE 802.3: Carrier sense multiple access with collision detection (CSMA/CD) access method and physical layer specifications
- IEEE 802.1Q: Virtual Bridged Local Area Networks

24.2 Applications

Application	Description
<u>MAC Address Learning</u>	Forward unicast packets through MAC addresses learning.
<u>MAC Address Change Notification</u>	Monitor change of the devices connected to a network device through MAC address change notification.

24.2.1 MAC Address Learning

Scenario

Usually a device maintains a MAC address table by learning MAC addresses dynamically. The operating principle is described as follows:

As shown in the following figure, the MAC address table of the switch is empty. When User A communicates with User B, it sends a packet to the port GigabitEthernet 0/2 of the switch, and the switch learns the MAC address of User A and stores it in the table. As the table does not contain the MAC address of User B, the switch broadcasts the packet to the ports of all connected devices except User A, including User B and User C.

Figure 3-1 Step 1 of MAC Address Learning

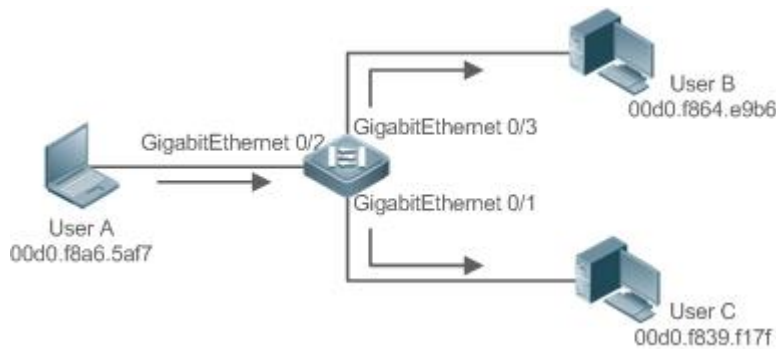

Figure 3-2 MAC Address Table 1

Status	VLAN	MAC address	Interface
Dynamic	1	00d0.f8a6.5af7	GigabitEthernet 0/2

When User B receives the packet, it sends a reply packet to User A through port GigabitEthernet 0/3 on the switch. As the MAC address of User A is already in the MAC address table, the switch send the reply unicast packet to port GigabitEthernet 0/2 port and learns the MAC address of User B. User C does not receive the reply packet from User B to User A.

Figure 3-3 Step 2 of MAC Address Learning

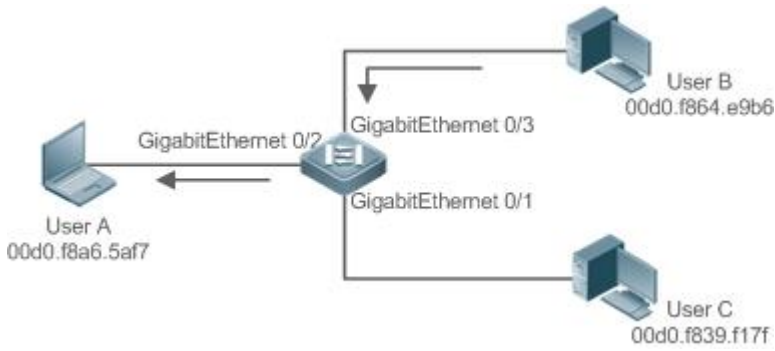

Figure 3-4 MAC Address Table 2

Status	VLAN	MAC address	Interface
Dynamic	1	00d0.f8a6.5af7	GigabitEthernet 0/2
Dynamic	1	00d0.f8a4.e9b6	GigabitEthernet 0/3

Through the interaction between User A and User B, the switch learns the MAC addresses of User A and User B. After that, packets between User A and User B will be exchanged via unicast without being received by User C.

Deployment

- With MAC address learning, a layer-2 switch forwards packets through unicast, reducing broadcast packets and network load.

24.2.2 MAC Address Change Notification

MAC address change notification provides a mechanism for the network management system (NMS) to monitor the change of devices connected to a network device.

Scenario

Figure 3-5 MAC Address Change Notification

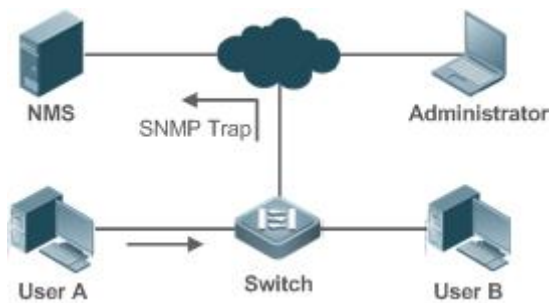

After MAC address change notification is enabled on a device, the device generates a notification message when the device learns a new MAC address or finishes aging a learned MAC address, and sends the message in an SNMP Trap message to a specified NMS.

A notification of adding a MAC address indicates that a new user accesses the network, and that of deleting a MAC address indicates that a user sends no packets within an aging time and usually the user exits the network.

When a network device is connected to a number of devices, a lot of MAC address changes may occur in a short time, resulting in an increase in traffic. To reduce traffic, you may configure an interval for sending MAC address change notifications. When the interval expires, all notifications generated during the interval are encapsulated into a message.

When a notification is generated, it is stored in the table of historical MAC address change notifications. The administrator may know recent MAC address changes by checking the table of notification history even without NMS.

i A MAC address change notification is generated only for a dynamic MAC address.

Deployment

- Enable MAC address change notification on a layer-2 switch to monitor the change of devices connected to a network device.

24.3Features

Basic Concepts

↘ Dynamic MAC Address

A dynamic MAC address is a MAC address entry generated through the process of MAC address learning by a device.

↘ Address Aging

A device only learns a limited number of MAC addresses, and inactive entries are deleted through address aging.

A device starts aging a MAC address when it learns it. If the device receives no packet containing the source MAC address, it will delete the MAC address from the MAC address table when the time expires.

↘ Forwarding via Unicast

If a device finds in its MAC address table an entry containing the MAC address and the VLAN ID of a packet and the output port is unique, it will send the packet through the port directly.

↘ Forwarding via Broadcast

If a device receives a packet containing the destination address `ffff.ffff.ffff` or an unidentified destination address, it will send the packet through all the ports in the VLAN where the packet is from, except the input port.

Overview

Feature	Description
Dynamic Address Limit for VLAN	Limit the number of dynamic MAC addresses in a VLAN.
Dynamic Address Limit for Interface	Limit the number of dynamic MAC addresses on an interface.

24.3.1Dynamic Address Limit for VLAN

Working Principle

The MAC address table with a limited capacity is shared by all VLANs. Configure the maximum number of dynamic MAC addresses for each VLAN to prevent one single VLAN from exhausting the MAC address table space.

A VLAN can only learn a limited number of dynamic MAC addresses after the limit is configured. The packets exceeding the limit are broadcast.

i If the number of learned MAC addresses is greater than the limit, a device will stop learning the MAC addresses from the VLAN and will not start learning again until the number drops below the limit after address aging.

i The MAC addresses copied to a specific VLAN are not subject to the limit.

24.3.2 Dynamic Address Limit for Interface

Working Principle

An interface can only learn a limited number of dynamic MAC addresses after the limit is configured. The packets exceeding the limit are broadcast

- If the number of learned MAC addresses is greater than the limit, a device will stop learning the MAC addresses from the interface and will not start learning again until the number drops below the limit after address aging.

24.4 Limitations



The products do not learn or forward packets whose source MAC address and destination MAC address is all 0.

24.5 Configuration

Configuration	Description and Command	
Configuring Dynamic MAC Address	(Optional) It is used to enable MAC address learning.	
	mac-address-learning	Configures MAC address learning globally or on an interface.
	mac-address-table aging-time	Configures an aging time for a dynamic MAC address.
Configuring a Static MAC Address	(Optional) It is used to bind the MAC address of a device with a port of a switch.	
	mac-address-table static	Configures a static MAC address.
Configuring a MAC Address for Packet Filtering	(Optional) It is used to filter packets.	
	mac-address-table filtering	Configures a MAC address for packet filtering.
Configuring MAC Address Change Notification	(Optional) It is used to monitor change of devices connected to a network device.	
	mac-address-table notification	Configures MAC address change notification globally.
	snmp trap mac-notification	Configures MAC address change notification on an interface.
Configuring a Management VLAN for an AP Port	(Optional) It is used to configure a management VLAN for an AP port.	
	aggregateport-admin vlan	Configures a management VLAN for an AP port.
Configuring the Alarm Logging Function for MAC Address Drift	(Optional) It is used to configure the alarm logging function for detected MAC address drift.	
	mac-address-table flapping-logging	
Configuring the Maximum Number of Learned MAC Addresses	(Optional) It is used to configure the maximum number of learned MAC addresses.	
	max-dynamic-mac-count <i>count</i>	
Configuring Packet Discarding When the Number of Learned	(Optional) It is used to configure the packet processing method when the number of learned MAC addresses exceeds the address limit.	

Configuration	Description and Command
MAC Addresses Exceeds the Address Limit	max-dynamic-mac-count exceed-action <i>forward discard</i>

24.5.1 Configuring Dynamic MAC Address

Configuration Effect

Learn MAC addresses dynamically and forward packets via unicast.

Configuration Steps

✚ Configuring Global MAC Address Learning

- Optional.
- You can perform this configuration to disable global MAC address learning.
- Configuration:

Command	mac-address-learning { enable disable }
Parameter	enable: Enables global MAC address learning.
Description	disable: Disable global MAC address learning.
Defaults	Global MAC address learning is enabled by default.
Command Mode	Global configuration mode
Usage Guide	N/A

i By default, global MAC address learning is enabled. When global MAC address learning is enabled, the MAC address learning configuration on an interface takes effect; when the function is disabled, MAC addresses cannot be learned globally.

✚ Configuring MAC Address Learning on Interface

- Optional.
- You can perform this configuration to disable MAC address learning on an interface.
- Configuration:

Command	mac-address-learning
Parameter	N/A
Description	
Defaults	MAC address learning is enabled by default.
Command Mode	Interface configuration mode
Usage Guide	Perform this configuration on a layer-2 interface, for example, a switch port or an AP port. When the command default interface is run in global configuration mode, if there is any layer-2 sub-interface, the MAC address learning cannot restore the default settings.

i By default, MAC address learning is enabled. If DOT1X, IP SOURCE GUARD, or a port security function is configured on a port, MAC address learning cannot be enabled. Access control cannot be enabled on a port with MAC address learning disabled.

✚ Configuring an Aging Time for a Dynamic MAC Address

- Optional.
- Configure an aging time for dynamic MAC addresses.
- Configuration:

Command	mac-address-table aging-time <i>value</i>
Parameter	<i>value</i> : Indicates the aging time. The value is either 0 or in the range from 10 to 1000,000.
Description	
Defaults	The default is 300s.
Command	Global configuration mode
Mode	
Usage Guide	If the value is set to 0, MAC address aging is disabled and learned MAC addresses will not be aged.

The actual aging time may be different from the configured value, but it is not more than two times of the configured value.

Verification

- Check whether a device learns dynamic MAC addresses.
- Run the **show mac-address-table dynamic** command to display dynamic MAC addresses.
- Run the **show mac-address-table aging-time** command to display the aging time for dynamic MAC addresses.

Command	show mac-address-table dynamic [address <i>mac-address</i>] [interface <i>interface-id</i>] [vlan <i>vlan-id</i>]
Parameter	address <i>mac-address</i> : Displays the information of a specific dynamic MAC address.
Description	interface <i>interface-id</i> : Specifies a physical interface or an AP port. vlan <i>vlan-id</i> : Displays the dynamic MAC addresses in a specific VLAN.
Command	Privileged EXEC mode/Global configuration mode/Interface configuration mode
Mode	
Usage Guide	N/A

```
FS# show mac-address-table dynamic
Vlan      MAC Address      Type      Interface
-----
1         0000.0000.0001   DYNAMIC   GigabitEthernet 1/1
1         0001.960c.a740   DYNAMIC   GigabitEthernet 1/1
1         0007.95c7.dff9   DYNAMIC   GigabitEthernet 1/1
1         0007.95cf.eee0   DYNAMIC   GigabitEthernet 1/1
1         0007.95cf.f41f   DYNAMIC   GigabitEthernet 1/1
1         0009.b715.d400   DYNAMIC   GigabitEthernet 1/1
1         0050.bade.63c4   DYNAMIC   GigabitEthernet 1/1
```

Field	Description
Vlan	Indicates the VLAN where the MAC address resides.
MAC Address	Indicates a MAC Address.
Type	Indicates a MAC address type.
Interface	Indicates the interface where the MAC address resides.

Command	show mac-address-table aging-time
Parameter Description	N/A
Command Mode	Privileged EXEC mode/Global configuration mode/Interface configuration mode
Usage Guide	N/A
	<pre>FS# show mac-address-table aging-time Aging time : 300</pre>

Configuration Example

📌 **Configuring Dynamic MAC Address**

<p>Scenario Figure 3-6</p>	
<p>Configuration Steps</p>	<ul style="list-style-type: none"> ● Enable MAC address learning on an interface. ● Configure the aging time for dynamic MAC addresses to 180s. ● Delete all dynamic MAC addresses in VLAN 1 on port GigabitEthernet 0/1.
	<pre>FS# configure terminal FS(config-if-GigabitEthernet 0/1)# mac-address-learning FS(config-if-GigabitEthernet 0/1)# exit FS(config)# mac aging-time 180 FS# clear mac-address-table dynamic interface GigabitEthernet 0/1 vlan 1</pre>
<p>Verification</p>	<ul style="list-style-type: none"> ● Check MAC address learning on an interface. ● Display the aging time for dynamic MAC addresses. ● Display all dynamic MAC addresses in VLAN 1 on port GigabitEthernet 0/1.
	<pre>FS# show mac-address-learning GigabitEthernet 0/1 learning ability: enable FS# show mac aging-time Aging time : 180 seconds FS# show mac-address-table dynamic interface GigabitEthernet 0/1 vlan 1 Vlan MAC Address Type Interface ----- 1 00d0.f800.1001 STATIC GigabitEthernet 1/1</pre>

Common Errors

Configure MAC address learning on an interface before configuring the interface as a layer-2 interface, for example, a switch port or an AP port.

24.5.2 Configuring a Static MAC Address

Configuration Effect

- Bind the MAC address of a network device with a port of a switch.

Configuration Steps

⤵ Configuring a Static MAC address

- Optional.
- Bind the MAC address of a network device with a port of a switch.
- Configuration:

Command	mac-address-table static <i>mac-address</i> vlan <i>vlan-id</i> interface <i>interface-id</i>
Parameter	address <i>mac-address</i> : Specifies a MAC address.
Description	vlan <i>vlan-id</i> : Specifies a VLAN where the MAC address resides. interface <i>interface-id</i> : Specifies a physical interface or an AP port.
Defaults	By default, no static MAC address is configured.
Command Mode	Global configuration mode
Usage Guide	When the switch receives a packet containing the specified MAC address on the specified VLAN, the packet is forwarded to the bound interface.

Verification

- Run the **show mac-address-table static** command to check whether the configuration takes effect.

Command	show mac-address-table static [address <i>mac-address</i>] [interface <i>interface-id</i>] [vlan <i>vlan-id</i>]
Parameter	address <i>mac-address</i> : Specifies a MAC address.
Description	interface <i>interface-id</i> : Specifies a physical interface or an AP port. vlan <i>vlan-id</i> : Specifies a VLAN where the MAC address resides.
Command Mode	Privileged EXEC mode/Global configuration mode /Interface configuration mode
Usage Guide	N/A
	<pre> FS# show mac-address-table static Vlan MAC Address Type Interface ----- 1 00d0.f800.1001 STATIC GigabitEthernet 1/1 1 00d0.f800.1002 STATIC GigabitEthernet 1/1 1 00d0.f800.1003 STATIC GigabitEthernet 1/1 </pre>

Configuration Example

Configuring a Static MAC address

In the above example, the relationship of MAC addresses, VLAN and interfaces is shown in the following table.

Role	MAC Address	VLAN ID	Interface ID
Web Server	00d0.3232.0001	VLAN2	Gi0/10
Database Server	00d0.3232.0002	VLAN2	Gi0/11
Administrator	00d0.3232.1000	VLAN2	Gi0/12

<p>Scenario Figure 3-7</p>	
<p>Configuration Steps</p>	<ul style="list-style-type: none"> Specify destination MAC addresses (<i>mac-address</i>). Specify the VLAN (<i>vlan-id</i>) where the MAC addresses reside. Specify interface IDs (<i>interface-id</i>).
<p>A</p>	<pre>A# configure terminal A(config)# mac-address-table static 00d0.f800.3232.0001 vlan 2 interface gigabitEthernet 0/10 A(config)# mac-address-table static 00d0.f800.3232.0002 vlan 2 interface gigabitEthernet 0/11 A(config)# mac-address-table static 00d0.f800.3232.1000 vlan 2 interface gigabitEthernet 0/12</pre>
<p>Verification</p>	<p>Display the static MAC address configuration on a switch.</p>
<p>A</p>	<pre>A# show mac-address-table static Vlan MAC Address Type Interface ----- 2 00d0.f800.3232.0001 STATIC GigabitEthernet 0/10 2 00d0.f800.3232.0002 STATIC GigabitEthernet 0/11 2 00d0.f800.3232.1000 STATIC GigabitEthernet 0/12</pre>

Common Errors

- Configure a static MAC address before configuring the specific port as a layer-2 interface, for example, a switch port or an AP port.

24.5.3 Configuring a MAC Address for Packet Filtering

Configuration Effect

- If a device receives packets containing a source MAC address or destination MAC address specified as the filtered MAC address, the packets are discarded.

Configuration Steps

▾ Configuring a MAC Address for Packet Filtering

- Optional.
- Perform this configuration to filter packets.
- Configuration:

Command	mac-address-table filtering <i>mac-address</i> vlan <i>vlan-id</i>
Parameter	address <i>mac-address</i> : Specifies a MAC address.
Description	vlan <i>vlan-id</i> : Specifies a VLAN where the MAC address resides.
Defaults	By default, no filtered MAC address is configured.
Command Mode	Global configuration mode
Usage Guide	If a device receives packets containing a source MAC address or destination MAC address specified as the filtered MAC address, the packets are discarded.

Verification

- Run the **show mac-address-table filter** command to display the filtered MAC address.

Command	show mac-address-table filter [address <i>mac-address</i>] [vlan <i>vlan-id</i>]
Parameter	address <i>mac-address</i> : Specifies a MAC address.
Description	vlan <i>vlan-id</i> : Specifies a VLAN where the MAC address resides.
Command Mode	Privileged EXEC mode/Global configuration mode /Interface configuration mode
Usage Guide	N/A
	<pre> FS# show mac-address-table filtering Vlan MAC Address Type Interface ----- 1 0000.2222.2222 FILTER </pre>

Configuration Example

▾ Configuring a MAC Address for Packet Filtering

Configuration Steps	<ul style="list-style-type: none"> ● Specify a destination MAC address (<i>mac-address</i>) for filtering. ● Specify a VLAN where the MAC addresses resides.
	<pre> FS# configure terminal FS(config)# mac-address-table static 00d0.f800.3232.0001 vlan 1 </pre>

Verification	Display the filtered MAC address configuration.												
	<pre>FS# show mac-address-table filter</pre> <table border="1" style="width: 100%; border-collapse: collapse;"> <thead> <tr> <th style="text-align: left;">Vlan</th> <th style="text-align: left;">MAC Address</th> <th style="text-align: left;">Type</th> <th style="text-align: left;">Interface</th> </tr> </thead> <tbody> <tr> <td colspan="4" style="border-top: 1px dashed black;">-----</td> </tr> <tr> <td style="text-align: center;">1</td> <td style="text-align: left;">00d0.f800.3232.0001</td> <td style="text-align: left;">FILTER</td> <td></td> </tr> </tbody> </table>	Vlan	MAC Address	Type	Interface	-----				1	00d0.f800.3232.0001	FILTER	
Vlan	MAC Address	Type	Interface										

1	00d0.f800.3232.0001	FILTER											

24.5.4 Configuring MAC Address Change Notification

Configuration Effect

- Monitor change of devices connected to a network device.

Configuration Steps

▾ Configuring NMS

- Optional.
- Perform this configuration to enable an NMS to receive MAC address change notifications.
- Configuration:

Command	snmp-server host <i>host-addr</i> traps [version { 1 2c 3 [auth noauth priv] }] <i>community-string</i>
Parameter	host <i>host-addr</i> : Specifies the IP address of a receiver.
Description	<ul style="list-style-type: none"> ● version { 1 2c 3 [auth noauth priv] }: Specifies the version of SNMP TRAP messages. You can also specify authentication and a security level for packets of Version 3. <i>community-string</i> : Indicates an authentication name.
Defaults	By default, the function is disabled.
Command Mode	Global configuration mode
Usage Guide	N/A

▾ Enabling SNMP Trap

- Optional.
- Perform this configuration to send SNMP Trap messages.
- Configuration:

Command	snmp-server enable traps
Parameter	N/A
Description	
Defaults	By default, the function is disabled.
Command Mode	Global configuration mode
Usage Guide	N/A

▾ Configuring Global MAC Address Change Notification

- Optional.
- If MAC address change notification is disabled globally, it is disabled on all interfaces.
- Configuration:

Command	mac-address-table notification
Parameter	N/A
Description	
Defaults	By default, MAC address change notification is disabled globally.
Command	Global configuration mode
Mode	
Usage Guide	N/A

📌 **Configuring MAC Address Change Notification On Interface**

- Optional.
- Perform this configuration to enable MAC address change notification on an interface.
- Configuration:

Command	snmp trap mac-notification { added removed }
Parameter	added: Generates a notification when an MAC address is added.
Description	removed: Generates a notification when an MAC address is deleted.
Defaults	By default, MAC address change notification is disabled on an interface.
Command	Interface configuration mode
Mode	
Usage Guide	N/A

📌 **Configuring Interval for Generating MAC Address Change Notifications and Volume of Notification History**

- Optional.
- Perform this configuration to modify the interval for generating MAC address change notifications and the volume of notification history.
- Configuration:

Command	mac-address-table notification { interval value history-size value }
Parameter	interval value: (Optional) Indicates the interval for generating MAC address change notifications. The value ranges from 1 to 3600 seconds,.
Description	history-size value: Indicates the maximum number of entries in the table of notification history. The value ranges from 1 to 200.
Defaults	The default interval is 1 second. The default maximum amount of notifications is 50.
Command	Global configuration mode
Mode	
Usage Guide	N/A

Verification

- Run the **show mac-address-table notification** command to check whether the NMS receives MAC address change notifications.

Command	show mac-address-table notification [interface [interface-id] history]								
Parameter	Interface: Displays the configuration of MAC address change notification on all interfaces.								
Description	interface-id: Displays the configuration of MAC address change notification on a specified interface. history: Displays the history of MAC address change notifications.								
Command Mode	Privileged EXEC mode/Global configuration mode /Interface configuration mode								
Usage Guide	N/A								
Usage Guide	<p>Display the configuration of global MAC address change notification.</p> <pre>FS#show mac-address-table notification</pre> <p>MAC Notification Feature : Enabled</p> <p>Interval(Sec): 300</p> <p>Maximum History Size : 50</p> <p>Current History Size : 0</p> <table border="1"> <thead> <tr> <th>Field</th> <th>Description</th> </tr> </thead> <tbody> <tr> <td>Interval(Sec)</td> <td>Indicates the interval for generating MAC address change notifications.</td> </tr> <tr> <td>Maximum History Size</td> <td>Indicates the maximum number of entries in the table of notification history.</td> </tr> <tr> <td>Current History Size</td> <td>Indicates the current notification entry number.</td> </tr> </tbody> </table>	Field	Description	Interval(Sec)	Indicates the interval for generating MAC address change notifications.	Maximum History Size	Indicates the maximum number of entries in the table of notification history.	Current History Size	Indicates the current notification entry number.
Field	Description								
Interval(Sec)	Indicates the interval for generating MAC address change notifications.								
Maximum History Size	Indicates the maximum number of entries in the table of notification history.								
Current History Size	Indicates the current notification entry number.								

Configuration Example

Scenario
Figure 3-8

The figure shows an intranet of an enterprise. Users are connected to A via port Gi0/2.

The Perform the configuration to achieve the following effects:

- When port Gi0/2 learns a new MAC address or finishes aging a learned MAC address, a MAC address change notification is generated.
- Meanwhile, A sends the MAC address change notification in an SNMP Trap message to a specified NMS.
- In a scenario where A is connected to a number of Users, the configuration can prevent MAC address change notification burst in a short time so as to reduce the network flow.

<p>Configuration Steps</p>	<ul style="list-style-type: none"> ● Enable global MAC address change notification on A, and configure MAC address change notification on port Gi0/2. ● Configure the IP address of the NMS host, and enable A with SNMP Trap. A communicates with the NMS via routing. ● Configure the interval for sending MAC address change notifications to 300 seconds (1 second by default).
<p>A</p>	<pre> FS# configure terminal FS(config)# mac-address-table notification FS(config)# interface gigabitEthernet 0/2 FS(config-if-GigabitEthernet 0/2)# snmp trap mac-notification added FS(config-if-GigabitEthernet 0/2)# snmp trap mac-notification removed FS(config-if-GigabitEthernet 0/2)# exit FS(config)# snmp-server host 192.168.1.10 traps version 2c comefrom2 FS(config)# snmp-server enable traps FS(config)# mac-address-table notification interval 300 </pre>
<p>Verification</p>	<ul style="list-style-type: none"> ● Check t whether MAC address change notification is enabled globally . ● Check whether MAC address change notification is enabled on the interface. ● Display the MAC addresses of interfaces, and run the clear mac-address-table dynamic command to simulate aging dynamic MAC addresses. ● Check whether global MAC address change notification is enabled globally. ● Display the history of MAC address change notifications.
<p>A</p>	<pre> FS# show mac-address-table notification MAC Notification Feature : Enabled Interval(Sec): 300 Maximum History Size : 50 Current History Size : 0 FS# show mac-address-table notification interface GigabitEthernet 0/2 Interface MAC Added Trap MAC Removed Trap ----- GigabitEthernet 0/2 Enabled Enabled FS# show mac-address-table interface GigabitEthernet 0/2 Vlan MAC Address Type Interface ----- 1 00d0.3232.0001 DYNAMIC GigabitEthernet 0/2 FS# show mac-address-table notification MAC Notification Feature : Enabled </pre>

	Interval(Sec): 300 Maximum History Size : 50 Current History Size : 1 FS# show mac-address-table notification history History Index : 0 Entry Timestamp: 221683 MAC Changed Message : Operation:DEL Vlan:1 MAC Addr: 00d0.3232.0003 GigabitEthernet 0/2
--	--

24.5.5 Configuring a Management VLAN for an AP Port

Configuration Effect

- Enable an AP port to process the packets from a management VLAN as management packets, and those from a non-management VLAN as data packets.

Configuration Steps

⤵ Configuring a Management VLAN for an AP Port

- Optional.
- Perform this configuration to enable an AP port to distinguish management packets from data packets.
- Configuration:

Command	<code>aggregateport-admin vlan vlan-list</code>
Parameter	<i>vlan-list</i> : Indicates a VLAN or a range of VLANs separated by "-".
Description	
Defaults	By default, no management VLAN is configured for an AP port.
Command Mode	Global configuration mode
Usage Guide	An AP port processes the packets received on the management VLAN as management packets.

Verification

- An AP port processes the packets from a management VLAN as management packets, and those from a non-management VLAN as data packets.

Configuration Example

⤵ Configuring a Management VLAN for an AP Port

Configuration Steps	<ul style="list-style-type: none"> ● Specify management VLANs for an AP port.
	FS# configure terminal FS(config)# aggregateport-admin vlan 1-20

Verification	Run the show running command to display the configuration.
---------------------	---

24.5.6 Configuring MAC Address Flapping Check

Configuration Effect

- Print a syslog alarm when MAC address flapping occurs, that is, a MAC address is learned by more than one port in a short time in a VLAN.

Configuration Steps

▾ Configuring MAC Address Flapping Check

- Optional.
- Configure this configuration to print a syslog alarm upon MAC address flapping.
- Configuration:

Command	mac-address-table flapping-logging
Parameter Description	N/A
Defaults	By default, the function is disabled.
Command Mode	Global configuration mode
Usage Guide	N/A

Verification

- Run the **show run** command to display the configuration.
- Print syslog to check the MAC address flapping.
- Run the **show mac-address-table flapping record** to display the dynamic MAC address flapping record. The first part shows information of the port where flapping occurs, and the second shows the current port policy.

Command	show mac-address-table flapping record
Parameter Description	
Command Mode	Privileged EXEC mode, global configuration mode, interface mode
Usage Guide	-
Command Display	<pre> FS# show mac-address-table flapping record Mac address flapping detect status : on Mac address flapping detect interval : 1s Mac address flapping syslog suppress time : 1800s Mac address flapping record max count : 300 Mac address flapping record total count : 2 </pre>

(D):error down					
Move-Time	VLAN	MAC-Address	Original-Port	Move-Ports	

2019.7.15 8:53:46	1	0026.8b06.6241	Te0/2	Te0/1	
2019.7.15 8:53:46	1	0026.8b06.6241	Te0/2(D)	Te0/1	

Field	Description
Move-Time	Flapping time
VLAN	VLAN of the MAC address
MAC-Address	MAC address
Original-Port	Interfaces that learn the MAC address before address flapping (D) followed by the current port policy
Move-Ports	Interfaces that learn the MAC address after address flapping (D) followed by the current port policy

Configuration Example

▾ **Configuring Syslog Printing upon MAC Address Flapping**

Configuration Steps	<ul style="list-style-type: none"> ● Enable syslog printing upon MAC address flapping.
	<pre>FS# configure terminal FS(config)# mac-address-table flapping-logging</pre>
Verification	Run the show running command to display the configuration.

24.5.7Configuring the MAC Address Flapping Protection Policy

Configuration Effect

- When MAC address flapping is detected on a port with the MAC address flapping protection policy configured, the port will be shut down.

Notes

- The MAC address flapping detection function must be enabled.

Configuration Steps

▾ **Configuring the MAC Address Flapping Protection Policy**

- Optional
- Perform this operation to prevent MAC address flapping between different ports.

- Perform this operation on the switch.

Command	mac-address-table flapping action [error-down priority <i>priority-num</i>]
Parameter Description	error-down: Specifies the policy that a port is shut down if MAC address flapping is detected on the port. priority <i>priority-num</i>: Indicates the priority of the port shutdown policy. The default value is 0 (the lowest priority). The value ranges from 0 to 5. A larger value indicates a higher priority.
Defaults	By default, the MAC address flapping protection function is disabled.
Command Mode	Interface configuration mode
Usage Guide	The MAC address flapping check function must be enabled first. Otherwise, the configuration does not take effect. When the command default interface is run in global configuration mode, if there is any Layer-2 sub-interface, the MAC-flapping protection cannot restore the default settings.

Verification

- Run **show run** to query the configuration result.
- Run **show mac-address-table flapping record** to display the dynamic MAC address flapping record. The first part shows information of the port where flapping occurs, and the second shows the current port policy.

Command	show mac-address-table flapping record										
Parameter Description											
Command Mode	Privileged EXEC mode, global configuration mode, interface mode										
Usage Guide	-										
Command Display	<pre> FS# show mac-address-table flapping record Mac address flapping detect status : on Mac address flapping detect interval : 1s Mac address flapping syslog supress time : 1800s Mac address flapping record max count : 300 Mac address flapping record total count : 2 (D):error down Move-Time VLAN MAC-Address Original-Port Move-Ports ----- 2019.7.15 8:53:46 1 0026.8b06.6241 Te0/2 Te0/1 2019.7.15 8:53:46 1 0026.8b06.6241 Te0/2(D) Te0/1 </pre> <table border="1"> <thead> <tr> <th>Field</th> <th>Description</th> </tr> </thead> <tbody> <tr> <td>Move-Time</td> <td>Flapping time</td> </tr> <tr> <td>VLAN</td> <td>VLAN of the MAC address</td> </tr> <tr> <td>MAC-Address</td> <td>MAC address</td> </tr> <tr> <td>Original-Port</td> <td>Interfaces that learn the MAC address before address flapping (D) followed by the current port policy</td> </tr> </tbody> </table>	Field	Description	Move-Time	Flapping time	VLAN	VLAN of the MAC address	MAC-Address	MAC address	Original-Port	Interfaces that learn the MAC address before address flapping (D) followed by the current port policy
Field	Description										
Move-Time	Flapping time										
VLAN	VLAN of the MAC address										
MAC-Address	MAC address										
Original-Port	Interfaces that learn the MAC address before address flapping (D) followed by the current port policy										

	Move-Ports	Interfaces that learn the MAC address after address flapping (D) followed by the current port policy
--	------------	--

-

Configuration Example

▾ **Configuring the MAC Address Flapping Protection Policy**

Configuration Steps	<ul style="list-style-type: none"> ● Enable the MAC address flapping detection function.
	<pre>FS# configure terminal FS(config)# mac-address-table flapping-logging</pre>
	<ul style="list-style-type: none"> ● Configure the MAC address flapping protection policy. <pre>FS(config)# interface GigabitEthernet 1/1 FS(config-if-GigabitEthernet 1/1)# mac-address-table flapping action error-down FS(config-if-GigabitEthernet 1/1)# mac-address-table flapping action priority 2</pre>
Verification	Run show running on the switch to query the configuration.

Common Errors

None

24.5.8Configuring the Maximum Number of MAC Addresses Learned by a Port

Configuration Effect

- Only a limited number of dynamic MAC addresses can be learned by a port.

Notes

None

Configuration Steps

▾ **Configuring the Maximum Number of MAC Addresses Learned by a Port**

- Optional
- Perform this operation on the switch.

Command	max-dynamic-mac-count <i>count</i>
Parameter Description	<i>count</i> : Indicates the maximum number of MAC addresses learned by a port.
Defaults	By default, the number of MAC addresses learned by a port is not limited. After the number of MAC addresses learned by a port is limited and after the maximum number of MAC addresses exceeds the limit, packets from source MAC addresses are forwarded by default.
Command	Interface configuration mode

Mode	
Usage Guide	N/A

Verification

- Run **show run** to query the configuration result.

Configuration Example

▾ **Configuring the Maximum Number of MAC Addresses Learned by a Port**

Configuration Steps	<ul style="list-style-type: none"> ● Configure the maximum number of MAC addresses learned by a port.
	<ul style="list-style-type: none"> ● Configure the maximum number of MAC addresses learned by a port and the countermeasure for the case that the number of MAC addresses exceeds the limit. <pre>FS(config)# interface GigabitEthernet 1/1 FS(config-if-GigabitEthernet 1/1)# max-dynamic-mac-count 100 FS(config-if-GigabitEthernet 1/1)# max-dynamic-mac-count exceed-action discard</pre>
Verification	Run show running on the switch to query the configuration.

Common Errors

None

24.5.9 Configuring the Maximum Number of MAC Addresses Learned by a VLAN

Configuration Effect

- Only a limited number of dynamic MAC addresses can be learned by a VLAN.

Notes

None

Configuration Steps

▾ **Configuring the Maximum Number of MAC Addresses Learned by a VLAN**

- Optional
- Perform this operation on the switch.

Command	max-dynamic-mac-count exceed-action forward discard
Parameter Description	forward/discard: Indicates that packets are forwarded or discarded when the number of MAC addresses learned by a VLAN exceeds the limit.
Defaults	By default, the number of MAC addresses learned by a VLAN is not limited. After the number of MAC addresses learned by a VLAN is limited and after the maximum number of MAC addresses exceeds the limit, packets from source MAC addresses are forwarded by default.
Command Mode	VLAN configuration mode
Usage Guide	N/A

Verification

- Run **show run** to query the configuration result.

Configuration Example

🔽 **Configuring the Maximum Number of MAC Addresses Learned by a VLAN**

Configuration Steps	<ul style="list-style-type: none"> ● Configure the maximum number of MAC addresses learned by a VLAN.
	<ul style="list-style-type: none"> ● Configure the maximum number of MAC addresses learned by a VLAN and the countermeasure for the case that the number of MAC addresses exceeds the limit. <pre style="background-color: #f2f2f2; padding: 10px;"> FS(config)#interface GigabitEthernet 0/1 FS(config-if-GigabitEthernet 0/1)#max-dynamic-mac-count 100 FS(config-if-GigabitEthernet 0/1)#max-dynamic-mac-count exceed-action discard FS(config)# vlan 2 FS(config-vlan)#max-dynamic-mac-count 100 FS(config-vlan)# max-dynamic-mac-count exceed-action discard </pre>
Verification	Run show running on the switch to query the configuration.

Common Errors

None

24.6 Monitoring

Clearing

Running the clear commands may lose vital information and interrupt services.

Description	Command
Clears dynamic MAC addresses.	clear mac-address-table dynamic [address <i>mac-address</i>] [interface <i>interface-id</i>] [vlan <i>vlan-id</i>]

Displaying

Description	Command
Displays the MAC address table.	show mac-address-table { dynamic static filter } [address <i>mac-address</i>] [interface <i>interface-id</i>] [vlan <i>vlan-id</i>]
Displays the aging time for dynamic MAC addresses.	show mac-address-table aging-time
Displays the maximum number of dynamic MAC addresses.	show mac-address-table max-dynamic-mac-count
Displays the configuration and history of MAC address change notifications.	show mac-address-table notification [interface [<i>interface-id</i>]] [history]
Displays the MAC address flapping	show mac-address-table flapping record

record.	
---------	--

Debugging

System resources are occupied when debugging information is output. Therefore, disable debugging immediately after use.

Description	Command
Debugs MAC address operation.	<code>debug bridge mac</code>

25 Configuring Aggregate Port

25.1 Overview

An aggregate port (AP) is used to bundle multiple physical links into one logical link to increase the link bandwidth and improve connection reliability.

An AP port supports load balancing, namely, distributes load evenly among member links. Besides, an AP port realizes link backup. When a member link of the AP port is disconnected, the load carried by the link is automatically allocated to other functional member links. A member link does not forward broadcast or multicast packets to other member links.

For example, the link between two devices supports a maximum bandwidth of 1,000 Mbps. When the service traffic carried by the link exceeds 1,000 Mbps, the traffic in excess will be discarded. Port aggregation can be used to solve the problem. For example, you can connect the two devices with network cables and combine multiple links to form a logical link capable of multiples of 1,000 Mbps.

For example, there are two devices connected by a network cable. When the link between the two ports of the devices is disconnected, the services carried by the link will be interrupted. After the connected ports are aggregated, the services will not be affected as long as one link remains connected.

Protocols and Standards

- IEEE 802.3ad

25.2 Applications

Applications	Description
AP Link Aggregation and Load Balancing	A large number of packets are transmitted between an aggregation device and a core device, which requires a greater bandwidth. To meet this requirement, you can bundle the physical links between the devices into one logical link to increase the link bandwidth, and configure a proper load balancing algorithm to distribute the work load evenly to each physical link, thus improving bandwidth utilization.

25.2.1 AP Link Aggregation and Load Balancing

Scenario

In Figure 4-1, the switch communicates with the router through an AP port. All the devices on the intranet (such as the two PCs on the left) use the router as a gateway. All the devices on the extranet (such as the two PCs on the right) send packets to the internet devices through the router, with the gateway’s MAC address as its source MAC address. To distribute the load between the router and other hosts to other links, configure destination MAC address-based load balancing. On the switch, configure source MAC address-based load balancing.

Figure 4-1 AP Link Aggregation and Load Balancing

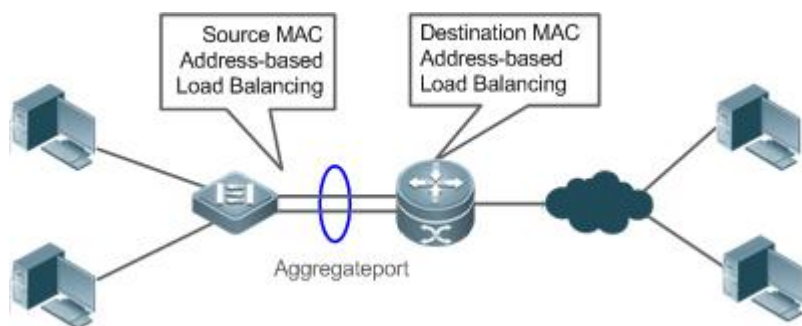

Deployment

- Configure the directly connected ports between the switch and router as a static AP port or a Link Aggregation Control Protocol (LACP) AP port.
- On the switch, configure a source MAC address-based load balancing algorithm.
- On the router, configure a destination MAC address-based load balancing algorithm.
- Features

25.3 Features

Basic Concepts

➤ **Static AP**

The static AP mode is an aggregation mode in which physical ports are directly added to an AP aggregation group through manual configuration to allow the physical ports to forward packets when the ports are proper in link state and protocol state.

An AP port in static AP mode is called a static AP, and its member ports are called static AP member ports.

➤ **LACP**

LACP is a protocol about dynamic link aggregation. It exchanges information with the connected device through LACP data units (LACPDU)s.

An AP port in LACP mode is called an LACP AP port, and its member ports are called LACP AP member ports.

➤ **AP Member Port Mode**

There are three aggregation modes available, namely, active, passive, and static.

AP member ports in active mode initiate LACP negotiation. AP member ports in passive mode only respond to received LACPDU)s. AP member ports in static mode do not send LACPDU)s for negotiation. The following table lists the requirements for peer port mode.

Port Mode	Peer Port Mode
Active mode	Active or passive mode
Passive mode	Active mode
Static Mode	Static Mode

➤ **AP Member Port State**

There are two kinds of AP member port state available:

- When a member port is Down, the port cannot forward packets. The Down state is displayed.
- When a member port is Up and the link protocol is ready, the port can forward packets. The Up state is displayed.

There are three kinds of LACP member port state:

- When the link of a port is Down, the port cannot forward packets. The Down state is displayed.
- When the link of a port is Up and the port is added to an aggregation group, the bndl state is displayed.
- When the link of a port is Up but the port is suspended because the peer end is not enabled with LACP or the attributes of the ports are inconsistent with those of the master port, the susp state is displayed. (The port in susp state does not forward packets.)

 Only full-duplex ports are capable of LACP aggregation.

 LACP aggregation can be implemented only when the rates, flow control approaches, medium types, and Layer-2/3 attributes of member ports are consistent.

 If you modify the preceding attributes of a member port in the aggregation group, LACP aggregation will fail.

 The ports which are prohibited from joining or exiting an AP port cannot be added to or removed from a static AP port or an LACP AP port.

AP Capacity Mode

The maximum number of member ports is fixed, which is equal to the maximum number of AP ports multiplied by the maximum number of member ports supported by a single AP port. If you want to increase the maximum number of AP ports, the maximum number of member ports supported by a single AP port must be reduced, and vice versa. This concerns the AP capacity mode concept. Some devices support the configuration of the AP capacity mode. For example, if the system supports 16,384 member ports, you can select the 1024 x 16, 512 x 32, and other AP capacity modes (Maximum number of AP ports multiplied by the maximum number of member ports supported by a single AP port).

LACP System ID

By default, all the LACP ports on a device belong to the same LACP aggregation system.

One device can be configured with only one LACP aggregation system. The system is identified by a system ID and each system has a priority, which is a configurable value. The system ID consists of the LACP system priority and MAC address of the device. A lower system priority indicates a higher priority of the system ID. If the system priorities are the same, a smaller MAC address of the device indicates a higher priority of the system ID. The system with an ID of a higher priority determines the port state. The port state of a system with an ID of a lower priority keeps consistent with that of a higher priority.

The LACP system ID can be configured when LACP ports of multiple (a maximum of four) independent devices need to negotiate with the LACP port of a specific device (for example, LACP ports of two independent ASWs need to negotiate with the LACP port of the NC). You can set the system IDs of the LACP ports of independent devices to the same MAC address and configure different device IDs to implement normal negotiation.

LACP Device ID

The LACP device ID can be configured when LACP ports of multiple independent devices need to negotiate with the LACP port of a specific device. It must be configured together with the system ID.

LACP Port ID

Each port has an independent LACP port priority, which is a configurable value. The port ID consists of the LACP port priority and port number. A smaller port priority indicates a higher priority of the port ID. If the port priorities are the same, a smaller port number indicates a higher priority of the port ID.

↘ LACP Master Port

When dynamic member ports are Up, LACP selects one of those ports to be the master port based on the rates and duplex modes, ID priorities of the ports in the aggregation group, and the bundling state of the member ports in the Up state. Only the ports that have the same attributes as the master port are in Bundle state and participate in data forwarding. When the attributes of ports are changed, LACP reselects a master port. When the new master port is not in Bundle state, LACP disaggregates the member ports and performs aggregation again.

↘ Minimum Number of AP Member Ports

An AP can be configured with a minimum number of AP member ports. When a member port exits the AP aggregation group, causing the number of member ports to be smaller than the minimum number, the other member ports in the group are unbundled (Down Status). When the member port rejoins the group, causing the number of member ports to be greater than the minimum number, the member ports in the group are automatically bundled (Up Status).

↘ LACP Independent Ports

In normal cases, LACP independent ports are used for interworking between access switches and servers with two NICs. If the OS is not pre-installed when a server with two NICs starts, the OS needs to be installed via the remote PXE OS installation device. Before the OS is installed, the server with two NICs cannot perform LACP negotiation with the access device, and only one NIC can work. In this case, the port on the access device must be able to change to a common Ethernet physical port automatically to ensure normal communication between the server and the remote PXE OS installation device. After the OS is installed and both NICs can run the LACP, the port on the access device must be able to enable the LACP again for negotiation.

 LACP independent ports can work only at layer 2. After an LACP independent port is enabled, if the LACP independent port does not receive LACP packets, it automatically changes to a common Ethernet port, which automatically copies the rate, duplex mode, flow control, and VLAN configuration from the AP port to ensure port forwarding capabilities.

 An LACP independent port automatically changes to a common Ethernet port only if it does not receive LACP packets within the set time-out period. After the port receives LACP packets, it changes to an LACP member port again.

Overview

Overview	Description
Link Aggregation	Aggregates physical links statically or dynamically to realize bandwidth extension and link backup.
Load Balancing	Balances the load within an aggregation group flexibly by using different load balancing methods.

25.3.1 Link Aggregation

Working Principle

There are two kinds of AP link aggregation. One is static AP, and the other is dynamic aggregation through LACP.

- Static AP

The static AP configuration is simple. Run a command to add the specified physical port to the AP port. After joining the aggregation group, a member port can receive and transmit data and participate in load balancing within the group.

- Dynamic AP (LACP)

An LACP-enabled port sends LACPDU to advertise its system priority, system MAC address, port priority, port number, and operation key. When receiving the LACPDU from the peer end, the device compares the system priorities of both ends based on the system ID in the packet. The end with a higher system ID priority sets the ports in the aggregation group to Bundle state based on the port ID priorities in a descending order, and sends an updated LACPDU. When receiving the LACPDU, the peer end sets corresponding ports to Bundle state so that both ends maintain consistency when a port exits or joins the aggregation group. The physical link can forward packets only after the ports at both ends are bundled dynamically.

After link aggregation, the LACP member ports periodically exchange LACPDUs. When a port does not receive an LACPDU in the specified time, a timeout occurs and the links are unbundled. In this case, the member ports cannot forward packets. There are two timeout modes: long timeout and short timeout. In long timeout mode, a port sends a packet every 30s. If it does not receive a packet from the peer end in 90s, a timeout occurs. In short timeout mode, a port sends a packet every 1s. If it does not receive a packet from the peer end in 3s, a timeout occurs. (The default timeout time in LACP short timeout mode is 3 seconds. The value is changeable.)

Figure 4-2 LACP Negotiation

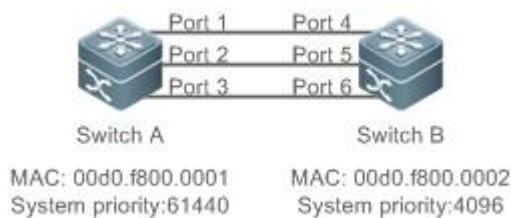

In Figure 4-2, Switch A is connected to Switch B through three ports. Set the system priorities of Switch A and Switch B to 61440 and 4096 respectively. Enable LACP on the Ports 1–6, set the aggregation mode to the active mode, and set the port priority to the default value 32768.

When receiving an LACPDU from Switch A, Switch B finds that it has a higher system ID priority than Switch A (the system priority of Switch B is higher than that of Switch A). Switch B sets Port 4, Port 5, and Port 6 to Bundle state based on the order of port ID priorities (or in an ascending order of port numbers if the port priorities are the same). When receiving an updated LACPDU from Switch B, Switch A finds that Switch B has a higher system ID priority and has set Port 4, Port 5, and Port 6 to Bundle state. Then Switch A also sets Port 1, Port 2, and Port 3 to Bundle state.

25.3.2 Load Balancing

Working Principle

AP ports segregate packet flows by using load balancing algorithms based on packet features, such as the source and destination MAC addresses, source and destination IP addresses, and Layer-4 source and destination port numbers. The packet flow with the consistent feature is transmitted by one member link, and different packet flows are evenly distributed to member links. For example, in source MAC address-based load balancing, packets are distributed to the member links based on the source MAC addresses of the packets. Packets with different source MAC addresses are evenly distributed to member links. Packets with the identical source MAC address are forwarded by one member link.

Currently, there are several AP load balancing modes as follows:

- Source MAC address or destination MAC address
- Source MAC address + destination MAC address
- Source IP address or destination IP address

- Source IP address + destination IP address
- Layer-4 source port number or Layer-4 destination port number
- Layer-4 source port number + Layer-4 destination port number
- Source IP address + Layer-4 source port number
- Source IP address + Layer-4 destination port number
- Destination IP address + Layer-4 source port number
- Destination IP address + Layer-4 destination port number
- Source IP address + Layer-4 source port number + Layer-4 destination port number
- Destination IP address + Layer-4 source port number + Layer-4 destination port number
- Source IP address + destination IP address + Layer-4 source port number
- Source IP address + destination IP address + Layer-4 destination port number
- Source IP address + destination IP address + Layer-4 source port number + Layer-4 destination port number
- Panel port for incoming packets
- Labels of Multiprotocol Label Switching (MPLS) packets
- Aggregation member port polling
- Enhanced mode
- i** Load balancing based on IP addresses or port numbers is applicable only to Layer-3 packets. When a device enabled with this load balancing method receives Layer-2 packets, it automatically switches to the default load balancing method.
- i** All the load balancing methods use a load algorithm (hash algorithm) to calculate the member links based on the input parameters of the methods. The input parameters include the source MAC address, destination MAC address, source MAC address + destination MAC address, source IP address, destination IP address, source IP address + destination IP addresses+ Layer-4 port number and so on. The algorithm ensures that packets with different input parameters are evenly distributed to member links. It does not indicate that these packets are always distributed to different member links. For example, in IP address-based load balancing, two packets with different source and destination IP addresses may be distributed to the same member link through calculation.
- i** Different products may support different load balancing algorithms.

📌 Enhanced Load Balancing

Enhanced load balancing allows the combination of multiple fields in different types of packets. These fields include **src-mac**, **dst-mac**, **I2-protocol**, and **src-port** in Layer-2 packets, **src-ip**, **dst-ip**, **protocol**, **I4-src-port**, **I4-dst-port**, and **src-port**, in IPv4 packets, **src-ip**, **dst-ip**, **protocol**, **I4-src-port**, **I4-dst-port**, and **src-port** in IPv6 packets; **top-label**, **2nd-label**, **3rd-label**, **src-ip**, **dst-ip**, **vlan**, **src-port**, **src-mac**, **dst-mac**, **protocol**, **I4-src-port**, **I4-dst-port**, and **I2-etype** in MPLS packets; and **vlan**, **src-port**, **src-id**, **rx-id**, **ox-id**, **fabric-id**, and **dst-id** in FCoE packets.

A device enabled with enhanced load balancing first determines the type of packets to be transmitted and performs load balancing based on the specified fields in the packets. For example, the AP port performs source IP-based load balancing on the packets containing an ever-changing source IPv4 address.

- i** All the load balancing methods are applicable to Layer-2 and Layer-3 AP ports. You need to configure proper load distribution methods based on different network environments to fully utilize network bandwidth.

- i** Perform enhanced load balancing based on the src-mac, dst-mac, and vlan fields in Layer-2 packets, and the src-ip field in IPv4 packets. If the incoming packet is an IPv4 packet with an ever-changing source MAC address, the enhanced balancing algorithm does not take effect, because the device will perform load balancing only based on the src-ip field in the IPv4 packet after finding that it is an IPv4 packet.
- i** In enhanced load balancing, the MPLS balancing algorithm takes effect only for MPLS Layer-3 VPN packets, but does not take effect for MPLS Layer-2 VPN packets.

📌 Hash Load Balancing Control

Hash load balancing enables users to control load balancing flexibly in different scenarios. Currently, FS adopts the following hash load balancing control functions:

- Hash disturbance factor: Traffic over AP ports is hashed for balancing. For two devices of the same type, the same path will be calculated for load balancing for the same stream. When the ECMP is deployed, the same stream of the two devices may be balanced to the same destination device, resulting in hash polarization. The hash disturbance factor is used to affect the load balancing algorithm. Different disturbance factors are configured for different devices to ensure that different paths are provided for the same stream.
- Hash synchronization: To ensure network security, a firewall cluster is deployed between the internal and external networks for traffic cleaning. This requires that both the uplink and downlink traffic of a session is transmitted to the same device in the firewall cluster for processing. The source and destination IP addresses contained in the uplink and downlink streams of a session are reversed. The uplink and downlink streams will be directed to different firewalls in the firewall cluster based on the traditional hash algorithm. The hash synchronization function ensures that uplink and downlink streams of a session be transmitted over the same path.
- Hash algorithm mode: Apply the most appropriate hash algorithm mode to different traffic, so that when traffic changes, balance can still be kept. For example, if the source and destination MAC addresses of a stream increase 1 at the same time, configure the algorithm based on the source and destination MAC addresses cannot keep stream balance. At the moment, a suitable hash algorithm mode needs to be applied.
- Hash factor acquisition mode: There are an inner layer and an outer layer in the header in each of VXLAN packets, GRE packets, and other tunnel packets. It can be specified to obtain the hash factor from the inner layer or outer layer, to achieve a better balancing effect. For example, in some scenarios, tunnel packets share the same outer IP address but have different inner IP addresses. In this case, the inner IP address can be specified as the hash factor to optimize traffic balancing.

25.3.3 Member Port BFD Detection

Working Principle

Bidirectional Forwarding Detection (BFD) is a protocol that delivers fast detection of path failures. According to RFC7130, LACP takes 3s to detect link failures even in short timeout mode. The packets distributed to the faulty link during the 3-second period will be lost. BFD delivers faster failure detection. You can configure BFD on member ports to detect link failure and switch load to other member links in case of a link failure.

Because BFD is a Layer-3 protocol, you need to configure BFD on Layer-3 AP ports. BFD is classified into IPv4 detection and IPv6 detection, which detect IPv4 and IPv6 paths respectively. When BFD detects that the path on a member port fails, the packets will not be distributed to the member port.

After BFD is enabled on an AP port, BFD sessions are set up on its member ports in forwarding state independently.

25.4 Limitations



- Each AP of the product contains up to eight member ports, and each device supports up to 256 APs by default.
- The capacity mode of APs can be set to any one of the following: 255*16, 127*32, 63*64, and 31*128. In these modes, the maximum number of member ports supported by each AP is 16, 32, 64, and 128 respectively, and the maximum number of supported APs is 255, 127, 63, and 31 respectively. The default configuration is 255*16.



- When the products adopt load balancing that is based on the source MAC address, destination MAC address, or source MAC address + destination MAC address, the devices also use the Ethernet type field and VLAN field of unicast packets as balancing factors by default.
- The products adopt the non-enhanced load balancing mode. With the Internet Group Management Protocol snooping (IGMP snooping) or multicast routing enabled, the keywords for load balancing of multicast packets are src-ip, dst-ip, or src-ip+dst-ip. The keywords for load balancing of other multicast packets, unknown unicast packets, and broadcast packets are src-mac, dst-mac, or src-mac+dst-mac. For example, when layer-3 packets (unknown unicast, multicast, and broadcast packets) are forwarded at layer 2, load balancing cannot be performed based on src-ip or dst-ip. In this case, the enhanced mode can be adopted because load balancing is performed based on the packet type in this mode.
- In load balancing mode based on src-dst-ip-l4port, L4port changes on the products are valid only to unicast packets.
- The products support AP-based load balancing algorithms. AP-based load balancing algorithms support load balancing based only on SMAC, DMAC, SMAC+DMAC, SIP, DIP, and SIP+DIP.
- The products do not support the Round Robin (RR) load balancing algorithm.
- Enhanced load balancing templates of the products support the following fields:
 L2 template: src-mac dst-mac vlan l2-protocol src-port
 IPv4 template: src-ip dst-ip protocol vlan l4-src-port l4-dst-port src-port
 IPv6 template: src-ip dst-ip protocol vlan l4-src-port l4-dst-port src-port

25.5 Configuration

Configuration	Description and Command	
<u>Configuring Static AP Ports</u>	(Mandatory) It is used to configure link aggregation manually.	
	interface aggregateport	Creates an Ethernet AP port.
	interface san-port-channel	Creates an FC AP port.
	port-group	Configures static AP member ports.
<u>Configuring LACP AP Ports</u>	(Mandatory) It is used to configure link aggregation dynamically.	
	port-group mode	Configures LACP member ports.
	lACP system-priority	Configures the LACP system priority.
	lACP short-timeout period	Configures the timeout time of the LACP system in short timeout mode.
	lACP port-priority	Configures the port priority.
lACP short-timeout	Configures the short timeout mode on a port.	

Configuration	Description and Command	
Enabling LinkTrap	(Optional) It is used to enable LinkTrap.	
	snmp trap link-status	Enables LinkTrap advertisement for an AP port.
	aggregateport member linktrap	Enables LinkTrap t for AP member ports.
Configuring a Load Balancing Mode	(Optional) It is used to configure a load balancing mode for an aggregated link.	
	aggregateport load-balance	Configures a load balancing algorithm for an AP port or AP member ports.
	(Optional) It is used to configure the profile of enhanced load balancing.	
	load-balance-profile	Renames the profile of enhanced load balancing.
	l2 field	Configures a load balancing mode for Layer-2 packets.
	ipv4 field	Configures a load balancing mode for IPv4 packets.
	ipv6 field	Configures a load balancing mode for IPv6 packets.
	mpls field	Configures a load balancing mode for MPLS packets.
	trill field	Configures a load balancing mode for TRILL packets.
	fcoe field	Configures a load balancing mode for FCoE packets.
	(Optional) It is used to control load balancing policy.	
	hash-disturb {string seed seed-value offset offset-value}	Configures hash disturbance factor.
	hash-symmetrical [ipv4 ipv6 fcoe on]	Configures hash synchronization.
	aggregateport hash-header {inner outer inner-outer}	Configures the balancing factor acquisition mode for tunnel packet.
aggregateport algorithm mode number	Configures the global load balancing algorithm mode.	
Configuring an AP Capacity Mode	(Optional) It is used to configure the AP capacity mode.	
	aggregateport capacity mode	Configures an AP capacity mode in global configuration mode.
Enabling BFD for AP Member Ports	(Optional) It is used to enable BFD for AP member ports.	
	aggregate bfd-detect ipv4	Enables IPv4 BFD for AP member ports.
Configuring a Preferred AP Member Port	(Optional) It is used to configure an AP member port as the preferred port.	
	aggregateport primary-port	Configures an AP member port as the preferred port.
Configuring the Minimum Number of AP Member Ports	aggregateport member minimum	Configures the minimum number of AP member ports.
Configuring the Minimum Number of AP Member Ports (Action)	aggregateport member minimum action	Triggers action when the number of AP member ports in the Up state is less than the minimum number of the AP member ports.
Enabling the LACP Independent Port Function	lACP individual enable	Enables the LACP independent port function.
Configuring the Time-out Period of Independent Port	lACP individual-timeout period time	Configures the time-out period of an independent port.

25.5.1 Configuring Static AP Ports

Configuration Effect

- Configure multiple physical ports as AP member ports to realize link aggregation.
- The bandwidth of the aggregation link is equal to the sum of the member link bandwidths.
- When a member link of the AP port is disconnected, the load carried by the link is automatically allocated to other functional member links.

Notes

- Only physical ports can be added to an AP port.
- The ports of different media types or port modes cannot be added to the same AP port.
- Layer-2 ports can be added to only a Layer-2 AP port, and Layer-3 ports can be added to only a Layer-3 AP port. The Layer-2/3 attributes of an AP port that contains member ports cannot be modified.
- After a port is added to an AP port, the attributes of the port are replaced by those of the AP port.
- After a port is removed from an AP port, the attributes of the port are restored.
- ❗ After a port is added to an AP port, the attributes of the port are consistent with those of the AP port. Therefore, do not perform configuration on the AP member ports or apply configuration to a specific AP member port. However, some configurations (the **shutdown** and **no shutdown** commands) can be configured on AP member ports. When you use AP member ports, check whether the function that you want to configure can take effect on a specific AP member port, and perform this configuration properly.
- ❗ The static aggregation has no error detection. Member ports are bound if linked up, so the user needs to ensure topology accuracy and consistency among member ports' negotiation attributes.

Configuration Steps

📌 Creating an Ethernet AP Port

- Mandatory.
- Perform this configuration on an AP-enabled device.

Command	interface aggregateport <i>ap-number</i>
Parameter	<i>ap-number</i> : Indicates the number of an AP port.
Description	
Defaults	By default, no AP port is created.
Command Mode	Global configuration mode
Usage Guide	To create an Ethernet AP port, run interfaces aggregateport in global configuration mode. To delete the specified Ethernet AP port, run no interfaces aggregateport <i>ap-number</i> in global configuration mode.

- ℹ Run **port-group** to add a physical port to a static AP port in interface configuration mode. If the AP port does not exist, it will be created automatically.
- ℹ Run **port-group mode** to add a physical port to an LACP AP port in interface configuration mode. If the AP port does not exist, it will be created automatically.
- ℹ The AP feature must be configured on the devices at both ends of a link and the AP mode must be the same (static AP or LACP AP).

▾ **Configuring Static AP Member Ports**

- Mandatory.
- Perform this configuration on AP-enabled devices.

Command	port-group <i>ap-number</i>
Parameter Description	port-group <i>ap-number</i> : Indicates the number of an AP port.
Defaults	By default, no ports are added to any static AP port.
Command Mode	Interface configuration mode of the specified Ethernet port
Usage Guide	To add member ports to an AP port, run port-group in interface configuration mode. To remove member ports from an AP port, run no port-group in interface configuration mode.

- i** The static AP member ports configured on the devices at both ends of a link must be consistent.
- i** After a member port exits the AP port, the default settings of the member port are restored. Different functions deal with the default settings of the member ports differently. It is recommended that you check and confirm the port settings after a member port exits an AP port.
- i** After a member port exits an AP port, the port is disabled by using the **shutdown** command to avoid loops. After you confirm that the topology is normal, run **no shutdown** in interface configuration mode to enable the port again.

▾ **Converting Layer-2 APs to Layer-3 APs**

- Optional.
- When you need to enable Layer-3 routing on an AP port, for example, to configure IP addresses or static route entries, convert the Layer-2 AP port to a Layer-3 AP port and enable routing on the Layer-3 AP port.
- Perform this configuration on AP-enabled devices that support Layer-2 and Layer-3 features, such as Layer-3 switches or wireless access controllers (ACs).

Command	no switchport
Parameter Description	N/A
Defaults	By default, the AP ports are Layer-2 AP ports.
Command Mode	Interface configuration mode of the specified AP port
Usage Guide	The Layer-3 AP feature is supported by only Layer-3 devices.

- i** The AP port created on a Layer-3 device that does not support Layer-2 feature is a Layer-3 AP port. Otherwise, the AP port is a Layer-2 AP port.

▾ **Creating an Ethernet AP Subinterface**

- Optional.
- On a device that supports subinterface configuration, run **interface aggregateport** *sub-ap-number* to create a subinterface.

- Perform this configuration on AP-enabled devices that support Layer-2 and Layer-3 features, such as Layer-3 switches.

Command	interface aggregateport <i>sub-ap-number</i>
Parameter Description	<i>sub-ap-number</i> : Indicates the number of an AP subinterface.
Defaults	By default, no subinterfaces are created.
Command Mode	Interface configuration mode of the specified AP port
Usage Guide	You need to convert the master port of the AP port to a Layer-3 port before creating a subinterface.

Verification

- Run **show running** to display the configuration.
- Run **show aggregateport summary** to display the AP configuration.

Command	show aggregateport <i>aggregate-port-number</i> [load-balance summary]
Parameter Description	<i>aggregate-port-number</i> : Indicates the number of an AP port. load-balance : Displays the load balancing algorithm. summary : Displays the summary of each link.
Command Mode	Any mode
Usage Guide	The information on all AP ports is displayed if you do not specify the AP port number.
<pre> FS# show aggregateport 1 summary AggregatePort MaxPorts SwitchPort Mode Load balance Ports ----- Ag1 8 Enabled ACCESS dst-mac Gi0/2 </pre>	

Configuration Example

📌 **Configuring an Ethernet Static AP Port**

Scenario Figure 3-2	
Configuration Steps	<ul style="list-style-type: none"> ● Add the GigabitEthernet 1/1 and GigabitEthernet 1/2 ports on Switch A to static AP port 3. ● Add the GigabitEthernet 2/1 and GigabitEthernet 2/2 ports on Switch B to static AP port 3.
Switch A	<pre> SwitchA# configure terminal SwitchA(config)# interface range GigabitEthernet 1/1-2 SwitchA(config-if-range)# port-group 3 </pre>
Switch B	<pre> SwitchB# configure terminal SwitchB(config)# interface range GigabitEthernet 2/1-2 </pre>

	SwitchB(config-if-range)# port-group 3
Verification	<ul style="list-style-type: none"> ● Run show aggregateport summary to check whether AP port 3 contains member ports GigabitEthernet 1/1 and GigabitEthernet 1/2.
Switch A	<pre>SwitchA# show aggregateport summary AggregatePort MaxPorts SwitchPort Mode Ports ----- Ag3 8 Enabled ACCESS Gi1/1,Gi1/2</pre>
Switch B	<pre>SwitchB# show aggregateport summary AggregatePort MaxPorts SwitchPort Mode Ports ----- Ag3 8 Enabled ACCESS Gi2/1,Gi2/2</pre>

25.5.2 Configuring LACP AP Ports

Configuration Effect

- Connected devices perform autonegotiation through LACP to realize dynamic link aggregation.
- The bandwidth of the aggregation link is equal to the sum of the member link bandwidths.
- When a member link of the AP port is disconnected, the load carried by the link is automatically allocated to other functional member links.
- It takes LACP 90s to detect a link failure in long timeout mode and 3s in short timeout mode.

Notes

- After a port exits an LACP AP port, the default settings of the port may be restored. Different functions deal with the default settings of the member ports differently. It is recommended that you check and confirm the port settings after a member port exits an LACP AP port.
- Changing the LACP system priority may cause LACP member ports to be disaggregated and aggregated again.
- Changing the priority of an LACP member port may cause the other member ports to be disaggregated and aggregated again.

Configuration Steps

📌 Configuring LACP Member Ports

- Mandatory.
- Perform this configuration on LACP-enabled devices.

Command	port-group <i>key-number</i> mode { active passive }
Parameter Description	<p><i>Key-number</i>: Indicates the management key of an AP port. In other words, it is the LACP AP port number. The maximum value is subject to the number of AP ports supported by the device.</p> <p>active: Indicates that ports are added to a dynamic AP port actively.</p> <p>passive: Indicates that ports are added to a dynamic AP port passively.</p>

Defaults	By default, no physical ports are added to any LACP AP port.
Command	Interface configuration mode of the specified physical port
Mode	
Usage Guide	Use this command in interface configuration mode to add member ports to an LACP AP port.

 The LACP member port configuration at both ends of a link must be consistent.

⤵ **Configuring the LACP System ID**

- Optional.
- Configure the LACP system ID when LACP ports of multiple (a maximum of four) independent devices need to negotiate with the LACP port of a specific device. Configure the LACP system ID together with the LACP device ID.

Command	lACP system-id <i>system-id</i>
Parameter Description	<i>system-id</i> : Indicates the system ID of an aggregation group. It must be a valid unicast MAC address.
Defaults	The LACP system ID is the MAC address of device by default.
Command Mode	Interface configuration mode
Usage Guide	Use this command in interface configuration mode to configure the LACP system ID.

⤵ **Configuring the LACP Device ID**

- Optional.
- Configure the LACP device ID when LACP ports of multiple (a maximum of four) independent devices need to negotiate with the LACP port of a specific device. Configure the LACP device ID together with the LACP system ID.

Command	lACP device <i>number</i>
Parameter Description	<i>number</i> : Indicates the device ID of an aggregation group. The value ranges from 0 to 3 .
Defaults	The LACP device ID is 0 by default.
Command Mode	Interface configuration mode
Usage Guide	Use this command in interface configuration mode to configure the LACP device ID.

⤵ **Configuring the LACP System Priority**

- Optional.
- Perform this configuration when you need to adjust the system ID priority. A smaller value indicates a higher system ID priority. The device with a higher system ID priority selects an AP port.
- Perform this configuration on LACP-enabled devices.

Command	lACP system-priority <i>system-priority</i>
Parameter Description	<i>system-priority</i> : Indicates the LACP system priority. The value ranges from 0 to 65535.
Defaults	By default, the LACP system priority is 32768.
Command Mode	Global configuration mode

Usage Guide	Use this command in global configuration mode to configure the LACP system priority. All the dynamic member links share one LACP system priority. Changing the LACP system priority will affect all member links. To restore the default settings, run no lacp system-priority in interface configuration mode.
--------------------	--

▾ **Configuring the Priority of an LACP Member Port**

- Optional.
- Perform this configuration when you need to specify the port ID priority. A smaller value indicates a higher port ID priority. The port with the highest port ID priority will be selected as the master port.
- Perform this configuration on LACP-enabled devices.

Command	lacp port-priority <i>port-priority</i>
Parameter Description	<i>port-priority</i> : Indicates the priority of an LACP member port. The value ranges from 0 to 65535.
Defaults	By default, the priority of an LACP member port is 32768.
Command Mode	Interface configuration mode of the specified physical port
Usage Guide	Use this command in global configuration mode to configure the priority of an LACP member port. To restore the settings, run no lacp port-priority in interface configuration mode.

▾ **Configuring the Timeout Mode of LACP Member Ports**

- Optional.
- When you need to implement real-time link failure detection, configure the short timeout mode. It takes LACP 90s to detect a link failure in long timeout mode and 3s in short timeout mode. (The default timeout time in LACP short timeout mode is 3 seconds. The value is changeable.)
- Perform this configuration on LACP-enabled devices, such as switches.

Command	lacp short-timeout
Parameter Description	N/A
Defaults	By default, the timeout mode of LACP member ports is long timeout.
Command Mode	Interface configuration mode
Usage Guide	The timeout mode is supported only by physical ports. To restore the default settings, run no lacp short-timeout in interface configuration mode.

▾ **Configuring the Timeout Time of the LACP System in Short Timeout Mode**

- Optional.
- Configure this function when the timeout time of a device in LACP short timeout mode needs to be adjusted.
- Configure this function on devices that support the LACP function.

Command	lacp short-timeout period <i>value</i>
Parameter Description	<i>value</i> : Indicates the timeout time in short timeout mode. The value ranges from 3 seconds to 90 seconds.
Defaults	The default timeout time in LACP short timeout mode is 3 seconds.

Command Mode	Global configuration mode
Usage Guide	In global configuration mode, run the command to configure the timeout time in LACP short timeout mode. All dynamic link groups configured on a device share the same timeout time in LACP short timeout mode. Changing the value will affect all aggregate groups on the switch. In interface configuration mode, run the no lacp short-timeout period command to restore the timeout time in LACP short timeout mode to the default value.

Verification

- Run **show running** to display the configuration.
- Run **show lacp summary** to display LACP link state.

Command	show lacp summary [<i>key-number</i>]
Parameter Description	<i>key-name</i> : Indicates the number of an LACP AP port.
Command Mode	Any mode
Usage Guide	The information on all LACP AP ports is displayed if you do not specify <i>key-name</i> . The system ID and device ID are displayed if configured.
	<pre> FS#show lacp summary System Id:32768, 0000.1236.54aa Flags: S - Device is requesting Slow LACPDUs F - Device is requesting Fast LACPDUs. A - Device is in active mode. P - Device is in passive mode. Aggregate port 2: System Id: 0000.1236.54aa Device num : 1 Local information: LACP port Oper Port Port Port Flags State Priority Key Number State ----- Te1/0/1 SA down 32768 0x2 0x4001 0x45 Partner information: LACP port Oper Port Port Port Flags Priority Dev ID Key Number State ----- Te1/0/1 SP 0 0000.0000.0000 0x0 0x0 0x0 </pre>

Configuration Example

➤ **Configuring LACP**

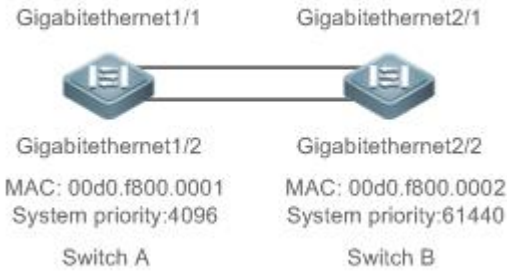
<p>Scenario Figure 4-3</p>	
<p>Configuration Steps</p>	<ul style="list-style-type: none"> ● On Switch A, set the LACP system priority to 4096. ● Enable dynamic link aggregation on the GigabitEthernet1/1 and GigabitEthernet1/2 ports on Switch A and add the ports to LACP AP port 3. ● On Switch B, set the LACP system priority to 61440. ● Enable dynamic link aggregation on the GigabitEthernet2/1 and GigabitEthernet2/2 ports on Switch B and add the ports to LACP AP port 3.
<p>Switch A</p>	<pre>SwitchA# configure terminal SwitchA(config)# lacp system-priority 4096 SwitchA(config)# interface range GigabitEthernet 1/1-2 SwitchA(config-if-range)# port-group 3 mode active SwitchA(config-if-range)# end</pre>
<p>Switch B</p>	<pre>SwitchB# configure terminal SwitchB(config)# lacp system-priority 61440 SwitchB(config)# interface range GigabitEthernet 2/1-2 SwitchB(config-if-range)# port-group 3 mode active SwitchB(config-if-range)# end</pre>
<p>Verification</p>	<ul style="list-style-type: none"> ● Run show lacp summary 3 to check whether LACP AP port 3 contains member ports GigabitEthernet2/1 and GigabitEthernet2/2.
<p>Switch A</p>	<pre>SwitchA# show LACP summary 3 System Id:32768, 00d0.f8fb.0001 Flags: S - Device is requesting Slow LACPDUs F - Device is requesting Fast LACPDUs. A - Device is in active mode. P - Device is in passive mode. Aggregated port 3: Local information: LACP port Oper Port Port Port Flags State Priority Key Number State</pre>

	<pre> ----- Gi1/1 SA bndl 32768 0x3 0x1 0x3d Gi1/2 SA bndl 32768 0x3 0x2 0x3d Partner information: LACP port Oper Port Port Port Flags Priority Dev ID Key Number State ----- Gi1/1 SA 32768 00d0.f800.0002 0x3 0x1 0x3d Gi1/2 SA 32768 00d0.f800.0002 0x3 0x2 0x3d </pre>
Switch B	<pre> SwitchB# show LACP summary 3 System Id:32768, 00d0.f8fb.0002 Flags: S - Device is requesting Slow LACPDUs F - Device is requesting Fast LACPDUs. A - Device is in active mode. P - Device is in passive mode. Aggregated port 3: Local information: LACP port Oper Port Port Port Flags State Priority Key Number State ----- Gi2/1 SA bndl 32768 0x3 0x1 0x3d Gi2/2 SA bndl 32768 0x3 0x2 0x3d Partner information: LACP port Oper Port Port Port Flags Priority Dev ID Key Number State ----- Gi2/1 SA 32768 00d0.f800.0001 0x3 0x1 0x3d Gi2/2 SA 32768 00d0.f800.0001 0x3 0x2 0x3d </pre>

25.5.3 Enabling LinkTrap

Configuration Effect

Enable the system with LinkTrap to send LinkTrap messages when aggregation links are changed.

Configuration Steps

📌 Enabling LinkTrap for an AP Port

- Optional.
- Enable LinkTrap in interface configuration mode. By default, LinkTrap is enabled. LinkTrap messages are sent when the link state or protocol state of the AP port is changed.
- Perform this configuration on AP-enabled devices.

Command	snmp trap link-status
Parameter	N/A
Description	
Defaults	By default, LinkTrap is enabled.
Command Mode	Interface configuration mode of the specified AP port
Usage Guide	Use this command in interface configuration mode to enable LinkTrap for the specified AP port. After LinkTrap is enabled, LinkTrap messages are sent when the link state of the AP port is changed. Otherwise, LinkTrap messages are not sent. By default, LinkTrap is enabled. To disable LinkTrap for an AP port, run no snmp trap link-status in interface configuration mode. LinkTrap cannot be enabled for a specific AP member port. To enable LinkTrap for all AP member ports, run aggregateport member linktrap in global configuration mode.

↘ **Enabling LinkTrap for AP Member Ports**

- Optional.
- By default, LinkTrap is disabled for AP member ports.
- Perform this configuration on AP-enabled devices.

Command	aggregateport member linktrap
Parameter	N/A
Description	
Defaults	By default, LinkTrap is disabled for AP member ports.
Command Mode	Global configuration mode
Usage Guide	Use this command in global configuration mode to enable LinkTrap for all AP member ports. By default, LinkTrap messages are not sent when the link state of AP member ports is changed. To disable LinkTrap for all AP member ports, run no aggregateport member linktrap in global configuration mode.

Verification

- Run **show running** to display the configuration.
- After LinkTrap is enabled, you can monitor this feature on AP ports or their member ports by using the MIB software.

Configuration Example

↘ **Enabling LinkTrap for AP Member Ports**

<p>Scenario</p> <p>Figure 3-4</p>	
<p>Configuration Steps</p>	<ul style="list-style-type: none"> ● Add the GigabitEthernet 1/1 and GigabitEthernet 1/2 ports on Switch A to static AP port 3. ● Add the GigabitEthernet 2/1 and GigabitEthernet 2/2 ports on Switch B to static AP port 3. ● On Switch A, disable LinkTrap for AP port 3 and enable LinkTrap for its member ports. ● On Switch B, disable LinkTrap for AP port 3 and enable LinkTrap its AP member ports.
<p>Switch A</p>	<pre>SwitchA# configure terminal SwitchA(config)# interface range GigabitEthernet 1/1-2 SwitchA(config-if-range)# port-group 3 SwitchA(config-if-range)# exit SwitchA(config)# aggregateport member linktrap SwitchA(config)# interface Aggregateport 3 SwitchA(config-if-AggregatePort 3)# no snmp trap link-status</pre>
<p>Switch B</p>	<pre>SwitchB# configure terminal SwitchB(config)# interface range GigabitEthernet 2/1-2 SwitchB(config-if-range)# port-group 3 SwitchB(config-if-range)# exit SwitchB(config)# aggregateport member linktrap SwitchB(config)# interface Aggregateport 3 SwitchB(config-if-AggregatePort 3)# no snmp trap link-status</pre>
<p>Verification</p>	<ul style="list-style-type: none"> ● Run show running to check whether LinkTrap is enabled for AP port 3 and its member ports.
<p>Switch A</p>	<pre>SwitchA# show run include AggregatePort 3 Building configuration... Current configuration: 54 bytes interface AggregatePort 3 no snmp trap link-status SwitchA# show run include AggregatePort aggregateport member linktrap</pre>
<p>Switch B</p>	<pre>SwitchB# show run include AggregatePort 3 Building configuration...</pre>

```
Current configuration: 54 bytes
interface AggregatePort 3
    no snmp trap link-status
SwitchB# show run | include AggregatePort
aggregateport member linktrap
```

25.5.4 Configuring a Load Balancing Mode

Configuration Effect

- The system distributes incoming packets among member links by using the specified load balancing algorithm. The packet flow with the consistent feature is transmitted by one member link, whereas different packet flows are evenly distributed to various links. A device enabled with enhanced load balancing first determines the type of packets to be transmitted and performs load balancing based on the specified fields in the packets. For example, the AP port performs source IP-based load balancing on the packets containing an ever-changing source IPv4 address.
- In enhanced load balancing mode, configure the hash disturbance factor to ensure that same packets from two devices of the same type will be balanced to different links.
- In enhanced load balancing mode, enable hash synchronization to ensure that uplink and downlink packets of the same type will be transmitted over the same link. For example, in load balancing based on the source and destination IP addresses, enable hash synchronization for IPv4 packets to ensure that the uplink and downlink IPv4 packets will be transmitted over the same path.

Notes

- Different disturbance factors may lead to the same disturbance effect.
- Enable or disable hash synchronization for IPv4, IPv6, FCoE and On as required.

Configuration Steps

📌 Configuring the Global Load Balancing Algorithm of an AP port

- (Optional) Perform this configuration when you need to optimize load balancing.
- Perform this configuration on AP-enabled devices.

Command	aggregateport load-balance { dst-mac src-mac src-dst-mac dst-ip src-ip src-dst-ip src-dst-ip-l4port enhanced profile <i>profile-name</i> }
Parameter Description	<p>dst-mac: Indicates that load is distributed based on the destination MAC addresses of incoming packets.</p> <p>src-mac: Indicates that load is distributed based on the source MAC addresses of incoming packets.</p> <p>src-dst-ip: Indicates that load is distributed based on source and destination IP addresses of incoming packets.</p> <p>dst-ip: Indicates that load is distributed based on the destination IP addresses of incoming packets.</p> <p>src-ip: Indicates that load is distributed based on the source IP addresses of incoming packets.</p> <p>src-dst-mac: Indicates that load is distributed based on source and destination MAC addresses of incoming packets.</p> <p>src-dst-ip-l4port: Indicates that load is distributed based on source IP and destination IP addresses as well as Layer-4 source and destination port numbers.</p> <p>enhanced profile <i>profile-name</i>: Indicates the name of the enhanced load balancing profile.</p>
Defaults	Load balancing can be based on source and destination MAC addresses (applicable to switches), source and

	destination IP addresses (applicable to gateways), or the profile of enhanced load balancing (applicable to switches with CB line cards).
Command Mode	Global configuration mode
Usage Guide	<p>To restore the default settings, run no aggregateport load-balance in global configuration mode.</p> <p>You can run aggregateport load-balance in interface configuration mode of an AP port on devices that support load balancing configuration on a specific AP port. The configuration in interface configuration mode prevails. To disable the load balancing algorithm, run no aggregateport load-balance in interface configuration mode of the AP port. After that, the load balancing algorithm configured in global configuration mode takes effect.</p> <p> You can run aggregateport load-balance in interface configuration mode of an AP port on devices that support load balancing configuration on a specific AP port.</p>

➤ **Renaming the Profile of Enhanced Load Balancing**

- By default, if a device supports enhanced load balancing, the system creates a profile named **default** for enhanced load balancing. Perform this configuration when you need to rename the profile or restore the default settings. In other cases, the configuration is optional.
- Perform this configuration on devices that support enhanced load balancing, such as aggregation switches and core switches.

Command	load-balance-profile <i>profile-name</i>
Parameter Description	<i>profile-name</i> : Indicates the profile name, which contains up to 31 characters.
Defaults	The default profile name is default .
Command Mode	Global configuration mode
Usage Guide	<p>To enter default profile mode, run load-balance-profile default. To rename the enhanced load balancing profile, run load-balance-profile profile-nam. To restore the default profile name, run default load-balance-profile in global configuration mode. To restore the default load balancing settings, run default load-balance-profile profile-name in global configuration mode.</p> <p>Only one profile is supported globally. Please do not delete the profile. To display the enhanced load balancing profile, run show load-balance-profile.</p>

➤ **Configuring the Layer-2 Packet Load Balancing Mode**

- (Optional) Perform this configuration to specify the Layer-2 packet load balancing mode.
- Perform this configuration on devices that support enhanced load balancing, such as aggregation switches and core switches.

Command	l2 field { [src-mac] [dst-mac] [l2-protocol] [src-port] }
Parameter Description	<p>src-mac: Indicates that load is distributed based on the source MAC addresses of incoming Layer-2 packets.</p> <p>dst-mac: Indicates that load is distributed based on the destination MAC addresses of incoming Layer-2 packets.</p> <p>l2-protocol: Indicates that load is distributed based on the Layer-2 protocol types of incoming Layer-2 packets.</p> <p>src-port: Indicates that load is distributed based on the panel port for incoming Layer-2 packets.</p>
Defaults	By default, the load balancing mode is src-mac , dst-mac and vlan .
Command Mode	Profile configuration mode

Usage Guide	To restore the default settings, run no l2 field in profile configuration mode.
--------------------	--

↘ **Configuring the IPv4 Packet Load Balancing Mode**

- Optional.
- Perform this configuration to specify the IPv4 packet load balancing mode.
- Perform this configuration on devices that support enhanced load balancing, such as aggregation switches and core switches.

Command	ipv4 field { [src-ip] [dst-ip] [protocol] [I4-src-port] [I4-dst-port] [src-port] }
Parameter Description	<p>src-ip: Indicates that load is distributed based on the source IP addresses of incoming IPv4 packets.</p> <p>dst-ip: Indicates that load is distributed based on the destination IP addresses of incoming IPv4 packets.</p> <p>protocol: Indicates that load is distributed based on the protocol types of incoming IPv4 packets.</p> <p>I4-src-port: Indicates that load is distributed based on the Layer-4 source port numbers of incoming IPv4 packets.</p> <p>I4-dst-port: Indicates that load is distributed based on the Layer-4 destination port numbers of incoming IPv4 packets.</p> <p>src-port: Indicates that load is distributed based on the panel port for incoming IPv4 packets.</p>
Defaults	By default, the load balancing mode is src-ip and dst-ip .
Command Mode	Profile configuration mode
Usage Guide	To restore the default settings, run no ipv4 field in profile configuration mode.

↘ **Configuring the IPv6 Packet Load Balancing Mode**

- Optional.
- Perform this configuration to specify the IPv6 packet load balancing mode.
- Perform this configuration on devices that support IPv6 packet load balancing, such as aggregation switches and core switches.

Command	ipv6 field { [src-ip] [dst-ip] [protocol] [I4-src-port] [I4-dst-port] [src-port] }
Parameter Description	<p>src-ip: Indicates that load is distributed based on the source IP addresses of incoming IPv6 packets.</p> <p>dst-ip: Indicates that load is distributed based on the destination IP addresses of incoming IPv6 packets.</p> <p>protocol: Indicates that load is distributed based on the protocol types of incoming IPv6 packets.</p> <p>I4-src-port: Indicates that load is distributed based on the Layer-4 source port numbers of incoming IPv6 packets.</p> <p>I4-dst-port: Indicates that load is distributed based on the Layer-4 destination port numbers of incoming IPv6 packets.</p> <p>src-port: Indicates that load is distributed according to the source port numbers of incoming IPv6 packets.</p>
Defaults	By default, the load balancing mode is src-ip and dst-ip .
Command Mode	Profile configuration mode
Usage Guide	To restore the default settings, run no ipv6 field in profile configuration mode.

↘ **Configuring the MPLS Packet Load Balancing Mode**

- Optional.
- Perform this configuration to specify the MPLS packet load balancing mode.
- Perform this configuration on devices that support MPLS packet load balancing, such as aggregation switches and core switches.



Command	mpls field { [top-label] [2nd-label] [3rd-label] [src-ip] [dst-ip] [vlan] [src-port] [dst-port] [src-mac] [dst-mac] [protocol] [I4-src-port] [I4-dst-port] [I2-etype] }
Parameter Description	<p>src-ip: Indicates that load is distributed based on the source IP addresses of incoming MPLS packets.</p> <p>dst-ip: Indicates that load is distributed based on the destination IP addresses of incoming MPLS packets.</p> <p>top-label: Indicates that load is distributed based on the top labels of incoming MPLS packets.</p> <p>2nd-label: Indicates that load is distributed based on the second labels of incoming MPLS packets.</p> <p>3rd-label: Indicates that load is distributed based on the third labels of incoming MPLS packets.</p> <p>vlan: Indicates that load is distributed based on the VLAN IDs of incoming MPLS packets.</p> <p>src-port: Indicates that load is distributed based on the source port numbers of incoming MPLS packets.</p> <p>dst-port: Indicates that load is distributed based on the panel port for outgoing MPLS packets.</p> <p>src-mac: Indicates that load is distributed based on the source MAC addresses of incoming MPLS packets.</p> <p>dst-mac: Indicates that load is distributed based on the destination MAC addresses of incoming MPLS packets.</p> <p>protocol: Indicates that load is distributed based on the protocol types of incoming MPLS packets.</p> <p>I4-src-port: Indicates that load is distributed based on the Layer-4 source port numbers of incoming MPLS packets.</p> <p>I4-dst-port: Indicates that load is distributed based on the Layer-4 destination port numbers of incoming MPLS packets.</p> <p>I2-etype: Indicates that load is distributed based on the Ethernet types of MPLS packets.</p>
Defaults	By default, the load balancing mode of MPLS packets is top-label and 2nd-label .
Command Mode	Profile configuration mode
Usage Guide	To restore the default settings, run no mpls field in profile configuration mode.

The MPLS load balancing algorithm takes effect only for MPLS Layer-3 VPN packets.

Configuring the TRILL Packet Load Balancing Mode

- Optional.
- Perform this configuration to specify the TRILL packet load balancing mode.
- Perform this configuration on devices that support TRILL packet load balancing, such as aggregation switches and core switches.

Command	trill field { [vlan] [src-ip] [dst-ip] [src-port] [dst-port] [src-mac] [dst-mac] [I4-src-port] [I4-dst-port] [I2-etype] [protocol] [ing-nick] [egr-nick] }
Parameter Description	<p>vlan: Indicates that load is distributed based on the VLAN IDs of incoming TRILL packets.</p> <p>src-ip: Indicates that load is distributed based on the source IP addresses of incoming TRILL packets.</p> <p>dst-ip: Indicates that load is distributed based on the destination IP addresses of incoming TRILL packets.</p> <p>src-port: Traffic is distributed according to the source port numbers of the incoming TRILL packets.</p> <p>src-mac: Indicates that load is distributed based on the source MAC addresses of incoming TRILL packets.</p> <p>dst-mac: Indicates that load is distributed based on the destination MAC addresses of incoming TRILL packets.</p> <p>I4-src-port: Indicates that load is distributed based on the Layer-4 source port numbers of incoming TRILL packets.</p> <p>I4-dst-port: Indicates that load is distributed based on the Layer-4 destination port numbers of incoming TRILL packets.</p> <p>I2-etype: Indicates that load is distributed based on the Ethernet types of TRILL packets.</p> <p>protocol: Indicates that load is distributed based on the protocol types of incoming TRILL packets.</p> <p>ing-nick: Indicates that load is distributed based on the Ingress Rbridge Nicknames of incoming TRILL packets.</p> <p>egr-nick: Indicates that load is distributed based on the Egress Rbridge Nicknames of incoming TRILL packets.</p>

Defaults	By default, the load balancing mode of TRILL packets is src-mac , dst-mac and vlan .
Command Mode	Profile configuration mode
Usage Guide	<p>To restore the default settings, run no trill field in profile configuration mode.</p> <ul style="list-style-type: none">  TRILL Transit RBridge packet flows are balanced based on the following fields: ing-nick, egr-nick, src-mac, dst-mac, vlan, and I2-etype.  TRILL Egress RBridge packet flows are balanced based on the following fields: Layer-2 packets: src-mac, dst-mac, vlan, and I2- protocol. Layer-3 packets: src-ip, dst-ip, I4-src-port, I4-dst-port, protocol, and vlan.  The src-port and dst-port fields can be used to balance all TRILL Transit RBridge and TRILL Egress RBridge packet flows.

➤ **Configuring the FCoE Packet Load Balancing Mode**

- Optional.
- Perform this configuration to specify the FCoE packet load balancing mode.
- Perform this configuration on devices that support FCoE packet load balancing, such as aggregation switches and core switches.

Command	fcoe field {[vlan] [src-port] [dst-port] [src-id] [dst-id] [rx-id] [ox-id] [fabric-id]}
Parameter Description	<p>vlan: Indicates that load is distributed based on the VLAN IDs of incoming FCoE packets.</p> <p>src-port: Indicates that load is distributed based on the source port numbers of incoming FCoE packets.</p> <p>src-id: Indicates that load is distributed based on the source IDs of FCoE packets.</p> <p>dst-id: Indicates that load is distributed based on the destination IDs of FCoE packets.</p> <p>rx-id: Indicates that load is distributed based on the Responder Exchange IDs of FCoE packets.</p> <p>ox-id: Indicates that load is distributed based on the Originator Exchange IDs of FCoE packets.</p> <p>fabric-id: Indicates that load is distributed based on the FC network fabric IDs of FCoE packets.</p>
Defaults	By default, the load balancing mode of FCoE packets is src-id , dst-id and ox-id .
Command Mode	Profile configuration mode
Usage Guide	To restore the default settings, run no fcoe field in profile configuration mode.

➤ **Configuring the Hash Disturbance Factor**

- Optional
- Perform this operation to balance packets of the same type over the AP port for devices of the same type.

Command	hash-disturb {string} { [seed seed_value] [offset offset] }
Parameter Description	<p><i>string</i>: Indicates the character string used to calculate the hash disturbance factor.</p> <p><i>seed_value</i>: Indicates the seed value of hash disturbance.</p> <p><i>offset</i>: Indicates the offset value of hash disturbance.</p>
Defaults	By default, no hash disturbance factor is set.
Command Mode	Profile configuration mode

Usage Guide	<p>To restore the default settings, run no hash-disturb in profile configuration mode.</p> <p>To configure HASH disturbance, you can run either the hash-disturb <i>string</i> command or the hash-disturb { [seed <i>seed_value</i>] [offset <i>offset</i>] } command. The latter is supported on few models. And these two commands are mutually excluded. Thus, you need to remove the first configuration before adopting a second configuration.</p>
--------------------	--

📌 **Enabling or Disabling Hash Synchronization**

- Optional
- Perform this operation to ensure that uplink and downlink streams of the same packet type are transmitted over the same path.

Command	hash-disturb { ipv4 ipv6 fcoe }
Parameter Description	<p>ipv4: Indicates that hash synchronization is enabled for IPv4 packets.</p> <p>ipv6: Indicates that hash synchronization is enabled for IPv6 packets.</p> <p>fcoe: Indicates that hash synchronization is enabled for FCoE packets.</p>
Defaults	Set it as required.
Command Mode	Profile configuration mode
Usage Guide	When hash synchronization is enabled for IPv4, IPv6, and FCoE packets as required, if uplink and downlink streams of the same packet type do not need to be transmitted over the same path, run the no form of this command in profile configuration mode.

📌 **Configuring Global Traffic Balance Algorithm Mode on AP**

- Optional
- Perform this operation when traffic changes to keep traffic balance.

Command	aggregateport algorithm mode <i>number</i>
Parameter Description	<i>Number</i> : Indicates algorithm mode.
Defaults	The default mode varies from product. Run command show aggregateport load-balance to check the default setting.
Command Mode	Global configuration mode
Usage Guide	Run command no aggregateport algorithm mode in global configuration mode to restore the default setting. Run command show running and show aggregateport load-balance to check whether it takes effect.

📌 **Configuring the Balancing Factor Acquisition Mode for Tunnel Packets**

- Optional. When performing load balancing, use this command to specify the balancing factor acquisition mode for specific tunnel packets, to optimize traffic balancing.

Command	aggregateport hash-header { inner outer inner-outer }
Parameter Description	<p>inner: Specifies the inner layer in the header of tunnel packets as the source for acquiring the balancing factor.</p> <p>outer: Specifies the outer layer in the header of tunnel packets as the source for acquiring the balancing factor.</p> <p>inner-outer: Specifies both the inner and outer layers in the header of tunnel packets as the source for acquiring the balancing factor.</p>
Defaults	The default configuration varies with products.
Command	Global configuration mode

Mode	
Usage Guide	<p>Use the default form of this command to restore the default acquisition mode.</p> <p>After configuration, if the show running command does not display the configuration, the configured mode is the same as the default value.</p> <p> The supported configuration options and types of tunnel packets vary with products. S6250 and S6500 series products support the outer configuration.</p>

Verification

- Run **show running** to display the configuration.
- Run **show aggregateport load-balance** to display the load balancing configuration. If a device supports load balancing configuration on a specific AP port, run **show aggregateport summary** to display the configuration.
- Run **show load-balance-profile** to display the enhanced load balancing profile.

Command	show aggregateport <i>aggregate-port-number</i> [load-balance summary]
Parameter	<i>aggregate-port-number</i> : Indicates the number of an AP port.
Description	load-balance : Displays the load balancing algorithm. summary : Displays the summary of each link.
Command Mode	Any mode
Usage Guide	The information on All AP ports is displayed if you do not specify the AP port number.
	<pre>FS# show aggregateport 1 summary AggregatePort MaxPorts SwitchPort Mode Load balance Ports ----- Ag1 8 Enabled ACCESS dst-mac Gi0/2</pre>

Command	show load-balance-profile [<i>profile-name</i>]
Parameter	<i>profile-name</i> : Indicates the profile name.
Description	
Command Mode	Any mode
Usage Guide	All enhanced profiles are displayed if you do not specify the profile number.
	<pre>FS# show load-balance-profile module0 Load-balance-profile: module0 Packet Hash Field: IPv4: src-ip dst-ip IPv6: src-ip dst-ip L2 : src-mac dst-mac vlan MPLS: top-labe l2nd-label</pre>

Configuration Example

Configuring a Load Balancing Mode

<p>Scenario</p> <p>Figure 4-4</p>	
<p>Configuration Steps</p>	<ul style="list-style-type: none"> ● Add the GigabitEthernet 1/1 and GigabitEthernet 1/2 ports on Switch A to static AP port 3. ● Add the GigabitEthernet 2/1 and GigabitEthernet 2/2 ports on Switch B to static AP port 3. ● On Switch A, configure source MAC address-based load balancing for AP port 3 in global configuration mode. ● On Switch B, configure destination MAC address-based load balancing for AP port 3 in global configuration mode.
<p>Switch A</p>	<pre>SwitchA# configure terminal SwitchA(config)# interface range GigabitEthernet 1/1-2 SwitchA(config-if-range)# port-group 3 SwitchA(config-if-range)# exit SwitchA(config)# aggregateport load-balance src-mac</pre>
<p>Switch B</p>	<pre>SwitchB# configure terminal SwitchB(config)# interface range GigabitEthernet 2/1-2 SwitchB(config-if-range)# port-group 3 SwitchB(config-if-range)# exit SwitchB(config)# aggregateport load-balance dst-mac</pre>
<p>Verification</p>	<ul style="list-style-type: none"> ● Run show aggregateport load-balance to check the load balancing algorithm configuration.
<p>Switch A</p>	<pre>SwitchA# show aggregatePort load-balance Load-balance : Source MAC</pre>
<p>Switch B</p>	<pre>SwitchB# show aggregatePort load-balance Load-balance : Destination MAC</pre>

Configuring Hash Load Balancing Control

<p>Scenario</p> <p>Figure 4-5</p>	
<p>Configuration Steps</p>	<ul style="list-style-type: none"> ● Add the GigabitEthernet 1/1 and GigabitEthernet 1/2 ports on Switch A to static AP port 3. ● Add the GigabitEthernet 2/1 and GigabitEthernet 2/2 ports on Switch B to static AP port 3. ● On Switch A, disable hash synchronization for FCoE packets. ● On Switch B, disable hash synchronization for FCoE packets. ● On Switch A, configure the hash disturbance factor A. ● On Switch B, configure the hash disturbance factor B. ● On Switch A, enable flexible hash. ● On Switch B, enable flexible hash.
<p>Switch A</p>	<pre>SwitchA# configure terminal SwitchA(config)# interface range GigabitEthernet 1/1-2 SwitchA(config-if-range)# port-group 3 SwitchA(config-if-range)# exit SwitchA(config)#load-balance-profile SwitchA(config-load-balance-profile)#no hash-symmetrical fcoe SwitchA(config-load-balance-profile)#hash-disturb A SwitchA(config-load-balance-profile)#exit</pre>
<p>Switch B</p>	<pre>SwitchB# configure terminal SwitchB(config)# interface range GigabitEthernet 2/1-2 SwitchB(config-if-range)# port-group 3 SwitchB(config-if-range)# exit SwitchB(config)#load-balance-profile SwitchB(config-load-balance-profile)# no hash-symmetrical fcoe SwitchA(config-load-balance-profile)#hash-disturb B SwitchB(config-load-balance-profile)#exit</pre>
<p>Verification</p>	<ul style="list-style-type: none"> ● Run show running to check whether the configuration is correct.

Common Errors

A user enables hash synchronization for IPv4, IPv6, FCoE and On packets. However, no configuration is displayed when the user runs **show running**. This is because hash synchronization for IPv4, IPv6, and FCoE packets is enabled by default. After the user disables the function, the configuration is displayed.

25.5.5 Configuring an AP Capacity Mode

Configuration Effect

- Change the maximum number of configurable AP ports and the maximum number of member ports in each AP port.

Notes

- The system has a default AP capacity mode. You can run **show aggregateport capacity** to display the current capacity mode.
- If the current configuration (maximum number of AP ports or the number of member ports in each AP port) exceeds the capacity to be configured, the capacity mode configuration will fail.

Configuration Steps

▾ Configuring an AP Capacity Mode

- (Optional) Perform this configuration to change the AP capacity.
- Perform this configuration on devices that support AP capacity change, such as core switches.

Command	aggregateport capacity mode <i>capacity-mode</i>
Parameter Description	<i>capacity-mode</i> : Indicates a capacity mode.
Defaults	By default, AP capacity modes vary with devices. For example, 256 x 16 indicates that the device has a maximum of 256 AP ports and 16 member ports in each AP port.
Command Mode	Global configuration mode
Usage Guide	The system provides several capacity modes for devices that support capacity mode configuration. To restore the default settings, run no aggregateport capacity mode in global configuration mode.

Verification

- Run **show running** to display the configuration.
- Run **show aggregateport capacity** to display the current AP capacity mode and AP capacity usage.

Command	show aggregateport capacity
Parameter Description	N/A
Command Mode	Any mode
Usage Guide	N/A
	<pre> FS# show aggregateport capacity AggregatePort Capacity Information: Configuration Capacity Mode: 128*16. Effective Capacity Mode : 256*8. Available Capacity : 128*8. Total Number: 128, Used: 1, Available: 127. </pre>

Configuration Example

▾ **Configuring an AP Capacity Mode**

<p>Scenario</p> <p>Figure 4-6</p>	
<p>Configuration Steps</p>	<ul style="list-style-type: none"> ● Add the GigabitEthernet 1/1 and GigabitEthernet 1/2 ports on Switch A to static AP port 3. ● Add the GigabitEthernet 2/1 and GigabitEthernet 2/2 ports on Switch B to static AP port 3. ● On Switch A, configure the 128 x128 AP capacity mode. ● On Switch B, configure the 256 x 64 AP capacity mode.
<p>Switch A</p>	<pre>SwitchA# configure terminal SwitchA(config)# interface range GigabitEthernet 1/1-2 SwitchA(config-if-range)# port-group 3 SwitchA(config-if-range)# exit SwitchA(config)# aggregateport capacity mode 128*128</pre>
<p>Switch B</p>	<pre>SwitchB# configure terminal SwitchB(config)# interface range GigabitEthernet 2/1-2 SwitchB(config-if-range)# port-group 3 SwitchB(config-if-range)# exit SwitchB(config)# aggregateport capacity mode 256*64</pre>
<p>Verification</p>	<ul style="list-style-type: none"> ● Run show aggregateport capacity to check the AP capacity mode configuration.
<p>Switch A</p>	<pre>SwitchA# show aggregatePort capacity AggregatePort Capacity Information: Configuration Capacity Mode: 128*128. Effective Capacity Mode : 128*128. Available Capacity Mode : 128*128. Total Number : 128, Used: 1, Available: 127.</pre>
<p>Switch B</p>	<pre>SwitchB# show aggregatePort capacity AggregatePort Capacity Information: Configuration Capacity Mode: 256*64. Effective Capacity Mode : 256*64.</pre>

Available Capacity Mode : 256*64. Total Number : 256, Used: 1, Available: 255.

25.5.6 Enabling BFD for AP Member Ports

Configuration Effect

- Enable BFD for all the member ports of a specified AP port.
- After BFD is enabled for an AP port, each member port performs BFD to determine whether the packets should be distributed to the member port to realize load balancing. When BFD detects a member port Down, the packets are not distributed to the port. When BFD detects that the member port is restored to Up, the packets are distributed to the port again.

Notes

- After BFD is enabled for an AP port, BFD sessions are set up. To make the sessions take effect, you need to configure BFD parameters. For details, see *Configuring BFD*.
- Enabling or disabling BFD for a single AP member port is not supported. You must enable or disable BFD for the entire AP group.
- Only member ports in the forwarding state are enabled with BFD. If a member port is not in the forwarding state because the link or LACP is down, the BFD session on the member port is automatically deleted.
- If only one member port is available (in the forwarding state), all packets are distributed to this port. In this case, BFD fails. When there are more than one available member port, BFD takes effect again.

Configuration Steps

▾ Enabling BFD for AP Member Ports

- (Optional) Enable BFD when you need to detect path failure on member ports in milliseconds. Traffic on the faulty link will be switched to other member links in case of a link failure.
- Perform this configuration on devices that support AP-BFD correlation.

Command	aggregate bfd-detect {ipv4 ipv6} src_ip dst_ip
Parameter Description	ipv4: Enables IPv4 BFD if the AP port is configured with an IPv4 address. ipv6: Enables IPv6 BFD if the AP port is configured with an IPv6 address. <i>src_ip:</i> Indicates the source IP address, that is, the IP address configured on the AP port. <i>dst_ip:</i> Indicates the destination IP address, that is, the IP address configured on the peer AP port.
Defaults	By default, BFD is disabled.
Command Mode	Interface configuration mode of the specified AP port
Usage Guide	<ol style="list-style-type: none"> 1. To make BFD sessions take effect, you need to configure BFD parameters. For details, see <i>Configuring BFD</i>. 2. Different products may support different IPv4/IPv6 BFD. 3. Both IPv4 BFD and IPv6 BFD can be enabled for an AP port if both are supported. 4. After BFD is enabled for an AP port, BFD sessions are automatically set up on its member ports in the forwarding state.

Verification

- Run **show running** to display the configuration.

- Run **show interface aggregateport** to display the BFD state of the AP member ports.

Command	show interface aggregateport <i>ap-num</i>
Parameter Description	<i>ap-num</i> : Indicates the number of an AP port.
Command Mode	Any mode
Usage Guide	N/A
	<pre> FS# show interface aggregateport 11 ... Aggregate Port Informations: Aggregate Number: 11 Name: "AggregatePort 11" Members: (count=2) GigabitEthernet 0/1 Link Status: Up LACP Status: bndl BFD Status: UP GigabitEthernet 0/2 Link Status: Up LACP Status: susp BFD Status: Invalid ... </pre>

Configuration Example

➤ **Enabling IPv4 BFD for AP Member Ports**

Scenario Figure 4-7	
Configuration Steps	<ul style="list-style-type: none"> ● Enable LACP for the GigabitEthernet 1/1 and GigabitEthernet 1/2 ports on Switch A and add the ports to LACP AP port 3. ● Enable LACP for the GigabitEthernet 2/1 and GigabitEthernet 2/2 ports on Switch B and add the ports to LACP AP port 3. ● Configure IP address 1.0.0.1 for AP port 3 on Switch A and enable IPv4 BFD. ● Configure IP address 1.0.0.2 for AP port 3 on Switch B and enable IPv4 BFD.
Switch A	<pre> SwitchA# configure terminal SwitchA(config)# interface range GigabitEthernet 1/1-2 SwitchA(config-if-range)# no switchport SwitchA(config-if-range)# port-group 3 mode active SwitchA(config-if-range)# exit </pre>

	<pre>SwitchA(config)# interface aggregateport 3 SwitchA(config-if-Aggregateport 3)# ip address 1.0.0.1 SwitchA(config-if-Aggregateport 3)# aggregate bfd-detect ipv4 1.0.0.1 1.0.0.2 SwitchA(config-if-Aggregateport 3)# bfd interval 50 min_rx 50 multiplier 3</pre>
Switch B	<pre>SwitchB# configure terminal SwitchB(config)# interface range GigabitEthernet 1/1-2 SwitchB(config-if-range)# no switchport SwitchB(config-if-range)# port-group 3 mode active SwitchB(config-if-range)# exit SwitchB(config)# interface aggregateport 3 SwitchB(config-if-Aggregateport 3)# ip address 1.0.0.2 SwitchB(config-if-Aggregateport 3)# aggregate bfd-detect ipv4 1.0.0.2 1.0.0.1 SwitchB(config-if-Aggregateport 3)# bfd interval 50 min_rx 50 multiplier 3</pre>
Verification	<ul style="list-style-type: none"> ● Run show run to check whether the configuration takes effect. ● Run show interface aggregateport to display the BFD state of the AP member ports.
Switch A	<pre>SwitchA# show run include AggregatePort 3 Building configuration... Current configuration: 54 bytes interface AggregatePort 3 no switchport ip address 1.0.0.1 aggregate bfd-detect ipv4 1.0.0.1 1.0.0.2 bfd interval 50 min_rx 50 multiplier 3 SwitchA# show interface aggregateport 3 ... Aggregate Port Informations: Aggregate Number: 3 Name: "AggregatePort 3" Members: (count=2) GigabitEthernet 1/1 Link Status: Up LACP Status: bndl BFD Status: UP GigabitEthernet 1/2 Link Status: Up LACP Status: bndl BFD Status: UP ...</pre>
Switch B	<pre>SwitchB# show run include AggregatePort 3</pre>

```

Building configuration...
Current configuration: 54 bytes
interface AggregatePort 3
  no switchport
  ip address 1.0.0.2
  aggregate bfd-detect ipv4 1.0.0.2 1.0.0.1
  bfd interval 50 min_rx 50 multiplier 3
SwitchB# show interface aggregateport 3
...
Aggregate Port Informations:
  Aggregate Number: 3
  Name: "AggregatePort 3"
  Members: (count=2)
  GigabitEthernet 1/1      Link Status: Up    LACP Status: bndl  BFD Status: UP
  GigabitEthernet 1/2      Link Status: Up    LACP Status: bndl  BFD Status: UP
  ...
    
```

Common Errors

1. If BFD is enabled for an AP port without BFD parameters, BFD does not take effect.
2. After BFD is enabled for an AP port, the BFD neighbor must be a directly connected AP port enabled with BFD.

25.5.7 Configuring a Preferred AP Member Port

Configuration Effect

- Configure a member port as the preferred AP member port.
- After the preferred member port is configured, the management VLAN packets on the AP port are forwarded by this port.

Notes

- For details about management VLAN configuration, see *Configuring MAC*.
- Only one preferred member port can be configured for one AP port.
- After an LACP AP member port is configured as the preferred AP member port, if the LACP negotiation on all AP member ports fails, the preferred port is automatically downgraded to a static AP member port.

Configuration Steps

▾ Configuring a Preferred AP Member Port

- (Optional) Perform this configuration to specify an AP member port dedicated to forwarding management VLAN packets.
- The configuration is applicable to dual-system servers. Configure the port connected to the management NIC of the server as the preferred AP member port.

Command	aggregateport primary-port
Parameter	N/A
Description	
Defaults	By default, No AP member port is a preferred port.
Command Mode	Interface configuration mode of an AP member port
Usage Guide	N/A

Verification

- Run **show running** to display the configuration.
- Run **show interface aggregateport** to display the preferred AP member port.

Command	show interface aggregateport ap-num
Parameter Description	<i>ap-num</i> : Indicates the number of an AP port.
Command Mode	Any mode
Usage Guide	N/A
	<pre> FS# show interface aggregateport 11 ... Aggregate Port Informations: Aggregate Number: 11 Name: "AggregatePort 11" Members: (count=2) Primary Port: GigabitEthernet 0/1 GigabitEthernet 0/1 Link Status: Up LACP Status: bndl GigabitEthernet 0/2 Link Status: Up LACP Status: bndl ... </pre>

Configuration Example

▾ **Configuring a Preferred AP Member Port**

Scenario Figure 4-8	
Configuration	<ul style="list-style-type: none"> ● Enable LACP for the GigabitEthernet 1/1 and GigabitEthernet 1/2 ports on Switch A and add the ports to

<p>Steps</p>	<p>LACP AP port 3.</p> <ul style="list-style-type: none"> ● Configure the GigabitEthernet 1/1 port on Switch A as a preferred port. ● Configure VLAN 10 on Switch A as the management VLAN.
<p>Switch A</p>	<pre>SwitchA# configure terminal SwitchA(config)# interface range GigabitEthernet 1/1-2 SwitchA(config-if-range)# port-group 3 mode active SwitchA(config-if-range)# exit SwitchA(config)# interface gigabitEthernet 1/1 SwitchA(config-if-GigabitEthernet 1/1) aggregateport primary-port SwitchA(config-if-GigabitEthernet 1/1)# exit SwitchA(config)# aggregateport-admin vlan 10 SwitchA(config)# interface aggregateport 3 SwitchA(config-if-Aggregateport 3)# switchport mode trunk SwitchA(config-if-Aggregateport 3)#</pre>
<p>Verification</p>	<ul style="list-style-type: none"> ● Run show run to check whether the configuration takes effect. ● Run show interface aggregateport to display the preferred AP member port.
<p>Switch A</p>	<pre>SwitchA# show run include GigabitEthernet 1/1 Building configuration... Current configuration: 54 bytes interface GigabitEthernet 1/1 aggregateport primary-port portgroup 3 mode active SwitchA# show interface aggregateport 3 ... Aggregate Port Informations: Aggregate Number: 3 Name: "AggregatePort 3" Members: (count=2) Primary Port: GigabitEthernet 1/1 GigabitEthernet 1/1 Link Status: Up LACP Status: bndl GigabitEthernet 1/2 Link Status: Up LACP Status: bndl ...</pre>

25.5.8 Configuring the Minimum Number of LACP AP Member Ports

Configuration Effect

- After the minimum number of AP member ports is configured, the aggregation group takes effect only when the number of member ports is greater than the minimum number.

Notes

- If the number of LACP AP member ports for an LACP aggregation group is less than the minimum number of AP member ports configured, all AP member ports are in the unbinding state.
- After the minimum number of static AP member ports is configured, if the number of static AP member ports in the Up state is less than the minimum number, the static AP member ports in the Up state cannot forward data and the corresponding AP is down. However, the state of the peer is not affected. Therefore, corresponding functions must be configured on the peer.

Configuration Steps

▾ Configuring the Minimum Number of AP Member Ports

- (Optional) Perform this configuration to specify the minimum number of AP member ports.

Command	aggregateport member minimum <i>number</i>
Parameter Description	<i>number</i> : Indicates the minimum number of member ports.
Defaults	By default, the minimum number of member ports is 1.
Command Mode	Interface configuration mode of the specified AP port
Usage Guide	N/A

▾ Configuring the Minimum Number of AP Member Ports (Action)

- (Optional) Perform this configuration when the number of AP member ports in the Up state is less than the minimum number of the AP member ports.

Command	aggregateport member minimum action [shutdown]
Parameter Description	<i>Shutdown</i> : shuts down the aggregated port when the number of AP member ports in the Up state is less than the minimum number of the AP member ports.
Defaults	By default, no action is triggered.
Command Mode	Interface configuration mode of the specified AP port
Usage Guide	N/A

Verification

- Run **show running** to display the configuration.
- Run **show interface aggregateport** to display the state of the AP member ports.

Command	show interface aggregateport <i>ap-num</i>
Parameter Description	<i>ap-num</i> : Indicates the number of an AP port.
Command	Any mode

Mode	
Usage Guide	N/A
	<pre> FS# show interface aggregateport 3 ... Aggregate Port Informations: Aggregate Number: 3 Name: "AggregatePort 3" Members: (count=2) GigabitEthernet 0/1 Link Status: Up LACP Status: bndl GigabitEthernet 0/2 Link Status: Up LACP Status: bndl ... </pre>

Configuration Example

Configuring the Minimum Number of LACP AP Member Ports, with the Number of LACP AP Member Ports Less Than the Minimum Number of LACP AP Member Ports

<p>Scenario</p> <p>Figure 4-9</p>	
<p>Configuration Steps</p>	<ul style="list-style-type: none"> ● Enable LACP for the GigabitEthernet 1/1 and GigabitEthernet 1/2 ports on Switch A and add the ports to LACP AP port 3. ● Enable LACP for the GigabitEthernet 2/1 and GigabitEthernet 2/2 ports on Switch B and add the ports to LACP AP port 3. ● On Switch A, set the minimum number of the member ports of AP port 3 to 3.
<p>Switch A</p>	<pre> SwitchA# configure terminal SwitchA(config)# interface range GigabitEthernet 1/1-2 SwitchA(config-if-range)# no switchport SwitchA(config-if-range)# port-group 3 mode active SwitchA(config-if-range)# exit SwitchA(config)# interface aggregateport 3 SwitchA(config-if-Aggregateport 3)# aggregateport minimum member 3 </pre>

<p>Switch B</p>	<pre>SwitchB# configure terminal SwitchB(config)# interface range GigabitEthernet 2/1-2 SwitchB(config-if-range)# no switchport SwitchB(config-if-range)# port-group 3 mode active SwitchB(config-if-range)# exit SwitchB(config)# interface aggregateport 3 SwitchB(config-if-Aggregateport 3)# aggregateport minimum member 3</pre>
<p>Verification</p>	<ul style="list-style-type: none"> ● Run show run to check whether the configuration takes effect. ● Run show lacp summery to display the aggregation state of each AP member port.
<p>Switch A</p>	<pre>SwitchA# show LACP summary 3 System Id:32768, 00d0.f8fb.0001 Flags: S - Device is requesting Slow LACPDUs F - Device is requesting Fast LACPDUs. A - Device is in active mode. P - Device is in passive mode. Aggregate port 3: Local information: LACP port Oper Port Port Port Flags State Priority Key Number State ----- Gi1/1 SA bndl 32768 0x3 0x1 0x3d Gi1/2 SA bndl 32768 0x3 0x2 0x3d Partner information: LACP port Oper Port Port Port Flags Priority Dev ID Key Number State ----- Gi1/1 SA 32768 00d0.f800.0002 0x3 0x1 0x3d Gi1/2 SA 32768 00d0.f800.0002 0x3 0x2 0x3d</pre>

➤ Configuring the Minimum Number of LACP AP Member Ports, with the Number of LACP AP Member Ports Not Less Than the Minimum Number of LACP AP Member Ports

<p>Scenario</p> <p>Figure 4-10</p>	
<p>Configuration Steps</p>	<ul style="list-style-type: none"> ● Enable LACP for the GigabitEthernet 1/1, GigabitEthernet 1/2 and GigabitEthernet 1/3 ports on Switch A and add the ports to LACP AP port 3. ● Enable LACP for the GigabitEthernet 2/1, GigabitEthernet2/2 and GigabitEthernet 2/3 ports on Switch B and add the ports to LACP AP port 3. ● Set the minimum number of member ports of LACP AP port 3 to 2.
<p>Switch A</p>	<pre>SwitchA# configure terminal SwitchA(config)# interface range GigabitEthernet 1/1-3 SwitchA(config-if-range)# no switchport SwitchA(config-if-range)# port-group 3 mode active SwitchA(config-if-range)# exit SwitchA(config)# interface aggregateport 3 SwitchA(config-if-Aggregateport 3)# aggregateport member minimum 2</pre>
<p>Switch B</p>	<pre>SwitchB# configure terminal SwitchB(config)# interface range GigabitEthernet 2/1-3 SwitchB(config-if-range)# no switchport SwitchB(config-if-range)# port-group 3 mode active SwitchB(config-if-range)# exit SwitchB(config)# interface aggregateport 3 SwitchB(config-if-Aggregateport 3)# aggregateport member minimum 2</pre>
<p>Verification</p>	<ul style="list-style-type: none"> ● Run show run to check whether the configuration is correct. ● Run show lacp summary to query the status of each member port of the AP port.
<p>Switch A</p>	<pre>SwitchA# show LACP summary 3 System Id:32768, 00d0.f8fb.0001 Flags: S - Device is requesting Slow LACPDUs F - Device is requesting Fast LACPDUs. A - Device is in active mode. P - Device is in passive mode. Aggregate port 3: Local information:</pre>

LACP port		Oper	Port	Port			
Port	Flags	State	Priority	Key	Number	State	
Gi1/1	SA	bndl	32768	0x3	0x1	0x3d	
Gi1/2	SA	bndl	32768	0x3	0x2	0x3d	
Gi1/3	SA	bndl	32768	0x3	0x3	0x3d	
Partner information:							
		LACP port	Oper	Port	Port		
Port	Flags	Priority	Dev ID	Key	Number	State	
Gi1/1	SA	32768	00d0.f800.0002	0x3	0x1	0x3d	
Gi1/2	SA	32768	00d0.f800.0002	0x3	0x2	0x3d	
Gi1/3	SA	32768	00d0.f800.0002	0x3	0x3	0x3d	

Common Errors

The number of LACP AP member ports of an LACP aggregation group is less than the minimum number of AP member ports configured, the LACP aggregation group is not in the binding state.

25.5.9Enabling the LACP Independent Port Function

Configuration Effect

- After the independent LACP port function is enabled, an LACP member port automatically changes to a common physical port if the LACP member port does not receive LACP packets within the set time-out period. The LACP member port state is changed to **individual** and the LACP member port can forward packets properly.
- After the LACP member port receives LACP packets, it changes to an LACP independent port again to perform LACP packet negotiation.
- The time-out period of an independent port can be adjusted by configuration.

Notes

- After the LACP independent port function is enabled, an LACP member port will not change to a common physical port immediately. An LACP member port changes to an independent port (a common physical port) only if it does not receive LACP packets within the set time-out period,
- The time-out period configuration of LACP independent port only affects LACP member ports that have not turned into independent ports. After the time-out period is configured, the period calculation will restart.
- In the long time-out mode, the LACP packet is sent every 30s. The time-out period should be longer than 30s so as not to affect the normal LACP negotiation. It is recommended to configure the time-out period at least twice the period of LACP packet sending. In the short time-out period, there is no limit.

Configuration Steps

▾ **Enabling the LACP Independent Port Function**

- Optional
- Perform this operation so that an member port of LACP aggregate group can forward packets normally when the LACP member port cannot perform LACP negotiation.

Command	lacp individual-port enable
Parameter	N/A
Description	
Defaults	By default, the LACP independent port function is disabled.
Command Mode	Interface configuration mode
Usage Guide	N/A

▾ **Configuring the Time-out Period of LACP Independent Port**

- Optional
- Perform this operation when an LACP independent port needs to adjust the time-out period.

Command **lacp individual-timeout period** *time*
Parameter *Time*: Time-out period. The range is 10-90, and the unit is second.
Description
Defaults The time-out period of LACP independent port is 90s by default.
Command Mode Global configuration mode

Verification

- Run **show running** to query the corresponding configuration.
- Run **show interface aggregateport** to query the AP member port status.

Command	show interface aggregateport <i>ap-num</i>
Parameter	ap-num : Indicates the AP number.
Description	
Command Mode	All modes
Usage Guide	N/A
Command Presentation	<pre> FS# show interface aggregateport 3 ... Aggregate Port Informations: Aggregate Number: 3 Name: "AggregatePort 3" Members: (count=2) GigabitEthernet 0/1 Link Status: Up Lacp Status: individual </pre>

	GigabitEthernet 0/2 Link Status: Up Lacp Status: individual ...
--	---

Configuration Example

▾ **Enabling the LACP Independent Port Function**

<p>Scenario</p> <p>Figure 4-11</p>	<p>The diagram illustrates a network setup for LACP independent port function. On the left, a server with two Network Interface Cards (NICs) is shown. These are connected to the Gigabit Ethernet 1/1 and Gigabit Ethernet 1/2 ports of an access device (switch). The switch is connected to a central network cloud, which in turn connects to a remote OS installation device.</p>
<p>Description</p>	<p>As shown in Figure 4-11, the server uses NIC 1 and NIC 2 as the communication ports to access to the GigabitEthernet1/1 and GigabitEthernet1/2 ports of the access device. The GigabitEthernet1/1 and GigabitEthernet1/2 ports are added to the LACP aggregation group, for example, AP port 3. A specific VLAN, for example, VLAN 10 is allocated. The LACP independent port function is enabled for the GigabitEthernet1/1 and GigabitEthernet1/2 ports. When the OS is not installed on the server, LACP negotiation between the server and the access device fails. In this case, the GigabitEthernet1/1 and GigabitEthernet1/2 ports of the access device change to common physical ports and are allocated to VLAN 10 automatically. The server uses NIC 1 or NIC 2 to communicate with the remote OS installation device. After the OS is installed, the server connects to the access device in LACP mode.</p>
<p>Configuration Steps</p>	<ul style="list-style-type: none"> ● Enable LACP for the GigabitEthernet 1/1 and GigabitEthernet 1/2 ports on the access device and add the ports to LACP AP port 3. ● Enable the LACP independent port function for the GigabitEthernet 1/1 and GigabitEthernet 1/2 ports on the access device. ● Allocate AP port 3 on the access device to VLAN 10.
<p>Switch A</p>	<pre> SwitchA# configure terminal SwitchA(config)# interface range GigabitEthernet 1/1-2 SwitchA(config-if-range)# port-group 3 mode active SwitchA(config-if-range)# lacp individual-port enable SwitchA(config-if-range)# exit SwitchA(config)# interface aggregateport 3 SwitchA(config-if-Aggregateport 3)#switch access vlan 10 SwitchA(config-if-Aggregateport 3)# </pre>
<p>Verification</p>	<ul style="list-style-type: none"> ● Run show run to check whether the configuration is correct. ● Run show lacp summery to query the status of each member port of the AP port.

```

Switch A
SwitchA# show LACP summary 3

System Id:32768, 00d0.f8fb.0001

Flags: S - Device is requesting Slow LACPDUs

F - Device is requesting Fast LACPDUs.

A - Device is in active mode.      P - Device is in passive mode.

Aggregate port 3:

Local information:

LACP port      Oper   Port      Port
Port  Flags   State   Priority   Key    Number   State
-----
Gi1/1  SA     individual  32768     0x3    0x1     0x3d
Gi1/2  SA     individual  32768     0x3    0x2     0x3d

Partner information:

                LACP port      Oper   Port      Port
Port  Flags   Priority   Dev ID   Key    Number   State
-----
Gi1/1  SA     32768     00d0.f800.0002  0x3    0x1     0x3d
Gi1/2  SA     32768     00d0.f800.0002  0x3    0x2     0x3d
    
```

25.6 Monitoring

Clearing

Description	Command
Clears the statistics of LACP packets on a LACP member port.	clear lacp counters [<i>key-number</i> <i>interface-type interface-number</i>]

Displaying

Description	Command
Displays the configuration of an enhanced load balancing profile.	show load-balance-profile [<i>profile-name</i>]
Displays the LACP aggregation state. You can display the information on a specified LACP AP port by specifying <i>key-number</i> .	show lacp summary [<i>key-numebr</i>]
Displays the statistics of LACP packets on LACP member ports. You can display the information on a specified LACP AP port by specifying <i>key-number</i> .	show lacp counters [<i>key-numebr</i>]
Displays the summary or load balancing	show aggregateport [<i>ap-number</i>] { load-balance summary }

Description	Command
algorithm of an AP port.	
Displays the capacity mode and usage of an AP port.	show aggregateport capacity

Debugging

System resources are occupied when debugging information is output. Therefore, disable debugging immediately after use.

Description	Command
Debugs an AP port.	debug lsm ap
Debugs LACP.	debug lacp { packet event database ha realtime stm timer all }

26 Configuring VLAN

26.1 Overview

A Virtual Local Area Network (VLAN) is a logical network created based on a physical network. A VLAN can be categorized into Layer-2 networks of the OSI model.

A VLAN has the same properties as a common LAN, except for physical location limitation. Unicast, broadcast and multicast frames of Layer 2 are forwarded and transmitted within a VLAN, keeping traffic segregated.

We may define a port as a member of a VLAN, and all terminals connected to this port are parts of a virtual network that supports multiple VLANs. You do not need to adjust the network physically when adding, removing and modifying users. Communication among VLANs is realized through Layer-3 devices, as shown in the following figure.

Figure 5- 1

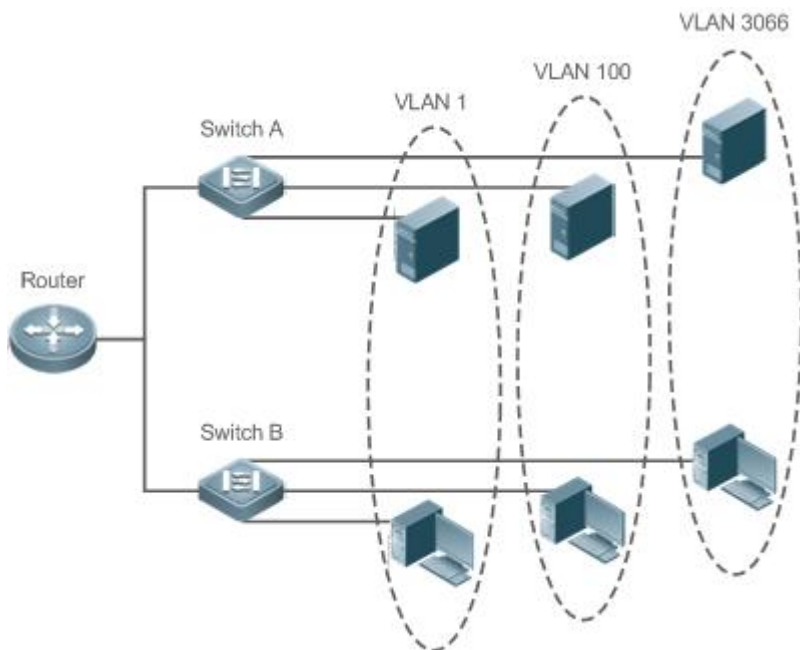

Protocols and Standards

- IEEE 802.1Q

26.2 Applications

Application	Description
Isolating VLANs at Layer 2 and Interconnecting VLANs at Layer 3	An intranet is divided into multiple VLANs, realizing Layer-2 isolation and Layer-3 interconnection with each other through IP forwarding by core switches.

26.2.1 Isolating VLANs at Layer 2 and Interconnecting VLANs at Layer 3

Scenario

An intranet is divided into VLAN 10, VLAN 20 and VLAN 30, realizing Layer-2 isolation from each other. The three VLANs correspond respectively to the IP sub-networks 192.168.10.0/24, 192.168.20.0/24, and 192.168.30.0/24, realizing interconnection with each other through IP forwarding by Layer-3 core switches.

Figure 5- 2

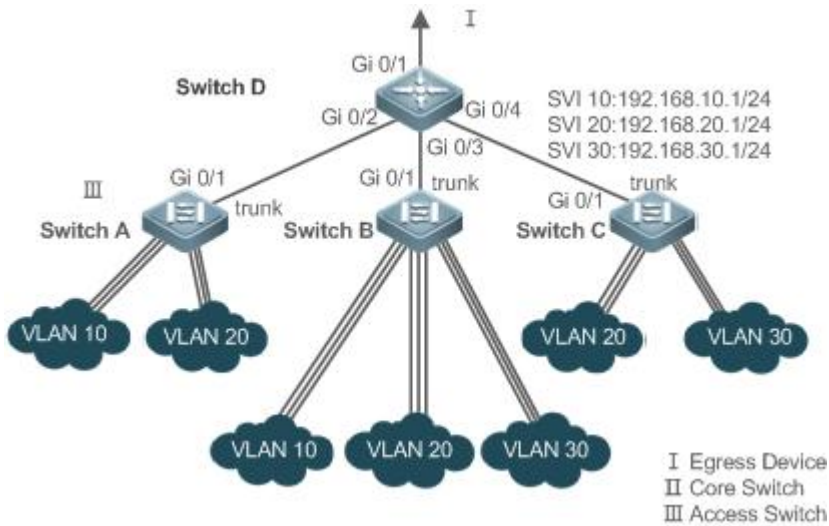

Remarks:	<p>Switch A, Switch B and Switch C are access switches.</p> <p>Configure three VLANs on a core switch and the port connected to the access switches as a Trunk port, and specify a list of allowed-VLANs to realize Layer-2 isolation;</p> <p>Configure three SVIs on the core switch, which are the gateway interfaces of the IP sub-networks corresponding to the three VLANs, and configure the IP addresses for these interfaces.</p> <p>Create VLANs respectively on the three access switches, assign Access ports for the VLANs, and specify Trunk ports of the core switch.</p>
-----------------	---

Deployment

- Divide an intranet into multiple VLANs to realize Layer-2 isolation among them.
- Configure SVIs on a Layer-3 switch to realize Layer-3 communication among VLANs.

26.3 Features

Basic Concepts

➤ VLAN

A VLAN is a logical network created based on a physical network. A VLAN has the same properties as a common LAN, except for physical location limitation. Unicast, broadcast and multicast frames of Layer 2 are forwarded and transmitted within a VLAN, keeping traffic segregated.

- i The VLANs supported by FS products comply with the IEEE802.1Q standard. A maximum of 4094 VLANs (VLAN ID 1-4094) are supported, among which VLAN 1 cannot be deleted.
- i The configurable VLAN IDs are from 1 to 4094.
- i In case of insufficient hardware resources, the system returns information on VLAN creation failure.

Port Mode

You can determine the frames allowed to pass a port and the VLANs which the port belongs to by configuring the port mode. See the following table for details.

Port Mode	Description
Access port	An Access port belongs to only one VLAN, which is specified manually.
Trunk port (802.1Q)	A Trunk port belongs to all the VLANs of an access switch by default, and it can forward the frames of all the VLANs or the frames of allowed-VLANs.
Uplink port	An Uplink port belongs to all the VLANs of an access switch by default, and it can forward the frames of all the VLANs and tag the native VLAN egress traffic.
Hybrid port	A Hybrid port belongs to all the VLANs of an access switch by default, and it can forward the frames of all the VLANs and send frames of VLANs untagged. It can also transmit frames of allowed-VLANs.
Servicechain Port	A service chain port does not learn MAC addresses and can forward packets from any VLAN by default. In addition, no other configuration is allowed.
Ptrunk Port	A ptrunk port is the same as a trunk port except that it only joins VLAN 1 by default. You can run the switchport trunk allowed command to add the port to or remove it from a specific VLAN.

Overview

Feature	Description
<u>VLAN</u>	VLAN helps realize Layer-2 isolation.

26.3.1VLAN

Every VLAN has an independent broadcast domain, and different VLANs are isolated on Layer 2.













Working Principle

Every VLAN has an independent broadcast domain, and different VLANs are isolated on Layer 2.

Layer-2 isolation: If no SVIs are configured for VLANs, VLANs are isolated on Layer 2. This means users in these VLANs cannot communicate with each other.

Layer-3 interconnection: If SVIs are configured on a Layer-3 switch for VLANs, these VLANs can communicate with each other on Layer 3.

26.4 Configuration

Configuration	Description and Command
<u>Configuring Basic VLAN</u>	 (Mandatory) It is used to create a VLAN.
	vlan Enters a VLAN ID.
	 (Optional) It is used to configure an Access port to transmit the flows from a single VLAN.
	switchport mode access Defines a port as a Layer-2 Access port.
	switchport access vlan Assigns a port to a VLAN.
	add interface Adds one Access port or a group of such ports to the current VLAN.
	 (Optional) It is used to rename a VLAN.
	name Names a VLAN.
<u>Configuring a Trunk Port</u>	 (Mandatory) It is used to configure the port as a Trunk port.
	switchport mode trunk Defines a port as a Layer-2 Trunk port.
	 (Optional) It is used to configure Trunk ports to transmit flows from multiple VLANs.
	switchport trunk allowed vlan Configures allowed-VLANs for a Trunk port.
	switchport trunk native vlan Specifies a native VLAN for a Trunk port.
<u>Configuring an Uplink Port</u>	 (Mandatory) It is used to configure the port as an Uplink port.
	switchport mode uplink Configures a port as an Uplink port.
	 (Optional) It is used to restore the port mode.
	no switchport mode Restores the port mode.
<u>Configuring a Hybrid Port</u>	 (Mandatory) It is used to configure a port as a Hybrid port.
	switchport mode hybrid Configures a port as a Hybrid port.
	 (Optional) It is used to transmit the frames of multiple VLANs untagged.
	no switchport mode Restores the port mode.
	switchport hybrid allowed vlan Configures allowed-VLANs for a Hybrid port.
	switchport hybrid native vlan Configures a default VLAN for a Hybrid port.
<u>Configuring a Service Chain Port</u>	 (Mandatory) It is used to configure a port as a service chain port.
	switchport mode servicechain Configures a port as a service chain port.
<u>Configuring a Ptrunk Port</u>	 (Mandatory) It is used to configure a port as a ptrunk port.
	switchport mode ptrunk Configures a port as a ptrunk port.
	 (Optional) It is used to restore the port mode.
	no switchport mode Restores the port mode.
Configuring an Inherited VLAN for an Independent Port	 (Mandatory) After a port is configured as an AP, if its member port is changed to independent port, then the independent port uses the inherited VLAN configured on the AP as its allowed VLAN list. If AP does not configure the inherited VLAN for the independent port, the member port inherits the allowed VLAN list of AP as its allowed VLAN list.
	switchport mode servicechain Configures a port as a service chain port.

26.4.1 Configuring Basic VLAN

Configuration Effect

- A VLAN is identified by a VLAN ID. You may add, delete, modify VLANs 2 to 4094, but VLAN 1 is created automatically and cannot be deleted. You may configure the port mode, and add or remove a VLAN.

Notes

- N/A

Configuration Steps

📌 **Creating and Modifying a VLAN**

- Mandatory.
- In case of insufficient hardware resources, the system returns information on VLAN creation failure.
- Use the **vlan *vlan-id*** command to create a VLAN or enter VLAN mode.
- Configuration:

Command	vlan <i>vlan-id</i>
Parameter Description	<i>vlan-id</i> : indicates VLAN ID ranging from 1 to 4094.
Defaults	VLAN 1 is created automatically and is not deletable.
Command Mode	Global configuration mode
Usage Guide	If you enter a new VLAN ID, the corresponding VLAN will be created. If you enter an existing VLAN ID, the corresponding VLAN will be modified. You may use the no vlan <i>vlan-id</i> command to delete a VLAN. The undeletable VLANs include VLAN1, the VLANs configured with SVIs, and SubVLANs.

📌 **Renaming a VLAN**

- Optional.
- You cannot rename a VLAN the same as the default name of another VLAN.
- Configuration:

Command	name <i>vlan-name</i>
Parameter Description	<i>vlan-name</i> : indicates a VLAN name.
Defaults	By default, the name of a VLAN is its VLAN ID. For example, the default name of the VLAN 4 is VLAN 0004.
Command Mode	VLAN configuration mode
Usage Guide	To restore the VLAN name to defaults, use the no name command.

📌 **Assigning Current Access port to a Specified VLAN**

- Optional.
- Use the **switchport mode access** command to specify Layer-2 ports (switch ports) as Access ports.
- Use the **switchport access vlan *vlan-id*** command to add an Access port to a specific VLAN so that the flows from the VLAN can be transmitted through the port.

Command	switchport mode access
Parameter	N/A
Description	
Defaults	A switch port is an Access port by default.
Command Mode	Interface configuration mode
Usage Guide	N/A

Command	switchport access vlan <i>vlan-id</i>
Parameter Description	<i>vlan-id</i> : indicates a VLAN ID.
Defaults	An Access port is added to VLAN 1 by default.
Command Mode	Interface configuration mode
Usage Guide	If a port is assigned to a non-existent VLAN, the VLAN will be created automatically.

⚡ **Adding an Access Port to Current VLAN**

- Optional.
- This command takes effect only on an Access port. After an Access port is added to a VLAN, the flows of the VLAN can be transmitted through the port.
- Configuration:

Command	add interface { <i>interface-id</i> range <i>interface-range</i> }
Parameter Description	<i>interface-id</i> : indicates a single port. <i>interface-id</i> : indicates multiple ports.
Defaults	By default, all Layer-2 Ethernet ports belong to VLAN 1.
Command Mode	VLAN configuration mode
Usage Guide	In VLAN configuration mode, add a specific Access port to a VLAN. This command takes the same effect as command switchport access vlan <i>vlan-id</i> .

i For the two commands of adding a port to a VLAN, the command configured later will overwrite the other one.

Verification

- Send untagged packets to an Access port, and they are broadcast within the VLAN.
- Use commands **show vlan** and **show interface switchport** to check whether the configuration takes effect.

Command	show vlan [id <i>vlan-id</i>]
Parameter Description	<i>vlan-id</i> : indicates a VLAN ID.
Command Mode	Any mode
Usage Guide	N/A
Command Display	FS(config-vlan)#show vlan id 20

VLAN Name	Status	Ports

20 VLAN0020	STATIC	Gi0/1

Configuration Example

Configuring Basic VLAN and Access Port

Configuration Steps	<ul style="list-style-type: none"> ● Create a VLAN and rename it. ● Add an Access port to the VLAN. There are two approaches. One is: 																																	
	<pre>FS# configure terminal FS(config)# vlan 888 FS(config-vlan)# name test888 FS# (config-vlan)# exit FS(config)# interface GigabitEthernet 0/3 FS(config-if-GigabitEthernet 0/3)# switchport mode access FS(config-if-GigabitEthernet 0/3)# switchport access vlan 20</pre> <p>The other approach is adding an Access port (GigabitEthernet 0/3) to VLAN20:</p> <pre>FS# configure terminal SwitchA(config)#vlan 20 SwitchA(config-vlan)#add interface GigabitEthernet 0/3</pre>																																	
Verification	Check whether the configuration is correct.																																	
	<pre>FS(config-vlan)#show vlan</pre> <table border="1"> <thead> <tr> <th>VLAN Name</th> <th>Status</th> <th>Ports</th> </tr> </thead> <tbody> <tr> <td colspan="3">-----</td> </tr> <tr> <td>1 VLAN0001</td> <td>STATIC</td> <td></td> </tr> <tr> <td>20 VLAN0020</td> <td>STATIC</td> <td>Gi0/3</td> </tr> <tr> <td>888 test888</td> <td>STATIC</td> <td></td> </tr> </tbody> </table> <pre>FS(config-vlan)# FS# show interface GigabitEthernet 0/3 switchport</pre> <table border="1"> <thead> <tr> <th>Interface</th> <th>Switchport Mode</th> <th>Access</th> <th>Native</th> <th>Protected</th> <th>VLAN lists</th> </tr> </thead> <tbody> <tr> <td colspan="6">-----</td> </tr> <tr> <td>GigabitEthernet 0/3</td> <td>enabled</td> <td>ACCESS</td> <td>20</td> <td>1</td> <td>Disabled ALL</td> </tr> </tbody> </table> <pre>FS# show run !</pre>	VLAN Name	Status	Ports	-----			1 VLAN0001	STATIC		20 VLAN0020	STATIC	Gi0/3	888 test888	STATIC		Interface	Switchport Mode	Access	Native	Protected	VLAN lists	-----						GigabitEthernet 0/3	enabled	ACCESS	20	1	Disabled ALL
VLAN Name	Status	Ports																																

1 VLAN0001	STATIC																																	
20 VLAN0020	STATIC	Gi0/3																																
888 test888	STATIC																																	
Interface	Switchport Mode	Access	Native	Protected	VLAN lists																													

GigabitEthernet 0/3	enabled	ACCESS	20	1	Disabled ALL																													

26.4.2 Configuring a Trunk Port

Configuration Effect

A Trunk is a point-to-point link connecting one Ethernet interface or multiple ones to other network devices (for example, a router or switch) and it may transmit the flows from multiple VLANs.

The Trunk of Ruijie devices adopts the 802.1Q encapsulation standard. The following figure displays a network adopting a Trunk connection.

Figure 5- 3

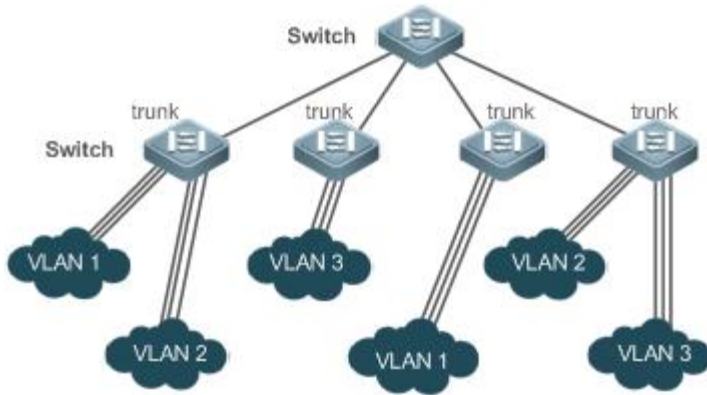

You may configure an Ethernet port or Aggregate Port (See *Configuring Aggregate Port* for details) as a Trunk port.

You should specify a native VLAN for a Trunk port. The untagged packets received by and sent from the Trunk port are considered to belong to the native VLAN. The default VLAN ID (PVID in the IEEE 802.1Q) of this Trunk port is the native VLAN ID. Meanwhile, frames of the native VLAN sent via the Trunk are untagged. The default native VLAN of a Trunk port is VLAN 1.

When configuring a Trunk link, make sure the Trunk ports at the two ends of the link adopt the same native VLAN.

Configuration Steps

Configuring a Trunk Port

- Mandatory.
- Configure a Trunk port to transmit the flows from multiple VLANs.
- Configuration:

Command	switchport mode trunk
Parameter	N/A
Description	
Defaults	The default mode is Access, which can be modified to Trunk.
Command Mode	Interface configuration mode
Usage Guide	To restore all properties of a Trunk port to defaults, use the no switchport mode command.

Defining Allowed-VLANs for a Trunk Port

- Optional.

- By default, a trunk port transmits the flows from all the VLANs (1 to 4094). You may configure a list of allowed-VLANs to prohibit flows of some VLANs from passing through a Trunk port.
- Configuration:

Command	switchport trunk allowed vlan { all [add remove except only]} <i>vlan-list</i>
Parameter Description	The parameter <i>vlan-list</i> can be a VLAN or some VLANs, and the VLAN IDs are connected by "-" in order. For example: 10-20. all indicates allowed-VLANs include all VLANs; add indicates adding a specific VLAN to the list of allowed-VLANs; remove indicates removing a specific VLAN from the list of allowed-VLANs; except indicates adding all VLANs except those in the listed VLAN to the list of allowed-VLANs. only indicates adding the listed VLANs to the list of allowed-VLANs, and removing the other VLANs from the list.
Defaults	The Trunk port and the Uplink port belong to all VLANs.
Command Mode	Interface configuration mode
Usage Guide	To restore the configuration on a Trunk port to defaults (all), use the no switchport trunk allowed vlan command.

📌 Configuring a Native VLAN

- Optional.
- A Trunk port receives and sends tagged or untagged 802.1Q frames. Untagged frames transmit the flows from the native VLAN. The default native VLAN is VLAN 1.
- If a frame carries the VLAN ID of a native VLAN, its tag will be stripped automatically when it passes a Trunk port.
- Configuration:

Command	switchport trunk native vlan <i>vlan-id</i>
Parameter Description	<i>vlan-id</i> : indicates a VLAN ID.
Defaults	The default VALN for a Trunk/Uplink port is VLAN 1.
Command Mode	Interface configuration mode
Usage Guide	To restore the native VLAN of a Trunk port back to defaults, use the no switchport trunk native vlan command.

i When you set the native VLAN of a port to a non-existent VLAN, this VLAN will not be created automatically. Besides, the native VLAN can be out of the list of allowed-VLANs for this port. In this case, the flows from the native VLAN cannot pass through the port.

Verification

- Send tag packets to a Trunk port, and they are broadcast within the specified VLANs.
- Use commands **show vlan** and **show interface switchport** to check whether the configuration takes effect.

Command	show vlan [id <i>vlan-id</i>]
Parameter Description	<i>vlan-id</i> : indicates a VLAN ID.
Command Mode	Any mode

Usage Guide	N/A
Command	FS(config-vlan)#show vlan id 20
Display	<pre> VLAN Name Status Ports ----- 20 VLAN0020 STATIC Gi0/1 </pre>

Configuration Example

Configuring Basic VLAN to Realize Layer-2 Isolation and Layer-3 Interconnection

<p>Scenario Figure 5- 4</p>	
<p>Configuration Steps</p>	<p>Networking Requirements:</p> <p>As shown in the figure above, an intranet is divided into VLAN 10, VLAN 20 and VLAN 30, realizing Layer-2 isolation from each other. The three VLANs correspond respectively to the IP sub-networks 192.168.10.0/24, 192.168.20.0/24, and 192.168.30.0/24, realizing interconnection with each other through IP forwarding by Layer-3 core switches.</p> <p>Key Points:</p> <p>The following example describes the configuration steps on a core switch and an access switch.</p> <ul style="list-style-type: none"> ● Configure three VLANs on a core switch and the port connected to the access switches as a Trunk port, and specify a list of allowed-VLANs to realize Layer-2 isolation. ● Configure three SVIs on the core switch, which are the gateway interfaces of the IP sub-networks corresponding to the three VLANs, and configure the IP addresses for these interfaces. ● Create VLANs respectively on the three access switches, assign Access ports for the VLANs, and specify Trunk ports of the core switch. The following example describes the configuration steps on Switch A.
<p>D</p>	<pre> D#configure terminal D(config)#vlan 10 D(config-vlan)#vlan 20 D(config-vlan)#vlan 30 D(config-vlan)#exit D(config)#interface range GigabitEthernet 0/2-4 D(config-if-range)#switchport mode trunk </pre>

	<pre> D(config-if-range)#exit D(config)#interface GigabitEthernet 0/2 D(config-if-GigabitEthernet 0/2)#switchport trunk allowed vlan remove 1-4094 D(config-if-GigabitEthernet 0/2)#switchport trunk allowed vlan add 10,20 D(config-if-GigabitEthernet 0/2)#interface GigabitEthernet 0/3 D(config-if-GigabitEthernet 0/3)#switchport trunk allowed vlan remove 1-4094 D(config-if-GigabitEthernet 0/3)#switchport trunk allowed vlan add 10,20,30 D(config-if-GigabitEthernet 0/3)#interface GigabitEthernet 0/4 D(config-if-GigabitEthernet 0/4)#switchport trunk allowed vlan remove 1-4094 D(config-if-GigabitEthernet 0/4)#switchport trunk allowed vlan add 20,30 D#configure terminal D(config)#interface vlan 10 D(config-if-VLAN 10)#ip address 192.168.10.1 255.255.255.0 D(config-if-VLAN 10)#interface vlan 20 D(config-if-VLAN 20)#ip address 192.168.20.1 255.255.255.0 D(config-if-VLAN 20)#interface vlan 30 D(config-if-VLAN 30)#ip address 192.168.30.1 255.255.255.0 D(config-if-VLAN 30)#exit </pre>
<p>A</p>	<pre> A#configure terminal A(config)#vlan 10 A(config-vlan)#vlan 20 A(config-vlan)#exit A(config)#interface range GigabitEthernet 0/2-12 A(config-if-range)#switchport mode access A(config-if-range)#switchport access vlan 10 A(config-if-range)#interface range GigabitEthernet 0/13-24 A(config-if-range)#switchport mode access A(config-if-range)#switchport access vlan 20 A(config-if-range)#exit A(config)#interface GigabitEthernet 0/1 A(config-if-GigabitEthernet 0/1)#switchport mode trunk </pre>
<p>Verification</p>	<p>Display the VLAN configuration on the core switch.</p> <ul style="list-style-type: none"> ● Display VLAN information including VLAN IDs, VLAN names, status and involved ports. ● Display the status of ports Gi 0/2, Gi 0/3 and Gi 0/4.

```

D
D#show vlan
VLAN  Name          Status          Ports
-----
  1 VLAN0001  STATIC          Gi0/1, Gi0/5, Gi0/6, Gi0/7
                                     Gi0/8, Gi0/9, Gi0/10, Gi0/11
                                     Gi0/12, Gi0/13, Gi0/14, Gi0/15
                                     Gi0/16, Gi0/17, Gi0/18, Gi0/19
                                     Gi0/20, Gi0/21, Gi0/22, Gi0/23
                                     Gi0/24
 10 VLAN0010  STATIC          Gi0/2, Gi0/3
 20 VLAN0020  STATIC          Gi0/2, Gi0/3, Gi0/4
 30 VLAN0030  STATIC          Gi0/3, Gi0/4

D#show interface GigabitEthernet 0/2 switchport
Interface          Switchport Mode    Access Native Protected VLAN lists
-----
GigabitEthernet 0/2    enabled  TRUNK    1    1    Disabled  10,20

D#show interface GigabitEthernet 0/3 switchport
Interface          Switchport Mode    Access Native Protected VLAN lists
-----
GigabitEthernet 0/3    enabled  TRUNK    1    1    Disabled  10,20,30

D#show interface GigabitEthernet 0/4 switchport
Interface          Switchport Mode    Access Native Protected VLAN lists
-----
GigabitEthernet 0/4    enabled  TRUNK    1    1    Disabled  20,30
    
```

Common Errors

- N/A

26.4.3Configuring an Uplink Port

Configuration Effect

- An Uplink port is usually used in QinQ (the IEEE 802.1ad standard) environment, and is similar to a Trunk port. Their difference is that an Uplink port only transmits tagged frames while a Trunk port sends untagged frames of the native VLAN.

Configuration Steps

↘ Configuring an Uplink Port

- Mandatory.

- Configure an Uplink port to transmit the flows from multiple VLANS, but only tagged frames can be transmitted.
- Configuration:

Command	switchport mode uplink
Parameter	N/A
Description	
Defaults	The default mode is Access, which can be modified to Uplink.
Command Mode	Interface configuration mode
Usage Guide	To restore all properties of an Uplink port to defaults, use the no switchport mode command.

⤵ **Defining Allowed-VLANs for a Trunk Port**

- Optional.
- You may configure a list of allowed-VLANs to prohibit flows of some VLANs from passing through an Uplink port.
- Configuration:

Command	switchport trunk allowed vlan { all [add remove except only] } vlan-list
Parameter Description	The parameter <i>vlan-list</i> can be a VLAN or some VLANs, and the VLAN IDs are connected by "-" in order. For example: 10-20. all indicates allowed-VLANs include all VLANs; add indicates adding a specific VLAN to the list of allowed-VLANs; remove indicates removing a specific VLAN from the list of allowed-VLANs; except indicates adding all VLANs except those in the listed VLAN to the list of allowed-VLANs; and only indicates adding the listed VLANs to the list of allowed-VLANs, and removing the other VLANs from the list.
Command Mode	Interface configuration mode
Usage Guide	To restore the allowed-VLANs to defaults (all), use the no switchport trunk allowed vlan command.

⤵ **Configuring a Native VLAN**

- Optional.
- If a frame carries the VLAN ID of a native VLAN, its tag will not be stripped when it passes an Uplink port. This is contrary to a Trunk port.
- Configuration:

Command	switchport trunk native vlan <i>vlan-id</i>
Parameter Description	<i>vlan-id</i> : indicates a VLAN ID.
Command Mode	Interface configuration mode
Usage Guide	To restore the native VLAN of an Uplink to defaults, use the no switchport trunk native vlan command.

Verification

- Send tag packets to an Uplink port, and they are broadcast within the specified VLANs.

- Use commands **show vlan** and **show interface switchport** to check whether the configuration takes effect.

Command	show vlan [id vlan-id]									
Parameter	<i>vlan-id</i> : indicates a VLAN ID.									
Description										
Command Mode	Any mode									
Usage Guide	N/A									
Command Display	<pre>FS(config-vlan)#show vlan id 20</pre> <table border="1"> <thead> <tr> <th>VLAN Name</th> <th>Status</th> <th>Ports</th> </tr> </thead> <tbody> <tr> <td colspan="3">-----</td> </tr> <tr> <td>20 VLAN0020</td> <td>STATIC</td> <td>Gi0/1</td> </tr> </tbody> </table>	VLAN Name	Status	Ports	-----			20 VLAN0020	STATIC	Gi0/1
VLAN Name	Status	Ports								

20 VLAN0020	STATIC	Gi0/1								

Configuration Example

➤ **Configuring an Uplink Port**

Configuration Steps	The following is an example of configuring Gi0/1 as an Uplink port.																		
	<pre>FS# configure terminal FS(config)# interface gi 0/1 FS(config-if-GigabitEthernet 0/1)# switchport mode uplink FS(config-if-GigabitEthernet 0/1)# end</pre>																		
Verification	Check whether the configuration is correct.																		
	<pre>FS# show interfaces GigabitEthernet 0/1 switchport</pre> <table border="1"> <thead> <tr> <th>Interface</th> <th>Switchport Mode</th> <th>Access</th> <th>Native</th> <th>Protected</th> <th>VLAN lists</th> </tr> </thead> <tbody> <tr> <td colspan="6">-----</td> </tr> <tr> <td>GigabitEthernet 0/1</td> <td>enabled</td> <td>UPLINK</td> <td>1</td> <td>1</td> <td>disabled ALL</td> </tr> </tbody> </table>	Interface	Switchport Mode	Access	Native	Protected	VLAN lists	-----						GigabitEthernet 0/1	enabled	UPLINK	1	1	disabled ALL
Interface	Switchport Mode	Access	Native	Protected	VLAN lists														

GigabitEthernet 0/1	enabled	UPLINK	1	1	disabled ALL														

26.4.4Configuring a Hybrid Port

Configuration Effect

- A Hybrid port is usually used in SHARE VLAN environment. By default, a Hybrid port is the same as a Trunk port. Their difference is that a Hybrid port can send the frames from the VLANs except the default VLAN in the untagged format.

Configuration Steps

➤ **Configuring a Hybrid Port**

- Mandatory.
- Configure a Hybrid port to transmit the flows from multiple VLANs.

- Configuration:

Command	switchport mode hybrid
Parameter	N/A
Description	
Defaults	The default mode is Access, which can be modified to Hybrid.
Command Mode	Interface configuration mode
Usage Guide	To restore all properties of a Hybrid port to defaults, use the no switchport mode command.

📌 Defining Allowed-VLANs for a Hybrid Port

- Optional.
- By default, a Hybrid port transmits the flows from all the VLANs (1 to 4094). You may configure a list of allowed-VLANs to prohibit flows of some VLANs from passing through a Hybrid port.
- Configuration:

Command	switchport hybrid allowed vlan [add only] tagged [add] untagged remove] vlan_list
Parameter	<i>vlan-id</i> : indicates a VLAN ID.
Description	
Defaults	By default a Hybrid port belongs to all VLANs. The port is added to the default VLAN in untagged form and to the other VLANs in the tagged form.
Command Mode	Interface configuration mode
Usage Guide	N/A

📌 Configuring a Native VLAN

- Optional.
- If a frame carries the VLAN ID of a native VLAN, its tag will be stripped automatically when it passes a Hybrid port.
- Configuration:

Command	switchport hybrid native vlan <i>vlan_id</i>
Parameter	<i>vlan-id</i> : indicates a VLAN ID.
Description	
Defaults	The default native VLAN is VLAN 1.
Command Mode	Interface configuration mode
Usage Guide	To restore the native VLAN of a Hybrid port to defaults, use the no switchport hybrid native vlan command.

Verification

- Send tagged packets to an Hybrid port, and they are broadcast within the specified VLANs.
- Use commands **show vlan** and **show interface switchport** to check whether the configuration takes effect.

Command	show vlan [id <i>vlan-id</i>]
Parameter	<i>vlan-id</i> : indicates a VLAN ID.

Description										
Command	Any mode									
Mode										
Usage Guide	N/A									
Command Display	<pre>FS(config-vlan)#show vlan id 20</pre> <table border="1"> <thead> <tr> <th>VLAN Name</th> <th>Status</th> <th>Ports</th> </tr> </thead> <tbody> <tr> <td>-----</td> <td></td> <td></td> </tr> <tr> <td>20 VLAN0020</td> <td>STATIC</td> <td>Gi0/1</td> </tr> </tbody> </table>	VLAN Name	Status	Ports	-----			20 VLAN0020	STATIC	Gi0/1
VLAN Name	Status	Ports								

20 VLAN0020	STATIC	Gi0/1								

Configuration Example

⚡ Configuring a Hybrid Port

Configuration Steps	The following is an example of configuring Gi0/1 as a Hybrid port.
	<pre>FS# configure terminal FS(config)# interface gigabitEthernet 0/1 FS(config-if-GigabitEthernet 0/1)# switchport mode hybrid FS(config-if-GigabitEthernet 0/1)# switchport hybrid native vlan 3 FS(config-if-GigabitEthernet 0/1)# switchport hybrid allowed vlan untagged 20-30 FS(config-if-GigabitEthernet 0/1)# end</pre>
Verification	Check whether the configuration is correct.
	<pre>FS(config-if-GigabitEthernet 0/1)#show run interface gigabitEthernet 0/1</pre> <pre>Building configuration... Current configuration : 166 bytes interface GigabitEthernet 0/1 switchport switchport mode hybrid switchport hybrid native vlan 3 switchport hybrid allowed vlan add untagged 20-30</pre>

26.4.5 Configuring a Service Chain Port

Configuration Effect

- In normal cases, the service chain port is used at layer 2 diversion environment. By default, the service chain port does not learn MAC addresses and can forward packets from any VLAN. In addition, it is deployed in transparent mode to divert layer-2 and layer-3 packets.

Configuration Steps

↘ Configuring a Service Chain Port

- Mandatory.
- Perform this operation to configure a port as a service chain port.
- Perform this operation on the switch.

Command	switchport mode servicechain
Parameter Description	N/A
Defaults	The default mode is ACCESS .
Command Mode	Interface configuration model
Usage Guide	Before changing a port from an access, trunk, hybrid, uplink, or 802.1Q tunnel port to a service chain port, clear other configurations on the port and changes the port to an access port first. To restore the default settings, run no switchport mode in interface configuration mode.

Verification

- The service chain port does not learn the MAC address when packets with tags are sent over the service chain port. In addition, packets are transmitted regardless of the carried tag and whether the VLAN is created.

Configuration Example

↘ Configuring a Service Chain Port

 Only configuration related to the service chain port is described.

Configuration Steps	Configure the Gi0/1 port as a service chain port.
	<pre>FS# configure terminal FS(config)# interface gigabitEthernet 0/1 FS(config-if-GigabitEthernet 0/1)# switchport mode servicechain FS(config-if-GigabitEthernet 0/1)# end</pre>
Verification	Run show run to check whether the configuration is correct.
	<pre>FS(config-if-GigabitEthernet 0/1)#show run interface gigabitEthernet 0/1 Building configuration... Current configuration : 166 bytes</pre>

```
interface GigabitEthernet 0/1
  switchport
  switchport mode servicechain
```

26.4.6 Configuring a Ptrunk Port

Configuration Effect

A ptrunk port is the same as a trunk port except that it only joins VLAN 1 by default. You can run the **switchport trunk allowed** command to add the port to or remove it from a specific VLAN.

Configuration Steps

▾ Configuring a Ptrunk Port

- Mandatory.
- Configure a Ptrunk port to transmit the flows from VLAN 1.
- Configuration:

Command	switchport mode ptrunk
Parameter	N/A
Description	
Defaults	The default mode is Access, which can be modified to Ptrunk.
Command Mode	Interface configuration mode
Usage Guide	To restore all properties of a Ptrunk port to defaults, use the no switchport mode command. This command is forbidden if there is a layer-2 sub-interface on this interface. If the default interface command is run globally and there is any layer-2 sub-interface, then the interface mode cannot restore the default settings.

▾ Defining Allowed-VLANs for a Ptrunk Port

- Optional.

- You may configure a list of allowed-VLANs to prohibit flows of some VLANs from passing through a Ptrunk port.
- Configuration:

Command	switchport trunk allowed vlan { all [add remove except only] } vlan-list
Parameter Description	<p><i>vlan list</i>: The parameter <i>vlan-list</i> can be a VLAN or some VLANs, and the VLAN IDs are connected by "-" in order. For example: 10-20.</p> <p>all indicates allowed-VLANs include all VLANs;</p> <p>add indicates adding a specific VLAN to the list of allowed-VLANs;</p> <p>remove indicates removing a specific VLAN from the list of allowed-VLANs;</p> <p>except indicates adding all VLANs except those in the listed VLAN to the list of allowed-VLANs.</p> <p>only indicates adding the listed VLANs to the list of allowed-VLANs, and removing the other VLANs from the list.</p>
Command Mode	Interface configuration mode
Usage Guide	You can run the no switchport trunk allowed vlan command to restore the default setting that a Ptrunk port exclusively belongs to VLAN 1.

⚡ Configuring a Native VLAN

- Optional.
- If a frame carries the VLAN ID of a native VLAN, its tag will be stripped automatically when it passes a Trunk port.
- Configuration:

Command	switchport trunk native vlan vlan-id
Parameter Description	<i>vlan-id</i> : indicates a VLAN ID.
Command Mode	Interface configuration mode
Usage Guide	To restore the native VLAN of a Ptrunk port back to the default VLAN 1, use the no switchport trunk native vlan command.

Verification

- Send tag packets to a Trunk port, and they are broadcast within the specified VLANs.
- Use commands **show vlan** and **show interface switchport** to check whether the configuration takes effect.

Command	show vlan [id vlan-id]
Parameter Description	<i>vlan-id</i> : indicates a VLAN ID.
Command Mode	Any mode
Usage Guide	N/A
Command Display	<pre>FS(config-vlan)#show vlan id 20 VLAN Name Status Ports ----- 20 VLAN0020 STATIC Gi0/1</pre>

Configuration Example

Configuring A Ptrunk Port

Configuration Steps	The following example configures the Gi0/1 port as a Ptrunk port.
D	<pre> FS# configure terminal FS(config)# interface gi 0/1 FS(config-if-GigabitEthernet 0/1)# switchport mode ptrunk FS(config-if-GigabitEthernet 0/1)# end </pre>
Verification	Run the show interface switchport command to verify the configuration.
D	<pre> FS# show interfaces GigabitEthernet 0/1 switchport Interface Switchport Mode Access Native Protected VLAN lists ----- GigabitEthernet 0/1 enabled PTRUNK 1 1 Disabled 1 </pre>

Common Errors

- N/A

26.4.7 Configuring an Inherited VLAN for an Independent Port

Configuration Effect

- Only trunk, uplink, and hybrid ports support this configuration. After the extend VLAN list of a trunk or uplink port is specified, when this port is an AP and a member port of the AP is changed to an independent port, the member port uses the extend VLAN list configured on the AP as the allowed VLAN list. Likewise, after the extend VLAN list of a hybrid port is specified, the extend VLAN list is used as the allowed VLAN list of a member hybrid port, and a member hybrid port that is changed to an independent port will also inherit the tag VLAN list of the AP.

Configuration Steps

Configuring an Inherited VLAN for an Independent Port

- Mandatory.
- Perform this operation on the switch. In PXE OS installation scenarios, perform this operation on an AP.

Command	switchport individual-port extend-vlan <i>vlan-list</i>
Parameter Description	N/A
Defaults	No inherited VLAN is configured by default.
Command Mode	Interface configuration mode of a switch port
Usage Guide	To disable this function, use the no switchport individual-port extend-vlan or default switchport individual-port extend-vlan command. Only trunk, uplink, and hybrid ports support this configuration.

Verification

- Run the **show run** command to check whether the **switchport individual-port extend-vlan** command exists on the interface.

Configuration Example

Configuring an Inherited VLAN for an Independent Port

Only the configuration related to inherited VLANs of independent ports is described.

Configuration Steps	The following is an example of this command:
	<pre>FS# configure terminal FS(config)# interface gigabitEthernet 0/1 FS(config-if-GigabitEthernet 0/1) switchport mode trunk FS(config-if-GigabitEthernet 0/1) switchport individual-port extend-vlan 10</pre>
Verification	Run the show run command to check whether the configuration is correct.
	<pre>FS(config-if-GigabitEthernet 0/1)#show run Building configuration... Current configuration : 166 bytes interface GigabitEthernet 0/1 switchport individual-port extend-vlan 10</pre>

26.5 Monitoring

Displaying

Description	Command
Displays VLAN configuration.	show vlan
Displays configuration of switch ports.	show interface switchport

Debugging

System resources are occupied when debugging information is output. Disable the debugging switch immediately after use.

Description	Command
Debugs VLANs.	debug bridge vlan

27 Configuring MAC VLAN

27.1 Overview

The MAC VLAN function refers to assigning VLANs based on MAC addresses, which is a new method of VLAN assignment. This function is often used with 802.1X dynamic VLAN assignment to implement secure and flexible access of 802.1X terminals. After an 802.1X user passes authentication, the access switch automatically generates a MAC VLAN entry based on the VLAN and user MAC address pushed by the authentication server. A network administrator can also configure the association between a MAC address and a VLAN on the switch in advance.

Protocols

- IEEE 802.1Q: Virtual Bridged Local Area Networks and Standards

27.2 Applications

Application	Description
Configuring MAC VLAN	Configures the MAC VLAN function to assign VLANs based on users' MAC addresses. When the physical location of a user changes, i.e. switching from one switch to another, it is unnecessary to re-configure the VLAN of the port used by the user.

27.2.1 Configuring MAC VLAN

Scenario

With popularization of mobile office, terminal devices usually do not use fixed ports for network access. A terminal device may use port A to access the network this time, but use port B to access the network next time. If the VLAN configurations of ports A and B are different, the terminal device will be assigned to a different VLAN in the second access, and fail to use the resources of the previous VLAN. If the VLAN configurations of ports A and B are the same, security issues may be introduced when port B is assigned to other terminal devices. How to allow hosts of different VLANs to access the network on the same port? The MAC VLAN function is hereby introduced.

The biggest advantage of MAC VLAN lies in that when the physical location of a user changes, i.e. switching from one switch to another, it is unnecessary to re-configure the VLAN of the port used by the user. Therefore, MAC address-based VLAN assignment can be regarded as user-based.

Deployment

- Configure or push MAC VLAN entries on a layer-2 switch or wireless device to assign VLANs based on users' MAC addresses.

27.3 Overview

Feature

Feature	Description
Configuring MAC VLAN	Configures the MAC VLAN function to assign VLANs based on users' MAC addresses.

27.3.1 Configuring MAC VLAN

Working Principle

When a switch receives a packet, the switch compare the source MAC address of the packet with the MAC address specified in a MAC VLAN entry. If they match, the switch forwards the packet to the VLAN specified in the MAC VLAN entry. If they don't match, the VLAN to which the data stream belongs is still determined by the VLAN assignment rule of the port.

To ensure that a PC is assigned to a specified VLAN no matter which switch it is connected to, you can perform configuration by using the following approaches:

- Static configuration by using commands. You can configure the association between a MAC address and a VLAN on a local switch by using commands.
- Automatic configuration by using an authentication server (802.1Xdynamic VLAN assignment). After a user passes authentication, a switch dynamically creates an association between the MAC address and a VLAN based on the information provided by the authentication server. When the user goes offline, the switch automatically deletes the association. This approach requires that the MAC-VLAN association be configured on the authentication server. For details about 802.1Xdynamic VLAN assignment, refer to the [Configuring 802.1X](#).

MAC VLAN entries support both of the two approaches, that is, the entries can be configured on both a local switch and an authentication server. The configurations can take effect only if they are consistent. If the configurations are different, the configuration performed earlier takes effect.

- i** The MAC VLAN function can be configured on hybrid ports only.
- i** MAC VLAN entries are effective only for untagged packets, but not effective for tagged packets.
- i** For MAC VLAN entries statically configured or dynamically generated, the specified VLANs must exist.
- i** VLANs specified in MAC VLAN entries cannot be Super VLANs (but can be Sub VLANs), Remote VLANs, or Primary VLANs (but can be Secondary VLANs).
- i** MAC addresses specified in MAC VLAN entries must be unicast addresses.
- i** MAC VLANs are effective for all hybrid ports that are enabled with the MAC VLAN function.

27.4 Configuration

Configuration	Description and Command	
<u>Enabling MAC VLAN on a Port</u>	(Mandatory) It is used to enable the MAC VLAN function on a port.	
	mac-vlan enable	Enables MAC VLAN on a port.
<u>Adding a Static MAC VLAN Entry Globally</u>	(Optional) It is used to bind MAC addresses with VLANs.	
	mac-vlan mac-address	Configures a static MAC VLAN entry.

27.4.1 Enabling MAC VLAN on a Port

Configuration Effect

Enable the MAC VLAN function on a port so that MAC VLAN entries can take effect on the port.

Notes

N/A

Configuration Steps

↳ Enabling MAC VLAN on a Port

- Mandatory.
- By default, the MAC VLAN function is disabled on ports and all MAC VLAN entries are ineffective on the ports.
- Enable MAC VLAN on a switch.

Command	mac-vlan enable
Parameter	N/A
Description	
Defaults	The MAC VLAN function is disabled on a port.
Command Mode	Interface configuration mode
Usage Guide	N/A

Verification

- Run the **show mac-vlan interface** command to display information about the ports enabled with the MAC VLAN function.

Command	show mac-vlan interface
Parameter	N/A
Description	
Command Mode	Privileged configuration mode/Global configuration mode/Interface configuration mode
Usage Guide	N/A
Command Display	<pre>FS# show mac-vlan interface MAC VLAN is enabled on following interface: -----</pre>

FastEthernet 0/1

Configuration Example

➤ **Enabling MAC VLAN on a Port**

Configuration Steps	<ul style="list-style-type: none"> ● Enable the MAC VLAN function on the Fast Ethernet 0/10 port.
	<pre>FS# configure terminal FS(config)# interface FastEthernet0/10 FS(config-if-FastEthernet 0/10)# mac-vlan enable</pre>
Verification	<ul style="list-style-type: none"> ● Check the information about the port enabled with the MAC VLAN function.
	<pre>FS# show mac-vlan interface MAC VLAN is enabled on following interface: ----- FastEthernet 0/10</pre>

Common Errors

When the MAC VLAN function is enabled on a port, the port is not configured as a layer-2 port (such as switch port or AP port) in advance.

27.4.2 Adding a Static MAC VLAN Entry Globally

Configuration Effect

- Configure a static MAC VLAN entry to bind a MAC addresses with a VLAN. The 802.1p priority can be configured, which is 0 by default.

Notes

N/A

Configuration Steps

➤ **Adding a Static MAC VLAN Entry**

- Optional.
- To bind a MAC addresses with a VLAN, you should perform this configuration. The 802.1p priority can be configured, which is 0 by default.
- Add a static MAC VLAN entry on a switch.

Command	mac-vlan mac-address mac-address [mask mac-mask] vlan vlan-id [priority pri_val]
Parameter	mac-address mac-address: Indicates a MAC address.
Description	<p>mask mac-mask: Indicates a mask.</p> <p>vlan vlan-id: Indicates the associated VLAN.</p> <p>priority pri_val: Indicates the priority.</p>

Defaults	No static MAC VLAN entry is configured by default.
Command	Global configuration mode
Mode	
Usage Guide	N/A

- i** If an untagged packet is matched with a MAC VLAN entry, the packet is modified to the VLAN specified by the MAC VLAN entry once arriving at the switch since the MAC VLAN entry has the highest priority. Subsequent functions and protocols are implemented based on the modified VLAN. Possible influences are as follows:
- i** If an 802.1X user fails to be authenticated, the hybrid port jumps to VLAN 100 specified by the FAIL VLAN function; however, the MAC VLAN entry statically configured redirects all packets of this user to VLAN 200. Consequently, the user cannot implement normal communication in FAIL VLAN 100.
- i** After an untagged packet is matched with a MAC VLAN entry, the VLAN that triggers MAC address learning is the VLAN redirected based on the MAC VLAN entry.
- i** For a port that is enabled with the MAC VLAN function, if received packets are matched with both MAC VLAN entries with full F masks and those without full F masks, the packets are processed based on the MAC VLAN entries without full F masks.
- i** If an untagged packet is matched with both a MAC VLAN entry and a VOICE VLAN entry, the packet priority is modified simultaneously. The priority of the VOICE VLAN entry is used as that of the packet.
- i** If an untagged packet is matched with both a MAC VLAN entry and a PROTOCOL VLAN entry, the VLAN carried in the packet should be the MAC VLAN.
- i** The MAC VLAN function is applied only to untagged packets, but not applied to PRIORITY packets (packets whose VLAN tag is 0 and carrying COS PRIORITY information) and the processing actions are uncertain.
- i** The QoS packet trust model on a switch is disabled by default, which will change PRIORITY of all packets to 0 and overwrite the modification on packet priorities by the MAC VLAN function. Run the **mls qos trust cos** command in the interface configuration mode to enable the QoS trust model and trust packet priorities.

↘ Deleting All Static MAC VLAN Entries

- Optional.
- To delete all static MAC VLAN entries, you should perform this configuration.
- Perform this configuration on a switch.

Command	no mac-vlan all
Parameter	N/A
Description	
Command	Global configuration mode
Mode	
Usage Guide	N/A

↘ Deleting the Static MAC VLAN Entry of a Specified MAC Address

- Optional.
- To delete the MAC VLAN entry of a specified MAC address, you should perform this configuration.
- Perform this configuration on a switch.

Command	no mac-vlan mac-address mac-address [mask mac-mask]
----------------	--

Parameter	mac-address <i>mac-address</i> : Indicates a MAC address.
Description	mask <i>mac-mask</i> : Indicates a mask.
Command Mode	Global configuration mode
Usage Guide	N/A

🔽 **Deleting the Static MAC VLAN Entry of a Specified VLAN**

- Optional.
- To delete the MAC VLAN entry of a specified VLAN, you should perform this configuration.
- Perform this configuration on a switch.

Command	no mac-vlan vlan <i>vlan-id</i>
Parameter Description	vlan <i>vlan-id</i> : Indicates a VLAN.
Command Mode	Global configuration mode
Usage Guide	N/A

Verification

- Run the **show mac-vlan static** command to check whether all static MAC VLAN entries are correct.
- Run the **show mac-vlan vlan** *vlan-id* command to check whether the MAC VLAN entry of a specified VLAN is correct.
- Run the **show mac-vlan mac-address** *mac-address* [**mask** *mac-mask*] command to display the MAC VLAN entry of a specified MAC address.

Command	show mac-vlan static show mac-vlan vlan <i>vlan-id</i> show mac-vlan mac-address <i>mac-address</i> [mask <i>mac-mask</i>]
Parameter Description	vlan <i>vlan-id</i> : Indicates a specified VLAN. mac-address <i>mac-address</i> : Indicates a specified MAC address. mask <i>mac-mask</i> : Indicates a specified mask.
Command Mode	Privileged configuration mode/Global configuration mode/Interface configuration mode
Usage Guide	N/A
Command Display	<pre> FS# show mac-vlan all The following MAC VLAN address exist: S: Static D: Dynamic MAC ADDR MASK VLAN ID PRIO STATE ----- 0000.0000.0001 ffff.ffff.fff 2 0 D 0000.0000.0002 ffff.ffff.fff 3 3 S 0000.0000.0003 ffff.ffff.fff 3 3 S&D Total MAC VLAN address count: 3 </pre>

Configuration Example

Adding a Static MAC VLAN Entry Globally

As shown in Figure 6-1, PC-A1 and PC-A2 belong to department A and are assigned to VLAN 100. PC-B1 and PC-B2 belong to department B and are assigned to VLAN 200. Due to employee mobility, the company provides a temporary office at the meeting room but requires that accessed employees be assigned to the VLANs of their own departments. For example, PC-A1 must be assigned to VLAN 100 and PC-B1 must be assigned to VLAN 200 after access.

Since the access ports for PCs at the meeting room are not fixed, the MAC VLAN function can be used to associate the PC MAC addresses with the VLANs of their departments. No matter which ports the employees use for access, the MAC VLAN function automatically assigns the VLANs of their departments.

<p>Scenario Figure 6- 1</p>	
<p>Configuration Steps</p>	<ul style="list-style-type: none"> ● Configure the port connecting Switch C and Router 1 as a Trunk port. ● Configure all ports connecting PCs on Switch C as hybrid ports, enable the MAC VLAN function and modify the default untagged VLAN list. ● Configure MAC VLAN entries on Switch C.
<p>A</p>	<pre> A# configure terminal A(config)# interface interface_name A(config-if)# switchport mode trunk A(config-if)# exit A(config)# interface interface_name A(config-if)# switchport mode hybrid A(config-if)# switchport hybrid allowed vlan add untagged 100,200 A(config-if)# mac-vlan enable </pre>

	<pre>A(config-if)# exit A(config)# mac-vlan mac-address PC-A1-mac vlan 100 A(config)# mac-vlan mac-address PC-B1-mac vlan 200</pre>
Verification	Check the configured static MAC VLAN entries on Switch C.
A	<pre>A# FS# show mac-vlan static The following MAC VLAN address exist: S: Static D: Dynamic MAC ADDR MASK VLAN ID PRIO STATE ----- PC-A1-macffff.ffff.ffff 100 0 S PC-B1-macffff.ffff.ffff 200 3 S Total MAC VLAN address count: 2</pre>

27.5 Monitoring

Displaying

Description	Command
Displays all the MAC VLAN entries, including static and dynamic.	show mac-vlan all
Displays the dynamic MAC VLAN entries.	show mac-vlan dynamic
Displays the static MAC VLAN entries.	show mac-vlan static
Displays the MAC VLAN entries of a specified VLAN.	show mac-vlan vlan <i>vlan-id</i>
Displays the MAC VLAN entries of a specified MAC address.	show mac-vlan mac-address <i>mac-address</i> [<i>mask mac-mask</i>]

Debugging



System resources are occupied when debugging information is output. Therefore, disable debugging immediately after use.

Description	Command
Debugs the MAC VLAN function.	debug bridge mvlan

28Configuring Super VLAN

29Overview

Super virtual local area network (VLAN) is an approach to dividing VLANs. Super VLAN is also called VLAN aggregation, and is a management technology tailored for IP address optimization.

Using super VLAN can greatly save IP addresses. Only one IP address needs to be assigned to the super VLAN that consists of multiple sub VLANs, which greatly saves IP addresses and facilitates network management.

29.1Application

Application	Description
<u>Sharing One IP Gateway Among Multiple VLANs</u>	VLANs are divided to implement layer-2 (L2) isolation of access users. All VLAN users share one IP gateway to implement layer-3 (L3) communication and communication with external networks.

29.1.1Sharing One IP Gateway Among Multiple VLANs

Scenario

Multiple VLANs are isolated at L2 on a L3 device, but users of these VLANs can perform L3 communication with each other in the same network segment.

Figure 7- 1

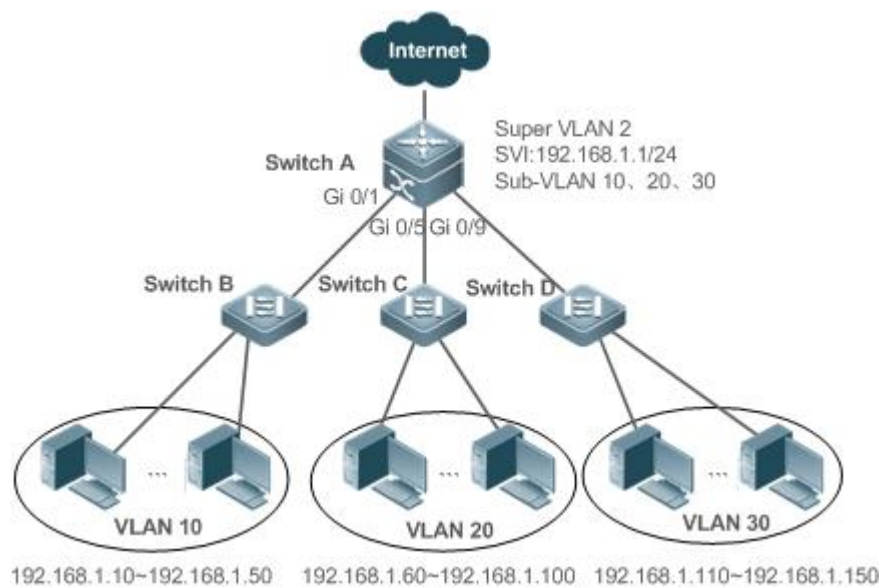

Remarks	<p>Switch A is a gateway or core switch.</p> <p>Switch B, Switch C, and Switch D are access switches.</p> <p>On Switch A, a super VLAN and multiple sub VLANs are configured, and a L3 interface and the IP address of the L3 interface are configured for the super VLAN.</p> <p>VLAN 10 is configured on Switch B, VLAN 20 is configured on Switch C, and VLAN 30 is configured on Switch D. Different departments of the company reside in different VLANs.</p>
----------------	--

Deployment

On the intranet, use the super VLAN so that multiple sub VLANs can share one IP gateway and meanwhile VLANs are mutually isolated at L2.

Users in sub VLANs can perform L3 communication through the gateway of the super VLAN.

29.2 Features

Basic Concepts

➤ Super VLAN

Super VLAN is also called VLAN aggregation, and is a management technology tailored for IP address optimization. It aggregates multiple VLANs to one IP network segment. No physical port can be added to a super VLAN. The switch virtual interface (SVI) is used to manage the cross-VLAN communication of sub VLANs. The super VLAN cannot be used as a common 802.1Q VLAN, but can be treated as the primary VLAN of sub VLANs.

➤ Sub VLAN

A sub VLAN is an independent broadcast domain. Sub VLANs are mutually isolated at L2. Users of sub VLANs of the same or different super VLANs communicate with each other through the L3 SVIs of their own super VLANs.

➤ ARP Proxy

A L3 SVI can be created only for a super VLAN. Users in a sub VLAN communicates with users in other sub VLANs of the same super VLAN or users in other network segments through the ARP proxy and the L3 SVI of the super VLAN. When a user of a sub VLAN sends an ARP request to a user of another sub VLAN, the gateway of the super VLAN uses its own MAC address to send or respond to the ARP requests. The process is called ARP proxy.

➤ IP Address Range of the Sub VLAN

Based on the gateway IP address configured for the super VLAN, an IP address range can be configured for each sub VLAN.

Overview

Feature	Description
Super VLAN	Create a L3 interface as an SVI to allow all sub VLANs to share the same IP network segment through the ARP proxy.

29.2.1 Super VLAN

Users of all sub VLANs of a super VLAN can be allocated IP addresses in the same IP address range, and share the same IP gateway. Users can implement cross-VLAN communication through this gateway. It is unnecessary to allocate a gateway for every VLAN, which saves the IP addresses.

Working Principle

IP addresses in a network segment are allocated to different sub VLANs that belong to the same super VLAN. Each sub VLAN has an independent broadcast domain of the VLAN, and different sub VLANs are isolated from each other at L2. When users in sub VLANs need to perform L3 communication, the IP address of the SVI of the super VLAN is used as the gateway address. In this way, multiple VLANs share the same IP gateway, and it is unnecessary to configure a gateway for every VLAN. In addition, to implement L3

communication between sub VLANs and between sub VLANs and other network segments, the ARP proxy function is used to forward and process the ARP requests and responses.

L2 communication of sub VLANs: If the SVI is not configured for the super VLAN, sub VLANs of super VLAN are mutually isolated at L2, that is, users in different sub VLANs cannot communicate with each other. If the SVI is configured for the super VLAN, and the gateway of the super VLAN can function as the ARP proxy, users in different sub VLANs of the same super VLAN can communicate with each other. This is because IP addresses of users in different sub VLANs belong to the same network segment, and communication between these users is still treated as L2 communication.

L3 communication of sub VLANs: If users in sub VLANs of a super VLAN need to perform L3 communication across network segments, the gateway of this super VLAN functions as the ARP proxy to respond to the ARP requests in place of sub VLANs.

29.3 Configuration

Configuration Item	Description and Command	
Configuring Basic Functions of the Super VLAN	Mandatory.	
	supervlan	Configures a super VLAN.
	subvlan <i>vlan-id-list</i>	Configures a sub VLAN.
	proxy-arp	Enables the ARP proxy function.
	interface vlan <i>vlan-id</i>	Creates a virtual interface for a super VLAN.
	ip address <i>ip mask</i>	Configures the IP address of the virtual interface of a super VLAN.
	Optional.	
subvlan-address-range <i>start-ip end-ip</i>	Specifies the IP address range in a sub VLAN.	

29.3.1 Configuring Basic Functions of the Super VLAN

Configuration Effect

Enable the super VLAN function and configure an SVI for the super VLAN to implement L2/L3 communication between sub VLANs across VLANs.

Users in all sub VLANs of a super VLAN share the same IP gateway. It is unnecessary to specify a network segment for every VLAN, which saves the IP addresses.

Notes

- A super VLAN does not belong to any physical port. Therefore, the device configured with the super VLAN cannot process packets that contain the super VLAN tag.
- Both the super VLAN function and the ARP proxy function of each sub VLAN must be enabled.
- An SVI and an IP address must be configured for a super VLAN. The SVI is a virtual interface used for communication of users in all sub VLANs.

Configuration Steps

➤ Configuring a Super VLAN

- Mandatory.
 - No physical port exists in a super VLAN.
 - The ARP proxy function must be enabled. This function is enabled by default.
 - You can run the **supervlan** command to change a common VLAN into a super VLAN.
 - After a common VLAN becomes a super VLAN, ports added to this VLAN will be deleted from this VLAN because no physical port exists in a super VLAN.
- A super VLAN is valid only after you configure sub VLANs for this super VLAN.
- VLAN 1 cannot be configured as a super VLAN.
- A super VLAN cannot be configured as a sub VLAN of another super VLAN. A sub VLAN of a super VLAN cannot be configured as a super VLAN.

Command	supervlan
Parameter Description	N/A
Defaults	By default, a VLAN is a common VLAN.
Command Mode	VLAN configuration mode
Usage Guide	By default, the super VLAN function is disabled. No physical port can be added to a super VLAN. Once a VLAN is not a super VLAN, all its sub VLANs become common static VLANs.

↘ Configuring a Virtual Interface for a Super VLAN

- Mandatory.
 - No physical port can be added to a super VLAN. You can configure the L3 SVI for a VLAN.
- When a super VLAN is configure with an SVI, it allocates a L3 interface i to each sub VLANs. If a sub VLAN is not allocated a L3 interfacdue to resource deficiency, the sub VLAN becomes a common VLAN again.

Command	interface vlan <i>vlan-id</i>
Parameter Description	<i>vlan-id</i> : Indicates the ID of the super VLAN.
Defaults	By default, no super VLAN is configured.
Command Mode	Global configuration mode
Usage Guide	A L3 interface must be configured as the virtual interface of a super VLAN.

↘ Configuring the Gateway of a Super VLAN

- Mandatory.
- The IP gateway on the L3 SVI is configured as the proxy for all users in sub VLANs to respond to ARP requests.

Command	ip address <i>ip mask</i>
----------------	----------------------------------

Parameter	<i>ip</i> : Indicates the IP address of the gateway on the virtual interface of a super VLAN.
Description	<i>Mask</i> : Indicates the mask.
Defaults	By default, no gateway is configured for a super VLAN.
Command Mode	Interface configuration mode
Usage Guide	Run this command to configure the gateway for a super VLAN. Users of all sub VLANs of the super VLAN share this gateway.

Configuring a Sub VLAN

- Mandatory.
- Physical ports can be added to sub VLANs. Sub VLANs of a super VLAN share the gateway address of the super VLAN and reside in the same network segment.
- The ARP proxy function must be enabled. This function is enabled by default.
- You can run the **subvlan***vlan-id-list* command to change a common VLAN into a sub VLAN of a super VLAN. Physical ports can be added to sub VLANs.
- Communication of users in a sub VLAN is managed by the super VLAN.

You must change a sub VLAN into a common VLAN before you can delete this sub VLAN by running the **no vlan** command.

One sub VLAN belongs to only one super VLAN.

Command	subvlan <i>vlan-id-list</i>
Parameter Description	<i>vlan-id-list</i> : Specifies multiple VLANs as sub VLANs of a super VLAN.
Defaults	By default, a VLAN is a common VLAN.
Command Mode	VLAN configuration mode
Usage Guide	<p>Connection interfaces can be added to a sub VLAN.</p> <p>You must change a sub VLAN into a common VLAN before you can delete this sub VLAN by running the no vlan [<i>id</i>]command.</p> <p>You cannot configure a L3 SVI of the VLAN for a sub VLAN.</p> <p> If you have configured a L3 SVI for a super VLAN, the attempt of adding more sub VLANs may fail due to resource deficiency.</p> <p> If you configure sub VLANs to a super VLAN, and then configure a L3 SVI of the VLAN for a super VLAN, some sub VLANs may become common VLANs again due to resource deficiency.</p>

Configuring the ARP Proxy

- (Mandatory) The ARP proxy function is enabled by default.
- Users in sub VLANs can implement L2/L3 communication across VLANs through the gateway proxy only after the ARP proxy function is enabled on both the super VLAN and sub VLANs.
- Users in sub VLANs can communicate with users of other VLANs only after the ARP proxy function is enabled on both the super VLAN and sub VLANs.

The ARP proxy function must be enabled on both the super VLAN and sub VLANs. Otherwise, this function does not take effect.

Command	proxy-arp
Parameter	N/A
Description	
Defaults	By default, the ARP proxy function is enabled.
Command Mode	VLAN configuration mode
Usage Guide	By default, the ARP proxy function is enabled. Run this command to enable the ARP proxy function on both the super VLAN and sub VLANs. Users in sub VLANs can implement L2/L3 communication across VLANs only after the ARP proxy function is enabled on both the super VLAN and sub VLANs.

📌 **Configuring the IP Address Range of the Sub VLAN**

- You can allocate an IP address range to each sub VLAN. Users in a sub VLAN can communicate with users of other VLANs only when their IP addresses are in the specified range.
- Unless otherwise specified, you do not need to configure the IP address range.
- ⚠️ IP addresses dynamically allocated to users through DHCP may not be in the allocated IP address range. If the IP addresses allocated through DCHP are not in the specified range, users in a sub VLAN cannot communicate with users of other VLANs. Therefore, be cautious in using the **subvlan-address-range start-ip end-ip** command.
- ⚠️ The IP address range of a sub VLAN must be within the IP address range of the super VLAN to which the sub VLAN belongs. Otherwise, users in sub VLANs cannot communicate with each other.
- ⚠️ IP addresses of users in a sub VLAN must be within the IP address range of the sub VLAN. Otherwise, users in the sub VLAN cannot communicate with each other.

Command	subvlan-address-range start-ip end-ip
Parameter	<i>start-ip</i> : Indicates the start IP address of a sub VLAN.
Description	<i>end-ip</i> : Indicates the end IP address of a sub VLAN.
Defaults	By default, no IP address range is configured.
Command Mode	VLAN configuration mode
Usage Guide	Optional. Run this command to configure the IP address range of users in a sub VLAN. IP address ranges of different sub VLANs of a super VLAN cannot overlap with each other. <ul style="list-style-type: none"> ⚠️ The IP address range of a sub VLAN must be within the IP address range of the super VLAN to which the sub VLAN belongs. Otherwise, users in sub VLANs cannot communicate with each other. ⚠️ Users in a sub VLAN can communicate with users of other VLANs only when their IP addresses (either dynamically allocated through DHCP or statically configured) are in the configured IP address range. ⚠️ IP addresses allocated through DHCP may not be in the configured IP address range. In this case, users in a sub VLAN cannot communicate with users of other VLANs. Therefore, be cautious when using this command.

Verification

After each sub VLAN is correlated with the gateway of the super VLAN, users in sub VLANs can ping each other.

Configuration Example

➤ **Configuring a Super VLAN on the Network so That Users in its Sub VLANs Use the Same Network Segment and Share the Same IP Gateway to Save IP Addresses**

<p>Scenario Figure 7-2</p>	
<p>Configuration</p>	<p>Perform the related super VLAN configuration on the core switch.</p>
<p>Steps</p>	<p>On the access switches, configure the common VLANs corresponding to the sub VLANs on the core switch.</p>
<p>A</p>	<pre>SwitchA#configure terminal Enter configuration commands, one per line. End with CNTL/Z. SwitchA(config)#vlan 2 SwitchA(config-vlan)#exit SwitchA(config)#vlan 10 SwitchA(config-vlan)#exit SwitchA(config)#vlan 20 SwitchA(config-vlan)#exit SwitchA(config)#vlan 30 SwitchA(config-vlan)#exit SwitchA(config)#vlan 2 SwitchA(config-vlan)#supervlan SwitchA(config-vlan)#subvlan 10,20,30 SwitchA(config-vlan)#exit SwitchA(config)#interface vlan 2 SwitchA(config-if-VLAN 2)#ip address 192.168.1.1 255.255.255.0</pre>

<pre>SwitchA(config)#vlan 10 SwitchA(config-vlan)#subvlan-address-range 192.168.1.10 192.168.1.50 SwitchA(config-vlan)#exit SwitchA(config)#vlan 20 SwitchA(config-vlan)#subvlan-address-range 192.168.1.60 192.168.1.100 SwitchA(config-vlan)#exit SwitchA(config)#vlan 30 SwitchA(config-vlan)#subvlan-address-range 192.168.1.110 192.168.1.150 SwitchA(config)#interface range gigabitEthernet 0/1,0/5,0/9 SwitchA(config-if-range)#switchport mode trunk</pre>	
Verification	Verify that the source host (192.168.1.10) and the destination host (192.168.1.60) can ping each other.
A	<pre>SwitchA(config-if-range)#show supervlan supervlan id supervlan arp-proxy subvlan id subvlan arp-proxy subvlan ip range ----- 2 ON 10 ON192.168.1.10 - 192.168.1.50 20 ON 192.168.1.60 - 192.168.1.100 30 ON 192.168.1.110 - 192.168.1.150</pre>

Common Errors

The SVI and IP gateway are not configured for the super VLAN. Consequently, communication fails between sub VLANs and between sub VLANs and other VLANs.

The ARP proxy function is disabled on the super VLAN or sub VLANs. Consequently, users in sub VLANs cannot communicate with users of other VLANs.

The IP address range of the sub VLAN is configured, but IP addresses allocated to users are not in this range.

29.4 Monitoring

Displaying

Description	Command
Displays the super VLAN configuration.	show supervlan

Debugging

System resources are occupied when debugging information is output. Therefore, disable debugging immediately after use.

Description	Command
Debugs the super VLAN.	debug bridge svlan

30 Configuring Protocol VLAN

30.1 Overview

The protocol VLAN technology is a VLAN distribution technology based on the packet protocol type. It can distribute packets of a certain protocol type with a null VLAN ID to the same VLAN. That is, the switch, based on the protocol type and encapsulation format of packets received by ports, matches the received untagged packets with protocol profiles. If the matching is successful, the switch automatically distributes the packets to a relevant VLAN for transmission. There are two types of protocol VLANs: IP address-based protocol VLAN and protocol VLAN based on the packet type and Ethernet type on ports. The protocol VLAN based on the packet type and Ethernet type on ports is called protocol VLAN for short and the IP address-based protocol VLAN is called subnet VLAN for short.

 The protocol VLAN is applicable only to Trunk ports and Hybrid ports.

Protocols and Standards

IEEE standard 802.1Q

30.2 Applications

Application	Description
Configuration and Application of Protocol VLAN	Implements Layer-2 communication isolation of user hosts that use different protocol packets for communication to reduce the network traffic.
Configuration and Application of Subnet VLAN	Specifies the VLAN range based on the IP network segment to which user packets belong.

30.2.1 Configuration and Application of Protocol VLAN

Scenario

As shown in the following figure, the network architecture is composed of the interconnected Windows NT server and Novell Network server and the office area is connected to the Layer-3 device Switch A through a hub. There are different PCs in the office area. Some PCs use the Windows NT operating system (OS) and support the IP protocol, and some PCs use the Novell Network OS and support the IPX protocol. PCs in the office area communicate with the external network and servers through the uplink port Gi 0/3.

The main requirements are as follows:

- The Layer-2 communication of PCs using the Windows NT OS is isolated from that of PCs using the Novell Network OS, so as to reduce the network traffic.

Figure 8- 1

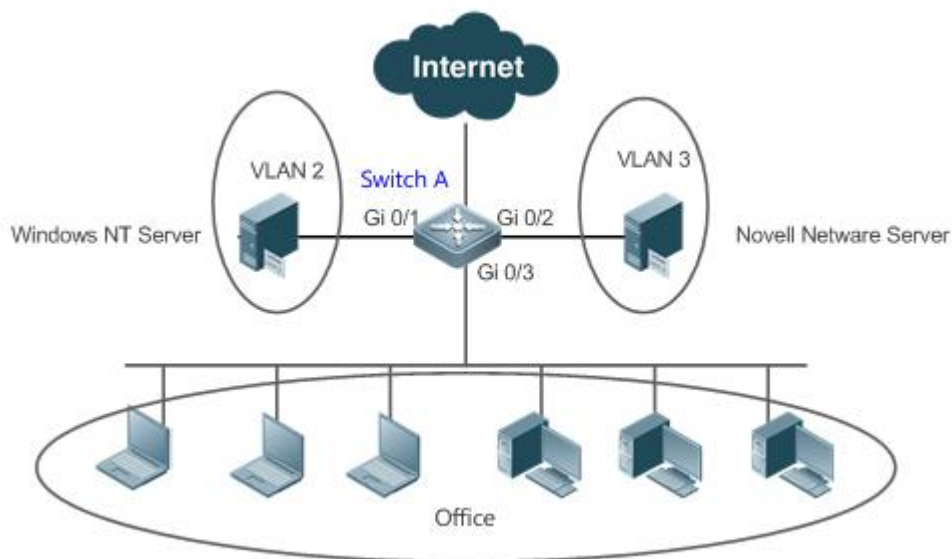

Remarks	Switch A is a switch and Port Gi 0/3 is a Hybrid port. Port Gi 0/1 is an Access port and belongs to VLAN 2. Port Gi 0/2 is also an Access port and belongs to VLAN 3.
----------------	---

Deployment

- Configure profiles of the packet type and Ethernet type (in this example, configure Profile 1 for IP protocol packets and configure Profile 2 for IPX protocol packets).
- Apply the profiles to the uplink port (Port Gi 0/3 in this example) and associate them with VLANs (in this example, associate Profile 1 with VLAN 2 and associate Profile 2 with VLAN 3).

The configured protocol VLANs take effect only on the Trunk ports and Hybrid ports.

30.2.2 Configuration and Application of Subnet VLAN

Scenario

As shown in the following figure, PCs in Office A and Office B are connected to the Layer-3 device Switch A through hubs. In Office A, the PCs belong to a fixed network segment and they are distributed to the same VLAN by port. In Office B, the PCs belong to two network segments, but they cannot be distributed to VLANs by fixed port.

The main requirements are as follows:

For PCs in Office B, Switch A can determine the VLAN range of the PCs based on the IP network segment to which their packets belong.

Figure 8- 2

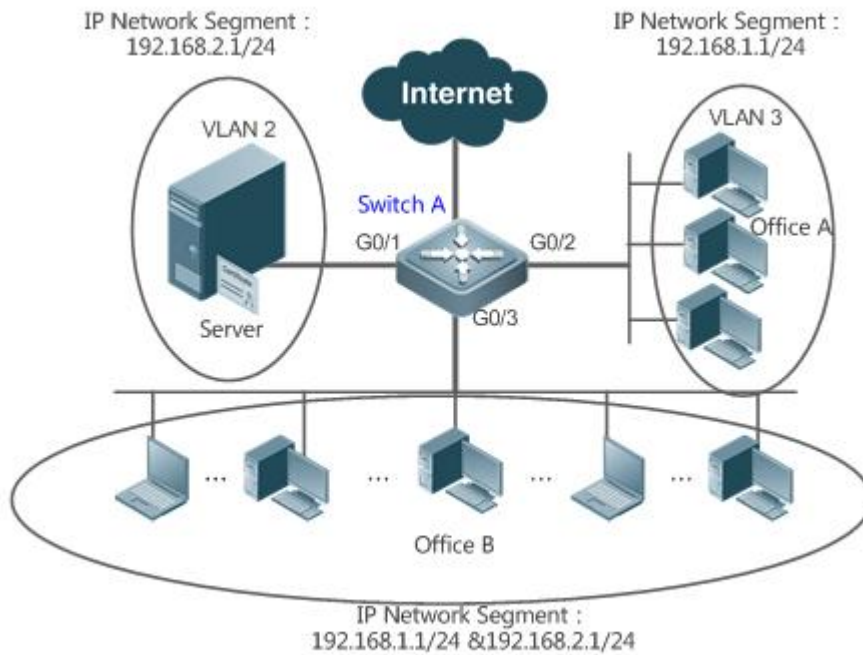

Remarks	Switch A is a switch. Port G0/1 is an Access port and belongs to VLAN 2. Port G0/2 is also an Access port and belongs to VLAN 3. Port G0/3 is a Hybrid port.
----------------	--

Deployment

- Globally configure subnet VLANs (in this example, allocate the IP network segment 192.168.1.1/24 to VLAN 3 and the IP network segment 192.168.2.1/24 to VLAN 2) and enable the subnet VLAN function on the uplink port (Port Gi 0/3 in this example).

 The configured subnet VLANs take effect only on the Trunk ports and Hybrid ports.

30.3 Features

Basic Concepts

Protocol VLAN

The protocol VLAN technology is a VLAN distribution technology based on the packet protocol type. It can distribute packets of a certain protocol type with a null VLAN ID to the same VLAN.

VLANs need to be specified for packets received by device ports so that a packet belongs to a unique VLAN. There are three possible cases:

- If a packet contains a null VLAN ID (untagged or priority packet) and the device supports only port-based VLAN distribution, the VLAN ID in the tag added to the packet is the PVID of the input port.
- If a packet contains a null VLAN ID (untagged or priority packet) and the device supports VLAN distribution based on the packet protocol type, the VLAN ID in the tag added to the packet is selected from the VLAN IDs mapped to the protocol suite configuration of the input port. If the protocol type of the packet does not match all protocol suite configuration of the input port, a VLAN ID is allocated according to the port-based VLAN distribution.
- If a packet is a tagged packet, the VLAN to which the packet belongs is determined by the VLAN ID in the tag.

Subnet VLANs can be configured only globally that is, only the protocol VLAN function can be enabled or disabled on ports. The matching configuration is globally performed for the protocol VLAN, the matching configuration is selected on ports and the VLAN IDs are specified for packets that are matched successfully.

- If an input packet contains a null VLAN ID and the IP address of the input packet matches an IP address, the packet is distributed to the subnet VLAN.
- If an input packet contains a null VLAN ID and the packet type and Ethernet type of the input packet match the packet type and Ethernet type of an input port, the packet is allocated to the protocol VLAN.

📌 **Protocol VLAN Priority**

The priority of a subnet VLAN is higher than that of a protocol VLAN. That is, if a subnet VLAN and protocol VLAN are configured at the same time and an input packet conforms to both the subnet VLAN and protocol VLAN, the subnet VLAN prevails.

Overview

Feature	Description
Automatic VLAN Distribution Based on Packet Type	The service types supported on a network are bound with VLANs or packets from a specified IP network segment are transmitted in a specified VLAN to facilitate management and maintenance.



30.3.1 Automatic VLAN Distribution Based on Packet Type

Working Principle

Set rules on the hardware and enable the rules on ports. The rules take effect only after they are enabled on ports. The rules include the packet type and IP address of packets. When a port receives untagged data packets that meet the rules, the port automatically distributes them to the VLAN specified in the rules for transmission. When the rules are disabled on ports, untagged data packets are distributed to the Native VLAN according to the port configuration.

Related Configuration

30.4 Configuration

Configuration	Description and Command
Configuring the Protocol VLAN Function	 (Mandatory) It is used to enable the VLAN distribution function based on the packet type and Ethernet type of the protocol VLAN.
	protocol-vlan profile num frame-type [type] ether-type [type] Configures the profile of the packet type and Ethernet type.
	protocol-vlan profile num ether-type [type] Configures the profile of the Ethernet type (some models do not support frame identification).
	protocol-vlan profile num vlan vid (Interface configuration mode) Applies the protocol VLAN on a port.
Configuring the Subnet VLAN Function	 (Mandatory) It is used to enable IP address-based VLAN distribution function of the protocol VLAN.
	protocol-vlan ipv4 address mask address vlan vid Configures an IP address, subnet mask, and VLAN

Configuration	Description and Command
	distribution.
	protocol-vlan ipv4 (Interface configuration mode) Enables the subnet VLAN on a port.

30.4.1 Configuring the Protocol VLAN Function

Configuration Effect

Bind service types supported in a network with VLANs to facilitate management and maintenance.

Notes

- It is recommended that the protocol VLAN be configured after VLANs, and the Trunk, Hybrid, Access, and AP attributes of ports are configured.
- If protocol VLAN is configured on a Trunk port or Hybrid port, all VLANs relevant to the protocol VLAN need to be contained in the permitted VLAN list of the Trunk port or Hybrid port.

Configuration Steps

📌 Configuring the Protocol VLAN Globally

- Mandatory.
- The protocol VLAN can be applied on an interface only in global configuration mode.

Command	protocol-vlan profile num frame-type [type] ether-type [type]
Parameter	<i>num</i> : Indicates the profile index.
Description	<i>type</i> : Indicates the packet type and Ethernet type.
Defaults	The protocol VLAN is disabled by default.
Command Mode	Global configuration mode
Usage Guide	The protocol VLAN can be configured on an interface only when the protocol VLAN is globally configured. When the global configuration of a protocol VLAN profile is deleted, the protocol VLAN configuration is deleted from all interfaces corresponding to the profile of the protocol VLAN.

📌 Switching the Port Mode to Trunk/Hybrid Mode

- Mandatory. The protocol VLAN function takes effect only on ports that are in Trunk/Hybrid mode.

📌 Enabling the Protocol VLAN on a Port

- Mandatory. The protocol VLAN is disabled by default.
- The protocol VLAN is truly enabled only when it is applied on interfaces.

Command	protocol-vlan profile num vlan vid
Parameter	<i>num</i> : Indicates the profile index.
Description	<i>vid</i> : Indicates the VLAN ID. The value 1 indicates the maximum VLAN ID supported by the product.
Defaults	The protocol VLAN is disabled by default.

Command	Interface configuration mode
Mode	
Usage Guide	An interface must work in Trunk/Hybrid mode.

Verification

Run the **show protocol-vlan profile** command to check the configuration.

Configuration Example

▾ **Enabling the Protocol VLAN Function in the Topological Environment**

<p>Scenario</p> <p>Figure 8-3</p>	<p>The diagram illustrates a network topology. At the top, a cloud labeled 'Internet' is connected to 'Switch A'. Switch A has three uplink ports: Gi 0/1, Gi 0/2, and Gi 0/3. Gi 0/1 is connected to a server labeled 'Windows NT Server' within a circle labeled 'VLAN 2'. Gi 0/2 is connected to a server labeled 'Novell Netware Server' within a circle labeled 'VLAN 3'. Gi 0/3 is connected to a horizontal bus that leads to an oval labeled 'Office' containing several laptops and desktop computers.</p>
<p>Configuration Steps</p>	<ul style="list-style-type: none"> ● Configure VLAN 2 and VLAN 3 for user communication on Switch A. ● Configure the protocol VLAN globally on Switch A (in this example, configure Profile 1 for IP protocol packets and configure Profile 2 for IPX protocol packets), enable the protocol VLAN function on the uplink port (Port Gi 0/3 in this example), and complete the protocol-VLAN association (in this example, associate Profile 1 with VLAN 2 and associate Profile 2 with VLAN 3). ● Port Gi 0/1 is an Access port and belongs to VLAN 2. Port Gi 0/2 is also an Access port and belongs to VLAN 3. Port Gi 0/3 is a Hybrid port. Ensure that the user communication VLANs are contained in the permitted untagged VLAN list of the Hybrid port.
<p>A</p>	<p>1. Create VLAN 2 and VLAN 3 for user network communication.</p> <pre># configure terminal Enter configuration commands, one per line. End with CNTL/Z. A(config)# vlan range 2-3</pre>

	<p>2. Configure the port mode.</p> <pre>A(config)#interface gigabitEthernet 0/1 A(config-if-GigabitEthernet 0/1)#switchport A(config-if-GigabitEthernet 0/1)#switchport access vlan 2 A(config-if-GigabitEthernet 0/1)#exit A(config)#interface gigabitEthernet 0/2 A(config-if-GigabitEthernet 0/2)#switchport A(config-if-GigabitEthernet 0/2)#switchport access vlan 3 A(config-if-GigabitEthernet 0/2)#exit A(config)# interface gigabitEthernet 0/3 A(config-if-GigabitEthernet 0/3)#switchport A(config-if-GigabitEthernet 0/3)# switchport mode hybrid A(config-if-GigabitEthernet 0/3)# switchport hybrid allowed vlan untagged 2-3</pre> <p>3. Configure the protocol VLAN globally.</p> <p>Configure Profile 1 for IP protocol packets and Profile 2 for IPX protocol packets (in this example, assume that packets are encapsulated using Ethernet II and the Ethernet types of IP protocol packets and IPX protocol packets are 0X0800 and 0X8137 respectively).</p> <pre>A(config)#protocol-vlan profile 1 frame-type ETHERII ether-type 0x0800 A(config)#protocol-vlan profile 2 frame-type ETHERII ether-type 0x8137</pre> <p>4. Apply Profile 1 and Profile 2 to Port Gi 0/3 and allocate Profile 1 to VLAN 2 and Profile 2 to VLAN 3.</p> <pre>A(config)# interface gigabitEthernet 0/3 A(config-if-GigabitEthernet 0/3) #protocol-vlan profile 1 vlan 2 A(config-if-GigabitEthernet 0/3) #protocol-vlan profile 2 vlan 3</pre>										
Verification	Check whether the protocol VLAN configuration on the device is correct.										
A	<pre>A(config)#show protocol-vlan profile</pre> <table border="1"> <thead> <tr> <th>profile</th> <th>frame-type</th> <th>ether-type/DSAP+SSAP</th> <th>interface</th> <th>vlan</th> </tr> </thead> <tbody> <tr> <td>1</td> <td>ETHERII</td> <td>0x0800</td> <td>Gi0/3</td> <td>2</td> </tr> </tbody> </table>	profile	frame-type	ether-type/DSAP+SSAP	interface	vlan	1	ETHERII	0x0800	Gi0/3	2
profile	frame-type	ether-type/DSAP+SSAP	interface	vlan							
1	ETHERII	0x0800	Gi0/3	2							

	2	ETHERII	0x8137		Gi0/3	3
--	---	---------	--------	--	-------	---

Common Errors

- A port connected to the device is not in Trunk/Hybrid mode.
- The permitted VLAN list of the port connected to the device does not contain the user communication VLANs.
- The protocol VLAN function is disabled on a port.

30.4.2Configuring the Subnet VLAN Function

Configuration Effect

Distribute packets from a specified network segment or IP address to a specified VLAN for transmission.

Notes

- It is recommended that the protocol VLAN be configured after VLANs, and the Trunk, Hybrid, Access, and AP attributes of ports are configured.
- If protocol VLAN is configured on a Trunk port or Hybrid port, all VLANs relevant to the protocol VLAN need to be contained in the permitted VLAN list of the Trunk port or Hybrid port.

Configuration Steps

➤ **Configuring the Subnet VLAN Globally**

- Mandatory.
- The subnet VLAN can be applied on an interface only in global configuration mode.

Command	protocol-vlan ipv4 address mask address vlan vid
Parameter	<i>address</i> : Indicates the IP address.
Description	<i>vid</i> : Indicates the VLAN ID. The value 1 indicates the maximum VLAN ID supported by the product.
Defaults	The subnet VLAN is disabled by default.
Command Mode	Global configuration mode
Usage Guide	The subnet VLAN can be enabled on an interface even if the protocol VLAN is not enabled globally. Nevertheless, the subnet VLAN takes effect only when the protocol VLAN is configured globally.

➤ **Switching the Port Mode to Trunk/Hybrid Mode**

- Mandatory. The subnet VLAN function takes effect only on ports that are in Trunk/Hybrid mode.

➤ **Enabling the Subnet VLAN on a Port**

- Mandatory. The subnet VLAN is disabled by default.
- The subnet VLAN is truly enabled only when it is applied on interfaces.

Command	protocol-vlan ipv4
Parameter Description	N/A
Defaults	The subnet VLAN is disabled by default.
Command Mode	Interface configuration mode
Usage Guide	An interface must work in Trunk/Hybrid mode.

Verification

Run the **show protocol-vlan ipv4** command to check the configuration.

Configuration Example

📌 **Enabling the Subnet VLAN Function in the Topological Environment**

<p>Scenario Figure 8- 4</p>	
<p>Configuration Steps</p>	<ul style="list-style-type: none"> ● Configure VLAN 2 and VLAN 3 for user communication on Switch A. ● Globally configure subnet VLANs on Switch A (in this example, allocate the IP network segment 192.168.1.1/24 to VLAN 3 and the IP network segment 192.168.2.1/24 to VLAN 2) and enable the subnet VLAN function on the uplink port (Port Gi 0/3 in this example). ● Port Gi 0/1 is an Access port and belongs to VLAN 2. Port Gi 0/2 is also an Access port and belongs to VLAN 3. Port Gi 0/3 is a Hybrid port. Ensure that the user communication VLANs are contained in the permitted untagged VLAN list of the Hybrid port.
<p>A</p>	<p>1. Create VLAN 2 and VLAN 3 for user network communication.</p> <pre>A# configure terminal</pre>

	<p>Enter configuration commands, one per line. End with CNTL/Z.</p> <pre>A(config)# vlan range 2-3</pre> <p>2. Configure the port mode.</p> <pre>A(config)#interface gigabitEthernet 0/1 A(config-if-GigabitEthernet 0/1)#switchport A(config-if-GigabitEthernet 0/1)#switchport access vlan 2 A(config-if-GigabitEthernet 0/1)#exit A(config)#interface gigabitEthernet 0/2 A(config-if-GigabitEthernet 0/2)#switchport A(config-if-GigabitEthernet 0/2)#switchport access vlan 3 A(config-if-GigabitEthernet 0/2)#exit A(config)# interface gigabitEthernet 0/3 A(config-if-GigabitEthernet 0/3)#switchport A(config-if-GigabitEthernet 0/3)# switchport mode hybrid A(config-if-GigabitEthernet 0/3)# switchport hybrid allowed vlan untagged 2-3</pre> <p>3. Configure the subnet VLAN globally.</p> <pre>A(config)# protocol-vlan ipv4 192.168.1.0 mask 255.255.255.0 vlan 3 A(config)# protocol-vlan ipv4 192.168.2.0 mask 255.255.255.0 vlan 2</pre> <p>4. Enable the subnet VLAN on interfaces. The subnet VLAN is disabled by default.</p> <pre>(config-if-GigabitEthernet 0/3)# protocol-vlan ipv4</pre>									
<p>Verification</p>	<p>Check whether the subnet VLAN configuration on the device is correct.</p>									
<p>A</p>	<pre>A# show protocol-vlan ipv4</pre> <table border="1"> <thead> <tr> <th>ip</th> <th>mask</th> <th>vlan</th> </tr> </thead> <tbody> <tr> <td>192.168.1.0</td> <td>255.255.255.0</td> <td>3</td> </tr> <tr> <td>192.168.2.0</td> <td>255.255.255.0</td> <td>2</td> </tr> </tbody> </table> <pre>interface ipv4 status</pre>	ip	mask	vlan	192.168.1.0	255.255.255.0	3	192.168.2.0	255.255.255.0	2
ip	mask	vlan								
192.168.1.0	255.255.255.0	3								
192.168.2.0	255.255.255.0	2								

	Gi0/3	enable
--	-------	--------

Common Errors

- A port connected to the device is not in Trunk/Hybrid mode.
- The permitted VLAN list of the port connected to the device does not contain the user communication VLANs.
- The subnet VLAN is disabled on a port.

30.5 Monitoring

Displaying

Description	Command
Displays the protocol VLAN content.	show protocol-vlan

Debugging

 System resources are occupied when debugging information is output. Therefore, disable debugging immediately after use.

Description	Command
Debugs the protocol VLAN.	debug bridge protvlan

31 Configuring Private VLAN

31.1 Overview

Private VLAN divides the Layer-2 broadcast domain of a VLAN into multiple subdomains. Each subdomain is composed of one private VLAN pair: primary VLAN and secondary VLAN.

One private VLAN domain may consist of multiple private VLAN pairs and each private VLAN pair represents one subdomain. In a private VLAN domain, all private VLAN pairs share the same primary VLAN. The secondary VLAN IDs of subdomains are different.

If a service provider allocates one VLAN to each user, the number of users that can be supported by the service provider is restricted because one device supports a maximum of 4,096 VLANs. On a Layer-3 device, one subnet address or a series of addresses are allocated to each VLAN, which results in the waste of IP addresses. The private VLAN technology properly solves the preceding two problems. Private VLAN is hereinafter called PVLAN for short.

31.2 Applications

Application	Description
Cross-Device Layer-2 Application of PVLAN	Users of an enterprise can communicate with each other but the user communication between enterprises is isolated.
Layer-3 Application of PVLAN on a Single Device	All enterprise users share the same gateway address and can communicate with the external network.

31.2.1 Cross-Device Layer-2 Application of PVLAN

Scenario

As shown in the following figure, in the hosting service operation network, enterprise user hosts are connected to the network through Switch A or Switch B. The main requirements are as follows:

- Users of an enterprise can communicate with each other but the user communication between enterprises is isolated.
- All enterprise users share the same gateway address and can communicate with the external network.

Figure 9- 1

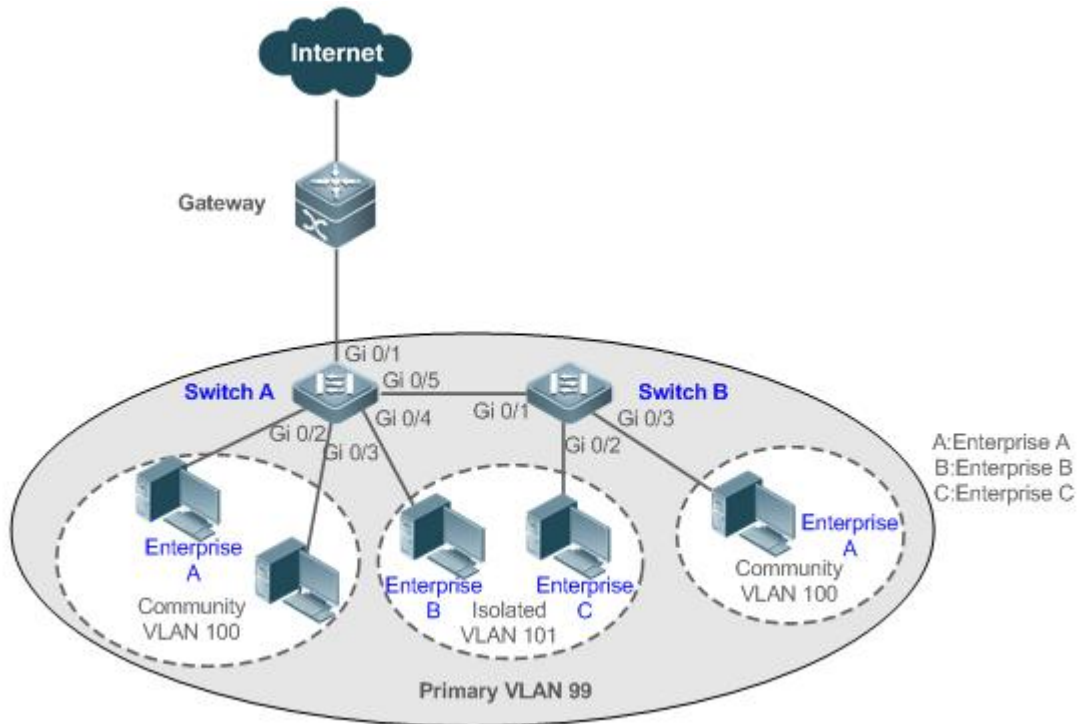

Remarks	<p>Switch A and Switch B are access switches.</p> <p>PVLAN runs across devices. The ports for connecting the devices need to be configured as Trunk ports, that is, Port Gi 0/5 of Switch A and Port Gi 0/1 of Switch B are configured as Trunk ports.</p> <p>Port Gi 0/1 for connecting Switch A to the gateway needs to be configured as a promiscuous port.</p> <p>Port Gi 0/1 of the gateway can be configured as a Trunk port or Hybrid port and the Native VLAN is the primary VLAN of PVLAN.</p>
----------------	---

Deployment

- Configure all enterprises to be in the same PVLAN (primary VLAN 99 in this example). All enterprise users share the same Layer-3 interface through this VLAN to communicate with the external network.
- If an enterprise has multiple user hosts, allocate the user hosts of different enterprises to different community VLANs. That is, configure the ports connected to the enterprise user hosts as the host ports of a community VLAN, so as to implement user communication inside an enterprise but isolate the user communication between enterprises.
- If an enterprise has only one user host, configure the ports connected to the user hosts of such enterprises as the host ports of an isolated VLAN so as to implement isolation of user communication between the enterprises.

31.2.2 Layer-3 Application of PVLAN on a Single Device

As shown in the following figure, in the hosting service operation network, enterprise user hosts are connected to the network through the Layer-3 device Switch A. The main requirements are as follows:

- Users of an enterprise can communicate with each other but the user communication between enterprises is isolated.
- All enterprise users can access the server.
- All enterprise users share the same gateway address and can communicate with the external network.

Figure 9- 2

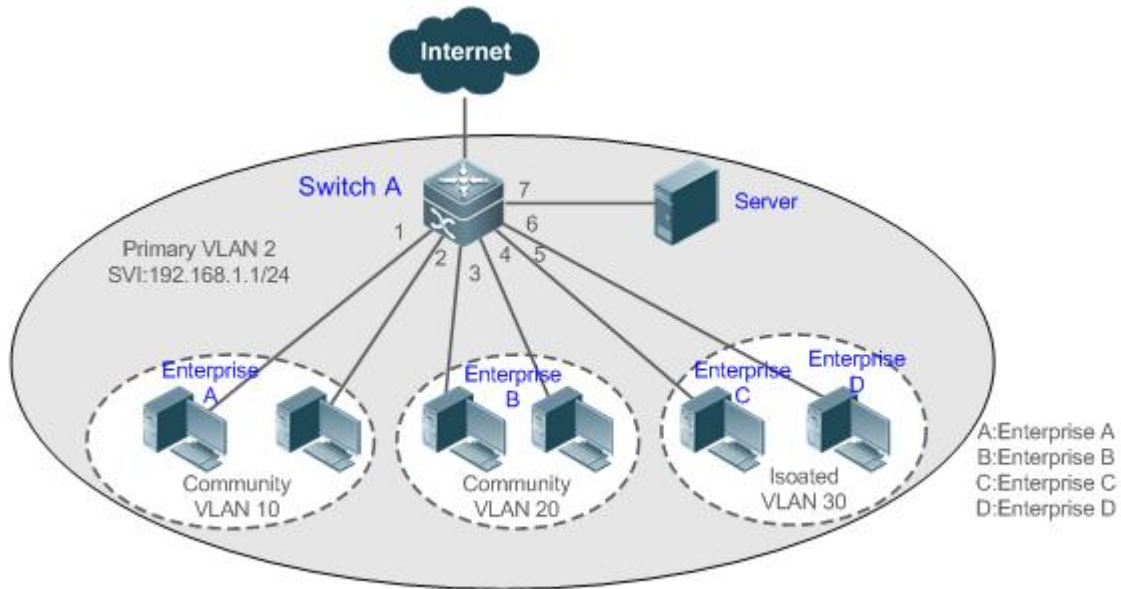

Remarks	<p>Switch A is a gateway switch.</p> <p>When user hosts are connected to a single device, Port Gi 0/7 for connecting to the server is configured as a promiscuous port so that enterprise users can communicate with the server.</p> <p>Layer-3 mapping needs to be performed on the primary VLAN and secondary VLANs so that the users can communicate with the external network.</p>
----------------	--

Deployment

- Configure the port that is directly connected to the server as a promiscuous port. Then, all enterprise users can communicate with the server through the promiscuous port.
- Configure the gateway address of PVLAN on the Layer-3 device (Switch A in this example) (in this example, set the SVI address of VLAN 2 to 192.168.1.1/24) and configure the mapping between the primary VLAN and secondary VLANs on the Layer-3 interface. Then, all enterprise users can communicate with the external network through the gateway address.

31.3 Features

Basic Concepts

➤ PVLAN

PVLAN supports three types of VLANs: primary VLANs, isolated VLANs, and community VLANs.

A PVLAN domain has only one primary VLAN. Secondary VLANs implement Layer-2 isolation in the same PVLAN domain. There are two types of secondary VLANs.

↘ Isolated VLAN

Ports in the same isolated VLAN cannot mutually make Layer-2 communication. A PVLAN domain has only one isolated VLAN.

↘ Community VLAN

Ports in the same community VLAN can make Layer-2 communication with each other but cannot make Layer-2 communication with ports in other community VLANs. A PVLAN domain can have multiple community VLANs.

↘ Layer-2 Association of PVLAN

PVLAN pairs exist only after Layer-2 association is performed among the three types of VLANs of PVLAN. Then, a primary VLAN has a specified secondary VLAN and a secondary VLAN has a specified primary VLAN. A primary VLAN and secondary VLANs are in the one-to-many relationship.

↘ Layer-3 Association of PVLAN

In PVLAN, Layer-3 interfaces, that is, switched virtual interfaces (SVIs) can be created only in a primary VLAN. Users in a secondary VLAN can make Layer-3 communication only after Layer-3 association is performed between the secondary VLAN and the primary VLAN. Otherwise, the users can make only Layer-2 communication.

↘ Community Port

Community ports are ports in a community VLAN. Community ports in the same community VLAN can communicate with each other and can communicate with promiscuous ports. They cannot communicate with community ports in other community VLANs or isolated ports in an isolated VLAN.

↘ Promiscuous Port

Promiscuous ports are ports in a primary VLAN. They can communicate with any ports, including isolated ports and community ports in secondary VLANs of the same PVLAN domain.

 In PVLAN, SVIs can be created only in a primary VLAN and SVIs cannot be created in secondary VLANs.

 Ports in PVLAN can be used as mirroring source ports but cannot be used as mirroring destination ports.

Overview

Feature	Description
PVLAN Layer-2 Isolation and IP Address Saving	Ports of different PVLAN types can be configured to implement interworking and isolation of VLAN intermediate user hosts. After Layer-2 mapping is performed between a primary VLAN and secondary VLANs, only Layer-2 communication is supported. If Layer-3 communication is required, users in a secondary VLAN need to use SVIs of the primary VLAN to make Layer-3 communication.

31.3.1PVLAN Layer-2 Isolation and IP Address Saving

Add users to subdomains of PVLAN to isolate communication between enterprises and between enterprise users.

Working Principle

Configure PVLAN, configure Layer-2 association and Layer-3 association between a primary VLAN and SubVLANs of PVLAN, and configure ports connected to user hosts, external network devices, and servers as different types of PVLAN ports. In this way, subdomain division and communication of users in subdomains with the external network and servers can be implemented.

↘ **Packet Forwarding Relationship Between Ports of Different Types**

Output Port Input Port	Promiscuous Port	Isolated Port	Community Port	Isolated Trunk Port (in the Same VLAN)	Promiscuous Trunk Port (in the Same VLAN)	Trunk Port (in the Same VLAN)
Promiscuous Port	Supported	Supported	Supported	Supported	Supported	Supported
Isolated Port	Supported	Unsupported	Unsupported	Unsupported	Supported	Supported
Community Port	Supported	Unsupported	Supported	Supported	Supported	Supported

↘ **VLAN Tag Changes After Packet Forwarding Between Ports of Different Types**

Output Port Input Port	Promiscuous Port	Isolated Port	Community Port	Isolated Trunk Port (in the Same VLAN)	Promiscuous Trunk Port (in the Same VLAN)	Trunk Port (in the Same VLAN)
Promiscuous Port	Unchanged	Unchanged	Unchanged	A secondary VLAN ID is added.	A primary VLAN ID tag is added and the VLAN tag keeps unchanged in the non-PVLAN.	A primary VLAN ID tag is added.
Isolated Port	Unchanged	NA	NA	NA	A primary VLAN ID tag is added and the VLAN tag keeps unchanged in the non-PVLAN.	An isolated VLAN ID tag is added.
Community Port	Unchanged	NA	Unchanged	A community VLAN ID tag is added.	A primary VLAN ID tag is added and the VLAN tag keeps unchanged in the non-PVLAN.	A community VLAN ID tag is added.
Switch CPU	Untag	Untag	Untag	A secondary VLAN ID tag is added.	A primary VLAN ID tag is added and the VLAN tag keeps unchanged in the non-PVLAN.	A primary VLAN ID tag is added.

31.4 Configuration

Configuration	Description and Command
Configuring Basic Functions of PVLAN	(Mandatory) It is used to configure a primary VLAN and secondary VLANs.
	private-vlan {community isolated primary} Configures the PVLAN type.
	(Mandatory) It is used to configure Layer-2 association between a primary VLAN and secondary VLANs of PVLAN to form PVLAN pairs.
	private-vlan association {svlist add svlist remove svlist} Configures Layer-2 association between a primary VLAN and secondary VLANs to form PVLAN pairs.
	(Optional) It is used to allocate users to an isolated VLAN or community VLAN.
	switchport mode private-vlan host Configures a PVLAN host port.
	switchport private-vlan host-association p_vid s_vid Associates Layer-2 ports with PVLAN and allocates ports to subdomains.
	(Optional) It is used to configure a port as a promiscuous port.
	Switchport mode private-vlan promiscuous Configures a PVLAN promiscuous port.
	switchport private-vlan mapping p_vid { svlist add svlist remove svlist } Configures the primary VLAN to which a PVLAN promiscuous port belongs and a list of secondary VLANs. PVLAN packets can be transmitted or received through this port only after the configuration is performed.
(Optional) It is used to configure Layer-3 communication for users in a secondary VLAN.	
private-vlan mapping { svlist add svlist remove svlist } Configures the SVI of the primary VLAN and configures Layer-3 association between the primary VLAN and secondary VLANs after PVLAN is created and Layer-2 association is performed. Users in a SubVLAN can make Layer-3 communication through the SVI of the primary VLAN.	

31.4.1 Configuring Basic Functions of PVLAN

Configuration Effect

- Enable PVLAN subdomains to form to implement isolation between enterprises and between enterprise users.
- Implement Layer-3 mapping between multiple secondary VLANs and the primary VLAN so that and multiple VLANs uses the same IP gateway, thereby helping save IP addresses.

Notes

- After a primary VLAN and a secondary VLAN are configured, a PVLAN subdomain exist only after Layer-2 association is performed between them.
- A port connected to a use host must be configured as a specific PVLAN port so that the user host joins a subdomain to implement the real user isolation.
- The port connected to the external network and the port connected to a server must be configured as promiscuous ports so that upstream and downstream packets are forwarded normally.

- Users in a secondary VLAN can make Layer-3 communication through the SVI of the primary VLAN only after Layer-3 mapping is performed between the secondary VLAN and the primary VLAN.

Configuration Steps

▾ **Configuring PVLAN**

- Mandatory.
- A primary VLAN and a secondary VLAN must be configured. The two types of VLANs cannot exist independently.
- Run the **private-vlan { community | isolated | primary }** command to configure a VLAN as the primary VLAN of PVLAN and other VLANs as secondary VLANs.

Command	private-vlan { community isolated primary }
Parameter Description	<p>community: Specifies that the VLAN type is community VLAN.</p> <p>isolated: Specifies that the VLAN type is isolated VLAN.</p> <p>primary: Specifies that the VLAN type is the primary VLAN of a PVLAN pair.</p>
Defaults	VLANs are common VLANs and do not have the attributes of PVLAN.
Command Mode	VLAN mode
Usage Guide	This command is used to specify the primary VLAN and secondary VLANs of PVLAN.

▾ **Configuring Layer-2 Association of PVLAN**

- Mandatory.
- PVLAN subdomains form, and isolated ports, community ports, and Layer-3 association can be configured only after Layer-2 association is performed between the primary VLAN and secondary VLANs of PVLAN.
- By default, after various PVLANS are configured, the primary VLANs and secondary VLANs are independent of each other. A primary VLAN has a secondary VLAN and a secondary VLAN has a primary VLAN only after Layer-2 association is performed.
- Run the **private-vlan association { svlist | add svlist | remove svlist }** command to configure or cancel the Layer-2 association between the primary VLAN and secondary VLANs of PVLAN. A PVLAN subdomain forms only after Layer-2 association is configured. The PVLAN subdomain does not exist after Layer-2 association is cancelled. If Layer-2 association is not performed, when isolated ports and promiscuous ports are used to configure associated PVLAN pairs, the configuration will fail or the association between ports and VLANs will be cancelled.

Command	private-vlan association { svlist add svlist remove svlist }
Parameter Description	<p><i>svlist</i>: Specifies the list of secondary VLANs to be associated or disassociated.</p> <p>add svlist: Adds the secondary VLANs to be associated.</p> <p>remove svlist: Cancels the association between <i>svlist</i> and the primary VLAN.</p>
Defaults	By default, the primary VLAN and secondary VLANs are not associated.
Command Mode	Primary VLAN mode of PVLAN
Usage Guide	<p>This command is used to configure Layer-2 association between a primary VLAN and secondary VLANs to form PVLAN pairs.</p> <p>Each primary VLAN can be associated with only one isolated VLAN but can be associated with multiple community</p>

	VLANs.
--	--------

➤ **Configuring Layer-3 Association of PVLAN**

- If users in a secondary VLAN domain needs to make Layer-3 communication, configure a Layer-3 interface SVI for the primary VLAN and then configure Layer-3 association between the primary VLAN and secondary VLANs on the SVI.
- By default, SVIs can be configured only in a primary VLAN. Secondary VLANs do not support Layer-3 communication.
- If users in a secondary VLAN of PVLAN need to make Layer-3 communication, the SVI of the primary VLAN needs to be used to transmit and receive packets.
- Run the **private-vlan mapping** { *svlist* | **add** *svlist* | **remove** *svlist* } command to configure or cancel the Layer-3 association between the primary VLAN and secondary VLANs of PVLAN. Users in a secondary VLAN can make Layer-3 communication with the external network only after Layer-3 association is configured. After Layer-3 association is cancelled, users in a secondary VLAN cannot make Layer-3 communication.

Command	private-vlan mapping { <i>svlist</i> add <i>svlist</i> remove <i>svlist</i> }
Parameter Description	<i>svlist</i> : Indicates the list of secondary VLANs, for which Layer-3 mapping needs to be configured. add <i>svlist</i> : Adds the secondary VLANs to be associated with a Layer-3 interface. remove <i>svlist</i> : Cancels the secondary VLANs associated with a Layer-3 interface.
Defaults	By default, the primary VLAN and secondary VLANs are not associated.
Command Mode	Interface configuration mode of the primary VLAN
Usage Guide	A Layer-3 SVI must be configured for the primary VLAN first. Layer-3 interfaces can be configured only in a primary VLAN. Layer-2 association must be performed between associated secondary VLANs and the primary VLAN.

➤ **Configuring Isolated Ports and Community Ports**

- After the primary VLAN and secondary VLANs of PVLAN as well as Layer-2 association are configured, allocate the device ports connected to user hosts so as to specify the subdomains to which the user hosts belong.
- If an enterprise has only one user host, set the port connected to the user host as an isolated port.
- If an enterprise has multiple user hosts, set the ports connected to the user hosts as community ports.

Command	switchport mode private-vlan host switchport private-vlan host-association <i>p_vid</i> <i>s_vid</i>
Parameter Description	<i>p_vid</i> : Indicates the primary VLAN ID in a PVLAN pair. <i>s_vid</i> : Indicates the secondary VLAN ID in a PVLAN pair. The port is an associated port if the VLAN is an isolated VLAN and the port is a community port if the VLAN is a community VLAN.
Defaults	By default, the interface works in Access mode; no private VLAN pairs are associated.
Command Mode	Both commands run in interface configuration mode.
Usage Guide	Both the preceding commands need to be configured. Before a port is configured as an isolated port or promiscuous port, and the port mode must be configured as the host port mode. Whether a port is configured as an isolated port or community port depends on the <i>s_vid</i> parameter.

	<p><i>p_vid</i> and <i>s_vid</i> must be respectively the IDs of the primary VLAN and secondary VLAN in a PVLAN pair, on which Layer-2 association is performed.</p> <p>One host port can be associated with only one PVLAN pair.</p>
--	---

➤ **Configuring a Promiscuous Port**

- According to the table listing port packet transmission and receiving rules in section "Features", the single port type of PVLAN cannot ensure symmetric forwarding of upstream and downstream packets. Ports for connecting to the external network or server need to be configured as promiscuous ports to ensure that users can successfully access the external network or server.

Command	<p>switchport mode private-vlan promiscuous</p> <p>switchport private-vlan mapping p_vid { svlist add svlist remove svlist }</p>
Parameter Description	<p><i>p_vid</i>: Indicates the primary VLAN ID in a PVLAN pair.</p> <p><i>svlist</i>: Indicates the secondary VLAN associated with a promiscuous port. Layer-2 association must be performed between it and <i>p_vid</i>.</p> <p>add svlist: Adds a secondary VLAN to be associated with a port.</p> <p>remove svlist: Cancels the secondary VLAN associated with a port.</p>
Defaults	By default, an interface works in Access mode; a promiscuous port is not associated with a secondary VLAN.
Command Mode	Interface configuration mode
Usage Guide	<p>The port mode must be configured as the promiscuous mode.</p> <p>If a port is configured as a promiscuous port, it must be associated with PVLN pairs. Otherwise, the port cannot bear or forward services.</p> <p>One promiscuous port can be associated with multiple PVLAN pairs within one primary VLAN but cannot be associated with multiple primary VLANs.</p>

Verification

Make user hosts connected to PVLAN ports transmit and receive packets as per PVLAN port forwarding rules to implement isolation. Configure Layer-3 association to make users in the primary VLAN and secondary VLANs of the same PVLAN to share the same gateway IP address and make Layer-3 communication.

Configuration Example

➤ **Cross-Device Layer-2 Application of PVLAN**

Figure 9- 3

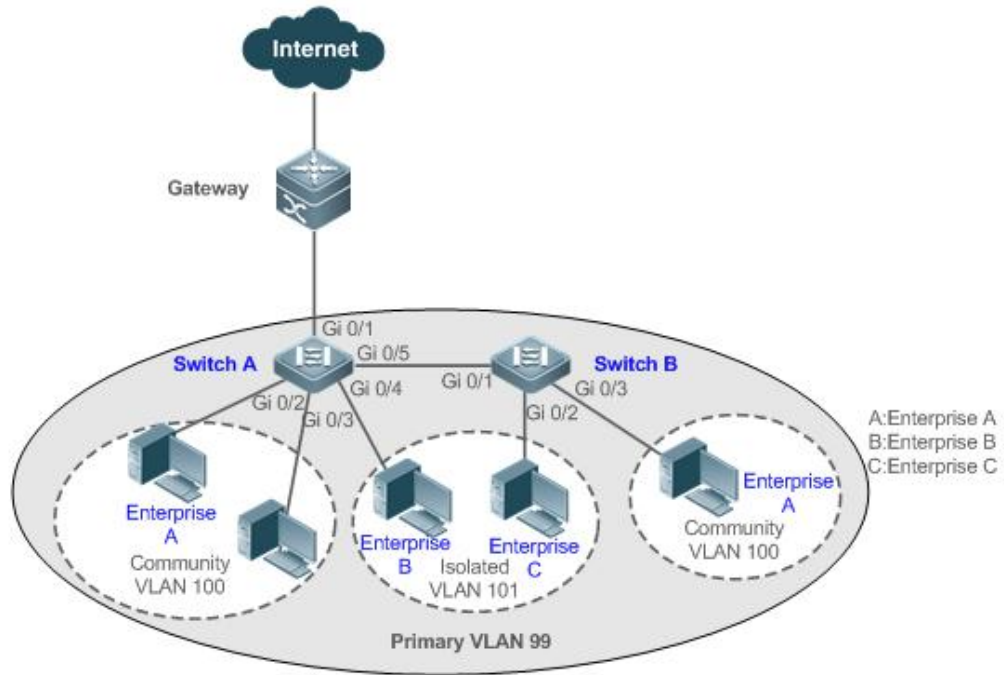

Configuration Steps

- Configure all enterprises to be in the same PVLAN (primary VLAN 99 in this example). All enterprise users share the same Layer-3 interface through this VLAN to communicate with the external network.
- If an enterprise has multiple user hosts, allocate each enterprise to a different community VLAN (in this example, allocate Enterprise A to Community VLAN 100) to implement user communication inside an enterprise and isolate user communication between enterprises.
- If an enterprise has only one user host, allocate such enterprises to the same isolated VLAN (in this example, allocate Enterprise B and Enterprise C to Isolated VLAN 101) to isolate user communication between enterprises.

A

```
SwitchA#configure terminal
Enter configuration commands, one per line. End with CNTL/Z.
SwitchA(config)#vlan 99
SwitchA(config-vlan)#private-vlan primary
SwitchA(config-vlan)#exit
SwitchA(config)#vlan 100
SwitchA(config-vlan)#private-vlan community
SwitchA(config-vlan)#exit
SwitchA(config)#vlan 101
SwitchA(config-vlan)#private-vlan isolated
SwitchA(config-vlan)#exit
SwitchA(config)#vlan 99
SwitchA(config-vlan)#private-vlan association 100-101
SwitchA(config-vlan)#exit
```

	<pre>SwitchA(config)#interface range gigabitEthernet 0/2-3 SwitchA(config-if-range)#switchport mode private-vlan host SwitchA(config-if-range)#switchport private-vlan host-association 99 100 SwitchA(config-if-range)#exit SwitchA(config)#interface gigabitEthernet 0/4 SwitchA(config-if-GigabitEthernet 0/4)#switchport mode private-vlan host SwitchA(config-if-GigabitEthernet 0/4)#switchport private-vlan host-association 99 101</pre>
<p>B</p>	<pre>SwitchB#configure terminal Enter configuration commands, one per line. End with CNTL/Z. SwitchB(config)#vlan 99 SwitchB(config-vlan)#private-vlan primary SwitchB(config-vlan)#exit SwitchB(config)#vlan 100 SwitchB(config-vlan)#private-vlan community SwitchB(config-vlan)#exit SwitchB(config)#vlan 101 SwitchB(config-vlan)#private-vlan isolated SwitchB(config-vlan)#exit SwitchB(config)#vlan 99 SwitchB(config-vlan)#private-vlan association 100-101 SwitchB(config-vlan)#exit SwitchB(config)#interface gigabitEthernet 0/2 SwitchB(config-if-GigabitEthernet 0/2)#switchport mode private-vlan host SwitchB(config-if-GigabitEthernet 0/2)# switchport private-vlan host-association 99 101 SwitchB(config-if-GigabitEthernet 0/2)#exit SwitchB(config)#interface gigabitEthernet 0/3 SwitchB(config-if-GigabitEthernet 0/3)#switchport mode private-vlan host SwitchB(config-if-GigabitEthernet 0/3)# switchport private-vlan host-association 99 100 SwitchB(config-if-GigabitEthernet 0/3)#exit</pre>
<p>Verification</p>	<p>Check whether VLANs and ports are correctly configured, and check whether packet forwarding is correct according to packet forwarding rules in section "Features".</p>
<p>A</p>	<pre>SwitchA#show running-config !</pre>

	<pre>vlan 99 private-vlan primary private-vlan association add 100-101 ! vlan 100 private-vlan community ! vlan 101 private-vlan isolated ! interface GigabitEthernet 0/1 switchport mode private-vlan promiscuous switchport private-vlan mapping 99 add 100-101 ! interface GigabitEthernet 0/2 switchport mode private-vlan host switchport private-vlan host-association 99 100 ! interface GigabitEthernet 0/3 switchport mode private-vlan host switchport private-vlan host-association 99 100 ! interface GigabitEthernet 0/4 switchport mode private-vlan host switchport private-vlan host-association 99 101 !</pre>
B	<pre>SwitchB#show running-config ! vlan 99 private-vlan primary private-vlan association add 100-101 ! vlan 100 private-vlan community</pre>

```
!
vlan 101
private-vlan isolated
!
```

Common Errors

- Layer-2 association is not performed between the primary VLAN and secondary VLANs of PVLAN, and a port VLAN list fails to be added when isolated ports, promiscuous ports, and community ports are configured.
- One host port fails to be associated with multiple PVLAN pairs.

Configuration Example

📌 **Layer-3 Application of PVLAN on a Single Device**

<p>Figure 9- 4</p>	<p>The diagram illustrates a network topology where a central Switch A is connected to an Internet cloud. Switch A has several ports: port 1 is connected to the Internet; port 7 is connected to a Server; ports 2, 3, 4, and 5 are connected to Enterprise A, B, C, and D respectively. Enterprise A and B are connected to a Community VLAN 10, Enterprise B is connected to a Community VLAN 20, and Enterprise C and D are connected to an Isolated VLAN 30. A legend on the right identifies the Enterprise groups: A:Enterprise A, B:Enterprise B, C:Enterprise C, D:Enterprise D. The primary VLAN 2 on Switch A has an SVI address of 192.168.1.1/24.</p>
<p>Configuration Steps</p>	<ul style="list-style-type: none"> ● Configure the PVLAN function on the device (Switch A in this example). For details about the configuration, see configuration tips in "Cross-Device Layer-2 Application of PVLAN." ● Set the port that is directly connected to the server (Port Gi 0/7 in this example) as a promiscuous port. Then, all enterprise users can communicate with the server through the promiscuous port. ● Configure the gateway address of PVLAN on the Layer-3 device (Switch A in this example) (in this example, set the SVI address of VLAN 2 to 192.168.1.1/24) and configure the Layer-3 interface mapping between the primary VLAN (VLAN 2 in this example) and secondary VLANs (VLAN 10, VLAN 20, and VLAN 30 in this example). Then, all enterprise users can communicate with the external network through the gateway address.
<p>A</p>	<pre>SwitchA#configure terminal Enter configuration commands, one per line. End with CNTL/Z. SwitchA(config)#vlan 2 SwitchA(config-vlan)#private-vlan primary</pre>

```
SwitchA(config-vlan)#exit
SwitchA(config)#vlan 10
SwitchA(config-vlan)#private-vlan community
SwitchA(config-vlan)#exit
SwitchA(config)#vlan 20
SwitchA(config-vlan)#private-vlan community
SwitchA(config-vlan)#exit
SwitchA(config)#vlan 30
SwitchA(config-vlan)#private-vlan isolated
SwitchA(config-vlan)#exit
SwitchA(config)#vlan 2
SwitchA(config-vlan)#private-vlan association 10,20,30
SwitchA(config-vlan)#exit
SwitchA(config)#interface range gigabitEthernet 0/1-2
SwitchA(config-if-range)#switchport mode private-vlan host
SwitchA(config-if-range)#switchport private-vlan host-association 2 10
SwitchA(config-if-range)#exit
SwitchA(config)#interface range gigabitEthernet 0/3-4
SwitchA(config-if-range)#switchport mode private-vlan host
SwitchA(config-if-range)#switchport private-vlan host-association 2 20
SwitchA(config-if-range)#exit
SwitchA(config)#interface range gigabitEthernet 0/5-6
SwitchA(config-if-range)#switchport mode private-vlan host
SwitchA(config-if-range)#switchport private-vlan host-association 2 30
SwitchA(config-if-range)#exit
SwitchA(config)#interface gigabitEthernet 0/7
SwitchA(config-if-GigabitEthernet 0/7)#switchport mode private-vlan promiscuous
SwitchA(config-if-GigabitEthernet 0/7)#switchport private-vlan mapping 2 10,20,30
SwitchA(config-if-GigabitEthernet 0/7)#exit
SwitchA(config)#interface vlan 2
SwitchA(config-if-VLAN 2)#ip address 192.168.1.1 255.255.255.0
SwitchA(config-if-VLAN 2)#private-vlan mapping 10,20,30
SwitchA(config-if-VLAN 2)#exit
```

Verification	Ping the gateway address 192.168.1.1 from user hosts in different subdomains. The ping operation is successful.
A	<pre>SwitchA#show running-config ! vlan 2 private-vlan primary private-vlan association add 10,20,30 ! vlan 10 private-vlan community ! vlan 20 private-vlan community ! vlan 30 private-vlan isolated ! interface GigabitEthernet 0/1 switchport mode private-vlan host switchport private-vlan host-association 2 10 ! interface GigabitEthernet 0/2 switchport mode private-vlan host switchport private-vlan host-association 2 10 ! interface GigabitEthernet 0/3 switchport mode private-vlan host switchport private-vlan host-association 2 20 ! interface GigabitEthernet 0/4 switchport mode private-vlan host switchport private-vlan host-association 2 20 ! interface GigabitEthernet 0/5</pre>

```

switchport mode private-vlan host
switchport private-vlan host-association 2 30
!
interface GigabitEthernet 0/6
switchport mode private-vlan host
switchport private-vlan host-association 2 30
!
interface GigabitEthernet 0/7
switchport mode private-vlan promiscuous
switchport private-vlan mapping 2 add 10,20,30
!
interface VLAN 2
no ip proxy-arp
ip address 192.168.1.1 255.255.255.0
private-vlan mapping add 10,20,30
!
SwitchA#show vlan private-vlan
VLAN  Type   Status  Routed  Ports  Associated VLANs
-----
2     primary active  Enabled Gi0/7   10,20,30
10    community active  Enabled Gi0/1, Gi0/2  2
20    community active  Enabled Gi0/3, Gi0/4  2
30    isolated active  Enabled Gi0/5, Gi0/6  2
    
```

Common Errors

- No Layer-2 association is performed on the primary VLAN and secondary VLANs of PVLAN and the Layer-3 association fails to be configured.
- The device is connected to the external network before Layer-3 association is configured. As a result, the device cannot communicate with the external network.
- The interfaces for connecting to the server and the external network are not configured as promiscuous interfaces, which results in asymmetric forwarding of upstream and downstream packets.

31.5 Monitoring

Displaying

Description	Command
Displays PVLAN configuration.	show vlan private-vlan

Debugging

 System resources are occupied when debugging information is output. Therefore, disable debugging immediately after use.

Description	Command
Debugs PVLAN.	debug bridge pvlan

32 Configuring MSTP

32.1 Overview

Spanning Tree Protocol (STP) is a Layer-2 management protocol. It cannot only selectively block redundant links to eliminate Layer-2 loops but also can back up links.

Similar to many protocols, STP is continuously updated from Rapid Spanning Tree Protocol (RSTP) to Multiple Spanning Tree Protocol (MSTP) as the network develops.

For the Layer-2 Ethernet, only one active link can exist between two local area networks (LANs). Otherwise, a broadcast storm will occur. To enhance the reliability of a LAN, it is necessary to establish a redundant link and keep some paths in backup state. If the network is faulty and a link fails, you must switch the redundant link to the active state. STP can automatically activate the redundant link without any manual operations. STP enables devices on a LAN to:

- Discover and start the best tree topology on the LAN.
- Troubleshoot a fault and automatically update the network topology so that the possible best tree topology is always selected.

The LAN topology is automatically calculated based on a set of bridge parameters configured by the administrator. The best topology tree can be obtained by properly configuring these parameters.

RSTP is completely compatible with 802.1D STP. Similar to traditional STP, RSTP provides loop-free and redundancy services. It is characterized by rapid speed. If all bridges in a LAN support RSTP and are properly configured by the administrator, it takes less than 1 second (about 50 seconds if traditional STP is used) to re-generate a topology tree after the network topology changes.

STP and RSTP have the following defects:

- STP migration is slow. Even on point-to-point links or edge ports, it still takes two times of the forward delay for ports to switch to the forwarding state.
- RSTP can rapidly converge but has the same defect with STP: Since all VLANs in a LAN share the same spanning tree, packets of all VLANs are forwarded along this spanning tree. Therefore, redundant links cannot be blocked according to specific VLANs and data traffic cannot be balanced among VLANs.

MSTP, defined by the IEEE in 802.1s, resolves defects of STP and RSTP. It cannot only rapidly converge but also can enable traffic of different VLANs to be forwarded along respective paths, thereby providing a better load balancing mechanism for redundant links.

In general, STP/RSTP works based on ports while MSTP works based on instances. An instance is a set of multiple VLANs. Binding multiple VLANs to one instance can reduce the communication overhead and resource utilization.

FS devices support STP, RSTP, and MSTP, and comply with IEEE 802.1D, IEEE 802.1w, and IEEE 802.1s.

Protocols and Standards

- IEEE 802.1D: Media Access Control (MAC) Bridges
- IEEE 802.1w: Part 3: Media Access Control (MAC) Bridges—Amendment 2: Rapid Reconfiguration
- IEEE 802.1s: Virtual Bridged Local Area Networks—Amendment 3: Multiple Spanning Trees

32.2 Applications

Application	Description
<u>MSTP+VRRP Dual-Core Topology</u>	With a hierarchical network architecture model, the MSTP+VRRP mode is used to implement redundancy and load balancing to improve system availability of the network.
<u>BPDU Tunnel</u>	In QinQ network environment, Bridge Protocol Data Unit (BPDU) Tunnel is used to implement tunnel-based transparent transmission of STP packets.

32.2.1 MSTP+VRRP Dual-Core Topology

Scenario

The typical application of MSTP is the MSTP+VRRP dual-core solution. This solution is an excellent solution to improve system availability of the network. Using a hierarchical network architecture model, it is generally divided into three layers (core layer, convergence layer, and access layer) or two layers (core layer and access layer). They form the core network system to provide data exchange service.

The main advantage of this architecture is its hierarchical structure. In the hierarchical network architecture, all capacity indicators, characteristics, and functions of network devices at each layer are optimized based on their network locations and roles, enhancing their stability and availability.

Figure 10- 1 MSTP+VRRP Dual-Core Topology

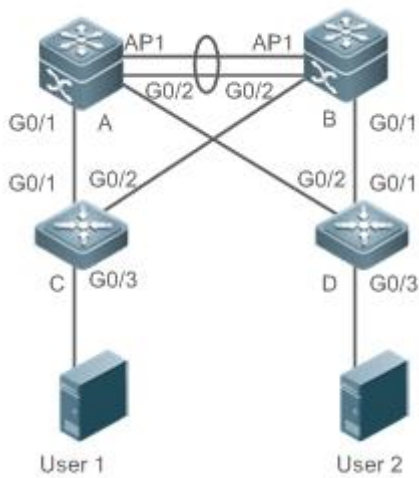

Remarks	The topology is divided into two layers: core layer (Devices A and B) and access layer (Devices C and D).
----------------	---

Deployment

- Core layer: Multiple MSTP instances are configured to realize load balancing. For example, two instances are created: Instance 1 and Instance 2. Instance 1 maps VLAN 10 while Instance 2 maps VLAN 20. Device A is the root bridge of Instances 0 and 1 (Instance 0 is CIST, which exists by default). Device B is the root bridge of Instance 2.
- Core layer: Devices A and B are the active VRRP devices respectively on VLAN 10 and VLAN 20.
- Access layer: Configure the port directly connected to the terminal (PC or server) as a PortFast port, and enable BPDU guard to prevent unauthorized users from accessing illegal devices.

32.2.2BPDU Tunnel

Scenario

The QinQ network is generally divided into two parts:customer network and service provider (SP) network. You can enable BPDU Tunnel to calculate STP packets of the customer network independently of the SP network, thereby preventing STP packets between the customer network from affecting the SP network.

Figure 10- 2 BPDU Tunnel Topology

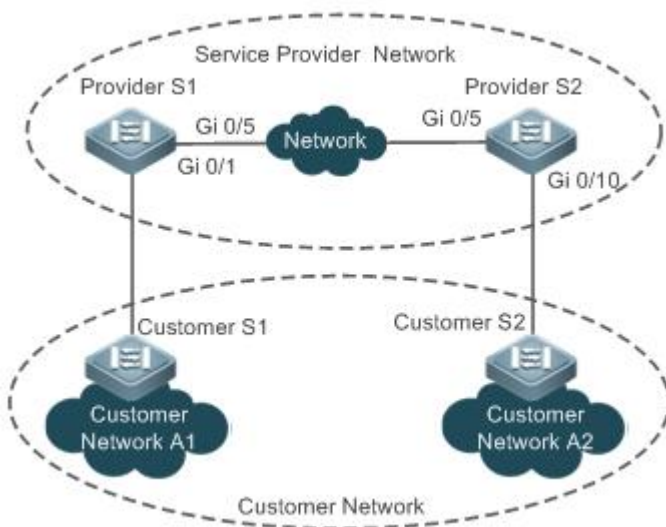

<p>Remarks</p>	<p>As shown in the above figure, the upper part is the SP network and the lower part is the customer network. The SP network consists of two provider edges (PEs): Provider S1 and Provider S2. Customer Network A1 and Customer Network A2 are a user's two sites in different regions. Customer S1 and Customer S2, access devices from the customer network to the SP network, access the SP network respectively through Provider S1 and Provider S2.</p> <p>Using BPDU Tunnel, Customer Network A1 and Customer Network A2 in different regions can perform unified spanning tree calculation across the SP network, not affecting the spanning tree calculation of the SP network.</p>
-----------------------	--

Deployment

- Enable basic QinQ on the PEs (Provider S1/Provider S2 in this example) so that data packets of the customer network are transmitted within the specified VLAN on the SP network.
- Enable STP transparent transmission on the PEs (Provider S1/Provider S2 in this example) so that the SP network can transmit STP packets of the customer network through BPDU Tunnel.

32.3 Features

Basic Concepts

↳ BPDU

To generate a stable tree topology network, the following conditions must be met:

- Each bridge has a unique ID consisting of the bridge priority and MAC address.
- The overhead of the path from the bridge to the root bridge is called root path cost.
- A port ID consists of the port priority and port number.

Bridges exchange BPDU packets to obtain information required for establishing the best tree topology. These packets use the multicast address 01-80-C2-00-00-00 (hexadecimal) as the destination address.

A BPDU consists of the following elements:

- Root bridge ID assumed by the local bridge
- Root path cost of the local bridge
- Bridge ID (ID of the local bridge)
- Message age (age of a packet)
- Port ID (ID of the port sending this packet)
- **Forward-Delay Time, Hello Time, Max-Age Time** are time parameters specified in the MSTP.
- Other flags, such as flags indicating network topology changes and local port status.

If a bridge receives a BPDU with a higher priority (smaller bridge ID and lower root path cost) at a port, it saves the BPDU information at this port and transmits the information to all other ports. If the bridge receives a BPDU with a lower priority, it discards the information.

Such a mechanism allows information with higher priorities to be transmitted across the entire network. BPDU exchange results are as follows:

- A bridge is selected as the root bridge.
- Except the root bridge, each bridge has a root port, that is, a port providing the shortest path to the root bridge.
- Each bridge calculates the shortest path to the root bridge.
- Each LAN has a designated bridge located in the shortest path between the LAN and the root bridge. A port designated to connect the bridge and the LAN is called designated port.
- The root port and designated port enter the forwarding status.

↳ Bridge ID

According to IEEE 802.1W, each bridge has a unique ID. The spanning tree algorithm selects the root bridge based on the bridge ID. The bridge ID consists of eight bytes, of which the last six bytes are the MAC address of the bridge. In its first two bytes (as listed in the following table), the first four bits indicate the priority; the last eight bits indicate the system ID for use in extended protocol. In RSTP, the system ID is 0. Therefore, the bridge priority should be an integral multiple of 4,096.

	Bit	Value
Priority value	16	32,768

	15	16,384
	14	8,192
	13	4,096
System ID	12	2,048
	11	1,024
	10	512
	9	256
	8	128
	7	64
	6	32
	5	16
	4	8
	3	4
	2	2
	1	1

➤ **Spanning-Tree Timers**

The following three timers affect the performance of the entire spanning tree:

- Hello timer: Interval for periodically sending a BPDU packet.
- Forward-Delay timer: Interval for changing the port status, that is, interval for a port to change from the listening state to the learning state or from the learning state to the forwarding state when RSTP runs in STP-compatible mode.
- Max-Age timer: The longest time-to-live (TTL) of a BPDU packet. When this timer elapses, the packet is discarded.

➤ **Port Roles and Port States**

Each port plays a role on a network to reflect different functions in the network topology.

- Root port: Port providing the shortest path to the root bridge.
- Designated port: Port used by each LAN to connect the root bridge.
- Alternate port: Alternative port of the root port. Once the root port loses effect, the alternate port immediately changes to the root port.
- Backup port: Backup port of the designated port. When a bridge has two ports connected to a LAN, the port with the higher priority is the designated port while the port with the lower priority is the backup port.
- Disabled port: Inactive port. All ports with the operation state being down play this role.

The following figures show the roles of different ports:

R = Root port D = Designated port A = Alternate port B = Backup port

Unless otherwise specified, port priorities decrease from left to right.

Figure 10- 3

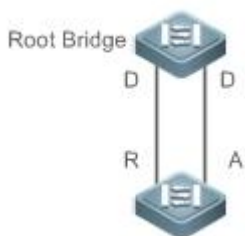

Figure 10- 4

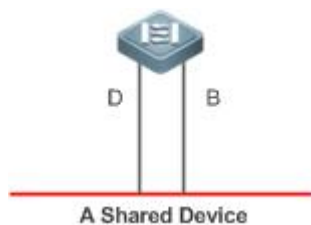
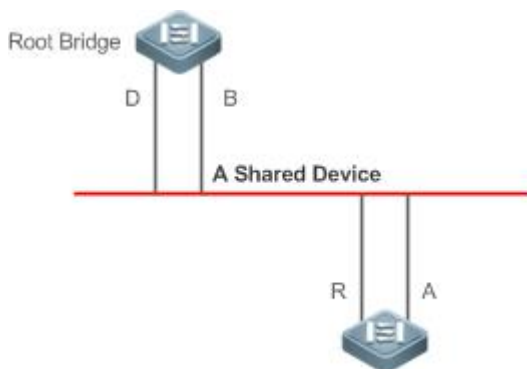

Figure 10- 5



Each port has three states indicating whether to forward data packets so as to control the entire spanning tree topology.

- Discarding: Neither forwards received packets nor learns the source MAC address.
- Learning: Does not forward received packets but learns the source MAC address, which is a transitive state.
- Forwarding: Forwards received packets and learns the source MAC address.

For a stable network topology, only the root port and designated port can enter the forwarding state while other ports are always in discarding state.

🔽 **Hop Count**

Internal spanning trees (ISTs) and multiple spanning tree instances (MSTIs) calculate whether the BPDU packet time expires based on an IP TTL-alike mechanism Hop Count, instead of Message Age and Max Age.

It is recommended to run the **spanning-tree max-hops** command in global configuration mode to configure the hop count. In a region, every time a BPDU packet passes through a device from the root bridge, the hop count decreases by 1. When the hop count becomes 0, the BPDU packet time expires and the device discards the packet.

To be compatible with STP and RSTP outside the region, MSTP also retains the Message Age and Max Age mechanisms.

Overview

Feature	Description
STP	STP, defined by the IEEE in 802.1D, is used to eliminate physical loops at the data link layer in a LAN.
RSTP	RSTP, defined by the IEEE in 802.1w, is optimized based on STP to rapidly converge the network topology.
MSTP	MSTP, defined by the IEEE in 802.1s, resolves defects of STP, RSTP, and Per-VLAN Spanning Tree (PVST). It cannot only rapidly converge but also can forward traffic of different VLANs along respective paths, thereby providing a better load balancing mechanism for redundant links.
MSTP Optical Features	MSTP includes the following features: PortFast, BPDU guard, BPDU filter, TC protection, TC guard, TC filter, BPDU check based on the source MAC address, BPDU filter based on the illegal length, Auto Edge, root guard, and loop guard.

32.3.1STP

STP is used to prevent broadcast storms incurred by loops and provide link redundancy.

Working Principle

For the Layer-2 Ethernet, only one active link can exist between two LANs. Otherwise, a broadcast storm will occur. To enhance the reliability of a LAN, it is necessary to establish a redundant link and keep some paths in backup state. If the network is faulty and a link fails, you must switch the redundant link to the active state. STP can automatically activate the redundant link without any manual operations. STP enables devices on a LAN to:

- Discover and start the best tree topology on the LAN.
- Troubleshoot a fault and automatically update the network topology so that the possible best tree topology is always selected.

The LAN topology is automatically calculated based on a set of bridge parameters configured by the administrator. The best topology tree can be obtained by properly configuring these parameters.

Related Configuration

📌 Enabling spanning-tree

- By default, the spanning-tree function is disabled.
- Run the **spanning-tree [forward-time seconds | hello-time seconds | max-age seconds]** command to enable STP and configure basic attributes.
- The forward-time ranges from 4 to 30. The hello-time ranges from 1 to 10. The max-age ranges from 6 to 40.

⚠️ Running the **clear** commands may lose vital information and thus interrupt services. The value ranges of forward-time, hello-time, and max-age are related. If one of them is modified, the other two ranges are affected. The three values must meet the following condition: $2 \times (\text{Hello Time} + 1 \text{ second}) \leq \text{Max-Age Time} \leq 2 \times (\text{Forward-Delay Time} - 1 \text{ second})$. Otherwise, the configuration will fail.

32.3.2RSTP

RSTP is completely compatible with 802.1D STP. Similar to traditional STP, RSTP provides loop-free and redundancy services. It is characterized by rapid speed. If all bridges in a LAN support RSTP and are properly configured by the administrator, it takes less than 1 second (about 50 seconds if traditional STP is used) to re-generate a topology tree after the network topology changes.

Working Principle

Fast RSTP Convergence

RSTP has a special feature, that is, to make ports quickly enter the forwarding state.

STP enables a port to enter the forwarding state 30 seconds (two times of the Forward-Delay Time; the Forward-Delay Time can be configured, with a default value of 15 seconds) after selecting a port role. Every time the topology changes, the root port and designated port reselected by each bridge enter the forwarding state 30 seconds later. Therefore, it takes about 50 seconds for the entire network topology to become a tree.

RSTP differs greatly from STP in the forwarding process. As shown in Figure 10- 6, Switch A sends an RSTP Proposal packet to Switch B. If Switch B finds the priority of Switch A higher, it selects Switch A as the root bridge and the port receiving the packet as the root port, enters the forwarding state, and then sends an Agree packet from the root port to Switch A. If the designated port of Switch A is agreed, the port enters the forwarding state. Switch B's designated port resends a Proposal packet to extend the spanning tree by sequence. Theoretically, RSTP can recover the network tree topology to rapidly converge once the network topology changes.

Figure 10- 6

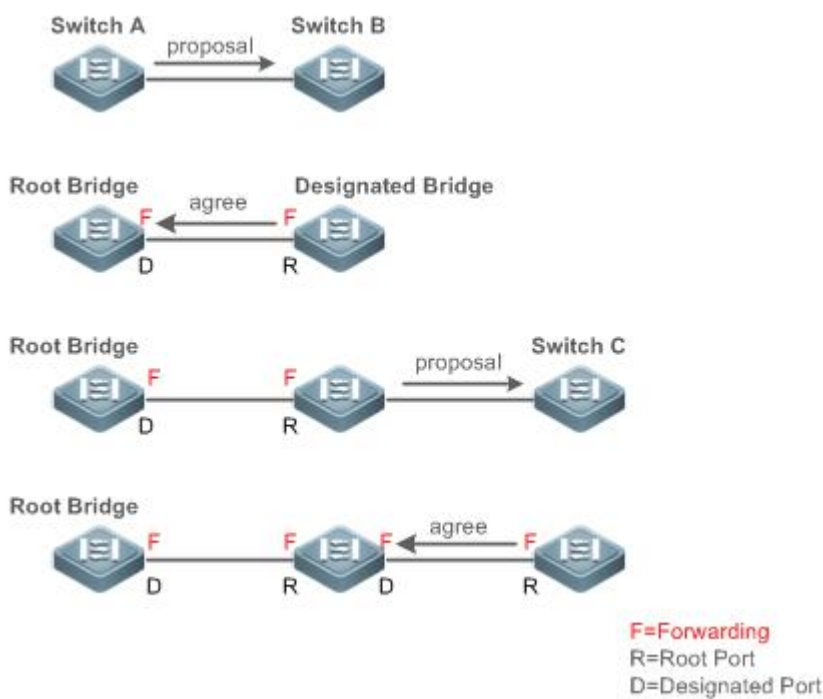

i The above handshake process is implemented only when the connection between ports is in point-to-point mode. To give the devices their full play, it is recommended not to enable point-to-point connection between devices.

Figure 10- 7 and Figure 10- 8 show the examples of non point-to-point connection.

Example of non point-to-point connection:

Figure 10- 7

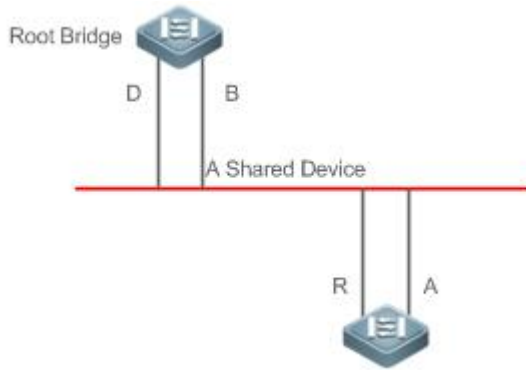

Figure 10-8

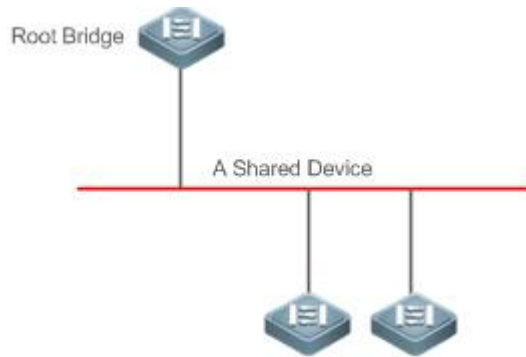
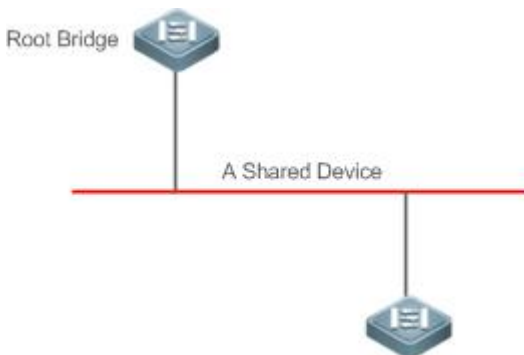

Figure 10-9 shows an example of point-to-point connection.

Figure 10-9



📌 **Compatibility Between RSTP and STP**

RSTP is completely compatible with STP. RSTP automatically checks whether the connected bridge supports STP or RSTP based on the received BPDU version number. If the port connects to an STP bridge, the port enters the forwarding state 30 seconds later, which cannot give RSTP its full play.

Another problem may occur when RSTP and STP are used together. As shown in the following figures, Switch A (RSTP) connects to Switch B (STP). If Switch A finds itself connected to an STP bridge, it sends an STP BPDU packet. However, if Switch B is replaced with Switch C (RSTP) but Switch A still sends STP BPDU packets, Switch C will assume itself connected to the STP bridge. As a result, two RSTP devices work under STP, greatly reducing the efficiency.

RSTP provides the protocol migration feature to forcibly send RSTP BPDU packets (the peer bridge must support RSTP). In this case, Switch A is enforced to send an RSTP BPDU and Switch C then finds itself connected to the RSTP bridge. As a result, two RSTP devices work under RSTP, as shown in Figure 10- 11.

Figure 10- 10

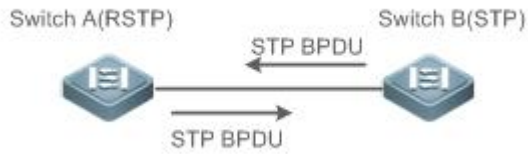
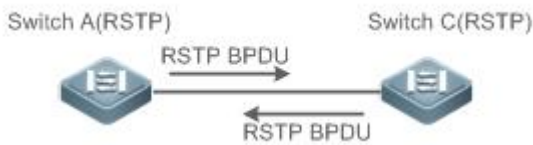

Figure 10- 11



Related Configuration

📌 **Configuring Protocol Migration**

- Run the **clear spanning-tree detected-protocols [interface interface-id]** command to enforce version check on a port. For details, see "Compatibility Between RSTP and STP".

32.3.3MSTP

MSTP resolves defects of STP and RSTP. It cannot only rapidly converge but also can forward traffic of different VLANs along respective paths, thereby providing a better load balancing mechanism for redundant links.

Working Principle

FS devices support MSTP. MSTP is a new spanning tree protocol developed from traditional STP and RSTP and includes the fast RSTP forwarding mechanism.

Since traditional spanning tree protocols are irrelevant to VLANs, problems may occur in specific network topologies:

As shown in Figure 10- 12, Devices A and B are in VLAN 1 while Devices C and D are in VLAN 2, forming a loop.

Figure 10- 12

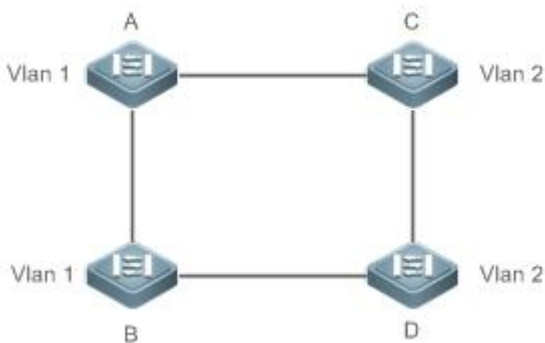

If the link from Device A to Device B through Devices C and D costs less than the link from Device A direct to Device B, the link between Device A and Device B enters the discarding state (as shown in Figure 10- 13). Since Devices C and D do not include VLAN 1 and cannot forward data packets of VLAN 1, VLAN 1 of Device A fails to communicate with VLAN 1 of Device B.

Figure 10- 13

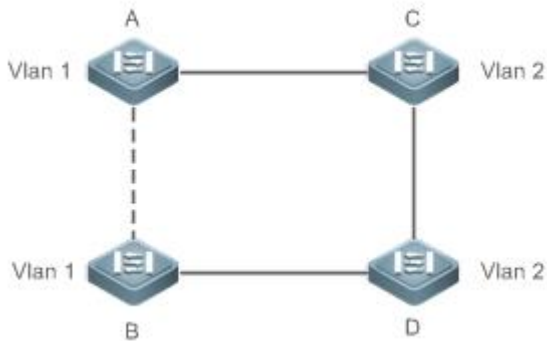

MSTP is developed to resolve this problem. It divides one or multiple VLANs of a device into an instance. Devices configured with the same instance form an MST region to run an independent spanning tree (called IST). This MST region, like a big device, implements the spanning tree algorithm with other MST regions to generate a complete spanning tree called common spanning tree (CST).

Based on this algorithm, the above network can form the topology shown in Figure 10- 14 under the MSTP algorithm: Devices A and B are in MSTP region 1 in which no loop occurs, and therefore no link enters the discarding state. This also applies to MSTP Region 2. Region 1 and Region 2, like two big devices having loops, select a link to enter the discarding state based on related configuration.

Figure 10- 14

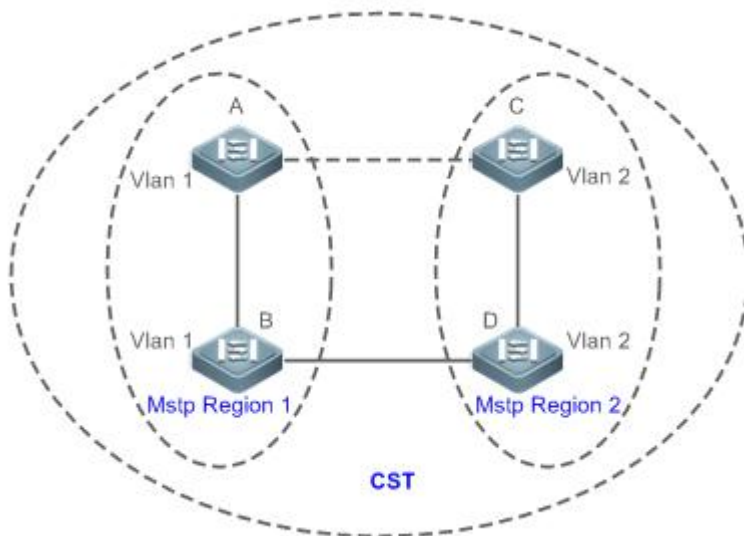

This prevents loops to ensure proper communication between devices in the same VLAN.

➤ MSTP Region Division

To give MSTP its due play, properly divide MSTP regions and configure the same MST configuration information for devices in the same MSTP region.

MST configuration information include:

- MST configuration name: Consists of at most 32 bytes to identify an MSTP region.
- MST Revision Number: Consists of 16 bits to identify an MSTP region.
- MST instance-VLAN mapping table: A maximum number of 64 instances (with their IDs ranging from 1 to 64) are created for each device and Instance 0 exists mandatorily. Therefore, the system supports a maximum number of 65 instances. Users can assign 1 to 4,994 VLANs belonging to different instances (ranging from 0 to 64) as required. Unassigned VLANs belong to Instance 0 by default. In this case, each MSTI is a VLAN group and implements the spanning tree algorithm of the MSTI specified in the BPDU packet, not affected by CIST and other MSTIs.

Run the **spanning-tree mst configuration** command in global configuration mode to enter the MST configuration mode to configure the above information.

MSTP BPDUs carry the above information. If the BPDU received by a device carries the same MST configuration information with the information on the device, it regards that the connected device belongs to the same MST region with itself. Otherwise, it regards the connected device originated from another MST region.

i It is recommended to configure the instance-VLAN mapping table after disabling MSTP. After the configuration, re-enable MSTP to ensure stability and convergence of the network topology.

▾ IST (Spanning Tree in an MSTP Region)

After MSTP regions are divided, each region selects an independent root bridge for each instance based on the corresponding parameters such as bridge priority and port priority, assigns roles to each port on each device, and specifies whether the port is in forwarding or discarding state in the instance based on the port role.

Through MSTP BPDU exchange, an IST is generated and each instance has their own spanning trees (MSTIs), in which the spanning tree corresponding to Instance 0 and CST are uniformly called Common Instance Spanning Tree (CIST). That is, each instance provides a single and loop-free network topology for their own VLAN groups.

As shown in Figure 100- 15, Devices A, B, and C form a loop in Region 1.

As shown in Figure 100- 15, Device A has the highest priority in the CIST (Instance 0) and thereby is selected as the region root. Then MSTP enables the link between A and C to enter the discarding state based on other parameters. Therefore, for the VLAN group of Instance 0, only links from A to B and from B to C are available, interrupting the loop of this VLAN group.

Figure 100- 15

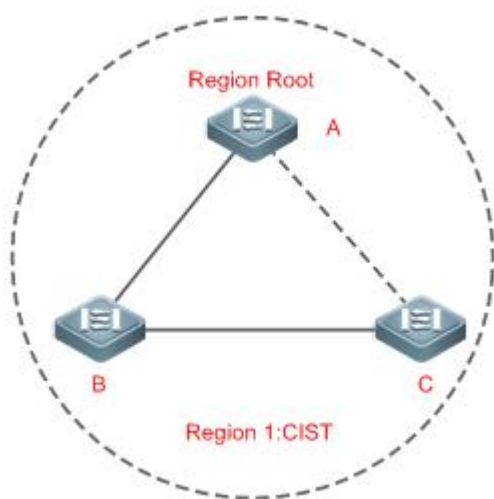

As shown in Figure 10- 16, Device B has the highest priority in the MSTI 1 (Instance 1) and thereby is selected as the region root. Then MSTP enables the link between B and C to enter the discarding state based on other parameters. Therefore, for the VLAN group of Instance 1, only links from A to B and from A to C are available, interrupting the loop of this VLAN group.

Figure 10- 16

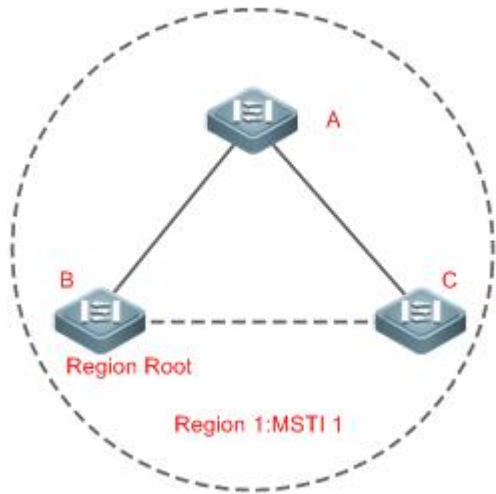

As shown in Figure 10- 17, Device C has the highest priority in the MSTI 2 (Instance 2) and thereby is selected as the region root. Then MSTP enables the link between B and C to enter the discarding state based on other parameters. Therefore, for the VLAN group of Instance 2, only links from B to C and from A to C are available, interrupting the loop of this VLAN group.

Figure 10- 17

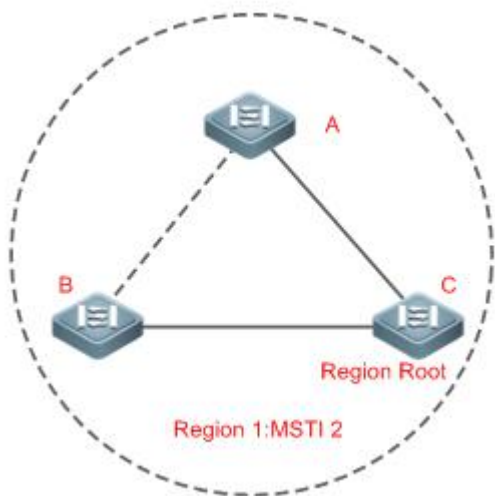

Note that MSTP does not care which VLAN a port belongs to. Therefore, users should configure the path cost and priority of a related port based on the actual VLAN configuration to prevent MSTP from interrupting wrong loops.

🔻 **CST (Spanning Tree Between MSTP Regions)**

Each MSTP region is like a big device for the CST. Different MSTP regions form a bit network topology tree called CST. As shown in Figure 10- 18, Device A, of which the bridge ID is the smallest, is selected as the root in the entire CST and the CIST regional root in this region. In Region 2, since the root path cost from Device B to the CST root is lowest, Device B is selected as the CIST regional root in this region. For the same reason, Device C is selected as the CIST regional root.

Figure 10- 18

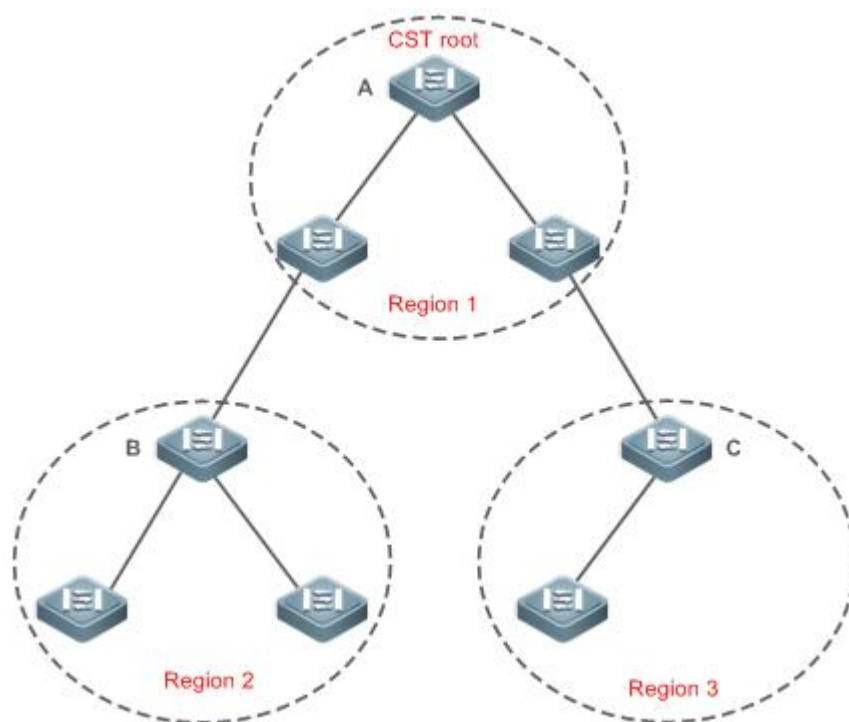

The CIST regional root may not be the device of which the bridge ID is the smallest in the region but indicates the device of which the root path cost from this region to the CST root is the smallest.

For the MSTI, the root port of the CIST regional root has a new role "master port". The master port acts as the outbound port of all instances and is in forwarding state for all instances. To make the topology more stable, we suggest that the master port of each region to the CST root be on the same device of the region if possible.

Compatibility Among MSTP, RSTP, and STP

Similar to RSTP, MSTP sends STP BPDUs to be compatible with STP. For details, see "Compatibility Between RSTP and STP".

Since RSTP processes MSTP BPDUs of the CIST, MSTP does not need to send RSTP BPDUs to be compatible with it.

Each STP or RSTP device is a single region and does not form the same region with any devices.

Related Configuration

Configuring STP

- By default, the STP mode is MSTP mode.
- Run `spanning-tree mode [stp | rstp | mstp]` to modify the STP mode.

32.3.4MSTP Optional Features

MSTP optional features mainly include PortFast port, BPDU guard, BPDU filter, TC guard, and guard. The optional features are mainly used to deploy MSTP configurations based on the network topology and application characteristics in the MSTP network. This enhances the stability, robustness, and anti-attack capability of MSTP, meeting application requirements of MSTP in different customer scenarios.

Working Principle

➤ PortFast

If a port of a device connects directly to the network terminal, this port is configured as a PortFast port to directly enter the forwarding state. If the PortFast port is not configured, the port needs to wait for 30 seconds to enter the forwarding state. Figure 10- 19 shows which ports of a device can be configured as PortFast ports.

Figure 10- 19

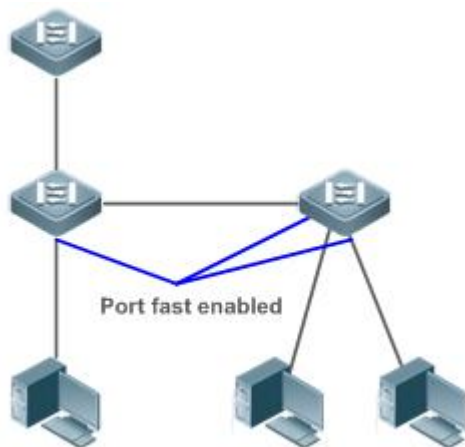

If a PortFast port still receives BPDUs, its Port Fast Operational State is Disabled and the port enters the forwarding state according to the normal STP algorithm.

➤ BPDU Guard

BPDU guard can be enabled globally or enabled on an interface.

It is recommended to run the **spanning-tree portfast bpduguard default** command in global configuration mode to enable global BPDU guard. If PortFast is enabled on a port or this port is automatically identified as an edge port, this port enters the error-disabled state to indicate the configuration error immediately after receiving a BPDU. At the same time, the port is disabled, indicating that a network device may be added by an unauthorized user to change the network topology.

It is also recommended to run the **spanning-tree bpduguard enable** command in interface configuration mode to enable BPDU guard on a port (whether PortFast is enabled or not on the port). In this case, the port enters the error-disabled state immediately after receiving a BPDU.

➤ BPDU Filter

BPDU filter can be enabled globally or enabled on an interface.

It is recommended to run the **spanning-tree portfast bpdufilter default** command in global configuration mode to enable global BPDU filter. In this case, the PortFast port neither receives nor sends BPDUs and therefore the host connecting directly to the PortFast port receives no BPDUs. If the port changes its Port Fast Operational State to Disabled after receiving a BPDU, BPDU filter automatically loses effect.

It is also recommended to run the **spanning-tree bpdufilter enable** command in interface configuration mode to enable BPDU filter on a port (whether PortFast is enabled or not on the port). In this case, the port neither receives nor sends BPDUs but directly enters the forwarding state.

➤ TC Protection

TC BPDUs are BPDU packets carrying the TC. If a switch receives such packets, it indicates the network topology changes and the switch will delete the MAC address table. For Layer-3 switches in this case, the forwarding module is re-enabled and the port status in the ARP entry changes. When a switch is attacked by forged TC BPDUs, it will frequently perform the above operations, causing heavy load and affecting network stability. To prevent this problem, you can enable TC protection.

TC protection can only be globally enabled or disabled. This function is disabled by default.

When TC protection is enabled, the switch deletes TC BPDUs within a specified period (generally 4 seconds) after receiving them and monitors whether any TC BPDU packet is received during the period. If a device receives TC BPDU packets during this period, it deletes them when the period expires. This can prevent the device from frequently deleting MAC address entries and ARP entries.

📌 TC Guard

TC protection ensures less dynamic MAC addresses and ARP entries removed when a large number of TC packets are generated on the network. However, a device receiving TC attack packets still performs many removal operations and TC packets can be spread, affecting the entire network. Users can enable TC guard to prevent TC packets from spreading globally or on a port. If TC guard is enabled globally or on a port, a port receiving TC packets filters these TC packets or TC packets generated by itself so that TC packets will not be spread to other ports. This can effectively control possible TC attacks in the network to ensure network stability. Particularly on Layer-3 devices, this function can effectively prevent the access-layer device from flapping and interrupting the core route.



If TC guard is used incorrectly, the communication between networks is interrupted.



It is recommended to enable this function only when illegal TC attack packets are received in the network.



If TC guard is enabled globally, no port spreads TC packets to others. This function can be enabled only on laptop access devices.



If TC guard is enabled on a port, the topology changes incurred and TC packets received on the port will not be spread to other ports. This function can be enabled only on uplink ports, particularly on ports of the convergence core.

📌 TC Filter

If TC guard is enabled on a port, the port does not forward TC packets received and generated by the port to other ports performing spanning tree calculation on the device. When the status of a port changes (for example, from blocking to forwarding), the port generates TC packets, indicating that the topology may have changed.

In this case, since TC guard prevents TC packets from spreading, the device may not clear the MAC addresses of the port when the network topology changes, causing a data forwarding error.

To resolve this problem, TC filter is introduced. TC filter does not process TC packets received by ports but processes TC packets in case of normal topology changes. If TC filter is enabled, the address removal problem will be avoided and the core route will not be interrupted when ports not enabled with PortFast frequently go up or down, and the core routing entries can be updated in a timely manner when the topology changes.



TC filter is disabled by default.

📌 BPDU Source MAC Address Check

BPDU source MAC address check prevents BPDU packets from maliciously attacking switches and causing MSTP abnormal. When the switch connected to a port on a point-to-point link is determined, you can enable BPDU source MAC address check to receive BPDU packets sent only by the peer switch and discard all other BPDU packets, thereby preventing malicious attacks. You can enable the BPDU source MAC address check in interface configuration mode for a specific port. One port can only filter one MAC address. If you run the **no bpdu src-mac-check** command to disable BPDU source MAC address check on a port, the port receives all BPDU packets.

📌 BPDU Filter

If the Ethernet length of a BPDU exceeds 1,500, this BPDU will be discarded, preventing receipt of illegal BPDU packets.

↘ Auto Edge

If the designated port of a device does not receive a BPDU from the downlink port within a specific period (3 seconds), the device regards a network device connected to the designated port, configures the port as an edge port, and switches the port directly into the forwarding state. The edge port will be automatically identified as a non-edge port after receiving a BPDU.

You can run the **spanning-tree autoedge disabled** command to disable Auto Edge.

This function is enabled by default.



If Auto Edge conflicts with the manually configured PortFast, the manual configuration prevails.



Since this function is used for rapid negotiation and forwarding between the designated port and the downlink port, STP does not support this function. If the designated port is in forwarding state, the Auto Edge configuration does not take effect on this port. It takes only when rapid negotiation is re-performed, for example, when the network cable is removed and plugged.



If BPDU filter has been enabled on a port, the port directly enters the forwarding state and is not automatically identified as an edge port.



This function applies only to the designated port.

↘ Root Guard

In the network design, the root bridge and backup root bridge are usually divided into the same region. Due to incorrect configuration of maintenance personnel or malicious attacks in the network, the root bridge may receive configuration information with a higher priority and thereby switches to the backup root bridge, causing incorrect changes in the network topology. Root guard is to resolve this problem.

If root guard is enabled on a port, its roles on all instances are enforced as the designated port. Once the port receives configuration information with a higher priority, it enters the root-inconsistent (blocking) state. If the port does not receive configuration information with a higher priority within a period, it returns to its original state.

If a port enters the blocking state due to root guard, you can manually restore the port to the normal state by disabling root guard on this port or disabling spanning tree guard (running **spanning-tree guard none** in interface configuration mode).



If root guard is used incorrectly, the network link will be interrupted.



If root guard is enabled on a non-designated port, this port will be enforced as a designated port and enter the BKN state. This indicates that the port enters the blocking state due to root inconsistency.



If a port enters the BKN state due to receipt of configuration information with a higher priority in MST0, this port will be enforced in the BKN state in all other instances.



Root guard and loop guard cannot take effect on a port at the same time.

↘ Loop Guard

Due to the unidirectional link failure, the root port or backup port becomes the designated port and enters the forwarding state if it does not receive BPDUs, causing a network loop. Loop guard is to prevent this problem.

If a port enabled with loop guard does not receive BPDUs, the port switches its role but stays in discarding state till it receives BPDUs and recalculates the spanning tree.



You can enable loop guard globally or on a port.



Root guard and loop guard cannot take effect on a port at the same time.

- ⚠ Before MSTP is restarted on a port, the port enters the blocking state in loop guard. If the port still receives no BPDU after MSTP is restarted, the port will become a designated port and enter the forwarding state. Therefore, it is recommended to identify the cause why a port enters the blocking state in loop protection and rectify the fault as soon as possible before restarting MSTP. Otherwise, the spanning tree topology will still become abnormal after MSTP is restarted.

↘ BPDU Transparent Transmission

In IEEE 802.1Q, the destination MAC address 01-80-C2-00-00-00 of the BPDU is used as a reserved address. That is, devices compliant with IEEE 802.1Q do not forward the BPDU packets received. However, devices may need to transparently transmit BPDU packets in actual network deployment. For example, if STP is disabled on a device, the device needs to transparently transmit BPDU packets so that the spanning tree between devices is properly calculated.

- ⚠ BPDU transparent transmission is disabled by default.
- ⚠ BPDU transparent transmission takes effect only when STP is disabled. If STP is enabled on a device, the device does not transparently transmit BPDU packets.

↘ BPDU Tunnel

- ↘ The QinQ network is generally divided into two parts: customer network and SP network. Before a user packet enters the SP network, it is encapsulated with the VLAN tag of an SP network and also retains the original VLAN tag as data. As a result, the packet carries two VLAN tags to pass through the SP network. In the SP network, packets are transmitted only based on the outer-layer VLAN tag. When packets leave the SP network, the outer-layer VLAN tag is removed.
- ↘ The STP packet transparent transmission feature, namely BPDU Tunnel, can be used to realize the transmission of STP packets between the customer network without any impact on the SP network. If an STP packet sent from the customer network enters a PE, the PE changes the destination MAC address of the packet to a private address before the packet is forwarded by the SP network. When the packet reaches the PE at the peer end, the PE changes the destination MAC address to a public address and returns the packet to the customer network at the peer end, realizing transparent transmission across the SP network. In this case, STP on the customer network is calculated independently of that on the SP network.

Related Configuration

↘ Configuring PortFast

- PortFast is disabled by default.
- In global configuration mode, run the **spanning-tree portfast default** command to enable PortFast on all ports and the **no spanning-tree portfast default** command to disable PortFast on all ports.
- In interface configuration mode, run the **spanning-tree portfast** command to enable PortFast on a port and the **spanning-tree portfast disabled** command to disable PortFast on a port.

↘ Configuring BPDU Guard

- BPDU guard is disabled by default.
- In global configuration mode, run the **spanning-tree portfast bpduguard default** command to enable BPDU guard on all ports and the **no spanning-tree portfast bpduguard default** command to disable BPDU guard on all ports.
- In interface configuration mode, run the **spanning-tree bpduguard enabled** command to enable BPDU guard on a port and the **spanning-tree bpduguard disabled** command to disable BPDU guard on a port.

↘ Configuring BPDU Filter

- BPDU Filter is disabled by default.
- In global configuration mode, run the **spanning-tree portfast bpdufilter default** command to enable BPDU filter on all ports and the **no spanning-tree portfast bpdufilter default** command to disable BPDU filter on all ports.
- In interface configuration mode, run the **spanning-tree bpdufilter enabled** command to enable BPDU filter on a port and the **spanning-tree bpdufilter disabled** command to disable BPDU filter on a port.

↘ **Configuring TC Protection**

- TC protection is disabled by default.
- In global configuration mode, run the **spanning-tree tc-protection** command to enable TC protection on all ports and the **no spanning-tree tc-protection** command to disable TC protection on all ports.
- TC protection can only be enabled or disabled globally.

↘ **Enabling TC Guard**

- TC guard is disabled by default.
- In global configuration mode, run the **spanning-tree tc-protection tc-guard** command to enable TC guard on all ports and the **no spanning-tree tc-protection tc-guard** command to disable TC guard on all ports.
- In interface configuration mode, run the **spanning-tree tc-guard** command to enable TC guard on a port and the **no spanning-tree tc-guard** command to disable TC guard on a port.

↘ **Configuring TC Filter**

- TC filter is disabled by default.
- In interface configuration mode, run the **spanning-tree ignore tc** command to enable TC filter on a port and the **no spanning-tree ignore tc** command to disable it on a port.

↘ **Enabling BPDU Source MAC Address Check**

- BPDU Source MAC Address Check is disabled by default.
- In interface configuration mode, run the **bpdu src-mac-check H.H.H** command to enable BPDU source MAC address check on a port and the **no bpdu src-mac-check** command to disable it on a port.

↘ **Configuring Auto Edge**

- Auto Edge is disabled by default.
- In interface configuration mode, run the **spanning-tree autoedge** command to enable Auto Edge on a port and the **spanning-tree autoedge disabled** command to disable it on a port.

↘ **Configuring Root Guard**

- Root Guard is disabled by default.
- In interface configuration mode, run the **spanning-tree guard root** command to enable root guard on a port and the **no spanning-tree guard root** command to disable it on a port.

↘ **Configuring Loop Guard**

- Loop Guard is disabled by default.

- In global configuration mode, run the **spanning-tree loopguard default** command to enable loop guard on all ports and the **no spanning-tree loopguard default** command to disable it on all ports.
- In interface configuration mode, run the **spanning-tree guard loop** command to enable loop guard on a port and the **no spanning-tree guard loop** command to disable it on a port.

▾ **Configuring BPDU Transparent Transmission**

- BPDU Transparent Transmission is disabled by default.
- In global configuration mode, run the **bridge-frame forwarding protocol bpdu** command to enable BPDU transparent transmission and the **no bridge-frame forwarding protocol bpdu** command to disable it.
- BPDU transparent transmission takes effect only when STP is disabled. If STP is enabled on a device, the device does not transparently transmit BPDU packets.

▾ **Configuring BPDU Tunnel**

- BPDU Tunnel is disabled by default.
- In global configuration mode, run the **l2protocol-tunnel stp** command to globally enable BPDU Tunnel and the **no l2protocol-tunnel stp** command to globally disable it.
- In interface configuration mode, run the **l2protocol-tunnel stp enable** command to enable BPDU Tunnel on a port and the **no l2protocol-tunnel stp enable** command to disable it on a port.
- BPDU Tunnel takes effect only when it is enabled in both global configuration mode and interface configuration mode.

32.3.5VSTP

Virtual Spanning Tree Protocol (VSTP) is used for loop prevention in the Multichassis Link Aggregation (M-LAG) scenario. VSTP virtualizes the M-LAG enabled devices into one bridge device. And the bridge ID is automatically chosen by the M-LAG system.

Currently, VSTP only applies to the M-LAG network to meet the following requirements:

1. Multiple-layer M-LAG interconnection;
2. The M-LAG member devices to act as non-root bridges.











Working Principle

VSTP virtualizes two devices running the STP into one device.

STP is able to learn the negotiation status of the M-LAG active-standby devices. With VSTP enabled, after the M-LAG active-standby negotiation is completed, the active and standby devices are virtualized to one device for port designation and convergence calculation.

1. STP synchronizes the bridge MAC address and instance priority of the M-LAG active and standby devices.
2. M-LAG active-standby negotiation.
3. Upon successful negotiation, the M-LG standby device uses the bridge MAC address and instance priority learned from the M-LAG active device to perform the virtual STP calculation and packet transmission.

32.4 Configuration

Configuration	Description and Command	
<u>Enabling STP</u>	 (Mandatory) It is used to enable STP.	
	spanning-tree	Enables STP and configures basic attributes.
	spanning-tree mode	Configures the STP mode.
<u>Configuring STP Compatibility</u>	 (Optional) It is used to be compatible with competitor devices.	
	spanning-tree compatible enable	Enables the compatibility mode of a port.
	clear spanning-tree detected-protocols	Performs mandatory version check for BPDUs.
<u>Configuring an MSTP Region</u>	 (Optional) It is used to configure an MSTP region.	
	spanning-tree mst configuration	Enters the MST configuration mode.
<u>Enabling Fast RSTP Convergence</u>	 (Optional) It is used to configure whether the link type of a port is point-to-point connection.	
	spanning-tree link-type	Configures the link type.
<u>Configuring Priorities</u>	 (Optional) It is used to configure the switch priority or port priority.	
	spanning-tree priority	Configures the switch priority.
	spanning-tree port-priority	Configures the port priority.
<u>Configuring the Port Path Cost</u>	 (Optional) It is used to configure the path cost of a port or the default path cost calculation method.	
	spanning-tree cost	Configures the port path cost.
	spanning-tree pathcost method	Configures the default path cost calculation method.
<u>Configuring the Maximum Hop Count of a BPDU Packet</u>	 (Optional) It is used to configure the maximum hop count of a BPDU packet.	
	spanning-tree max-hops	Configures the maximum hop count of a BPDU packet.
<u>Enabling PortFast-related Features</u>	 (Optional) It is used to enable PortFast-related features.	
	spanning-tree portfast	Enables PortFast.
	spanning-tree portfast bpduguard default	Enables BPDU guard on all ports.
	spanning-tree bpduguard enabled	Enables BPDU guard on a port.
	spanning-tree portfast bpdufilter default	Enables BPDU filter on all ports.
<u>Enabling TC-related Features</u>	 (Optional) It is used to enable TC-related features.	
	spanning-tree tc-protection	Enables TC protection.
	spanning-tree tc-protection tc-guard	Enables TC guard on all ports.
	spanning-tree tc-guard	Enables TC guard on a port.
<u>Enabling BPDU Source MAC Address Check</u>	 (Optional) It is used to enable BPDU source MAC address check.	
	bpdu src-mac-check	Enables BPDU source MAC address check on a port.

Configuration	Description and Command	
Configuring Auto Edge	(Optional) It is used to configure Auto Edge.	
	spanning-tree autoedge	Enables Auto Edge on a port. This function is enabled by default.
Enabling Guard-related Features	(Optional) It is used to enable port guard features.	
	spanning-tree guard root	Enables root guard on a port.
	spanning-tree loopguard default	Enables loop guard on all ports.
	spanning-tree guard loop	Enables loop guard on a port.
Enabling BPDU Transparent Transmission	(Optional) It is used to enable BPDU transparent transmission	
	bridge-frame forwarding protocol bpdu	Enables BPDU transparent transmission.
Enabling BPDU Tunnel	(Optional) It is used to enable BPDU Tunnel.	
	I2protocol-tunnel stp	Enables BPDU Tunnel globally.
	I2protocol-tunnel stp enable	Enables BPDU Tunnel on a port.
Enabling VSTP	(Optional) It is used to enable VSTP.	
	spanning-tree v-stp enable	Enables the VSTP function.

32.4.1 Enabling STP

Configuration Effect

- Enable STP globally and configure the basic attributes.
- Configure the STP mode.

Notes

- STP is disabled by default. Once STP is enabled, the device starts to run STP. The device runs MSTP by default.
- The default STP mode is MSTP mode.
- STP and Transparent Interconnection of Lots of Links (TRILL) of the data center cannot be enabled at the same time.
- STP timer parameters take effect only when the device is selected as the root bridge of the spanning tree. That is, the timer parameters of a non-root bridge should use the timer values of the root bridge.

Configuration Steps

➤ Enabling STP

- Mandatory.
- Unless otherwise specified, enable STP on each device.
- Run the **spanning-tree [forward-time seconds | hello-time seconds | max-age seconds]** command to enable STP and configure basic attributes.

! Running the **clear** commands may lose vital information and thus interrupt services. The value ranges of forward-time, hello-time, and max-age are related. If one of them is modified, the other two ranges are affected. The three values must meet the following condition: $2 \times (\text{Hello Time} + 1 \text{ second}) \leq \text{Max-Age Time} \leq 2 \times (\text{Forward-Delay Time} - 1 \text{ second})$. Otherwise, the topology may become unstable.

Command	spanning-tree [forward-time <i>seconds</i> hello-time <i>seconds</i> max-age <i>seconds</i> tx-hold-count <i>numbers</i>]
Parameter	forward-time <i>seconds</i> : Indicates the interval when the port status changes. The value ranges from 4 to 30 seconds.
Description	The default value is 15 seconds. hello-time <i>seconds</i> : Indicates the interval when a device sends a BPDU packet. The value ranges from 1 to 10 seconds. The default value is 2 seconds. max-age <i>second</i> : Indicates the longest TTL of a BPDU packet. The value ranges from 6 to 40 seconds. The default value is 20 seconds. tx-hold-count <i>numbers</i> : Indicates the maximum number of BPDUs sent per second. The value ranges from 1 to 10. The default value is 3.
Defaults	STP is disabled by default.
Command Mode	Global configuration mode
Usage Guide	The value ranges of forward-time, hello-time, and max-age are related. If one of them is modified, the other two ranges are affected. The three values must meet the following condition: $2 \times (\text{Hello Time} + 1 \text{ second}) \leq \text{Max-Age Time} \leq 2 \times (\text{Forward-Delay Time} - 1 \text{ second})$ Otherwise, the topology may become unstable.

↘ **Configuring the STP Mode**

- Optional.
- According to related 802.1 protocol standards, STP, RSTP, and MSTP are mutually compatible, without any configuration by the administrator. However, some vendors' devices do not work according to 802.1 protocol standards, possibly causing incompatibility. Therefore, FS provides a command for the administrator to switch the STP mode to a lower version if other vendors' devices are incompatible with FS devices.
- Run the **spanning-tree mode** [**stp** | **rstp** | **mstp**] command to modify the STP mode.

Command	spanning-tree mode [stp rstp mstp]
Parameter	stp : Spanning Tree Protocol (IEEE 802.1d)
Description	rstp : Rapid Spanning Tree Protocol (IEEE 802.1w) mstp : Multiple Spanning Tree Protocol (IEEE 802.1s)
Defaults	The default value is mstp .
Command Mode	Global configuration mode
Usage Guide	However, some vendors' devices do not work according to 802.1 protocol standards, possibly causing incompatibility. If other vendors' devices are incompatible with FS devices, run this command to switch the STP mode to a lower version.

Verification

- Display the configuration.

Related Commands

➤ **Configuring STP**

Command	spanning-tree [forward-time <i>seconds</i> hello-time <i>seconds</i> max-age <i>seconds</i> tx-hold-count <i>numbers</i>]
Parameter Description	<p>forward-time <i>seconds</i>: Indicates the interval when the port status changes. The value ranges from 4 to 30 seconds. The default value is 15 seconds.</p> <p>hello-time <i>seconds</i>: Indicates the interval when a device sends a BPDU packet. The value ranges from 1 to 10 seconds. The default value is 2 seconds.</p> <p>max-age <i>second</i>: Indicates the longest TTL of a BPDU packet. The value ranges from 6 to 40 seconds. The default value is 20 seconds.</p> <p>tx-hold-count <i>numbers</i>: Indicates the maximum number of BPDUs sent per second. The value ranges from 1 to 10. The default value is 3.</p>
Command Mode	Global configuration mode
Usage Guide	<p>The value ranges of forward-time, hello-time, and max-age are related. If one of them is modified, the other two ranges are affected. The three values must meet the following condition:</p> $2 \times (\text{Hello Time} + 1 \text{ second}) \leq \text{Max-Age Time} \leq 2 \times (\text{Forward-Delay Time} - 1 \text{ second})$ <p>Otherwise, the topology may become unstable and the configuration will fail.</p>

➤ **Configuring the STP Mode**

Command	spanning-tree mode [stp rstp mstp]
Parameter Description	<p>stp: Spanning Tree Protocol (IEEE 802.1d)</p> <p>rstp: Rapid Spanning Tree Protocol (IEEE 802.1w)</p> <p>mstp: Multiple Spanning Tree Protocol (IEEE 802.1s)</p>
Command Mode	Global configuration mode
Usage Guide	However, some vendors' devices do not work according to 802.1 protocol standards, possibly causing incompatibility. If other vendors' devices are incompatible with FS devices, run this command to switch the STP mode to a lower version.

Configuration Example

➤ **Enabling STP and Configuring Timer Parameters**

Scenario Figure 10- 20	<p>The diagram shows two network devices, DEV A and DEV B, connected in a simple topology. DEV A is at the top and DEV B is at the bottom. They are connected via two links: one on the left connecting G 0/1 of DEV A to G 0/1 of DEV B, and one on the right connecting G 0/2 of DEV A to G 0/2 of DEV B.</p>
Configuration Steps	<ul style="list-style-type: none"> ● Enable STP and set the STP mode to STP on the devices. ● Configure the timer parameters of root bridge DEV A as follows: Hello Time=4s, Max Age=25s, Forward

	Delay=18s.
DEV A	<p>Step 1: Enable STP and set the STP mode to STP.</p> <pre>FS#configure terminal</pre> <p>Enter configuration commands, one per line. End with CNTL/Z.</p> <pre>FS(config)#spanning-tree FS(config)#spanning-tree mode stp</pre> <p>Step 2: Configure the timer parameters of root bridge DEV A.</p> <pre>FS(config)#spanning-tree hello-time 4 FS(config)#spanning-tree max-age 25 FS(config)#spanning-tree forward-time 18</pre>
DEV B	<p>Enable STP and set the STP mode to STP.</p> <pre>FS#configure terminal</pre> <p>Enter configuration commands, one per line. End with CNTL/Z.</p> <pre>FS(config)#spanning-tree FS(config)#spanning-tree mode stp</pre>
Verification	<ul style="list-style-type: none"> Run the show spanning-tree summary command to display the spanning tree topology and protocol configuration parameters.
DEV A	<pre>FS#show spanning-tree summary</pre> <p>Spanning tree enabled protocol stp</p> <pre> Root ID Priority 0 Address 00d0.f822.3344 this bridge is root Hello Time 4 sec Forward Delay 18 sec Max Age 25 sec Bridge ID Priority 0 Address 00d0.f822.3344 Hello Time 4 sec Forward Delay 18 sec Max Age 25 sec Interface Role Sts Cost Prio OperEdge Type ----- Gi0/2 Desg FWD 20000 128 False P2p Gi0/1 Desg FWD 20000 128 False P2p </pre>

```

DEV B
FS#show spanning-tree summary

Spanning tree enabled protocol stp

  Root ID    Priority    0
             Address    00d0.f822.3344
             this bridge is root
             Hello Time  4 sec   Forward Delay 18 sec   Max Age 25 sec

  Bridge ID  Priority    32768
             Address    001a.a917.78cc
             Hello Time  2 sec   Forward Delay 15 sec   Max Age 20 sec

Interface          Role Sts Cost          Prio   OperEdge Type
-----
Gi0/2              Altn BLK 20000    128    False   P2p Bound(STP)
Gi0/1              Root FWD 20000    128    False   P2p Bound(STP)
    
```

Common Errors

N/A

32.4.2Configuring STP Compatibility

Configuration Effect

- Enable the compatibility mode of a port to realize interconnection between FS devices and other SPs' devices.
- Enable protocol migration to perform forcible version check to affect the compatibility between RSTP and STP.

Notes

- If the compatibility mode is enabled on a port, this port will add different MSTI information into the to-be-sent BPDU based on the current port to realize interconnection between FS devices and other SPs' devices.
- When enabling compatibility on a port, ensure correct VLAN trimming information of the port. It is recommended to configure consistent VLAN lists for ports at both ends of the link.

Configuration Steps

➤ **Enabling the Compatibility Mode on a Port**

- Optional.

➤ **Configuring Protocol Migration**

- **Optional.**

➤ **If the peer device supports RSTP, you can enforce version check on the local device to force the two devices to run RSTP.**

Verification

- Display the configuration.

Related Commands

➤ **Enabling the Compatibility Mode on a Port**

Command	spanning-tree compatible enable
Parameter	N/A
Description	
Defaults	The compatibility mode is disabled on a port by default.
Command Mode	Interface configuration mode
Usage Guide	If the compatibility mode is enabled on a port, this port will add different MSTI information into the to-be-sent BPDU based on the current port to realize interconnection between FS devices and other SPs' devices.

➤ **Enabling Protocol Migration**

Command	clear spanning-tree detected-protocols [interface <i>interface-id</i>]
Parameter Description	interface <i>interface-id</i> : Indicates a port.
Command Mode	Privileged EXEC mode
Usage Guide	This command is used to enforce a port to send RSTP BPDU packets and perform forcible check on them.

Configuration Example

➤ **Enabling STP Compatibility**

<p>Scenario Figure 10-21</p>	
<p>Configuration Steps</p>	<ul style="list-style-type: none"> ● Configure Instances 1 and 2 on Devices A and B, and map Instance 1 with VLAN 10 and Instance 2 with VLAN 20. ● Configure Gi0/1 and Gi0/2 to respectively belong to VLAN 10 and VLAN 20, and enable STP compatibility.

<p>DEV A</p>	<p>Step 1: Configure Instances 1 and 2, and map Instances 1 and 2 respectively with VLANs 10 and 20.</p> <pre> FS#configure terminal Enter configuration commands, one per line. End with CNTL/Z. FS(config)#spanning-tree mst configuration FS(config-mst)#instance 1 vlan 10 FS(config-mst)#instance 2 vlan 20 </pre> <p>Step 2: Configure the VLAN the port belongs to, and enable STP compatibility on the port.</p> <pre> FS(config)#int gi 0/1 FS(config-if-GigabitEthernet 0/1)#switchport access vlan 10 FS(config-if-GigabitEthernet 0/1)#spanning-tree compatible enable FS(config-if-GigabitEthernet 0/1)#int gi 0/2 FS(config-if-GigabitEthernet 0/2)#switchport access vlan 20 FS(config-if-GigabitEthernet 0/2)#spanning-tree compatible enable </pre>
<p>DEV B</p>	<p>Perform the same steps as DEV A.</p>
<p>Verification</p>	<ul style="list-style-type: none"> ● Run the show spanning-tree summary command to check whether the spanning tree topology is correctly calculated.
<p>DEV A</p>	<pre> FS#show spanning-tree summary Spanning tree enabled protocol mstp MST 0 vlans map : 1-9, 11-19, 21-4094 Root ID Priority 32768 Address 001a.a917.78cc this bridge is root Hello Time 2 sec Forward Delay 15 sec Max Age 20 sec Bridge ID Priority 32768 Address 001a.a917.78cc Hello Time 2 sec Forward Delay 15 sec Max Age 20 sec Interface Role Sts Cost Prio OperEdge Type ----- Gi0/2 Desg FWD 20000 128 False P2p Gi0/1 Desg FWD 20000 128 False P2p </pre>

	<pre> MST 1 vlans map : 10 Region Root Priority 32768 Address 001a.a917.78cc this bridge is region root Bridge ID Priority 32768 Address 001a.a917.78cc Interface Role Sts Cost Prio OperEdge Type ----- Gi0/1 Desg FWD 20000 128 False P2p MST 2 vlans map : 20 Region Root Priority 32768 Address 001a.a917.78cc this bridge is region root Bridge ID Priority 32768 Address 001a.a917.78cc Interface Role Sts Cost Prio OperEdge Type ----- Gi0/2 Desg FWD 20000 128 False P2p </pre>
<p>DEV B</p>	<pre> FS#show spanning-tree summary Spanning tree enabled protocol mstp MST 0 vlans map : 1-9, 11-19, 21-4094 Root ID Priority 32768 Address 001a.a917.78cc this bridge is root Hello Time 2 sec Forward Delay 15 sec Max Age 20 sec Bridge ID Priority 32768 </pre>

```

Address      00d0.f822.3344

Hello Time   4 sec   Forward Delay 18 sec   Max Age 25 sec

Interface    Role Sts Cost      Prio   OperEdge Type
-----
Gi0/2        Altn BLK 20000    128    False   P2p
Gi0/1        Root FWD 20000    128    False   P2p

MST 1 vlans map : 10

Region Root Priority  32768
Address      001a.a917.78cc
this bridge is region root

Bridge ID  Priority  32768
Address    00d0.f822.3344

Interface    Role Sts Cost      Prio   OperEdge Type
-----
Gi0/1        Root FWD 20000    128    False   P2p

MST 2 vlans map : 20

Region Root Priority  32768
Address      001a.a917.78cc
this bridge is region root

Bridge ID  Priority  32768
Address    00d0.f822.3344

Interface    Role Sts Cost      Prio   OperEdge Type
-----
Gi0/2        Root FWD 20000    128    False   P2p
    
```

Common Errors

N/A

32.4.3 Configuring an MSTP Region

Configuration Effect

- Configure an MSTP region to adjust which devices belong to the same MSTP region and thereby affect the network topology.

Notes

- To make multiple devices belong to the same MSTP region, configure the same name, revision number, and instance-VLAN mapping table for them.
- You can configure VLANs for Instances 0 to 64, and then the remaining VLANs are automatically allocated to Instance 0. One VLAN belongs to only one instance.
- It is recommended to configure the instance-VLAN mapping table after disabling STP. After the configuration, re-enable MSTP to ensure stability and convergence of the network topology.

Configuration Steps

↘ Configuring an MSTP Region

- Optional.
- Configure an MSTP region when multiple devices need to belong to the same MSTP region.

Verification

- Display the configuration.

Related Commands

↘ Entering MSTP Region Configuration Mode

- Optional.
- Configure an MSTP region when multiple devices need to belong to the same MSTP region.
- Run the **spanning-tree mst configuration** command to enter the MST configuration mode.
- Run the **instance *instance-id* vlan *vlan-range*** command to configure the MSTI-VLAN mapping.
- Run the **name *name*** command to configure the MST name.
- Run the **revision *version*** command to configure the MST version number.

Command	spanning-tree mst configuration
Parameter	N/A
Description	
Command Mode	Global configuration mode
Usage Guide	Run this command to enter the MST configuration mode.

↘ Configuring Instance-VLAN Mapping

Command	instance <i>instance-id</i> vlan <i>vlan-range</i>
Parameter	<i>instance-id</i> : Indicates the MSTI ID, ranging from 0 to 64.
Description	<i>vlan-range</i> : Indicates the VLAN ID, ranging from 1 to 4,094.

Defaults	The default instance-VLAN mapping is that all VLANs are in Instance 0.
Command	MST configuration mode
Mode	
Usage Guide	<p>To add a VLAN group to an MSTI, run this command.</p> <p>For example,</p> <p>instance 1 vlan 2-200: Adds VLANs 2 to 200 to Instance 1.</p> <p>instance 1 vlan 2,20,200: Adds VLANs 2, 20, and 200 to Instance 1.</p> <p>You can use the no form of this command to remove VLANs from an instance. Removed VLANs are automatically forwarded to Instance 0.</p>

➤ **Configuring MST Version Name**

Command	name <i>name</i>
Parameter	<i>name</i> : Indicates the MST name. It consists of a maximum of 32 bytes.
Description	
Defaults	The default name is an empty character string.
Command	MST configuration mode
Mode	
Usage Guide	N/A

➤ **Configuring MST Version Number**

Command	revision <i>version</i>
Parameter	<i>version</i> : Indicates the MST revision number, ranging from 0 to 65,535.
Description	
Defaults	The default revision number is 0.
Command	MST configuration mode
Mode	
Usage Guide	N/A

Verification

- Display the configuration.
- Run the **show spanning-tree mst configuration** command to display the MSTP region configuration.

Configuration Example

➤ **Enabling MSTP to Achieve VLAN Load Balancing in the MSTP+VRRP Topology**

Scenario

Figure 10-22

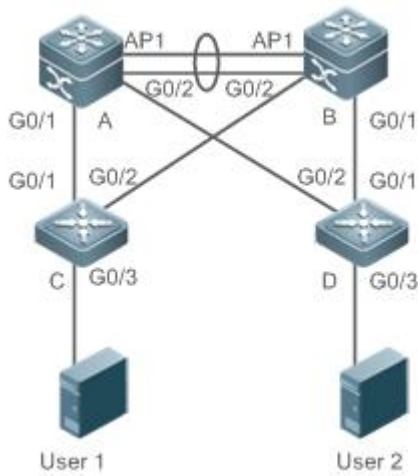

Configuration Steps

- Enable MSTP and create Instances 1 and 2 on Switches A, B, C, and D.
- Configure Switch A as the root bridge of Instances 0 and 1 and Switch B as the root bridge of Instance 2.
- Configure Switch A as the VRRP master device of VLANs 1 and 10 and Switch B as the VRRP master device of VLAN 20.

A

Step 1: Configure VLANs 10 and 20, and configure ports as Trunk ports.

```
A(config)#vlan 10
A(config-vlan)#vlan 20
A(config-vlan)#exit
A(config)#int range gi 0/1-2
A(config-if-range)#switchport mode trunk
A(config-if-range)#int ag 1
A(config-if-AggregatePort 1)# switchport mode trunk
```

Step 2: Enable MSTP and create Instances 1 and 2.

```
A(config)#spanning-tree
A(config)# spanning-tree mst configuration
A(config-mst)#instance 1 vlan 10
A(config-mst)#instance 2 vlan 20
A(config-mst)#exit
```

Step 3: Configure Switch A as the root bridge of Instances 0 and 1.

```
A(config)#spanning-tree mst 0 priority 4096
A(config)#spanning-tree mst 1 priority 4096
A(config)#spanning-tree mst 2 priority 8192
```

	<p>Step 4: Configure VRRP priorities to enable Switch A to act as the VRRP master device of VLAN 10, and configure the virtual gateway IP address of VRRP.</p> <pre>A(config)#interface vlan 10 A(config-if-VLAN 10)ip address 192.168.10.2 255.255.255.0 A(config-if-VLAN 10) vrrp 1 priority 120 A(config-if-VLAN 10) vrrp 1 ip 192.168.10.1</pre> <p>Step 5 Set the VRRP priority to the default value 100 to enable Switch A to act as the VRRP backup device of VLAN 20.</p> <pre>A(config)#interface vlan 20 A(config-if-VLAN 20)ip address 192.168.20.2 255.255.255.0 A(config-if-VLAN 20) vrrp 1 ip 192.168.20.1</pre>
B	<p>Step 1: Configure VLANs 10 and 20, and configure ports as Trunk ports.</p> <pre>B(config)#vlan 10 B(config-vlan)#vlan 20 B(config-vlan)#exit B(config)#int range gi 0/1-2 B(config-if-range)#switchport mode trunk B(config-if-range)#int ag 1 B(config-if-AggregatePort 1)# switchport mode trunk</pre> <p>Step 2: Enable MSTP and create Instances 1 and 2.</p> <pre>B(config)#spanning-tree B(config)# spanning-tree mst configuration B(config-mst)#instance 1 vlan 10 B(config-mst)#instance 2 vlan 20 B(config-mst)#exit</pre> <p>Step 3: Configure Switch A as the root bridge of Instance 2.</p> <pre>B(config)#spanning-tree mst 0 priority 8192 B(config)#spanning-tree mst 1 priority 8192 B(config)#spanning-tree mst 2 priority 4096</pre> <p>Step 4: Configure the virtual gateway IP address of VRRP.</p>

	<pre>B(config)#interface vlan 10 B(config-if-VLAN 10)ip address 192.168.10.3 255.255.255.0 B(config-if-VLAN 10) vrrp 1 ip 192.168.10.1</pre> <p>Step 5 Set the VRRP priority to 120 to enable Switch B to act as the VRRP backup device of VLAN 20.</p> <pre>B(config)#interface vlan 20 B(config-if-VLAN 20)vrrp 1 priority 120 B(config-if-VLAN 20)ip address 192.168.20.3 255.255.255.0 B(config-if-VLAN 20) vrrp 1 ip 192.168.20.1</pre>
C	<p>Step 1: Configure VLANs 10 and 20, and configure ports as Trunk ports.</p> <pre>C(config)#vlan 10 C(config-vlan)#vlan 20 C(config-vlan)#exit C(config)#int range gi 0/1-2 C(config-if-range)#switchport mode trunk</pre> <p>Step 2: Enable MSTP and create Instances 1 and 2.</p> <pre>C(config)#spanning-tree C(config)# spanning-tree mst configuration C(config-mst)#instance 1 vlan 10 C(config-mst)#instance 2 vlan 20 C(config-mst)#exit</pre> <p>Step 3: Configure the port connecting Device C directly to users as a PortFast port and enable BPDU guard.</p> <pre>C(config)#int gi 0/3 C(config-if-GigabitEthernet 0/3)#spanning-tree portfast C(config-if-GigabitEthernet 0/3)#spanning-tree bpduguard enable</pre>
D	<p>Perform the same steps as Device C.</p>
Verification	<ul style="list-style-type: none"> ● Run the show spanning-tree summary command to check whether the spanning tree topology is correctly calculated. ● Run the show vrrp brief command to check whether the VRRP master/backup devices are successfully created.
A	<pre>FS#show spanning-tree summary</pre>

Spanning tree enabled protocol mstp

MST 0 vlans map : 1-9, 11-19, 21-4094

```

Root ID    Priority    4096
           Address    00d0.f822.3344
           this bridge is root
           Hello Time  4 sec  Forward Delay 18 sec  Max Age 25 sec
    
```

```

Bridge ID  Priority    4096
           Address    00d0.f822.3344
           Hello Time  4 sec  Forward Delay 18 sec  Max Age 25 sec
    
```

Interface	Role	Sts Cost	Prio	OperEdge	Type
Ag1	Desg FWD	19000	128	False	P2p
Gi0/1	Desg FWD	200000	128	False	P2p
Gi0/2	Desg FWD	200000	128	False	P2p

MST 1 vlans map : 10

```

Region Root Priority  4096
                    Address    00d0.f822.3344
                    this bridge is region root
    
```

```

Bridge ID  Priority    4096
           Address    00d0.f822.3344
    
```

Interface	Role	Sts Cost	Prio	OperEdge	Type
Ag1	Desg FWD	19000	128	False	P2p
Gi0/1	Desg FWD	200000	128	False	P2p
Gi0/2	Desg FWD	200000	128	False	P2p

MST 2 vlans map : 20

```

Region Root Priority  4096
    
```

	<pre> Address 001a.a917.78cc this bridge is region root Bridge ID Priority 8192 Address 00d0.f822.3344 Interface Role Sts Cost Prio OperEdge Type ----- Ag1 Root FWD 19000 128 False P2p Gi0/1 Desg FWD 200000 128 False P2p Gi0/2 Desg FWD 200000 128 False P2p </pre>
B	<pre> FS#show spanning-tree summary Spanning tree enabled protocol mstp MST 0 vlans map : 1-9, 11-19, 21-4094 Root ID Priority 4096 Address 00d0.f822.3344 this bridge is root Hello Time 4 sec Forward Delay 18 sec Max Age 25 sec Bridge ID Priority 8192 Address 001a.a917.78cc Hello Time 2 sec Forward Delay 15 sec Max Age 20 sec Interface Role Sts Cost Prio OperEdge Type ----- Ag1 Root FWD 19000 128 False P2p Gi0/1 Desg FWD 200000 128 False P2p Gi0/2 Desg FWD 200000 128 False P2p MST 1 vlans map : 10 Region Root Priority 4096 Address 00d0.f822.3344 this bridge is region root </pre>

	<pre> Bridge ID Priority 8192 Address 001a.a917.78cc Interface Role Sts Cost Prio OperEdge Type ----- Ag1 Root FWD 19000 128 False P2p Gi0/1 Desg FWD 200000 128 False P2p Gi0/2 Desg FWD 200000 128 False P2p MST 2 vlans map : 20 Region Root Priority 4096 Address 001a.a917.78cc this bridge is region root Bridge ID Priority 4096 Address 001a.a917.78cc Interface Role Sts Cost Prio OperEdge Type ----- Ag1 Desg FWD 19000 128 False P2p Gi0/1 Desg FWD 200000 128 False P2p Gi0/2 Desg FWD 200000 128 False P2p </pre>
C	<pre> FS#show spanning-tree summary Spanning tree enabled protocol mstp MST 0 vlans map : 1-9, 11-19, 21-4094 Root ID Priority 4096 Address 00d0.f822.3344 this bridge is root Hello Time 4 sec Forward Delay 18 sec Max Age 25 sec Bridge ID Priority 32768 Address 001a.a979.00ea </pre>

	<pre> Hello Time 2 sec Forward Delay 15 sec Max Age 20 sec Interface Role Sts Cost Prio Type OperEdge ----- Fa0/2 Altn BLK 200000 128 P2p False Fa0/1 Root FWD 200000 128 P2p False MST 1 vlans map : 10 Region Root Priority 4096 Address 00d0.f822.3344 this bridge is region root Bridge ID Priority 32768 Address 001a.a979.00ea Interface Role Sts Cost Prio Type OperEdge ----- Fa0/2 Altn BLK 200000 128 P2p False Fa0/1 Root FWD 200000 128 P2p False MST 2 vlans map : 20 Region Root Priority 4096 Address 001a.a917.78cc this bridge is region root Bridge ID Priority 32768 Address 001a.a979.00ea Interface Role Sts Cost Prio Type OperEdge ----- Fa0/2 Root FWD 200000 128 P2p False Fa0/1 Altn BLK 200000 128 P2p False </pre>
D	Omitted.

Common Errors

- MST region configurations are inconsistent in the MSTP topology.
- VLANs are not created before you configure the mapping between the instance and VLAN.
- A device runs STP or RSTP in the MSTP+VRRP topology, but calculates the spanning tree according to the algorithms of different MST regions.

32.4.4 Enabling Fast RSTP Convergence

Configuration Effect

- Configure the link type to make RSTP rapidly converge.

Notes

- If the link type of a port is point-to-point connection, RSTP can rapidly converge. For details, see "Fast RSTP Convergence". If the link type is not configured, the device automatically sets the link type based on the duplex mode of the port. If a port is in full duplex mode, the device sets the link type to point-to-point. If a port is in half duplex mode, the device sets the link type to shared. You can also forcibly configure the link type to determine whether the port connection is point-to-point connection.
- The link type of a port is related to the rate and duplex mode. If the port is in half duplex mode, the link type is shared.

Configuration Steps

⌵ Configuring the Link Type

- Optional.

Verification

- Display the configuration.
- Run the **show spanning-tree [mst instance-id] interface interface-id** command to display the spanning tree configuration of the port.

Related Commands

⌵ Configuring the Link Type

Command	spanning-tree link-type [point-to-point shared]
Parameter Description	point-to-point: Forcibly configures the link type of a port to be point-to-point. shared: Forcibly configures the link type of a port to be shared.
Defaults	If a port is in full duplex mode, the link type of the port is point-to-point. If a port is in half duplex mode, the link type of the port is shared.
Command Mode	Interface configuration mode
Usage Guide	If the link type of a port is point-to-point connection, RSTP can rapidly converge. If the link type is not configured, the device automatically sets the link type based on the duplex mode of the port.

Configuration Example

⌵ Enabling Fast RSTP Convergence

Configuration	Set the link type of a port to point-to-point.
----------------------	--

Steps	<pre>FS(config)#int gi 0/1 FS(config-if-GigabitEthernet 0/1)#spanning-tree link-type point-to-point</pre>
Verification	<ul style="list-style-type: none"> ● Run the show spanning-tree summary command to display the link type of the port.
	<pre>FS#show spanning-tree summary Spanning tree enabled protocol mstp MST 0 vlans map : ALL Root ID Priority 32768 Address 001a.a917.78cc this bridge is root Hello Time 2 sec Forward Delay 15 sec Max Age 20 sec Bridge ID Priority 32768 Address 00d0.f822.3344 Hello Time 2 sec Forward Delay 15 sec Max Age 20 sec Interface Role Sts Cost Prio OperEdge Type ----- Gi0/1 Root FWD 20000 128 False P2p</pre>

Common Errors

N/A

32.4.5Configuring Priorities

Configuration Effect

- Configure the switch priority to determine a device as the root of the entire network and to determine the topology of the entire network.
- Configure the port priority to determine which port enters the forwarding state.

Notes

- It is recommended to set the priority of the core device higher (to a smaller value) to ensure stability of the entire network. You can assign different switch priorities to different instances so that each instance runs an independent STP based on the assigned priorities. Devices in different regions use the priority only of the CIST (Instance 0). As described in bridge ID, the switch priority has 16 optional values: 0, 4,096, 8,192, 12,288, 16,384, 20,480, 24,576, 28,672, 32,768, 36,864, 40,960, 45,056, 49,152, 53,248, 57,344, 61,440. They are integral multiples of 4,096. The default value is 32,768.

- If two ports are connected to a shared device, the device selects a port with a higher priority (smaller value) to enter the forwarding state and a port with a lower priority (larger value) to enter the discarding state. If the two ports have the same priority, the device selects the port with a smaller port ID to enter the forwarding state. You can assign different port priorities to different instances on a port so that each instance runs an independent STP based on the assigned priorities.
- Similar to the switch priority, the port priority also has 16 optional values: 0, 16, 32, 48, 64, 80, 96, 112, 128, 144, 160, 176, 192, 208, 224, 240. They are integral multiples of 16. The default value is 128.
- The modified port priority takes effect only on the designated port.

Configuration Steps

▾ Configuring the Switch Priority

- Optional.
- To change the root or topology of a network, configure the switch priority.

▾ Configuring the Port Priority

- Optional.
- To change the preferred port entering the forwarding state, configure the port priority.

Verification

- Display the configuration.
- Run the **show spanning-tree [mst instance-id] interface interface-id** command to display the spanning tree configuration of the port.

Related Commands

▾ Configuring the Switch Priority

Command	spanning-tree [mst instance-id] priority priority
Parameter	mst instance-id : Indicates the instance ID, ranging from 0 to 64.
Description	priority priority : Indicates the switch priority. There are 16 optional values: 0, 4,096, 8,192, 12,288, 16,384, 20,480, 24,576, 28,672, 32,768, 36,864, 40,960, 45,056, 49,152, 53,248, 57,344, 61,440. They are integral multiples of 4,096.
Defaults	The default value of <i>instance-id</i> is 0 while that of <i>priority</i> is 32,768.
Command Mode	Global configuration mode
Usage Guide	Configure the switch priority to determine a device as the root of the entire network and to determine the topology of the entire network.

▾ Configuring the Port Priority

Command	spanning-tree [mst instance-id] port-priority priority
Parameter	mst instance-id : Indicates the instance ID, ranging from 0 to 64.
Description	port-priority priority : Indicates the port priority. There are 16 optional values: 0, 16, 32, 48, 64, 80, 96, 112, 128, 144, 160, 176, 192, 208, 224, 240. They are integral multiples of 4,096.
Defaults	The default value of <i>instance-id</i> is 0. The default value of <i>priority</i> is 128.

Command	Interface configuration mode
Mode	
Usage Guide	<p>If a loop occurs in a region, the port with a higher priority is preferred to enter the forwarding state. If two ports have the same priority, the port with a smaller port ID is selected to enter the forwarding state.</p> <p>Run this command to determine which port in the loop of a region enters the forwarding state.</p>

Configuration Example

📌 **Configuring the Port Priority**

<p>Scenario Figure 10- 23</p>	
<p>Configuration Steps</p>	<ul style="list-style-type: none"> ● Configure the bridge priority so that DEV A becomes the root bridge of the spanning tree. ● Configure the priority of Gi0/2 on DEV A is 16 so that Gi0/2 on DEV B can be selected as the root port.
<p>DEV A</p>	<p>Step 1: Enable STP and configure the bridge priority.</p> <pre>FS(config)#spanning-tree FS(config)#spanning-tree mst 0 priority 0</pre> <p>Step 2: Configure the priority of Gi 0/2.</p> <pre>FS(config)# int gi 0/2 FS(config-if-GigabitEthernet 0/2)#spanning-tree mst 0 port-priority 16</pre>
<p>DEV B</p>	<pre>FS(config)#spanning-tree</pre>
<p>Verification</p>	<ul style="list-style-type: none"> ● Run the show spanning-tree summary command to display the topology calculation result of the spanning tree.
<p>DEV A</p>	<pre>FS# FS#show spanning-tree summary Spanning tree enabled protocol mstp MST 0 vlans map : ALL Root ID Priority 0 Address 00d0.f822.3344 this bridge is root</pre>

	<pre> Hello Time 2 sec Forward Delay 15 sec Max Age 20 sec Bridge ID Priority 0 Address 00d0.f822.3344 Hello Time 2 sec Forward Delay 15 sec Max Age 20 sec Interface Role Sts Cost Prio OperEdge Type ----- Gi0/2 Desg FWD 20000 16 False P2p Gi0/1 Desg FWD 20000 128 False P2p </pre>
DEV B	<pre> FS#show spanning-tree summary Spanning tree enabled protocol mstp MST 0 vlans map : ALL Root ID Priority 0 Address 00d0.f822.3344 this bridge is root Hello Time 2 sec Forward Delay 15 sec Max Age 20 sec Bridge ID Priority 32768 Address 001a.a917.78cc Hello Time 2 sec Forward Delay 15 sec Max Age 20 sec Interface Role Sts Cost Prio OperEdge Type ----- Gi0/2 Root FWD 20000 128 False P2p Gi0/1 Altn BLK 20000 128 False P2p </pre>

Common Errors

N/A

32.4.6 Configuring the Port Path Cost

Configuration Effect

- Configure the path cost of a port to determine the forwarding state of the port and the topology of the entire network.
- If the path cost of a port uses its default value, configure the path cost calculation method to affect the calculation result.

Notes

- A device selects a port as the root port if the path cost from this port to the root bridge is the lowest. Therefore, the port path cost determines the root port of the local device. The default port path cost is automatically calculated based on the port rate (Media Speed). A port with a higher rate will have a low path cost. Since this method can calculate the most scientific path cost, do not change the path cost unless required. You can assign different path costs to different instances on a port so that each instance runs an independent STP based on the assigned path costs.
- If the port path cost uses the default value, the device automatically calculates the port path cost based on the port rate. However, IEEE 802.1d-1998 and IEEE 802.1t define different path costs for the same link rate. The value is a short integer ranging from 1 to 65,535 in 802.1d-1998 while is a long integer ranging from 1 to 200,000,000 in IEEE 802.1t. The path cost of an aggregate port (AP) has two solutions: 1. FS solution: Port Path Cost x 95%; 2. Solution recommended in standards: 20,000,000,000/Actual link bandwidth of the AP, in which Actual link bandwidth of the AP = Bandwidth of a member port x Number of active member ports. The administrator must unify the path cost calculation method in the entire network. The default standard is the private long integer standard.
- The following table lists path costs automatically configured for different link rate in two solutions.

Port Rate	Port	IEEE 802.1d (short)	IEEE 802.1t (long)	IEEE 802.1t (long standard)
10M	Common port	100	2000000	2000000
	AP	95	1900000	2000000÷linkupcnt
100M	Common port	19	200000	200000
	AP	18	190000	200000÷linkupcnt
1000M	Common port	4	20000	20000
	AP	3	19000	20000÷linkupcnt
10000M	Common port	2	2000	2000
	AP	1	1900	20000÷linkupcnt

- FS's long integer standard is used by default. After the solution is changed to the path cost solution recommended by the standards, the path cost of an AP changes with the number of member ports in UP state. If the port path cost changes, the network topology also will change.
- If an AP is static, linkupcnt in the table is the number of active member ports. If an AP is an LACP AP, linkupcnt in the table is the number of member ports forwarding AP data. If no member port in the AP goes up, linkupcnt is 1. For details about AP and LACP, see the *Configuring AP*.
- The modified port path cost takes effect only on the Rx port.

Configuration Steps

➤ **Configuring the Port Path Cost**

- Optional.
- To determine which port or path data packets prefer to pass through, configure the port path cost.

➤ **Configuring the Default Path Cost Calculation Method**

- Optional.
- To change the path cost calculation method, configure the default path cost calculation method.

Verification

- Display the configuration.
- Run the **show spanning-tree [mst instance-id] interface interface-id** command to display the spanning tree configuration of the port.

Related Commands

▾ **Configuring the Port Path Cost**

Command	spanning-tree [mst instance-id] cost cost
Parameter	mst instance-id: Indicates the instance ID, ranging from 0 to 64.
Description	cost cost: Indicates the path cost, ranging from 1 to 200,000,000.
Defaults	The default value of <i>instance-id</i> is 0. The default value is automatically calculated based on the port rate. 1000 Mbps—20000 100 Mbps—200000 10 Mbps—2000000
Command Mode	Interface configuration mode
Usage Guide	A larger value of <i>cost</i> indicates a higher path cost.

▾ **Configuring the Default Path Cost Calculation Method**

Command	spanning-tree pathcost method { long [standard] short }
Parameter	<i>long:</i> Uses the path cost specified in 802.1t.
Description	<i>standard:</i> Uses the cost calculated according to the standard. <i>short:</i> Uses the path cost specified in 802.1d.
Defaults	The path cost specified in 802.1t is used by default.
Command Mode	Global configuration mode
Usage Guide	If the port path cost uses the default value, the device automatically calculates the port path cost based on the port rate.

Configuration Example

▾ **Configuring the Port Path Cost**

<p>Scenario Figure 10- 24</p>	

Configuration Steps	<ul style="list-style-type: none"> ● Configure the bridge priority so that DEV A becomes the root bridge of the spanning tree. ● Configure the path cost of Gi 0/2 on DEV B is 1 so that Gi 0/2 can be selected as the root port.
DEV A	<pre>FS(config)#spanning-tree FS(config)#spanning-tree mst 0 priority 0</pre>
DEV B	<pre>FS(config)#spanning-tree FS(config)# int gi 0/2 FS(config-if-GigabitEthernet 0/2)# spanning-tree cost 1</pre>
Verification	<ul style="list-style-type: none"> ● Run the show spanning-tree summary command to display the topology calculation result of the spanning tree.
DEV A	<pre>FS# FS#show spanning-tree summary Spanning tree enabled protocol mstp MST 0 vlans map : ALL Root ID Priority 0 Address 00d0.f822.3344 this bridge is root Hello Time 2 sec Forward Delay 15 sec Max Age 20 sec Bridge ID Priority 0 Address 00d0.f822.3344 Hello Time 2 sec Forward Delay 15 sec Max Age 20 sec Interface Role Sts Cost Prio OperEdge Type ----- Gi0/2 Desg FWD 20000 128 False P2p Gi0/1 Desg FWD 20000 128 False P2p</pre>
DEV B	<pre>FS#show spanning-tree summary Spanning tree enabled protocol mstp MST 0 vlans map : ALL Root ID Priority 0 Address 00d0.f822.3344 this bridge is root</pre>

Hello Time		2 sec	Forward Delay		15 sec	Max Age		20 sec
Bridge ID	Priority	32768						
Address		001a.a917.78cc						
Hello Time		2 sec	Forward Delay		15 sec	Max Age		20 sec
Interface	Role	Sts	Cost	Prio	OperEdge Type			

Gi0/2	Root	FWD	1	128	False	P2p		
Gi0/1	Altn	BLK	20000	128	False	P2p		

Common Errors

- N/A

32.4.7 Configuring the Maximum Hop Count of a BPDU Packet

Configuration Effect

- Configure the maximum hop count of a BPDU packet to change the BPDU TTL and thereby affect the network topology.

Notes

- The default maximum hop count of a BPDU packet is 20. Generally, it is not recommended to change the default value.

Configuration Steps

➤ **Configuring the Maximum Hop Count**

- (Optional) If the network topology is so large that a BPDU packet exceeds the default 20 hops, it is recommended to change the maximum hop count.

Verification

- Display the configuration.

Related Commands

➤ **Configuring the Maximum Hop Count**

Command	spanning-tree max-hops <i>hop-count</i>
Parameter Description	<i>hop-count</i> : Indicates the number of devices a BPDU passes through before being discarded. It ranges from 1 to 40.
Defaults	The default value of <i>hop-count</i> is 20.
Command Mode	Global configuration mode
Usage Guide	In a region, the BPDU sent by the root bridge includes a hop count. Every time a BPDU passes through a device from the root bridge, the hop count decreases by 1. When the hop count becomes 0, the BPDU times out and the device

	<p>discards the packet.</p> <p>This command specifies the number of devices a BPDU passes through in a region before being discarded. Changing the maximum hop count will affect all instances.</p>
--	---

Configuration Example

↘ Configuring the Maximum Hop Count of a BPDU Packet

Configuration Steps	<ul style="list-style-type: none"> ● Set the maximum hop count of a BPDU packet to 25.
	<pre>FS(config)# spanning-tree max-hops 25</pre>
Verification	<ul style="list-style-type: none"> ● Run the show spanning-tree command to display the configuration.
	<pre>FS# show spanning-tree StpVersion : MSTP SysStpStatus : ENABLED MaxAge : 20 HelloTime : 2 ForwardDelay : 15 BridgeMaxAge : 20 BridgeHelloTime : 2 BridgeForwardDelay : 15 MaxHops: 25 TxHoldCount : 3 PathCostMethod : Long BPDUGuard : Disabled BPDUFilter : Disabled LoopGuardDef : Disabled ##### mst 0 vlans map : ALL BridgeAddr : 00d0.f822.3344 Priority: 0 TimeSinceTopologyChange : 2d:0h:46m:4s TopologyChanges : 25 DesignatedRoot : 0.001a.a917.78cc RootCost : 0 RootPort : GigabitEthernet 0/1 CistRegionRoot : 0.001a.a917.78cc</pre>

```
CistPathCost : 20000
```

32.4.8 Enabling PortFast-related Features

Configuration Effect

- After PortFast is enabled on a port, the port directly enters the forwarding state. However, since the Port Fast Operational State becomes disabled due to receipt of BPDUs, the port can properly run the STP algorithm and enter the forwarding state.
- If BPDU guard is enabled on a port, the port enters the error-disabled state after receiving a BPDU.
- If BPDU filter is enabled on a port, the port neither sends nor receives BPDUs.

Notes

- The global BPDU guard takes effect only when PortFast is enabled on a port.
- If BPDU filter is enabled globally, a PortFast-enabled port neither sends nor receives BPDUs. In this case, the host connecting directly to the PortFast-enabled port does not receive any BPDUs. If the port changes its Port Fast Operational State to Disabled after receiving a BPDU, BPDU filter automatically fails.
- The global BPDU filter takes effect only when PortFast is enabled on a port.

Configuration Steps

↘ Enabling PortFast

- Optional.
- If a port connects directly to the network terminal, configure this port as a PortFast port.

↘ Enabling BPDU Guard

- Optional.
- If device ports connect directly to network terminals, you can enable BPDU guard on these ports to prevent BPDU attacks from causing abnormality in the spanning tree topology. A port enabled with BPDU guard enters the error-disabled state after receiving a BPDU.
- If device ports connect directly to network terminals, you can enable BPDU guard to prevent loops on the ports. The prerequisite is that the downlink device (such as the hub) can forward BPDU packets.

↘ Enabling BPDU Filter

- Optional.
- To prevent abnormal BPDU packets from affecting the spanning tree topology, you can enable BPDU filter on a port to filter abnormal BPDU packets.

Verification

- Display the configuration.
- Run the **show spanning-tree [mst instance-id] interface interface-id** command to display the spanning tree configuration of the port.

Related Commands

↘ Configuring PortFast

Command	spanning-tree portfast
Parameter	N/A
Description	
Defaults	PortFast is disabled on a port by default.
Command Mode	Interface configuration mode
Usage Guide	After PortFast is enabled on a port, the port directly enters the forwarding state. However, since the Port Fast Operational State becomes disabled due to receipt of BPDUs, the port can properly run the STP algorithm and enter the forwarding state.

↘ Configuring BPDU Guard for all Ports

Command	spanning-tree portfast bpduguard default
Parameter	N/A
Description	
Defaults	BPDU guard is globally disabled by default.
Command Mode	Global configuration mode
Usage Guide	If BPDU guard is enabled on a port, the port enters the error-disabled state after receiving a BPDU. Run the show spanning-tree command to display the configuration.

↘ Configuring BPDU Guard for a Port

Command	spanning-tree bpduguard enabled
Parameter	N/A
Description	
Defaults	BPDU guard is disabled on a port by default.
Command Mode	Interface configuration mode
Usage Guide	If BPDU guard is enabled on a port, the port enters the error-disabled state after receiving a BPDU.

↘ Configuring BPDU Filter for all Ports

Command	spanning-tree portfast bpdufilter default
Parameter	N/A
Description	
Defaults	BPDU filter is globally disabled by default.
Command Mode	Global configuration mode
Usage Guide	If BPDU filter is enabled, corresponding ports neither send nor receive BPDUs.

↘ Configuring BPDU Filter for a Port

Command	spanning-tree bpdufilter enabled
Parameter	N/A

Description	
Defaults	BPDU filter is disabled on a port by default.
Command Mode	Interface configuration mode
Usage Guide	If BPDU filter is enabled on a port, the port neither sends nor receives BPDUs.

Configuration Example

▾ **Enabling PortFast on a Port**

<p>Scenario Figure 10- 25</p>	
<p>Configuration Steps</p>	<ul style="list-style-type: none"> ● Configure Gi 0/3 of DEV C as a PortFast port and enable BPDU guard.
<p>DEV C</p>	<pre>FS(config)# int gi 0/3 FS(config-if-GigabitEthernet 0/3)# spanning-tree portfast %Warning: portfast should only be enabled on ports connected to a single host. Connecting hubs, switches, bridges to this interface when portfast is enabled,can cause temporary loops. FS(config-if-GigabitEthernet 0/3)#spanning-tree bpduguard enable</pre>
<p>Verification</p>	<ul style="list-style-type: none"> ● Run the show spanning-tree interface command to display the port configuration.
<p>DEV C</p>	<pre>FS#show spanning-tree int gi 0/3 PortAdminPortFast : Enabled PortOperPortFast : Enabled PortAdminAutoEdge : Enabled PortOperAutoEdge : Enabled PortAdminLinkType : auto PortOperLinkType : point-to-point</pre>

<pre> PortBPDUGuard : Enabled PortBPDUFilter : Disabled PortGuardmode : None ##### MST 0 vlans mapped :ALL PortState : forwarding PortPriority : 128 PortDesignatedRoot : 0.00d0.f822.3344 PortDesignatedCost : 0 PortDesignatedBridge :0.00d0.f822.3344 PortDesignatedPortPriority : 128 PortDesignatedPort : 4 PortForwardTransitions : 1 PortAdminPathCost : 20000 PortOperPathCost : 20000 Inconsistent states : normal PortRole : designatedPort </pre>

32.4.9 Enabling TC-related Features

Configuration Effect

- If TC protection is enabled on a port, the port deletes TC BPDU packets within a specified time (generally 4 seconds) after receiving them, preventing MAC and ARP entry from being removed.
- If TC guard is enabled, a port receiving TC packets filters TC packets received or generated by itself so that TC packets are not spread to other ports. In this way, possible TC attacks are efficiently prevented to keep the network stable.
- TC filter does not process TC packets received by ports but processes TC packets in case of normal topology changes.

Notes

- It is recommended to enable TC guard only when illegal TC attack packets are received in the network.

Configuration Steps

↘ Enabling TC Protection

- Optional.
- TC protection is disabled by default.

↘ Enabling TC Guard

- Optional.
- TC guard is disabled by default.

- To filter TC packets received or generated due to topology changes, you can enable TC guard.

↘ Enabling TC Filter

- Optional.
- TC filter is disabled by default.
- To filter TC packets received on a port, you can enable TC filter on the port.

Verification

- Display the configuration.

Related Commands

↘ Enabling TC Protection

Command	spanning-tree tc-protection
Parameter	N/A
Description	
Defaults	TC protection is disabled by default.
Command Mode	Global configuration mode
Usage Guide	N/A

↘ Configuring TC Guard for all Ports

Command	spanning-tree tc-protection tc-guard
Parameter	N/A
Description	
Defaults	TC guard is globally disabled by default.
Command Mode	Global configuration mode
Usage Guide	Enable TC guard to prevent TC packets from spreading.

↘ Configuring TC Guard for a Port

Command	spanning-tree tc-guard
Parameter	N/A
Description	
Defaults	TC guard is disabled on a port by default.
Command Mode	Interface configuration mode
Usage Guide	Enable TC guard to prevent TC packets from spreading.

↘ Configuring TC Filter for a Port

Command	spanning-tree ignore tc
Parameter	N/A
Description	

Defaults	TC filter is disabled by default.
Command	Interface configuration mode
Mode	
Usage Guide	If TC filter is enabled on a port, the port does not process received TC packets.

Configuration Example

▾ Enabling TC Guard on a Port

Configuration Steps	Enable TC guard on a port.
	<pre>FS(config)#int gi 0/1 FS(config-if-GigabitEthernet 0/1)#spanning-tree tc-guard</pre>
Verification	<ul style="list-style-type: none"> ● Run the show run interface command to display the TC guard configuration of the port.
	<pre>FS#show run int gi 0/1 Building configuration... Current configuration : 134 bytes interface GigabitEthernet 0/1 switchport mode trunk spanning-tree tc-guard</pre>

Common Errors

- If TC guard or TC filter is incorrectly configured, an error may occur during packet forwarding of the network device. For example, when the topology changes, the device fails to clear MAC address in a timely manner, causing packet forwarding errors.

32.4.10 Enabling BPDU Source MAC Address Check

Configuration Effect

- Enable BPDU source MAC address check. After this, a device receives only BPDU packets with the source MAC address being the specified MAC address and discards other BPDU packets.

Notes

- When the switch connected to a port on a point-to-point link is determined, you can enable BPDU source MAC address check so that the switch receives the BPDU packets sent only by the peer switch.

Configuration Steps

▾ Enabling BPDU Source MAC Address Check

- Optional.

- BPDUs source MAC address check is disabled by default.
- To prevent malicious BPDU attacks, you can enable BPDU source MAC address check.

Verification

- Display the configuration.

Related Commands

▾ **Enabling BPDU Source MAC Address Check**

Command	bpdu src-mac-check H.H.H
Parameter	<i>H.H.H</i> : Indicates an MAC address. The device receives only BPDU packets with this address being the source MAC
Description	address.
Defaults	BPDU source MAC address check is disabled by default.
Command Mode	Interface configuration mode
Usage Guide	BPDU source MAC address check prevents BPDU packets from maliciously attacking switches and causing MSTP abnormal. When the switch connected to a port on a point-to-point link is determined, you can enable BPDU source MAC address check to receive BPDU packets sent only by the peer switch and discard all other BPDU packets, thereby preventing malicious attacks. You can enable BPDU source MAC address check in interface configuration mode for a specific port. One port can only filter one MAC address.

Configuration Example

▾ **Enabling BPDU Source MAC Address Check on a Port**

Configuration Steps	Enable BPDU source MAC address check on a port.
	<pre>FS(config)#int gi 0/1 FS(config-if-GigabitEthernet 0/1)#bpdu src-mac-check 00d0.f800.1234</pre>
Verification	<ul style="list-style-type: none"> ● Run the show run interface command to display the spanning tree configuration of the port.
	<pre>FS#show run int gi 0/1 Building configuration... Current configuration : 170 bytes interface GigabitEthernet 0/1 switchport mode trunk bpdu src-mac-check 00d0.f800.1234</pre>

	spanning-tree link-type point-to-point
--	--

Common Errors

- If BPDU source MAC address check is enabled on a port, the port receives only BPDU packets with the configured MAC address being the source MAC address and discards all other BPDU packets.

32.4.11 Configuring Auto Edge

Configuration Effect

- Enable Auto Edge. If a designated port does not receive any BPDUs within a specified time (3 seconds), it is automatically identified as an edge port. However, if the port receives BPDUs, its Port Fast Operational State will become Disabled.

Notes

- Unless otherwise specified, do not disable Auto Edge.
- By default, the port is automatically identified as an edge port and enters the forwarding state if a designated port does not receive any BPDUs within 3 seconds. If packet loss or packet Tx/Rx delay occurs in the network, it is recommended to disable Auto Edge.

Configuration Steps

⌵ **Configuring Auto Edge**

- Optional.
- Auto Edge is enabled by default.

Verification

- Display the configuration.

Related Commands

⌵ **Configuring Auto Edge**

Command	spanning-tree autoedge
Parameter	N/A
Description	
Defaults	Auto Edge is enabled by default.
Command Mode	Interface configuration mode
Usage Guide	<p>If the designated port of a device does not receive a BPDU from the downlink port within a specific period (3 seconds), the device regards a network device connected to the designated port, configures the port as an edge port, and switches the port directly into the forwarding state. The edge port will be automatically identified as a non-edge port after receiving a BPDU.</p> <p>You can run the spanning-tree autoedge disabled command to disable Auto Edge.</p>

Configuration Example

Disabling Auto Edge on a Port

Configuration Steps	Disable Auto Edge on a port.
	<pre>FS(config)#int gi 0/1 FS(config-if-GigabitEthernet 0/1)#spanning-tree autoedge disabled</pre>
Verification	<ul style="list-style-type: none"> ● Run the show spanning-tree interface command to display the spanning tree configuration of the port.
	<pre>FS#show spanning-tree interface gi 0/1 PortAdminPortFast : Disabled PortOperPortFast : Disabled PortAdminAutoEdge : Disabled PortOperAutoEdge : Disabled PortAdminLinkType : point-to-point PortOperLinkType : point-to-point PortBPDUGuard : Disabled PortBPDUFilter : Disabled PortGuardmode : None ##### MST 0 vlans mapped :ALL PortState : forwarding PortPriority : 128 PortDesignatedRoot : 0.00d0.f822.3344 PortDesignatedCost : 0 PortDesignatedBridge :0.00d0.f822.3344 PortDesignatedPortPriority : 128 PortDesignatedPort : 2 PortForwardTransitions : 6 PortAdminPathCost : 20000 PortOperPathCost : 20000 Inconsistent states : normal PortRole : designatedPort</pre>

Common Errors

32.4.12 Enabling Guard-related Features

Configuration Effect

- If root guard is enabled on a port, its roles on all instances are enforced as the designated port. Once the port receives configuration information with a higher priority, it enters the root-inconsistent (blocking) state. If the port does not receive configuration information with a higher priority within a period, it returns to its original state.
- Due to the unidirectional link failure, the root port or backup port becomes the designated port and enters the forwarding state if it does not receive BPDUs, causing a network loop. Loop guard is to prevent this problem.

Notes

- Root guard and loop guard cannot take effect on a port at the same time.

Configuration Steps

↘ Enabling Root Guard

- Optional.
- The root bridge may receive configuration with a higher priority due to incorrect configuration by maintenance personnel or malicious attacks in the network. As a result, the current root bridge may lose its role, causing incorrect topology changes. To prevent this problem, you can enable root guard on a designated port of a device.

↘ Enabling Loop Guard

- Optional.
- You can enable loop guard on a port (root port, master port, or AP) to prevent it from failing to receive BPDUs sent by the designated bridge, increasing device stability. Otherwise, the network topology will change, possibly causing a loop.

↘ Disabling Guard

- Optional.
- Guard is disabled by default.

Verification

- Display the configuration.

Related Commands

↘ Enabling Root Guard

Command	spanning-tree guard root
Parameter	N/A
Description	
Defaults	Root guard is disabled by default.

Command Mode	Interface configuration mode
Usage Guide	If root guard is enabled, the current root bridge will not change due to incorrect configuration or illegal packet attacks.

↘ **Enabling Loop Guard of all Ports**

Command	spanning-tree loopguard default
Parameter Description	N/A
Defaults	Loop guard is disabled by default.
Command Mode	Global configuration mode
Usage Guide	Enabling loop guard on a root port or backup port will prevent possible loops caused by BPDU receipt failure.

↘ **Enabling Loop Guard of a Port**

Command	spanning-tree guard loop
Parameter Description	N/A
Defaults	Loop guard is disabled by default.
Command Mode	Interface configuration mode
Usage Guide	Enabling loop guard on a root port or backup port will prevent possible loops caused by BPDU receipt failure.

↘ **Disabling Guard**

Command	spanning-tree guard none
Parameter Description	N/A
Defaults	Guard is disabled by default.
Command Mode	Interface configuration mode
Usage Guide	N/A

Configuration Example

↘ **Enabling Loop Guard on a Port**

<p>Scenario Figure 10- 26</p>	
<p>Configuration Steps</p>	<ul style="list-style-type: none"> ● Configure DEV A as the root bridge and DEV B as a non-root bridge on a spanning tree. ● Enable loop guard on ports Gi 0/1 and Gi 0/2 of DEV B.
<p>DEV A</p>	<pre>FS(config)#spanning-tree FS(config)#spanning-tree mst 0 priority 0</pre>
<p>DEV B</p>	<pre>FS(config)#spanning-tree FS(config)# int range gi 0/1-2 FS(config-if-range)#spanning-tree guard loop</pre>
<p>Verification</p>	<ul style="list-style-type: none"> ● Run the show spanning-tree interface command to display the spanning tree configuration of the port.
<p>DEV A</p>	<p>Omitted.</p>
<p>DEV B</p>	<pre>FS#show spanning-tree int gi 0/1 PortAdminPortFast : Disabled PortOperPortFast : Disabled PortAdminAutoEdge : Enabled PortOperAutoEdge : Disabled PortAdminLinkType : auto PortOperLinkType : point-to-point PortBPDUGuard : Disabled PortBPDUFilter : Disabled PortGuardmode : Guard loop ##### MST 0 vlans mapped :ALL PortState : forwarding PortPriority : 128</pre>

```
PortDesignatedRoot : 0.001a.a917.78cc
PortDesignatedCost : 0
PortDesignatedBridge :0.001a.a917.78cc
PortDesignatedPortPriority : 128
PortDesignatedPort : 17
PortForwardTransitions : 1
PortAdminPathCost : 20000
PortOperPathCost : 20000
Inconsistent states : normal
PortRole : rootPort
```

```
FS#show spanning-tree int gi 0/2
```

```
PortAdminPortFast : Disabled
PortOperPortFast : Disabled
PortAdminAutoEdge : Enabled
PortOperAutoEdge : Disabled
PortAdminLinkType : auto
PortOperLinkType : point-to-point
PortBPDUGuard : Disabled
PortBPDUFilter : Disabled
PortGuardmode : Guard loop
```

```
##### MST 0 vlans mapped :ALL
```

```
PortState : discarding
PortPriority : 128
PortDesignatedRoot : 0.001a.a917.78cc
PortDesignatedCost : 0
PortDesignatedBridge :0.001a.a917.78cc
PortDesignatedPortPriority : 128
PortDesignatedPort : 18
PortForwardTransitions : 1
PortAdminPathCost : 20000
PortOperPathCost : 20000
```

	Inconsistent states : normal PortRole : alternatePort
--	--

Common Errors

- If root guard is enabled on the root port, master port, or AP, the port may be incorrectly blocked.

32.4.13 Enabling BPDU Transparent Transmission

Configuration Effect

- If STP is disabled on a device, the device needs to transparently transmit BPDU packets so that the spanning tree between devices is properly calculated.

Notes

- BPDU transparent transmission takes effect only when STP is disabled. If STP is enabled on a device, the device does not transparently transmit BPDU packets.

Configuration Steps

➤ **Enabling BPDU Transparent Transmission**

- Optional.
- If STP is disabled on a device that needs to transparently transmit BPDU packets, enable BPDU transparent transmission.

Verification

- Display the configuration.

Related Commands

➤ **Enabling BPDU Transparent Transmission**

Command	bridge-frame forwarding protocol bpdu
Parameter	N/A
Description	
Defaults	BPDU transparent transmission is disabled by default.
Command Mode	Global configuration mode
Usage Guide	<p>In IEEE 802.1Q, the destination MAC address 01-80-C2-00-00-00 of the BPDU is used as a reserved address. That is, devices compliant with IEEE 802.1Q do not forward the BPDU packets received. However, devices may need to transparently transmit BPDU packets in actual network deployment. For example, if STP is disabled on a device, the device needs to transparently transmit BPDU packets so that the spanning tree between devices is properly calculated.</p> <p>BPDU transparent transmission takes effect only when STP is disabled. If STP is enabled on a device, the device does not transparently transmit BPDU packets.</p>

Configuration Example

➤ **Enabling BPDU Transparent Transmission**

<p>Scenario Figure 10-27</p>	
	<p>STP is enabled on DEV A and DEV C while is disabled on DEV B.</p>
<p>Configuration Steps</p>	<ul style="list-style-type: none"> ● Enable BPDU transparent transmission on DEV B so that STP between DEV A and DEV C can be correctly calculated.
<p>DEV B</p>	<pre>FS(config)#bridge-frame forwarding protocol bpdu</pre>
<p>Verification</p>	<ul style="list-style-type: none"> ● Run the show run command to check whether BPDU transparent transmission is enabled.
<p>DEV B</p>	<pre>FS#show run Building configuration... Current configuration : 694 bytes bridge-frame forwarding protocol bpdu</pre>

32.4.14 Enabling BPDU Tunnel

Configuration Effect

- Enable BPDU Tunnel so that STP packets from the customer network can be transparently transmitted across the SP network. STP packet transmission between the customer network does not affect the SP network, causing STP on the customer network to be calculated independently of that on the SP network.

Notes

- BPDU Tunnel takes effect only when it is enabled in both global configuration mode and interface configuration mode.

Configuration Steps

➤ **Enabling BPDU Tunnel**

- (Optional) In a QinQ network, you can enable BPDU Tunnel if STP needs to be calculated separately between customer networks and SP networks.

Verification

- Run the **show l2protocol-tunnel stp** command to display the BPDU Tunnel configuration.

Related Commands

➤ **Configuring BPDU Tunnel in Global Configuration Mode**



<p>Command</p>	<p>l2protocol-tunnel stp</p>
-----------------------	-------------------------------------

Parameter	N/A
Description	
Defaults	BPDU Tunnel is disabled by default.
Command	Global configuration mode
Mode	
Usage Guide	BPDU Tunnel takes effect only when it is enabled in both global configuration mode and interface configuration mode.

↘ **Configuring BPDU Tunnel in Interface Configuration Mode**

Command	I2protocol-tunnel stp enable
Parameter	N/A
Description	
Defaults	BPDU Tunnel is disabled by default.
Command	Interface configuration mode
Mode	
Usage Guide	BPDU Tunnel takes effect only when it is enabled in both global configuration mode and interface configuration mode.

↘ **Configuring BPDU Tunnel Transparent Transmission Address**

Command	I2protocol-tunnel stp tunnel-dmac <i>mac-address</i>
Parameter	<i>mac-address</i> : Indicates the STP address for transparent transmission.
Description	
Defaults	The default MAC address is 01d0.f800.0005.
Command	Global configuration mode
Mode	
Usage Guide	<p>If an STP packet sent from a customer network enters a PE, the PE changes the destination MAC address of the packet to a private address before the packet is forwarded by the SP network. When the packet reaches the PE at the peer end, the PE changes the destination MAC address to a public address and returns the packet to the customer network at the peer end, realizing transparent transmission across the SP network. This private address is the transparent transmission address of BPDU Tunnel.</p> <p> Optional transparent transmission addresses of STP packets include 01d0.f800.0005, 011a.a900.0005, 010f.e200.0003, 0100.0ccd.cdd0, 0100.0ccd.cdd1, and 0100.0ccd.cdd2.</p> <p> If no transparent transmission address is configured, BPDU Tunnel uses the default address 01d0.f800.0005.</p>

Configuration Example

↘ **Enabling BPDU Tunnel**

<p>Scenario Figure 10-28</p>	
<p>Configuration Steps</p>	<ul style="list-style-type: none"> ● Enable basic QinQ on the PEs (Provider S1/Provider S2 in this example) so that data packets of the customer network are transmitted within VLAN 200 on the SP network. ● Enable STP transparent transmission on the PEs (Provider S1/Provider S2 in this example) so that the SP network can transmit STP packets of the customer network through BPDU Tunnel.
<p>Provider S1</p>	<p>Step 1: Create VLAN 200 on the SP network.</p> <pre>FS#configure terminal Enter configuration commands, one per line. End with CNTL/Z. FS(config)#vlan 200 FS(config-vlan)#exit</pre> <p>Step 2: Enable basic QinQ on the port connected to the customer network and use VLAN 20 for tunneling.</p> <pre>FS(config)#interface gigabitEthernet 0/1 FS(config-if-GigabitEthernet 0/1)#switchport mode dot1q-tunnel FS(config-if-GigabitEthernet 0/1)#switchport dot1q-tunnel native vlan 200 FS(config-if-GigabitEthernet 0/1)#switchport dot1q-tunnel allowed vlan add untagged 200</pre> <p>Step 3: Enable STP transparent transmission on the port connected to the customer network.</p> <pre>FS(config-if-GigabitEthernet 0/1)#l2protocol-tunnel stp enable FS(config-if-GigabitEthernet 0/1)#exit</pre> <p>Step 4: Enable STP transparent transmission in global configuration mode.</p> <pre>FS(config)#l2protocol-tunnel stp</pre> <p>Step 5: Configure an Uplink port.</p> <pre>FS(config)# interface gigabitEthernet 0/5 FS(config-if-GigabitEthernet 0/5)#switchport mode uplink</pre>
<p>Provider S2</p>	<p>Configure Provider S2 by performing the same steps.</p>

<p>Verification</p>	<ul style="list-style-type: none"> ● Check whether the BPDU Tunnel configuration is correct. ● Verify the Tunnel port configuration by checking whether: 1. The port type is dot1q-tunnel; 2. The outer tag VLAN is consistent with the native VLAN and added to the VLAN list of the Tunnel port; 3. The port that accesses the SP network is configured as an Uplink port.
<p>Provider S1</p>	<p>Step 1: Check whether the BPDU Tunnel configuration is correct.</p> <pre>FS#show l2protocol-tunnel stp L2protocol-tunnel: stp Enable L2protocol-tunnel destination mac address: 01d0.f800.0005 GigabitEthernet 0/1 l2protocol-tunnel stp enable</pre> <p>Step 2: Check whether the QinQ configuration is correct.</p> <pre>FS#show running-config interface GigabitEthernet 0/1 switchport mode dot1q-tunnel switchport dot1q-tunnel allowed vlan add untagged 200 switchport dot1q-tunnel native vlan 200 l2protocol-tunnel stp enable spanning-tree bpdudfilter enable ! interface GigabitEthernet 0/5 switchport mode uplink</pre>
<p>Provider S2</p>	<p>Verify Provider S2 configuration by performing the same steps.</p>

Common Errors

- In the SP network, BPDU packets can be correctly transparently transmitted only when the transparent transmission addresses of BPDU Tunnel are consistent.

32.4.15Configuring VSTP

Configuration Effect

- Enable the VSTP function to prevent layer-2 loop in the M-LAG scenario.

Notes

- VSTP is only applicable to the M-LAG scenario.

Configuration Steps

➤ Enabling VSTP

- Optional.
- In global configuration mode, run the **spanning-tree v-stp enable** command to enable the VSTP function and the **no spanning-tree v-stp enable** command to disable VSTP.

Command	spanning-tree v-stp enable
Parameter	N/A
Description	
Defaults	VSTP is disabled by default.
Command Mode	Global configuration mode
Usage Guide	<p>VSTP is used to prevent the layer-loop in the M-LAG scenario. VSTP is supported by STP, RSTP and MSTP. To make VSTP take effect, the following conditions should be met:</p> <ol style="list-style-type: none"> 1. Enable VSTP on all M-LAG member devices. 2. Configure the identical STP configuration on all M-LAG member devices, for example, device priority, MSTP field configuration, port cost and port priority. 3. Interconnect all M-LAG member devices.

Verification

- Run the **show running-config** command to display the VSTP configuration.

```
FS#show running-config

Building configuration...

Current configuration : 7359 bytes

spanning-tree v-stp enable
spanning-tree
```

- Run the **show spanning-tree v-stp information** command to display the VSTP status.

```
FS#show spanning-tree v-stp information

V-STP status           : enable
Local bridge mac       : 00d0.f822.33ed
Selected bridge mac    : 5869.6c7b.b4a2
Peerlink Port          : AggregatePort 4
Calculate Virtrual Index : 4095
Mlag Remote device connected : Y

MST 0 Root Port       : None
```

Configuration Example

▾ **Enabling VSTP**

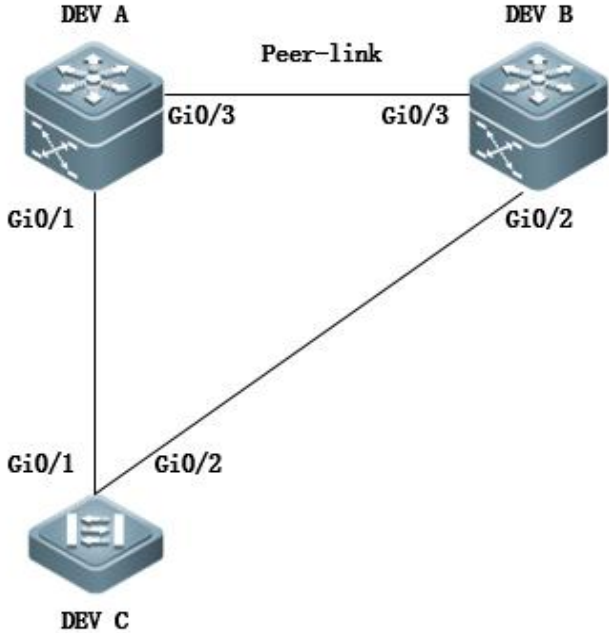
<p>Scenario Figure 10-29</p>	
<p>Configuration Steps</p>	<ul style="list-style-type: none"> ●
<p>Device A, B, C</p>	<p>Step 1: Enable RSTP on device A, B and C.</p> <pre>FS#configure terminal Enter configuration commands, one per line. End with CNTL/Z. FS(config)#spanning-tree FS(config)#spanning-tree mode rstp</pre>
<p>Device A, B</p>	<p>Step 2: Enable VSTP on device A and B.</p> <pre>FS(config)#spanning-tree v-stp enable</pre>
<p>Verification</p>	<pre>FS#show run Building configuration... Current configuration : 694 bytes spanning-tree v-stp enable</pre>

Common Errors

- VSTP is disabled on some M-LAG member device, leading to VSTP calculation error.
- STP configuration of the M-LAG member device is not identical, leading to VSTP calculation error.
- The M-LAG member devices are not interconnected, leading to STP virtualization failure.

32.5 Monitoring

Clearing

 Running the **clear** commands may lose vital information and thus interrupt services.

Description	Command
Clears the statistics of packets sent and received on a port.	clear spanning-tree counters [interface <i>interface-id</i>]
Clears the STP topology change information.	clear spanning-tree mst <i>instance-id</i> topochange record

Displaying

Description	Command
Displays MSTP parameters and spanning tree topology information.	show spanning-tree
Displays the count of sent and received MSTP packets.	show spanning-tree counters [interface <i>interface-id</i>]
Displays MSTP instances and corresponding port forwarding status.	show spanning-tree summary
Displays the ports that are blocked by root guard or loop guard.	show spanning-tree inconsistentports
Displays the configuration of an MST region.	show spanning-tree mst configuration
Displays MSTP information of an instance.	show spanning-tree mst <i>instance-id</i>
Displays MSTP information of the instance corresponding to a port.	show spanning-tree mst <i>instance-id</i> interface <i>interface-id</i>
Displays topology changes of a port in an instance.	show spanning-tree mst <i>instance-id</i> topochange record
Displays MSTP information of all instances corresponding to a port.	show spanning-tree interface <i>interface-id</i>
Displays the forwarding time.	show spanning-tree forward-time
Displays the hello time.	show spanning-tree hello time
Displays the maximum hop count.	show spanning-tree max-hops
Displays the maximum number of BPDU packets sent per second.	show spanning-tree tx-hold-count
Displays the path cost calculation method.	show spanning-tree pathcost method
Displays BPDU Tunnel information.	show l2protocol-tunnel stp
Displays the VSTP configuration.	show spanning-tree v-stp information

Debugging



System resources are occupied when debugging information is output. Therefore, disable the debugging switch immediately after use.

Description	Command
Debugs all STPs.	debug mstp all
Debugs MSTP Graceful Restart (GR).	debug mstp gr
Debugs BPDU packet receiving.	debug mstp rx
Debugs BPDU packet sending.	debug mstp tx
Debugs MSTP events.	debug mstp event
Debugs loop guard.	debug mstp loopguard
Debugs root guard.	debug mstp rootguard
Debugs the bridge detection state machine.	debug mstp bridgedetect
Debugs the port information state machine.	debug mstp portinfo
Debugs the port protocol migration state machine.	debug mstp protomigrat
Debugs MSTP topology changes.	debug mstp topochange
Debugs the MSTP receiving state machine.	debug mstp receive
Debugs the port role transition state machine.	debug mstp roletran
Debugs the port state transition state machine.	debug mstp statetran
Debugs the MSTP sending state machine.	debug mstp transmit
Debugs the VSTP message.	Debug mstp vstp msg
Debugs the VSTP message sending.	debug mstp vstp send
Debugs the VSTP message receiving.	debug mstp vstp recv

33 Configuring GVRP

34 Overview

The GARP VLAN Registration Protocol (GVRP) is an application of the Generic Attribute Registration Protocol (GARP) used to dynamically configure and proliferate VLAN memberships.

GVRP simplifies VLAN configuration and management. It reduces the workload of manually configuring VLANs and adding ports to VLANs, and reduces the possibility of network disconnection due to inconsistent configuration. With GVRP, you can dynamically maintain VLANs and add/remove ports to/from VLANs to ensure VLAN connectivity in a topology.

Protocols and Standards

IEEE standard 802.1D

IEEE standard 802.1Q

34.1 Applications

Application	Description
GVRP Configuration in a LAN	Connect two switches in a local area network (LAN) and realize VLAN synchronization.
GVRP PDUs Tunnel Application	Use the GVRP Protocol Data Units (PDUs) Tunnel feature to transparently transmit GVRP packets through a tunnel in a QinQ network environment.

34.1.1 GVRP Configuration in a LAN

Scenario

Enable GVRP and set the GVRP registration mode to Normal to register and deregister all dynamic and static VLANs between Device A and Device F.

Figure 11- 1

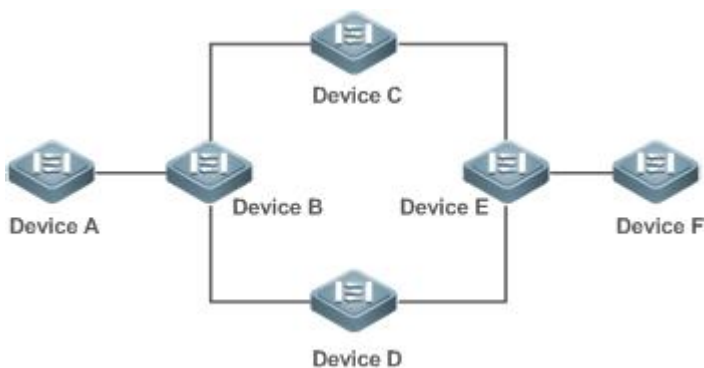

Remarks	Device A, Device B, Device C, Device D, Device E, and Device F are switches. The ports connected between two devices are Trunk ports. On Device A and Device F, configure static VLANs used for communication. Enable GVRP on all switches.
----------------	---

Deployment

- On each device, enable the GVRP and dynamic VLAN creation features, and ensure that dynamic VLANs can be created on intermediate devices.
- On Device A and Device F, configure static VLANs used for communication. Device B, Device C, Device D, and Device E will dynamically learn the VLANs through GVRP.

 It is recommended that the Spanning Tree Protocol (STP) be enabled to avoid loops in the customer network topology.

34.1.2 GVRP PDUs Tunnel Application

Scenario

A QinQ network environment is generally divided into a customer network and a service provider (SP) network. The GVRP PDUs Tunnel feature allows GVRP packets to be transmitted between customer networks without impact on SP networks. The GVRP calculation in customer networks is separated from that in SP networks without interference.

Figure 11- 2 GVRP PDUs Tunnel Application Topology

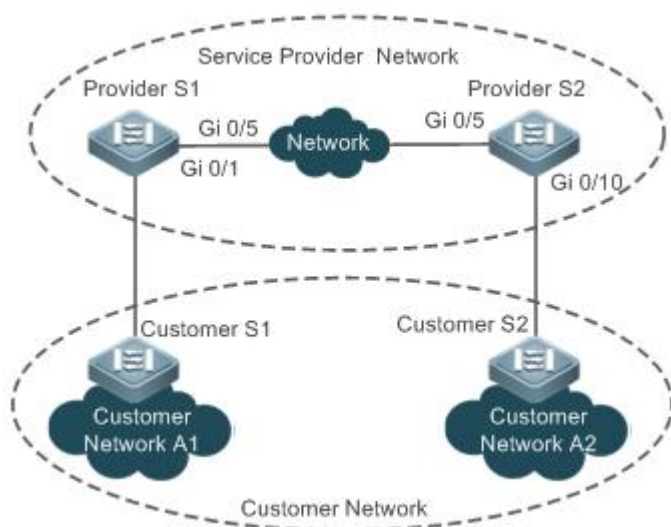

Remarks	<p>Figure 11- 2 shows an SP network and a customer network. The SP network contains the provider edge (PE) devices Provider S1 and Provider S2. Customer Network A1 and Customer Network A2 are the same customer's two sites in different locations. Customer S1 and Customer S2 are the access devices in the customer network, which are connected to the SP network through Provider S1 and Provider S2 respectively.</p> <p>The GVRP PDUs Tunnel feature allows Customer Network A1 and Customer Network A2 to perform unified GVRP calculation across the SP network, without impact on the SP network's GVRP calculation.</p>
----------------	--

Deployment

- Enable basic QinQ on the PEs (Provider S1 and Provider S2) in the SP network to transmit data packets from the customer network through a specified VLAN in the SP network.
- Enable GVRP transparent transmission on the PEs (Provider S1 and Provider S2) in the SP network to allow the SP network to tunnel GVRP packets from the customer network via the GVRP PDUs Tunnel feature.

34.2Features

Basic Concepts

GVRP

GVRP is an application of GARP used to register and deregister VLAN attributes in the following modes:

- When a port receives a VLAN attribute declaration, the port will register the VLAN attributes contained in the declaration (that is, the port will join the VLAN).
- When a port receives a VLAN attribute revocation declaration, the port will deregister the VLAN attributes contained in the declaration (that is, the port will exit the VLAN).

Figure 11-3

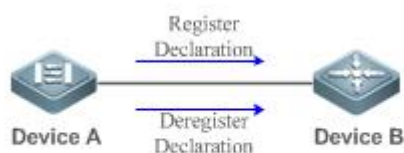

Dynamic VLAN

A VLAN that can be dynamically created and deleted without the need for manual configuration is called a dynamic VLAN.

You can manually convert a dynamic VLAN to a static VLAN, but not the way around.

A protocol state machine controls the joining of ports to dynamic VLANs created through GVRP. Only the Trunk ports that receive GVRP VLAN attribute declaration can join these VLANs. You cannot manually add ports to dynamic VLANs.

Message Types

(1) Join message

When a GARP application entity hopes other GARP entities to register its attributes, it will send a Join message. When a GARP entity receives a Join message from another entity or requires other entities to register its static attributes, it will send a Join message. There are two types of Join message: JoinEmpty and JoinIn.

- JoinEmpty message: Used to declare an unregistered attribute
- JoinIn message: Used to declare a registered attribute

(2) Leave message

When a GARP application entity hopes other GARP entities to deregister its attributes, it will send a Leave message. When a GARP entity receives a Leave message from another entity or requires other entities to deregister its statically deregistered attributes, it will send a Leave message. There are two types of Leave message: LeaveEmpty and LeaveIn.

- LeaveEmpty message: Used to deregister an unregistered attribute
- LeaveIn message: Used to deregister a registered attribute

(3) LeaveAll message

Each GARP application entity starts its LeaveAll timer during startup. When the timer times out, the entity sends a LeaveAll message to deregister all attributes to enable other GARP entities to reregister attributes. When the GARP application entity receives a LeaveAll message from another entity, it also sends a LeaveAll message. The LeaveAll timer is restarted when a LeaveAll message is sent again to initiate a new cycle.

Timer Types

GARP defines four timers used to control GARP message sending.

(1) Hold timer

The Hold timer controls the sending of GARP messages (including Join and Leave messages). When a GARP application entity has its attributes changed or receives a GARP message from another entity, it starts the Hold timer. During the timeout period, the GARP application entity encapsulates all GARP messages to be sent into packets as few as possible, and sends the packets when the timer times out. This reduces the quantity of sent packets and saves bandwidth resources.

(2) Join timer

The Join timer controls the sending of Join messages. After a GARP application entity sends a Join message, it waits for one timeout interval of the Join timer to ensure that the Join message is reliably transmitted to another entity. If the GARP application entity receives a JoinIn message from another entity before the timer times out, it will not resend the Join message; otherwise, it will resend the Join message. Not each attribute has its own Join timer, but each GARP application entity has one Join timer.

(3) Leave timer

The Leave timer controls attribute deregistration. When a GARP application entity hopes other entities to deregister one of its attributes, it sends a Leave message. Other entities which receive the Leave message start the Leave timer. The attribute will be deregistered only if these entities receive no Join message mapped to the attribute during the timeout period.

(4) LeaveAll timer

Each GARP application entity starts its own LeaveAll timer upon startup. When the timer times out, the entity sends a LeaveAll message to enable other entities to reregister attributes. Then the LeaveAll timer is restarted to initiate a new cycle.

↘ GVRP Advertising Modes

GVRP allows a switch to inform other interconnected devices of its VLANs and instruct the peer device to create specific VLANs and add the ports that transmit GVRP packets to corresponding VLANs.

Two GVRP advertising modes are available:

- Normal mode: A device externally advertises its VLAN information, including dynamic and static VLANs.
- Non-applicant mode: A device does not externally advertise its VLAN information.

↘ GVRP Registration Modes

A GVRP registration mode specifies whether the switch that receives a GVRP packet processes the VLAN information in the packet, such as dynamically creating a new VLAN and adding the port that receives the packet to the VLAN.

Two GVRP registration modes are available:

- Normal mode: Process the VLAN information in the received GVRP packet.
- Disabled mode: No to process the VLAN information in the received GVRP packet.

Overview

Feature	Description
Intra-Topology VLAN Information Synchronization	Dynamically creates VLANs and adds/removes ports to/from VLANs, which reduces the manual configuration workload and the probability of VLAN disconnection due to missing configuration.

34.2.1 Intra-Topology VLAN Information Synchronization

Working Principle

GVRP is an application of GARP based on the GARP working mechanism. GVRP maintains the dynamic registration information of VLANs on a device and propagates the information to other devices. A GVRP-enabled device receives VLAN registration information from other devices and dynamically updates the local VLAN registration information. The device also propagates the local VLAN registration information to other devices so that all devices in a LAN maintain consistent VLAN information. The VLAN registration

information propagated by GVRP includes the manually-configured static registration information on the local device and the dynamic registration information from other devices.

External VLAN Information Advertising

The Trunk port on a GVRP-enabled device periodically collects VLAN information within the port, including the VLANs that the Trunk port joins or exits. The collected VLAN information is encapsulated in a GVRP packet to be sent to the peer device. After the Trunk port on the peer device receives the packet, it resolves the VLAN information. Then corresponding VLANs will be dynamically created, and the Trunk port will join the created VLANs or exit other VLANs. For details about the VLAN information, see the above description of GVRP message types.

Related Configurations

- GVRP is disabled by default.
- Run `[no] gvrp enable` to enable or disable GVRP.
- After GVRP is enabled on a device, the device sends GVRP packets carrying VLAN information. If GVRP is disabled on the device, the device does not send GVRP packets carrying VLAN information or process received GVRP packets.



VLAN Registration and Deregistration

Upon receiving a GVRP packet, the switch determines whether to process the VLAN information in the packet according to the registration mode of the corresponding port. For details, see the above description of GVRP registration modes.

Related Configurations

- If GVRP is enabled, the port in Trunk mode is enabled with dynamic VLAN registration by default.
- To enable dynamic VLAN registration on a port, run the **gvrp registration mode normal** command. To disable dynamic VLAN registration on a port, run the **gvrp register mode disable** command.
- If dynamic VLAN registration is enabled, dynamic VLANs will be created on the local device when the port receives a GVRP packet carrying VLAN information from the peer end.
- If dynamic VLAN registration is disabled, no dynamic VLAN will be created on the local device when the port receives a GVRP packet from the peer end.

Configuration	Description and Command	
Configuring Basic GVRP Features and VLAN Information Synchronization	 (Mandatory) It is used to enable GVRP and dynamic VLAN creation.	
	gvrp enable	Enables GVRP.
	gvrp dynamic-vlan-creation enable	Enables dynamic VLAN creation.
	switchport mode trunk	Switches to Trunk port mode. GVRP take effects only in Trunk mode.
	switchport trunk allowed vlan all	Allows the traffic from all VLANs to pass through.
	gvrp applicant state	Configures the advertising mode of a port. The Normal mode indicates to advertise VLAN information externally by sending a GVRP packet. The Non-applicant mode indicates not to advertise

Configuration	Description and Command	
		VLAN information externally.
	gvrp registration mode	Configures the registration mode of a port. The Normal mode indicates to process the VLAN information in the received GVRP packet, such as dynamically creating VLANs and adding ports to VLANs. The Disabled mode indicates not to process the VLAN information in the received GVRP packet.
	 (Optional) It is used to configure timers and the registration mode and advertising mode of a port.	
	gvrp timer	Configures timers.
<u>Configuring GVRP PDUs Transparent Transmission</u>	 (Optional) It is used to configure GVRP PDUs transparent transmission.	
	bridge-frame forwarding protocol gvrp	Enables GVRP PDUs transparent transmission.
<u>Configuring the GVRP PDUs Tunnel Feature</u>	 (Optional) It is used to configure the GVRP PDUs Tunnel feature.	
	l2protocol-tunnel gvrp	Enables the GVRP PDUs Tunnel feature in global configuration mode.
	l2protocol-tunnel gvrp enable	Enables the GVRP PDUs Tunnel feature in interface configuration mode.
	l2protocol-tunnel gvrp tunnel-dmac	Configures the transparent transmission address used by the GVRP PDUs Tunnel feature.

34.3 Configuration

34.3.1 Configuring Basic GVRP Features and VLAN Information Synchronization

Configuration Effect

- Dynamically create/delete VLANs and add/remove ports to/from VLANs.
- Synchronize VLAN information between devices to ensure normal intra-topology communication.
- Reduce the manual configuration workload and simplify VLAN management.

Notes

- GVRP must be enabled on both connected devices. GVRP information is transmitted only by Trunk Links. The transmitted information contains the information of all VLANs on the current device, including dynamically learned VLANs and manually configured VLANs.
- If STP is enabled, only ports in Forwarding state participate in GVRP (such as receiving and sending GVRP PDUs) and have their VLAN information propagated by GVRP.
- All VLAN ports added by GVRP are tagged ports.
- The system does not save the VLAN information that is dynamically learned by GVRP. The information will be lost when the device is reset and cannot be saved manually.
- All devices that need to exchange GVRP information must maintain consistent GVRP timers (Join timer, Leave timer, and Leaveall timer).

- If STP is not enabled, all available ports can participate in GVRP. If Single Spanning Tree (SST) is enabled, only ports in Forwarding state in the SST Context participate in GVRP. If Multi Spanning Tree (MST) is enabled, GVRP can run in the Spanning Tree Context to which VLAN1 belongs. You cannot specify other Spanning Tree Context for GVRP.

Configuration Steps

↘ Enabling GVRP

- Mandatory.
- Only GVRP-enabled devices can process GVRP packets.

↘ Enabling Dynamic VLAN Creation

- Mandatory.
- After dynamic VLAN creation is enabled on a device, the device will dynamically create VLANs upon receiving GVRP Join messages.

↘ Configuring Timers

- Optional.
- There are three GVRP timers: Join timer, Leave timer, and Leaveall timer, which are used to control message sending intervals.
- The timer interval relationships are as follows: The interval of the Leave timer must be three times or more greater than that of the Join timer; the interval of the Leaveall timer must be greater than that of the Leave timer.
- The three timers are controlled by the GVRP state machine and can be triggered by each other.

↘ Configuring the Advertising Mode of a Port

- Optional.
- Two GVRP advertising modes are available: Normal (default) and Non-applicant.
- Normal mode: Indicates that a device externally advertises its VLAN information.
- Non-applicant mode: Indicates that a device does not externally advertise its VLAN information.

↘ Configuring the Registration Mode of a Port

- Optional.
- Two GVRP registration modes are available: Normal and Disabled.

↘ Switching to Trunk Port Mode

- Mandatory.
- GVRP takes effect only on ports in Trunk mode.

Verification

- Run the **show gvrp configuration** command to check the configuration.
- Check whether a dynamic VLAN is configured and the corresponding port joins the VLAN.

Related Commands

▾ Enabling GVRP

Command	gvrp enable
Parameter	N/A
Description	
Defaults	By default, GVRP is disabled.
Command Mode	Global configuration mode
Usage Guide	GVRP can be enabled only in global configuration mode. If GVRP is not enabled globally, you can still set other GVRP parameters, but the parameter settings take effect only when GVRP starts running.

▾ Enabling Dynamic VLAN Creation

Command	gvrp dynamic-vlan-creation enable
Parameter	N/A
Description	
Defaults	By default, dynamic VLAN creation is disabled.
Command Mode	Global configuration mode
Usage Guide	When a port receives a JoinIn or JoinEmpty message that indicates a non-existent VLAN on the local device, GVRP may create this VLAN, depending on the configuration of this command.

 The parameters of a dynamic VLAN created through GVRP cannot be modified manually.

▾ Configuring Timers

Command	gvrp timer { join timer-value leave timer-value leaveall timer-value }
Parameter	<i>timer-value</i> : 1–2,147,483,647 ms
Description	
Defaults	Join timer: 200ms, leave timer: 600ms, leaveall timer: 10,000ms
Command Mode	Global configuration mode
Usage Guide	<p>The interval of the Leave timer must be three times or greater than that of the Join timer.</p> <p>The interval of the Leaveall timer must be greater than that of the Leave timer.</p> <p>The time unit is milliseconds.</p> <p>The following timer intervals are recommended in actual networking:</p> <p>Join timer: 6,000 ms (6s)</p> <p>Leave timer: 30,000 ms (30s)</p> <p>Leaveall timer: 120,000 ms (2 minutes)</p> <p> Ensure that the GVRP timer settings on all interconnected GVRP devices are consistent; otherwise, GVRP may work abnormally.</p>

▾ Configuring the Advertising Mode of a Port

Command	gvrp applicant state { normal non-applicant }
Parameter	normal: Indicates that a port externally advertises VLAN information.
Description	non-applicant: Indicates that a port does not externally advertise VLAN information.

Defaults	By default, ports are allowed to send GVRP notification.
Command	Interface configuration mode
Mode	
Usage Guide	This command is used to configure the GVRP advertising mode of a port.

📌 **Configuring the Registration Mode of a Port**

Command	gvrp registration mode { normal disabled }
Parameter	normal: Indicates that the port is allowed to join a dynamic VLAN.
Description	disabled: Indicates that the port is not allowed to join a dynamic VLAN.
Defaults	If GVRP is enabled, the port in Trunk mode is enabled with dynamic VLAN registration by default.
Command	Interface configuration mode
Mode	
Usage Guide	This command is used to configure the GVRP registration mode of a port.

Configuration Example

📌 **Enabling GVRP in a Topology and Dynamically Maintaining VLANs and the VLAN-Port Relationship**

Scenario Figure 11-4	
Configuration Steps	<ul style="list-style-type: none"> ● On Switch A and Switch C, configure VLANs used for communication in the customer network. ● Enable the GVRP and dynamic VLAN creation features on Switch A, Switch B, and Switch C. ● Configure the ports connected between switches as Trunk ports, and ensure that the VLAN lists of Trunk ports include the communication VLANs. By default, a Trunk port allows the traffic from all VLANs to pass through. ● It is recommended that STP be enabled to avoid loops.
A	<p>1. Create VLAN 1–200 used for communication in the customer network.</p> <pre>A# configure terminal Enter configuration commands, one per line. End with CNTL/Z. A(config)# vlan range 1-200</pre> <p>2. Enable the GVRP and dynamic VLAN creation features.</p> <pre>A(config)# gvrp enable A(config)# gvrp dynamic-vlan-creation enable</pre> <p>3. Configure the port connected to Switch B as a Trunk port. By default, a Trunk port allows the traffic from all VLANs to pass through.</p> <pre>A(config)# interface gigabitEthernet 0/1 A(config-if-GigabitEthernet 0/1)# switchport mode trunk</pre> <p>4. Configure the advertising mode and registration mode of the Trunk port. The Normal mode is used by default and does not need to be configured manually.</p>

	<pre>A(config-if-GigabitEthernet 0/1)# gvrp applicant state normal A(config-if-GigabitEthernet 0/1)# gvrp registration mode normal A(config-if-GigabitEthernet 0/1)# end</pre>						
C	<ul style="list-style-type: none"> The configuration on Switch C is the same as that on Switch A. 						
B	<p>1. Enable the GVRP and dynamic VLAN creation features.</p> <pre>B# configure terminal B(config)# gvrp enable B(config)# gvrp dynamic-vlan-creation enable</pre> <p>2. Configure the ports connected to Switch A and Switch C as Trunk ports.</p> <pre>B(config)# interface range GigabitEthernet 0/2-3 B(config-if-GigabitEthernet 0/2)# switchport mode trunk</pre>						
Verification	<p>Check whether the GVRP configuration on each device is correct. Check whether VLAN 2–100 are dynamically created on Switch B and whether Port G 0/2 and Port G 0/3 on Switch B join the dynamic VLANs.</p>						
A	<pre>A# show gvrp configuration Global GVRP Configuration: GVRP Feature:enabled GVRP dynamic VLAN creation:enabled Join Timers(ms):200 Leave Timers(ms):600 Leaveall Timers(ms):1000 Port based GVRP Configuration:</pre> <table border="1" data-bbox="326 1368 1414 1514"> <thead> <tr> <th>PORT</th> <th>Applicant Status</th> <th>Registration Mode</th> </tr> </thead> <tbody> <tr> <td>GigabitEthernet 0/1</td> <td>normal</td> <td>normal</td> </tr> </tbody> </table>	PORT	Applicant Status	Registration Mode	GigabitEthernet 0/1	normal	normal
PORT	Applicant Status	Registration Mode					
GigabitEthernet 0/1	normal	normal					
B	<pre>B# show gvrp configuration Global GVRP Configuration: GVRP Feature:enabled GVRP dynamic VLAN creation:enabled Join Timers(ms):200 Leave Timers(ms):600 Leaveall Timers(ms):1000 Port based GVRP Configuration:</pre>						

	PORT	Applicant Status	Registration Mode
	GigabitEthernet 0/2	normal	normal
	GigabitEthernet 0/3	normal	normal
C	<pre> C# show gvrp configuration Global GVRP Configuration: GVRP Feature:enabled GVRP dynamic VLAN creation:enabled Join Timers(ms):200 Leave Timers(ms):600 Leaveall Timers(ms):1000 Port based GVRP Configuration: PORT Applicant Status Registration Mode ----- GigabitEthernet 0/1 normal normal </pre>		

Common Errors

- The ports connected between devices are not in Trunk mode.
- The VLAN lists of the ports connected between devices do not include the VLANs used for communication in the customer network.
- The GVRP advertising modes and registration modes of Trunk ports are not set to Normal.

34.3.2 Enabling GVRP PDUs Transparent Transmission

Configuration Effect

Enable devices to transparently transmit GVRP PDU frames to realize normal inter-device GVRP calculation when GVRP is not enabled.

Notes

GVRP PDUs transparent transmission takes effect only when GVRP is disabled. After GVRP is enabled, devices will not transparently transmit GVRP PDU frames.

Configuration Steps

▾ Configuring GVRP PDUs Transparent Transmission

- Optional.
- Perform this configuration when you need to enable devices to transparently transmit GVRP PDU frames when GVRP is disabled.

Verification

Run the **show run** command to check whether GVRP PDUs transparent transmission is enabled.

Related Commands

➤ **Configuring GVRP PDUs Transparent Transmission**

Command	bridge-frame forwarding protocol gvrp
Parameter Description	N/A
Command Mode	Global configuration mode
Defaults	The function is disabled by default.
Usage Guide	<p>In the IEEE 802.1Q standard, the destination MAC address 01-80-C2-00-00-06 for GVRP PDUs is reserved. Devices compliant with IEEE 802.1Q do not forward received GVRP PDU frames. However, in actual network deployment, devices may need to transparently transmit GVRP PDU frames to realize normal inter-device GVRP calculation when GVRP is not enabled.</p> <p>GVRP PDUs transparent transmission takes effect only when GVRP is disabled. After GVRP is enabled, devices will not transparently transmit GVRP PDU frames.</p>

Configuration Example

➤ **Configuring GVRP PDUs Transparent Transmission**

Scenario Figure 11-5	
	Enable GVRP on DEV A and DEV C. (DEV B is not enabled with GVRP.)
Configuration Steps	Configure GVRP PDUs transparent transmission on DEV B to realize normal GVRP calculation between DEV A and DEV C.
DEV B	<pre>FS(config)#bridge-frame forwarding protocol gvrp</pre>
Verification	Run the show run command to check whether GVRP PDUs transparent transmission is enabled.
DEV B	<pre>FS#show run Building configuration... Current configuration : 694 bytes bridge-frame forwarding protocol gvrp</pre>

34.3.3 Configuring the GVRP PDUs Tunnel Feature

Configuration Effect

Transparently transmit GVRP packets between customer networks through tunnels in SP networks without impact on the SP networks, and thereby separate the GVRP calculation in customer networks from that in SP networks.

Notes

The GVRP PDUs Tunnel feature takes effect after it is enabled in global configuration mode and interface configuration mode.

Configuration Steps

▾ Configuring the GVRP PDUs Tunnel Feature

- (Optional) Perform this configuration when you need to separate GVRP calculation between customer networks and SP networks in a QinQ environment.

Verification

Run the **show l2protocol-tunnel gvrp** command to check the GVRP PDUs Tunnel configuration.

Related Commands

▾ Configuring the GVRP PDUs Tunnel Feature in Global Configuration Mode

Command	I2protocol-tunnel gvrp
Parameter	N/A
Description	
Defaults	The function is disabled by default.
Command Mode	Global configuration mode
Usage Guide	The GVRP PDUs Tunnel feature takes effect after it is enabled in global configuration mode and interface configuration mode.

▾ Configuring the GVRP PDUs Tunnel Feature in Interface Configuration Mode

Command	I2protocol-tunnel gvrp enable
Parameter	N/A
Description	
Defaults	The function is disabled by default.
Command Mode	Interface configuration mode
Usage Guide	The GVRP PDUs Tunnel feature takes effect after it is enabled in global configuration mode and interface configuration mode.

▾ Configuring the GVRP PDUs Tunnel Transparent Transmission Address

Command	I2protocol-tunnel gvrp tunnel-dmac mac-address
Parameter	<i>mac-address</i> : Indicates the GVRP address used by transparent transmission.
Description	
Defaults	The default address is 01d0.f800.0006.

Command Mode	Global configuration mode
Usage Guide	<p>In GVRP PDUs Tunnel application, when a GVRP packet from a customer network enters the PE in an SP network, the destination MAC address of the packet is changed to a private address before the packet is forwarded in the SP network. When the packet reaches the peer PE, the destination MAC address is changed to a public address before the packet is sent to the customer network at the other end. In this way, the GVRP packet can be transparently transmitted across the SP network. The private address is the transparent transmission address used by the GVRP PDUs Tunnel feature.</p> <p> Address range for transparent transmission of GVRP packets: 01d0.f800.0006, 011a.a900.0006</p> <p> When no transparent transmission address is configured, the default address 01d0.f800.0006 is used.</p>

Configuration Example

Configuring the GVRP PDUs Tunnel Feature

Scenario Figure 11-6	
Configuration Steps	<ul style="list-style-type: none"> ● Enable basic QinQ on the PEs (Provider S1 and Provider S2) in the SP network to transmit data packets from the customer network through VLAN 200 in the SP network. ● Enable GVRP transparent transmission on the PEs (Provider S1 and Provider S2) in the SP network to allow the SP network to tunnel GVRP packets from the customer network via the GVRP PDUs Tunnel feature.
Provider S1	<p>Step 1: Create VLAN 200 of the SP network.</p> <pre>FS#configure terminal Enter configuration commands, one per line. End with CNTL/Z. FS(config)#vlan 200 FS(config-vlan)#exit</pre> <p>Step 2: Enable basic QinQ on the port connected to the customer network to tunnel data from the customer network through VLAN 200.</p> <pre>FS(config)#interface gigabitEthernet 0/1</pre>

	<pre>FS(config-if-GigabitEthernet 0/1)#switchport mode dot1q-tunnel FS(config-if-GigabitEthernet 0/1)#switchport dot1q-tunnel native vlan 200 FS(config-if-GigabitEthernet 0/1)#switchport dot1q-tunnel allowed vlan add untagged 200</pre> <p>Step 3: Enable GVRP transparent transmission on the port connected to the customer network.</p> <pre>FS(config-if-GigabitEthernet 0/1)#l2protocol-tunnel gvrp enable FS(config-if-GigabitEthernet 0/1)#exit</pre> <p>Step 4: Enable GVRP transparent transmission globally.</p> <pre>FS(config)#l2protocol-tunnel gvrp</pre> <p>Step 5: Configure an uplink port.</p> <pre>FS(config)# interface gigabitEthernet 0/5 FS(config-if-GigabitEthernet 0/5)#switchport mode uplink</pre>
Provider S2	<p>The configuration on Provider S2 is similar to that on Provider S1.</p>
Verification	<ul style="list-style-type: none"> ● Check whether the GVRP PDUs Tunnel configuration is correct. ● Check whether the Tunnel port is configured correctly. Pay attention to the following: <ul style="list-style-type: none"> - The port type is dot1q-tunnel. - The outer tag VLAN is the Native VLAN and added to the VLAN list of the Tunnel port. - The ports on the PEs in the uplink direction are configured as Uplink ports.
Provider S1	<p>1. Check whether the GVRP PDUs Tunnel configuration is correct.</p> <pre>FS#show l2protocol-tunnel gvrp</pre> <pre>L2protocol-tunnel: Gvrp Enable L2protocol-tunnel destination mac address: 01d0.f800.0006 GigabitEthernet 0/1 l2protocol-tunnel gvrp enable</pre> <p>2. Check whether the QinQ configuration is correct.</p> <pre>FS#show running-config interface GigabitEthernet 0/1 switchport mode dot1q-tunnel switchport dot1q-tunnel allowed vlan add untagged 200 switchport dot1q-tunnel native vlan 200 l2protocol-tunnel gvrp enable ! interface GigabitEthernet 0/5 switchport mode uplink</pre>

Provider S2	The verification on Provider S2 is the same as that on Provider S1.
--------------------	---

Common Errors

In an SP network, transparent transmission addresses are not configured consistently, which affects the transmission of GVRP PDU frames.

34.4 Monitoring

Clearing



Running the **clear** commands may lose vital information and thus interrupt services.

Description	Command
Clears port counters.	clear gvrp statistics { <i>interface-id</i> all }

Displaying

Description	Command
Displays port counters.	show gvrp statistics { <i>interface-id</i> all }
Displays the current GVRP status.	show gvrp status
Displays the current GVRP configuration.	show gvrp configuration
Displays the information of the GVRP PDUs Tunnel feature.	show l2protocol-tunnel gvrp

Debugging



System resources are occupied when debugging information is output. Therefore, disable debugging immediately after use.

Description	Command
Enables GVRP event debugging.	debug gvrp event
Enables GVRP timer debugging.	debug gvrp timer

35 Configuring LLDP

35.1 Overview

The Link Layer Discovery Protocol (LLDP), defined in the IEEE 802.1AB standard, is used to discover the topology and identify topological changes. LLDP encapsulates local information of a device into LLDP data units (LLDPDUs) in the type/length/value (TLV) format and then sends the LLDPDUs to neighbors. It also stores LLDPDUs from neighbors in the management information base (MIB) to be accessed by the network management system (NMS).

With LLDP, the NMS can learn about topology, for example, which ports of a device are connected to other devices and whether the rates and duplex modes at both ends of a link are consistent. Administrators can quickly locate and rectify a fault based on the information.

A FS LLDP-compliant device is capable of discovering neighbors when the peer is either of the following:

- FS LLDP-compliant device
- Endpoint device that complies with the Link Layer Discovery Protocol-Media Endpoint Discovery (LLDP-MED)

Protocols and Standards

- IEEE 802.1AB 2005: Station and Media Access Control Connectivity Discovery
- ANSI/TIA-1057: Link Layer Discovery Protocol for Media Endpoint Devices

35.2 Applications

Application	Description
Displaying Topology	Multiple switches, a MED device, and an NMS are deployed in the network topology.
Conducting Error Detection	Two switches are directly connected and incorrect configuration will be displayed.

35.2.1 Displaying Topology

Scenario

Multiple switches, a MED device, and an NMS are deployed in the network topology.

As shown in the following figure, the LLDP function is enabled by default and no additional configuration is required.

- Switch A and Switch B discover that they are neighbors.
- Switch A discovers its neighbor MED device, that is, IP-Phone, through port GigabitEthernet 0/1.
- The NMS accesses MIB of switch A.

Figure 12- 1

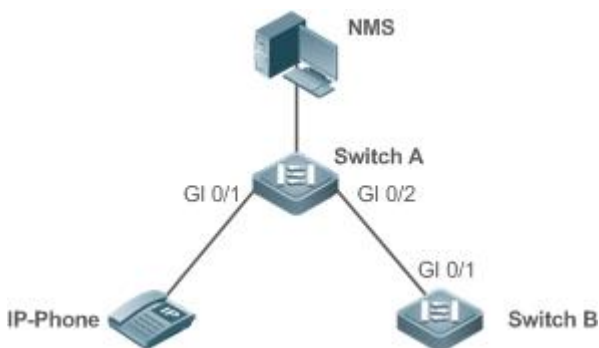

Remarks	<p>FS Switch A, Switch B, and IP-Phone support LLDP and LLDP-MED.</p> <p>LLDP on switch ports works in TxRx mode.</p> <p>The LLDP transmission interval is 30 seconds and transmission delay is 2 seconds by default.</p>
----------------	---

Deployment

- Run LLDP on a switch to implement neighbor discovery.

- Run the Simple Network Management Protocol (SNMP) on the switch so that the NMS acquires and sets LLDP-relevant information on the switch.

35.2.2 Conducting Error Detection

Scenario

Two switches are directly connected and incorrect configuration will be displayed.

As shown in the following figure, the LLDP function and LLDP error detection function are enabled by default, and no additional configuration is required.

- After you configure a virtual local area network (VLAN), port rate and duplex mode, link aggregation, and maximum transmission unit (MTU) of a port on Switch A, an error will be prompted if the configuration does not match that on Switch B, and vice versa.

Figure 12- 2



Remarks	FS Switch A and Switch B support LLDP. LLDP on switch ports works in TxRx mode. The LLDP transmission interval is 30 seconds and transmission delay is 2 seconds by default.
----------------	--

Deployment

- Run LLDP on a switch to implement neighbor discovery and detect link fault.

35.3 Features

Basic Concepts

↳ LLDAPDU

LLDPDU is a protocol data unit encapsulated into an LLDP packet. Each LLDPDU is a sequence of TLV structures. The TLV collection consists of three mandatory TLVs, a series of optional TLVs, and one End Of TLV. The following figure shows the format of an LLDPDU.

Figure 12- 3 LLDPDU Format

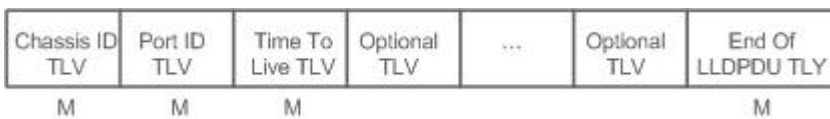

In the preceding figure:

- M indicates a mandatory TLV.
- In an LLDPDU, Chassis ID TLV, Port ID TLV, Time To Live TLV, and End Of LLDPDU TLV are mandatory and TLVs of other TLVs are optional.

↳ LLDP Encapsulation Format

LLDP packets can be encapsulated in two formats: Ethernet II and Subnetwork Access Protocols (SNAP).

The following figure shows the format of LLDP packets encapsulated in the Ethernet II format.

Figure 12- 4 Ethernet II Format



In the preceding figure:

- Destination Address: Indicates the destination MAC address, which is the LLDP multicast address 01-80-C2-00-00-0E.
- Source Address: Indicates the source MAC address, which is the port MAC address.
- Ethertype: Indicates the Ethernet type, which is 0x88CC.
- LLDPDU: Indicates the LLDP protocol data unit.
- FCS: Indicates the frame check sequence.

Figure 12-5 shows the format of LLDP packets encapsulated in the SNAP format.

Figure 12- 5 SNAP Format

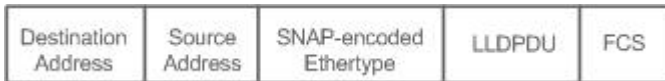

In the preceding figure:

- Destination Address: Indicates the destination MAC address, which is the LLDP multicast address 01-80-C2-00-00-0E.
- Source Address: Indicates the source MAC address, which is the port MAC address.
- SNAP-encoded Ethertype: Indicates the Ethernet type of the SNMP encapsulation, which is AA-AA-03-00-00-00-88-CC.
- LLDPDU: Indicates the LLDP protocol data unit.
- FCS: Indicates the frame check sequence.

TLV

TLVs encapsulated into an LLDPDU can be classified into two types:

- Basic management TLVs
- Organizationally specific TLVs

Basic management TLVs are a collection of basic TLVs used for network management. Organizationally specific TLVs are defined by standard organizations and other institutions, for example, the IEEE 802.1 organization and IEEE 802.3 organization define their own TLV collections.

9. Basic management TLVs

The basic management TLV collection consists of two types of TLVs: mandatory TLVs and optional TLVs. A mandatory TLV must be contained in an LLDPDU for advertisement and an optional TLV is contained selectively.

The following table describes basic management TLVs.

TLV Type	Description	Mandatory/Optional
End Of LLDPDU TLV	Indicates the end of an LLDPDU, occupying two bytes.	Mandatory
Chassis ID TLV	Identifies a device with a MAC address.	Mandatory
Port ID TLV	Identifies a port sending LLDPDUs.	Fixed
Time To Live TLV	Indicates the time to live (TTL) of local information on a neighbor. When	Mandatory

	a device receives a TLV containing TTL 0, it deletes the neighbor information.	
Port Description TLV	Indicates the descriptor of the port sending LLDPDUs.	Optional
System Name TLV	Describes the device name.	Optional
System Description TLV	Indicates the device description, including the hardware version, software version, and operating system information.	Optional
System Capabilities TLV	Describes main functions of the device, such as the bridge, routing, and relay functions.	Optional
Management Address TLV	Indicates the management address, which contains the interface ID and object identifier (OID).	Optional

FS LLDP-compliant switches support advertisement of basic management TLVs.

10. Organizationally specific TLVs

Different organizations, such as the IEEE 802.1, IEEE 802.3, IETF and device suppliers, define specific TLVs to advertise specific information about devices. The organizationally unique identifier (OUI) field in a TLV is used to distinguish different organizations.

- Organizationally specific TLVs are optional and are advertised in an LLDPDU selectively. Currently, there are three types of common organizationally specific TLVs: IEEE 802.1 organizationally specific TLVs, IEEE 802.3 organizationally specific TLVs, and LLDP-MED TLVs.

The following table describes IEEE 802.1 organizationally specific TLVs.

TLV Type	Description
Port VLAN ID TLV	Indicates the VLAN identifier of a port.
Port And Protocol VLAN ID TLV	Indicates the protocol VLAN identifier of a port.
VLAN Name TLV	Indicates the VLAN name of a port.
Protocol Identity TLV	Indicates the protocol type supported by a port.

FS LLDP-compliant switches do not send the Protocol Identity TLV but receive this TLV.

- IEEE 802.3 organizationally specific TLVs

The following table describes IEEE 802.3 organizationally specific TLVs.

TLV Type	Description
MAC/PHY Configuration//Status TLV	Indicates the rate and duplex mode of a port, and whether to support and enable auto-negotiation.
Power Via MDI TLV	Indicates the power supply capacity of a port.
Link Aggregation TLV	Indicates the link aggregation capacity of a port and the current aggregation state.
Maximum Frame Size TLV	Indicates the maximum size of the frame transmitted by a port.

FS LLDP-compliant devices support advertisement of IEEE 802.3 organizationally specific TLVs.

- LLDP-MED TLV

LLDP-MED is an extension to LLDP based on IEEE 802.1AB LLDP. It enables users to conveniently deploy the Voice Over IP (VoIP) network and detect faults. It provides applications including the network configuration policies, device discovery, PoE management, and inventory management, meeting requirements for low cost, effective management, and easy deployment.

The following table describes LLDP-MED TLVs.

TLV Type	Description
LLDP-MED Capabilities TLV	Indicates the type of the LLDP-MED TLV encapsulated into an LLDPDU and device type (network connectivity device or endpoint device), and whether to support LLDP-MED.
Network Policy TLV	Advertises the port VLAN configuration, supported application type (such as voice or video services), and Layer-2 priority information.
Location Identification TLV	Locates and identifies an endpoint device.
Extended Power-via-MDI TLV	Provides more advanced power supply management.
Inventory – Hardware Revision TLV	Indicates hardware version of a MED device.
Inventory – Firmware Revision TLV	Indicates the firmware version of the MED device.
Inventory – Software Revision TLV	Indicates the software version of the MED device.
Inventory – Serial Number TLV	Indicates the serial number of the MED device.
Inventory – Manufacturer Name TLV	Indicates the name of the manufacturer of the MED device.
Inventory – Model Name TLV	Indicates the module name of the MED device.
Inventory – Asset ID TLV	Indicates the asset identifier of the MED device, used for inventory management and asset tracking.

FS LLDP-compliant FS devices support advertisement of LLDP-MED TLVs.

Overview

Feature	Description
<u>LLDP Work Mode</u>	Configures the mode of transmitting and receiving LLDP packets.
<u>LLDP Transmission Mechanism</u>	Enables directly connected LLDP-compliant devices to send LLDP packets to the peer.
<u>LLDP Reception Mechanism</u>	Enables directly connected LLDP-compliant devices to receive LLDP packets from the peer.

35.3.1LLDP Work Mode

Configure the LLDP work mode so as to specify the LLDP packet transmission and reception mode.

Working Principle

LLDP provides three work modes:

- TxRx: Transmits and receives LLDPDUs.
- Rx Only: Only receives LLDPDUs.
- Tx Only: Only transmits LLDPDUs.

When the LLDP work mode is changed, the port initializes the protocol state machine. You can set a port initialization delay to prevent repeated initialization of a port due to frequent changes of the LLDP work mode.

Related Configuration

📌 Configuring the LLDP Work Mode

The default LLDP work mode is TxRx.

You can run the **lldp mode** command to configure the LLDP work mode.

If the work mode is set to TxRx, the device can both transmit and receive LLDP packets. If the work mode is set to Rx Only, the device can only receive LLDP packets. If the work mode is set to Tx Only, the device can only transmit LLDP packets. If the work mode is disabled, the device cannot transmit or receive LLDP packets.

35.3.2LLDP Transmission Mechanism

LLDP packets inform peers of their neighbors. When the LLDP transmission mode is cancelled or disabled, LLDP packets cannot be transmitted to neighbors.

Working Principle

LLDP periodically transmits LLDP packets when working in TxRx or Tx Only mode. When information about the local device changes, LLDP immediately transmits LLDP packets. You can configure a delay time to avoid frequent transmission of LLDP packets caused by frequent changes of local information.

LLDP provides two types of packets:

- Standard LLDP packet, which contains management and configuration information about the local device.
- Shutdown packet: When the LLDP work mode is disabled or the port is shut down, LLDP Shutdown packets will be transmitted. A Shutdown packet consists of the Chassis ID TLV, Port ID TLV, Time To Live TLV, and End OF LLDP TLV. TTL in the Time to Live TLV is 0. When a device receives an LLDP Shutdown packet, it considers that the neighbor information is invalid and immediately deletes it.

When the LLDP work mode is changed from disabled or Rx to TxRx or Tx, or when LLDP discovers a new neighbor (that is, a device receives a new LLDP packet and the neighbor information is not stored locally), the fast transmission mechanism is started so that the neighbor quickly learns the device information. The fast transmission mechanism enables a device to transmit multiple LLDP packets at an interval of 1 second.

Related Configuration

📌 Configuring the LLDP Work Mode

The default work mode is TxRx.

Run the **lldp mode txrx** or **lldp mode tx** command to enable the LLDP packet transmission function. Run the **lldp mode rx** or **no lldp mode** command to disable the LLDP packet transmission function.

In order to enable LLDP packet reception, set the work mode to TxRx or Rx Only. If the work mode is set to Rx Only, the device can only receive LLDP packets.

📌 Configuring the LLDP Transmission Delay

The default LLDP transmission delay is 2 seconds.

Run the **lldp timer tx-delay** command to change the LLDP transmission delay.

If the delay is set to a very small value, the frequent change of local information will cause frequent transmission of LLDP packets. If the delay is set to a very large value, no LLDP packet may be transmitted even if local information is changed.

📌 Configuring the LLDP Transmission Interval

The default LLDP transmission interval is 30 seconds.

Run the **lldp timer tx-interval** command to change the LLDP transmission interval.

If the interval is set to a very small value, LLDP packets may be transmitted frequently. If the interval is set to a very large value, the peer may not discover the local device in time.

⚡ Configuring the TLVs to Be Advertised

By default, an interface is allowed to advertise TLVs of all types except Location Identification TLV.

Run the **lldp tlv-enable** command to change the TLVs to be advertised.

⚡ Configuring the LLDP Fast Transmission Count

By default, three LLDP packets are fast transmitted.

Run the **lldp fast-count** command to change the number of LLDP packets that are fast transmitted.

35.3.3 LLDP Reception Mechanism

A device can discover the neighbor and determine whether to age the neighbor information according to received LLDP packets.

Working Principle

A device can receive LLDP packets when working in TxRx or Rx Only mode. After receiving an LLDP packet, a device conducts validity check. After the packet passes the check, the device checks whether the packet contains information about a new neighbor or about an existing neighbor and stores the neighbor information locally. The device sets the TTL of neighbor information according to the value of TTL TLV in the packet. If the value of TTL TLV is 0, the neighbor information is aged immediately.

Related Configuration

⚡ Configuring the LLDP Work Mode









The default LLDP work mode is TxRx.





Run the **lldp mode txrx** or **lldp mode rx** command to enable the LLDP packet reception function. Run the **lldp mode tx** or **no lldp mode** command to disable the LLDP packet reception function.

In order to enable LLDP packet reception, set the work mode to TxRx or Rx Only. If the work mode is set to Tx Only, the device can only transmit LLDP packets.

35.4 Configuration

Configuration	Description and Command	
Configuring the LLDP Function	⚠ (Optional) It is used to enable or disable the LLDP function in global or interface configuration mode.	
	lldp enable	Enables the LLDP function.
	no lldp enable	Disables the LLDP function.
Configuring the LLDP Work Mode	⚠ (Optional) It is used to configure the LLDP work mode.	
	lldp mode {rx tx txrx }	Configures the LLDP work mode.
	no lldp mode	Shuts down the LLDP work mode.
Configuring the TLVs to Be Advertised	⚠ (Optional) It is used to configure the TLVs to be advertised.	
	lldp tlv-enable	Configures the TLVs to be advertised.

Configuration	Description and Command	
	no lldp tlv-enable	Cancels TLVs.
<u>Configures the Management Address to Be Advertised</u>	 (Optional) It is used to configure the management address to be advertised in LLDP packets.	
	lldp management-address-tlv <i>[ip-address]</i>	Configures the management address to be advertised in LLDP packets.
	no lldp management-address-tlv	Cancels the management address.
<u>Configuring the LLDP Fast Transmission Count</u>	 (Optional) It is used to configure the number of LLDP packets that are fast transmitted.	
	lldp fast-count <i>value</i>	Configures the <u>LLDP fast transmission</u> count.
	no lldp fast-count	Restores the default <u>LLDP fast transmission</u> count.
<u>Configuring the TTL Multiplier and Transmission Interval</u>	 (Optional) It is used to configure the TTL multiplier and transmission interval.	
	lldp hold-multiplier <i>value</i>	Configures the TTL multiplier.
	no lldp hold-multiplier	Restores the default TTL multiplier.
	lldp timer tx-interval <i>seconds</i>	Configures the transmission interval.
	no lldp timer tx-interval	Restores the default transmission interval.
<u>Configuring the Transmission Delay</u>	 (Optional) It is used to configure the delay time for LLDP packet transmission.	
	lldp timer tx-delay <i>seconds</i>	Configures the transmission delay.
	no lldp timer tx-delay	Restores the default transmission delay.
<u>Configuring the Initialization Delay</u>	 (Optional) It is used to configure the delay time for LLDP to initialize on any interface.	
	lldp timer reinit-delay <i>seconds</i>	Configures the initialization delay.
	no lldp timer reinit-delay	Restores the default initialization delay.
<u>Configuring the LLDP Trap Function</u>	 (Optional) It is used to configure the LLDP Trap function.	
	lldp notification remote-change enable	Enables the LLDP Trap function.
	no lldp notification remote-change enable	Disables the LLDP Trap function.
	lldp timer notification-interval	Configures the LLDP Trap transmission interval.
<u>Configuring the LLDP Error Detection Function</u>	 (Optional) It is used to configure the LLDP error detection function.	
	lldp error-detect	Enables the LLDP error detection function.
	no lldp error-detect	Disables the LLDP error detection function.
<u>Configuring the LLDP Encapsulation Format</u>	 (Optional) It is used to configure the LLDP encapsulation format.	
	lldp encapsulation snap	Sets the LLDP encapsulation format to SNAP.
	no lldp encapsulation snap	Sets the LLDP encapsulation format to Ethernet II.
<u>Configuring the LLDP Network Policy</u>	 (Optional) It is used to configure the LLDP Network Policy.	
	lldp network-policy profile <i>profile-num</i>	Configures an LLDP Network Policy.
	no lldp network-policy profile <i>profile-num</i>	Deletes an LLDP Network Policy.

Configuration	Description and Command	
Configuring the Civic Address	 (Optional) It is used to configure the civic address of a device.	
	{ country state county city division neighborhood street-group leading-street-dir trailing-street-suffix street-suffix number street-number-suffix landmark additional-location-information name postal-code building unit floor room type-of-place postal-community-name post-office-box additional-code } ca-word	Configures the civic address of a device.
	no { country state county city division neighborhood street-group leading-street-dir trailing-street-suffix street-suffix number street-number-suffix landmark additional-location-information name postal-code building unit floor room type-of-place postal-community-name post-office-box additional-code } ca-word	Deletes civic address of a device.
Configuring the Emergency Telephone Number	 (Optional) It is used to configure the emergency telephone number of a device.	
	lldp location elin identifier id elin-location tel-number	Configures the emergency telephone number of a device.
	no lldp location elin identifier id	Deletes the emergency telephone number of a device.
Configuring the Function of Ignoring PVID Detection	 (Optional) It is used to ignore PVID detection.	
	lldp ignore pvid-error-detect	Enables the function of ignoring PVID detection.
	no lldp ignore pvid-error-detect	Disables the function of ignoring PVID detection.
Configuring the Type of the Management Address in the LLDP Packets	 (Optional) It is used to configure the type of the management address in the LLDP packets.	
	lldp management-address-tlv global-ip type {interface loopback}	Specifying the type of the management address in the LLDP packets.
	no lldp management-address-tlv global-ip type	Restores the default type of the management address in the LLDP packets.

35.4.1 Configuring the LLDP Function

Configuration Effect

- Enable or disable the LLDP function.

Notes

- To make the LLDP function take effect on an interface, you need to enable the LLDP function globally and on the interface.

Configuration Steps

- Optional.
- Configure the LLDP function in global or interface configuration mode.

Verification

Display LLDP status

- Check whether the LLDP function is enabled in global configuration mode.
- Check whether the LLDP function is enabled in interface configuration mode.

Related Commands

↘ **Enabling the LLDP Function**

Command	lldp enable
Parameter	N/A
Description	
Command Mode	Global configuration mode/Interface configuration mode
Usage Guide	The LLDP function takes effect on an interface only after it is enabled in global configuration mode and interface configuration mode.

↘ **Disabling the LLDP Function**

Command	no lldp enable
Parameter	N/A
Description	
Command Mode	Global configuration mode/Interface configuration mode
Usage Guide	N/A

Configuration Example

↘ **Disabling the LLDP Function**

Configuration Steps	Disable the LLDP function in global configuration mode.
	<pre>FS(config)#no lldp enable</pre>
Verification	Display global LLDP status.
	<pre>FS(config)#show lldp status Global status of LLDP: Disable</pre>

Common Errors

- If the LLDP function is enabled on an interface but disabled in global configuration mode, the LLDP function does not take effect on the interface.

- A port can learn a maximum of five neighbors.
- If a neighbor does not support LLDP but it is connected to an LLDP-supported device, a port may learn information about the device that is not directly connected to the port because the neighbor may forward LLDP packets.

35.4.2 Configuring the LLDP Work Mode

Configuration Effect

- If you set the LLDP work mode to TxRx, the interface can transmit and receive packets.
- If you set the LLDP work mode to Tx, the interface can only transmit packets but cannot receive packets.
- If you set the LLDP work mode to Rx, the interface can only receive packets but cannot transmit packets.
- If you disable the LLDP work mode, the interface can neither receive nor transmit packets.

Notes

- LLDP runs on physical ports (AP member ports for AP ports). Stacked ports and VSL ports do not support LLDP.

Configuration Steps

- Optional.
- Set the LLDP work mode to Tx or Rx as required.

Verification

Display LLDP status information on an interface

- Check whether the configuration takes effect.

Related Commands

▾ Configuring the LLDP Work Mode

Command	lldp mode { rx tx txrx }
Parameter	rx: Only receives LLDPDUs.
Description	tx: Only transmits LLDPDUs. txrx: Transmits and receives LLDPDUs.
Command Mode	Interface configuration mode
Usage Guide	To make LLDP take effect on an interface, make sure to enable LLDP globally and set the LLDP work mode on the interface to Tx, Rx or TxRx.

▾ Disabling the LLDP Work Mode

Command	no lldp mode
Parameter	N/A
Description	
Command Mode	Interface configuration mode
Usage Guide	After the LLDP work mode on an interface is disabled, the interface does not transmit or receive LLDP packets.

Configuration Example

Configuring the LLDP Work Mode

Configuration Steps	Set the LLDP work mode to Tx in interface configuration mode.
	<pre>FS(config)#interface gigabitethernet 0/1 FS(config-if-GigabitEthernet 0/1)#lldp mode tx</pre>
Verification	Display LLDP status information on the interface.
	<pre>FS(config-if-GigabitEthernet 0/1)#show lldp status interface gigabitethernet 0/1 Port [GigabitEthernet 0/1] Port status of LLDP : Enable Port state : UP Port encapsulation : Ethernet II Operational mode : TxOnly Notification enable : NO Error detect enable : YES Number of neighbors : 0 Number of MED neighbors : 0</pre>

35.4.3 Configuring the TLVs to Be Advertised

Configuration Effect

- Configure the type of TLVs to be advertised to specify the LLDPDUs in LLDP packets.

Notes

- If you configure the **all** parameter for the basic management TLVs, IEEE 802.1 organizationally specific TLVs, and IEEE 802.3 organizationally specific TLVs, all optional TLVs of these types are advertised.
- If you configure the **all** parameter for the LLDP-MED TLVs, all LLDP-MED TLVs except Location Identification TLV are advertised.
- If you want to configure the LLDP-MED Capability TLV, configure the LLDP 802.3 MAC/PHY TLV first; If you want to cancel the LLDP 802.3 MAC/PHY TLV, cancel the LLDP-MED Capability TLV first.
- If you want to configure LLDP-MED TLVs, configure the LLDP-MED Capability TLV before configuring other types of LLDP-MED TLVs. If you want to cancel LLDP-MED TLVs, cancel the LLDP-MED Capability TLV before canceling other types of LLDP-MED TLVs. If a device is connected to an IP-Phone that supports LLDP-MED, you can configure the Network Policy TLV to push policy configuration to the IP-Phone.
- If a device supports the DCBX function by default, ports of the device are not allowed to advertise IEEE 802.3 organizationally specific TLVs and LLDP-MED TLVs by default.

Configuration Steps

- Optional.
- Configure the type of TLVs to be advertised on an interface.

Verification

Display the configuration of TLVs to be advertised on an interface

- Check whether the configuration takes effect.

Related Commands

📌 Configuring TLVs to Be Advertised

Command	lldp tlv-enable { basic-tlv { all port-description system-capability system-description system-name } dot1-tlv { all port-vlan-id protocol-vlan-id [<i>vlan-id</i>] vlan-name [<i>vlan-id</i>] } dot3-tlv { all link-aggregation mac-physic max-frame-size power } med-tlv { all capability inventory location { civic-location elin } identifier <i>id</i> network-policy profile [<i>profile-num</i>] power-over-ethernet } }
Parameter Description	<p>basic-tlv: Indicates the basic management TLV.</p> <p>port-description: Indicates the Port Description TLV.</p> <p>system-capability: Indicates the System Capabilities TLV.</p> <p>system-description: Indicates the System Description TLV.</p> <p>system-name: Indicates the System Name TLV.</p> <p>dot1-tlv: Indicates the IEEE 802.1 organizationally specific TLVs.</p> <p>port-vlan-id: Indicates the Port VLAN ID TLV.</p> <p>protocol-vlan-id: Indicates the Port And Protocol VLAN ID TLV.</p> <p><i>vlan-id</i>: Indicates the Port Protocol VLAN ID, ranging from 1 to 4,094.</p> <p>vlan-name: Indicates the VLAN Name TLV.</p> <p><i>vlan-id</i>: Indicates the VLAN name, ranging from 1 to 4,094.</p> <p>dot3-tlv: Indicates the IEEE 802.3 organizationally specific TLVs.</p> <p>link-aggregation: Indicates the Link Aggregation TLV.</p> <p>mac-physic: Indicates the MAC/PHY Configuration/Status TLV.</p> <p>max-frame-size: Indicates the Maximum Frame Size TLV.</p> <p>power: Indicates the Power Via MDI TLV.</p> <p>med-tlv: Indicates the LLDP MED TLV.</p> <p>capability: Indicates the LLDP-MED Capabilities TLV.</p> <p>Inventory: Indicates the inventory management TLV, which contains the hardware version, firmware version, software version, SN, manufacturer name, module name, and asset identifier.</p> <p>location: Indicates the Location Identification TLV.</p> <p>civic-location: Indicates the civic address information and postal information.</p> <p>elin: Indicates the emergency telephone number.</p> <p><i>id</i>: Indicates the policy ID, ranging from 1 to 1,024.</p> <p>network-policy: Indicates the Network Policy TLV.</p> <p><i>profile-num</i>: Indicates the Network Policy ID, ranging from 1 to 1,024.</p> <p>power-over-ethernet: Indicates the Extended Power-via-MDI TLV.</p>
Command Mode	Interface configuration mode
Usage Guide	N/A

➤ **Canceling TLVs**

Command	<code>no lldp tlv-enable {basic-tlv {all port-description system-capability system-description system-name } dot1-tlv {all port-vlan-id protocol-vlan-id vlan-name } dot3-tlv {all link-aggregation mac-physic max-frame-size power } med-tlv {all capability inventory location {civic-location elin } identifier id network-policy profile [profile-num] power-over-ethernet } }</code>
Parameter Description	<p>basic-tlv: Indicates the basic management TLV.</p> <p>port-description: Indicates the Port Description TLV.</p> <p>system-capability: Indicates the System Capabilities TLV.</p> <p>system-description: Indicates the System Description TLV.</p> <p>system-name: Indicates the System Name TLV.</p> <p>dot1-tlv: Indicates the IEEE 802.1 organizationally specific TLVs.</p> <p>port-vlan-id: Indicates the Port VLAN ID TLV.</p> <p>protocol-vlan-id: Indicates the Port And Protocol VLAN ID TLV.</p> <p>vlan-name: Indicates the VLAN Name TLV.</p> <p>dot3-tlv: Indicates the IEEE 802.3 organizationally specific TLVs.</p> <p>link-aggregation: Indicates the Link Aggregation TLV.</p> <p>mac-physic: Indicates the MAC/PHY Configuration/Status TLV.</p> <p>max-frame-size: Indicates the Maximum Frame Size TLV.</p> <p>power: Indicates the Power Via MDI TLV.</p> <p>med-tlv: Indicates the LLDP MED TLV.</p> <p>capability: Indicates the LLDP-MED Capabilities TLV.</p> <p>Inventory: Indicates the inventory management TLV, which contains the hardware version, firmware version, software version, SN, manufacturer name, module name, and asset identifier.</p> <p>location: Indicates the Location Identification TLV.</p> <p>civic-location: Indicates the civic address information and postal information.</p> <p>elin: Indicates the emergency telephone number.</p> <p>id: Indicates the policy ID, ranging from 1 to 1,024.</p> <p>network-policy: Indicates the Network Policy TLV.</p> <p>profile-num: Indicates the Network Policy ID, ranging from 1 to 1,024.</p> <p>power-over-ethernet: Indicates the Extended Power-via-MDI TLV.</p>
Command Mode	Interface configuration mode
Usage Guide	N/A

Configuration Example

➤ **Configuring TLVs to Be Advertised**

Configuration Steps	Cancel the advertisement of the IEEE 802.1 organizationally specific Port And Protocol VLAN ID TLV.
	<pre>FS(config)#interface gigabitEthernet 0/1 FS(config-if-GigabitEthernet 0/1)#no lldp tlv-enable dot1-tlv protocol-vlan-id</pre>
Verification	Display LLDP TLV configuration in interface configuration mode.

```

FS(config-if-GigabitEthernet 0/1)#show lldp tlv-config interface gigabitethernet 0/1
LLDP tlv-config of port [GigabitEthernet 0/1]
      NAME                STATUS DEFAULT
-----
Basic optional TLV:
Port Description TLV      YES    YES
System Name TLV          YES    YES
System Description TLV   YES    YES
System Capabilities TLV  YES    YES
Management Address TLV   YES    YES

IEEE 802.1 extend TLV:
Port VLAN ID TLV         YES    YES
Port And Protocol VLAN ID TLV NO    YES
VLAN Name TLV            YES    YES

IEEE 802.3 extend TLV:
MAC-Physic TLV           YES    YES
Power via MDI TLV        YES    YES
Link Aggregation TLV     YES    YES
Maximum Frame Size TLV   YES    YES

LLDP-MED extend TLV:
Capabilities TLV         YES    YES
Network Policy TLV      YES    YES
Location Identification TLV NO    NO
Extended Power via MDI TLV YES    YES
Inventory TLV            YES    YES
    
```

35.4.4 Configures the Management Address to Be Advertised

Configuration Effect

- Configure the management address to be advertised in LLDP packets in interface configuration mode.
- After the management address to be advertised is cancelled, the management address in LLDP packets is subject to the default settings.

Notes

- LLDP runs on physical ports (AP member ports for AP ports). Stacked ports and VSL ports do not support LLDP.

Configuration Steps

- Optional.
- Configure the management address to be advertised in LLDP packets in interface configuration mode.

Verification

Display LLDP information on a local interface

- Check whether the configuration takes effect.

Related Commands

↘ **Configuring the Management Address to Be Advertised**

Command	lldp management-address-tlv [<i>ip-address</i>]
Parameter Description	<i>ip-address</i> : Indicates the management address to be advertised in an LLDP packet.
Command Mode	Interface configuration mode
Usage Guide	A management address is advertised through LLDP packets by default. The management address is the IPv4 address of the minimum VLAN supported by the port. If no IPv4 address is configured for the VLAN, LLDP keeps searching for the qualified IP address. If no IPv4 address is found, LLDP searches for the IPv6 address of the minimum VLAN supported by the port. If no IPv6 address is found, the loopback address 127.0.0.1 is used as the management address.

↘ **Canceling the Management Address**

Command	no lldp management-address-tlv
Parameter Description	N/A
Command Mode	Interface configuration mode
Usage Guide	A management address is advertised through LLDP packets by default. The management address is the IPv4 address of the minimum VLAN supported by the port. If no IPv4 address is configured for the VLAN, LLDP keeps searching for the qualified IP address. If no IPv4 address is found, LLDP searches for the IPv6 address of the minimum VLAN supported by the port. If no IPv6 address is found, the loopback address 127.0.0.1 is used as the management address.

Configuration Example

↘ **Configuring the Management Address to Be Advertised**

Configuration Steps	Set the management address to 192.168.1.1 on an interface.
	<pre>FS(config)#interface gigabitethernet 0/1</pre>

	FS(config-if-GigabitEthernet 0/1)#lldp management-address-tlv 192.168.1.1
Verification	Display configuration on the interface.
	<pre> FS(config-if-GigabitEthernet 0/1)#show lldp local-information interface GigabitEthernet 0/1 Lldp local-information of port [GigabitEthernet 0/1] Port ID type : Interface name Port id : GigabitEthernet 0/1 Port description : GigabitEthernet 0/1 Management address subtype : ipv4 Management address : 192.168.1.1 Interface numbering subtype : ifIndex Interface number : 1 Object identifier : 802.1 organizationally information Port VLAN ID : 1 Port and protocol VLAN ID(PPVID) : 1 PPVID Supported : YES PPVID Enabled : NO VLAN name of VLAN 1 : VLAN0001 Protocol Identity : 802.3 organizationally information Auto-negotiation supported : YES Auto-negotiation enabled : YES PMD auto-negotiation advertised : 1000BASE-T full duplex mode, 100BASE-TX full duplex mode, 100BASE-TX half duplex mode, 10BASE-T full duplex mode, 10BASE-T half duplex mode Operational MAU type : speed(100)/duplex(Full) PoE support : NO Link aggregation supported : YES Link aggregation enabled : NO Aggregation port ID : 0 Maximum frame Size : 1500 </pre>

LLDP-MED organizationally information Power-via-MDI device type : PD Power-via-MDI power source : Local Power-via-MDI power priority : Power-via-MDI power value : Model name : Model name

35.4.5 Configuring the LLDP Fast Transmission Count

Configuration Effect

- Configure the number of LLDP packets that are fast transmitted.

Configuration Steps

- Optional.
- Configure the number of LLDP packets that are fast transmitted in global configuration mode.

Verification

Displaying the global LLDP status information

- Check whether the configuration takes effect.

Related Commands

▾ Configuring the LLDP Fast Transmission Count

Command	lldp fast-count <i>value</i>
Parameter Description	<i>value</i> : Indicates the number of LLDP packets that are fast transmitted. The value ranges from 1 to 10. The default value is 3.
Command Mode	Global configuration mode
Usage Guide	N/A

▾ Restoring the Default LLDP Fast Transmission Count

Command	no lldp fast-count
Parameter Description	N/A
Command Mode	Global configuration mode
Usage Guide	N/A

Configuration Example

▾ Configuring the LLDP Fast Transmission Count

Configuration Steps	Set the LLDP fast transmission count to 5 in global configuration mode.
	<pre>FS(config)#lldp fast-count 5</pre>
Verification	Display the global LLDP status information.
	<pre>FS(config)#show lldp status Global status of LLDP : Enable Neighbor information last changed time : Transmit interval : 30s Hold multiplier : 4 Reinit delay : 2s Transmit delay : 2s Notification interval : 5s Fast start counts : 5</pre>

35.4.6 Configuring the TTL Multiplier and Transmission Interval

Configuration Effect

- Configure the TTL multiplier.
- Configure the LLDP packet transmission interval.

Configuration Steps

- Optional.
- Perform the configuration in global configuration mode.

Verification

Display LLDP status information on an interface

- Check whether the configuration takes effect.

Related Commands

📌 Configuring the TTL Multiplier

Command	lldp hold-multiplier <i>value</i>
Parameter Description	<i>value</i> : Indicates the TTL multiplier. The value ranges from 2 to 10. The default value is 4.
Command Mode	Global configuration mode
Usage Guide	In an LLDP packet, the value of Time To Live TLV is calculated based on the following formula: Time to Live TLV= TTL multiplier x Packet transmission interval + 1. Therefore, you can modify the Time to Live TLV in LLDP packets by configuring the TTL multiplier.

↘ **Restoring the Default TTL Multiplier**

Command	no lldp hold-multiplier
Parameter	N/A
Description	
Command Mode	Global configuration mode
Usage Guide	In an LLDP packet, the value of Time To Live TLV is calculated based on the following formula: Time to Live TLV = TTL multiplier x Packet transmission interval + 1. Therefore, you can modify the Time to Live TLV in LLDP packets by configuring the TTL multiplier.

↘ **Configuring the Transmission Interval**

Command	lldp timer tx-interval seconds
Parameter	<i>seconds</i> : Indicates the LLDP packet transmission interval. The value ranges from 5 to 32,768.
Description	
Command Mode	Global configuration mode
Usage Guide	N/A

↘ **Restoring the Default Transmission Interval**

Command	no lldp timer tx-interval
Parameter	N/A
Description	
Command Mode	Global configuration mode
Usage Guide	N/A

Configuration Example

↘ **Configuring the TTL Multiplier and Transmission Interval**

Configuration Steps	Set the TTL multiplier to 3 and the transmission interval to 20 seconds. The TTL of local device information on neighbors is 61 seconds.
	<pre>FS(config)#lldp hold-multiplier 3 FS(config)#lldp timer tx-interval 20</pre>
Verification	Display the global LLDP status information.
	<pre>FS(config)#lldp hold-multiplier 3 FS(config)#lldp timer tx-interval 20 FS(config)#show lldp status Global status of LLDP : Enable Neighbor information last changed time : Transmit interval : 20s</pre>

Hold multiplier	: 3
Reinit delay	: 2s
Transmit delay	: 2s
Notification interval	: 5s
Fast start counts	: 3

35.4.7 Configuring the Transmission Delay

Configuration Effect

- Configure the delay time for LLDP packet transmission.

Configuration Steps

- Optional.
- Perform the configuration in global configuration mode.

Verification

Displaying the global LLDP status information

- Check whether the configuration takes effect.

Related Commands

↘ Configuring the Transmission Delay

Command	lldp timer tx-delay seconds
Parameter Description	<i>seconds</i> : Indicates the transmission delay. The value ranges from 1 to 8,192.
Command Mode	Global configuration mode
Usage Guide	When local information of a device changes, the device immediately transmits LLDP packets to its neighbors. Configure the transmission delay to prevent frequent transmission of LLDP packets caused by frequent changes of local information.

↘ Restoring the Default Transmission Delay

Command	no lldp timer tx-delay
Parameter Description	N/A
Command Mode	Global configuration mode
Usage Guide	When local information of a device changes, the device immediately transmits LLDP packets to its neighbors. Configure the transmission delay to prevent frequent transmission of LLDP packets caused by frequent changes of local information.

Configuration Example

➤ **Configuring the Transmission Delay**

Configuration Steps	Set the transmission delay to 3 seconds.
	<pre>FS(config)#lldp timer tx-delay 3</pre>
Verification	Display the global LLDP status information.
	<pre>FS(config)#show lldp status Global status of LLDP : Enable Neighbor information last changed time : Transmit interval : 30s Hold multiplier : 4 Reinit delay : 2s Transmit delay : 3s Notification interval : 5s Fast start counts : 3</pre>

35.4.8 Configuring the Initialization Delay

Configuration Effect

- Configure the delay time for LLDP to initialize on any interface.

Configuration Steps

- Optional.
- Configure the delay time for LLDP to initialize on any interface.

Verification

Display the global LLDP status information

- Check whether the configuration takes effect.

Related Commands

➤ **Configuring the Initialization Delay**

Command	lldp timer reinit-delay <i>seconds</i>
Parameter Description	<i>seconds</i> : Indicates the initialization delay . The value ranges from 1 to 10 seconds.
Command Mode	Global configuration mode
Usage Guide	Configure the initialization delay to prevent frequent initialization of the state machine caused by frequent changes of the port work mode.

➤ **Restoring the Default Initialization Delay**

Command	no lldp timer reinit-delay
Parameter	N/A
Description	
Command Mode	Global configuration mode
Usage Guide	Configure the initialization delay to prevent frequent initialization of the state machine caused by frequent changes of the port work mode.

Configuration Example

➤ **Configuring the Initialization Delay**

Configuration Steps	Set the initialization delay to 3 seconds.
	<pre>FS(config)#lldp timer reinit-delay 3</pre>
Verification	Display the global LLDP status information.
	<pre>FS(config)#show lldp status Global status of LLDP : Enable Neighbor information last changed time : Transmit interval : 30s Hold multiplier : 4 Reinit delay : 3s Transmit delay : 2s Notification interval : 5s Fast start counts : 3</pre>

35.4.9 Configuring the LLDP Trap Function

Configuration Effect

- Configure the interval for transmitting LLDP Trap messages.

Configuration Steps

➤ **Enabling the LLDP Trap Function**

- Optional.
- Perform the configuration in interface configuration mode.

➤ **Configuring the LLDP Trap Transmission Interval**

- Optional.

- Perform the configuration in global configuration mode.

Verification

Display LLDP status information

- Check whether the LLDP Trap function is enabled.
- Check whether the interval configuration takes effect.

Related Commands

📌 **Enabling the LLDP Trap Function**

Command	lldp notification remote-change enable
Parameter	N/A
Description	
Command Mode	Interface configuration mode
Usage Guide	The LLDP Trap function enables a device to send its local LLDP information (such as neighbor discovery and communication link fault) to the NMS server so that administrators learn about the network performance

📌 **Disabling the LLDP Trap Function**

Command	no lldp notification remote-change enable
Parameter	N/A
Description	
Command Mode	Interface configuration mode
Usage Guide	The LLDP Trap function enables a device to send its local LLDP information (such as neighbor discovery and communication link fault) to the NMS server so that administrators learn about the network performance.

📌 **Configuring the LLDP Trap Transmission Interval**

Command	lldp timer notification-interval <i>seconds</i>
Parameter	<i>seconds</i> : Indicates the interval for transmitting LLDP Trap messages. The value ranges from 5 to 3,600 seconds. The default value is 5 seconds.
Description	
Command Mode	Global configuration mode
Usage Guide	Configure the LLDP Trap transmission interval to prevent frequent transmission of LLDP Trap messages. LLDP changes detected within this interval will be transmitted to the NMS server.

📌 **Restoring the LLDP Trap Transmission Interval**

Command	no lldp timer notification-interval
Parameter	N/A
Description	
Command Mode	Global configuration mode
Usage Guide	Configure the LLDP Trap transmission interval to prevent frequent transmission of LLDP Trap messages. LLDP

	changes detected within this interval will be transmitted to the NMS server.
--	--

Configuration Example

➤ **Enabling the LLDP Trap Function and Configuring the LLDP Trap Transmission Interval**

Configuration Steps	Enable the LLDP Trap function and set the LLDP Trap transmission interval to 10 seconds.
	<pre>FS(config)#lldp timer notification-interval 10 FS(config)#interface gigabitethernet 0/1 FS(config-if-GigabitEthernet 0/1)#lldp notification remote-change enable</pre>
Verification	Display LLDP status information.
	<pre>FS(config-if-GigabitEthernet 0/1)#show lldp status Global status of LLDP : Enable Neighbor information last changed time : Transmit interval : 30s Hold multiplier : 4 Reinit delay : 2s Transmit delay : 2s Notification interval : 10s Fast start counts : 3 ----- Port [GigabitEthernet 0/1] ----- Port status of LLDP : Enable Port state : UP Port encapsulation : Ethernet II Operational mode : RxAndTx Notification enable : YES Error detect enable : YES Number of neighbors : 0 Number of MED neighbors : 0</pre>

35.4.10 Configuring the LLDP Error Detection Function

Configuration Effect

- Enable the LLDP error detection function. When LLDP detects an error, the error is logged.

- Configure the LLDP error detection function to detect VLAN configuration at both ends of a link, port status, aggregate port configuration, MTU configuration, and loops.

Notes

N/A

Configuration Steps

- Optional.
- Enable or disable the LLDP error detection function in interface configuration mode.

Verification

Display LLDP status information on an interface

- Check whether the configuration takes effect.

Related Commands

📌 **Enabling the LLDP Error Detection Function**

Command	lldp error-detect
Parameter	N/A
Description	
Command Mode	Interface configuration mode
Usage Guide	The LLDP error detection function relies on specific TLVs in LLDP packets exchanged between devices at both ends of a link. Therefore, a device needs to advertise correct TLVs to ensure the LLDP error detection function.

📌 **Disabling the LLDP Error Detection Function**

Command	no lldp error-detect
Parameter	N/A
Description	
Command Mode	Interface configuration mode
Usage Guide	The LLDP error detection function relies on specific TLVs in LLDP packets exchanged between devices at both ends of a link. Therefore, a device needs to advertise correct TLVs to ensure the LLDP error detection function.

Configuration Example

📌 **Enabling the LLDP Error Detection Function**

Configuration Steps	Enable the LLDP error detection function on interface GigabitEthernet 0/1.
	<pre>FS(config)#interface gigabitEthernet 0/1 FS(config-if-GigabitEthernet 0/1)#lldp error-detect</pre>
Verification	Display LLDP status information on the interface.

```

FS(config-if-GigabitEthernet 0/1)#show lldp status interface gigabitethernet 0/1
Port [GigabitEthernet 0/1]
Port status of LLDP           : Enable
Port state                    : UP
Port encapsulation           : Ethernet II
Operational mode              : RxAndTx
Notification enable           : NO
Error detect enable           : YES
Number of neighbors           : 0
Number of MED neighbors       : 0
    
```

35.4.11 Configuring the LLDP Encapsulation Format

Configuration Effect

- Configure the LLDP encapsulation format.

Configuration Steps

- Optional.
- Configure the LLDP encapsulation format on an interface.

Verification

Display LLDP status information of an interface

- Check whether the configuration takes effect.

Related Commands

⚡ Setting the LLDP Encapsulation Format to SNAP

Command	lldp encapsulation snap
Parameter	N/A
Description	
Command Mode	Interface configuration mode
Usage Guide	 The LLDP encapsulation format configuration on a device and its neighbors must be consistent.

⚡ Restoring the Default LLDP Encapsulation Format (Ethernet II)

Command	No lldp encapsulation snap
Parameter	N/A
Description	
Command Mode	Interface configuration mode

Usage Guide	The LLDP encapsulation format configuration on a device and its neighbors must be consistent.
--------------------	---

Configuration Example

Setting the LLDP Encapsulation Format to SNAP

Configuration Steps	Set the LLDP encapsulation format to SNAP.
	<pre>FS(config)#interface gigabitethernet 0/1 FS(config-if-GigabitEthernet 0/1)#lldp encapsulation snap</pre>
Verification	Display LLDP status information on the interface.
	<pre>FS(config-if-GigabitEthernet 0/1)#show lldp status interface gigabitethernet 0/1 Port [GigabitEthernet 0/1] Port status of LLDP : Enable Port state : UP Port encapsulation : Snap Operational mode : RxAndTx Notification enable : NO Error detect enable : YES Number of neighbors : 0 Number of MED neighbors : 0</pre>

35.4.12Configuring the LLDP Network Policy

Configuration Effect

- Configure the LLDP Network Policy.
- If a device is connected to an IP-Phone that supports LLDP-MED, you can configure the Network Policy TLV to push policy configuration to the IP-Phone, , which enables the IP-Phone to change the tag and QoS of voice streams. In addition to the LLDP Network Policy, perform the following steps on the device: 1. Enable the Voice VLAN function and add the port connected to the IP-Phone to the Voice VLAN. 2. Configure the port connected to the IP-Phone as a QoS trusted port (the trusted DSCP mode is recommended). 3. If 802.1X authentication is also enabled on the port, configure a secure channel for the packets from the Voice VLAN. If the IP-Phone does not support LLDP-MED, enable the voice VLAN function and add the MAC address of the IP-Phone to the Voice VLAN OUI list manually.
- For the configuration of the QoS trust mode, see *Configuring IP QoS*; for the configuration of the Voice VLAN, see *Configuring Voice VLAN*; for the configuration of the secure channel, see *Configuring ACL*.

Configuration Steps

- Optional.
- Configure the LLDP Network Policy.

Verification

Displaying the LLDP network policy configuration.

- Check whether the configuration takes effect.

Related Commands

📌 **Configuring the LLDP Network Policy**

Command	lldp network-policy profile <i>profile-num</i>
Parameter	<i>profile-num</i> : Indicates the ID of an LLDP Network Policy. The value ranges from 1 to 1,024.
Description	
Command	Global configuration mode
Mode	
Usage Guide	Run this command to enter the LLDP network policy mode after specifying a policy ID. After entering the LLDP network policy mode, run the { voice voice-signaling } vlan command to configure a specific network policy.

📌 **Deleting the LLDP Network Policy**

Command	no lldp network-policy profile <i>profile-num</i>
Parameter	<i>profile-num</i> : Indicates the LLDP Network Policy ID. The value ranges from 1 to 1,024.
Description	
Command	Interface configuration mode
Mode	
Usage Guide	Run this command to enter the LLDP network policy mode after specifying a policy ID. After entering the LLDP network policy mode, run the { voice voice-signaling } vlan command to configure a specific network policy.

Configuration Example

📌 **Configuring the LLDP Network Policy**

Configuration Steps	Set the Network Policy TLV to 1 for LLDP packets to be advertised by port GigabitEthernet 0/1 and set the VLAN ID of the Voice application to 3, COS to 4, and DSCP to 6.
	<pre> FS#config FS(config)#lldp network-policy profile 1 FS(config-lldp-network-policy)# voice vlan 3 cos 4 FS(config-lldp-network-policy)# voice vlan 3 dscp 6 FS(config-lldp-network-policy)#exit FS(config)# interface gigabitEthernet 0/1 FS(config-if-GigabitEthernet 0/1)# lldp tlv-enable med-tlv network-policy profile 1 </pre>
Verification	Display the LLDP network policy configuration on the local device.
	<pre> network-policy information: </pre>

```

-----
network policy profile :1
voice vlan 3 cos 4
voice vlan 3 dscp 6
    
```

35.4.13 Configuring the Civic Address

Configuration Effect

- Configure the civic address of a device.

Configuration Steps

- Optional.
- Perform this configuration in LLDP Civic Address configuration mode.

Verification

Display the LLDP civic address of the local device

- Check whether the configuration takes effect.

Related Commands

↘ Configuring the Civic Address of a Device

Command	Configure the LLDP civic address. Use the no option to delete the address. { country state county city division neighborhood street-group leading-street-dir trailing-street-suffix street-suffix number street-number-suffix landmark additional-location-information name postal-code building unit floor room type-of-place postal-community-name post-office-box additional-code } ca-word
Parameter Description	<p>country: Indicates the country code, with two characters. CH indicates China.</p> <p>state: Indicates the CA type is 1.</p> <p>county: Indicates that the CA type is 2.</p> <p>city: Indicates that the CA type is 3.</p> <p>division: Indicates that the CA type is 4.</p> <p>neighborhood: Indicates that the CA type is 5.</p> <p>street-group: Indicates that the CA type is 6.</p> <p>leading-street-dir: Indicates that the CA type is 16.</p> <p>trailing-street-suffix: Indicates that the CA type is 17.</p> <p>street-suffix: Indicates that the CA type is 18.</p> <p>number: Indicates that the CA type is 19.</p> <p>street-number-suffix: Indicates that the CA type is 20.</p> <p>landmark: Indicates that the CA type is 21.</p> <p>additional-location-information: Indicates that the CA type is 22.</p> <p>name: Indicates that the CA type is 23.</p> <p>postal-code: Indicates that the CA type is 24.</p> <p>building: Indicates that the CA type is 25.</p>

	<p>unit: Indicates that the CA type is 26.</p> <p>floor: Indicates that the CA type is 27.</p> <p>room: Indicates that the CA type is 28.</p> <p>type-of-place: Indicates that the CA type is 29.</p> <p>postal-community-name: Indicates that the CA type is 30.</p> <p>post-office-box: Indicates that the CA type is 31.</p> <p>additional-code: Indicates that the CA type is 32.</p> <p><i>ca-word:</i> Indicates the address.</p>
Command Mode	LLDP Civic Address configuration mode
Usage Guide	After entering the LLDP Civic Address configuration mode, configure the LLDP civic address.

📌 **Deleting the Civic Address of a Device**

Command	no { country state county city division neighborhood street-group leading-street-dir trailing-street-suffix street-suffix number street-number-suffix landmark additional-location-information name postal-code building unit floor room type-of-place postal-community-name post-office-box additional-code }
Parameter Description	N/A
Command Mode	LLDP Civic Address configuration mode
Usage Guide	After entering the LLDP Civic Address configuration mode, configure the LLDP civic address.

📌 **Configuring the Device Type**

Command	device-type <i>device-type</i>
Parameter Description	<p><i>device-type:</i> Indicates the device type. The value ranges from 0 to 2. The default value is 1.</p> <p>0 indicates that the device type is DHCP server.</p> <p>1 indicates that the device type is switch.</p> <p>2 indicates that the device type is LLDP MED .</p>
Command Mode	LLDP Civic Address configuration mode
Usage Guide	After entering the LLDP Civic Address configuration mode, configure the device type.

📌 **Restoring the Device Type**

Command	no device-type
Parameter Description	N/A
Command Mode	LLDP Civic Address configuration mode
Usage Guide	After entering the LLDP Civic Address configuration mode, restore the default settings.

Configuration Example

📌 **Configuring the Civic Address of a Device**

Configuration Steps	Set the address of port GigabitEthernet 0/1 as follows: set country to CH, city to Fuzhou, and postal code to 350000.
	<pre>FS#config FS(config)#lldp location civic-location identifier 1 FS(config-lldp-civic)# country CH FS(config-lldp-civic)# city Fuzhou FS(config-lldp-civic)# postal-code 350000</pre>
Verification	Display the LLDP civic address of port GigabitEthernet 0/1 1.
	<pre>civic location information: ----- Identifier :1 country :CH device type :1 city :Fuzhou postal-code :350000</pre>

35.4.14 Configuring the Emergency Telephone Number

Configuration Effect

- Configure the emergency telephone number of a device.

Configuration Steps

- Optional.
- Perform this configuration in global configuration mode.

Verification

Display the emergency telephone number of the local device

- Check whether the configuration takes effect.

Related Commands

↘ Configuring the Emergency Telephone Number of a Device

Command	lldp location elin identifier <i>id</i> elin-location <i>tel-number</i>
Parameter	<i>id</i> : Indicates the identifier of an emergency telephone number. The value ranges from 1 to 1,024.
Description	<i>tel-number</i> : Indicates emergency telephone number, containing 10-25 characters.
Command Mode	Global configuration mode
Usage Guide	Run this command to configure the emergency telephone number.

➤ **Deleting the Emergency Telephone Number of a Device**

Command	no lldp location elin identifier <i>id</i>
Parameter Description	<i>id</i> : Indicates the identifier of an emergency telephone number. The value ranges from 1 to 1,024.
Command Mode	Global configuration mode
Usage Guide	N/A

Configuration Example

➤ **Configuring the Emergency Telephone Number of a Device**

Configuration Steps	Set the emergency telephone number of port GigabitEthernet 0/1 to 08528555556.
	<pre>FS#config FS(config)#lldp location elin identifier 1 elin-location 085283671111</pre>
Verification	Display the emergency telephone number of port GigabitEthernet 0/1.
	<pre>elin location information: ----- Identifier :1 elin number :085283671111</pre>

35.4.15 Configuring the Function of Ignoring PVID Detection

Configuration Effect

- Ignores the PVID detection.

Configuration Steps

- Optional.
- According to the real condition, select whether to enable the function..

Verification

Display the LLDP information.

- Check whether the status of PVID detection in global LLDP is the same as your configuration.

Related Commands

➤ **Ignoring PVID Detection**

Command	lldp ignore pvid-error-detect
Parameter Description	N/A

Command Mode	Global configuration mode
Usage Guide	Use the command to ignore PVID detection.

Configuration Example

Configuring the Function of Ignoring PVID Detection

Configuration Steps	<p> Ignores PVID detection in global configuration mode.</p> <pre> FS#config FS(config)#lldp ignore pvid-error-detect </pre>
Verification	<p> Display the global LLDP information.</p> <pre> uijie(config)#show lldp status Global status of LLDP : Enable Neighbor information last changed time : Transmit interval : 30s Hold multiplier : 4 Reinit delay : 2s Transmit delay : 2s Notification interval : 5s Fast start counts : 5 Igore PVID error detect : YES </pre>

35.4.16 Configuring the Type of the Management Address in LLDP Packets

Configuration Effect

- Changes the priority order of the addresses chosen to be the management address in LLDP packets.
- Restores the default priority order of the addresses chosen to be the management address.

Notes

- LLDP runs on physical ports (AP member ports for AP ports). Stacked ports and VSL ports do not support LLDP.

Configuration Steps

- Optional.
- Configure the type of the management address in LLDP packets.

Verification

- Display the management address in LLDP packets.
- Check whether the candidate addresses are chosen as the management address in the configured order.

Related Commands

↳ **Configuring the Type of the Management Address in LLDP Packets**

Command	lldp management-address-tlv global-ip type { interface loopback }
Parameter Description	interface: Uses the IP address of the interface as the management address. loopback: Uses the IP address of the Loopback interface as the management address.
Command Mode	Global configuration mode
Usage Guide	<p>By default, the management address in LLDP packets is chosen in the following order: the configured management address for LLDP packets, the IP address of the MGMT port, the IP address of the SVI (IP address of the routed port), the local IP address 127.0.0.1, and the MAC address of the system.</p> <p>If the interface parameter is adopted, the management address, in the order of priority, is: the configured LLDP address for LLDP packets, the IP address of the SVI (IP address of the routed port), the local IP address 127.0.0.1, and the MAC address of the system.</p> <p>If the loopback parameter is adopted, the management address, in the order of priority, is: the configured LLDP address for LLDP packets, the IP address of the Loopback port, the local IP address 127.0.0.1, and the MAC address of the system.</p>

↳ **Restoring the Default Priority Order of Candidate Addresses**

Command	{no default} lldp management-address-tlv global-ip
Parameter Description	N/A
Command Mode	Global configuration mode
Usage Guide	By default, the management address in LLDP packets is chosen in the following order: the configured management address for LLDP packets, the IP address of the MGMT port, the IP address of the SVI (IP address of the routed port), the local IP address 127.0.0.1, and the MAC address of the system.

Configuration Example

↳ **Configuring the Type of the Management Address in LLDP Packets**

Configuration Steps	Uses the IP address of the interface as the management address.
	<pre>FS(config)#lldp management-address-tlv global-ip type interface</pre>
Verification	Configure the IP address of MGMT port, and display the LLDP configuration information. The management address is the IP address of MGMT port.
	<pre>FS(config)#show lldp local-information int gi1/0/1 LLDP local-information of port [TenGigabitEthernet 1/0/1] ----- Port ID type : Interface name</pre>

<pre> Port ID : TenGigabitEthernet 1/0/1 Port description : TenGigabitEthernet 1/0/1 Management address subtype : ipv4 Management address : 172.30.32.217 Interface numbering subtype : ifIndex Interface number : 8194 Object identifier : 802.1 organizationally information Port VLAN ID : 1 Port and protocol VLAN ID(PPVID) : 0 PPVID Supported : YES PPVID Enabled : NO VLAN name of VLAN 1 : VLAN0001 Protocol Identity :</pre>
<p>Use the IP address of the interface as the management address, and display the LLDP configuration information. The management address is the IP address of the SVI.</p>
<pre> FS(config)# lldp management-address-tlv global-ip type interface FS(config)# show lldp local-information int gi1/0/1 LLDP local-information of port [TenGigabitEthernet 1/0/1] ----- Port ID type : Interface name Port ID : TenGigabitEthernet 1/0/1 Port description : TenGigabitEthernet 1/0/1 Management address subtype : ipv4 Management address : 172.30.32.235 Interface numbering subtype : ifIndex Interface number : 4097 Object identifier :</pre> <pre> 802.1 organizationally information Port VLAN ID : 1</pre>

<pre> Port and protocol VLAN ID(PPVID) :0 PPVID Supported :YES PPVID Enabled :NO VLAN name of VLAN 1 :VLAN0001 Protocol Identity : </pre>
<p>Use the IP address of the Loopback interface as the management address, and display the LLDP configuration information. The management address is the IP address of the Loopback interface.</p>
<pre> FS(config)# lldp management-address-tlv global-ip type loopback FS(config)#show lldp local-information int gi1/0/1 LLDP local-information of port [TenGigabitEthernet 1/0/1] ----- Port ID type : Interface name Port ID : TenGigabitEthernet 1/0/1 Port description : TenGigabitEthernet 1/0/1 Management address subtype : ipv4 Management address : 7.1.1.1 Interface numbering subtype : ifIndex Interface number : 16385 Object identifier : 802.1 organizationally information Port VLAN ID : 1 Port and protocol VLAN ID(PPVID) :0 PPVID Supported :YES PPVID Enabled :NO VLAN name of VLAN 1 :VLAN0001 Protocol Identity : </pre>

35.5 Monitoring

Clearing

Running the **clear** commands may lose vital information and thus interrupt services.

Description	Command
Clears LLDP statistics.	clear lldp statistics [interface interface-name]

Clears LLDP neighbor information.	clear lldp table [interface <i>interface-name</i>]
-----------------------------------	--

Displaying

Description	Command
Displays LLDP information on the local device, which will be organized as TLVs and sent to neighbors.	show lldp local-information [global interface <i>interface-name</i>]
Displays the LLDP civic address or emergency telephone number of a local device.	show lldp location { civic-location elin-location } { identifier <i>id</i> interface <i>interface-name</i> static }
Displays LLDP information on a neighbor.	show lldp neighbors [interface <i>interface-name</i>] [detail]
Displays the LLDP network policy configuration of the local device.	show lldp network-policy { profile [<i>profile-num</i>] interface <i>interface-name</i> }
Displays LLDP statistics.	show lldp statistics [global interface <i>interface-name</i>]
Displays LLDP status information.	show lldp status [interface <i>interface-name</i>]
Displays the configuration of TLVs to be advertised by a port.	show lldp tlv-config [interface <i>interface-name</i>]

Debugging



System resources are occupied when debugging information is output. Therefore, disable debugging immediately after use.

Description	Command
Debugs LLDP error processing.	debug lldp error
Debugs LLDP event processing.	debug lldp event
Debugs LLDP hot backup processing.	debug lldp ha
Debugs the LLDP packet reception.	debug lldp packet
Debugs the LLDP state machine.	debug lldp stm

36 Configuring QinQ

36.1 Overview

QinQ is used to insert a public virtual local area network (VLAN) tag into a packet with a private VLAN tag to allow the double-tagged packet to be transmitted over a service provider (SP) network.

Users on a metropolitan area network (MAN) must be separated by VLANs. IEEE 802.1Q supports only 4,094 VLANs, far from enough. Through the double-tag encapsulation provided by QinQ, a packet is transmitted over the SP network based on the unique outer VLAN tag assigned by the public network. In this way, private VLANs can be reused, which increases the number of available VLAN tags and provides a simple Layer-2 virtual private network (VPN) feature.

Figure 13-1 shows the double-tag insertion process. The entrance to an SP network is called a dot1q-tunnel port, or Tunnel port for short. All frames entering provider edges (PEs) are considered untagged. All tags, whether untagged frames or frames with customer VLAN tags, are encapsulated with the tags of the SP network. The VLAN ID of the SP network is the ID of the default VLAN for the Tunnel port.

Figure 13-1 Outer Tag Encapsulation

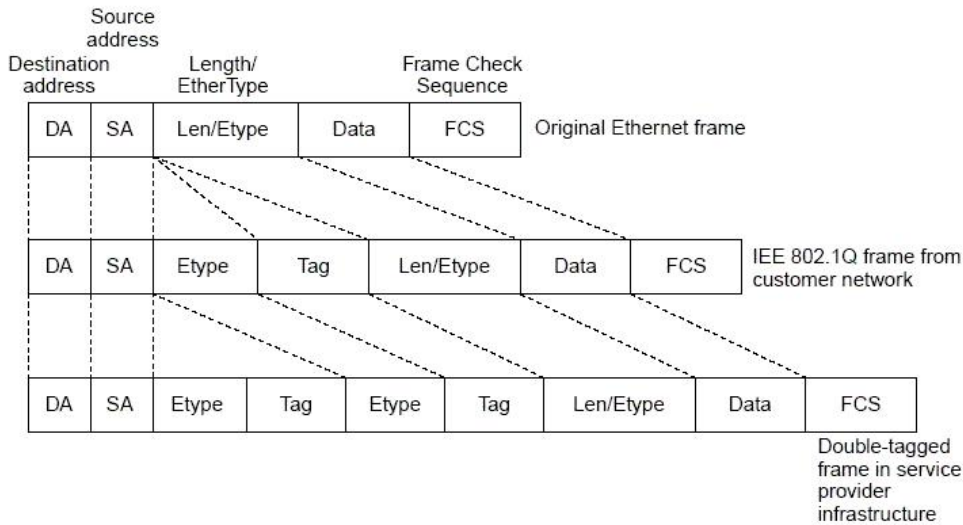

Protocols and Standards

- IEEE 802.1ad

36.2 Applications

Application	Description
Implementing Layer-2 VPN Through Port-Based Basic QinQ	Data is transmitted from Customer A and Customer B to the peer end without conflict on the SP network even if the data comes from the same VLAN.
Implementing Layer-2 VPN and Service Flow Management Through C-TAG-Based Selective QinQ	Outer tags are inserted into frames flexibly based on different customer VLANs to achieve Layer-2 VPN, segregate service flows (e.g., broadband Internet access and IPTV), and implement various QoS policies. Customer tag (C-TAG)-based QinQ is more flexible than port-based QinQ.
Implementing Layer-2 VPN and Service Flow Management Through ACL-Based Selective QinQ	The different service flows, such as broadband Internet access and IPTV, are segregated based on access control lists (ACLs). Different QoS policies are applied to service flows through selective QinQ.
Implementing VLAN Aggregation for Different Services Through VLAN Mapping	Different service flows (PC, IPTV, and VoIP) are transmitted through different VLANs. The VLANs are aggregated on a campus network so that only one VLAN is used to carry the same service flows, thus saving VLAN resources.
Implementing QinQ-Based Layer-2 Transparent Transmission	Customer Network A and Customer Network B in different areas can perform unified Multiple Spanning Tree Protocol (MSTP) calculation or VLAN deployment across the SP network without affecting the SP network.

36.2.1 Implementing Layer-2 VPN Through Port-Based Basic QinQ

Scenario

An SP provides the VPN service to Customer A and Customer B.

- Customer A and Customer B belong to different VLANs on the SP network and achieve communication through respective SP VLANs.
- The VLANs of Customer A and Customer B are transparent to the SP network. The VLANs can be reused without conflicts.
- The Tunnel port encapsulates a native VLAN tag in each packet. Packets are transmitted through the native VLAN over the SP network without impact on the VLANs of Customer A and Customer B, thus implementing simple Layer-2 VPN.

Figure 13-2

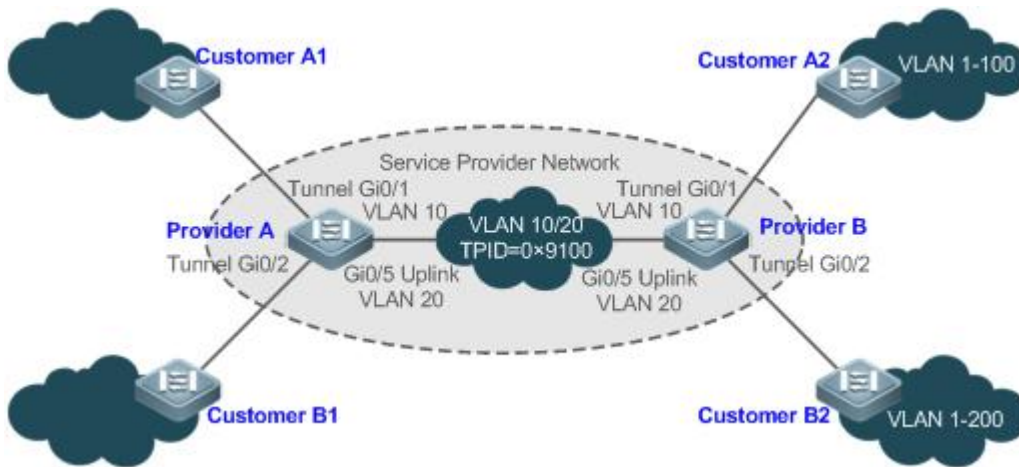

Remarks	<p>Customer A1 and Customer A2 are the customer edges (CEs) for Customer A network. Customer B1 and Customer B2 are the CEs for Customer B network.</p> <p>Provider A and Provider B are the PEs on the SP network. Customer A and Customer B access the SP network through Provider A and Provider B.</p> <p>The VLAN of Customer A ranges from 1 to 100.</p> <p>The VLAN of Customer B ranges from 1 to 200.</p>
----------------	--

Deployment

- Enable basic QinQ on PEs to implement Layer-2 VPN.
- The tag protocol identifiers (TPIDs) used by many switches (including FS switches) are set to 0x8100, but the switches of some vendors do not use 0x8100. In the latter case, you need to change the TPID value on the Uplink ports of PEs to the values of the TPIDs used by third-party switches.
- Configure priority replication and priority mapping for class of service (CoS) on the Tunnel ports of PEs, and configure different QoS policies for different service flows (for details, see *Configuring QoS*).

36.2.2 Implementing Layer-2 VPN and Service Flow Management Through C-TAG-Based Selective QinQ

Scenario

Basic QinQ encapsulates an outer tag of the native VLAN in a packet. That is, the encapsulation of outer tags depends on the native VLAN on Tunnel ports. Selective QinQ encapsulates an outer tag in a packet based on its inner tag to implement VPN transparent transmission and apply QoS policies flexibly.

- Broadband Internet access and IPTV are important services carried by MANs. The SPs manage different service flows through different VLANs and provides QoS policies for the VLANs or CoS. You can enable C-TAG-based QinQ on PEs to encapsulate outer VLAN tags in the service flows to achieve transparent transmission based on the QoS policies of the SP network.
- Important services and regular services are separated within different VLAN ranges. The customer can transmit service flows transparently over an SP network through C-TAG-based selective QinQ and ensure preferential transmission of important service flows by using the QoS policies of the SP network.

In Figure 13-3, the CEs are aggregated by the floor switches inside residential buildings. The broadband Internet access and IPTV services are segregated by VLANs with different QoS policies.

- The service flows of broadband Internet access and IPTV are transmitted transparently by different VLANs over the SP network.

- The SP network provides QoS policies based on VLANs or CoS. On the PEs, you can encapsulate an outer tag in the service flow based on its inner VLAN tag or set a CoS to ensure preferential transmission of service flows over the SP network.
- The CoS values of service packets can be changed through priority mapping or replication so that the QoS policies of the SP network are applied flexibly.

Figure 13-3

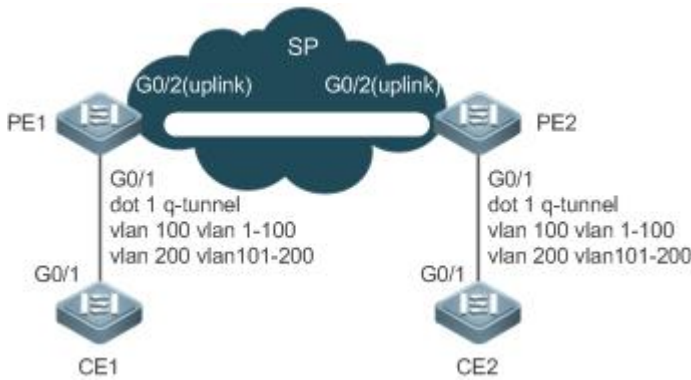

Remarks	<p>CE 1 and CE 2 access the SP network through PE1 and PE2.</p> <p>On CE 1 and CE 2, the broadband Internet access flows are transmitted through VLAN 1–100, and IPTV flows are transmitted through VLAN 101–200.</p> <p>PE 1 and PE 2 are configured with Tunnel ports and VLAN mappings to segregate service flows.</p>
----------------	---

Deployment

- Configure C-TAG-based selective QinQ on the ports (G0/1) of PE 1 and PE 2 connected to CE 1 and CE 2 respectively to realize the segregation and transparent transmission of service flows.
- If the SP network provides QoS policies based on VLANs or CoS, you can encapsulate an outer tag in the service flow based on its inner tag or set a CoS through priority replication or mapping on PE 1 and PE 2 to ensure preferential transmission of service flows over the SP network.

36.2.3 Implementing Layer-2 VPN and Service Flow Management Through ACL-Based Selective QinQ

Scenario

The service flows from the customer network may be classified by MAC address, IP address, or protocol type, instead of by VLAN. The customer network may contain many low-end access devices unable to segregate service flows by VLAN IDs. In the preceding two situations, the packets from the customer network cannot be encapsulated with outer tags based on their inner tags to realize transparent transmission and implement QoS policies. Service flows may be classified by MAC address, IP address, or protocol type through ACLs. Selective QinQ uses ACLs to segregate service flows and add or modify outer tags in order to implement Layer-2 VPN and QoS policies based on different service flows.

In Figure 13-4, different VLANs are configured on PE 1 and PE 2 to transmit different service flows classified through ACLs. If the SP network provides QoS policies based on different services, certain services can be transmitted preferentially.

- Outer VLAN tags are encapsulated based on different service flows. The service flows of a customer network can be transmitted transparently, and its branch offices can access each other.
- The SP network provides QoS policies based on the VLAN tags or CoS values to ensure preferential transmission of certain service flows.

Figure 13-4

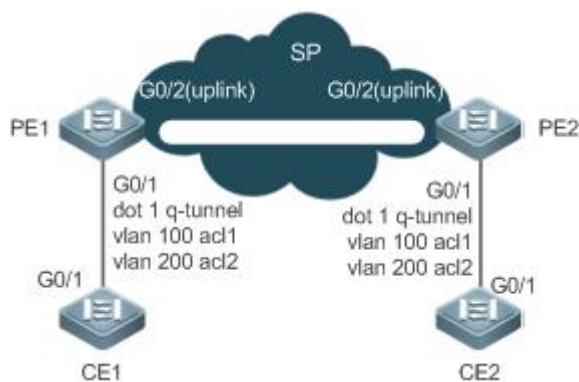

Remarks	<p>CE 1 and CE 2 access the SP network through PE1 and PE2.</p> <p>PE 1 and PE 2 classify flows based on ACLs: ACL 1 matches the Point-to-Point Protocol over Ethernet (PPPoE) flows, and ACL 2 matches the IPTV flows.</p> <p>PE 1 and PE 2 are configured with Tunnel ports, as well as outer tag encapsulation policies applicable to service flows recognized by different ACLs.</p>
----------------	--

Deployment

- Configure ACLs on PE 1 and PE 2 to segregate service flows.
- Configure ACL-based selective QinQ on the ports (G0/1) of PE 1 and PE 2 connected to CE 1 and CE 2 respectively to realize the segregation and transparent transmission of service flows.
- If the SP network provides QoS policies based on VLANs or CoS, you can encapsulate an outer tag in the service flow based on its inner tag or set a CoS through priority replication or mapping on PE 1 and PE 2 to ensure preferential transmission of service flows over the SP network.

36.2.4 Implementing VLAN Aggregation for Different Services Through VLAN Mapping

Scenario

The different service flows of different users are segregated on a campus network.

- The different service flows are transmitted through different VLANs on the home gateway.
- The same service flows from different users are segregated on the floor switch.
- The same service flows from different users are sent by a campus switch through one single VLAN.

Figure 13-5

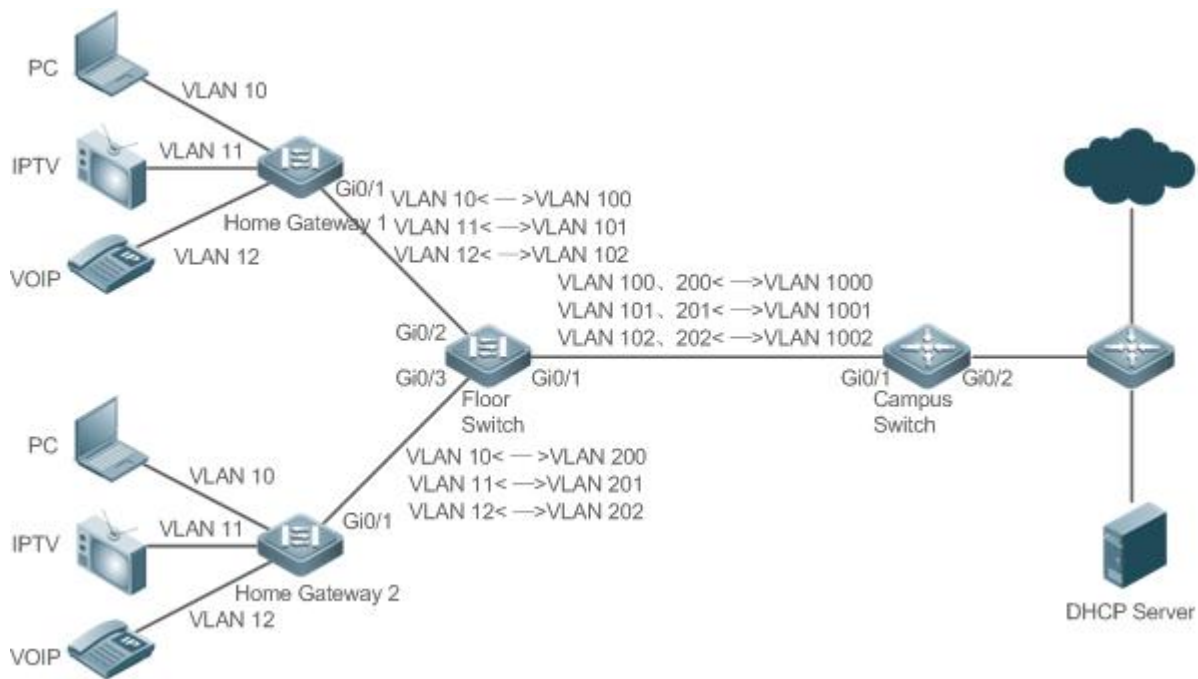

Remarks	<p>PC, IPTV, and VoIP are different user services.</p> <p>Switch A and Switch B are the gateway devices of different users.</p> <p>Switch C is a floor switch.</p> <p>Switch D is a campus switch.</p>
----------------	--

Deployment

- On the home gateway devices, configure VLANs for different services to segregate service flows. For example, configure VLAN 10 for the PC service, VLAN 11 for IPTV, and VLAN 12 for VoIP.
- On the ports of the floor switch (Switch D) connected to the home gateway devices, configure VLAN mapping to segregate the service flows of different users.
- On the campus switch, configure VLAN mapping to segregate the service flows.
- Through the preceding deployment, the different service flows of different users are segregated.

36.2.5 Implementing QinQ-Based Layer-2 Transparent Transmission

Scenario

The Layer-2 transparent transmission between customer networks has no impact on the SP network.

- The Layer-2 packets on customer networks are transparent to SP networks and can be transmitted between the customer networks without impact on the SP networks.

Figure 13-6

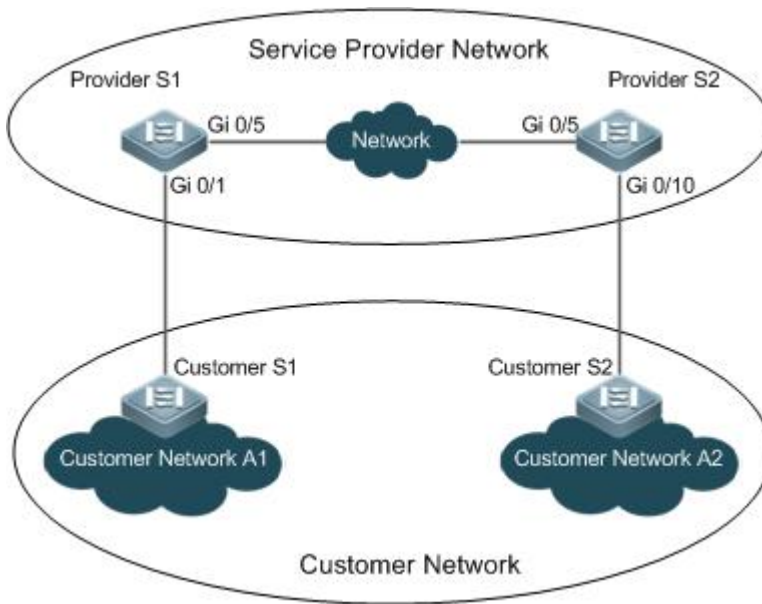

Remarks	<p>Customer S1 and Customer S2 access the SP network through Provider S1 and Provider S2.</p> <p>Provider S1 and Provider S2 are enabled with Layer-2 transparent transmission globally, and the Gi 0/1 and Gi 0/10 ports are enabled with Layer-2 transparent transmission.</p>
----------------	--

Deployment

- On the ports of the PEs (Provider S1 and Provider S2) connected to Customer S1 and Customer S2 respectively, configure Layer-2 transparent transmission between Customer Network A1 and Customer Network A2 without impact on the SP network.
- Configure STP transparent transmission based on user requirements to realize transparent transmission of bridge protocol data unit (BPDU) packets between Customer Network A1 and Customer Network A2 and to perform unified MSTP calculation across the SP network.
- Configure GARP VLAN Registration Protocol (GVRP) transparent transmission based on user requirements to realize transparent transmission of GVRP packets between Customer Network A1 and Customer Network A2 and dynamic VLAN configuration on the customer networks across the SP network.

36.3 Features

Basic Concepts

Basic QinQ

Configure basic QinQ on a Tunnel port and configure a native VLAN for the port. Packets entering the port are encapsulated with outer tags containing the native VLAN ID. Basic QinQ does not segregate service flows and cannot encapsulate packets flexibly based on VLANs.

Selective QinQ

Selective QinQ is classified into two types: selective QinQ based on C-TAGs and selective QinQ based on ACLs.

In C-TAG-based selective QinQ, outer tags are encapsulated in packets based on the inner tags to segregate service flows and realize transparent transmission.

In ACL-based selective QinQ, outer tags are encapsulated in packets based on the ACLs to segregate service flows.

➤ **TPID**

An Ethernet frame tag consists of four fields: TPID, User Priority, Canonical Format Indicator (CFI), and VLAN ID.

By default, the TPID is 0x8100 according to IEEE802.1Q. On the switches of some vendors, the TPID is set to 0x9100 or other values. The TPID configuration aims to ensure that the TPIDs of packets to be forwarded are compatible with the TPIDs supported by third-party switches.

➤ **Priority Mapping and Priority Replication**

The default value of User Priority in Ethernet frame tags is 0, indicating regular flows. You can set this field to ensure preferential transmission of certain packets. You can specify User Priority by setting the value of CoS in a QoS policy.

Priority replication: If the SP network provides a QoS policy corresponding to a specified CoS in the inner tag, you can replicate the CoS of the inner tag to the outer tag to enable transparent transmission based on the QoS policy provided by the SP network.

Priority mapping: If the SP network provides various QoS policies corresponding to specified CoS values for different service flows, you can map the CoS value of the inner tag to the CoS value of the outer tag to ensure preferential transmission of service flows based on the QoS policies provided by the SP network.

➤ **Layer-2 Transparent Transmission**

STP and GVRP packets may affect the topology of the SP network. If you want to unify the topology of two customer networks separated by the SP network without affecting the SP network topology, transmit the STP and GVRP packets from the customer networks over the SP network transparently.

Overview

Feature	Description
Basic QinQ	Configures the Tunnel port and specifies whether packets sent from the port are tagged.
Selective QinQ	Encapsulates different outer tags in data flows based on ACLs.
VLAN Mapping	Replaces the inner tags of packets with outer tags, and then restores the outer tags to inner tags based on the same rules.
TPID Configuration	By default, the TPID is 0x8100 according to IEEE802.1Q. On the switches of some vendors, the TPIDs of outer tags are set to 0x9100 or other values. The TPID configuration aims to ensure that the TPIDs of packets to be forwarded are compatible with the TPIDs supported by third-party switches.
MAC Address Replication	In ACL-based selective QinQ, the VLAN IDs for the MAC addresses that switches learn belong to the native VLAN. If VLAN conversion is implemented based on ACLs, upon receiving packets from the peer end, the local end may fail to query MAC addresses, causing a flood. To address this problem, MAC address replication is provided to replicate the MAC addresses of the native VLAN to the VLAN where the outer tag is located.
Layer-2 Transparent Transmission	Transmits Layer-2 packets between customer networks without impact on SP networks.
Priority Replication	If the SP network provides a QoS policy corresponding to a specified CoS value in the inner tag, you can replicate the CoS of the inner tag to the outer tag to enable transparent transmission based on the QoS policy provided by the SP network.
Priority Mapping	If the SP network provides various QoS policies corresponding to specified CoS values for different service flows, you can map the CoS value of the inner tag to the CoS value of the outer tag to ensure preferential transmission of service flows based on the QoS policies provided by the SP network.

36.3.1 Basic QinQ

Basic QinQ can be used to implement simple Layer-2 VPN, but it lacks flexibility in encapsulating outer tags.

Working Principle

After a Tunnel port receives a packet, the switch adds the outer tag containing the default VLAN ID to the packet. If the received packet already carries a VLAN tag, it is encapsulated as a double-tagged packet. If it does not have a VLAN tag, it is added with the VLAN tag containing the default VLAN ID.

36.3.2 Selective QinQ

Selective QinQ adds different outer tags to data flows flexibly.

Working Principle

Selective QinQ can be used to encapsulate different outer tags based on inner tags, MAC addresses, protocol numbers, source addresses, destination addresses, priorities, or the port numbers of applications. In this way, packets of different users, services, and priorities are encapsulated with different outer VLAN tags.

You can configure the following selective QinQ policies:

- Add an outer VLAN tag based on the inner VLAN tag.
- Modify an outer VLAN tag based on the outer VLAN tag.
- Modify an outer VLAN tag based on the inner VLAN tag.
- Modify an outer VLAN tag based on the inner and outer VLAN tags.
- Add an outer VLAN tag based on the ACL.
- Modify an outer VLAN tag based on the ACL.
- Modify an inner VLAN tag based on the ACL.

36.3.3 VLAN Mapping

Working Principle

The inner tag of a packet is replaced by an outer tag to allow the packet to be transmitted based on the public network topology. When the packet is transmitted to the customer network, the outer tag is restored to the original inner tag based on the same rule. VLAN mapping supports the following mapping rule:

- 1:1 VLAN mapping: Changes a VLAN ID to the specified VLAN ID.

1:1 VLAN Mapping Mode 1

1:1 VLAN mapping is mainly applied on floor switches to use different VLANs to carry the same services from different users, as shown in Figure 13-7.

Figure 13-7

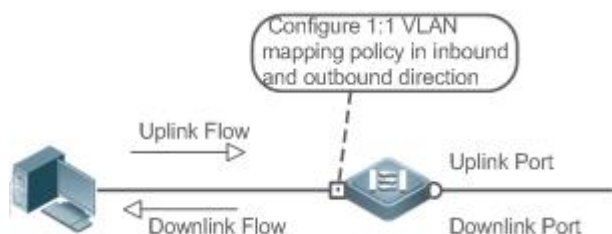

- Configure the Downlink port with a VLAN mapping policy in the inbound direction to map the inner tag of the uplink flow to an outer tag.

- Configure the Uplink port with a VLAN mapping policy in the outbound direction to map the outer tag of the downlink flow to the original inner tag.

➤ **1:1 VLAN Mapping Mode 2**

Figure 13-8

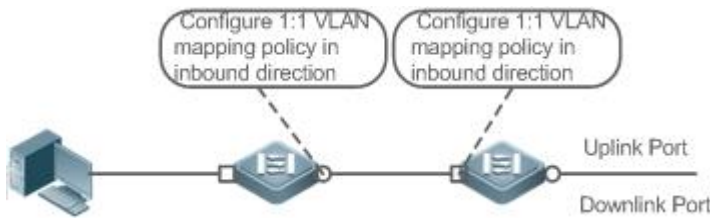

- Configure the Downlink port with a VLAN mapping policy in the inbound direction to map the inner tag of the uplink flow to an outer tag.
- For downstream data flows, Configure the Uplink port with a VLAN mapping policy in the inbound direction to the outer tag of the downlink flow to the original inner tag.

36.3.4TPID Configuration

Working Principle

An Ethernet frame tag consists of four fields, namely, TPID, User Priority, CFI, and VLAN ID. By default, the TPID is 0x8100 according to IEEE802.1Q. On the switches of some vendors, the TPIDs of outer tags are set to 0x9100 or other values. The TPID configuration feature allows you to configure TPIDs on ports, which will replace the TPIDs of the outer VLAN tags in packets with the configured TPIDs to realize TPID compatibility.

36.3.5MAC Address Replication

Working Principle

In ACL-based selective QinQ, the MAC address learned by a switch belongs to the native VLAN. The Tunnel port tags the packet with the specified outer VLAN ID based on the selective QinQ policy. Upon receiving a reply packet containing the same outer VLAN tag, the Tunnel port fails to find the MAC address in the outer VLAN as it is in the native VLAN, causing a flood.

Figure 13-9

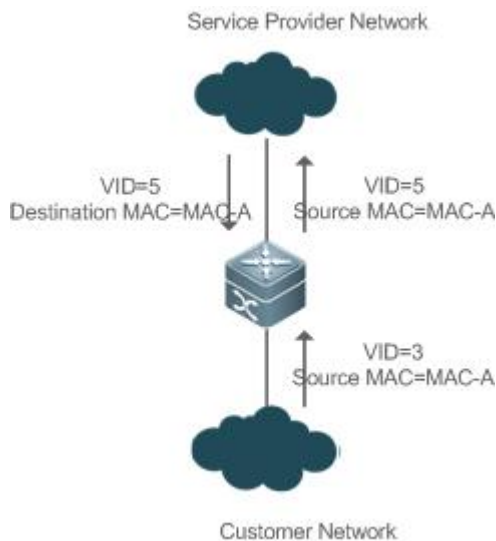

As in Figure 13-9, the customer network is connected to the Tunnel port of the switch. Configured with native VLAN 4, the Tunnel port tags the packet whose source MAC address is A with outer VLAN 5. Upon receiving a packet with inner tag VLAN 3 and source MAC address A, the switch tags the packet with outer VLAN 5. Because the port is configured with native VLAN 4, MAC address A is learned by VLAN 4. Upon receiving the reply packet, the switch looks for MAC address A on VLAN 5 because the outer tag of the packet contains VLAN ID 5. However, MAC address A is not learned by VLAN 5, causing floods.

You can configure the Tunnel port to replicate the MAC address of the native VLAN to the outer VLAN to avoid continuous flooding of the packets from the SP network. You can also configure the Tunnel port to replicate the MAC address of the outer VLAN for the outer tag to the native VLAN to avoid continuous flooding of the packets from the customer network.

36.3.6 Layer-2 Transparent Transmission

Working Principle

The Layer-2 transparent transmission feature is designed to realize the transmission of Layer-2 packets between customer networks without impact on SP networks. When a Layer-2 packet from a customer network enters a PE, the PE changes the destination MAC address of the packet to a private address before forwarding the packet. The peer PE changes the destination MAC address to a public address to send the packet to the customer network at the other end, realizing transparent transmission on the SP network.

36.3.7 Priority Replication

Working Principle

If the SP network provides a QoS policy corresponding to a specified User Priority (CoS) in the inner tag, you can replicate the CoS of the inner tag to the outer tag to enable transparent transmission based on the QoS policy provided by the SP network.

36.3.8 Priority Mapping

Working Principle

If the SP network provides various QoS policies corresponding to specified CoS values for different service flows, you can map the CoS value of the inner tag to the CoS value of the outer tag to ensure preferential transmission of service flows based on the QoS policies provided by the SP network.

36.4 Limitations



- The S6500 series products support four global Tag Protocol Identifier (TPID) values. One of the TPID values must be 0x8100, and the other three are random.

36.5 Configuration

Configuration	Description and Command	
Configuring QinQ	Mandatory.	
	switchport mode dot1q-tunnel switchport dot1q-tunnel allowed vlan { [add] tagged vlist [add] untagged vlist remove vlist }	Configures a Tunnel port. Adds the VLANs to the Tunnel port in tagged or untagged mode.
	switchport dot1q-tunnel native vlan VID	Configures the default VLAN for the Tunnel port.
Configuring C-TAG-Based	(Mandatory) It is used to configure C-TAG-based selective QinQ based on basic QinQ. Selective	

Configuration	Description and Command	
Selective QinQ	QinQ prevails over basic QinQ.	
	dot1q outer-vid <i>VID</i> register inner-vid <i>v_list</i>	Configures the policy to add the VLAN IDs of outer tags based on inner tags.
Configuring ACL-Based Selective QinQ	(Mandatory) It is used to configure ACL-based selective QinQ based on basic QinQ. Selective QinQ prevails over basic QinQ.	
	traffic-redirect access-group <i>acl</i> nested-vlan <i>VID</i> in	Configures the policy to add the VLAN IDs of outer tags based on ACLs.
Configuring VLAN Mapping	(Mandatory) It is used to enable VLAN mapping.	
	vlan-mapping-in <i>vlan cvlan</i> remark <i>svlan</i>	Configures 1:1 VLAN mapping in the inbound direction. This feature changes the inner VLAN ID of the packet entering a port to a specified outer VLAN ID.
	vlan-mapping-out <i>vlan svlan</i> remark <i>cvlan</i>	Configures 1:1 VLAN mapping in the outbound direction. This feature changes the outer VLAN ID of the packet exiting a port to a specified inner VLAN ID.
	vlan-mapping-in <i>vlan cvlan-list</i> remark <i>svlan</i>	Configures N:1 VLAN mapping in the inbound direction. This feature changes the inner VLAN ID of the packet entering a port to a specified outer VLAN ID.
Configuring TPIDs	(Optional) It is used to realize TPID compatibility.	
	frame-tag <i>tpid tpid</i>	Configures the TPID of a frame tag. If you want to set it to 0x9100, configure the frame-tag tpid 9100 command. By default, the TPID is in hexadecimal format. You need to configure this feature on an egress port.
Configuring MAC Address Replication	(Optional) It is used to configure MAC address replication to prevent floods.	
	mac-address-mapping <i>x</i> source-vlan <i>src-vlan-list</i> destination-vlan <i>dst-vlan-id</i>	Replicates the dynamic MAC address of the source VLAN to the destination VLAN.
Configuring an Inner/Outer VLAN Tag Modification Policy	(Optional) It is used to adjust the outer and inner VLAN tags of the packets transmitted over SP networks based on network topologies.	
	dot1q relay-vid <i>VID</i> translate local-vid <i>v_list</i>	Configures the policy to change the VLAN IDs of outer tags based on the outer tags.
	dot1q relay-vid <i>VID</i> translate inner-vid <i>v_list</i>	Configures the policy to change the VLAN IDs of outer tags based on inner tags.
	dot1q new-outer-vlan <i>VID</i> translate old-outer-vlan <i>vid</i> inner-vlan <i>v_list</i>	Configures the policy to change the VLAN IDs of outer tags based on outer and inner tags.
	traffic-redirect access-group <i>acl</i> outer-vlan <i>VID</i> in	Configures the policy to change the VLAN IDs of outer tags based on an ACL.
	traffic-redirect access-group <i>acl</i> inner-vlan <i>VID</i> out	Configures the policy to change the VLAN IDs of inner tags based on an ACL.
Configuring Priority Mapping and Priority Replication	(Optional) It is used to apply the QoS policy provided by the SP network by priority replication.	
	inner-priority-trust enable	Replicates the value of the User Priority field in

Configuration	Description and Command	
		the inner tag (C-TAG) to the User Priority field of the outer tag (S-TAG).
	(Optional) It is used to apply the QoS policy provided by the SP network by priority mapping.	
	dot1q-tunnel cos <i>inner-cos-value</i> remark-cos <i>outer-cos-value</i>	Sets the value of the User Priority field in the outer tag (S-TAG) based on the User Priority field of the inner tag (C-TAG).
Configuring Layer-2 Transparent Transmission	(Optional) It is used to transmit MSTP and GVRP packets transparently based on the customer network topology without affecting the SP network topology.	
	I2protocol-tunnel stp	Enables STP transparent transmission in global configuration mode.
	I2protocol-tunnel stp enable	Enables STP transparent transmission in interface configuration mode.
	I2protocol-tunnel gvrp	Enables GVRP transparent transmission in global configuration mode.
	I2protocol-tunnel gvrp enable	Enables GVRP transparent transmission in interface configuration mode.
	I2protocol-tunnel{STP GVRP}tunnel-dmac <i>mac-address</i>	Configures a transparent transmission address.

- Pay attention to the following limitations when you configure QinQ:
- Do not configure a routed port as the Tunnel port.
- Do not enable 802.1X on the Tunnel port.
- Do not enable the port security function on the Tunnel port.
- When the Tunnel port is configured as the source port of the remote switched port analyzer (RSPAN), the packets whose outer tags contain VLAN IDs consistent with the RSPAN VLAN IDs are monitored.
- If you want to match the ACL applied to the Tunnel port with the VLAN IDs of inner tags, use the **inner** keyword.
- Configure the egress port of the customer network connected to the SP network as an Uplink port. If you configure the TPID of the outer tag on a QinQ-enabled port, set the TPID of the outer tag on the Uplink port to the same value.
- By default, the maximum transmission unit (MTU) on a port is 1,500 bytes. After added with an outer VLAN tag, a packet is four bytes longer. It is recommended to increase the port MTU on the SP networks to at least 1,504 bytes.
- After a switch port is enabled with QinQ, you must enable SVGL sharing before enabling IGMP snooping. Otherwise, IGMP snooping will not work on the QinQ-enabled port.
- If a packet matches two or more ACL-based selective QinQ policies without priority, only one policy is executed. It is recommended to specify the priority.

36.5.1 Configuring QinQ

Configuration Effect

- Implement Layer-2 VPN based on a port-based QinQ policy.

Notes

- It is not recommended to configure the native VLAN of the Trunk port on the PE as its default VLAN, because the Trunk port strips off the tags containing the native VLAN IDs when sending packets.

Configuration Steps

➤ **Configuring the Tunnel port**

- (Mandatory) Configure the Tunnel port in interface configuration mode.
- Run the **switchport mode dot1q-tunnel** command in interface configuration mode to configure the Tunnel port.

Command	switchport mode dot1q-tunnel
Parameter	N/A
Description	
Defaults	By default, no Tunnel port is configured.
Command Mode	Interface configuration mode
Usage Guide	N/A

➤ **Configuring the Native VLAN**

- Mandatory.
- Configure the native VLAN for the Tunnel port.
- After you configure the native VLAN, add it to the VLAN list of the Tunnel port in untagged mode.
- Run the **switchport dot1q-tunnel native vlan VID** command in interface configuration mode to configure the default VLAN for the Tunnel port.
- If the native VLAN is added to the VLAN list in untagged mode, the outgoing packets on the Tunnel port are not tagged. If the native VLAN is added to the VLAN list in tagged mode, the outgoing packets on the Tunnel port are tagged with the native VLAN ID. To ensure the uplink and downlink transmission, add the native VLAN to the VLAN list in untagged mode.

Command	switchport dot1q-tunnel native vlan VID
Parameter Description	<i>VID</i> : Indicates the ID of the native VLAN. The value ranges from 1 to 4,094. The default value is 1.
Defaults	By default, the native VLAN is VLAN 1.
Command Mode	Interface configuration mode
Usage Guide	Use this command to configure the VLAN of the SP network.

➤ **Adding the VLANs on the Tunnel port**

- Mandatory.
- After you configure the native VLAN, add it to the VLAN list of the Tunnel port in untagged mode.
- If port-based QinQ is enabled, you do not need to add the VLANs of the customer network to the VLAN list of the Tunnel port.
- If selective QinQ is enabled, add the VLANs of the customer network to the VLAN list of the Tunnel port in tagged or untagged mode based on requirements.
- Run the **switchport dot1q-tunnel allowed vlan { [add] tagged vlist | [add] untagged vlist | remove vlist }** command in interface configuration mode to add VLANs to the VLAN list of the Tunnel port. Upon receiving packets from corresponding VLANs, the Tunnel port adds or removes tags based on the settings.

Command	switchport dot1q-tunnel allowed vlan { [add] tagged vlist [add] untagged vlist remove vlist }
Parameter Description	<i>v_list</i> : Indicates the list of the VLANs on the Tunnel port.

Defaults	By default, VLAN 1 is added to the VLAN list of the Tunnel port in untagged mode. Other VLANs are not added.
Command	Interface configuration mode
Mode	
Usage Guide	Use this command to add or remove VLANs on the Tunnel port and specify whether the outgoing packets are tagged or untagged. If basic QinQ is enabled, add the native VLAN to the VLAN list of the Tunnel port in untagged mode.

Verification

Check the Tunnel port configuration.

- Check whether the Tunnel port is configured properly on a switch.

Configuration Example

📌 **Configuring Basic QinQ to Implement Layer-2 VPN**

<p>Scenario Figure 13-10</p>	
<p>Configuration Steps</p>	<ul style="list-style-type: none"> ● Configure Tunnel ports on the PEs and connect the CEs to the Tunnel ports. ● Configure the native VLANs for the Tunnel ports and add the native VLANs to the VLAN lists of the Tunnel ports respectively in untagged mode. ● Configure VLANs on the customer networks based on requirements. <p>3 QinQ-enabled switches encapsulate outer tags in packets for transmission over the SP network. Therefore, you do not need to configure customer VLANs on the PEs.</p> <p>4 The TPID is 0x8100 by default according to IEEE802.1Q. On some third-party switches, the TPID is set to a different value. If such switches are deployed, set the TPIDs on the ports connected to the third-party switches to realize TPID compatibility.</p> <p>⚠️ If the PEs are connected through Trunk ports or Hybrid ports, do not configure the native VLANs for the Trunk ports or Hybrid ports as the default VLANs for the Tunnel ports. The Trunk ports or Hybrid ports strip off the VLAN tags containing the Native VLAN IDs when sending packets.</p>
<p>Provider A</p>	<p>Step 1: Create VLAN 10 and VLAN 20 on the SP network to segregate the data of Customer A and Customer B.</p> <pre> ProviderA#configure terminal Enter configuration commands, one per line. End with CNTL/Z. ProviderA(config)#vlan 10 ProviderA(config-vlan)#exit </pre>

	<pre> ProviderA(config)#vlan 20 ProviderA(config-vlan)#exit </pre> <p>Step 2: Enable basic QinQ on the port connected to the network of Customer A to use VLAN 10 for tunneling.</p> <pre> ProviderA(config)#interface gigabitEthernet 0/1 ProviderA(config-if-GigabitEthernet 0/1)#switchport mode dot1q-tunnel ProviderA(config-if-GigabitEthernet 0/1)#switchport dot1q-tunnel native vlan 10 ProviderA(config-if-GigabitEthernet 0/1)#switchport dot1q-tunnel allowed vlan add untagged 10 </pre> <p>Step 3: Enable basic QinQ on the port connected to the network of Customer B to use VLAN 20 for tunneling.</p> <pre> ProviderA(config)#interface gigabitEthernet 0/2 ProviderA(config-if-GigabitEthernet 0/2)#switchport mode dot1q-tunnel ProviderA(config-if-GigabitEthernet 0/2)#switchport dot1q-tunnel native vlan 20 ProviderA(config-if-GigabitEthernet 0/2)#switchport dot1q-tunnel allowed vlan add untagged 20 </pre> <p>Step 4: Configure an Uplink port.</p> <pre> ProviderA(config)# interface gigabitEthernet 0/5 ProviderA(config-if-GigabitEthernet 0/5)#switchport mode uplink </pre> <p>Step 5: Change the TPID of the outgoing packets on the Uplink port to a value (for example, 0x9100) recognizable by third-party switches.</p> <pre> ProviderA(config-if-GigabitEthernet 0/5)#frame-tag tpid 9100 </pre> <p>Step 6: Configure Provider B by performing the same steps.</p>
<p>Verification</p>	<p>Customer A1 sends a packet containing VLAN ID 100 destined to Customer A2. The packet through Provider A is tagged with the outer tag specified by the Tunnel port. The packet that reaches Customer A2 carries the original VLAN ID 100. Check whether the Tunnel port is configured correctly. Check whether the TPID is configured correctly.</p>
<p>Provider A</p>	<pre> ProviderA#show running-config interface GigabitEthernet 0/1 switchport mode dot1q-tunnel switchport dot1q-tunnel allowed vlan add untagged 10 switchport dot1q-tunnel native vlan 10 spanning-tree bpdufilter enable ! interface GigabitEthernet 0/2 switchport mode dot1q-tunnel switchport dot1q-tunnel allowed vlan add untagged 20 switchport dot1q-tunnel native vlan 20 spanning-tree bpdufilter enable </pre>

	<pre> ! interface GigabitEthernet 0/5 switchport mode uplink frame-tag tpid 0x9100 ProviderA#show interfaces dot1q-tunnel =====Interface Gi0/1===== Native vlan: 10 Allowed vlan list:1,10, Tagged vlan list: =====Interface Gi0/2===== Native vlan: 20 Allowed vlan list:1,20, Tagged vlan list: ProviderA#show frame-tag tpid Ports Tpid ----- Gi0/5 0x9100 </pre>
Provider B	Check Provider B by performing the same steps.

Common Errors

- The native VLAN is not added to the VLAN list of the Tunnel port in untagged mode.
- No TPID is configured on the port connected to the third-party switch on which TPID is not 0x8100. As a result, packets cannot be recognized by the third-party switch.

36.5.2Configuring C-TAG-Based Selective QinQ

Configuration Effect

- Encapsulate outer VLAN tags (S-TAGs) in packets based on inner tags to ensure preferential transmission and management of Layer-2 VPN and service flows.

Notes

- C-TAG-based selective QinQ must be configured based on basic QinQ.
- Some selective QinQ policies are not supported on some products due to limitations of chips.
- If you need to continue to adopt the VLAN tag priority specified by the customer network, you can configure priority replication to configure an outer tag the same as the inner tag.
- If the SP network requires the transmission of packets based on the priority of the outer tag, you need to configure priority replication to set the CoS of the outer tag to the specified value.

Configuration Steps

➤ **Configuring a Policy to Add the VLAN IDs of Outer Tags Based on Inner Tags**

- Mandatory.
 - Upon receiving a packet, the Tunnel port adds the VLAN ID of the outer tag based on the VLAN ID of the inner tag. This function enables the Tunnel port to add the VLAN ID of the inner tag to the outer tag and adds the port to the VLAN in untagged mode. In this way, the outgoing packets carry the original inner tags.
- 5 The ACL-based QinQ policy prevails over the port-based and C-TAG-based QinQ policy.
 - 6 When a member port is added to or removed from an aggregate port (AP), the QinQ policy configured on the AP port will be deleted. You need to configure the policy again. It is recommended that you configure a selective QinQ policy on the AP port after you configure its member ports.

You must configure the Tunnel port and the port connected to the public network to permit packets with specified VLAN IDs (including the native VLAN ID) in the outer tag to pass through.

Command	<code>dot1q outer-vid VID register inner-vid v_list</code>
Parameter	N/A
Description	
Defaults	By default, no policy is configured.
Command Mode	Interface configuration mode
Usage Guide	N/A

Verification

- Check whether the users within the VLANs can communicate with each other.
- Check whether Layer-2 VPN is implemented.
- Check whether different service traffic is transmitted based on the selective QinQ policy, such as outer tag insertion, priority replication, and priority mapping.

Configuration Example

➤ **Implementing Layer-2 VPN and Service Flow Management Through C-TAG-Based Selective QinQ**

<p>Scenario Figure 13-11</p>	
<p>Configuration Steps</p>	<ul style="list-style-type: none"> ● Configure the ports on PE 1 and PE 2 connected to CE 1 and CE 2 as Tunnel ports. ● Configure a selective QinQ policy to add an outer tag to the packet based on its inner tag.

	<ul style="list-style-type: none"> ● If the SP network provides a VLAN-based QoS policy, the policy enables the port to add the outer tags with the corresponding VLAN ID to the specified service flow packets. ● If the SP network provides a CoS-based QoS policy and the CoS value is the same as that of the inner tag, you can configure priority mapping to replicate the CoS value of the inner tag to the outer VLAN tag so that the packet is transmitted based on the priority policy for the inner tag. ● If the SP network provides a CoS-based QoS policy, you can configure priority mapping to set the CoS value of the outer VLAN tag to a specified value so that the packet is transmitted based on the priority policy.
<p>PE1</p>	<p>Step 1: Configure the VLAN for transparent transmission.</p> <pre>PE1#configure terminal Enter configuration commands, one per line. End with CNTL/Z. PE1(config)#vlan 100 PE1(config-vlan)#exit PE1(config)#vlan 200 PE1(config-vlan)#exit</pre> <p>Step 2: On the Downlink port of the access switch, configure a selective QinQ policy to add outer tags based on inner tags.</p> <p>Configure port Gi 0/1 as a Tunnel port.</p> <pre>PE1(config)#interface gigabitEthernet 0/1 PE1(config-if)# switchport mode dot1q-tunnel</pre> <p>Add VLAN 101 and VLAN 201 of the SP to the VLAN list of the Tunnel port and configure the Tunnel port to strip off the outer tag from incoming packets.</p> <pre>PE1(config-if)# switchport dot1q-tunnel allowed vlan add untagged 100,200</pre> <p>Configure the Tunnel port to add outer tag VLAN 100 to incoming data frames containing inner tag VLAN 1-100.</p> <pre>PE1(config-if)# dot1q outer-vid 100 register inner-vid 1-100</pre> <p>Configure the Tunnel port to add outer tag VLAN 200 to incoming data frames containing inner tag VLAN 101-200.</p> <pre>PE1(config-if)# dot1q outer-vid 200 register inner-vid 101-200</pre> <p>Step 3: Configure the port that accesses the SP network as an Uplink port.</p> <pre>PE1(config)# interface gigabitEthernet 0/2 PE1(config-if-GigabitEthernet 0/2)#switchport mode uplink</pre>
<p>PE2</p>	<ul style="list-style-type: none"> ● Perform the same configuration on PE 2.
<p>Verification</p>	<p>Verify the configuration by checking whether:</p> <ul style="list-style-type: none"> ● The Downlink port is configured as a Tunnel port. ● The VLAN specified by the outer tag is added to the VLAN list of the Tunnel port. ● The selective QinQ policy on the Tunnel port is correct. ● The Uplink port is configured correctly. <p>Step 1: Check whether the VLAN mapping policy is correct.</p>
<p>PE1</p>	<pre>PE1#show running-config interface gigabitEthernet 0/1</pre>

```
interface GigabitEthernet 0/1
    switchport mode dot1q-tunnel
    switchport dot1q-tunnel allowed vlan add untagged 100,200
    dot1q outer-vid 100 register inner-vid 1-200
    dot1q outer-vid 200 register inner-vid 101-200
    spanning-tree bpdufilter enable
!
```

Step 2: Check the C-TAG-based selective QinQ policy. Check whether the mapping relationship between the inner and outer VLAN tags is correct.

```
PE1#show registration-table
```

Ports	Type	Outer-VID	Inner-VID-list
Gi0/1	Add-outer	100	1-200
Gi0/1	Add-outer	200	101-200

36.5.3 Configuring ACL-Based Selective QinQ

Configuration Effect

- Encapsulate outer VLAN tags (S-TAGs) in packets based on the ACL-based flow classification to allow the SP network to manage different services.

Notes

- ACL-based selective QinQ must be configured based on basic QinQ.
 - Some selective QinQ policies are not supported on some products due to limitations of chips.
 - If you need to continue to adopt the VLAN tag priority specified by the customer network, you can configure priority replication to configure an outer tag the same as the inner tag.
 - If the SP network requires the transmission of packets based on the priority of the outer tag, you need to configure priority replication to set the CoS of the outer tag to the specified value.
- 7 The ACL-based QinQ policy prevails over the port-based and C-TAG-based QinQ policy.
 - 8 When an ACL is deleted, the related policy will be automatically deleted.
 - 9 Upon receiving a packet with two or more tags, the Tunnel port cannot add an outer tag to the packet based on the ACL-based selective QinQ policy.
 - 10 If a packet matches two or more ACL-based selective QinQ policies without priority, only one policy is executed. It is recommended to specify the priority.

You must configure the Tunnel port and the port connected to the public network to permit packets with specified VLAN IDs (including the native VLAN ID) in the outer tag to pass through.

Configuration Steps

➤ **Configuring a Policy to Add the VLAN IDs of Outer Tags Based on ACLs**

- Mandatory.
- The Tunnel port adds outer tags with different VLAN IDs to incoming packets based on the packet content.

Command	traffic-redirect access-group <i>acl</i> nested-vlan <i>VID</i> in
Parameter	N/A
Description	
Defaults	By default, no policy is added.
Command Mode	Interface configuration mode
Usage Guide	N/A

Verification

- Check whether the users of the same service in different branch offices can communicate with each other and whether specified service data is transmitted preferentially through virtual private LAN segment (VPLS) configuration.
- Check whether Layer-2 VPN is implemented.
- Check whether different service traffic is transmitted based on the selective QinQ policy, such as outer tag insertion, priority replication, and priority mapping.

Configuration Example

➤ **Implementing Layer-2 VPN and Service Flow Management Through ACL-Based Selective QinQ**

<p>Scenario Figure 13-12</p>	
<p>Configuration Steps</p>	<ul style="list-style-type: none"> ● Configure the ports on PE 1 and PE 2 connected to CE 1 and CE 2 as Tunnel ports. ● Configure ACL policies on PE 1 and PE 2 to segregate the service flows from the customer network. ● On the Tunnel ports, configure a selective QinQ policy to add an outer tag to the packet based on ACL policies. ● If the SP network provides a VLAN-based QoS policy, the policy enables the port to add the corresponding VLAN ID to the outer tags of the specified service flow. ● If the SP network provides a CoS-based QoS policy, you can configure priority mapping to set the CoS value of the outer VLAN tag to a specified value so that the packet is transmitted based on the priority policy.
<p>PE 1</p>	<p>Step 1: Create an ACL to permit flows of PPPoE type (0x8863/0x8864) and IPoE type (0x0800) to pass through.</p> <pre>PE1#configure terminal</pre> <p>Enter configuration commands, one per line. End with CNTL/Z.</p>

	<pre> PE1(config)# expert access-list extended acl1 PE1(config-exp-nacl)# permit 0x8863 any any PE1(config-exp-nacl)# permit 0x8864 any any PE1(config-exp-nacl)#exit PE1(config)# expert access-list extended acl2 PE1(config-exp-nacl)#permit 0x0800 any any </pre> <p>Step 2: Configure VLAN 100 and VLAN 200 on the SP network to segregate data.</p> <pre> PE#configure terminal Enter configuration commands, one per line. End with CNTL/Z. PE1(config)#vlan 100 PE1(config-vlan)#exit PE1(config)#vlan 200 PE1(config-vlan)#exit </pre> <p>Step 3: On the Downlink port of the access switch, configure a selective QinQ policy to add outer VLAN tags based on ACLs.</p> <p>Configure port Gi 0/1 as a Tunnel port.</p> <pre> PE1(config)#interface gigabitEthernet 0/1 PE1(config-if)# switchport mode dot1q-tunnel </pre> <p>Add VLAN 100 and VLAN 200 of the SP to the VLAN list of the Tunnel port and configure the Tunnel port to strip off the outer tag from incoming packets.</p> <pre> PE1(config-if)#switchport dot1q-tunnel allowed vlan add untagged 100,200 </pre> <p>Configure the Tunnel port to add outer tag VLAN 100 to the incoming data frames which match ACL 1.</p> <pre> PE1(config-if)# traffic-redirect access-group acl1 nested-vlan 100 in </pre> <p>Configure the Tunnel port to add outer tag VLAN 200 to the incoming data frames which match ACL 2.</p> <pre> PE1(config-if)# traffic-redirect access-group acl1 nested-vlan 200 in </pre> <p>Step 4: Configure the port connected to the SP network as an Uplink port.</p> <pre> PE1(config)# interface gigabitEthernet 0/2 PE1(config-if-GigabitEthernet 0/2)#switchport mode uplink </pre>
<p>Verification</p>	<p>Check whether the users of the same service in different branch offices can communicate with each other and whether specified service data is transmitted preferentially.</p> <ul style="list-style-type: none"> ● Check whether Layer-2 VPN is implemented. ● Check whether the ACL is correct. ● Check whether the service priority is correct. ● Check whether the Downlink port is configured as a Tunnel port, whether the outer tag VLAN is added to the VLAN list of the Tunnel port, and whether the mapping policy on the Tunnel port is correct.

PE1

Step 1: Check whether the Tunnel port is configured correctly.

```
FS#show running-config interface gigabitEthernet 0/1

interface GigabitEthernet 0/1
  switchport mode dot1q-tunnel
  switchport dot1q-tunnel allowed vlan add untagged 100,200
  traffic-redirect access-group acl1 nested-vlan 100 in
  traffic-redirect access-group acl2 nested-vlan 200 in
  spanning-tree bpdufilter enable
!
```

Step 2: Check the ACL-based selective QinQ policy. Check whether the mapping relationship between the inner and outer VLAN tags is correct.

```
PE1#show traffic-redirect
```

Ports	Type	VID	Match-filter
Gi0/1	Nested-vid	101	acl1
Gi0/1	Nested-vid	201	acl2

Common Errors

- No ACL policy is configured.
- ACL policies are used to segregate flows based on MAC addresses. Packet floods will occur if MAC address replication is not configured.

36.5.4Configuring VLAN Mapping

Configuration Effect

- Replace the inner tags of the packets with the outer tags to allow the packets to be transmitted based on the VLAN planning on the SP network.

Notes

- VLAN mapping can be configured only on Access ports, Trunk ports, Hybrid ports, or Uplink ports.
- ⚠ After VLAN mapping is configured, the VLAN IDs of the packets sent to the CPU are changed to the specified VLAN ID.
- ⚠ It is not recommended to configure VLAN mapping and selective QinQ on one port.

Configuration Steps

➤ **Configuring 1:1 VLAN Mapping**

- Mandatory if the 1:1 mode is used. Configure a 1:1 VLAN mapping rule.
- Run the **vlan-mapping-in vlan CVID remark SVID** command or the **vlan-mapping-out vlan SVID remark CVID** command on a Trunk port or an Uplink port to enable 1:1 VLAN mapping.

Command	vlan-mapping-in vlan <i>src-vlan-list</i> remark <i>dest-vlan</i>
Parameter	<i>src-vlan-list</i> : Indicates the customer VLAN.
Description	<i>dest-vlan</i> : Indicates the service VLAN, which is the VLAN where the SP network is located.
Defaults	
Command Mode	Interface configuration mode
Usage Guide	Use this command to configure 1:1 VLAN mapping in the inbound direction.

Command	vlan-mapping-out vlan <i>src-vlan</i> remark <i>dest-vlan</i>
Parameter	<i>src-vlan</i> : Indicates the service VLAN, which is the VLAN where the SP network is located.
Description	<i>dest-vlan</i> : Indicates the customer VLAN.
Defaults	
Command Mode	Interface configuration mode
Usage Guide	Use this command to configure 1:1 VLAN mapping in the outbound direction.

Verification

Check whether VLAN mapping is configured correctly.

- Run the **show interfaces**[*intf-id*] **vlan-mapping** command to display the VLAN mapping.

Configuration Example

📌 **Implementing VLAN Aggregation for Different Services Through VLAN Mapping**

<p>Scenario Figure 13-13</p>	
<p>Configuration Steps</p>	<ul style="list-style-type: none"> ● Configure Home Gateway 1 and Home Gateway 2. <p>Step 1: On the home gateways, configure the original VLANs for different services.</p> <pre>FS#configure terminal</pre> <p>Enter configuration commands, one per line. End with CNTL/Z.</p>

```
FS(config)#vlan range 10-12
```

```
FS(config-vlan-range)#exit
```

Step 2: Configure the attributes of the ports connected to PC, IPTV, and VoIP. Assume that the connected ports are Gi 0/2, Gi 0/3, and Gi 0/4 respectively.

```
FS(config)#interface gigabitEthernet 0/2
```

```
FS(config-if-GigabitEthernet 0/2)#switchport access vlan 10
```

```
FS(config-if-GigabitEthernet 0/2)#exit
```

```
FS(config)#interface gigabitEthernet 0/3
```

```
FS(config-if-GigabitEthernet 0/3)#switchport access vlan 11
```

```
FS(config-if-GigabitEthernet 0/3)#exit
```

```
FS(config)#interface gigabitEthernet 0/4
```

```
FS(config-if-GigabitEthernet 0/4)#switchport access vlan 12
```

```
FS(config-if-GigabitEthernet 0/4)#exit
```

Step 3: Configure an Uplink port.

```
FS(config)# interface gigabitEthernet 0/1
```

```
FS(config-if-GigabitEthernet 0/1)#switchport mode uplink
```

- Configure a floor switch with 1:1 VLAN mapping policies.

Step 1: On the home gateways, configure the original VLANs and mapped VLANs for different services.

```
FS#configure terminal
```

Enter configuration commands, one per line. End with CNTL/Z.

```
FS(config)#vlan range 10-12
```

```
FS(config-vlan-range)#exit
```

```
FS(config)#vlan range 100-102
```

```
FS(config-vlan-range)#exit
```

```
FS(config)#vlan range 200-202
```

```
FS(config-vlan-range)#exit
```

Step 2: On the Downlink port of Home Gateway 1, configure 1:1 VLAN mapping policies in the inbound and outbound directions.

```
FS(config)#interface gigabitEthernet 0/2
```

```
FS(config-if-GigabitEthernet 0/2)#switchport mode uplink
```

```
FS(config-if-GigabitEthernet 0/2)#vlan-mapping-in vlan 10 remark 100
```

```
FS(config-if-GigabitEthernet 0/2)#vlan-mapping-in vlan 11 remark 101
```

```
FS(config-if-GigabitEthernet 0/2)#vlan-mapping-in vlan 12 remark 102
```

```
FS(config-if-GigabitEthernet 0/2)#vlan-mapping-out vlan 100 remark 10
```

```
FS(config-if-GigabitEthernet 0/2)#vlan-mapping-out vlan 101 remark 11
```

	<pre> FS(config-if-GigabitEthernet 0/2)#vlan-mapping-out vlan 102 remark 12 Step 3: On the Downlink port of Home Gateway 2, configure 1:1 VLAN mapping policies in the inbound and outbound directions. FS(config)#interface gigabitEthernet 0/3 FS(config-if-GigabitEthernet 0/3)#switchport mode uplink FS(config-if-GigabitEthernet 0/3)#vlan-mapping-in vlan 10 remark 200 FS(config-if-GigabitEthernet 0/3)#vlan-mapping-in vlan 11 remark 201 FS(config-if-GigabitEthernet 0/3)#vlan-mapping-in vlan 12 remark 202 FS(config-if-GigabitEthernet 0/3)#vlan-mapping-out vlan 200 remark 10 FS(config-if-GigabitEthernet 0/3)#vlan-mapping-out vlan 201 remark 11 FS(config-if-GigabitEthernet 0/3)#vlan-mapping-out vlan 202 remark 12 Step 4: Configure an Uplink port. FS(config)# interface gigabitEthernet 0/1 FS(config-if-GigabitEthernet 0/1)#switchport mode uplink </pre>
<p>Verification</p>	<p>Display the 1:1 VLAN mapping policies configured on the floor switch.</p> <pre> FS#show interfaces vlan-mapping Ports type Status Service-Vlan Customer-Vlan-list ----- Gi0/2 in active 100 10 Gi0/2 in active 101 11 Gi0/2 in active 102 12 Gi0/2 out active 100 10 Gi0/2 out active 101 11 Gi0/2 out active 102 12 Gi0/3 in active 200 10 Gi0/3 in active 201 11 Gi0/3 in active 202 12 Gi0/3 out active 200 10 Gi0/3 out active 201 11 Gi0/3 out active 202 12 </pre>

36.5.5 Configuring TPIDs

Configuration Effect

Configure the TPIDs in the tags on SP network devices to realize TPID compatibility.

Notes

If a PE connected to a third-party switch on which the TPID is not 0x8100, you need to configure the TPID on the port of the PE connected to the third-party switch.

Do not set the TPIDs to any of the following values: 0x0806 (ARP), 0x0200 (PUP), 0x8035 (RARP), 0x0800 (IP), 0x86DD (IPv6), 0x8863/0x8864 (PPPoE), 0x8847/0x8848 (MPLS), 0x8137 (IPX/SPX), 0x8000 (IS-IS), 0x8809 (LACP), 0x888E (802.1X), 0x88A7 (clusters), and 0x0789 (reserved by FS Networks).

Configuration Steps

- If a PE connected to a third-party switch on which the TPID is not 0x8100, you need to configure the TPID on the port of the PE connected to the third-party switch.
- TPIDs can be configured in interface configuration mode and global configuration mode. The following example adopts interface configuration mode.

Configure the **frame-tag tpid 0x9100** command in interface configuration mode to change the TPID to 0x9100. For details about the TPID value, see section 1.4.5.

Command	frame-tag tpid tpid
Parameter	<i>tpid</i> : Indicates the new value of the TPID.
Description	
Defaults	The default value of the TPID is 0x8100.
Command Mode	Interface configuration mode
Usage Guide	If a PE is connected to a third-party switch on which the TPID is not 0x8100, use this command to configure the TPID on the port connected to the third-party switch.

Verification

Check whether the TPID is configured.

Configuration Example

Configuring the TPID on a port

Configuration Steps	<p>Configure the TPID on a port.</p> <pre>FS(config)# interface gigabitethernet 0/1 FS(config-if)# frame-tag tpid 9100</pre>
Verification	<p>Display the TPID on the port.</p> <pre>FS# show frame-tag tpid interfaces gigabitethernet 0/1 Port tpid ----- Gi0/1 0x9100</pre>









36.5.6Configuring MAC Address Replication

Configuration Effect

- Replicate the dynamic address learned on a port from one VLAN to another.
- Avoid packet floods when service flows are segregated through MAC-based ACLs.

Notes

11 After MAC address replication is disabled, the system will delete all the learned MAC address entries from the destination VLAN.

-  MAC address replication can be configured on a port only once. If you need to modify the configuration, delete the current configuration and configure it again.
-  VLAN MAC address replication cannot be used together with VLAN sharing, and the MAC addresses cannot be replicated to dynamic VLANs.
-  Up to eight destination VLANs can be configured on each port. MAC address replication takes effect even if the port does not belong to the specified destination VLAN.
-  MAC address replication cannot be configured on the Host and Promiscuous ports, monitoring ports, and port security-/802.1X-enabled ports.
-  Only dynamic addresses can be replicated. Address replication is disabled when the address table is full. If source addresses already exist before replication is enabled, corresponding MAC addresses will not be replicated.
-  Replicated addresses have a higher priority than dynamic addresses but have a lower priority than other types of addresses.
-  When a MAC address ages, the replicated MAC address will also age. When the MAC address is deleted, the replicated address will be deleted automatically.
-  Hot backup is not supported. After primary/secondary switchover occurs, it is recommended that you disable MAC address replication and then enable it again.

12 The MAC address entries obtained through MAC address replication cannot be deleted manually. If you need to delete these entries, disable MAC address replication.

Configuration Steps

▾ Configuring MAC Address Replication

- Perform this configuration to replicate MAC addresses from one VLAN to another to avoid packet floods.
- Run the **mac-address-mapping <1-8> source-vlan src-vlan-list destination-vlan dst-vlan-id** command on a Trunk port to enable MAC address replication. *src-vlan-list* and *dst-vlan-id* specify the VLAN range.

Command	mac-address-mapping x source-vlan src-vlan-list destination-vlan dst-vlan-id
Parameter	x: Indicates the index number for MAC address replication. The value ranges from 1 to 8.
Description	<i>src-vlan-list</i> : Indicates the source VLAN list. <i>dst-vlan-id</i> : Indicates the destination VLAN list.
Defaults	By default, MAC address replication is disabled.
Command Mode	Interface configuration mode
Usage Guide	N/A

Verification

- Check whether the MAC address of the specified VLAN is replicated to another VLAN.

Configuration Example

▾ Configuring MAC Address Replication

Configuration Steps	<ul style="list-style-type: none"> ● Configure MAC address replication. <pre>FS(config)# interface gigabitethernet 0/1 FS(config-if)# switchport mode trunk FS(config-if)# mac-address-mapping 1 source-vlan 1-3 destination-vlan 5</pre>									
Verification	<ul style="list-style-type: none"> ● Check whether the configuration takes effect on the port. ● Send a packet from the source VLAN and check whether the source MAC address of the packet is replicated to the destination VLAN. <pre>FS# show interfaces mac-address-mapping</pre> <table border="1"> <thead> <tr> <th>Ports</th> <th>destination-VID</th> <th>Source-VID-list</th> </tr> </thead> <tbody> <tr> <td>-----</td> <td></td> <td></td> </tr> <tr> <td>Gi0/1</td> <td>5</td> <td>1-3</td> </tr> </tbody> </table>	Ports	destination-VID	Source-VID-list	-----			Gi0/1	5	1-3
Ports	destination-VID	Source-VID-list								

Gi0/1	5	1-3								

Common Errors

- See "Notes".

36.5.7 Configuring an Inner/Outer VLAN Tag Modification Policy

Configuration Effect

- Modify outer or inner tags based on the actual networking requirements.

Notes

- 13 The ACL-based QinQ policy prevails over the port-based and C-TAG-based QinQ policy.
- 14 When an ACL is deleted, the related policy will be automatically deleted.
- 15 Tag modification policies take effect only on Access ports, Trunk ports, Hybrid ports, and Uplink ports.
- 16 Tag modification policies are mainly used to modify inner and outer tags on the SP network.
- 17 If a packet matches two or more ACL-based selective QinQ policies without priority, only one policy is executed. It is recommended to specify the priority.

Configuration Steps

📌 **Configuring the Policy to Change the VLAN IDs of Outer Tags Based on Inner Tags**

- Optional.
- Perform this configuration to change the VLAN IDs of outer tags based on the VLAN IDs of inner tags.
- You can change the VLAN IDs of the outer tags in the packets that enter Access ports, Trunk ports, Hybrid ports, and Uplink ports based on the VLAN IDs of the inner tags in these packets.

Command	dot1q relay-vid VID translate inner-vid v_list
Parameter	VID: Indicates the modified VLAN ID of the outer tag.
Description	v_list: Indicates the VLAN ID of the inner tag.
Defaults	By default, no policy is configured.
Command	Interface configuration mode

Mode	
Usage Guide	N/A

▼ **Configuring the Policy to Change the VLAN IDs of Outer Tags Based on the VLAN IDs of Outer and Inner Tags**

- Optional.
- Perform this configuration to change the VLAN IDs of outer tags based on the VLAN IDs of inner and outer tags.
- You can change the VLAN IDs of the outer tags in the packets that enter Access ports, Trunk ports, Hybrid ports, and Uplink ports based on the VLAN IDs of the inner and outer tags in these packets.

Command	dot1q new-outer-vlan <i>new-vid</i> translate old-outer-vlan <i>vid</i> inner-vlan <i>v_list</i>
Parameter	<i>new-vid</i> : Indicates the modified VLAN ID of the outer tag.
Description	<i>vid</i> : Indicates the original VLAN ID of the outer tag. <i>v_list</i> : Indicates the VLAN ID of the inner tag.
Defaults	By default, no policy is configured.
Command	Interface configuration mode
Mode	
Usage Guide	N/A

▼ **Configuring the Policy to Change the VLAN IDs of Outer Tags Based on the Outer Tags**

- Optional.
- Perform this configuration to change the VLAN IDs of outer tags based on these VLAN IDs.
- You can change the VLAN IDs of the outer tags in the packets that enter Access ports, Trunk ports, Hybrid ports, and Uplink ports based on these VLAN IDs.

Command	dot1q relay-vid <i>VID</i> translate local-vid <i>v_list</i>
Parameter	<i>VID</i> : Indicates the modified VLAN ID of the outer tag.
Description	<i>v_list</i> : Indicates the original VLAN ID of the outer tag.
Defaults	By default, no policy is configured.
Command	Interface configuration mode
Mode	
Usage Guide	N/A

▼ **Configuring a Policy to Change the VLAN IDs of Inner Tags Based on ACLs**

- Optional.
- You can change the VLAN IDs of the inner tags in the packets that exit Access ports, Trunk ports, Hybrid ports, and Uplink ports based on the packet content.
- Before you configure such a policy, configure an ACL.

Command	traffic-redirect access-group <i>acl</i> inner-vlan <i>vid</i> out
Parameter	<i>acl</i> : Indicates the ACL.
Description	<i>vid</i> : Indicates the modified VLAN ID of the inner tag.
Defaults	By default, no policy is configured.
Command	Interface configuration mode
Mode	

Usage Guide	N/A
--------------------	-----

▾ **Configuring a Policy to Change the VLAN IDs of Outer Tags Based on ACLs**

- Optional.
- You can change the VLAN IDs of the outer tags in the packets that exit Access ports, Trunk ports, Hybrid ports, and Uplink ports based on the packet content.
- Before you configure such a policy, configure an ACL.

Command	traffic-redirect access-group <i>acl</i> outer-vlan <i>vid</i> in
Parameter	<i>acl</i> : Indicates the ACL.
Description	<i>vid</i> : Indicates the modified VLAN ID of the outer tag.
Defaults	By default, no policy is configured.
Command Mode	Interface configuration mode
Usage Guide	N/A

Verification

Check whether the configuration takes effect and whether the port modifies the tags in received packets based on the policy.

Configuration Example

▾ **Configuring the Policy to Change the VLAN IDs of Outer Tags Based on the Outer Tags**

Configuration Steps	<ul style="list-style-type: none"> ● Configure inner/outer tag modification policies on a port based on the actual networking requirements. ● The following example shows how to change VLAN IDs of outer tags based on outer tags and ACLs respectively. For details about other policies, see the description above. <p>Configure a policy to change outer VLAN tags based on the outer VLAN tags.</p> <pre>FS(config)# interface gigabitEthernet 0/1 FS(config-if)# switchport mode trunk FS(config-if)# dot1q relay-vid 100 translate local-vid 10-20</pre> <p>Configure a policy to change outer VLAN tags based on ACLs.</p> <pre>FS# configure terminal FS(config)# ip access-list standard 2 FS(config-acl-std)# permit host 1.1.1.1 FS(config-acl-std)# exit FS(config)# interface gigabitEthernet 0/2 FS(config-if)# switchport mode trunk FS(config-if)# traffic-redirect access-group 2 outer-vlan 3 in</pre>
Verification	<ul style="list-style-type: none"> ● Check whether the configuration takes effect on the port. ● Check whether the port changes the VLAN IDs of the outer tags in received packets based on the configured policy.

36.5.8 Configuring Priority Mapping and Priority Replication

Configuration Effect

- If an SP network provides a QoS policy based on the User Priority field of the inner tag, configure priority replication to apply the QoS policy to the outer tag.
- If an SP network provides a QoS policy based on the User Priority field of the inner tag, configure priority mapping to apply the User Priority field provided by the SP network to the outer tag.

Notes

- ⚠ Only a Tunnel port can be configured with priority replication, which has a higher priority than trusted QoS but lower than ACL-based QoS.
- ⚠ Priority replication and priority mapping cannot be both enabled on one port.
- ⚠ Only a Tunnel port can be configured with priority mapping, which prevails over QoS.
- ⚠ The configuration of priority mapping does not take effect if no trust mode is configured (trust none) or the trust mode is not matched with priority mapping.

Configuration Steps

- Only a Tunnel port can be configured with priority mapping or priority replication.
- Configure priority replication to apply the inner tag-based QoS policy provided by the SP network.
- Configure priority mapping to configure the User Priority field of the outer VLAN tag based on the inner tag and apply the QoS policy flexibly.
- To enable priority replication, run the **inner-priority-trust enable** command on the Tunnel port.
- To enable priority mapping, run the **dot1q-Tunnel cos inner-cos-value remark-cos outer-cos-value** command on the Tunnel port.

inner-cos-value and *outer-cos-value* range from 0 to 7.

18 The following priority mapping is used when no priority mapping is configured:

inner pri	0	1	2	3	4	5	6	7

outer pri	0	1	2	3	4	5	6	7

Command	inner-priority-trust enable
Parameter	N/A
Description	
Defaults	By default, priority replication is disabled.
Command	Interface configuration mode
Mode	
Usage Guide	N/A

Command	dot1q-Tunnel cos inner-cos-value remark-cos outer-cos-value
Parameter	<i>inner-cos-value</i> : Indicates the CoS value of the inner tag.
Description	<i>outer-cos-value</i> : Indicates the CoS value of the outer tag.

Defaults	By default, priority mapping is disabled.
Command	Interface configuration mode
Mode	
Usage Guide	N/A

Verification

- Run the **show inner-priority-trust interfaces** *type intf-id* command and the **show interfaces** *type intf-id remark* command to check whether priority mapping or priority replication takes effect.

Configuration Example

📌 **Configuring Priority Mapping and Priority Replication**

Configuration Steps	<ul style="list-style-type: none"> ● To maintain the packet priority, you need to replicate the priority of the inner tag in a packet to the outer tag on the Tunnel port. ● To flexibly control the packet priority on the Tunnel port, you can add outer tags of different priorities to packets based on the priorities of the inner tags in the packets. <p>Configure priority replication.</p> <pre>FS(config)# interface gigabitethernet 0/1 FS(config-if)# mls qos trust cos FS(config-if)# inner-priority-trust enable FS(config)# end</pre> <p>Configure priority mapping.</p> <pre>FS(config)# interface gigabitethernet 0/2 FS(config-if)# dot1q-tunnel cos 3 remark-cos 5</pre>
Verification	<ul style="list-style-type: none"> ● Display the priority configuration on the port. <p>Check whether priority replication is enabled on the Tunnel port.</p> <pre>FS# show inner-priority-trust interfaces gigabitethernet 0/1 Port inner-priority-trust ----- Gi0/1 enable</pre> <p>Display the priority mapping configured on the Tunnel port.</p> <pre>FS# show interfaces gigabitethernet 0/1 remark Ports Type From value To value ----- Gi0/1 Cos-To-Cos 3 5</pre>

Common Errors



See "Notes".

36.5.9 Configuring Layer-2 Transparent Transmission

Configuration Effect

Transmit Layer-2 packets transparently without impact on the SP network and the customer network.

Notes

-  If STP is not enabled, you need to run the **bridge-frame forwarding protocol bpdu** command to enable STP transparent transmission.
-  Transparent transmission enabled on a port takes effect only after enabled globally. When transparent transmission takes effect on the port, the port does not participate in related protocol calculation. If the port receives a packet whose destination MAC address is the special broadcast address, it determines that a networking error occurs and discards the packet.

Configuration Steps

▾ Configuring STP Transparent Transmission

- Mandatory if you need to transparently transmit BPDU packets through STP.
- Enable STP transparent transmission in global configuration mode and interface configuration mode.
- Run the **I2protocol-tunnel stp** command in global configuration mode to enable STP transparent transmission.
- Run the **I2protocol-tunnel stp enable** command in interface configuration mode to enable STP transparent transmission.

Command	I2protocol-tunnel stp
Parameter	N/A
Description	
Defaults	By default, STP transparent transmission is disabled.
Command Mode	Global configuration mode
Usage Guide	N/A

Command	I2protocol-tunnel stp enable
Parameter	N/A
Description	
Defaults	By default, STP transparent transmission is disabled.
Command Mode	Interface configuration mode
Usage Guide	N/A

▾ Configuring GVRP Transparent Transmission

- Mandatory if you need to transparently transmit GVRP packets.
- Enable GVRP transparent transmission in global configuration mode and interface configuration mode.
- Run the **I2protocol-tunnel gvrp** command in global configuration mode to enable GVRP transparent transmission.
- Run the **I2protocol-tunnel gvrp enable** command in interface configuration mode to enable GVRP transparent transmission.

Command	I2protocol-tunnel gvrp
Parameter	N/A

Description	
Defaults	By default, GVRP transparent transmission is disabled.
Command Mode	Global configuration mode
Usage Guide	N/A

Command	<code>l2protocol-tunnel gvrp enable</code>
Parameter Description	N/A
Defaults	By default, GVRP transparent transmission is disabled.
Command Mode	Interface configuration mode
Usage Guide	N/A

↘ **Configuring a Transparent Transmission Address**

- Optional.
- Configure a transparent transmission address.

Command	<code>l2protocol-tunnel { stp gvrp } tunnel-dmac mac-address</code>
Parameter Description	<i>mac-address</i> : Indicates the address used to transparently transmit packets.
Defaults	By default, the first three bytes of the transparent transmission address is 01d0f8, and the last three bytes are 000005 and 000006 for STP and GVTP respectively.
Command Mode	Interface configuration mode
Usage Guide	<p>19 The following addresses are available for STP: 01d0.f800.0005, 011a.a900.0005, 010f.e200.0003, 0100.0ccd.cdd0, 0100.0ccd.cdd1, and 0100.0ccd.cdd2. The following addresses are available for GVRP: 01d0.f800.0006 and 011a.a900.0006.</p> <p>20 When no transparent transmission address is configured, the default settings are used.</p>

Verification

Run the **show l2protocol-tunnel stp** command and the **show l2protocol-tunnel gvrp** command to check whether the transparent transmission address is configured correctly.

Configuration Example

The following example shows how to configure STP transparent transmission.

↘ **Configuring STP Transparent Transmission**

<p>Scenario Figure 13-14</p>	
<p>Configuration Steps</p>	<ul style="list-style-type: none"> ● On the PEs (Provider S1 and Provider S2), enable STP transparent transmission in global configuration mode and interface configuration mode. ● Before you enable STP transparent transmission, enable STP in global configuration mode to allow the switches to forward STP packets.
<p>Provider S1</p>	<p>Step 1: Enable STP.</p> <pre>bridge-frame forwarding protocol bpdu</pre> <p>Step 2: Configure the VLAN for transparent transmission.</p> <pre>ProviderS1#configure terminal</pre> <p>Enter configuration commands, one per line. End with CNTL/Z.</p> <pre>ProviderS1(config)#vlan 200 ProviderS1(config-vlan)#exit</pre> <p>Step 3: Enable basic QinQ on the port connected to the customer network and use VLAN 200 for tunneling.</p> <pre>ProviderS1(config)#interface gigabitEthernet 0/1 ProviderS1(config-if-GigabitEthernet 0/1)#switchport mode dot1q-tunnel ProviderS1(config-if-GigabitEthernet 0/1)#switchport dot1q-tunnel native vlan 200</pre> <p>Step 4: Enable STP transparent transmission on the port connected to the customer network.</p> <pre>ProviderS1(config-if-GigabitEthernet 0/1)#l2protocol-tunnel stp enable ProviderS1(config-if-GigabitEthernet 0/1)#exit</pre> <p>Step 5: Enable STP transparent transmission in global configuration mode.</p> <pre>ProviderS1(config)#l2protocol-tunnel stp</pre> <p>Step 4: Configure an Uplink port.</p> <pre>ProviderS1(config)# interface gigabitEthernet 0/5</pre>

	ProviderS1(config-if-GigabitEthernet 0/5)#switchport mode uplink
Provider S2	Configure Provider S2 by performing the same steps.
Verification	<p>Step 1: Check whether STP transparent transmission is enabled in global configuration mode and interface configuration mode.</p> <pre>ProviderS1#show l2protocol-tunnel stp L2protocol-tunnel: Stp Enable GigabitEthernet 0/1 l2protocol-tunnel stp enable</pre> <p>Step 2: Verify the configuration by checking whether:</p> <ul style="list-style-type: none"> ● The port type is dot1q-tunnel. ● The outer tag VLAN is consistent with the native VLAN and added to the VLAN list of the Tunnel port. ● The port that accesses the SP network is configured as an Uplink port. <pre>ProviderS1#show running-config interface GigabitEthernet 0/1 switchport mode dot1q-tunnel switchport dot1q-tunnel allowed vlan add untagged 200 switchport dot1q-tunnel native vlan 200 l2protocol-tunnel stp enable spanning-tree bpdufilter enable ! interface GigabitEthernet 0/5 switchport mode uplink</pre>

Common Errors

- STP is not enabled in global configuration mode.
- Transparent transmission is not enabled in global configuration mode and interface configuration mode.

36.6 Monitoring

Displaying

Description	Command
Displays whether the specified port is a Tunnel port.	show dot1q-tunnel [interfaces <i>intf-id</i>]
Displays the configuration of the Tunnel port.	show interfaces dot1q-tunnel
Displays the C-TAG-based selective QinQ policies on the Tunnel port.	show registration-table [interfaces <i>intf-id</i>]
Displays the C-TAG-based selective QinQ policies on the Access port, Trunk port or Hybrid port.	show translation-table [interfaces <i>intf-id</i>]
Displays VLAN mapping on ports.	show interfaces [<i>intf-id</i>] vlan-mapping
Displays the ACL-based selective QinQ policies.	show traffic-redirect [interfaces <i>intf-id</i>]

Displays the TPID configuration on ports.	show frame-tag tpid interfaces [<i>intf-id</i>]
Displays the configuration of priority replication.	show inner-priority-trust
Displays the configuration of priority mapping.	show interface intf-name remark
Displays the configuration of MAC address replication.	show mac-address-mapping
Displays the configuration of Layer-2 transparent transmission.	show l2protocol-tunnel { <i>gvrp</i> <i>stp</i> }

Debugging

System resources are occupied when debugging information is output. Therefore, disable debugging immediately after use.

Description	Command
Debugs QinQ.	debug bridge qinq

37 Configuring HASH Simulator

37.1 Overview

HASH simulator is a program that simulates the HASH algorithm of the switch. HASH simulator supports Aggregate Port (AP) load-balancing and Equal-Cost Multipath Routing (ECMP) load-balancing modes.

- AP HASH simulator simulates the HASH algorithm to calculate the AP member port for packet forwarding based on the packet field, load-balancing mode and specified AP information. The calculation result conforms to the real forwarding port.
- If you configure AP on a switch, use the AP simulator to calculate the AP member port for packet forwarding by specifying the packet field.
- ECMP HASH simulator simulates the HASH algorithm to calculate the next hop for packet forwarding based on the packet field and load balance mode. The calculation result conforms to the real forwarding next hop.
- If you configure ECMP on a switch and want to know the next hop for specified packets without doing tests, use the ECMP simulator to calculate the hit next hop.

HASH simulator can be used to track and monitor the forwarding path of specified packets, facilitating user management and troubleshooting.

Protocols and Standards

- IEEE 802.3ad

37.2 Applications

Application	Description
AP HASH Simulator	Combining multiple physical links into one logical link is an effective way to increase port bandwidth and improve reliability on a L3 switch. Packets are forwarded through a physical link according to load balance algorithm. AP simulator calculation enables users to check the member link, which serves as reference for troubleshooting and topology deployment.
ECMP HASH Simulator	On a L3 switch configured with ECMP, packets are forward through an ECMP load-balanced next hop. ECMP simulator calculation enables users to check the member link, which serves as reference for troubleshooting and topology deployment.

37.2.1 AP HASH Simulator

Scenario

With HASH simulator, you can calculate the AP load-balanced forwarding port.

- AP load balancing: The dual-NIC server is aggregated into one logical link to share service data flow.
- You should know which NIC on the server receives the packets with destination IP addresses of 2.2.2.1/24, 4.4.4.1/24, and 9.9.9.1/24 sent by the uplinked server.

Figure 14- 1

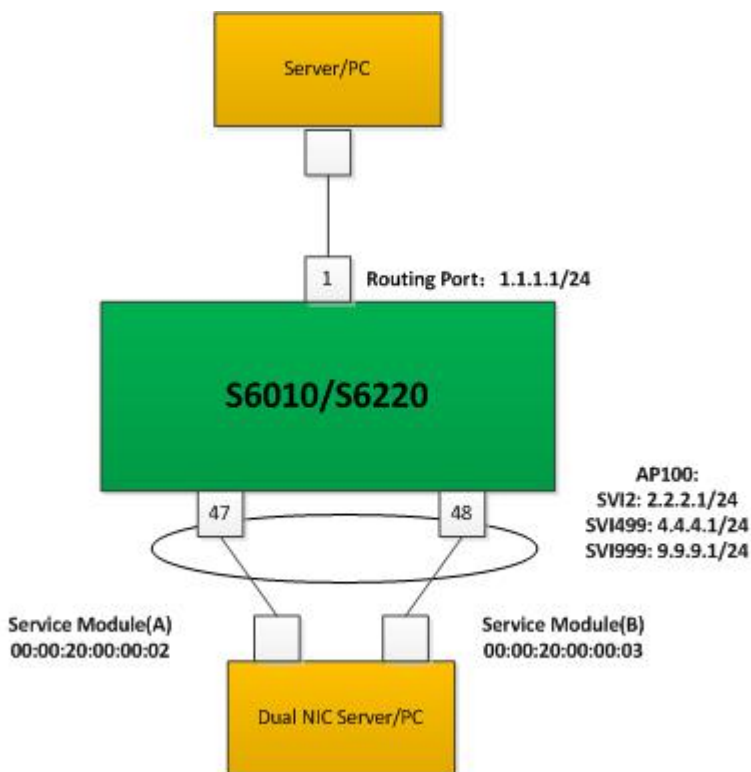

Note N/A

Deployment

- The ports connecting the dual NIC server and S6010/S6220 are aggregated into an AP to share service data flow.
- Use VLAN 2, VLAN 499 and VLAN 999 to separate the network and undertake different types of service.
- You can identify the AP load-balanced forwarding port on S6010/S6220 according to packet features.
- i** The packet feature can be Source IP, Destination IP, Source L4 port, or Destination L4 port.

37.2.2 ECMP HASH Simulator

Scenario

With HASH simulator, you can calculate the ECMP load-balanced next hop.

- SW1 is uplinked to network segment 1.0.0.0/24 and downlinked to network segment 2.2.2.0/24. The uplink PC can communicate with the downlink clients via SW1.

- You should know which downlink port can receive or forward packets containing different IP addresses sent by the uplink PC.

Figure 14-2

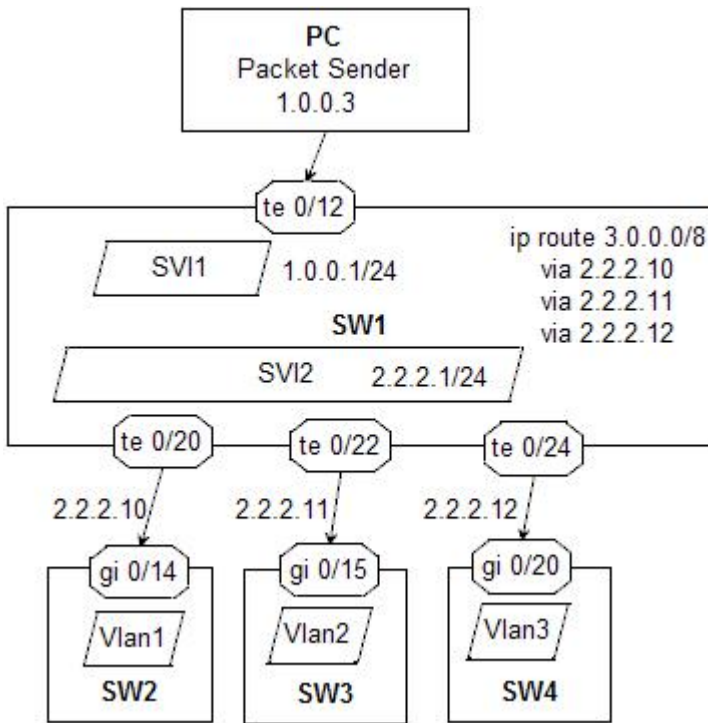

Deployment

- Configure an ECMP route to 3.0.0.0/8 on SW1 and multiple ECMP next hops connect with the downlink.
- You can identify the ECMP load-balanced next hop on SW1 according to packet features.
- i** The packet feature can be Source IP, Destination IP, Source L4 port, or Destination L4 port.

37.3 Features

Basic Concepts

AP

AP is a logical port that consists of several physical ports. AP can be divided into static AP and dynamic AP (LACP AP) based on protocol or into L2 AP and L3 AP based on port feature.

L2 AP

L2 AP is a logical port that consists of several L2 ports with the same L2 features.

L3 AP

L3 AP is a logical port that consists of several L3 ports with the same L3 features.

Load-balancing Mode

Packets are forwarded by an AP member port based on its load-balancing mode. The following AP load-balancing modes are available:

- Source MAC address/ destination MAC address (Src-mac/Dst-mac)
- Source MAC address + destination MAC address (Src-dst-mac)
- Source IP address/ destination IP address (Src-ip/Dst-ip)
- Source IP address + destination IP address (Src-dst-ip)
- Source IP address + destination IP address + source L4 port + destination L4 port (Src-dst-ip-l4port)
- Panel port of incoming packets
- Enhanced Mode (Enhanced)

ECMP

ECMP is a routing strategy where next-hop packet forwarding to a single destination can occur over multiple "best paths" which tie for top place in routing metric calculations. When a next hop becomes unreachable, traffic is switched to the other next hops.

 The ECMP next hop is also selected based on the load-balancing mode.

HASH Simulator

HASH simulator is a program that simulates the HASH algorithm of the switch.

Quintuple

The quintuple refers to the source IP address, destination IP address, protocol, source L4 port and destination L4 port.

Overview

Overview	Description
AP HASH Simulator	Calculates the AP member port for packet forwarding according to the packet field, AP load balance mode and specified AP information.
ECMP HASH Simulator	Calculates the next hop for packet forwarding according to the packet field, load balance mode and destination IP address.

37.3.1 AP HASH Simulator

AP HASH simulator is used to calculate the AP member port for packet forwarding by specifying the packet field.

Working Principle

HASH simulator simulates the HASH algorithm on the switch. The process of AP load-balancing calculation on a switch follows the following steps:

Figure 14- 3

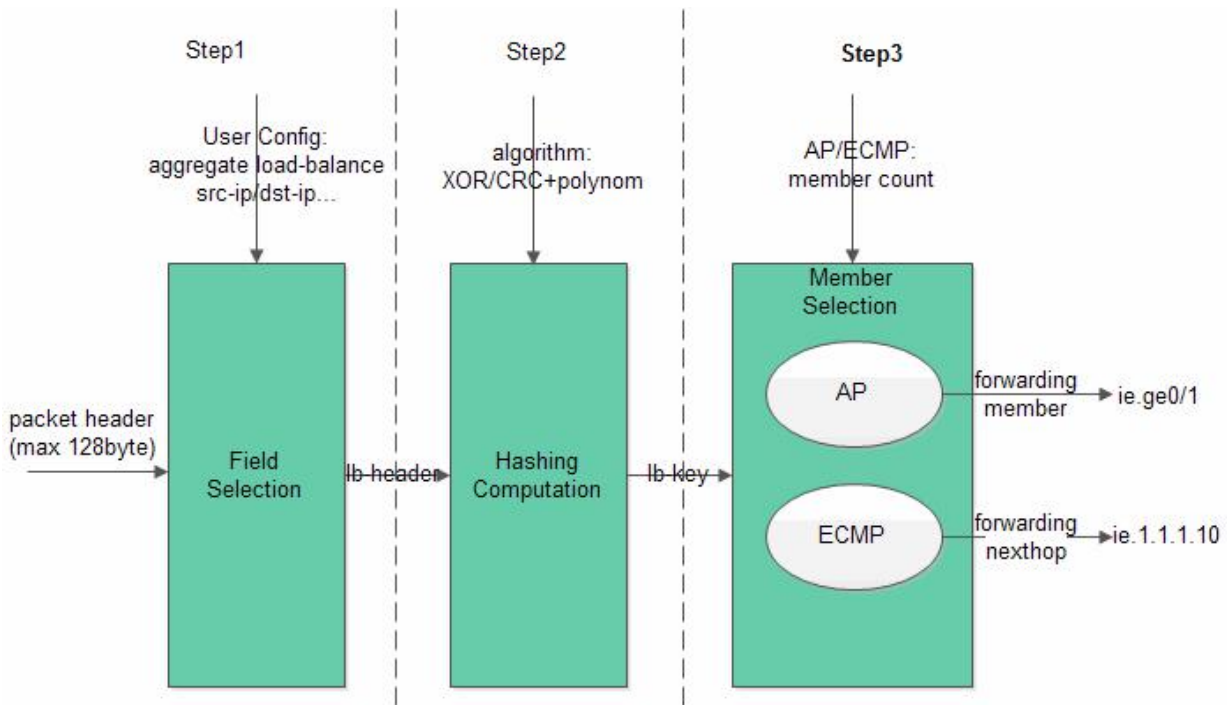

- Step1: Field Selection. Fields are extracted according to the configured load-balancing mode.

Different fields are selected as HASH factors based on the configured load-balancing mode:

Load-balancing Mode	HASH Factor
Src-mac	mac address source
Dst-mac	mac address destination
Src-dst-mac	mac address source and destination
Src-ip	IP address source
Dst-ip	IP address destination
Src-dst-ip	IP address source and destination
Src-dst-ip-l4port	IP address source and destination, L4 port source and destination
Enhanced	Fields are extracted according to load-balance profile. Use the show load-balance profile <i>profile-name</i> command to display all packet fields corresponding to supported packet types.

- ✔ AP HASH simulator supports src- mac, dst-mac, src-dst-mac, src-ip, dst-ip, src-dst-ip, src-dst-ip-l4port and enhanced load-balancing modes.

i Selected HASH factors for AP load-balancing may vary with different products.

- Step2: HASH Computation

HASH algorithm is used to compute the HASH lb-key (load-balance key) based on the HASH factor selected in step 1. HASH algorithms vary with different switches, such as XOR, CRC and CRC+ scramble.

HASH simulator simulates the HASH algorithm on the switch.

- Step3: Member Selection

Divide the AP member number by HASH lb-key, and the remainder is the forwarding port index. The index is unique on FS BCM series switch (including core switch and access switch). Therefore, it can be used to identify the forwarding port.

Related Configuration

Displaying AP simulator calculation result

Users can check the IPv4 AP load-balanced forwarding port by specifying the quintuple feature of IPv4 packets.

Users can check the IPv6 AP load-balanced forwarding port by specifying the quintuple feature of IPv6 packets.

AP HASH simulator supports simulative calculation of unicast packet forwarding only.

37.3.2 ECMP HASH Simulator

ECMP HASH simulator is used to calculate the next hop for packet forwarding by specifying the packet field.

Working Principle

ECMP HASH simulator simulates the HASH algorithm, similar to AP HASH simulator.

- Step1: Field Selection. Fields are extracted according to the configured load balance mode.

ECMP load-balancing modes share configuration with AP load-balancing modes. Load-balancing modes correspond to HASH factors are as follows:

Load-balancing Mode	HASH Factor
Src-mac	IP address source
Dst-mac	IP address source
Src-dst-mac	IP address source
Src-ip	IP address source
Dst-ip	IP address source and destination
Src-dst-ip	IP address source and destination
Src-dst-ip-l4port	IP address source and destination, L4 port source and destination
Enhanced	Fields are extracted according to load-balance profile. Use the show load-balance profile profile-name command to display all packet fields corresponding to supported packet types.

ECMP HASH simulator supports src-ip, dst-ip, src-dst-ip, src-dst-ip-l4port and enhanced load-balancing modes.



Selected HASH factors for ECMP load balancing vary with different products.



For some products like N18000-CB, load-balancing modes correspond to HASH factors. For example, the src-mac mode corresponds to the HASH factor of source MAC address; the dst-mac mode corresponds to the HASH factor of destination MAC address.

- Step2: HASH Computation

HASH algorithm is used to compute the HASH lb-key (load-balance key) based on the HASH factor selected in step 1. ECMP load balance supports HASH algorithms of CRC and CRC+ scramble.

- Step3: Member Selection

Divide the ECMP next hop number by HASH lb-key, and the remainder is the next-hop index. The unique index can be used to identify the next hop.

Related Configuration

📄 Displaying ECMP simulator calculation result

Users can check the IPv4 ECMP load-balanced next hop by specifying the quintuple feature of IPv4 packets.

Users can check the IPv6 ECMP load-balanced next hop by specifying the quintuple feature of IPv6 packets.

- i** If the ECMP next hop is an AP, the forwarding port is selected based on AP load balance mode. Users can enter the command to display the packet forwarding port.

37.4 Configuration

Configuration	Description and Command
Displaying AP load-balanced forwarding port	<p>i Optional</p> <p>show aggregate load-balance to interface aggregateport <i>ap-id ip</i> [source <i>source-ip</i>] [destination <i>dest-ip</i>] [ip-protocol <i>protocol-id</i>] [I4-source-port <i>src-port</i>] [I4-dest-port <i>dest-port</i>]</p> <p>Displays the IPv4 AP load-balanced forwarding port.</p>
	<p>show aggregate load-balance to interface aggregateport <i>ap-id ipv6</i> [source <i>source-ip</i>] [destination <i>dest-ip</i>] [ip-protocol <i>protocol-id</i>] [I4-source-port <i>src-port</i>] [I4-dest-port <i>dest-port</i>]</p> <p>Displays the IPv6 AP load-balanced forwarding port.</p>
	<p>show aggregate load-balance interface <i>interface-type interface-number to interface aggregateport</i> <i>ap-id forward</i> [L2 L3] mac [src-mac <i>source-mac</i>] [dst-mac <i>dest-mac</i>] [vlan <i>vlan-id</i>] [etype <i>value</i>]</p> <p>Displays the layer-2 AP load-balanced forwarding port.</p>
Displaying ECMP load-balanced forwarding port	<p>show ip ecmp-nexthop address destination <i>dest-ip</i> [source <i>source-ip</i>] [protocol <i>protocol-id</i>] [I4-source-port <i>src-port</i>] [I4-dest-port <i>dst-port</i>] [vrf <i>vrf-name</i>]</p> <p>Displays the IPv4 ECMP next hop.</p>
	<p>show ipv6 ecmp-nexthop address destination <i>dest-ip</i> [source <i>source-ip</i>] [next-header <i>protocol-id</i>] [I4-source-port <i>src-port</i>] [I4-dest-port <i>dst-port</i>] [vrf <i>vrf-name</i>]</p> <p>Displays the IPv6 ECMP next hop.</p>

37.4.1 Displaying AP Load-Balanced Forwarding Port

Configuration Effect

- Display the AP member port for packet forwarding.

Notes

- AP hash simulator works based on the AP load-balancing mode. Therefore, use the aggregate load-balance command to configure the AP load-balancing mode first.
- Create AP and add member ports.
-  See Configuring Aggregate Port in Ethernet Switching Configuration Guide.

Configuration Steps

▾ Displaying Layer-2 AP load-balanced forwarding port

- Monitor forwarding path and troubleshooting.
- Enter the command to display AP forwarding ports on the switch.

▾ Displaying IPv4 AP load-balanced forwarding port

- The same as above.

▾ Displaying IPv6 AP load-balanced forwarding port

- The same as above.

Verification

- Verify the configuration by pumping real traffic. Observe and record the forwarding port.
- Check whether the real forwarding port conforms to the displayed port.

Related Commands

▾ Displaying Layer-2 AP load-balanced forwarding port

Command	show aggregate load-balance interface <i>interface-type interface-number</i> to interface aggregateport <i>ap-id</i> forward [L2 L3] mac [src-mac <i>source-mac</i>] [dst-mac <i>dest-mac</i>] [vlan <i>vlan-id</i>] [etype <i>value</i>]
Parameter	interface <i>interface-type interface-number</i> : Traffic ingress. aggregateport <i>ap-id</i> : Destination AP ID. forward [L2 L3]: Layer-2 or layer-3 forwarding mode. src-mac <i>source-mac</i> : Source MAC address. dst-mac <i>dest-mac</i> : Destination MAC address vlan <i>vlan-id</i> : TAG ID etype <i>value</i> : Ethernet type of packet.
Command Mode	Privileged EXEC mode/Global configuration mode/Interface configuration mode
Usage Guide	N/A

▾ Displaying IPv4 AP load-balanced forwarding port

Command	show aggregate load-balance interface <i>interface-type interface-number</i> to interface aggregateport <i>ap-id</i> forward [L2 L3] ip [source <i>source-ip</i>] [destination <i>dest-ip</i>] [ip-protocol <i>protocol-id</i>] [I4-source-port <i>src-port</i>] [I4-dest-port <i>dest-port</i>]
Parameter	interface <i>interface-type interface-number</i> : Traffic ingress. aggregateport <i>ap-id</i> : Destination AP ID.

	<p>forward [L2 L3]: Layer-2 or layer-3 forwarding mode.</p> <p>source <i>source-ip</i>: Source IPv4 address</p> <p>destination <i>dest-ip</i>: Destination IPv4 address</p> <p>ip-protocol <i>protocol-id</i>: IP protocol ID. For example, the protocol ID of TCP and UDP are 6 and 17 respectively.</p> <p>I4-source-port <i>src-port</i>: L4 source port ID</p> <p>I4-dest-port <i>dst-port</i>: L4 destination port ID</p>
Command Mode	Privileged EXEC mode/Global configuration mode/Interface configuration mode
Usage Guide	N/A

📌 **Displaying IPv6 AP load-balanced forwarding port**

Command	<p>show aggregate load-balance interface <i>interface-type interface-number</i> to interface aggregateport <i>ap-id</i></p> <p>forward [L2 L3] ipv6 [source <i>source-ip</i>] [destination <i>dest-ip</i>] [ip-protocol <i>protocol-id</i>] [I4-source-port <i>src-port</i>] [I4-dest-port <i>dst-port</i>]</p>
Parameter	<p>interface <i>interface-type interface-number</i>: Traffic ingress.</p> <p>aggregateport <i>ap-id</i>: Destination AP ID.</p> <p>forward [L2 L3]: Layer-2 or layer-3 forwarding mode.</p> <p>source <i>source-ip</i>: Source IPv6 address</p> <p>destination <i>dest-ip</i>: Destination IPv6 address</p> <p>ip-protocol <i>protocol-id</i>: IP protocol ID. For example, the protocol ID of TCP and UDP are 6 and 17 respectively.</p> <p>I4-source-port <i>src-port</i>: L4 source port ID</p> <p>I4-dest-port <i>dst-port</i>: L4 destination port ID</p>
Command Mode	Privileged EXEC mode/Global configuration mode/interface configuration mode
Usage Guide	N/A

Common Errors

- AP HASH simulator does not support the configured load-balancing mode.
- The current switch does not support AP HASH simulator.
- AP is not created or does not have member ports.

Configuration Example

📌 **Displaying Layer-2 AP load-balanced forwarding port**

Configuration Steps	<p>Configures load-balancing mode.</p> <pre> FS# configure terminal FS(config)# aggregateport load-balance dst-mac FS(config)# show agg load-balance Load-balance : Destination MAC FS# end </pre>
----------------------------	---

Verification

Run the **show aggregate load-balance to** command to display AP forwarding port according to packet dmac

- Display AP load-balanced forwarding port for packets destined to MAC address 0000.2000.0002.

```
FS# show aggregate load-balance interface gigabitethernet 0/1 to interface aggregateport 1 forward L2 mac
dst-mac 0000.2000.0002
aggregateport load-balance mode : Destination MAC
balance to port : GigabitEthernet 0/47
```

- Display AP load-balanced forwarding port for packets destined to MAC address 0000.2000.0003.

```
FS# show aggregate load-balance interface gigabitethernet 0/1 to interface aggregateport 1 forward L2 mac
dst-mac 0000.2000.0002
aggregateport load-balance mode : Destination MAC
balance to port : GigabitEthernet 0/48
```

- If the specified AP does not have member ports, the forwarding port is displayed as NULL.

```
FS# show aggregate load-balance interface gigabitethernet 0/1 to interface aggregateport 1 forward L2 mac
dst-mac 0000.2000.0002
aggregateport load-balance mode : Destination MAC
balance to port :
```

Displaying IPv4 AP load-balanced forwarding port

Network Environment

Figure 14- 4

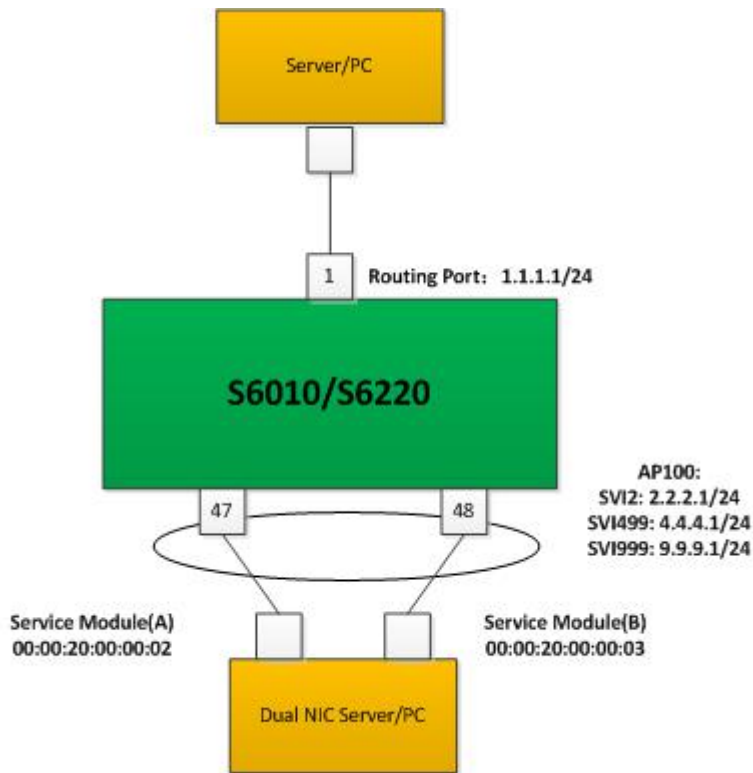

Configuration Steps	<p>Configure the load-balancing mode.</p> <pre> FS# configure terminal FS(config)# aggregate load-balance dst-ip FS(config)# show agg load-balance Load-balance : Destination IP FS# end </pre>
Verification	<p>Use the show aggregate load-balance to command to display AP forwarding port.</p> <ul style="list-style-type: none"> ● Display AP load-balanced forwarding port for packets destined to IP address 2.2.2.2. <pre> FS# show aggregate load-balance interface gigabitethernet 0/1 to interface aggregateport 1 forward L3 ip destination 2.2.2.2 aggregateport load-balance mode : Destination IP balance to port : GigabitEthernet 0/47 </pre> <ul style="list-style-type: none"> ● Display AP load-balanced forwarding port for packets destined to IP address 4.4.4.4. <pre> FS# show aggregate load-balance interface gigabitethernet 0/1 to interface aggregateport 1 forward L3 ip destination 4.4.4.4 aggregateport load-balance mode : Destination IP balance to port : GigabitEthernet 0/48If the specified AP does not have member ports, the forwarding port is displayed as NULL. </pre> <pre> FS# show aggregate load-balance interface gigabitethernet 0/1 to interface aggregateport 1 forward L3 ip source 1.1.1.1 aggregateport load-balance mode : Destination IP balance to port : </pre>

37.4.2 Displaying ECMP Load-Balanced Forwarding Port

Configuration Effect

- Display the ECMP next hop for packet forwarding.

Notes

- Only reachable next hops are load-balanced.

Configuration Steps

⌵ Displaying IPv4 ECMP next hop

- Monitor forwarding path and troubleshooting.
- Enter the command to display AP forwarding ports on the switch.

⌵ Displaying IPv6 ECMP next hop

The same as above

Verification

- Verify the configuration by pumping real flows. Observe and record the forwarding next hop.
- Check whether the real next hop conforms to the displayed next hop.

Related Commands

↘ Displaying IPv4 ECMP next hop

Command	show ip ecmp-nexthop address destination <i>dest-ip</i> [source <i>source-ip</i>] [protocol <i>protocol-id</i>] [I4-source-port <i>src-port</i>] [I4-dest-port <i>dst-port</i>] [vrf <i>vrf-name</i>]
Parameter	source <i>source-ip</i> : Source IPv4 address destination <i>dest-ip</i> : Destination IPv4 address protocol <i>protocol-id</i> : IP protocol ID. For example, the protocol ID of TCP, UDP and ICMP are 6,17 and 1 respectively. I4-source-port <i>src-port</i> : L4 source port ID I4-dest-port <i>dst-port</i> : L4 destination port ID vrf <i>vrf-name</i> : VRF name
Command Mode	Privileged EXEC mode/Global configuration mode/Interface configuration mode
Usage Guide	N/A

↘ Displaying IPv6 ECMP next hop

Command	show ipv6 ecmp-nexthop address destination <i>dest-ip</i> [source <i>source-ip</i>] [next-header <i>protocol-id</i>] [I4-source-port <i>src-port</i>] [I4-dest-port <i>dst-port</i>] [vrf <i>vrf-name</i>]
Parameter	source <i>source-ip</i> : Source IPv6 address destination <i>dest-ip</i> : Destination IPv6 address next-header <i>protocol-id</i> : IP protocol ID. For example, the protocol ID of TCP, UDP and ICMP are 6,17 and 1 respectively. I4-source-port <i>src-port</i> : L4 source port ID I4-dest-port <i>dst-port</i> : L4 destination port ID vrf <i>vrf-name</i> : VRF name
Command Mode	Privileged EXEC mode/Global configuration mode/Interface configuration mode
Usage Guide	N/A

Common Errors

- ECMP HASH simulator does not support the configured load-balancing mode.
- The current switch does not support ECMP HASH simulator.
- ECMP is not configured or no reachable next hop is available.

Configuration Example

↘ Displaying IPv4 ECMP Next Hop

<p>Network Environment Figure 14-5</p>	
<p>Configuration Steps</p>	<ol style="list-style-type: none"> 1. Configure ECMP. 2. Configure the load-balancing mode.
	<pre> FS# configure terminal FS(config)# aggregate load-balance src-dst-ip FS(config)# show agg load-balance Load-balance : Source IP and Destination IP FS(config)# end </pre>

Verification	<p>Use the show ip ecmp-nexthop command to display the route in vrf 0. The hit next hop is marked by "*". The DIP parameter is mandatory whether it is necessary for the HASH calculation. ECMP HASH simulator can be used to calculate one single next hop for a uni-route.</p> <ul style="list-style-type: none"> ● Display the ECMP load-balanced next hop for packets from 1.0.0.1 to 3.0.0.1. Change the destination IP address to 3.0.0.2 and display the next hop again. <pre data-bbox="333 421 1419 1086"> FS#show ip ecmp-nexthop address destination 3.0.0.1 source 1.0.0.1 balance mode: Source IP and Destination IP route table: vrf 0 hit ip route, actual nexthop marked by "*": 3.0.0.0/8 via 2.2.2.10 weight 1 via 2.2.2.11 weight 1 * via 2.2.2.12 weight 1 FS#show ip ecmp-nexthop address destination 3.0.0.2 source 1.0.0.1 balance mode: Source IP and Destination IP route table: vrf 0 hit ip route, actual nexthop marked by "*": 3.0.0.0/8 via 2.2.2.10 weight 1 via 2.2.2.11 weight 1 via 2.2.2.12 weight 1 * </pre> <ul style="list-style-type: none"> ● If the DIP in the entered CLI command does not hit the routing table, an error is displayed. <pre data-bbox="333 1131 1419 1209"> FS#show ip ecmp-nexthop address destination 5.0.0.1 source 1.0.0.7 %ecmp HASH failed, for look up time out or no route hitted </pre> <ul style="list-style-type: none"> ● Display the ECMP load-balanced next hop for packets from 1.0.0.1 to 3.0.0.1. Change the source IP address to 1.0.0.3 and display the next hop again. <pre data-bbox="333 1299 1419 1955"> FS#show ip ecmp-nexthop address destination 3.0.0.1 source 1.0.0.1 balance mode: Source IP and Destination IP route table: vrf 0 hit ip route, actual nexthop marked by "*": 3.0.0.0/8 via 2.2.2.10 weight 1 via 2.2.2.11 weight 1 * via 2.2.2.12 weight 1 FS#show ip ecmp-nexthop address destination 3.0.0.1 source 1.0.0.3 balance mode: Source IP and Destination IP route table: vrf 0 hit ip route, actual nexthop marked by "*": 3.0.0.0/8 via 2.2.2.10 weight 1 * via 2.2.2.11 weight 1 via 2.2.2.12 weight 1 </pre>
--------------	--

- The ECMP next hop is down. Display the simulatively calculated next hop again.

```
FS#show arp
Protocol  Address      Age(min)  Hardware      Type  Interface
Internet  2.2.2.11     <static> 0000.0000.0011 arpa  VLAN 2
Internet  2.2.2.12     <static> 0000.0000.0012 arpa  VLAN 2
Internet  1.0.0.1      --        00d0.f822.33b2 arpa  VLAN 1
Internet  2.2.2.1      --        00d0.f822.33b2 arpa  VLAN 2
Internet  2.2.2.10     <--->    <Incomplete> arpa  VLAN 2
```

- Display the ECMP load-balanced next hop for the packets from 1.0.0.1 to 3.0.0.1, to 3.0.0.2 and to 3.0.0.6 respectively again.

```
FS#show ip ec ad de 3.0.0.1 so 1.0.0.1
balance mode:  Source IP and Destination IP
route table:   vrf 0
hit ip route, actual nexthop marked by "*":
3.0.0.0/8
  via 2.2.2.10 weight 1
  via 2.2.2.11 weight 1 *
  via 2.2.2.12 weight 1
FS#show ip ec ad de 3.0.0.2 so 1.0.0.1
balance mode:  Source IP and Destination IP
route table:   vrf 0
hit ip route, actual nexthop marked by "*":
3.0.0.0/8
  via 2.2.2.10 weight 1
  via 2.2.2.11 weight 1
  via 2.2.2.12 weight 1 *
FS#show ip ec ad de 3.0.0.6 so 1.0.0.1
balance mode:  Source IP and Destination IP
route table:   vrf 0
hit ip route, actual nexthop marked by "*":
3.0.0.0/8
  via 2.2.2.10 weight 1
  via 2.2.2.11 weight 1 *
  via 2.2.2.12 weight 1
```

38 Configuring L3-PKT-COUNTER ENABLE

38.1 Overview

Generally, the traffic statistics function involves all traffic on the port. The IP traffic statistics function enables the device to count only IP traffic on layer-3 interfaces.

Protocols and Standards

- N/A

38.2 Applications

N/A

38.3 Configuration

Configuration	Description and Command
Configuring IP traffic Statistics on the Layer-3 Interface	 (Optional) It is used to configure the traffic statistics function on the Layer-3 interface.
	l3-pkt-counter enable Enables IP (including IPv4 and IPv6) traffic statistics on the Layer-3 interface.

38.3.1 Enabling IP Traffic Statistics on the Layer-3 Interface

Configuration Effect

Enable IP traffic statistics on the Layer-3 interface.

Configuration Steps

▾ Enabling IP Traffic Statistics on the Layer-3 Interface

Command	[no] l3-pkt-counter enable
Parameter Description	no: Disables IP traffic statistics on the Layer-3 interface.
Defaults	IP traffic statistics is disabled by default.
Command Mode	Global configuration mode
Usage Guide	N/A

Verification

- Run the **show run | in l3-pkt-counter enable** command to check whether the IP traffic statistics function is enabled.

38.4 Monitoring

Displaying

Description	Command
Displays the device configuration.	show running-config

39 Configuring Positioning Lamp

39.1 Overview

The positioning lamp function is used to pinpoint the actual physical location of a port to be controlled. You can just run a command to enable the LED indicator of a port to be solid red for positioning. When building or altering the scenario environment, O&M personnel may easily remove and insert the cable from or into a false port due to complex scenario topology and existence of excessive cables. This misoperation can cause scenario errors and delay the project maintenance or delivery progress. For this, the positioning means is a good solution to pinpoint the actual location of a required port.

39.2 Applications

Application	Description
Port positioning	Pinpoints the physical location of a port conveniently and accurately in complex environment.

39.2.1 Port Positioning

Scenario

Switch A and switch B are connected through multiple links. A port on switch A needs to be controlled but another port may be manipulated due to misoperations. With the positioning means, when a port on switch A needs to be controlled, you can run a command to enable the positioning lamp on the port. Then, the LED indicator of the port is solid red. In this way, you can accurately find out the physical location of the required port.

Figure 16-1

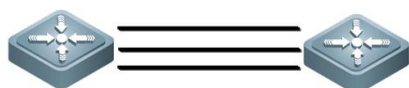

Deployment

- The positioning lamp function is disabled by default. To pinpoint a port, enable the positioning lamp function on the port.

39.3 Configuration

Configuration	Description and Command
Configuring the Basic Function for an Indicator	(Mandatory) It is used to enable the positioning lamp.
	posit-lamp enable Enables the positioning lamp.
	no posit-lamp enable Restores the default mode, that is, disables the positioning lamp.

39.3.1 Configuring the Basic Function for an Indicator

Configuration Effect

- Enable the positioning lamp function on a port so that the physical LED indicator of the port is solid red.

Notes

- The port indicator is solid red to indicate the positioning state and green to indicate the link state (whether the green indicator blinks depends on data transmission).
- The positioning state is prior to the link state. When the positioning lamp function is enabled, the link state change cannot switch the status of the port indicator.

Configuration Steps

➤ Configuring the Indicator

- Mandatory. The positioning lamp function is disabled by default.
- The positioning lamp function can be configured on AP members, split ports, and VSL ports.

Command	posit-lamp enable
Parameter	N/A
Description	
Command	Interface configuration mode
Mode	
Usage Guide	N/A

Verification

Configure the positioning lamp function on a port.

- Check whether the LED indicator of the port is solid red.
- Run the **shut** or **no shut** command on the port or remove and then insert the cable. The indicator status should not change.

Common Errors

- N/A

39.4 Monitoring

N/A

40 Configuring Port Module Type

40.1 Overview

Different module types need to be configured for ports using different modules so that the modules can normally transmit and receive signals and forward traffic.

40.2 Applications

Application	Description
Configuring the Module Type for Ports	Configure the port module type based on inserted optical modules, AOCs, and copper cables.

40.2.1 Configuring the Module Type for Ports



Scenario

A single switch with 100G/25G physical ports is used.

Deployment

- The port module type is not configured by default. The software automatically adapts to the module type based on the inserted modules. It configures the optical module type for optical modules, backplane type for AOC modules, and copper cable type for copper cables.
- If a module cannot be identified and consequently the port link cannot go up, you can use this function to forcibly set the module type for repair.

40.3 Configuration

Configuration	Description and Command	
Configuring the Module Type for 100G Ports	 (Optional) It is used to configure the module type based on inserted modules.	
	transceiver { module_type }	Sets the module type for 100G ports.
Configuring the Module Type for 25G Ports	 (Optional) It is used to configure the module type based on inserted modules.	
	transceiver { module_type }	Sets the module type for 25G ports.

40.3.1 Configuring the Module Type for Ports

Configuration Effect

- If the module type is configured after modules are inserted into a port, flapping will occur on the port. Therefore, perform the configuration when the port is down.

Notes

- Configure the module type based on inserted modules. If a module is inconsistent with the configuration, a syslog is displayed. The inconsistency can result in port signal deterioration, packet CRC error or packet loss, and even port going down.

Configuration Steps

⌵ Configuring the Module Type for 100G Ports

Command	<code>transceiver { 100GBASE-Activecable 100GBASE-COPPER 100GBASE-FIBER 40GBASE-Activecable 40GBASE-COPPER 40GBASE-FIBER }</code>
Parameter Description	<p>100GBASE-Activecable: Indicates the 100G AOC module type.</p> <p>100GBASE-COPPER: Indicates the 100G copper cable module type.</p> <p>100GBASE-FIBER: Indicates the 100G optical module type.</p> <p>40GBASE-Activecable: Indicates the 40G AOC module type.</p> <p>40GBASE-COPPER: Indicates the 40G copper cable module type.</p> <p>40GBASE-FIBER: Indicates the 40G optical module type.</p>
Command Mode	Interface configuration mode
Usage Guide	The module type needs to be configured based on actual modules. You can use the default form of this command to restore the default configuration.

⌵ Configuring the Module Type for 25G Ports

Command	<code>transceiver {10GBASE-Activecable 10GBASE-COPPER 10GBASE-FIBER 25GBASE-Activecable 25GBASE-COPPER 25GBASE-FIBER}</code>
Parameter Description	<p>10GBASE-Activecable: Indicates the 10G AOC module type.</p> <p>10GBASE-COPPER: Indicates the 10G copper cable module type.</p> <p>10GBASE-FIBER: Indicates the 10G optical module type.</p> <p>25GBASE-Activecable: Indicates the 25G AOC module type.</p> <p>25GBASE-COPPER: Indicates the 25G copper cable module type.</p> <p>25GBASE-FIBER: Indicates the 25G optical module type.</p>
Command Mode	Interface configuration mode
Usage Guide	The module type needs to be configured based on actual modules. You can use the default form of this command to restore the default configuration.

Configuration Example

⌵ Configuring the Module Type for 100G Ports

Configuration Steps	<ul style="list-style-type: none"> ● Set the module type of the 100G port to AOC module type.
----------------------------	--

	FS(config-if-HundredGigabitEthernet 0/49)#transceiver 100GBASE-Activecable
Verification	Run the show running-config include TFGigabitEthernet 0/1 command to display the port configuration.
	<pre> FS(config-if-HundredGigabitEthernet 0/49)#show run in hundredGigabitEthernet 0/49 Building configuration... Current configuration : 67 bytes interface hundredGigabitEthernet 0/49 transceiver 100GBASE-Activecable </pre>

⤵ Configuring the Module Type for 25G Ports

Configuration Steps	<ul style="list-style-type: none"> ● Set the module type of the 25G port to AOC module type.
	FS(config-if-TFGigabitEthernet 0/1)#transceiver 25GBASE-Activecable
Verification	Run the show running-config interface TFGigabitEthernet 0/1 command to display the port configuration.
	<pre> FS(config-if-TFGigabitEthernet 0/1)#show run in TFGigabitEthernet0/1 Building configuration... Current configuration : 67 bytes interface TFGigabitEthernet 0/1 transceiver 25GBASE-Activecable </pre>

Common Errors

```

FS(config-if-TFGigabitEthernet 0/1)#transceiver 25GBASE-COPPER

*Apr 4 22:15:48: %PORT-3-ERROR: Transceiver configuration(25GBASE-COPPER) on Interface TFGigabitEthernet 0/1 cannot match the
inserted transceiver(25GBASE-Activecable).

FS(config-if-TFGigabitEthernet 0/1)#

FS(config-if-HundredGigabitEthernet 0/49)#transceiver 100GBASE-COPPER

*Apr 4 22:15:48: %PORT-3-ERROR: Transceiver configuration(100GBASE-COPPER) on Interface HundredGigabitEthernet 0/49 cannot
match the inserted transceiver(100GBASE-Activecable).

FS(config-if-HundredGigabitEthernet 0/49)#
    
```

40.4 Monitoring

N/A

IP Address & Application Configuration

1. Configuring IP Address and Service
2. Configuring ARP
3. Configuring IPv6
4. Configuring DHCP
5. Configuring DHCPv6
6. Configuring DNS
7. Configuring FTP Server
8. Configuring FTP Client
9. Configuring Tunnel Interface
10. Configuring Network Connectivity Test Tool
11. Configuring TCP
12. Configuring IPv4/IPv6 REF
13. Configuring ECMP CLUSTER

1 Configuring IP Addresses and Services

1.1 Overview

Internet Protocol (IP) sends packets to the destination from the source by using logical (or virtual) addresses, namely IP addresses. At the network layer, routers forward packets based on IP addresses.

Protocols and Standards

- RFC 1918: Address Allocation for Private Internets
- RFC 1166: Internet Numbers

1.2 Applications

Application	Description
Configuring an IP Address for Communication	Two networks communicate through one switch interface.

1.2.1 Configuring an IP Address for Communication

Scenario

A switch is connected to a Local Area Network (LAN), which is divided into two network segments, namely, 172.16.1.0/24 and 172.16.2.0/24. Computers in the two network segments can communicate with the Internet through switches and computers between the two network segments can communicate with each other.

Figure 1- 1 Configuring IP Addresses

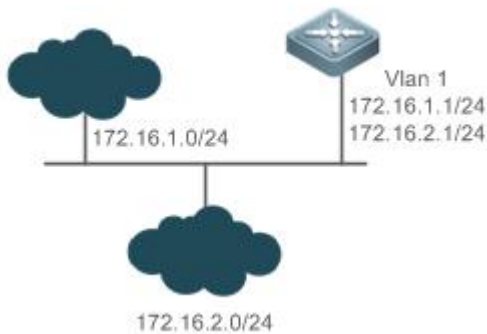

Deployment

- Configure two IP addresses on VLAN1. One is a primary IP address and the other is a secondary IP address.
- On hosts in the network segment 172.16.1.0/24, set the gateway to 172.16.1.1; on hosts in the network segment 172.16.2.0/24, set the gateway to 172.16.2.1.

1.3 Features

Basic Concepts

IP Address

An IP address consists of 32 bits in binary. To facilitate writing and description, an IP address is generally expressed in decimal. When expressed in decimal, an IP address is divided into four groups, with eight bits in each group. The value range of each group is from 0 to 255, and groups are separated by a full stop ". For example, "192.168.1.1" is an IP address expressed in decimal.

IP addresses are used for interconnection at the IP layer. A 32-bit IP address consists of two parts, namely, the network bits and the host bits. Based on the values of the first several bits in the network part, IP addresses in use can be classified into four classes.

For a class A address, the most significant bit is 0. 7 bits indicate a network ID, and 24 bits indicate a local address. There are 128 class A networks in total.

Figure 1- 2

		8	16	24	32
Class A IP address	0	Network ID	Host ID		

For a class B address, the first two most significant bits are 10. 14 bits indicate a network ID, and 16 bits indicate a local address. There are 16,384 class B networks in total.

Figure 1- 3

			8	16	24	32
Class B IP address	1	0	Network ID	Host ID		

For a class C address, the first three most significant bits are 110. 21 bits indicate a network ID, and 8 bits indicate a local address. There are 2,097,152 class C networks in total.

Figure 1- 4

				8	16	24	32
Class C IP address	1	1	0	Network ID	Host ID		

For a class D address, the first four most significant bits are 1110 and other bits indicate a multicast address.

Figure 1- 5

					8	16	24	32
Class D IP address	1	1	1	0	Multicast address			

The addresses with the first four most significant bits 1111 cannot be assigned. These addresses are called class E addresses and are reserved.

When IP addresses are planned during network construction, IP addresses must be assigned based on the property of the network to be built. If the network needs to be connected to the Internet, users should apply for IP addresses to the corresponding agency. In China, you can apply to China Internet Network Information Center (CNNIC) for IP addresses. Internet Corporation for Assigned Names and Numbers (ICANN) is the final organization responsible for IP address assignment. If the network to be built is an internal private network, users do not need to apply for IP addresses. However, IP addresses cannot be assigned at random. It is recommended to assign dedicated private network addresses.

The following table lists reserved and available addresses.

Class	Address Range	Status
Class A network	0.0.0.0 - 0.255.255.255	Reserved
	1.0.0.0 - 126.255.255.255	Available
	127.0.0.0 - 127.255.255.255	Reserved
Class B network	128.0.0.0 - 191.254.255.255	Available
	191.255.0.0 - 191.255.255.255	Reserved
Class C network	192.0.0.0 - 192.0.0.255	Reserved
	192.0.1.0 - 223.255.254.255	Available
	223.255.255.0 - 223.255.255.255	Reserved
Class D network	224.0.0.0 - 239.255.255.255	Multicast address
Class E network	240.0.0.0 - 255.255.255.254	Reserved
	255.255.255.255	Broadcast address

Three address ranges are dedicated to private networks. These addresses are not used in the Internet. If the networks to which these addresses are assigned need to be connected to the Internet, these IP addresses need to be converted into valid Internet addresses.

The following table lists private address ranges. Private network addresses are defined in RFC 1918.

Class	Address Range	Status
Class A network	10.0.0.0 - 10.255.255.255	1 class A network
Class B network	172.16.0.0 - 172.31.255.255	16 class B networks
Class C network	192.168.0.0 - 192.168.255.255	256 class C networks

For assignment of IP addresses, TCP/UDP ports, and other codes, refer to RFC 1166.

↘ Subnet Mask

A subnet mask is also a 32-bit value. The bits that identify the IP address are the network address. In a subnet mask, the IP address bits corresponding to the bits whose values are 1s are the network address, and the IP address bits corresponding to the bits whose values are 0s are the host address. For example, for class A networks, the subnet mask is 255.0.0.0. By using network masks, you can divide a network into several subnets. Subnetting means to use some bits of the host address as the network address, thus decreasing the host capacity, and increasing the number of networks. In this case, network masks are called subnet masks.

↘ Broadcast Packet

Broadcast packets refer to the packets destined for all hosts on a physical network. FS products support two types of broadcast packets: (1) directed broadcast, which indicates that all hosts on the specified network are packet receivers and the host bits of a destination address are all 1s; (2) limited broadcast, which indicates that all hosts on all networks are packet receivers and the 32 bits of a destination address are all 1s.

↘ ICMP Packet

Internet Control Message Protocol (ICMP) is a sub-protocol in the TCP/IP suite for transmitting control messages between IP hosts and network devices. It is mainly used to notify corresponding devices when the network performance becomes abnormal.

↘ TTL

Time To Live (TTL) refers to the number of network segments where packets are allowed to pass before the packets are discarded. The TTL is a value in an IP packet. It informs the network whether packets should be discarded as the packets stay on the network for a long time.

Features

Feature	Description
IP Address	The IP protocol can run on an interface only after the interface is configured with an IP address.
Broadcast Packet Processing	Broadcast addresses are configured and broadcast packets are forwarded and processed.
Sending ICMP Packets	ICMP packets are sent and received.
Limiting Transmission Rate of ICMP Error Packets	This function prevents Denial of Service (DoS) attacks.
IP MTU	Maximum Transmission Unit (MTU) of IP packets on an interface is configured.
IP TTL	The TTL of unicast packets and broadcast packets is configured.
IP Source Route	Source routes are checked.

1.3.1 IP Address

IP addresses are obtained on an interface in the following ways:

11. Manually configuring IP addresses
12. Obtaining IP addresses through DHCP
13. Obtaining IP addresses through PPP negotiation

These approaches are mutually exclusive. If you configure a new approach to obtain an IP address, the old IP address will be overwritten.

 For details on how to obtain IP addresses through DHCP, see the “DHCP” chapter. The following describes the other three approaches for obtaining IP addresses.

📌 Configuring the IP Address for an Interface

A device can receive and send IP packets only after the device is configured with an IP address. Only the interface configured with an IP address can run the IP protocol.

📌 Configuring Multiple IP Addresses for an Interface

FS products support multiple IP address configuration on one interface, of which one is a primary IP address and the others are secondary IP addresses. Theoretically, the number of secondary IP addresses is not limited. However, secondary IP addresses must belong to different networks and secondary IP addresses must be in different networks from primary IP addresses. In network construction, secondary IP addresses are often used in the following circumstances:

- A network does not have enough host addresses. For example, a LAN now needs one class C network to allocate 254 addresses. However, when the number of hosts exceeds 254, one class C network is not enough and another class C network is needed. In this case, two networks need to be connected. Therefore, more IP addresses are needed.
- Many old networks are based on L2 bridged networks without subnetting. You can use secondary IP addresses to upgrade the network to a routing network based on IP layer. For each subnet, one device is configured with one IP address.
- When two subnets of one network are isolated by another network, you can connect the isolated subnets by creating a subnet of the isolated network and configuring a secondary address. One subnet cannot be configured on two or more interfaces of a device.

▾ Obtaining an IP Addresses through PPP Negotiation

- i** This command is supported on point-to-point interfaces only.

Through this configuration, a point-to-point interface accepts the IP address assigned by the peer end through PPP negotiation.

▾ Borrowing an IP Addresses from Another Interface

One interface may not be configured with an IP address. To enable the interface, it must borrow an IP address from another interface.

- i** IP addresses of Ethernet interfaces, tunnel interfaces, and loopback interfaces can be borrowed. However, these interfaces cannot borrow IP addresses from other interfaces.
- i** The IP addresses of borrowed interfaces cannot be borrowed from other interfaces.
- i** If a borrowed interface has multiple IP addresses, only the primary IP address can be borrowed.
- i** The IP address of one interface can be lent to multiple interfaces.
- i** IP addresses of borrowing interfaces are always consistent with and vary with IP addresses of borrowed interfaces.

Related Configuration

▾ Configuring an Interface with One or More IP Addresses

- By default, an interface is not configured with an IP address.
- The **ip address** command is used to configure an IP address for an interface.
- After an IP address is configured, the IP address can be used for communication when it passes conflict detection.
- The **ip address ip-address mask secondary** command can be used to configure multiple secondary IP addresses.

▾ Borrowing an IP Address from Other Interfaces

- By default, an interface is not configured with an IP address.
- The **ip unnumbered** command can be used to borrow IP addresses from other interfaces.

1.3.2 Broadcast Packet Processing

Working Principle

Broadcast is divided into two types. One is limited broadcast, and the IP address is 255.255.255.255. Because the broadcast is prohibited by routers, the broadcast is called local network broadcast. The other is directed broadcast. All host bits are 1s, for example, 192.168.1.255/24. The broadcast packets with these IP addresses can be forwarded.

If IP network devices forward limited broadcast packets (destination IP address is 255.255.255.255), the network may be overloaded, which severely affects network performance. This circumstance is called broadcast storm. Devices provide some approaches to confine broadcast storms within the local network and prevent continuous spread of broadcast storms. L2 network devices such as bridges and switches forward and spread broadcast storms.

The best way to avoid broadcast storm is to assign a broadcast address to each network, which is directed broadcast. This requires the IP protocol to use directed broadcast rather than limited broadcast to spread data.

For details about broadcast storms, see RFC 919 and RFC 922.

Directed broadcast packets refer to the broadcast packets destined for a subnet. For example, packets whose destination address is 172.16.16.255 are called directed broadcast packets. However, the node that generates the packets is not a member of the destination subnet.

After receiving directed broadcast packets, the devices not directly connected to the destination subnet forward the packets. After directed broadcast packets reach the devices directly connected to the subnet, the devices convert directed broadcast packets to limited broadcast packets (destination IP address is 255.255.255.255) and broadcast the packets to all hosts on the destination subnet at the link layer.

Related Configuration

✚ Configuring an IP Broadcast Address

- By default, the IP broadcast address of an interface is 255.255.255.255.
- To define broadcast packets of other addresses, run the **ip broadcast-address** command on the interface.

✚ Forwarding Directed Broadcast Packets

- By default, directed broadcast packets cannot be forwarded.
- On the specified interface, you can run the **ip directed-broadcast** command to enable directed broadcast packets forwarding. In this way, the interface can forward directed broadcast packets to networks that are directly connected. Broadcast packets can be transmitted within the destination subnet without affecting forwarding of other directed broadcast packets.
- On an interface, you can define an Access Control List (ACL) to transmit certain directed broadcast packets. After an ACL is defined, only directed broadcast packets that match the ACL are forwarded.

1.3.3 Sending ICMP Packets

Working Principle

✚ ICMP Protocol Unreachable Message

A device receives non-broadcast packets destined for itself, and the packets contain the IP protocol that cannot be processed by the device. The device sends an ICMP protocol unreachable message to the source host. Besides, if the device does not know a route to forward packets, it also sends an ICMP host unreachable message.

✚ ICMP Redirection Message

Sometimes, a route may be less than optimal, which makes a device send packets from the interface that receives packets. If a device sends packets from an interface on which it receives the packets, the device sends an ICMP redirection message to the source, informing the source that the gateway is another device on the same subnet. In this way, the source sends subsequent packets according to the optimal path.

✚ ICMP Mask Response Message

Sometimes, a network device sends an ICMP mask request message to obtain the mask of a subnet. The network device that receives the ICMP mask request message sends a mask response message.

✚ Error Message for TTL Timeout

When forwarding an IP packet of which TTL expires, a device responds to the source end with an error message indicating exceeded TTL. To prevent attacks after the route is traced, the functionality of sending such error messages can be disabled.

↘ **Timestamp Query**

RFC 792 requires the system, after receiving an ICMP timestamp request query message, to return its current time. You can disable sending of such reply messages to avoid attacks aimed at time-based protocols. By this means, once received, ICMP timestamp request query messages are discarded.

Related Configuration

↘ **Enabling ICMP Protocol Unreachable Message**

- By default, the ICMP Protocol unreachable message function is enabled on an interface.
- You can run the **[no] ip unreachable** command to disable or enable the function.

↘ **Enabling ICMP Redirection Message**

- By default, the ICMP redirection message function is enabled on an interface.
- You can run the **[no] ip redirects** command to disable or enable the function.

↘ **Enabling ICMP Mask Response Message**

- By default, the ICMP mask response message function is enabled on an interface.
- You can run the **[no] ip mask-reply** command to disable or enable the function.

↘ **Enabling Error Message for TTL Timeout**

- By default, the error message for TTL timeout function is enabled.
- You can run the **[no] ip ttl-expires enable** command to disable or enable the function.

↘ **Enabling Timestamp Query**

- By default, the timestamp query function is enabled on an interface.
- You can run the **[no] ip icmp timestamp** command to disable or enable the function.

1.3.4 Limiting Transmission Rate of ICMP Error Packets

Working Principle

This function limits the transmission rate of ICMP error packets to prevent DoS attacks by using the token bucket algorithm.

If an IP packet needs to be fragmented but the Don't Fragment (DF) bit in the header is set to 1, the device sends an ICMP destination unreachable packet (code 4) to the source host. This ICMP error packet is used to discover the path MTU. When there are too many other ICMP error packets, the ICMP destination unreachable packet (code 4) may not be sent. As a result, the path MTU discovery function fails. To avoid this problem, you should limit the transmission rate of ICMP destination unreachable packets and other ICMP error packets respectively.

Related Configuration

↘ **Configuring the Transmission Rate of ICMP Destination Unreachable Packets Triggered by DF Bit in the IP Header**

- The default transmission rate is 10 packets every 100 milliseconds.
- The **ip icmp error-interval DF** command can be used to configure the transmission rate.

✚ **Configuring the Transmission Rate of Other ICMP Error Packets**

- The default transmission rate is 10 packets every 100 milliseconds.
- The **ip icmp error-interval** command can be used to configure the transmission rate.

1.3.5IP MTU

Working Principle

If an IP packet exceeds the IP MTU size, the FSOS software splits the packet. For all devices in the same physical network segment, the IP MTU of interconnected interfaces must be the same. You can adjust the link MTU of interfaces on FS products. After the link MTU of interfaces is changed, the IP MTU of interfaces will be changed. The IP MTU of interfaces automatically keeps consistent with the link MTU of interfaces. However, if the IP MTU of interfaces is adjusted, the link MTU of interfaces will not be changed.

Related Configuration

✚ **Setting the IP MTU**

- By default, the IP MTU of an interface is 1500.
- The **ip mtu** command can be used to set the IP packet MTU.

1.3.6IP TTL

Working Principle

An IP packet is transmitted from the source address to the destination address through routers. After a TTL value is set, the TTL value decreases by 1 every time when the IP packet passes a router. When the TTL value drops to zero, the router discards the packet. This prevents infinite transmission of useless packets and waste of bandwidth.

Related Configuration

✚ **Setting the IP TTL**

- By default, the IP TTL of an interface is 64.
- The **ip ttl** command can be used to set the IP TTL of an interface.

1.3.7Protecting IP Routed Ports

Working Principle

This command is used to forbid packets to come in and go out via the same routed port.

Related Configuration

✚ **Enabling Protection of IP Routed Ports**

- By default, protection of IP routed ports is disabled.
- The **ip redirect-drop** command can be used to enable or disable the function.

1.3.8IP Source Route

Working Principle

FS products support IP source routes. When a device receives an IP packet, it checks the options such as source route, loose source route, and record route in the IP packet header. These options are detailed in RFC 791. If the device detects that the packet enables one option, it responds; if the device detects an invalid option, it sends an ICMP parameter error message to the source and then discards the packet.

After the IP source route is enabled, the source route option is added to an IP packet to test the throughput of a specific network or help the packet bypasses the failed network. However, this may cause network attacks such as source address spoofing and IP spoofing.

Related Configuration

📌 **Configuring an IP Source Route**

- By default, the IP source route function is enabled.
- The **ip source-route** command can be used to enable or disable the function.

1.3.9 Specifying the Source Address of ICMP Packets

Working Principle

In a network with a large number of IP addresses configured, it is complex for receivers to recognize from which device ICMP packets are sent. To simplify the judgement, you can choose a specified address, like the address of the loopback interface, as the source address for ICMP packets.

Related Configuration

📌 **Specifying the Source Address of ICMP Packets**

- By default, no source address is configured for ICMP packets.
- In global configuration mode, use the **ip icmp source [vrf vrf-name] ip-address** command to specify the source address of ICMP packets.

1.4 Configuration

Configuration		Description and Command
Configuring the IP Addresses of an Interface	(Mandatory) It is used to configure an IP address and allow the IP protocol to run on an interface.	
	ip address	Manually configures the IP address of an interface.
	ip unnumbered	Borrows an IP address from another interface.
Configuring Broadcast Forwarding	(Optional) It is used to set an IP broadcast address and enable directed broadcast forwarding.	
	ip broadcast-address	Configures an IP broadcast address.
	ip directed-broadcast	Enables directed broadcast forwarding.
Configuring ICMP Forwarding	(Optional) It is used to enable ICMP packet forwarding.	
	ip unreachable	Enables ICMP unreachable messages and host unreachable messages.
	ip redirects	Enables ICMP redirection messages.

Configuration	Description and Command	
	ip mask-reply	Enables ICMP mask response messages.
	ip ttl-expires enable	Enables error messages for TTL timeout.
	ip icmp timestamp	Enables Timestamp Query.
Configuring the Transmission Rate of ICMP Error Packets	Optional.	
	ip icmp error-interval DF	Configures the transmission rate of ICMP destination unreachable packets triggered by the DF bit in the IP header.
	ip icmp error-interval	Configures the transmission rate of ICMP error packets and ICMP redirection packets.
Setting the IP MTU	(Optional) It is used to configure the IP MTU on an interface.	
	ip mtu	Sets the MTU value.
Setting the IP TTL	(Optional) It is used to configure the TTL of unicast packets and broadcast packets.	
	ip ttl	Sets the TTL value.
Configuring an IP Source Route	(Optional) It is used to check the source routes.	
	ip source-route	Enables the IP source route function.
<u>Specifying the Source Address of ICMP Packets</u>	(Optional) It is used to configure the source address of ICMP packets.	
	ip icmp source [vrf vrf-name] ip-address	Specifies the source address for ICMP packets.

1.4.1 Configuring the IP Addresses of an Interface

Configuration Effect

Configure the IP address of an interface for communication.

Notes

- N/A

Configuration Steps

↘ Configuring the IP Address of an Interface

- Mandatory
- Perform the configuration in L3 interface configuration mode.

↘ Obtaining the IP Address of an Interface through PPP Negotiation

- Optional
- If a point-to-point interface is not configured with an IP address, obtain an IP address through PPP negotiation.
- Perform the configuration in L3 interface configuration mode.

↘ Borrowing an IP Addresses from Another Interface

- Optional

- If a point-to-point interface is not configured with an IP address, borrow an IP address from another interface.
- Perform the configuration in L3 interface configuration mode.

Verification

Run the **show ip interface** command to check whether the configuration takes effect.

Related Commands

↘ Manually Configuring the IP Address of an Interface

Command	ip address <i>ip-address network-mask</i> [secondary]
Parameter Description	<i>ip-address</i> : 32-bit IP address, with 8 bits for each group. The IP address is expressed in decimal and groups are separated by a full stop (.). <i>network-mask</i> : 32-bit network mask. Value 1 indicates the mask bit and 0 indicates the host bit. Every 8 bits form one group. The network mask is expressed in decimal and groups are separated by a full stop (.). secondary : Secondary IP address.
Command Mode	Interface configuration mode
Usage Guide	N/A

↘ Borrowing an IP Addresses from Another Interface

Command	ip unnumbered <i>interface-type interface-number</i>
Parameter Description	<i>interface-type</i> : Interface type. <i>interface-number</i> : Interface ID.
Command Mode	Interface configuration mode
Usage Guide	<p>An unnumbered interface indicates that the interface is enabled with the IP protocol without an IP address assigned. An unnumbered interface needs to be associated with an interface configured with an IP address. For an IP packet generated on an unnumbered interface, the source IP address of the packet is the IP address of the associated interface. In addition, the routing protocol process decides whether to send a route update packet to the unnumbered interface according to its associated IP address. If you want to use an unnumbered interface, pay attention to the following limitations:</p> <p>An Ethernet interface cannot be set to an unnumbered interface.</p> <p>When a serial interface encapsulates SLIP, HDLC, PPP, LAPB, and Frame-Relay, the serial interface can be set to an unnumbered interface. During Frame-Relay encapsulation, however, only a point-to-point interface can be configured as an unnumbered interface. AnX.25 interface cannot be configured as an unnumbered interface.</p> <p>The ping command cannot be used to check whether an unnumbered interface is working properly because an unnumbered interface is not configured with an IP address. However, you can monitor the status of an unnumbered interface remotely through SNMP.</p> <p>A device cannot be cold started through an unnumbered interface.</p>

Configuration Example

↘ Configuring an IP Address for an Interface

Configuration Steps	Configure IP address 192.168.23.110 255.255.255.0 on interface GigabitEthernet 0/0.
	<pre>FS#configure terminal FS(config)#interface gigabitEthernet 0/0 FS(config-if-GigabitEthernet 0/0)# no switchport FS(config-if-GigabitEthernet 0/0)#ip address 192.168.23.110 255.255.255.0</pre>
Verification	Run the show ip interface command to check whether the configuration takes effect.
	<pre>FS# show ip interface gigabitEthernet 0/0 GigabitEthernet 0/0 IP interface state is: UP IP interface type is: BROADCAST IP interface MTU is: 1500 IP address is: 192.168.23.110/24 (primary)</pre>

1.4.2 Configuring Broadcast Forwarding

Configuration Effect

Set the broadcast address of an interface to 0.0.0.0 and enable directed broadcast forwarding.

Notes

N/A

Configuration Steps

↘ Configuring an IP Broadcast Address

- (Optional) Some old hosts may identify broadcast address 0.0.0.0 only. In this case, set the broadcast address of the target interface to 0.0.0.0.
- Perform the configuration in L3 interface configuration mode.

↘ Enabling Directed Broadcast Forwarding

- (Optional) If you want to enable a host to send broadcast packets to all hosts in a domain that it is not in, enable directed broadcast forwarding.
- Perform the configuration in L3 interface configuration mode.

Verification

Run the **show running-config interface** command to check whether the configuration takes effect.

Related Commands

↘ Configuring an IP Broadcast Address

Command	ip broadcast-address <i>ip-address</i>
Parameter Description	<i>ip-address</i> : Broadcast address of an IP network.
Command Mode	Interface configuration mode
Usage Guide	Generally, the destination address of IP broadcast packets is all 1s, which is expressed as 255.255.255.255. The FSOS software can generate broadcast packets of other IP addresses through definition and receive self-defined broadcast packets and the broadcast packets with address 255.255.255.255.

▾ **Allowing Forwarding of Directed Broadcast Packets**

Command	ip directed-broadcast [<i>access-list-number</i>]
Parameter Description	<i>access-list-number</i> : Access list number, ranging from 1 to 199 and from 1300 to 2699. After an ACL is defined, only directed broadcast packets that match the ACL are forwarded.
Command Mode	Interface configuration mode
Usage Guide	If the no ip directed-broadcast command is run on an interface, the FSOS software will discard directed broadcast packets received from the network that is directly connected.

Configuration Example

Configuration Steps	<p>On interface gigabitEthernet 0/1, set the destination address of IP broadcast packets to 0.0.0.0 and enable directed broadcast forwarding.</p> <pre> FS#configure terminal FS(config)#interface gigabitEthernet 0/1 FS(config-if-GigabitEthernet 0/1)# no switchport FS(config-if-GigabitEthernet 0/1)#ip broadcast-address 0.0.0.0 FS(config-if-GigabitEthernet 0/1)#ip directed-broadcast </pre>
Verification	<p>Run the show ip interface command to check whether the configuration takes effect.</p> <pre> FS#show running-config interface gigabitEthernet 0/1 ip directed-broadcast ip broadcast-address 0.0.0.0 </pre>

1.4.3 Configuring ICMP Forwarding

Configuration Effect

Enable ICMP unreachable messages, ICMP redirection messages, and mask response messages on an interface.

Notes

N/A

Configuration Steps

▾ **Enabling ICMP Unreachable Messages**

- By default, ICMP unreachable messages are enabled.
- Optional)The **no ip unreachable** command can be used to disable ICMP unreachable messages.
- Perform the configuration in L3 interface configuration mode.

↘ **Enabling ICMP Redirection Messages**

- By default, ICMP redirection messages are enabled.
- Optional)The **no ip redirects** command can be used to disable ICMP redirection messages.
- Perform the configuration in L3 interface configuration mode.

↘ **Enabling ICMP Mask Response Messages**

- By default, ICMP mask response messages are enabled.
- Optional)The **no ip mask-reply** command can be used to disable ICMP mask response messages.
- Perform the configuration in L3 interface configuration mode.

↘ **Enabling Error Messages for TTL Timeout**

- By default, error messages for TTL timeout are enabled.
- (Optional) The **no ip ttl-expires enable** command can be used to disable error messages for TTL timeout.
- Perform the configuration in global configuration mode.

↘ **Enabling Timestamp Query**

- By default, timestamp query is enabled.
- (Optional) The **no ip icmp timestamp** command can be used to disable timestamp query.
- Perform the configuration in global configuration mode.

Verification

Run the **show ip interface** command to check whether the configuration takes effect.

Run the **show running-config** command to check whether error messages for TTL timeout are disabled.

Run the **show running-config** command to check whether timestamp query is disabled.

Related Commands

↘ **Enabling ICMP Unreachable Messages**

Command	ip unreachable
Parameter	N/A
Description	
Command Mode	Interface configuration mode
Usage Guide	N/A

↘ **Enabling ICMP Redirection Messages**

Command	ip redirects
----------------	---------------------

Parameter Description	N/A
Command Mode	Interface configuration mode
Usage Guide	N/A

↘ **Enabling ICMP Mask Response Messages**

Command	ip mask-reply
Parameter Description	N/A
Command Mode	Interface configuration mode
Usage Guide	N/A

↘ **Enabling Error Messages for TTL Timeout**

Command	no ip ttl-expires enable
Parameter Description	N/A
Command Mode	Global configuration mode
Usage Guide	N/A

↘ **Enabling Timestamp Query**

Command	no ip icmp timestamp
Parameter Description	N/A
Command Mode	Global configuration mode
Usage Guide	N/A

Configuration Example

Configuration Steps	Enable ICMP unreachable messages, ICMP redirection messages, and mask response messages on interface gigabitEthernet 0/1.
----------------------------	---

	<pre> FS#configure terminal FS(config)# no ip ttl-expires enable FS(config)#interface gigabitEthernet 0/1 FS(config-if-GigabitEthernet 0/1)# no switchport FS(config-if-GigabitEthernet 0/1)# ip unreachable FS(config-if-GigabitEthernet 0/1)# ip redirects FS(config-if-GigabitEthernet 0/1)# ip mask-reply </pre>
Verification	<p>Run the show ip interface command to check whether the configuration takes effect.</p>
	<pre> FS#show running-config include ip ttl-expires enable no ip ttl-expires enable FS#show ip interface gigabitEthernet 0/1 GigabitEthernet 0/1 ICMP mask reply is: ON Send ICMP redirect is: ON Send ICMP unreachable is: ON </pre>

1.4.4 Configuring the Transmission Rate of ICMP Error Packets

Configuration Effect

Configure the transmission rate of ICMP error packets.

Notes

N/A

Configuration Steps

📌 Configuring the Transmission Rate of ICMP Destination Unreachable Packets Triggered by the DF Bit in the IP Header

- Optional
- Perform the configuration in global configuration mode.

📌 Configuring the Transmission Rate of Other ICMP Error Packets

- Optional
- Perform the configuration in global configuration mode.

Verification

Run the **show running-config** command to check whether the configuration takes effect.

Related Commands

📌 Configuring the Transmission Rate of ICMP Destination Unreachable Packets Triggered by the DF Bit in the IP Header

Command	ip icmp error-interval DF milliseconds [bucket-size]
Parameter Description	<p><i>milliseconds</i>: Refresh cycle of a token bucket. The value range is from 0 to 2,147,483,647 and the default value is 100 milliseconds. When the value is 0, the transmission rate of ICMP error packets is not limited.</p> <p><i>bucket-size</i>: Number of tokens contained in a token bucket. The value range is from 1 to 200 and the default value is 10.</p>
Command Mode	Global configuration mode.
Usage Guide	<p>This function limits the transmission rate of ICMP error packets to prevent DoS attacks by using the token bucket algorithm.</p> <p>If an IP packet needs to be fragmented but the DF bit in the header is set to 1, the device sends an ICMP destination unreachable packet (code 4) to the source host. This ICMP error packet is used to discover the path MTU. When there are too many other ICMP error packets, the ICMP destination unreachable packet (code 4) may not be sent. As a result, the path MTU discovery function fails. To avoid this problem, you should limit the transmission rate of ICMP destination unreachable packets and other ICMP error packets respectively.</p> <p>It is recommended to set the refresh cycle to integral multiples of 10 milliseconds. If the refresh cycle is set to a value greater than 0 and smaller than 10 milliseconds, the refresh cycle that actually takes effect is 10 milliseconds. For example, if the refresh rate is set to 1 per 5 milliseconds, the refresh rate that actually takes effect is 2 per 10 milliseconds. If the refresh cycle is not integral multiples of 10 milliseconds, the refresh cycle that actually takes effect is automatically converted to integral multiples of 10 milliseconds. For example, if the refresh rate is set to 3 per 15 milliseconds, the refresh rate that actually takes effect is 2 per 10 milliseconds.</p>

📌 Configuring the Transmission Rate of Other ICMP Error Packets

Command	ip icmp error-interval milliseconds [bucket-size]
Parameter Description	<p><i>milliseconds</i>: Refresh cycle of a token bucket. The value range is 0 to 2,147,483,647, and the default value is 100 (ms). When the value is 0, the transmission rate of ICMP error packets is not limited.</p> <p><i>bucket-size</i>: Number of tokens contained in a token bucket. The value range is 1 to 200 and the default value is 10.</p>
Command Mode	Global configuration mode.
Usage Guide	<p>This function limits the transmission rate of ICMP error packets to prevent DoS attacks by using the token bucket algorithm.</p> <p>It is recommended to set the refresh cycle to integral multiples of 10 milliseconds. If the refresh cycle is set to a value greater than 0 and smaller than 10 milliseconds, the refresh cycle that actually takes effect is 10 milliseconds. For example, if the refresh rate is set to 1 per 5 milliseconds, the refresh rate that actually takes effect is 2 per 10 milliseconds. If the refresh cycle is not integral multiples of 10 milliseconds, the refresh cycle that actually takes effect is automatically converted to integral multiples of 10 milliseconds. For example, if the refresh rate is set to 3 per 15 milliseconds, the refresh rate that actually takes effect is 2 per 10 milliseconds.</p>

Configuration Example

Configuration Steps	Set the transmission rate of ICMP destination unreachable packets triggered the DF bit in IP header to 100 packets per second and the transmission rate of other ICMP error packets to 10 packets per second.
	<pre>FS(config)# ip icmp error-interval DF 1000 100 FS(config)# ip icmp error-interval 1000 10</pre>
Verification	Run the show running-config command to check whether the configuration takes effect.

```
FS#show running-config | include ip icmp error-interval
ip icmp error-interval 1000 10
ip icmp error-interval DF 1000 100
```

1.4.5 Setting the IP MTU

Configuration Effect

Adjust the IP packet MTU.

Notes

N/A

Configuration Steps

- (Optional) When the IP MTU of interconnected interfaces is different on devices in the same physical network segment, set the IP MTU to the same value.
- Perform the configuration in L3 interface configuration mode.

Verification

Run the **show ip interface** command to check whether the configuration takes effect.

Related Commands

↘ Setting the IP MTU

Command	ip mtu bytes
Parameter Description	bytes: IP packet MTU. The value range is from 68 to 1,500 bytes.
Command Mode	Interface configuration mode
Usage Guide	N/A

Configuration Example

Configuration Steps	Set the IP MTU of interface gigabitEthernet 0/1 to 512 bytes.
	<pre>FS#configure terminal FS(config)#interface gigabitEthernet 0/1 FS(config-if-GigabitEthernet 0/1)# no switchport FS(config-if-GigabitEthernet 0/1)#ip mtu 512</pre>
Verification	Run the show ip interface command to check whether the configuration takes effect.
	<pre>FS# show ip interface gigabitEthernet 0/1 IP interface MTU is: 512</pre>

1.4.6 Setting the IP TTL

Configuration Effect

Modify the IP TTL value of an interface.

Notes

N/A

Configuration Steps

- Optional
- Perform the configuration in L3 interface configuration mode.

Verification

Run the **show run-config** command to check whether the configuration takes effect.

Related Commands

▾ Setting the IP TTL

Command	<code>ip ttl value</code>
Parameter Description	<i>value</i> : TTL value. The value range is from 0 to 255.
Command Mode	Global configuration mode.
Usage Guide	N/A

Configuration Example

Configuration Steps	<ul style="list-style-type: none"> ● Set the TTL of unicast packets to 100.
	<pre>FS#configure terminal FS(config)#ip ttl 100</pre>
Verification	Run the show run-config command to check whether the configuration takes effect.
	<pre>FS#show running-config ip ttl 100</pre>

1.4.7 Configuring Protection of IP Routed Ports

Configuration Effect

Enable or disable protection of IP routed ports.

Notes

This configuration is supported on Layer 3 routed ports.

Configuration Steps

- By default, protection of IP routed ports is disabled.
- (Optional) The **ip redirect-drop** command can be used to enable or disable the function.

Verification

Run the **show run-config** command to check whether the configuration takes effect.

Related Commands

▾ **Configuring Protection of IP Routed Ports**

Command	ip redirect-drop
Parameter	N/A
Description	
Command Mode	Interface configuration mode.
Usage Guide	N/A

Configuration Example

Configuration Steps	<ul style="list-style-type: none"> ● Requires packets coming in via the fastEthernet 0/1 interface to go out via other routed ports .
	<pre>FS(config)#interface gigabitEthernet 0/1 FS(config-if-GigabitEthernet 0/1)#ip redirect-drop</pre>
Verification	Run the show run-config command to check whether the configuration takes effect.
	<pre>FS#show running-config ip redirect-drop</pre>

1.4.8Configuring an IP Source Route

Configuration Effect

Enable or disable the IP source route function.

Notes

N/A

Configuration Steps

- By default, the IP source route function is enabled.
- Optional) The **no ip source-route** command can be use to disable the IP source route function.

Verification

Run the **show run-config** command to check whether the configuration takes effect.

Related Commands

▾ **Configuring an IP Source Route**

Command	ip source-route
Parameter	N/A
Description	
Command Mode	Global configuration mode.
Usage Guide	N/A

Configuration Example

Configuration Steps	<ul style="list-style-type: none"> ● Disable the IP source route function.
	<pre>FS#configure terminal FS(config)#no ip source-route</pre>
Verification	Run the show run-config command to check whether the configuration takes effect.
	<pre>FS#show running-config no ip source-route</pre>

1.4.9 Specifying the Source Address of ICMP Packets

Configuration Effect

Choose a specific address as the source address for ICMP packets.

Notes

N/A

Configuration Steps

▾ Specifying the Source Address of ICMP Packets

- Optional
- Set a source address for ICMP packets in global configuration mode.

Verification

After the configuration, the specified address is used as the source address for ICMP reply packets.

Related Commands

▾ Specifying the Source Address of ICMP Packets

Command	ip icmp source [vrf vrf-name] ip-address
Parameter Description	N/A
Command Mode	Global configuration mode
Usage Guide	In a network with a large number of IP addresses configured, it is complex for receivers to recognize from which device ICMP packets are sent. To simplify the judgement, you can choose a specified address, like the address of the loopback

	interface, as the source address for ICMP packets.
--	--

Configuration Example

Configuration Steps	<ul style="list-style-type: none">● Configure the source address for ICMP packets.
	<pre>FS(config)# ip icmp source 192.168.1.1</pre>
Verification	Run the show run-config command to check whether the configuration takes effect.

```
Building configuration...
Current configuration : 4438 bytes

version 11.0(5)B9P23
hostname S6220-H_2
!
load-balance-profile FS
    hash-disturb 5
!
no spanning-tree
!
expert access-list extended 2704
!
expert access-list extended 2705
!
ip vrf VRF-A
    rd 100:1
    route-target both 100:1
!
username FS privilege 15 password FS
!
install 0 RG-S6220-48XT6QXS-H
!
sysmac 5869.6c9d.b47c
!
nfpp
!
ip icmp source 192.168.1.1
!
.....
```

1.5 Monitoring

Displaying

Description	Command
Displays the IP address of an interface.	show ip interface [<i>interface-type</i> <i>interface-number</i> brief]
Displays IP packet statistics.	show ip packet statistics [total <i>interface-name</i>]
Displays statistics of IP packets on an interface.	show ip interface-statistics [<i>interface-name</i>] { ipv4 ipv6 }
Displays statistics on sent and received IP packets in the protocol stack.	show ip packet queue

2 Configuring ARP

2.1 Overview

In a local area network (LAN), each IP network device has two addresses: 1) local address. Since the local address is contained in the header of the data link layer (DLL) frame, it is a DLL address. However, it is processed by the MAC sublayer at the DLL and thereby is usually called the MAC address. MAC addresses represent IP network devices on LANs. 2) network address. Network addresses on the Internet represent IP network devices and also indicate the networks where the devices reside.

In a LAN, two IP devices can communicate with each other only after they learn the 48-bit MAC address of each other. The process of obtaining the MAC address based on the IP address is called address resolution. There are two types of address resolution protocols: 1) Address Resolution Protocol (ARP); 2) Proxy ARP. ARP and Proxy ARP are described respectively in RFC 826 and RFC 1027.

ARP is used to bind the MAC address with the IP address. When you enter an IP address, you can learn the corresponding MAC address through ARP. Once the MAC address is obtained, the IP-MAC mapping will be saved to the ARP cache of the network device. With the MAC address, the IP device can encapsulate DLL frames and send them to the LAN. By default, IP and ARP packets on the Ethernet are encapsulated in Ethernet II frames.

Protocols and Standards

- RFC 826: An Ethernet Address Resolution Protocol
- RFC 1027: Using ARP to implement transparent subnet gateways

2.2 Applications

Application	Description
LAN-based ARP	A user learns the MAC addresses of other users in the same network segment through ARP.
Proxy ARP-based Transmission	Transparent With Proxy ARP, a user can directly communicate with users in another network without knowing that it exists.

2.2.1 LAN-based ARP

Scenario

ARP is required in all IPv4 LANs.

- A user needs to learn the MAC addresses of other users through ARP to communicate with them.

Figure 2- 1

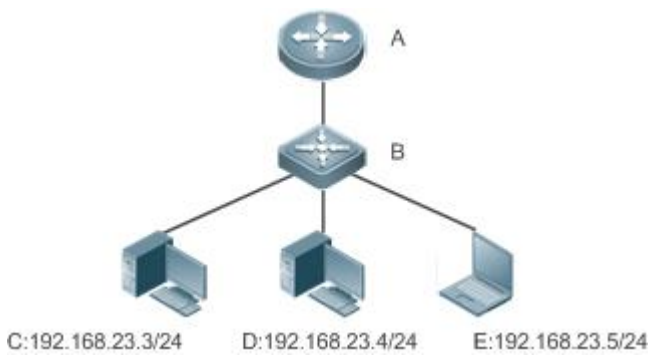

Remarks	A is a router. B is a switch. It acts as the gateway. C, D, and E are hosts.
----------------	--

Deployment

- Enable ARP in a LAN to implement IP-MAC mapping.

2.2.2 Proxy ARP-based Transparent Transmission

Scenario

Transparent transmission across IPv4 LANs is performed.

- Enable Proxy ARP on the router to achieve direct communication between users in different network segments.

Figure 2- 2

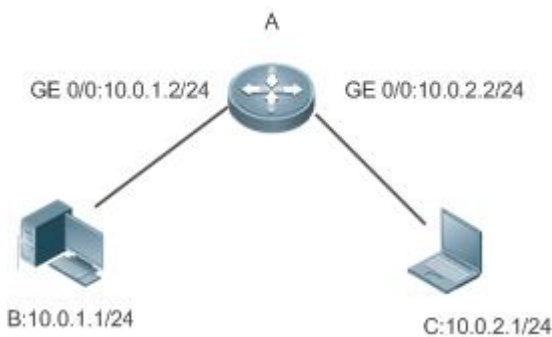

Remarks	A is a router connecting two LANs. B and C are hosts in different subnets. No default gateway is configured for them.
----------------	--

Deployment

- Enable Proxy ARP on the subnet gateway. After configuration, the gateway can act as a proxy to enable a host without any route information to obtain MAC addresses of IP users in other subnets.

2.3 Features

Overview

Feature	Description
---------	-------------

Static ARP	Users can manually specify IP-MAC mapping to prevent the device from learning incorrect ARP entries.
ARP Attributes	Users can specify the ARP entry timeout, ARP request retransmission times and interval, and maximum number of unresolved ARP entries.
Gratuitous ARP	Gratuitous ARP is used to detect IP address conflicts and enable peripheral devices to update ARP entries.
Proxy ARP	A proxy replies to the ARP requests from other devices in different subnets.
Local Proxy ARP	A proxy replies to the ARP requests from other devices in the same subnet.
Any IP ARP	Users can access the network without changing the IP address and gateway.
ARP Trustworthiness Detection	Neighbor Unreachable Detection (NUD) is used to ensure that correct ARP entries are learned.
Scheduled Automatic ARP Scanning	Enable scheduled automatic ARP scanning on neighbors in the LAN.
ARP-based IP Guard	You can set the number of IP packets for triggering ARP drop to prevent a large number of unknown unicast packets from being sent to the CPU.
Refraining from Sending ARP Requests to Authentication VLANs	The device refrains from sending ARP broadcast requests to authentication VLANs to reduce the number of ARP broadcast requests in the network.
ARP VXLAN-related Functions	Enable automatic ARP entry learning, ARP requests, and gratuitous ARP request suppression.
Fast Aging of ARP Entries	Enable fast aging of fast aging of ARP entries on an interface.
Fast Removal of ARP Entries	Enable fast removal of ARP entries when L2 ports get down.
Passive ARP Response Packet Learning	Users can enable active ARP response packet learning
ARP Probe upon MAC Address Flapping	Users can enable ARP probe upon MAC address flapping.

2.3.1 Static ARP

Static ARP entries can be configured manually or assigned by the authentication server. The manually configured ones prevail. Static ARP can prevent the device from learning incorrect ARP entries.

Working Principle

If static ARP entries are configured, the device does not actively update ARP entries and these ARP entries permanently exist.

When the device forwards Layer-3 packets, the static MAC address is encapsulated in the Ethernet header as the destination MAC address.

Related Configuration

📌 Enabling Static ARP

Run the **arp [vrf name] ip-address mac-address type** command in global configuration mode to configure static ARP entries. By default, no static ARP entry is configured. Users can bind static ARP entries to individual VRF instances or the global VRF instance. ARP encapsulation supports only the Ethernet II type, which is represented by ARPA.

2.3.2 ARP Attributes

Users can specify the ARP timeout, ARP request retransmission interval and times, maximum number of unresolved ARP entries, and maximum number of ARP entries on an interface.

Working Principle

↳ ARP Timeout

The ARP timeout only applies to the dynamically learned IP-MAC mapping. When the ARP entry timeout expires, the device sends a unicast ARP request packet to detect whether the peer end is online. If it receives an ARP reply from the peer end, it does not delete this ARP entry. Otherwise, the device deletes this ARP entry.

When the ARP timeout is set to a smaller value, the mapping table stored in the ARP cache is more accurate but ARP consumes more network bandwidth.

↳ ARP Request Retransmission Interval and Times

The device consecutively sends ARP requests to resolve an IP address to a MAC address. The shorter the retransmission interval is, the faster the resolution is. The more times the ARP request is retransmitted, the more likely the resolution will succeed and the more bandwidth ARP will consume.

↳ Maximum Number of Unresolved ARP Entries

In a LAN, ARP attacks and scanning may cause a large number of unresolved ARP entries generated on the gateway. As a result, the gateway fails to learn the MAC addresses of the users. To prevent such attacks, users can configure the maximum number of unresolved ARP entries.

↳ Maximum Number of ARP Entries on an Interface

Configure the maximum number of ARP entries on a specified interface to prevent ARP entry resource waste.

Related Configuration

↳ Configuring the ARP Timeout

Run the **arp timeout** *seconds* command in interface configuration mode to configure the ARP timeout. The default timeout is 3,600 seconds. You can change it based on actual situations.

↳ Configuring the ARP Request Retransmission Interval and Times

- Run the **arp retry interval** *seconds* command in global configuration mode to configure the ARP request retransmission interval. The default interval is 1 second. You can change it based on actual situations.
- Run the **arp retry times** *number* command in global configuration mode to configure the ARP request retransmission times. The default number of retransmission times is 5. You can change it based on actual situations.

↳ Configuring the Maximum Number of Unresolved ARP Entries

Run the **arp unresolve** *number* command in global configuration mode to configure the maximum number of unresolved ARP entries. The default value is the maximum number of ARP entries supported by the device. You can change it based on actual situations.

↳ Configuring the Maximum Number of ARP Entries on an Interface

Run the **arp cache interface-limit** *limit* command in interface configuration mode to configure the maximum number of ARP entries learned on an interface. The default number is 0. You can change it based on actual situations. This command also applies to static ARP entries.

2.3.3 Gratuitous ARP

Working Principle

Gratuitous ARP packets are a special type of ARP packets. In a gratuitous ARP packet, the source and destination IP addresses are the IP address of the local device. Gratuitous ARP packets have two purposes:

1. IP address conflict detection. If the device receives a gratuitous packet and finds the IP address in the packet the same as its own IP address, it sends an ARP reply to notify the peer end of the IP address conflict.
2. ARP update. When the MAC address of an interface changes, the device sends a gratuitous ARP packet to notify other devices to update ARP entries.

The device can learn gratuitous ARP packets. After receiving a gratuitous ARP packet, the device checks whether the corresponding dynamic ARP entry exists. If yes, the device updates the ARP entry based on the information carried in the gratuitous ARP packet.

Related Configuration

↳ Enabling Gratuitous ARP

Run the **arp gratuitous-send interval** *seconds* [*number*] command in interface configuration mode to enable gratuitous ARP. This function is disabled on interfaces by default. Generally you need to enable this function on the gateway interface to periodically update the MAC address of the gateway on the downlink devices, which prevents others from faking the gateway.

2.3.4 Proxy ARP

Working Principle

The device enabled with Proxy ARP can help a host without any route information to obtain MAC addresses of IP users in other subnets. For example, if the device receiving an ARP request finds the source IP address in a different network segment from the destination IP address and knows the route to the destination address, the device sends an ARP reply containing its own Ethernet MAC address. This is how Proxy ARP works.

Related Configuration

↳ Enabling Proxy ARP

- Run the **ip proxy-arp** command in interface configuration mode to enable Proxy ARP.
- This function is disabled by default.

2.3.5 Local Proxy ARP

Working Principle

Local Proxy ARP means that a device acts as a proxy in the local VLAN (common VLAN or sub VLAN).

After local Proxy ARP is enabled, the device can help users to obtain the MAC addresses of other users in the same subnet. For example, when port protection is enabled on the device, users connected to different ports are isolated at Layer 2. After local Proxy

ARP is enabled, the device receiving an ARP request acts as a proxy to send an ARP reply containing its own Ethernet MAC address. In this case, different users communicate with each other through Layer-3 routes. This is how local Proxy ARP works.

Related Configuration

↳ Enabling Local Proxy ARP

- Run the **local-proxy-ar** command in interface configuration mode to enable local Proxy ARP.
- This function is disabled by default.
- This command is supported only on switch virtual interfaces (SVIs).

2.3.6 Any IP ARP

Working Principle

If any IP ARP is enabled, users can access the network with any IP address. This applies when a user is using his own laptop in a hotel and wants to access the network without changing the IP address and gateway. If the gateway receiving an ARP request finds the source IP address in a different subnet and the destination address possibly not its own address, the gateway still sends an ARP reply and creates a direct route for the user.

Related Configuration

↳ Enabling Any IP ARP

Run the **arp any-ip** command in interface configuration mode to enable any IP ARP. This function is disabled on interfaces by default.

2.3.7 ARP Trustworthiness Detection

Working Principle

The **arp trust-monitor enable** command is used to enable anti-ARP spoofing to prevent excessive useless ARP entries from occupying device resources. After ARP trustworthiness detection is enabled on a Layer-3 interface, the device receives ARP request packets from this interface:

1. If the corresponding entry does not exist, the device creates a dynamic ARP entry and performs NUD after 1 to 5 seconds. That is, the device begins to age the newly learned ARP entry and sends a unicast ARP request. If the device receives an ARP update packet from the peer end within the aging time, it stores the entry. If not, it deletes the entry.
2. If the corresponding ARP entry exists, NUD is not performed.
3. If the MAC address in the existing dynamic ARP entry is updated, the device also performs NUD.

Since this function adds a strict confirmation procedure in the ARP learning process, it affects the efficiency of ARP learning.

After this function is disabled, NUD is not required for learning and updating ARP entries.

Related Configuration

↳ Enabling ARP Trustworthiness Detection

Run the **arp trust-monitor enable** command in interface configuration mode to enable ARP trustworthiness detection. This function is disabled by default.

2.3.8 Scheduled Automatic ARP Scanning

Working Principle

When scheduled automatic ARP scanning is enabled, the network segment configured on the interface is scanned in a scheduled manner to learn the ARP entries of neighbors. The scanning interval ranges from 1 to 30 minutes, and the default interval is 5 minutes. The scanning rate ranges from 1 to 100 pps, and the default rate is 20 pps.

Related Configuration

▾ Configuring ARP Scanning

- Run the **arp scan auto** *start-ip-address end-ip-address* command in interface configuration mode to enable scheduled automatic ARP scanning. By default, this function is disabled.
- Run the **arp scan interval** *minutes* command in global configuration mode to configure the scanning interval.
- Run the **arp scan rate** *rate-value* command in global configuration mode to configure the scanning rate.

2.3.9 ARP-based IP Guard

Working Principle

When receiving unresolved IP packets, the switch cannot forward them through the hardware and thereby need to send them to the CPU for address resolution. If a large number of such packets are sent to the CPU, the CPU will be congested, affecting other services on the switch.

After ARP-based IP guard is enabled, the switch receiving ARP request packets counts the number of packets in which the destination IP address hits this ARP entry. If this number is equal to the configured number, the switch sets a drop entry in the hardware so that the hardware will not send the packets with this destination IP address to the CPU. After the address resolution is complete, the switch continues to forward the packets with this destination IP address.

Related Configuration

▾ Enabling ARP-based IP Guard

- Run the **arp anti-ip-attack** command in global configuration mode to configure the number of IP packets for triggering ARP drop.
- By default, the switch discards the corresponding ARP entry after it receives three unknown unicast packets containing the same destination IP address.

2.3.10 Refraining from Sending ARP Requests to Authentication VLANs

Working Principle

In gateway authentication mode, all sub VLANs in a Super VLAN are authentication VLANs by default. Users in an authentication VLAN have to pass authentication to access the network. After authentication, a static ARP entry is generated on the device. Therefore, when accessing an authenticated user, the device does not need to send ARP requests to the authentication VLAN. If the device attempts to access users in an authentication-exemption VLAN, it only needs to send ARP requests to the authentication-exemption VLAN.

In gateway authentication mode, this function is enabled on the device by default. If the device needs to access authentication-exemption users in an authentication VLAN, disable this function.

Related Configuration

↘ Refraining from Sending ARP Requests to Authentication VLANs

- Run the **arp suppress-auth-vlan-req** command in interface configuration mode to refrain from sending ARP requests to authentication VLANs.
- This function is enabled by default.

2.3.11 ARP VXLAN-related Functions

Working Principle

In the VXLAN+SDN environment, the ARP module provides the following functions to adapt to the SDN controller:

1. Enabling/disabling automatic ARP entry learning on Overlay router interfaces: When the SDN controller is used to deliver ARP entries to the device in a unified manner, run the **no arp vxlan learning-enable** command to disable the function. In this case, the device does not learn or update ARP entries based on the received ARP packets.
2. Enabling/disabling SDN controller response to ARP requests: When the SDN controller needs to manage ARP packets in a unified manner, run the **arp vxlan sdn-reply** command to enable the function. In this case, ARP requests are copied to the SDN controller for responses.
3. Enabling/disabling gratuitous ARP request suppression on Overlay router interfaces: To prevent the problem that some terminals no longer send ARP requests to the SDN controller after learning the ARP entries from the gratuitous ARP request packets sent by the Overlay network gateway, run the **arp vxlan suppress gratuitous arp** command to enable gratuitous ARP request suppression on Overlay router interfaces.
4. Enabling/disabling Overlay router interfaces to actively send gratuitous ARP request packets: To prevent the problem that aging of the virtual MAC address of the overlay network gateway could lead to flooding of VXLAN-related traffic and thus affect device performance, enable Overlay router interfaces to actively send gratuitous ARP request packets.
5. Enabling/disabling generating of host routes after EVPN synchronizes ARP or ND entries to Overlay router interfaces.

For details about how to configure VXLAN, see *VXLAN-SCG.doc*.

2.3.12 ARP Packet Statistics Collection

Working Principle

The device counts the total numbers of sent/received ARP requests/responses and packets of unknown types on all interfaces from power-on.

2.3.13 ARP Packet Rate Statistics Collection

Working Principle

The device measures, at a minimum interval of 1s, the rate of ARP requests, ARP responses, and packets of unknown types received on each interface in a period of time.

2.3.14 Enabling Fast Aging of ARP Entries

Working Principle

ARP entries cannot be learned under unusual circumstances. After MAC addresses age, ARP entries age fast so as to achieve fast route convergence.

Related Configuration

↳ Enabling Fast Aging of ARP Entries

- In interface configuration mode, run the **arp fast-aging enable** command to enable fast aging of ARP entries.
- By default, this function is disabled.

2.3.15 Enabling Fast Removal of ARP Entries

Working Principle

When L2 ports get down, their corresponding ARP entries are fast deleted for fast routing convergence.

Related Configuration

↳ Enabling Fast Removal of ARP Entries

- In interface configuration mode, run the **arp l2port-down fast-delete** command to enable fast removal of ARP entries.
- By default, this function is disabled.

2.3.16 Enabling Passive ARP Response Packet Learning

Working Principle

The device does not learn ARP response packets when it does not send ARP request packets by default. Run the **arp reply-auto-learning enable** command to enable passive ARP response packet learning.

Related Configuration

↳ Enabling Passive ARP Response Packet Learning

- Run the **arp reply-auto-learning enable** command in global configuration mode to enable passive ARP response packet learning.

2.3.17 Enabling ARP Probe upon MAC Address Flapping

Working Principle

If MAC address flapping occurs, namely, the layer-2 interface changes and is inconsistent with the interface recorded in the ARP entry, the device will continue to send ARP request packets to probe the actual interface until the probe succeeds.

Related Configuration

↳ Enabling ARP Probe upon MAC Address Flapping

- Run the **arp mac-flapping resolve enable** command in global configuration mode to enable ARP probe upon MAC address flapping.









↳ Configuring ARP Probe Interval upon MAC Address Flapping









- Run the **arp mac-flapping resolve interval [seconds]** command in global configuration mode to configure ARP probe interval upon MAC address flapping.

↳ Configuring ARP Probe Count upon MAC Address Flapping

- Run the **arp mac-flapping resolve times** [number] command in global configuration mode to configure ARP probe count upon MAC address flapping.

2.4 Configuration

Configuration	Description and Command
Enabling Static ARP	 (Optional) It is used to enable static IP-MAC binding.
	arp Enables static ARP.
Configuring ARP Attributes	 (Optional) It is used to specify the ARP timeout, ARP request retransmission interval and times, maximum number of unresolved ARP entries, and maximum number of ARP entries on an interface.
	arp timeout Configures the ARP timeout.
	arp retry interval Configures the ARP request retransmission interval.
	arp unresolve Configures the maximum number of unresolved ARP entries.
Enabling Gratuitous ARP	 (Optional) It is used to detect IP address conflicts and enables peripheral devices to update ARP entries.
	arp gratuitous-send interval Enables gratuitous ARP.
Enabling Proxy ARP	 (Optional) It is used to act as a proxy to reply to ARP requests from the devices in different subnets.
	ip proxy-arp Enables Proxy ARP.
Enabling Local Proxy ARP	 (Optional) It is used to act as a proxy to reply to ARP requests from other devices in the same subnet.
	local-proxy-arp Enables local Proxy ARP.
Enabling Any IP ARP	 (Optional) It is used to allow users to access the network without changing the IP address and gateway.
	arp any-ip Enables any IP ARP.
Enabling ARP Trustworthiness Detection	 (Optional) It is used to unicast ARP request packets to ensure that correct ARP entries are learned.
	arp trust-monitor enable Enables ARP trustworthiness detection.
Configuring Scheduled Automatic ARP Scanning	 (Optional) It is used to enable scheduled automatic ARP scanning on an interface.
	arp scan auto Enables scheduled automatic ARP scanning on an interface.
	arp scan interval Configures the scheduled automatic ARP scanning interval in global configuration mode.
	arp scan rate Configures the scheduled automatic ARP scanning rate in global configuration mode.

Configuration	Description and Command	
Enabling ARP-based IP Guard	 (Optional) It is used to prevent a large number of IP packets from being sent to the CPU.	
	arp anti-ip-attack	Configures the number of IP packets for triggering ARP drop.
Refraining from Sending ARP Requests to Authentication VLANs	 (Optional) It is used to refrain from sending ARP requests to authentication VLANs.	
	arp suppress-auth-vlan-req	Refrains from sending ARP requests to authentication VLANs.
Enabling ARP VXLAN-related Functions	 (Optional) It is used to enable ARP VXLAN to support network deployment.	
	arp vxlan	arp vxlan
	arp vxlan gratuitous-send interval	arp vxlan gratuitous-send interval
Configuring ARP Packet Rate Statistics Collection	 (Optional) It is used to enable ARP packet rate statistics collection and configure the interval for collecting rate statistics.	
	arp rate-statistic enable	Enables ARP packet rate statistics collection.
	arp rate-statistic compute interval	Configures the interval for collecting ARP packet rate statistics.
Enabling Fast Aging of ARP Entries	 (Optional) It is used to enable fast aging of ARP entries.	
	arp fast-aging enable	Enables fast aging of ARP entries.
Enabling Fast Removal of ARP Entries	 (Optional) It is used to enable fast removal of ARP entries.	
	arp l2port-down fast-delete	Enables fast removal of ARP entries.
Enabling Active ARP Response Packet Learning	 (Optional) It is used to enable active ARP response packet learning.	
	arp reply-auto-learning enable	Enables active ARP response packet learning.
Enabling ARP Probe upon MAC Address Flapping	 (Optional) It is used to enable ARP probe upon MAC address flapping.	
	arp mac-flapping resolve enable	Enables ARP probe upon MAC address flapping.
	arp mac-flapping resolve interval	Configures the ARP probe interval.
	arp mac-flapping resolve times	Configures the ARP probe count.

2.4.1 Enabling Static ARP

Configuration Effect

Users can manually specify IP-MAC mapping to prevent the device from learning incorrect ARP entries.

Notes

After a static ARP entry is configured, the Layer-3 switch learns the physical port corresponding to the MAC address in the static ARP entry before it performs Layer-3 routing.

Configuration Steps

⤵ Configuring Static ARP Entries

- Optional.

- You can configure a static ARP entry to bind the IP address of the uplink device with its MAC address to prevent MAC change caused by ARP attacks.
- Configure static ARP entries in global configuration mode.

Verification

Run the **show running-config** command to check whether the configuration takes effect. Or run the **show arp static** command to check whether a static ARP cache table is created.

Related Commands

📄 **Configuring Static ARP Entries**

Command	arp [<i>vrf name</i> oob] <i>ip-address mac-address type</i>
Parameter	vrf name : Specifies a VRF instance. The name parameter indicates the name of the VRF instance.
Description	oob : Configures a static ARP entry for a management port. <i>ip-address</i> : Indicates the IP address mapped to a MAC address, which is in four-part dotted-decimal format. <i>mac-address</i> : Indicates the DLL address, consisting of 48 bits. <i>type</i> : Indicates the ARP encapsulation type. For an Ethernet interface, the keyword is arpa .
Command Mode	Global configuration mode
Usage Guide	The FSOS queries a 48-bit MAC address based on a 32-bit IP address in the ARP cache table. Since most hosts support dynamic ARP resolution, usually the static ARP mapping are not configured. Use the clear arp-cache command to delete the dynamic ARP entries.

Configuration Example

Scenario	For the network topology, see Figure 2- 1.												
Configuration Steps	Configure a static ARP entry on B to statically bind the IP address of A with the MAC address. <pre>FS(config)#arp 192.168.23.1 00D0.F822.334B arpa</pre>												
Verification	Run the show arp static command to display the static ARP entry. <pre>FS(config)#show arp static</pre> <table border="1"> <thead> <tr> <th>Protocol</th> <th>Address</th> <th>Age(min)</th> <th>Hardware</th> <th>Type</th> <th>Interface</th> </tr> </thead> <tbody> <tr> <td>Internet</td> <td>192.168.23.1</td> <td><static></td> <td>00D0.F822.334B</td> <td>arpa</td> <td></td> </tr> </tbody> </table> 1 static arp entries exist.	Protocol	Address	Age(min)	Hardware	Type	Interface	Internet	192.168.23.1	<static>	00D0.F822.334B	arpa	
Protocol	Address	Age(min)	Hardware	Type	Interface								
Internet	192.168.23.1	<static>	00D0.F822.334B	arpa									

Common Errors

- The MAC address in static ARP is incorrect.

2.4.2Configuring ARP Attributes

Configuration Effect

Users can specify the ARP timeout, ARP request retransmission interval and times, maximum number of unresolved ARP entries, and maximum number of ARP entries on an interface.

Configuration Steps

➤ **Configuring the ARP Timeout**

- Optional.
- In a LAN, if a user goes online/offline frequently, it is recommended to set the ARP timeout small to delete invalid ARP entries as soon as possible.
- Configure the ARP timeout in interface configuration mode.

➤ **Configuring the ARP Request Retransmission Interval and Times**

- Optional.
- If the network resources are insufficient, it is recommended to set the ARP request retransmission interval great and the retransmission times small to reduce the consumption of network bandwidths.
- Configure the ARP request retransmission interval and times in global configuration mode.

➤ **Configuring the Maximum Number of Unresolved ARP Entries**

- Optional.
- If the network resources are insufficient, it is recommended to set the maximum number of unresolved ARP entries small to reduce the consumption of network bandwidths.
- Configure the maximum number of unresolved ARP entries in global configuration mode.

➤ **Configuring the Maximum Number of ARP Entries on an Interface**

- Optional.
- Configure the maximum number of ARP entries on an interface in interface configuration mode.

Verification

Run the **show arp timeout** command to display the timeouts of all interfaces.

Run the **show running-config** command to display the ARP request retransmission interval and times, maximum number of unresolved ARP entries, and maximum number of ARP entries on an interface.

Related Commands

➤ **Configuring the ARP Timeout**

Command	arp timeout <i>seconds</i>
Parameter Description	<i>seconds</i> : Indicates the timeout in seconds, ranging from 0 to 2,147,483. The default value is 3,600.
Command Mode	Interface configuration mode
Usage Guide	The ARP timeout only applies to the dynamically learned IP-MAC mapping. When the ARP timeout is set to a smaller value, the mapping table stored in the ARP cache is more accurate but ARP consumes more network bandwidth. Unless otherwise specified, do not configure the ARP timeout.

➤ **Configuring the ARP Request Retransmission Interval and Times**

Command	arp retry interval <i>seconds</i>
Parameter	<i>seconds</i> : Indicates the ARP request retransmission interval in seconds, ranging from 1 to 3,600. The default value is 1.

Description	
Command Mode	Global configuration mode
Usage Guide	If a device frequently sends ARP requests, affecting network performance, you can set the ARP request retransmission interval longer. Ensure that this interval does not exceed the ARP timeout.

↘ **Configuring the Maximum Number of Unresolved ARP Entries**

Command	arp unresolve <i>number</i>
Parameter Description	<i>number</i> : Indicates the maximum number of unresolved ARP entries, ranging from 1 to 8,192. The default value is 8,192.
Command Mode	Global configuration mode
Usage Guide	<p>If a large number of unresolved entries exist in the ARP cache table and remain in the table after a while, it is recommended to use this command to limit the number of unresolved ARP entries.</p> <p> The maximum number of the unresolved ARP entries limits the number of neighbors that can be resolved at a time. If the device needs to resolve a large number of neighbors, it will take a long time to finish resolving all neighbors if the arp unresolve <i>number</i> is set to a small value.</p>

↘ **Configuring the Maximum Number of ARP Entries on an Interface**

Command	arp cache interface-limit <i>limit</i>
Parameter Description	<i>limit</i> : Indicates the maximum number of ARP entries that can be learned on an interface, including configured ARP entries and dynamically learned ARP entries. The value ranges from 0 to the ARP entry capacity supported by the device. 0 indicates no limit on this number.
Command Mode	Interface configuration mode
Usage Guide	Limiting the number of ARP entries on an interface can prevent malicious ARP attacks from generating excessive ARP entries on the device and occupying entry resources. The configured value must be equal to or greater than the number of the ARP entries learned by the interface. Otherwise, the configuration does not take effect. The configuration is subject to the ARP entry capacity supported by the device.

Configuration Example

Scenario	For the network topology, see Figure 2- 1.
Configuration Steps	<ul style="list-style-type: none"> ● Set the ARP timeout to 60 seconds on port GigabitEthernet 0/1. ● Set the maximum number of learned ARP entries to 300 on port GigabitEthernet 0/1. ● Set the ARP request retransmission interval to 3 seconds. ● Set the ARP request retransmission times to 4. ● Set the maximum number of unresolved ARP entries to 4,096. ● Set the maximum number of learned ARP entries to 1,000 on Sub Slot 2 of Slot 1.
	<pre> FS(config)#interface gigabitEthernet 0/1 FS(config-if-GigabitEthernet 0/1)#arp timeout 60 FS(config-if-GigabitEthernet 0/1)#arp cache interface-limit 300 FS(config-if-GigabitEthernet 0/1)#exit </pre>

	<pre>FS(config)#arp retry interval 3 FS(config)#arp retry times 4 FS(config)#arp unresolve 4096</pre>
<p>Verification</p>	<ul style="list-style-type: none"> ● Run the show arp timeout command to display the timeout of the interface. ● Run the show running-config command to display the ARP request retransmission interval and times, and maximum number of unresolved ARP entries.
	<pre>FS#show arp timeout Interface arp timeout(sec) ----- GigabitEthernet 0/1 60 GigabitEthernet 0/2 3600 GigabitEthernet 0/4 3600 GigabitEthernet 0/5 3600 GigabitEthernet 0/7 3600 VLAN 100 3600 VLAN 111 3600 Mgmt 0 3600 FS(config)# show running-config arp unresolve 4096 arp retry times 4 arp retry interval 3 ! interface GigabitEthernet 0/1 arp cache interface-limit 300</pre>

-

2.4.3 Enabling Gratuitous ARP

Configuration Effect

The interface periodically sends gratuitous ARP packets.

Configuration Steps

- Optional.
- When a switch acts as the gateway, enable gratuitous ARP on an interface to prevent other users from learning incorrect gateway MAC address in case of ARP spoofing.

- Enable gratuitous ARP in interface configuration mode.

Verification

Run the **show running-config interface** [name] command to check whether the configuration is successful.

Related Commands

▾ **Enabling Gratuitous ARP**

Command	arp gratuitous-send interval seconds [number]
Parameter Description	seconds: Indicates the interval for sending a gratuitous ARP request. The unit is second. The value ranges from 1 to 3,600. number: Indicates the number of gratuitous ARP requests that are sent. The default value is 1. The value ranges from 1 to 100.
Command Mode	Interface configuration mode
Usage Guide	If a network interface of a device acts as the gateway for downstream devices but a downstream device pretends to be the gateway, enable gratuitous ARP on the interface to advertise itself as the real gateway.

Configuration Example

Scenario	For the network topology, see Figure 2- 1.
Configuration Steps	Configure the GigabitEthernet 0/0 interface to send a gratuitous ARP packet every 5 seconds. <pre>FS(config-if-GigabitEthernet 0/0)#arp gratuitous-send interval 5</pre>
Verification	Run the show running-config interface command to check whether the configuration takes effect. <pre>FS#sh running-config interface gigabitEthernet 0/0 Building configuration... Current configuration : 127 bytes ! interface GigabitEthernet 0/0 duplex auto speed auto ip address 30.1.1.1 255.255.255.0 arp gratuitous-send interval 5</pre>

2.4.4 Enabling Proxy ARP

Configuration Effect

The device acts as a proxy to reply to ARP request packets from other users.

Notes

By default, Proxy ARP is disabled.

Configuration Steps

- Optional.
- If a user without any route information needs to obtain the MAC addresses of the IP users in other subnets, enable Proxy ARP on the device so that the device can act as a proxy to send ARP replies.
- Enable Proxy ARP in interface configuration mode.

Verification

Run the **show ip interface** [*name*] *command* to check whether the configuration takes effect.

Related Commands

📌 **Enabling Proxy ARP**

Command	ip proxy-arp
Parameter	N/A
Description	
Command Mode	Interface configuration mode
Usage Guide	N/A

Configuration Example

Scenario	For the network topology, see Figure 2- 1.
Configuration Steps	Enable Proxy ARP on port GigabitEthernet 0/0.
	<pre>FS(config-if-GigabitEthernet 0/0)#ip proxy-arp</pre>
Verification	Run the show ip interface command to check whether the configuration takes effect.
	<pre>FS#show ip interface gigabitEthernet 0/0 GigabitEthernet 0/0 IP interface state is: DOWN IP interface type is: BROADCAST IP interface MTU is: 1500 IP address is: No address configured IP address negotiate is: OFF Forward direct-broadcast is: OFF ICMP mask reply is: ON Send ICMP redirect is: ON Send ICMP unreachable is: ON DHCP relay is: OFF</pre>

Fast switch is: ON Help address is: 0.0.0.0 Proxy ARP is: ON ARP packet input number: 0 Request packet : 0 Reply packet : 0 Unknown packet : 0 TTL invalid packet number: 0 ICMP packet input number: 0 Echo request : 0 Echo reply : 0 Unreachable : 0 Source quench : 0 Routing redirect : 0

2.4.5 Enabling Local Proxy ARP

Configuration Effect

The device acts as a proxy to reply to ARP request packets from other users in the same subnet.

Notes

Local Proxy ARP is supported only on SVIs.

Configuration Steps

- Optional.
- If a user enabled with port protection needs to communicate with users in the VLAN, enable local Proxy ARP on the device.
- Enable local Proxy ARP in interface configuration mode.

Verification

Run the **show run interface** [*name*] command to check whether the configuration takes effect.

Related Commands

↳ Enabling Local Proxy ARP

Command	local-proxy-arp
Parameter Description	N/A
Command Mode	Interface configuration mode
Usage Guide	N/A

Configuration Example

Scenario	For the network topology, see Figure 2- 1.
Configuration Steps	Enable local Proxy ARP on the VLAN 1 interface.
	<pre>FS(config-if-VLAN 1)#local-proxy-arp</pre>
Verification	Run the show ip interface command to check whether the configuration takes effect.
	<pre>FS#show running-config interface vlan 1 Building configuration... Current configuration : 53 bytes interface VLAN 1 ip address 192.168.1.2 255.255.255.0 local-proxy-arp</pre>

2.4.6 Enabling Any IP ARP

Configuration Effect

Users can access the network with any IP address.

Notes

Any IP ARP is supported only on egress gateway products.

In the following two scenarios, users must modify the configuration before they can access the network.

- 14. The user's IP address is in the same network segment as the interface directly connected to the device. However, the IP address configured on the interface directly connected to the device is not the gateway address.
- 15. The user's IP address is not in the same network segment as the interface directly connected to the device, but in the network segment of another interface. That means an IP address conflict occurs.

As the user' IP address is not in the same network segment as the interface directly connected to the device, the dynamic ARP entries and direct routes are generated only when the user initiates ARP requests. Therefore, in some scenarios (including but not limited to the following ones), the user will not be able to access the network unless it clears the ARP entries and relearn the gateway address.

- 16. The device acts as a proxy to respond to ARP requests. After the user learns the MAC address of the device, dynamic ARP entries are cleared on the device. As a result, the user's dynamic ARP entries and direct routes are removed and the user cannot receive the reply packets.
- 17. The device acts as a proxy to respond to ARP requests. After the user learns the MAC address of the device, any IP ARP is disabled and then enabled again on the interface.

Note: Disabling any IP ARP on an interface will cause users' dynamic ARP entries and direct routes to be removed. Consequently, users cannot receive response packets.

On the other hand, if static ARP entries or ARP entries with VRRP IP addresses exist, dynamic ARP entries generated by any IP ARP will be overwritten or fail to be added, disabling the any IP ARP function.

Configuration Steps



- Optional.
- In a hotel, enable any IP ARP on the gateway so that users can access the network without changing the IP address.
- Enable any IP ARP in interface configuration mode.

Verification

Run the **show running-config interface** [*name*] command to check whether the configuration takes effect.

Related Commands

↘ **Enabling Any IP ARP**

Command	arp any-ip
Parameter	N/A
Description	
Command Mode	Interface configuration mode
Usage Guide	<p> Disabling any IP ARP on an interface will cause users' dynamic ARP entries and direct routes to be removed. Consequently, users cannot receive response packets.</p> <p> If static ARP entries or ARP entries with VRRP IP addresses exist, dynamic ARP entries generated by any IP ARP will be overwritten or fail to be added, disabling the any IP ARP function.</p>

Configuration Example

Scenario	See Figure 2-1.
Configuration Steps	Enable any IP ARP on port GigabitEthernet 0/0.
	<pre>FS(config-if-GigabitEthernet 0/0)#arp any-ip</pre>
Verification	Run the show running-config interface command to check whether the configuration takes effect.
	<pre>FS(config-if-GigabitEthernet 0/0)#sh run int gi0/0</pre> <pre>Building configuration...</pre> <pre>Current configuration : 140 bytes</pre> <pre>!</pre> <pre>interface GigabitEthernet 0/0</pre> <pre> duplex auto</pre> <pre> speed auto</pre> <pre> ip address 30.1.1.1 255.255.255.0</pre>

	arp gratuitous-send interval 5 arp any-ip
--	--

2.4.7 Enabling ARP Trustworthiness Detection

Configuration Effect

Enable ARP trustworthiness detection. If the device receiving an ARP request packet fails to find the corresponding entry, it performs NUD. If the MAC address in the existing dynamic ARP entry is updated, the device immediately performs NUD to prevent ARP attacks.

Notes

Since this function adds a strict confirmation procedure in the ARP learning process, it affects the efficiency of ARP learning.

Configuration Steps

- Optional.
- If there is a need for learning ARP entries, enable ARP trustworthiness detection on the device. If the device receiving an ARP request packet fails to find the corresponding entry, it needs to send a unicast ARP request packet to check whether the peer end exists. If yes, the device learns the ARP entry. If not, the device does not learn the ARP entry. If the MAC address in the ARP entry changes, the device will immediately perform NUD to prevent ARP spoofing.
- Enable ARP trustworthiness detection in interface configuration mode.

Verification

Run the **show running-config interface** [name] command to check whether the configuration take effect

Related Commands

▾ Enabling ARP Trustworthiness Detection

Command	arp trust-monitor enable
Parameter Description	N/A
Command Mode	Interface configuration mode
Usage Guide	<p>❗ Enable this function. If the corresponding ARP entry exists and the MAC address is not updated, the device does not perform NUD.</p> <p>❗ Enable this function. If the MAC address of the existing dynamic ARP entry is updated, the device immediately performs NUD.</p> <p>❗ After this function is disabled, the device does not perform NUD for learning or updating ARP entries.</p>

Configuration Example

Scenario	For the network topology, see Figure 2- 1.
Configuration Steps	Enable ARP trustworthiness detection on port GigabitEthernet 0/0.

	FS(config-if-GigabitEthernet 0/0)#arp trust-monitor enable
Verification	Run the show running-config interface command to check whether the configuration takes effect.
	<pre> FS#show running-config interface gigabitEthernet 0/0 Building configuration... Current configuration : 184 bytes ! interface GigabitEthernet 0/0 duplex auto speed auto ip address 30.1.1.1 255.255.255.0 arp trust-monitor enable </pre>

2.4.8 Configuring Scheduled Automatic ARP Scanning

Configuration Effect

After scheduled automatic ARP scanning is configured on an interface, the device scans neighbors in the specified range and learns ARP entries from the neighbors. After a time period of the scanning interval (5 minutes by default), the device starts the next scanning and learns the remaining ARP entries. The device repeats these operations until all ARP entries are learnt.

Notes

N/A

Configuration Steps

- Optional.
- Perform this configuration in interface configuration mode.

Verification

Run the **show running-config interface** *[name]* command to display configurations.

Related Commands

📌 Enabling Scheduled Automatic ARP Scanning

Command	arp scan auto <i>start-ip-address end-ip-address</i>
Parameter Description	<p><i>start-ip-address</i>: Specifies the start IP address of the ARP scan range. The start IP address must be smaller than or equal to the end IP address.</p> <p><i>end-ip-address</i>: Specifies the end IP address of the ARP scan range. The end IP address must be greater than or equal to the start IP address.</p>
Command Mode	Interface configuration mode

Usage Guide	<p>This function is enabled to perform scheduled automatic ARP scanning once every 5 minutes by default.</p> <p>The IP address with existing neighboring ARP entries is not scanned.</p> <p>If you know the allocated IP address range in a LAN, you can specify the ARP scan range. The number of the specified IP addresses cannot be greater than 1,024.</p> <p>The start/end IP address of the ARP scan range must be in the same network segment as the interface IP address.</p> <p>ARP scanning takes effect on UP interfaces only.</p>
--------------------	--

Configuration Example

Scenario	See figure 2-1.
Configuration Steps	Enable ARP scanning on an SVI.
	<pre>FS(config-if-VLAN 20)# arp scan auto 192.168.23.1 192.168.23.100</pre>
Verification	Run the show running-config interface command to display configurations.
	<pre>FS#sho running-config interface vlan 20 Building configuration... Current configuration : 57 bytes interface VLAN 20 arp scan auto 192.168.23.1 192.168.23.100 dut4(config-if-VLAN 20)#</pre>

Common Errors

1. The start IP address is greater than the end IP address in the configured ARP scanning range.
2. The start/end IP address is not in the same network segment as the interface IP address.

2.4.9 Enabling ARP-based IP Guard

Configuration Effect

When the CPU receives the specified number of packets in which the destination IP address hits the ARP entry, all packets with this destination IP address will not be sent to the CPU afterwards.

Notes

N/A

Configuration Steps

- Optional.
- By default, when three unknown unicast packets are sent to the CPU, the drop entry is set. Users can run this command to adjust the number of packets for triggering ARP drop based on the network environment. Users can also disable this function.
- Configure ARP-based IP guard in global configuration mode.

Verification

Run the **show run** command to check whether the configuration takes effect.

Related Commands

▾ Enabling ARP-based IP Guard

Command	arp anti-ip-attack num
Parameter	<i>num</i> : Indicates the number of IP packets for triggering ARP drop. The value ranges from 0 to 100.
Description	0 indicates that ARP-based IP guard is disabled. The default value is 3.
Command Mode	Interface configuration mode
Usage Guide	 If hardware resources are sufficient, run the arp anti-ip-attack num command to set the number of IP packets for triggering ARP drop to a small value. If hardware resources are insufficient, run the arp anti-ip-attack num command to set the number of IP packets for triggering ARP drop to a large value, or disable this function.

Configuration Example

Scenario	For the network topology, see Figure 2- 1.
Configuration Steps	Enable ARP-based IP guard on B. <pre>FS(config)#arp anti-ip-attack 10</pre>
Verification	Run the show running-config command to check whether the configuration takes effect. <pre>FS#show running-config</pre> <p>Building configuration...</p> <p>Current configuration : 53 bytes</p> <pre>arp anti-ip-attack 10</pre>

2.4.10 Refraining from Sending ARP Requests to Authentication VLANs

Configuration Effect

The device does not send ARP request packets to authentication VLANs.

Notes

This function is supported only on SVIs.

Configuration Steps

- Optional.
- In gateway authentication mode, the device does not send ARP request packets to authentication VLANs by default. If the device needs to send ARP request packets to authentication VLANs, run the **no arp suppress-auth-vlan-req** command to disable this function.
- Perform this configuration in interface configuration mode.

Verification

Run the **show run interface** [name] command to check whether the configuration takes effect.

Related Commands

↘ **Refraining from Sending ARP Requests to Authentication VLANs**

Command	arp suppress-auth-vlan-req
Parameter Description	N/A
Command Mode	Interface configuration mode
Usage Guide	N/A

Configuration Example

Scenario	For the network topology, see Figure 2- 1.
Configuration Steps	Disable the VLAN 2 interface from refraining from sending ARP requests to authentication VLANs. <pre>FS(config-if-VLAN 2)#no arp suppress-auth-vlan-req</pre>
Verification	Run the show running-config interface [name] command to check whether the configuration takes effect. <pre>FS#show running-config interface vlan 2</pre> <p>Building configuration...</p> <p>Current configuration : 53 bytes</p> <pre>interface VLAN 2 ip address 192.168.1.2 255.255.255.0 no arp suppress-auth-vlan-req</pre>

2.4.11 ARP VXLAN-related Functions

Working Principle

In the VXLAN+SDN environment, the ARP module provides the following functions to adapt to the SDN controller:

6. Enabling/disabling automatic ARP entry learning on Overlay router interfaces: When the SDN controller is used to deliver ARP entries to the device in a unified manner, run the **no arp vxlan learning-enable** command to disable the function. In this case, the device does not learn or update ARP entries based on the received ARP packets.
7. Enabling/disabling SDN controller response to ARP requests: When the SDN controller needs to manage ARP packets in a unified manner, run the **arp vxlan sdn-reply** command to enable the function. In this case, ARP requests are copied to the SDN controller for responses.
8. Enabling/disabling gratuitous ARP request suppression on Overlay router interfaces: To prevent the problem that some terminals no longer send ARP requests to the SDN controller after learning the ARP entries from the gratuitous ARP request packets sent

by the Overlay network gateway, run the **arp vxlan suppress gratuitous arp** command to enable gratuitous ARP request suppression on Overlay router interfaces.

9. Enabling/disabling Overlay router interfaces to actively send gratuitous ARP request packets: To prevent the problem that aging of the virtual MAC address of the overlay network gateway could lead to flooding of VXLAN-related traffic and thus affect device performance, enable Overlay router interfaces to actively send gratuitous ARP request packets.
10. Enabling/disabling generating of host routes after EVPN synchronizes ARP or ND entries to Overlay router interfaces.

For details about how to configure VXLAN, see *VXLAN-SCG.doc*.

Related Configuration

↘ **Enabling ARP VXLAN to Support the VXLAN+SDN Deployment**

- In global configuration mode, run the **no arp vxlan learning-enable** command to disable automatic ARP entry learning on Overlay router interfaces; run the **arp vxlan sdn-reply** command to enable the SDN controller to respond to ARP requests; run the **arp vxlan suppress gratuitous_arp** command to enable gratuitous arp request sending on Overlay router interfaces.
- By default, automatic ARP entry learning is enabled, the function of SDN controller responding to ARP requests is disabled, and gratuitous ARP request suppression is disabled.
- By default, Overlay router interfaces does not actively send gratuitous ARP request packets.

↘ **Enabling Generating of Host Routes After EVPN Synchronizes ARP or ND Entries to Overlay Router Interfaces**

- In interface configuration mode, run the **no arp vxlan remote-arp inactive** command to enable generating of host routes after EVPN synchronizes ARP or ND entries to Overlay router interfaces.
- By default, host routes are not generated when EVPN synchronizes ARP or ND entries to Overlay router interfaces.

2.4.12 Configuring ARP Packet Rate Statistics Collection

Configuration Effect

Measure the rate of receiving/sending ARP packets on each interface.

Notes

The default sampling interval is 5s, but the rate is measured at an interval of 1s.

Configuration Steps

- (Optional) Configure ARP packet rate statistics collection when needed.
- Perform the configuration in global configuration mode.

Command	arp rate-statistic enable
Parameter	N/A
Description	
Defaults	ARP packet rate statistics collection is disabled by default.
Command Mode	Global configuration mode
Usage Guide	ARP packet rate statistics collection is disabled by default. If the command result of show arp rate-statistic shows that statistics are all 0s, run the show run-config command to display configurations. If the function is not enabled, run the arp rate-statistic enable command to enable the function. To disable the function, run the no arp rate-statistic enable

	command.
--	----------

➤ **Configuring the Interval for Collecting ARP Packet Rate Statistics**

- (Optional) Configure the interval for collecting ARP packet rate statistics if the default value (5s) does not meet requirements.
- Perform the configuration in global configuration mode.

Command	arp rate-statistic compute interval <i>seconds</i>
Parameter Description	<i>seconds</i> : Indicates the interval in seconds, which cannot be less than 1s.
Defaults	The default value is 5s.
Command Mode	Global configuration mode
Usage Guide	If ARP packets are received/sent at an undesired rate on many interfaces, appropriately adjust the interval for collecting ARP packet rate statistics.

Verification

Run the **show running-config** command to display configurations.

Configuration Example

Configuration Steps	Enable ARP packet rate statistics collection in global configuration mode.
	FS(config)#arp rate-statistic enable
Verification	Run the show running-config command to display configurations.
	<pre> FS(config)#arp rate-statistic enable FS(config)#show running-config ! arp rate-statistic enable arp rate-statistic timeout 10 ! FS(config)# </pre>

Configuration Steps	Configure the interval for collecting ARP packet rate statistics in global configuration mode.
	FS(config)#arp rate-statistic compute interval 10
Verification	Run the show running-config command to display configurations.
	<pre> FS(config)#arp rate-statistic enable FS(config)#show running-config ! arp rate-statistic enable arp rate-statistic compute interval 10 ! FS(config)# </pre>

2.4.13 Enabling Fast Aging of ARP Entries

Configuration Effect

ARP entries cannot be learned under unusual circumstances. After MAC addresses age, ARP entries age fast.

Notes

N/A

Configuration Steps



- Optional.
- Perform the configuration in interface configuration mode.
- Only SVI and Overlay Router interfaces are supported.

Verification

Run the **show run** command to check whether the configuration is successful.

Related Commands

↘ Enabling Fast Aging of ARP Entries

Command	arp fast-aging enable
Parameter Description	N/A
Command Mode	Interface configuration mode
Usage Guide	<p>By default, dynamic ARP entries start aging one hour after the aging of their corresponding MAC addresses. If this feature is configured, after their corresponding MAC address age, the dynamic ARP entries age immediately.</p> <ul style="list-style-type: none">  This command is supported on SVI and Overlay Router interfaces.  When ARP-to-host conversion is configured, it is recommended to enable this function at the same time, to help achieve fast route convergence.

Configuration Example

Scenario	See Figure 2-1.
Configuration Steps	<p>Enabling fast aging of ARP entries on the SVI 2 interface.</p> <pre>FS(config-if-VLAN 2)#arp fast-aging enable</pre>
Verification	<p>Run the show running-config command to check whether the configuration is successful.</p> <pre>FS#show running-config interface VLAN 2 ! arp fast-aging enable !</pre>

Common Errors

N/A

2.4.14 Enabling Fast Removal of ARP Entries

Configuration Effect

When L2 ports get down, corresponding ARP entries are fast deleted.

Notes

N/A

Configuration Steps

- Optional.
- Perform the configuration in interface configuration mode.
- Only SVIs are supported.

Verification

Run the **show run** command to check whether the configuration is successful.

Related Commands

▾ Enabling Fast Removal of ARP Entries

Command	arp l2port-down fast-delete
Parameter Description	N/A
Command Mode	Interface configuration mode
Usage Guide	Run the arp l2port-down fast-delete command on an SVI, so ARP entries are removed as soon as L2 ports under this SVI get down. Without configuring this feature, ARP entries are deleted only after their aging time is reached.

Configuration Example

Scenario	See Figure 2-1.
Configuration Steps	Enabling fast removal of ARP entries on the SVI 2 interface. FS(config-if-VLAN 2)#arp l2port-down fast-delete
Verification	Run the show running-config command to check whether the configuration is successful. FS#show running-config interface VLAN 2 ! arp l2port-down fast-delete !

Common Errors

N/A

2.4.15 Enabling Passive ARP Response Packet Learning

Configuration Effect

The device will learn ARP response packets even when it does not send ARP request packets.

Notes

N/A

Configuration Steps

- Optional.
- Enable passive ARP response packet learning in global configuration mode.

Verification

Run the **show run** command to check whether the configuration is successful.

Related Commands

▾ Enabling Passive ARP Response Packet Learning

Command	arp reply-auto-learning enable
Parameter Description	N/A
Command Mode	Global configuration mode
Usage Guide	After this function is enabled, the device will learn ARP response packets even when it does not send ARP request packets.

Configuration Example

<p>Scenario Figure 2- 3</p>	<p>C:192.168.23.3/24 D:192.168.23.4/24 E:192.168.23.5/24</p> <p>A: Router B: Switch serving as the gateway for the users C, D and E: Users</p>
<p>Configuration Steps</p>	<p>Enabling passive ARP response packet learning. .</p> <pre>FS(config)#arp reply-auto-learning enable</pre>
<p>Verification</p>	<p>Run show running-config command to check whether the configuration is successful.</p>

```
FS#show running-config
!
arp reply-auto-learning enable
!
```

Common Errors

N/A

2.4.16 Enabling ARP Probe upon MAC Address Flapping

Configuration Effect

If MAC address flapping occurs, namely, the layer-2 interface changes and is inconsistent with the interface recorded in the ARP entry, the device will continue to send ARP request packets to probe the actual interface until the probe succeeds.

Notes

N/A.

Configuration Steps



- Optional.
- Enable ARP probe upon MAC address flapping in global configuration mode.

Verification

Run the **show run** command to check whether the configuration is successful.

Related Commands

↘ **Enabling ARP Probe upon MAC Address Flapping**

Command	arp mac-flapping resolve enable
Parameter Description	N/A
Command Mode	Global configuration mode
Usage Guide	<p>If MAC address flapping occurs, namely, the layer-2 interface changes and is inconsistent with the interface recorded in the ARP entry, the device will continue to send ARP request packets to probe the actual interface until the probe succeeds.</p> <p> The interface will not be updated immediately when MAC address flapping occurs. Instead, it will be updated after the probe finishes or after the device receives ARP response packets to learn the interface again. If there is consistent attack flow, the interface recorded in the ARP entry may not be consistent with the actual MAC address.</p> <p> If you want to update the interface immediately when MAC address flapping occurs, please disable this command.</p>

↘ **Configuring ARP Probe Interval**

Command	arp mac-flapping resolve interval [seconds]
Parameter Description	The default interval is 2 seconds.
Command Mode	Global configuration mode
Usage Guide	This command is used to configure the ARP probe interval upon MAC address flapping.

↘ **Configuring ARP Probe Count**

Command	arp mac-flapping resolve times [number]
Parameter Description	The default count is 5.
Command Mode	Global configuration mode
Usage Guide	This command is used to configure the ARP probe count upon MAC address flapping.

Configuration Example

Scenario Figure 2- 4	<p>C:192.168.23.3/24 D:192.168.23.4/24 E:192.168.23.5/24</p> <p>A: Router B: Switch serving as the gateway for the users C, D and E: Users</p>
Configuration Steps	<p>Enabling ARP probe upon MAC address flapping.</p> <pre>FS(config)#arp mac-flapping resolve enable</pre> <p>Setting ARP probe interval to 5s.</p> <pre>FS(config)# arp mac-flapping resolve interval 5</pre> <p>Setting ARP probe count to 1.</p> <pre>FS(config)# arp mac-flapping resolve times 1</pre> <pre>FS(config)#arp reply-auto-learning enable</pre>
Verification	<p>Run show running-config command to check whether the configuration is successful.</p> <pre>FS#show running-config</pre> <pre>!</pre> <pre>arp mac-flapping resolve enable</pre> <pre>!</pre> <pre>!</pre> <pre>arp mac-flapping resolve interval 5</pre>

```
!
!
arp mac-flapping resolve times 1
!
```

Common Errors

N/A

2.5 Monitoring

Clearing



Running the **clear** commands may lose vital information and thus interrupt services.

Description	Command
Clears dynamic ARP entries. In gateway authentication mode, dynamic ARP entries in authentication VLANs are not cleared.	clear arp-cache
Clears ARP packet statistics.	clear arp-cache packet statistics [<i>interface</i>]

Displaying

Description	Command
Displays the ARP table in detail.	show arp [<i>detail</i>] [<i>interface-type interface-number</i> [<i>vrf vrf-name</i>] [<i>ip</i> [<i>mask</i>] <i>mac-address</i> static complete incomplete]
Displays the ARP table.	show ip arp [<i>vrf vrf-name</i>]
Displays the ARP entry counter.	show arp counter
Displays the timeout of dynamic ARP entries.	show arp timeout
Displays ARP packet statistics.	show arp packet statistics [<i>interface</i>]
Displays ARP packet rate statistics.	show arp rate-statistic [<i>interface</i>]

Debugging



System resources are occupied when debugging information is output. Therefore, disable the debugging switch immediately after use.

Description	Command
Debugs ARP packet sending and receiving.	debug arp
Debugs the creation and deletion of ARP entries.	debug arp event

3 Configuring IPv6

3.1 Overview

As the Internet develops rapidly and IPv4 address space is becoming exhausted, IPv4 limitations become more and more obvious. At present, many researches and practices on Internet Protocol Next Generation (IPng) have been conducted. The IPng working group of the Internet Engineering Task Force (IETF) has formulated an IPng protocol named IP Version 6 (IPv6), which is described in RFC 2460.

Main Features

↘ Larger Address Space

Compared with 32 bits in an IPv4 address, the length of an IPv6 address is extended to 128 bits. Therefore, the address space has approximately 2^{128} addresses. IPv6 adopts a hierarchical address allocation mode to support address allocation of multiple subnets from the Internet core network to intranet subnet.

↘ Simpler Packet Header Format

Since the design principle of the IPv6 packet header is to minimize the overhead of the packet header, some non-key fields and optional fields are removed from the packet header to the extended packet header. Therefore, although the length of an IPv6 address is four times of that of an IPv4 address, the IPv6 packet header is only two times of the IPv4 packet header. The IPv6 packet header makes device forwarding more efficient. For example, with no checksum in the IPv6 packet header, the IPv6 device does not need to process fragments (fragmentation is completed by the initiator).

↘ Efficient Hierarchical Addressing and Routing Structure

IPv6 uses a convergence mechanism and defines a flexible hierarchical addressing and routing structure. Multiple networks at the same layer are represented as a uniform network prefix on the upstream device, greatly reducing routing entries maintained by the device and routing and storage overheads of the device.

↘ Easy Management: Plug and Play (PnP)

IPv6 provides automatic discovery and auto-configuration functions to simplify management and maintenance of network nodes. For example, Neighbor Discovery (ND), MTU Discovery, Router Advertisement (RA), Router Solicitation (RS), and auto-configuration technologies provide related services for PnP. Particularly, IPv6 offers two types of auto-configuration: stateful auto-configuration and stateless auto-configuration. In IPv4, Dynamic Host Configuration Protocol (DHCP) realizes auto-configuration of the host IP address and related parameters. IPv6 inherits this auto-configuration service from IPv4 and called it stateful auto-configuration (see DHCPv6). Besides, IPv6 also offers the stateless auto-configuration service. During stateless auto-configuration, a host automatically obtains the local address of the link, address prefix of the local device, and other related configurations.

↘ Security

As an optional extension protocol of IPv4, Internet Protocol Security (IPSec) is a part of IPv6 to provide security for IPv6 packets. At present, IPv6 provides two mechanisms: Authentication Header (AH) and Encapsulated Security Payload (ESP). AH provides data integrity and authenticates IP packet sources to ensure that the packets originate from the nodes identified by the source addresses. ESP provides data encryption to realize end-to-end encryption.

↘ Better QoS Support

A new field in the IPv6 packet header defines how to identify and process data streams. The Flow Label field in the IPv6 packet header is used to authenticate a data flow. Using this field, IPv6 allows users to propose requirements on the communication quality. , A

device can identify all packets belonging to a specific data stream based on this field and process these packets according to user requirements.

↘ **New Protocol for Neighboring Node Interaction**

IPv6 Neighbor Discovery Protocol (NDP) uses a series of Internet Control Message Protocol Version 6 (ICMPv6) packets to implement interactive management of neighboring nodes (nodes on the same link). IPv6 uses NDP packets and efficient multicast/unicast ND packets instead of broadcast-based Address Resolution Protocol (ARP) and Control Message Protocol Version 4 (ICMPv4) router discovery packets.

↘ **Extensibility**

With strong extensibility, IPv6 features can be added to the extended packet header following the IPv6 packet header. Unlike IPv4, the IPv6 packet header can support at most 40 bytes of options. For an IPv6 packet, the length of the extended packet header is restricted only by the maximum number of bytes in the packet.

Protocols and Standards

- RFC 4291 - IP Version 6 Addressing Architecture
- RFC 2460 - Internet Protocol, Version 6 (IPv6) Specification
- RFC 4443 - Internet Control Message Protocol (ICMPv6) for the Internet Protocol Version 6 (IPv6) Specification
- RFC 4861 - Neighbor Discovery for IP version 6 (IPv6)
- RFC 4862 - IPv6 Stateless Address Auto-configuration
- RFC 5059 - Deprecation of Type 0 Routing Headers in IPv6

3.2 Applications

Application	Description
Communication Based on IPv6 Addresses	Two PCs communicate with each other using IPv6 addresses.

3.2.1 Communication Based on IPv6 Addresses

Scenario

As shown in Figure 3- 1, Host 1 and Host 2 communicate with each other using IPv6 addresses.

Figure 3- 1



Deployment

Hosts can use the stateless address auto-configuration or DHCPv6 address assignment mode. After addresses are configured, hosts can communicate with each other using IPv6 addresses.

3.3 Features

Overview

Feature	Description
IPv6 Address Format	The IPv6 address format makes IPv6 have a larger address space and flexible representation approach.
IPv6 Address Type	IPv6 identifies network applications based on addresses.
IPv6 Packet Header Format	IPv6 simplifies the fixed and extended packet headers to improve the data packet processing and forwarding efficiency of the device.
IPv6 PMTUD	A host dynamically discovers and adjusts the MTU size on the data Tx path, saving router resources and improving IPv6 network efficiency.
IPv6 Neighbor Discovery	ND functions include router discovery, prefix discovery, parameter discovery, address auto-configuration, address resolution (like ARP), next-hop determination, Neighbor Unreachability Detection (NUD), Duplicate Address Detection (DAD), and redirection.
IPv6 Source Routing	This feature is used to specify the intermediate nodes that a packet passes through along the path to the destination address. It is similar to the IPv4 loose source routing option and loose record routing option.
Restricting the Sending Rate of ICMPv6 Error Messages	This feature prevents DoS attacks.
IPv6 HOP-LIMIT	This feature prevents useless unicast packets from being unlimitedly transmitted on the network and wasting network bandwidth.
Refraining from Sending NS Packets to Authentication VLANs	In gateway authentication mode, a device is refrained from sending NS packets to authentication VLANs.
Default Gateway on the Management Interface	The default gateway is configured on the management interface to generate a default route for this interface.
<u>Enabling Statistics of ND Packets</u>	This feature enables the statistics of received and sent ND packets and their rates on all IPv6 interfaces.
<u>Enabling Fast Removal of ND Entries</u>	The feature enables fast removal of ND entries when L2 ports get down.
<u>Enabling an Interface to Learn ND Entries Via DAD NS Packets</u>	The features enables an interface to learn ND entries via DAD packets
<u>Enabling Generating of Host Routes After EVPN Synchronizes ARP or ND Entries to Overlay Router Interfaces</u>	This feature enables generating of host routes after EVPN synchronizes ND entries to Overlay Router interfaces.

3.3.1 IPv6 Address Format

An IPv6 address is represented in the X:X:X:X:X:X format, where X is a 4-digit hexadecimal integer (16 bits). Each address consists of 8 integers, with a total of 128 bits (each integer contains 4 hexadecimal digits and each digit contains four bits). The following are three valid IPv6 addresses:

```
2001:ABCD:1234:5678:AAAA:BBBB:1200:2100
```

```
800:0:0:0:0:0:0:1
```

```
1080:0:0:0:8:800:200C:417A
```

These integers are hexadecimal, where A to F represent 10 to 15. Each integer in the address must be represented, except the leading zeros in each integer. If an IPv6 address contains a string of zeros (as shown in the second and third examples above), a double colon (::) can be used to represent these zeros. That is, 800:0:0:0:0:0:0:1 can be represented as 800::1.

A double colon indicates that this address can be extended to a complete 128-bit address. In this approach, only when the 16-bit integers are all 0s, can they be replaced with a double colon. A double colon can exist once in an IPv6 address.

In IPv4/IPv6 mixed environment, an address has a mixed representation. In an IPv6 address, the least significant 32 bits can be used to represent an IPv4 address. This IPv6 address can be represented in a mixed manner, that is, X:X:X:X:d.d.d.d, where X is a hexadecimal integer and d is a 8-bit decimal integer. For example, 0:0:0:0:0:192.168.20.1 is a valid IPv6 address. It can be abbreviated to :::192.168.20.1. Typical applications are IPv4-compatible IPv6 addresses and IPv4-mapped IPv6 addresses. If the first 96 bits are 0 in an IPv4-compatible IPv6 address, this address can be represented as ::A.B.C.D, e.g., ::1.1.1.1. IPv4-compatible addresses have been abolished at present. IPv4-mapped IPv6 addresses are represented as ::FFFF:A.B.C.D to represent IPv4 addresses as IPv6 addresses. For example, IPv4 address 1.1.1.1 mapped to an IPv6 address is represented as ::FFFF:1.1.1.1.

Since an IPv6 address is divided into two parts: subnet prefix and interface ID, it can be represented as an address with an additional value according to an address allocation method like Classless Inter-Domain Routing (CIDR). The additional value indicates how many bits (subnet prefix) in the address represent the network part. That is, the IPv6 node address contains the prefix length. The prefix length is separated from the IPv6 address by a slash. For example, in 12AB::CD30:0:0:0/60, the prefix length used for routing is 60 bits.

Related Configuration

Configuring an IPv6 Address

- No IPv6 address is configured on interfaces by default.
- Run the **ipv6 address** command to configure an IPv6 address on an interface.
- After configuration, a host can communicate with others using the configured IPv6 address based on DAD.

3.3.2 IPv6 Address Type

RFC 4291 defines three types of IPv6 addresses:

- Unicast address: ID of a single interface. Packets destined to a unicast address are sent to the interface identified by this address.
- Multicast address: ID of an interface group (the interfaces generally belong to different nodes). Packets destined to a multicast address are sent to all interfaces included in this address.
- Anycast address: ID of an interface group. Packets destined to an anycast address are sent to one interface included in this address (the nearest interface according to the routing protocol).



IPv6 does not define broadcast addresses.

These three types of addresses are described as follows:

↘ Unicast Addresses

Unicast addresses fall into five types: unspecified address, loopback address, link-local address, site-local address, and global unicast address. At present, site-local addresses have been abolished. Except unspecified, loopback, and link-local addresses, all other addresses are global unicast addresses.

- Unspecified address

The unspecified address is 0:0:0:0:0:0:0, which is usually abbreviated to ::. It has two general purposes:

18. If a host has no unicast address when started, it uses the unspecified address as the source address to send an RS packet to obtain prefix information from the gateway and thereby generate a unicast address.
19. When an IPv6 address is configured for a host, the device detects whether the address conflicts with addresses of other hosts in the same network segment and uses the unspecified address as the source address to send a Neighbor Solicitation (NS) packet (similar to a free ARP packet).

- Loopback address

The loopback address is 0:0:0:0:0:0:1, which is usually abbreviated to ::1. Similar to IPv4 address 127.0.0.1, the loopback address is generally used by a node to send itself packets.

- Link-local address

The format of a link-local address is as follows:

Figure 3- 2

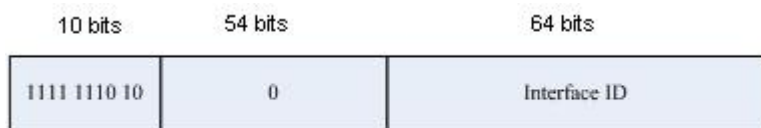

The link-local address is used on a single network link to assign IDs to hosts. The address identified by the first 10 bits in the prefix is the link-local address. A device never forwards packets in which the source or destination address contains the link-local address. The intermediate 54 bits in the address are all 0s. The last 64 bits represent the interface ID, which allows a single network to connect 2⁶⁴-1 hosts.

- Site-local address

The format of a site-local address is as follows:

Figure 3- 3

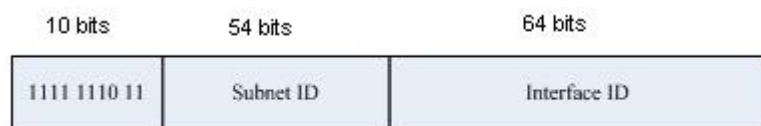

A site-local address is used to transmit data within a site. A device never forwards packets in which the source or destination address contains the site-local address to the Internet. That is, these packets can be forwarded only within the site. A site can be assumed as an enterprise's local area network (LAN). Such addresses are similar to IPv4 private addresses such as 192.168.0.0/16. RFC 3879 has abolished site-local addresses. New addresses do not support the first 10 bits as the prefix and are all regarded as global unicast addresses. Existing addresses can continue to use this prefix.

- Global unicast address

The format of a global unicast address is as follows:

Figure 3-4



Among global unicast addresses, there is a type of IPv4-embedded IPv6 addresses, including IPv4-compatible IPv6 addresses and IPv4-mapped IPv6 addresses. They are used for interconnection between IPv4 nodes and IPv6 nodes.

The format of an IPv4-compatible IPv6 address is as follows:

Figure 3-5

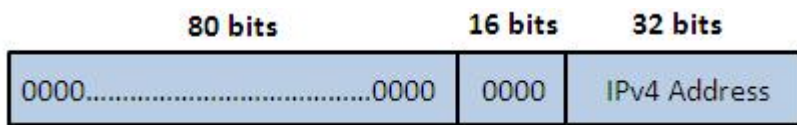

The format of an IPv4-mapped IPv6 address is as follows:

Figure 3-6

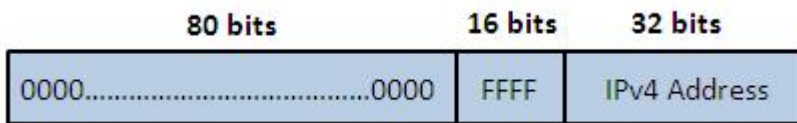

IPv4-compatible IPv6 addresses are mainly used on automatic tunnels. Nodes on automatic tunnels support both IPv4 and IPv6. Using these addresses, IPv4 devices transmit IPv6 packets over tunnels. At present, IPv4-compatible IPv6 addresses have been abolished. IPv4-mapped IPv6 addresses are used by IPv6 nodes to access IPv4-only nodes. For example, if the IPv6 application on an IPv4/IPv6 host requests to resolve the name of an IPv4-only host, the name server dynamically generates an IPv4-mapped IPv6 address and returns it to the IPv6 application.

↘ Multicast Addresses

The format of an IPv6 multicast address is as follows:

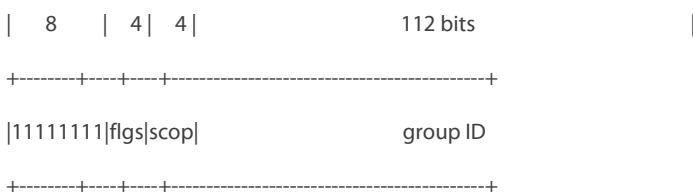

The first byte in the address is all 1s, representing a multicast address.

- Flag field

The flag field consists of four bits. Currently only the fourth bit is specified to indicate whether this address is a known multicast address assigned by the Internet Assigned Numbers Authority (IANA) or a temporary multicast address in a certain scenario. If the flag bit is 0, this address is a known multicast address. If the flag bit is 1, this address is a temporary multicast address. The remaining three flag bits are reserved for future use.

- Scope field

The scope field consists of four bits to indicate the multicast range. That is, a multicast group includes the local node, local link, local site, and any node in the IPv6 global address space.

- Group ID field

The group ID consists of 112 bits to identify a multicast group. A multicast ID can represent different groups based on the flag and scope fields.

IPv6 multicast addresses are prefixed with FF00::/8. One IPv6 multicast address usually identifies interfaces on a series of different nodes. After a packet is sent to a multicast address, the packet is then forwarded to the interfaces on each node identified by this multicast address. For a node (host or device), you must add the following multicast addresses:

1. Multicast address for all nodes on the local link, that is, FF02::1
2. Solicited-node multicast address, prefixed with FF02:0:0:0:1:FF00:0000/104

If the node is a device, it also has to be added to the multicast address of all devices on the local link, that is, FF02::2.

The solicited-node multicast address corresponds to the IPv6 unicast and anycast address. You must add a corresponding solicited-node multicast address for each configured unicast and anycast address of an IPv6 node. The solicited-node multicast address is prefixed with FF02:0:0:0:1:FF00:0000/104. The remaining 24 bits are composed of the least significant 24 bits of the unicast or anycast address. For example, if the unicast address is FE80::2AA:FF:FE21:1234, the solicited-node multicast address is FF02::1:FF21:1234.

The solicited-node multicast address is usually used in NS packets. Its address format is as follows:

Figure 3- 7

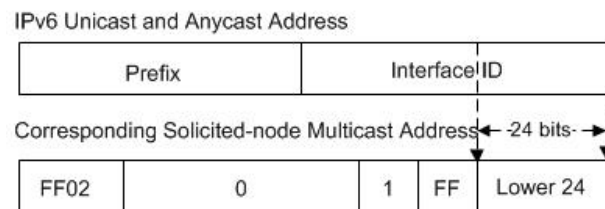

↘ Anycast Addresses

Similar to a multicast address, an anycast address can also be shared by multiple nodes. The difference is that only one node in the anycast address receives data packets while all nodes included in the multicast address receive data packets. Since anycast addresses are allocated to the normal IPv6 unicast address space, they have the same formats with unicast addresses. Every member in an anycast address must be configured explicitly for easier recognition.

Anycast addresses can be allocated only to devices and cannot be used as source addresses of packets.

RFC 2373 redefines an anycast address called subnet-router anycast address. Figure 3- 8 shows the format of a subnet-router anycast address. Such an address consists of the subnet prefix and a series of 0s (interface ID).

The subnet prefix identifies a specified link (subnet). Packets destined to the subnet-router anycast address will be forwarded to a device on this subnet. A subnet-router anycast address is usually used by the application on a node to communicate with a device on a remote subnet.

Figure 3- 8

Format of a Subnet-router Anycast Address

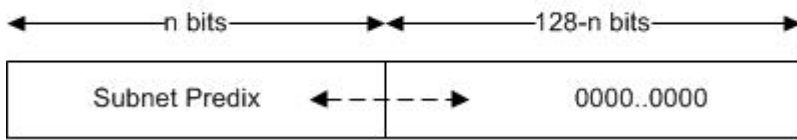

Related Configuration

▾ Configuring an IPv6 Address

- No IPv6 address is configured on interfaces by default.
- Run the **ipv6 address** command to configure the IPv6 unicast address and anycast address of an interface.
- After an interface goes up, it will automatically join the corresponding multicast group.

3.3.3 IPv6 Packet Header Format

Figure 3-9 shows the format of the IPv6 packet header.

Figure 3-9

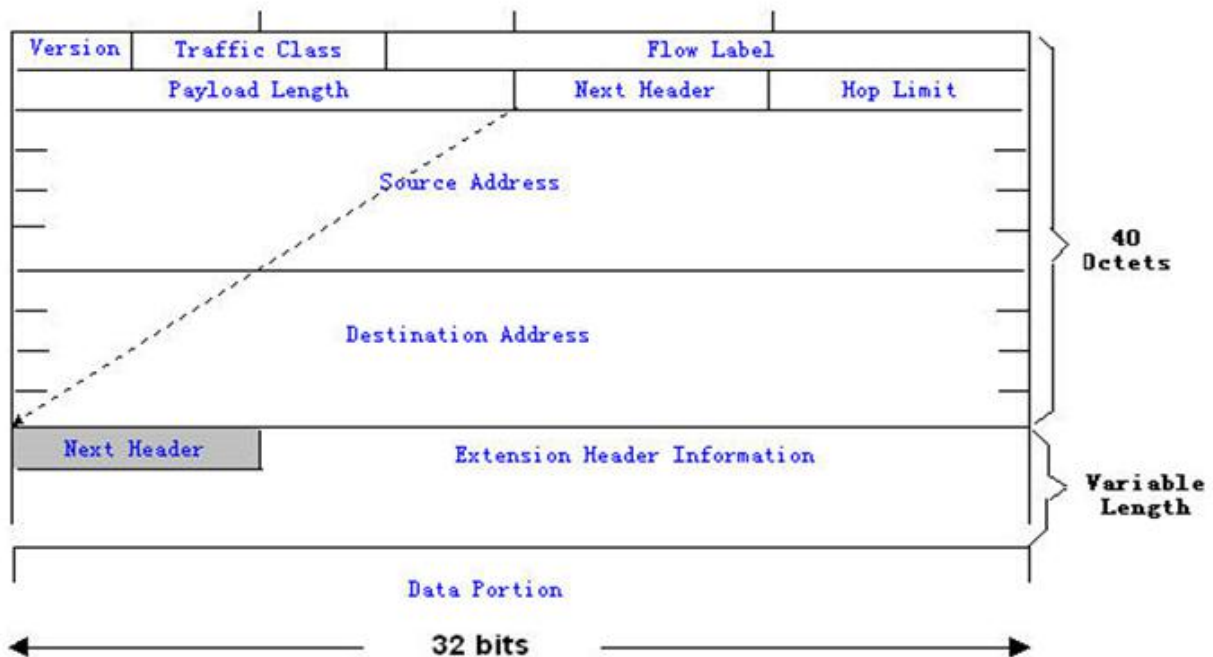

The IPv4 packet header is in unit of four bytes. The IPv6 packet header consists of 40 bytes, in unit of eight bytes. The IPv6 packet header has the following fields:

- Version

This field consists of 4 bits. In an IPv6 address, this field must be 6.

- Traffic Class

This field consists of 8 bits. This field indicates the service provided by this packet, similar to the TOS field in an IPv4 address.

- Flow Label

This field consists of 20 bits to identify packets belonging to the same service flow. One node can act as the Tx source of multiple service flows. The flow label and source address uniquely identify one service flow.

- Payload Length

This field consists of 16 bits, including the packet payload length and the length of IPv6 extended options (if available). That is, it includes the IPv6 packet length except the IPv6 packet header.

- Next Header

This field indicates the protocol type in the header field following the IPv6 packet header. Similar to the Protocol field in the IPv4 address header, the Next Header field is used to indicate whether the upper layer uses TCP or UDP. It can also be used to indicate existence of the IPv6 extension header.

- Hop Limit

This field consists of 8 bits. Every time a device forwards a packet, the field value reduced by 1. If the field value reaches 0, this packet will be discarded. It is similar to the Lifetime field in the IPv4 packet header.

- Source Address

This field consists of 128 bits and indicates the sender address in an IPv6 packet.

- Destination Address

This field consists of 128 bits and indicates the receiver address in an IPv6 packet.

At present, IPv6 defines the following extension headers:

- Hop-By-Hop Options

This extension header must follow the IPv6 packet header. It consists of option data to be checked on each node along the path.

- Routing Options (Type 0 routing header)

This extension header indicates the nodes that a packet passes through from the source address to the destination address. It consists of the address list of the passerby nodes. The initial destination address in the IPv6 packet header is the first address among the addresses in the routing header, but not the final destination address of the packet. After the node corresponding to the destination address in the IPv6 packet header receives a packet, it processes the IPv6 packet header and routing header, and sends the packet to the second address, the third address, and so on in the routing header list till the packet reaches the final destination address.

- Fragment

The source node uses this extension header to fragment the packets of which the length exceeds the path MTU (PMTU).

- Destination Options

This extension header replaces the option fields of IPv4. At present, the Destination Options field can only be filled with integral multiples of 64 bits (eight bytes) if required. This extension header can be used to carry information to be checked by the destination node.

- Upper-layer header

This extension header indicates the protocol used at the upper layer, such as TCP (6) and UDP (17).

Another two extension headers AH and ESP will be described in the *Configuring IPsec*.

3.3.4 IPv6 PMTUD

Similar to IPv4 Path MTU Discovery (PMTUD), IPv6 PMTUD allows a host to dynamically discover and adjust the MTU size on the data Tx path. If the length of a data packet to be sent by a host is greater than the PMTU, the host performs packet fragmentation on its own. In this manner, the IPv6 device does not need to perform fragmentation, saving device resources and improving the IPv6 network efficiency.

Figure 3- 10

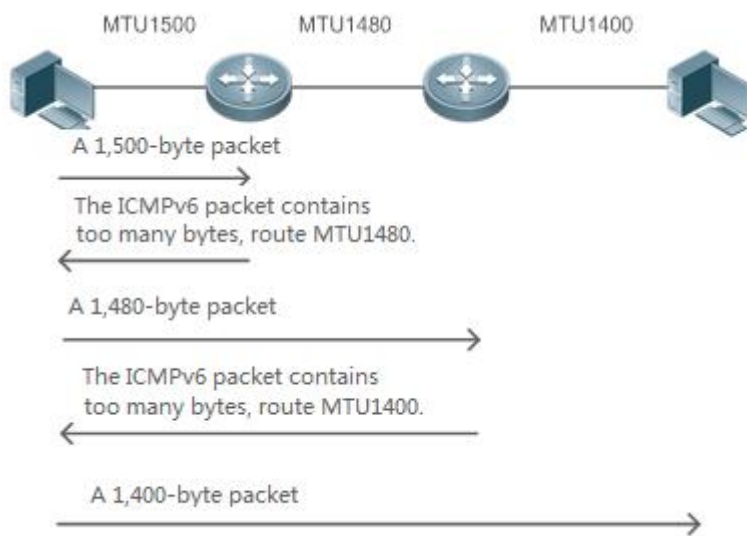

As shown in Figure 3- 10, if the length of a packet to be sent by the host is greater than the PMTU, the router discards this packet and sends an ICMPv6 Packet Too Big message containing its PMTU to the host. The host then fragments the packet based on the new PMTU. In this manner, the router does not need to perform fragmentation, saving router resources and improving the IPv6 network efficiency.

Related Configuration

✚ Configuring the IPv6 MTU of an Interface

- The default IPv6 MTU is 1500 on an Ethernet interface.
- To reduce traffic caused by dropping packets, a proper MTU value needs to be set according to the actual networking environment. Run the **ipv6 mtu** command to modify the IPv6 MTU of an interface.

3.3.5 IPv6 Neighbor Discovery

NDP is a basic part of IPv6. Its main functions include router discovery, prefix discovery, parameter discovery, address auto-configuration, address resolution (like ARP), next-hop determination, NUD, DAD, and redirection. NDP defines five ICMP packets: RS (ICMP type: 133), RA (ICMP type: 134), NS (similar to ARP request, ICMP type: 135), NA (similar to ARP reply, ICMP type: 136), ICMP Redirect (ICMP type: 137).

All the above ICMP packets carry one or multiple options. These options are optional in some cases but are significant in other cases. NDP mainly defines five options: Source Link-Layer Address Option, Type=1; Target Link-Layer Address Option, Type=2; Prefix Information Option, Type=3; Redirection Header Option, Type=4; MTU Option, Type=5.

➤ **Address Resolution**

When a node attempts to communicate with another, the node has to obtain the link-layer address of the peer end by sending it an NS packet. In this packet, the destination address is the solicited-node multicast address corresponding to the IPv6 address of the destination node. This packet also contains the link-layer address of the source node. After receiving this NS packet, the peer end replies with an NA packet in which the destination address is the source address of the NS packet, that is, the link-layer address of the solicited node. After receiving this NA packet, the source node can communicate with the destination node.

Figure 3- 11 shows the address resolution process.

Figure 3- 11

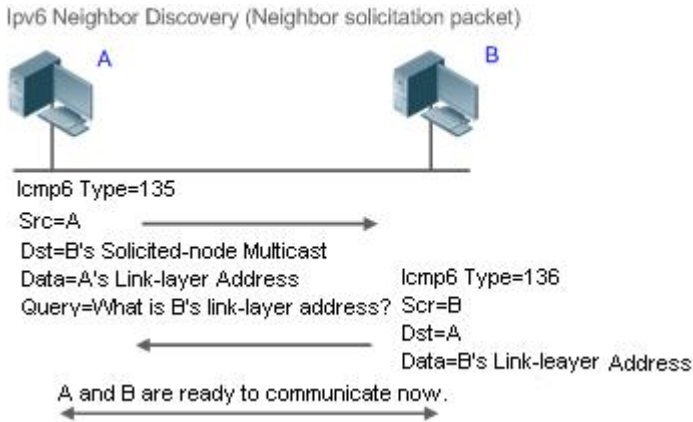

➤ **NUD**

If the reachable time of a neighbor has elapsed but an IPv6 unicast packet needs to be sent to it, the device performs NUD.

While performing NUD, the device can continue to forward IPv6 packets to the neighbor.

➤ **DAD**

To know whether the IPv6 address configured for a host is unique, the device needs to perform DAD by sending an NS packet in which the source IPv6 address is the unspecified address.

If a device detects an address conflict, this address is set to the duplicate status so that the device cannot receive IPv6 packets with this address being the destination address. Meanwhile, the device also starts a timer for this duplicate address to periodically perform DAD. If no address conflict is detected in re-detection, this address can be properly used.

➤ **Router, Prefix, and Parameter Discovery**

A device periodically sends RA packets to all local nodes on the link.

Figure 3- 12 shows the RA packet sending process.

Figure 3- 12

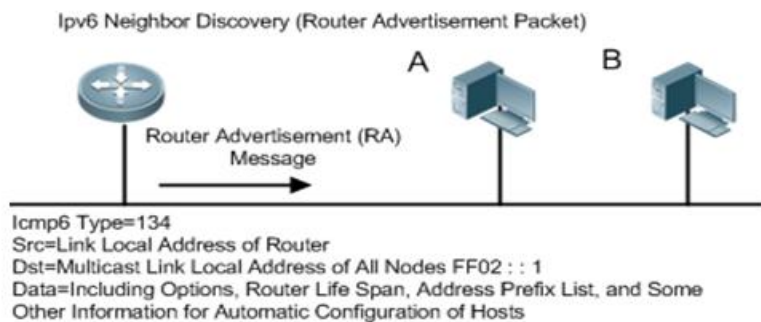

An RA packet usually contains the following content:

- One or multiple IPv6 address prefixes (used for on-link determination or stateless address auto-configuration)
- Validity of the IPv6 address prefix
- Host auto-configuration method (stateful or stateless)
- Default device information (whether the device acts as the default device; if yes, the interval for acting as the default device is also included.)
- Other information provided for host configuration, such as hop limit, MTU, and NS retransmission interval
- Routing priority

RA packets can also be used as replies to the RS packets sent by a host. Using RS packets, a host can obtain the auto-configured information immediately after started rather than wait for the RA packets sent by the device. If no unicast address is configured for a newly started host, the host includes the unspecified address (0:0:0:0:0:0:0:0) as the source address in the RS packet. Otherwise, the host uses the configured unicast address as the source address and the multicast address of all local routing devices (FF02::2) as the destination address in the RS packet. As an reply to the RS packet, the RA packet uses the source address of the RS packet as the destination address (if the source address is the unspecified address, it uses the multicast address of all local nodes (FF02::1).

In an RA packet, the following parameters can be configured:

- Ra-interval: Interval for sending the RA packet.
- Ra-lifetime: Lifetime of a router, that is, whether the device acts as the default router on the local link and the interval for acting as the default router.
- Prefix: Prefix of an IPv6 address on the local link. It is used for on-link determination or stateless address auto-configuration, including other parameter configurations related to the prefix.
- Ns-interval: NS packet retransmission interval.
- Reachabletime: Period when the device regards a neighbor reachable after detecting a Confirm Neighbor Reachability event.
- Ra-hoplimit: Hops of the RA packet, used to set the hop limit for a host to send a unicast packet.
- Ra-mtu: MTU of the RA packet.
- Managed-config-flag: Whether a host receiving this RA packet obtains the address through stateful auto-configuration.
- Other-config-flag: Whether a host receiving this RA packet uses DHCPv6 to obtain other information except the IPv6 address for auto-configuration.

Configure the above parameters when configuring IPv6 interface attributes.

- The RDNSS and DNSSL options provide IPv6 terminals with the addresses of recursive DNS servers and a search list of DNS domain names.
- The URL options offers URLs to IPv6 terminals.

↘ **Redirection**

If a router receiving an IPv6 packet finds a better next hop, it sends the ICMP Redirect packet to inform the host of the better next hop. The host will directly send the IPv6 packet to the better next hop next time.

↘ **Maximum Number of Unresolved ND Entries**

- You can configure the maximum number of unresolved ND entries to prevent malicious scanning network segments from generating a large number of unresolved ND entries and occupying excessive memory space.

↘ **Maximum Number of Neighbor Learning Entries on an Interface**

- You can configure the maximum number of neighbor learning entries on an interface to prevent neighbor learning attacks from occupying ND entries and memory space of the device and affecting forwarding efficiency of the device.

Related Configuration

↘ **Enabling IPv6 Redirection**

- By default, ICMPv6 Redirect packets can be sent on IPv6 interfaces.
- Run the **no ipv6 redirects** command in interface configuration mode to prohibit an interface from sending Redirect packets.

↘ **Configuring IPv6 DAD**

- By default, an interface sends one NS packet to perform IPv6 DAD.
- Run the **ipv6 nd dad attempts value** command in interface configuration mode to configure the number of NS packets consecutively sent by DAD. Value 0 indicates disabling DAD for IPv6 addresses on this interface.
- Run the **no ipv6 nd dad attempts** command to restore the default configuration.
- By default, the device performs DAD on duplicate IPv6 addresses every 60 seconds.
- Run the **ipv6 nd dad retry value** command in global configuration mode to configure the DAD interval. Value 0 indicates disabling DAD for the device.
- Run the **no ipv6 nd dad retry** command to restore the default configuration.

↘ **Configuring the Reachable Time of a Neighbor**

- The default reachable time of an IPv6 neighbor is 30s.
- Run the **ipv6 nd reachable-time milliseconds** command in interface configuration mode to modify the reachable time of a neighbor.

↘ **Configuring the Stale Time of a Neighbor**

- The default stale time of an IPv6 neighbor is 1 hour. After the time elapses, the device performs NUD.
- Run the **ipv6 nd stale-time seconds** command in interface configuration mode to modify the stale time of a neighbor.

↘ **Configuring Prefix Information**

- By default, the prefix in an RA packet on an interface is the prefix configured in the **ipv6 address** command on the interface.
- Run the **ipv6 nd prefix** command in interface configuration mode to add or delete prefixes and prefix parameters that can be advertised.

➤ **Enabling/disabling RA Suppression**

- By default, an IPv6 interface does not send RA packets.
- Run the **no ipv6 nd suppress-ra** command in interface configuration mode to disable RA suppression.

➤ **Configuring the Maximum Number of Unresolved ND Entries**

- The default value is 0, indicating no restriction. It is only restricted to the ND entry capacity supported by the device.
- Run the **ipv6 nd unresolved number** command in global configuration mode to restrict the number of unresolved neighbors. After the entries exceed this restriction, the device does not actively resolve subsequent packets.

➤ **Configuring the Maximum Number of ND Entries Learned on an Interface**

- Run the **ipv6 nd cache interface-limit value** command in interface configuration mode to restrict the number of neighbors learned on an interface. The default value is 0, indicating no restriction.

3.3.6IPv6 Source Routing

Working Principle

Similar to the IPv4 loose source routing and loose record routing options, the IPv6 routing header is used to specify the intermediate nodes that the packet passes through along the path to the destination address. It uses the following format:

Figure 3- 13

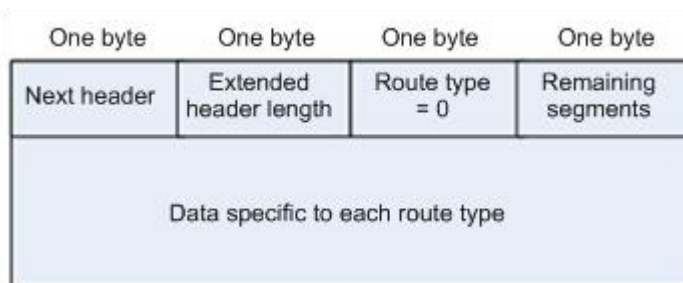

The Segments Left field is used to indicate how many intermediate nodes are specified in the routing header for the packet to pass through from the current node to the final destination address.

Currently, two routing types are defined: 0 and 2. The Type 2 routing header is used for mobile communication. RFC 2460 defines the Type 0 routing header (similar to the loose source routing option of IPv4). The format of the Type 0 routing header is as follows:

Figure 3- 14

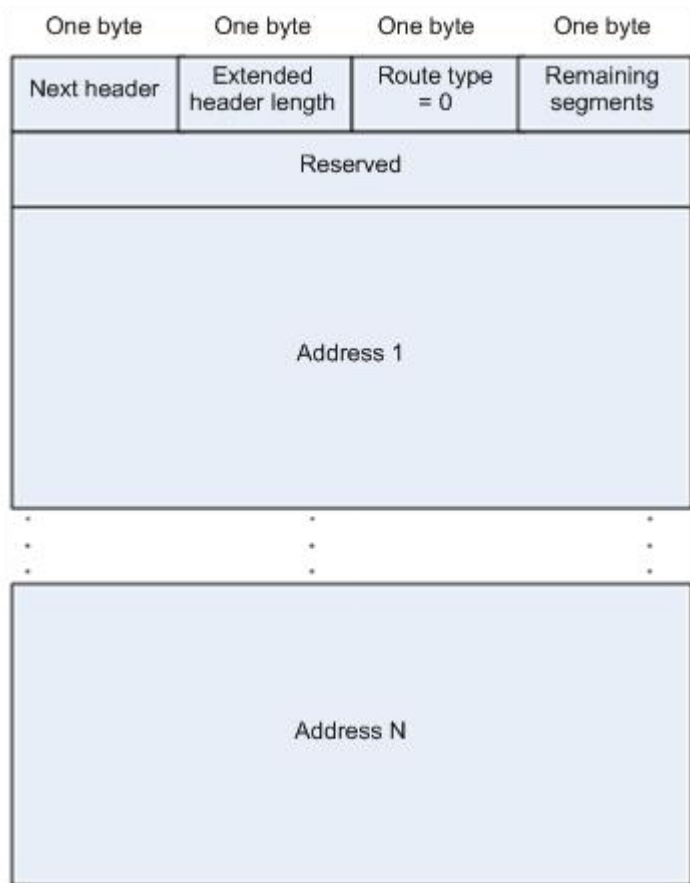

The following example describes the application of the Type 0 routing header, as shown in Figure 3- 15.

Figure 3- 15

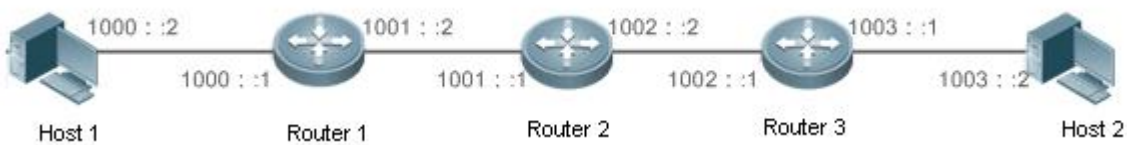

Host 1 sends Host 2 a packet specifying the intermediate nodes Router 2 and Router 3. The following table lists the changes of fields related to the IPv6 header and routing header during the forwarding process.

Transmission Node	Fields in the IPv6 Header	Fields Related to the Type 0 Routing Header
Host 1	Source address=1000::2 Destination address=1001::1 (Address of Router 2)	Segments Left=2 Address 1=1002::1 (Address of Router 3) Address 2=1003::2 (Address of Host 2)
Router 1	No change	
Router 2	Source address=1000::2 Destination address=1002::1 (Address of Router 3)	Segments Left=1 Address 1=1001::1 (Address of Router 2) Address 2=1003::2 (Address of Host 2)
Router 3	Source address=1000::2 Destination address=1003::2 (Address of Host 2)	Segments Left=0 Address 1=1001::1 (Address of Router 2) Address 1=1002::2 (Address of Router 3)

Host 2	No change
--------	-----------

The forwarding process is as follows:

1. Host 1 sends a packet in which the destination address is Router 2's address 1001::1, the Type 0 routing header is filled with Router 3's address 1002::1 and Host 2's address 1003::2, and the value of the Segments Left field is 2.
2. Router 1 forwards this packet to Router 2.
3. Router 2 changes the destination address in the IPv6 header to Address 1 in the routing header. That is, the destination address becomes Router 3's address 1002::1, Address 1 in the routing header becomes Router 2's address 1001::1, and the value of the Segments Left field becomes 1. After modification, Router 2 forwards the packet to Router 3.
4. Router 3 changes the destination address in the IPv6 header to Address 2 in the routing header. That is, the destination address becomes Host 2's address 1003::2, Address 2 in the routing header becomes Router 3's address 1002::1, and the value of the Segments Left field becomes 0. After modification, Router 3 forwards the packet to Host 2.

The Type 0 routing header may be used to initiate DoS attacks. As shown in Figure 3- 16, Host 1 sends packets to Host 2 at 1 Mbps and forges a routing header to cause multiple round-trips between Router 2 and Router 3 (50 times from Router 2 to Router 3 and 49 times from Router 3 to Router 2). At the time, the routing header generates the traffic amplification effect:" 50 Mbps from Router 2 to Router 3 and 49 Mbps from Router 3 to Router 2." Due to this security problem, RFC 5095 abolished the Type 0 routing header.

Figure 3- 16

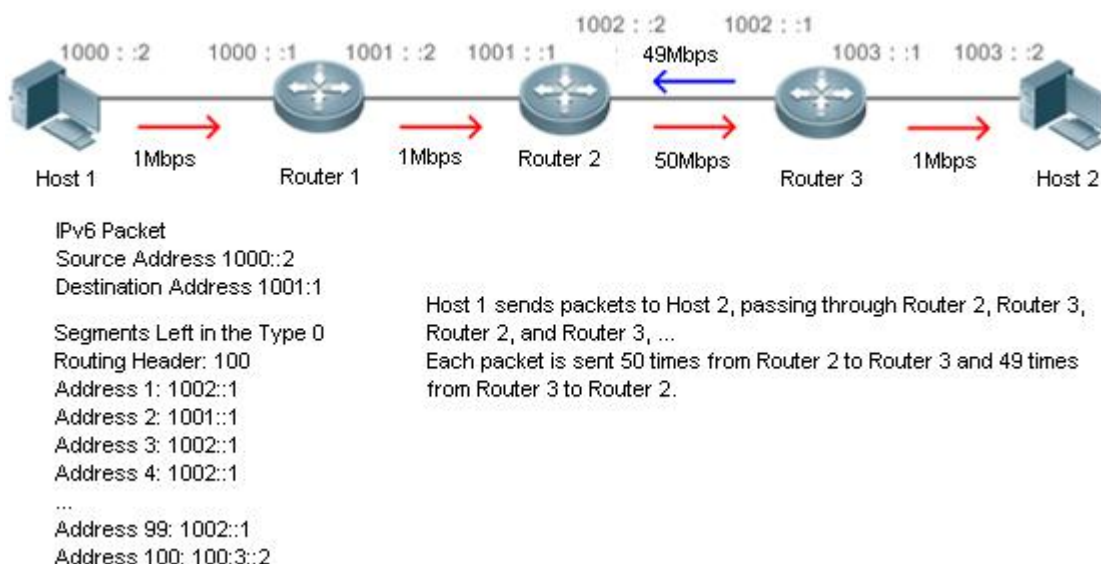

Related Configuration

Enabling IPv6 Source Routing

- The Type 0 routing header is not supported by default.
- Run the **ipv6 source-route** command in global configuration mode to enable IPv6 source routing.

3.3.7 Restricting the Sending Rate of ICMPv6 Error Messages

Working Principle

The destination node or intermediate router sends ICMPv6 error messages to report the errors incurred during IPv6 data packet forwarding and transmission. There are mainly four types of error messages: Destination Unreachable, Packet Too Big, Time Exceeded, and Parameter Problem.

When receiving an invalid IPv6 packet, a device discards the packet and sends back an ICMPv6 error message to the source IPv6 address. In the case of invalid IPv6 packet attacks, the device may continuously reply to ICMPv6 error messages till device resources are exhausted and thereby fail to properly provide services. To solve this problem, you can restrict the sending rate of ICMPv6 error messages.

If the length of an IPv6 packet to be forwarded exceeds the IPv6 MTU of the outbound interface, the router discards this IPv6 packet and sends back an ICMPv6 Packet Too Big message to the source IPv6 address. This error message is mainly used as part of the IPv6 PMTUD process. If the sending rate of ICMPv6 error messages is restricted due to excessive other ICMPv6 error messages, ICMPv6 Packet Too Big messages may be filtered, causing failure of IPv6 PMTUD. Therefore, it is recommended to restrict the sending rate of ICMPv6 Packet Too Big messages independently of other ICMPv6 error messages.

Although ICMPv6 Redirect packets are not ICMPv6 error messages, FS recommends restricting their rates together with ICMPv6 error messages except Packet Too Big messages.

Related Configuration

✚ Configuring the Sending Rate of ICMPv6 Packet Too Big Messages

- The default rate is 10 per 100 ms.
- Run the **ipv6 icmp error-interval too-big** command to configure the sending rate of ICMPv6 Packet Too Big messages.

✚ Configuring the Sending Rate of Other ICMPv6 Error Messages

- The default rate is 10 per 100 ms.
- Run the **ipv6 icmp error-interval** command to configure the sending rate of other ICMPv6 error messages.

3.3.8 IPv6 Hop Limit

Working Principle

An IPv6 data packet passes through routers from the source address and destination address. If a hop limit is configured, it decreases by one every time the packet passes through a router. When the hop limit decreases to 0, the router discards the packet to prevent this useless packet from being unlimitedly transmitted on the network and wasting network bandwidth. The hop limit is similar to the TTL of IPv4.

Related Configuration

✚ Configuring the IPv6 Hop Limit

- The default IPv6 hop limit of a device is 64.
- Run the **ipv6 hop-limit** command to configure the IPv6 hop limit of a device.

3.3.9 Refraining from Sending NS Packets to Authentication VLANs

Working Principle

In gateway authentication mode, all sub VLANs in a super VLAN are authentication VLANs by default. Users in an authentication VLAN have to pass authentication to access the network. After authentication, a static ND entry is generated on the device. Therefore, when

accessing an authenticated user, the device does not need to send NS packets to the authentication VLAN. If the device attempts to access users in an authentication-free VLAN, it only needs to send NS requests to the authentication-free VLAN.

In gateway authentication mode, the function of refraining from sending NS packets to authentication VLANs is enabled on the device by default. If the device needs to access authentication-free users in an authentication VLAN, disable this function.

Related Configuration

▾ Enabling the Function of Refraining from Sending NS Packets to Authentication VLANs

- Run the **ipv6 nd suppress-auth-vlan-ns** command in interface configuration mode to enable the function of refraining from sending NS packets to authentication VLANs.
- This function is enabled by default.
- This function is supported only on switch virtual interfaces (SVIs) and takes effect only in gateway authentication mode.

3.3.10 Default Gateway on the Management Interface

Working Principle

The default gateway is configured on the management interface to generate a default route for this interface.

Related Configuration

▾ Configuring the Default Gateway on the Management Interface

- Run the **ipv6 gateway *ipv6-address*** command in interface configuration mode to configure the default gateway on the management interface.
- No default gateway is configured on the management interface by default.

3.3.11 Configuring the Source Address of ICMPv6 Packets

Working Principle

In a network with a large number of IPv6 addresses configured, it is complex for receivers to recognize from which device ICMPv6 packets are sent. To simplify the judgement, you can choose a specified address, like the address of the loopback interface, as the source address for ICMPv6 packets.

Related Configuration

▾ Configuring the Source Address of ICMPv6 Packets

- Run the **ipv6 icmp source [*vrf vrf-name*] *ipv6-address*** command in global configuration mode.

3.3.12 Enabling Statistics of ND Packets

Working Principle

After this feature is enabled, the number of ND packets received by or sent from the gateway is counted, and their rates within the specified period are calculated.

Related Configuration

▾ Configuring the Interval Between Two Samplings of ND Packets

- Run the **ipv6 nd rate-statistics interval seconds** command in global configuration mode.

3.3.13 Enabling Fast Removal of ND Entries

Working Principle

When L2 ports get down, their corresponding ND entries are fast deleted for fast routing convergence.

Related Configuration

▾ Enabling Fast Removal of ND Entries

- Run the **ipv6 nd l2port-down fast-delete** command in interface configuration mode.
- By default, this feature is disabled.

3.3.14 Enabling an Interface to Learn ND Entries Via DAD NS Packets

Working Principle

After this command is run, when the interface receives DAD NS packets, ND entries with the status of Stale will be created.

Related Configuration

▾ Enabling an Interface to Learn ND Entries Via DAD NS Packets

- Run the **ipv6 nd dad learning enable** command in interface configuration mode.

3.3.15 Enabling Generating of Host Routes After EVPN Synchronizes ND Entries to Overlay Router Interfaces

Working Principle



By default, host routes are not generated when EVPN synchronizes ARP or ND entries to Overlay router interfaces. Therefore, L3 packets are not forwarded based on those entries. You can perform the **no arp vxlan remote-arp inactive** command to enable forwarding of L3 packets.













Related Configuration

▾ Enabling Generating of Host Routes After EVPN Synchronizes ND Entries to Overlay Router Interfaces

- Run the **no ipv6 nd remote inactive** command in interface configuration mode.
- By default, host routes are not generated when EVPN synchronizes ARP or ND entries to Overlay router interfaces.

3.4 Configuration

Configuration	Description and Command
Configuring an IPv6 Address	 (Mandatory) It is used to configure IPv6 addresses and enable IPv6.
	ipv6 enable Enables IPv6 on an interface.
	ipv6 address Configures the IPv6 unicast address of an interface.
Configuring IPv6 NDP	 (Optional) It is used to enable IPv6 redirection on an interface.
	ipv6 redirects Enables IPv6 redirection on an interface.

Configuration	Description and Command	
	 (Optional) It is used to enable DAD.	
	ipv6 nd dad attempts	Configures the number of consecutive NS packets sent during DAD.
	 (Optional) It is used to configure ND parameters.	
	ipv6 nd reachable-time	Configures the reachable time of a neighbor.
	ipv6 nd prefix	Configures the address prefix to be advertised in an RA packet.
	ipv6 nd suppress-ra	Enables RA suppression on an interface.
	 (Optional) It is used to configure the maximum number of unresolved ND entries.	
	ipv6 nd unresolved	Configures the maximum number of unresolved ND entries.
	 (Optional) It is used to configure the RDNSS and DNSSL options in the RA.	
	ipv6 nd ra dns server	Configures the RDNSS option.
	ipv6 nd ra dns search-list	Configures the DNSSL option.
	 (Optional) It is used to configure the URL for RA.	
	ipv6 nd ra-url	ipv6 nd ra-url
	 (Optional) It is used to configure the maximum number of neighbors learned on an interface.	
ipv6 nd cache interface-limit	Configures the maximum number of neighbors learned on an interface.	
Enabling MTD <u>on an Interface</u>	 (Optional) It is used to restrict the MTU of IPv6 packets sent on an interface.	
	ipv6 mtu	Configures the IPv6 MTU.
Enabling IPv6 Source Routing	 (Optional) It is used to enable IPv6 source routing.	
	ipv6 source-route	Configures the device to forward IPv6 packets carrying the routing header.
Configuring the Sending Rate of ICMPv6 Error Messages	 Optional.	
	ipv6 icmp error-interval too-big	Configures the sending rate of ICMPv6 Packet Too Big messages.
Configuring the IPv6 Hop Limit	 (Optional) It is used to restrict the hop limit of IPv6 unicast packets sent on an interface.	
	ipv6 hop-limit	Configures the IPv6 hop limit.
Enabling Refraining from Sending NS Packets to Authentication VLANs	 (Optional) It is used to restrict sending NS packets to authentication VLANs in gateway authentication mode.	
	ipv6 nd suppress-auth-vlan-ns	Enables NS broadcast suppression in authentication VLANs.
Configuring the Default Gateway on the Management Interface	 (Optional) It is used to configure the default gateway on the management interface.	
	ipv6 gateway ipv6-address	Configures the default gateway on the management interface.

Configuration	Description and Command
Enabling Statistics of ND Packets	(Optional) It is used to configure the interval between two samplings of ND packets.
	ipv6 nd rate-statistics interval <i>seconds</i> Sets the interval between two samplings of ND packets and enables statistics.
Enabling Fast Removal of ND Entries	(Optional) It is used to delete ND entries as soon as L2 ports get down.
	ipv6 nd l2port-down fast-delete Enables fast removal of ND entries when L2 ports get down.
Enabling an Interface to Learn ND Entries Via DAD NS Packets	(Optional) It is used to enable learning of ND entries through DAD NS packets.
	ipv6 nd dad learning enable Enables an interface to learn ND entries via DAD NS packets.
Enabling Generating of Host Routes After EVPN Synchronizes ND Entries to Overlay Router Interfaces	(Optional) It is used to enable generating of host routes after EVPN synchronizes ND entries to Overlay router interfaces.
	no ipv6 nd remote inactive Enables generating of host routes after EVPN synchronizes ND entries to Overlay router interfaces.

3.4.1 Configuring an IPv6 Address

Configuration Effect

Configure the IPv6 address of an interface to implement IPv6 network communication.

Configuration Steps

➤ Enabling IPv6 on an Interface

- (Optional) If you do not want to enable IPv6 by configuring an IPv6 address, run the **ipv6 enable** command.

➤ Configuring the IPv6 Unicast Address of an Interface

- Mandatory.

Verification

Run the **show ipv6 interface** command to check whether the configured address takes effect.

Related Commands

➤ Enabling IPv6 on an Interface

Command	ipv6 enable
Parameter	N/A
Description	
Command Mode	Interface configuration mode
Usage Guide	IPv6 can be enabled on an interface by two methods: 1) running the ipv6 enable command in interface configuration mode; 2) configuring an IPv6 address on the interface. If an interface is bound to a multiprotocol VRF instance configured with no IPv6 address family, IPv6 cannot be enabled on this interface. You can enable IPv6 on this interface only after configuring an IPv6 address family

	<p>for the multiprotocol VRF.</p> <p>If an IPv6 address is configured on an interface, IPv6 is automatically enabled on this interface. In this case, IPv6 cannot be disabled even when you run the no ipv6 enable command.</p>
--	--

➤ **Configuring the IPv6 Unicast Address of an Interface**

Command	<p>ipv6 address <i>ipv6-address / prefix-length</i></p> <p>ipv6 address <i>ipv6-prefix / prefix-length eui-64</i></p> <p>ipv6 address <i>prefix-name sub-bits / prefix-length [eui-64]</i></p>
Parameter Description	<p><i>ipv6-address</i>: Indicates the IPv6 address, which must comply with the address format defined in RFC 4291. Separated by a colon (:), each address field consists of 16 bits and is represented by hexadecimal digits.</p> <p><i>ipv6-prefix</i>: Indicates the IPv6 address prefix, which must comply with the address format defined in RFC 4291.</p> <p><i>prefix-length</i>: Indicates the length of the IPv6 address prefix, that is, the part representing the network in the IPv6 address.</p> <p><i>prefix-name</i>: Indicates the name of the universal prefix. This specified universal prefix is used to create the interface address.</p> <p><i>sub-bits</i>: Indicates the subprefix bits and host bits of the address to be concatenated with the prefixes provided by the general prefix specified with the <i>prefix-name</i> parameter. This value is combined with the universal prefix to create the interface address. This value must be in the form documented in RFC 4291.</p> <p><i>eui-64</i>: Indicates the created IPv6 address, consisting of the configured address prefix and 64-bit interface ID.</p>
Command Mode	Interface configuration mode
Usage Guide	<p> If an interface is bound to a multiprotocol VRF instance configured with no IPv6 address family, the IPv6 address cannot be configured for this interface. You can configure the IPv6 address of this interface only after configuring an IPv6 address family for the multiprotocol VRF.</p> <p>If an IPv6 interface is created and is Up state, the system automatically generates a link-local address for this interface.</p> <p>The IPv6 address of an interface can also be created by the universal prefix mechanism. That is, IPv6 address = Universal prefix + Sub prefix + Host bits. The universal prefix can be configured by running the ipv6 general-prefix command or learned by the prefix discovery function of the DHCPv6 client (see the <i>Configuring DHCPv6</i>). Sub prefix + Host bits are specified by the <i>sub-bits</i> and <i>prefix-length</i> parameters in the ipv6 address command.</p> <p>If you run the no ipv6 address command without specifying an address, all manually configured addresses will be deleted.</p> <p>Run the no ipv6 address <i>ipv6-prefix/prefix-length eui-64</i> command to delete the configured address.</p>

Configuration Example

➤ **Configuring an IPv6 Address on an Interface**

Configuration Steps	Enable IPv6 on the GigabitEthernet 0/0 interface and add IPv6 address 2000::1 to the interface.
	<pre>FS(config)#interface gigabitEthernet 0/0 FS(config-if-GigabitEthernet 0/0)#ipv6 enable FS(config-if-GigabitEthernet 0/0)#ipv6 address 2000::1/64</pre>

Verification	Run the show ipv6 interface command to verify that an address is successfully added to the GigabitEthernet 0/0 interface.
	<pre> FS(config-if-GigabitEthernet 0/0)#show ipv6 interface gigabitEthernet 0/0 interface GigabitEthernet 0/0 is Down, ifindex: 1, vrf_id 0 address(es): Mac Address: 00:00:00:00:00:00 INET6: FE80::200:FF:FE00:1 [TENTATIVE], subnet is FE80::/64 INET6: 2000::1 [TENTATIVE], subnet is 2000::/64 Joined group address(es): MTU is 1500 bytes ICMP error messages limited to one every 100 milliseconds ICMP redirects are enabled ND DAD is enabled, number of DAD attempts: 1 ND reachable time is 30000 milliseconds ND advertised reachable time is 0 milliseconds ND retransmit interval is 1000 milliseconds ND advertised retransmit interval is 0 milliseconds ND router advertisements are sent every 200 seconds<160--240> ND router advertisements live for 1800 seconds </pre>

3.4.2 Configuring IPv6 NDP

Configuration Effect

Configure NDP-related attributes, for example, enable IPv6 redirection and DAD.

Notes

RA suppression is enabled on interfaces by default. To configure a device to send RA packets, run the **no ipv6 nd suppress-ra** command in interface configuration mode.

Configuration Steps

➤ Enabling IPv6 Redirection on an Interface

- (Optional) IPv6 redirection is enabled by default.
- To disable IPv6 redirection on an interface, run the **no ipv6 redirects** command.

➤ Configuring the Number of Consecutive NS Packets Sent During DAD

- Optional.

- To prevent enabling DAD for IPv6 addresses on an interface or modify the number of consecutive NS packets sent during DAD, run the **ipv6 nd dad attempts** command.

➤ **Configuring the Reachable Time of a Neighbor**

- Optional.
- To modify the reachable time of a neighbor, run the **ipv6 nd reachable-time** command.

➤ **Configuring the Address Prefix to Be Advertised in an RA Packet**

- By default, the prefix in an RA packet on an interface is the prefix configured in the **ipv6 address** command on the interface.
- (Optional) Run the **ipv6 nd prefix** command to add or delete prefixes and prefix parameters that can be advertised.

➤ **Enabling/Disabling RA Suppression on an Interface**

- Optional.
- If a device needs to send RA packets, run the **no ipv6 nd suppress-ra** command.

➤ **Configuring the Maximum Number of Unresolved ND Entries**

- Optional.
- If a large number of unresolved ND entries are generated due to scanning attacks, run the **ipv6 nd unresolved** command to restrict the number of unresolved neighbors.

➤ **Configuring the Maximum Number of ND Entries Learned on an Interface**

- Optional.
- If the number of IPv6 hosts is controllable, run the **ipv6 nd cache interface-limit** command to restrict the number of neighbors learned on an interface. This prevents ND learning attacks from occupying the memory space and affecting device performance.

Verification

Run the following commands to check whether the configuration is correct:

- **show ipv6 interface** *interface-type interface-num*: Check whether the configurations such as the redirection function, reachable time of a neighbor, and NS sending interval take effect.
- **show ipv6 interface** *interface-type interface-num ra-inifo*: Check whether the prefix and other information configured for RA packets are correct.
- **show run**

Related Commands

➤ **Enabling IPv6 Redirection on an Interface**

Command	ipv6 redirects
Parameter	N/A
Description	
Command Mode	Interface configuration mode
Usage Guide	All ICMPv6 error messages are transmitted at a limited transmission rate. By default, a maximum number of 10

	ICMPv6 error messages are transmitted per second (10 pps).
--	--

↘ **Configuring the Number of Consecutive NS Packets Sent During DAD**

Command	ipv6 nd dad attempts <i>value</i>
Parameter Description	<i>value</i> : Indicates the number of NS packets.
Command Mode	Interface configuration mode
Usage Guide	You need to enable DAD before configuring an IPv6 address on an interface. Then the address is in tentative state. If no address conflict is detected by DAD, this address can be correctly used. If an address conflict is detected and the interface ID of this address uses EUI-64, duplicate link-layer addresses exist on this link. In this case, the system automatically disables this interface to prevent IPv6-related operations on this interface). At the time, you must configure a new address and restart the interface to re-enable DAD. When an interface changes from the down state to the up state, DAD is re-enabled for the addresses on this interface.

↘ **Configuring the Reachable Time of a Neighbor**

Command	ipv6 nd reachable-time <i>milliseconds</i>
Parameter Description	<i>milliseconds</i> : Indicates the reachable time of a neighbor, ranging from 0 to 3,600,000. The unit is millisecond. The default value is 30s.
Command Mode	Interface configuration mode
Usage Guide	A device detects unreachable neighbors based on the configured reachable time. The shorter the configured reachable time, the faster the device detects unreachable neighbors but the more it consumes network bandwidth and device resources. Therefore, it is not recommended to set this time too small. The configured value is advertised in an RA packet and is also used on the device. If the value is 0, the reachable time is not specified on the device and it is recommended to use the default value.

↘ **Configuring the Address Prefix to Be Advertised in an RA Packet**

Command	ipv6 nd prefix { <i>ipv6-prefix/prefix-length</i> default } [[<i>valid-lifetime</i> { infinite <i>preferred-lifetime</i> }]] [at <i>valid-date preferred-date</i>] [infinite { infinite <i>preferred-lifetime</i> }]] [no-advertise] [[off-link] [no-autoconfig]]
Parameter Description	<i>ipv6-prefix</i> : Indicates the network ID of IPv6, which must comply with the address representation format in RFC 4291. <i>prefix-length</i> : Indicates the length of the IPv6 address prefix. A slash (/) must be added before the prefix. <i>valid-lifetime</i> : Indicates the period when a host receiving the prefix of an RA packet regards the prefix valid. The value ranges from 0 to 4,294,967,295. The default value is 30 days. <i>preferred-lifetime</i> : Indicates the preferred period when a host receiving the prefix of an RA packet regards the prefix valid. The value ranges from 0 to 4,294,967,295. The default value is 7 days. at <i>valid-date preferred-date</i> : Indicates the valid date and preferred deadline configured for the RA prefix. It uses the format of <i>dd+mm+yyyy+hh+mm</i> . infinite : Indicates that the prefix is permanently valid. default : Indicates that the default parameter configuration is used. no-advertise : Indicates that the prefix is not advertised by a router. off-link : If the prefix of the destination address in the IPv6 packet sent by a host matches the configured prefix, the device regards the destination address on the same link and directly reachable. This parameter indicates that this prefix does not require on-link determination.

	no-autoconfig: Indicates that the prefix in the RA packet received by a host cannot be used for address auto-configuration.
Command Mode	Interface configuration mode
Usage Guide	<p>This command can be used to configure parameters related to each prefix, including whether to advertise this prefix. By default, an RA packet uses the prefix configured by running the ipv6 address command. Run the ipv6 nd prefix command to add other prefixes.</p> <p>Run the ipv6 nd prefix default command to configure the default parameters for an interface. That is, if no parameter is specified when a prefix is added, use the parameters configured in the ipv6 nd prefix default command as the parameters of the new prefix. The default parameter configurations are abandoned once a parameter is specified for the prefix. That is, when you use the ipv6 nd prefix default command to modify the default parameter configurations, only the prefix configured for the default parameters changes and configurations of the prefix remain the same.</p> <p>at valid-date preferred-date: You can specify the valid date of the prefix in two methods: 1) specifying a fixed time for each prefix in an RA packet; 2) specifying the deadline. In the second method, the valid date of the prefix in each RA packet decreases till it becomes 0.</p>

▾ Enabling/Disabling RA Suppression on an Interface

Command	ipv6 nd suppress-ra
Parameter Description	N/A
Command Mode	Interface configuration mode
Usage Guide	To enable RA suppression on an interface, run the ipv6 suppress-ra command.

▾ Configuring the Maximum Number of Unresolved ND Entries

Command	ipv6 nd unresolved number
Parameter Description	<i>number:</i> Indicates the maximum number of unresolved ND entries.
Command Mode	Global configuration mode
Usage Guide	To prevent malicious scanning attacks from creating a large number of unresolved ND entries and occupying entry resources, you can restrict the number of unresolved ND entries.

▾ Configuring the Maximum Number of ND Entries Learned on an Interface

Command	ipv6 nd cache interface-limit value
Parameter Description	<i>value:</i> Indicates the maximum number of neighbors learned by an interface.
Command Mode	Interface configuration mode
Usage Guide	Restricting the number of ND entries learned on an interface can prevent malicious neighbor attacks. If this number is not restricted, a large number of ND entries will be generated on the device, occupying excessive memory space. The configured value must be equal to or greater than the number of the ND entries learned by the interface. Otherwise, the configuration does not take effect. The configuration is subject to the ND entry capacity supported

	by the device.
--	----------------

Configuration Example

➤ **Enabling IPv6 Redirection on an Interface**

Configuration Steps	Enable IPv6 redirection on interface GigabitEthernet 0/0.
	FS(config-if-GigabitEthernet 0/0)#ipv6 redirects
Verification	Run the show ipv6 interface command to check whether the configuration takes effect.
	<pre>FS#show ipv6 interface gigabitEthernet 0/0 interface GigabitEthernet 0/0 is Down, ifindex: 1, vrf_id 0 address(es): Mac Address: 00:00:00:00:00:00 INET6: FE80::200:FF:FE00:1 [TENTATIVE], subnet is FE80::/64 Joined group address(es): MTU is 1500 bytes ICMP error messages limited to one every 100 milliseconds ICMP redirects are enabled ND DAD is enabled, number of DAD attempts: 1 ND reachable time is 30000 milliseconds ND advertised reachable time is 0 milliseconds ND retransmit interval is 1000 milliseconds ND advertised retransmit interval is 0 milliseconds ND router advertisements are sent every 200 seconds<160--240> ND router advertisements live for 1800 seconds</pre>

➤ **Configuring IPv6 DAD**

Configuration Steps	Configure the interface to send three consecutive NS packets during DAD.
	FS(config-if-GigabitEthernet 0/0)# ipv6 nd dad attempts 3
Verification	Run the show ipv6 interface command to check whether the configuration takes effect.
	<pre>FS#show ipv6 interface gigabitEthernet 0/0 interface GigabitEthernet 0/0 is Down, ifindex: 1, vrf_id 0 address(es):</pre>

	<pre> Mac Address: 00:00:00:00:00:00 INET6: FE80::200:FF:FE00:1 [TENTATIVE], subnet is FE80::/64 Joined group address(es): MTU is 1500 bytes ICMP error messages limited to one every 100 milliseconds ICMP redirects are enabled ND DAD is enabled, number of DAD attempts: 3 ND reachable time is 30000 milliseconds ND advertised reachable time is 0 milliseconds ND retransmit interval is 1000 milliseconds ND advertised retransmit interval is 0 milliseconds ND router advertisements are sent every 200 seconds<160--240> ND router advertisements live for 1800 seconds FS(config-if-GigabitEthernet 0/0)# </pre>
--	---

📌 **Configuring Prefix Information in an RA Packet**

Configuration	Add a prefix 1234::/64 to interface GigabitEthernet 0/0.
Steps	<pre> FS(config-if-GigabitEthernet 0/0)#ipv6 nd prefix 1234::/6 </pre>
Verification	Run the show ipv6 interface command to check whether the configuration takes effect.
	<pre> FS#show ipv6 interface gigabitEthernet 0/0 ra-info GigabitEthernet 0/0: DOWN (RA is suppressed) RA timer is stopped waits: 0, initcount: 0 statistics: RA(out/in/inconsistent): 0/0/0, RS(input): 0 Link-layer address: 00:00:00:00:00:00 Physical MTU: 1500 ND router advertisements live for 1800 seconds ND router advertisements are sent every 200 seconds<160--240> Flags: !M!O, Adv MTU: 1500 ND advertised reachable time is 0 milliseconds ND advertised retransmit time is 0 milliseconds ND advertised CurHopLimit is 64 </pre>

Configuration Steps	Add a prefix 1234::/64 to interface GigabitEthernet 0/0.
	<pre>FS(config-if-GigabitEthernet 0/0)#ipv6 nd prefix 1234::/6</pre>
Verification	Run the show ipv6 interface command to check whether the configuration takes effect.
	<pre>Prefixes: <total: 1> 1234::/64(Def, CFG, vlttime: 2592000, pltime: 604800, flags: LA)</pre>

⤵ Configuring RA Packets to Obtain Prefixes from the Prefix Pool

Configuration Steps	Configure RA packets to obtain prefixes from the prefix pool "ra-pool".
	<pre>FS(config-if-GigabitEthernet 0/0)#peel default ipv6 pool ra-pool</pre>
Verification	Run the show run command to check whether the configuration takes effect.
	<pre>FS(config-if-GigabitEthernet 0/0)#show run interface gigabitEthernet 0/0 Building configuration... Current configuration : 125 bytes interface GigabitEthernet 0/0 ipv6 enable no ipv6 nd suppress-ra peel default ipv6 pool ra-pool !</pre>

⤵ Disabling RA Suppression

Configuration Steps	Disable RA suppression on an interface.
	<pre>FS(config-if-GigabitEthernet 0/0)# no ipv6 nd suppress-ra</pre>
Verification	Run the show run command to check whether the configuration takes effect.
	<pre>FS(config-if-GigabitEthernet 0/0)#show run interface gigabitEthernet 0/0 Building configuration... Current configuration : 125 bytes interface GigabitEthernet 0/0 ipv6 enable</pre>

Configuration Steps	Disable RA suppression on an interface.
	<pre>FS(config-if-GigabitEthernet 0/0)# no ipv6 nd suppress-ra</pre>
Verification	Run the show run command to check whether the configuration takes effect.
	<pre>no ipv6 nd suppress-ra !</pre>

⤵ **Configuring the Maximum Number of Unresolved ND Entries**

Configuration Steps	Set the maximum number of unresolved ND entries to 200.
	<pre>FS(config)# ipv6 nd unresolved 200</pre>
Verification	Run the show run command to check whether the configuration takes effect.
	<pre>FS#show run ! ipv6 nd unresolved 200 !</pre>

⤵ **Configuring the Maximum Number of ND Entries Learned on an Interface**

Configuration Steps	Set the maximum number of ND entries learned on an interface to 100.
	<pre>FS(config-if-GigabitEthernet 0/1)# ipv6 nd cache interface-limit 100</pre>
Verification	Run the show run command to check whether the configuration takes effect.
	<pre>FS#show run ! interface GigabitEthernet 0/1 ipv6 nd cache interface-limit 100 !</pre>

3.4.3 Configuring IPv6 MTU on an Interface

Configuration Effect

According to the actual networking environment, configure a proper IPv6 to avoid package loss.

Notes

The IPv6 MTU of an interface must be less than or equal to the interface MTU. Generally, the range of the IPv6 MTU is from 1,280 to 1,500.

Configuration Steps

➤ **Configuring the IPv6 MTU of an Interface**

- Optional.
- When the internet minimum MTU is less than the IPv6 MTU of the interface, use this configuration to set a proper interface MTU.

Verification

- Run the **show run** or **show ipv6 interface** command to check whether the configuration is correct.
- Capture the locally sent IPv6 packets of which the length exceeds the IPv6 MTU. The packet capture result shows that the IPv6 packet is fragmented based on the IPv6 MTU of the interface.

Related Commands

➤ **Configuring the IPv6 MTU of an Interface**

Command	ipv6 mtu bytes
Parameter	<i>bytes</i> : Indicates the MTU of an IPv6 packet, ranging from 1,280 to 1,500. The unit is byte.
Description	
Command	Interface configuration mode
Mode	
Usage Guide	N/A

Configuration Example

➤ **Configuring the IPv6 MTU of an Interface**

Configuration Steps	Change the IPv6 MTU of interface GigabitEthernet 0/0 to 1,300.
	<pre>FS(config-if-GigabitEthernet 0/0)#ipv6 mtu 1300</pre>
Verification	Run the show ipv6 interface command to check whether the configuration takes effect.
	<pre>FS(config-if-GigabitEthernet 0/0)#show ipv6 interface interface GigabitEthernet 0/ is Down, ifindex: 1, vrf_id 0 address(es): Mac Address: 00:d0:f8:22:33:47 INET6: FE80::2D0:F8FF:FE22:3347 [TENTATIVE], subnet is FE80::/64 INET6: 1020::1 [TENTATIVE], subnet is 1020::/64 INET6: 1023::1 [TENTATIVE], subnet is 1023::/64 Joined group address(es): MTU is 1300 bytes ICMP error messages limited to one every 100 milliseconds ICMP redirects are enabled ND DAD is enabled, number of DAD attempts: 1</pre>

Configuration Steps	Change the IPv6 MTU of interface GigabitEthernet 0/0 to 1,300.
	<pre>FS(config-if-GigabitEthernet 0/0)#ipv6 mtu 1300</pre>
Verification	Run the show ipv6 interface command to check whether the configuration takes effect.
	<pre> ND reachable time is 30000 milliseconds ND advertised reachable time is 0 milliseconds ND retransmit interval is 1000 milliseconds ND advertised retransmit interval is 0 milliseconds ND router advertisements are sent every 200 seconds<160--240> ND router advertisements live for 1800 seconds </pre>

3.4.4 Enabling IPv6 Source Routing

Configuration Effect

RFC 5095 abolished the Type 0 routing header. FS devices do not support the Type 0 routing header by default. The administrator can run the **ipv6 source-route** command to in global configuration mode to enable IPv6 source routing.

Configuration Steps

▾ Enabling IPv6 Source Routing

- Optional.
- To enable IPv6 source routing, run the **ipv6 source-route** command.

Verification

The device can properly forward packets carrying the Type 0 routing header.

Related Commands

▾ Enabling IPv6 Source Routing

Command	ipv6 source-route
Parameter	N/A
Description	
Command Mode	Global configuration mode
Usage Guide	Since the Type 0 header may cause the device prone to DoS attacks, the device does not forward IPv6 packets carrying the routing header by default, but still processes IPv6 packets with itself being the final destination address and the Type 0 routing header.

Configuration Example

▾ Enabling IPv6 Source Routing

Configuration Steps	Enable IPv6 source routing.
----------------------------	-----------------------------

	FS(config)#ipv6 source-route
Verification	Run the show run command to check whether the configuration takes effect.
	FS#show run inc ipv6 source-route ipv6 source-route

3.4.5 Configuring the Sending Rate of ICMPv6 Error Messages

Configuration Effect

Configure the sending rate of ICMPv6 error messages.

Configuration Steps

▾ Configuring the Sending Rate of ICMPv6 Packet Too Big Messages

- Optional.
- If a device receives many IPv6 packets with the packet length exceeding the IPv6 MTU of the outbound interface and thereby sends many ICMPv6 Packet Too Big messages to consume much CPU resources, run the **ipv6 icmp error-interval too-big** command to restrict the sending rate of this error message.

▾ Configuring the Sending Rate of Other ICMPv6 Error Messages

- Optional.
- If a device receives many illegal IPv6 packets and thereby generates many ICMPv6 error messages, run the **ipv6 icmp error-interval** command to restrict the sending rate of ICMPv6 error messages. (This command does not affect the sending rate of ICMPv6 Packet Too Big messages.)

Verification

Run the **show running-config** command to check whether the configuration takes effect.

Related Commands

▾ Configuring the Sending Rate of ICMPv6 Packet Too Big Messages

Command	ipv6 icmp error-interval too-big <i>milliseconds</i> [<i>bucket-size</i>]
Parameter Description	<i>milliseconds</i> : Indicates the refresh period of a token bucket, ranging from 0 to 2,147,483,647. The unit is millisecond. The default value is 100. If the value is 0, the sending rate of ICMPv6 error messages is not restricted. <i>bucket-size</i> : Indicates the number of tokens in a token bucket, ranging from 1 to 200. The default value is 10.
Command Mode	Global configuration mode
Usage Guide	To prevent DoS attacks, use the token bucket algorithm to restrict the sending rate of ICMPv6 error messages. If the length of an IPv6 packet to be forwarded exceeds the IPv6 MTU of the outbound interface, the router discards this IPv6 packet and sends back an ICMPv6 Packet Too Big message to the source IPv6 address. This error message is mainly used as part of the IPv6 PMTUD process. If other ICMPv6 error messages are excessive, ICMPv6 Packet Too Big messages cannot be sent, causing failure of IPv6 PMTUD. Therefore, it is recommended to restrict the sending rate of ICMPv6 Packet Too Big messages independently of other ICMPv6 error messages. Since the precision of the timer is 10 milliseconds, it is recommended to set the refresh period of a token bucket to

	<p>an integer multiple of 10 milliseconds. If the refresh period of the token bucket is between 0 and 10, the actual refresh period is 10 milliseconds. For example, if the sending rate is set to 1 every 5 milliseconds, two error messages are sent every 10 milliseconds in actual situations. If the refresh period of the token bucket is not an integer multiple of 10 milliseconds, it is automatically converted to an integer multiple of 10 milliseconds. For example, if the sending rate is set to 3 every 15 milliseconds, two tokens are refreshed every 10 milliseconds in actual situations.</p>
--	---

➤ **Configuring the Sending Rate of Other ICMPv6 Error Messages**

Command	ipv6 icmp error-interval <i>milliseconds</i> [<i>bucket-size</i>]
Parameter Description	<p><i>milliseconds</i>: Indicates the refresh period of a token bucket, ranging from 0 to 2,147,483,647. The unit is millisecond. The default value is 100. If the value is 0, the sending rate of ICMPv6 error messages is not restricted.</p> <p><i>bucket-size</i>: Indicates the number of tokens in a token bucket, ranging from 1 to 200. The default value is 10.</p>
Command Mode	Global configuration mode
Usage Guide	<p>To prevent DoS attacks, use the token bucket algorithm to restrict the sending rate of ICMPv6 error messages. Since the precision of the timer is 10 milliseconds, it is recommended to set the refresh period of a token bucket to an integer multiple of 10 milliseconds. If the refresh period of the token bucket is between 0 and 10, the actual refresh period is 10 milliseconds. For example, if the sending rate is set to 1 every 5 milliseconds, two error messages are sent every 10 milliseconds in actual situations. If the refresh period of the token bucket is not an integer multiple of 10 milliseconds, it is automatically converted to an integer multiple of 10 milliseconds. For example, if the sending rate is set to 3 every 15 milliseconds, two tokens are refreshed every 10 milliseconds in actual situations.</p>

Configuration Example

➤ **Configuring the Sending Rate of ICMPv6 Error Messages**

Configuration Steps	<p>Set the sending rate of the ICMPv6 Packet Too Big message to 100 pps and that of other ICMPv6 error messages to 10 pps.</p>
	<pre>FS(config)#ipv6 icmp error-interval too-big 1000 100 FS(config)#ipv6 icmp error-interval 1000 10</pre>
Verification	<p>Run the show running-config command to check whether the configuration takes effect.</p>
	<pre>FS#show running-config include ipv6 icmp error-interval ipv6 icmp error-interval 1000 10 ipv6 icmp error-interval too-big 1000 100</pre>

3.4.6 Configuring the IPv6 Hop Limit

Configuration Effect

Configure the number of hops of a unicast packet to prevent the packet from being unlimitedly transmitted.

Configuration Steps

➤ **Configuring the IPv6 Hop Limit**

- Optional.
- To modify the number of hops of a unicast packet, run the **ipv6 hop-limit value** command.

Verification

- Run the **show running-config** command to check whether the configuration is correct.
- Capture the IPv6 unicast packets sent by a host. The packet capture result shows that the hop-limit field value in the IPv6 header is the same as the configured hop limit.

Related Commands

↘ **Configuring the IPv6 Hop Limit**

Command	ipv6 hop-limit value
Parameter Description	<i>value</i> : Indicates the number of hops of a unicast packet sent by the device. The value ranges from 1 to 255.
Command Mode	Global configuration mode
Usage Guide	N/A

Configuration Example

↘ **Configuring the IPv6 Hop Limit**

Configuration Steps	Change the IPv6 hop limit of a device to 250.
	<pre>FS(config)#ipv6 hop-limit 250</pre>
Verification	Run the show running-config command to check whether the configuration takes effect.
	<pre>FS#show running-config ipv6 hop-limit 254</pre>

3.4.7 Enabling/Disabling the Function of Refraining from Sending NS Packets to Authentication VLANs

Configuration Effect

Enable or disable the function of refraining from sending NS packets to authentication VLANs on an SVI.

Notes

The configuration is supported only on SVIs and takes effect only in gateway authentication mode.

Configuration Steps

↘ **Enabling/Disabling the Function of Refraining from Sending NS Packets to Authentication VLANs**

- Optional.
- In gateway authentication mode, run the **no ipv6 nd suppress-auth-vlan-ns** command so that the device can send NS packets to authentication VLANs.

Verification

- Run the **show running-config** command to check whether the configuration is correct.

Related Commands

➤ **Enabling/Disabling the Function of Refraining from Sending NS Packets to Authentication VLANs**

Command	ipv6 nd suppress-auth-vlan-ns
Parameter	N/A
Description	
Command Mode	Interface configuration mode
Usage Guide	Use the no form of this command to disable this function.

Configuration Example

➤ **Disabling the Function of Refraining from Sending NS Packets to Authentication VLANs**

Configuration Steps	Disable the function of refraining from sending NS packets to authentication VLANs.
	<pre>FS(config-if-VLAN 2)#no ipv6 nd suppress-auth-vlan-ns</pre>
Verification	Run the show running-config interface vlan 2 command to check whether the configuration takes effect.
	<pre>FS#show running-config interface vlan 2 no ipv6 nd suppress-auth-vlan-ns</pre>

3.4.8 Configuring the Default Gateway on the Management Interface

Configuration Effect

Configure the default gateway on the management interface. A default route is generated, with the outbound interface being the management interface and the next hop being the configured gateway.

Notes

The configuration is supported only on the management interface.

Configuration Steps

➤ **Configuring the Default Gateway on the Management Interface**

- Optional.
- To configure a default route and the next hop for the management interface, run the **ipv6 gateway** command.

Verification

- Run the **show running-config** command to check whether the configuration is correct.

Related Commands

➤ **Configuring the Default Gateway on the Management Interface**

Command	ipv6 gateway <i>ipv6-address</i>
Parameter	N/A
Description	

Command	Interface configuration mode
Mode	
Usage Guide	This command is supported only on the management interface.

Configuration Example

📌 **Configuring the Default Gateway on the Management Interface**

Configuration Steps	Sett the default gateway of the management interface to 2000::1.
	<pre>FS(config)# interface mgmt 0 FS(config-mgmt)# ipv6 gateway 2000::1</pre>
Verification	Run the show running-config interface vlan 2 command to check whether the configuration takes effect.
	<pre>FS#show running-config interface mgmt 0 Ipv6 gateway 2000::1</pre>

3.4.9Configuring the Source Address of ICMPv6 Packets

Configuration Effect

Specifying the source address of ICMPv6 packets.

Configuration Steps

📌 **Configuring the Source Address of ICMPv6 Packets**

- Optional.
- To set the source address for ICMPv6 packets, run the **ipv6 icmpv6 source [vrf vrf-name] ipv6-address** command in global configuration mode.

Verification

- After the source address is enabled, the address is used in ICMPv6 reply packets.

Related Commands

📌 **Configuring the Source Address of ICMPv6 Packets**

Command	ipv6 icmp source [vrf vrf-name] ipv6-address
Parameter Description	-
Command Mode	Global configuration mode
Usage Guide	In a network with a large number of IPv6 addresses configured, it is complex for receivers to recognize from which device ICMPv6 packets are sent. To simplify the judgement, you can choose a specified address, like the address of the loopback interface, as the source address for ICMPv6 packets.

Configuration Example

➤ **Configuring the Source Address of ICMPv6 Packets**

Configuration Steps	Configure the source address of ICMPv6 packets.
	FS(config)# ipv6 icmp source 1001::1
Verification	Run the show running-config command to check whether the configuration takes effect.
	ipv6 icmp source 1001::1

3.4.10 Enabling Statistics of ND Packets

Configuration Effect

Calculating the rate of ND packets.

Configuration Steps

➤ **Configuring the Interval Between Two Samplings of ND Packets**

- Optional.
- To set the source address for ICMPv6 packets, run the **ipv6 nd rate-statistics interval seconds** command in interface configuration mode.

Verification

- Run the **show run-config** command to display the configuration or the **show ipv6 nd-packet [interface interface-name] statistics** command to display the rate of ND packets.

Related Commands

➤ **Configuring the Interval Between Two Samplings of ND Packets**

Command	ipv6 nd rate-statistics interval seconds
Parameter Description	<i>seconds</i> : Specifies the interval between two samplings of ND packets in the unit of second. The range is from 60 to 86,400.
Command Mode	Global configuration mode
Usage Guide	The default value for <i>seconds</i> is 0, which means disabled statistics. You can run the no ipv6 nd rate-statistics interval command to disabled the statistics.

Configuration Example

➤ **Configuring the Interval Between Two Samplings of ND Packets**

Configuration Steps	Set the interval to 100s.
	FS(config)# ipv6 nd rate-statistics interval 100
Verification	Run the show running-config command to check whether the configuration takes effect.
	ipv6 nd rate-statistics interval 100

3.4.11 Enabling Fast Removal of ND Entries

Configuration Effect

When L2 ports get down, corresponding ND entries are fast deleted.

Configuration Steps

▾ Enabling Fast Removal of ND Entries

- Optional.
- Perform the configuration in interface configuration mode.
- Only SVIs are supported.

Verification

- Run the **show run** command to display the configuration.

Related Commands

▾ Enabling Fast Removal of ND Entries

Command	ipv6 nd l2port-down fast-delete
Parameter Description	N/A
Command Mode	Interface configuration mode
Usage Guide	Run the ipv6 nd l2port-down fast-delete command on an SVI, so ARP entries are removed as soon as L2 ports under this SVI get down. Without configuring this feature, ARP entries are deleted only after their aging time is reached.

Configuration Example

▾ Enabling Fast Removal of ND Entries

Configuration Steps	Enable fast removal of ND entries as soon as L2 ports get down.
	<pre>FS(config-if-VLAN 2)#ipv6 nd l2port-down fast-delete</pre>
Verification	Run the show running-config command to check whether the configuration takes effect.
	<pre>FS#show running-config interface VLAN 2 ! ipv6 nd l2port-down fast-delete !</pre>

3.4.12 Enabling an Interface to Learn ND Entries via DAD NS Packets

Configuration Effect

The enabled interface can learn ND entries via DAD NS packets.

Configuration Steps

➤ **Enabling an Interface to Learn ND Entries via DAD NS Packets**

- Optional.

Verification

- Run the **show run-config** command to display the configuration.

Related Commands

➤ **Enabling an Interface to Learn ND Entries via DAD NS Packets**

Command	ipv6 nd dad learning enable
Parameter	N/A
Description	
Command Mode	Interface configuration mode
Usage Guide	After this command is run, when the interface receives DAD NS packets, ND entries with the status of Stale will be created.

Configuration Example

➤ **Enabling an Interface to Learn ND Entries via DAD NS Packets**

Configuration Steps	Enable the SVI 1 interface to learn ND entries via DAD NS packets.
	FS(config-if-VLAN 1)# ipv6 nd dad learning enable
Verification	Run the show running-config command to check whether the configuration takes effect.
	ipv6 nd dad learning enable

3.4.13 Enabling Generating of Host Routes After EVPN Synchronizes ND Entries to Overlay Router Interfaces

Configuration Effect

L3 traffic can be routed after this feature is enabled.

Configuration Steps

➤ **Enabling Generating of Host Routes After EVPN Synchronizes ND Entries to Overlay Router Interfaces**

- Optional.
- Perform the **no ipv6 nd remote inactive** command in interface configuration mode.

Verification

- Run the **show run-config** command to display the configuration.

Related Commands

➤ **Enabling Generating of Host Routes After EVPN Synchronizes ND Entries to Overlay Router Interfaces**

Command	no ipv6 nd remote inactive
Parameter Description	N/A
Command Mode	Interface configuration mode
Usage Guide	In the VXLAN EVPN environment, BGP is adopted for most forwarding scenarios, and L3 forwarding based on ARP entries is not usually needed. So, to avoid a waste of hardware resources, by default, host routes are configured not to be generated when EVPN synchronizes ARP or ND entries to Overlay router interfaces. But when BGP is not available, you should perform this command so traffic can be routed.

Configuration Example

➤ **Enabling Generating of Host Routes After EVPN Synchronizes ND Entries to Overlay Router Interfaces**

Configuration Steps	Enabling generating of host routes after EVPN synchronizes ND entries to the Overlay router interface, OverlayRouter 1.
	FS(config-if-OverlayRouter 1)#no ipv6 nd remote inactive
Verification	Run the show running-config command to check whether the configuration takes effect.
	! interface OverlayRouter 1 no ipv6 nd remote inactive !

3.5 Monitoring

Clearing

Running the **clear** commands may lose vital information and thus interrupt services.

Description	Command
Clears the dynamically learned neighbors.	clear ipv6 neighbors [vrf vrf-name] [oob] [interface-id]
Clears statistics of ND packets.	clear ipv6 nd-packet [interface-name statistics]

Displaying

Description	Command
Displays IPv6 information of an interface.	show ipv6 interface [[interface-id] [ra-info]] [brief [interface-id]]
Displays neighbor information.	show ipv6 neighbors [vrf vrf-name] [verbose] [interface-id] [ipv6-address] [static] [oob]
Displays information of the IPv6 routing table.	show ipv6 route [vrf vrf-name] [static local connected bgp rip ospf isis]
Displays statistics of ND packets.	show ipv6 nd-packet [interface interface-name] statistics

Debugging



System resources are occupied when debugging information is output. Therefore, disable the debugging switch immediately after use.

Description	Command
Debugs ND entry learning.	debug ipv6 nd

4 Configuring DHCP

4.1 Overview

The Dynamic Host Configuration Protocol (DHCP) is a LAN protocol based on the User Datagram Protocol (UDP) for dynamically assigning reusable network resources, for example, IP addresses.

The DHCP works in Client/Server mode. A DHCP client sends a request message to a DHCP server to obtain an IP address and other configurations. When a DHCP client and a DHCP server are not in a same subnet, they need a DHCP relay to forward DHCP request and reply packets.

Protocols and Standards

- RFC2131: Dynamic Host Configuration Protocol
- RFC2132: DHCP Options and BOOTP Vendor Extensions
- RFC3046: DHCP Relay Agent Information Option

4.2 Applications

Application	Description
Providing DHCP Service in a LAN	Assigns IP addresses to clients in a LAN.
Enabling DHCP Client	Enable DHCP Client.
Applying AM Rule on DHCP Server	Apply DHCP Server in Super VLAN environment.
Deploying DHCP Relay in Wired Network	In a wired network, users from different network segments requests IP addresses.
Applying AM Rule on DHCP Relay	In a Super VLAN, users from different network segments requests IP addresses.

4.2.1 Providing DHCP Service in a LAN

Scenario

Assign IP addresses to four users in a LAN.

For example, assign IP addresses to User 1, User 2, User 3 and User 4, as shown in the following figure.

- The four users are connected to Server S through A, B, C and D.

Figure 4- 1

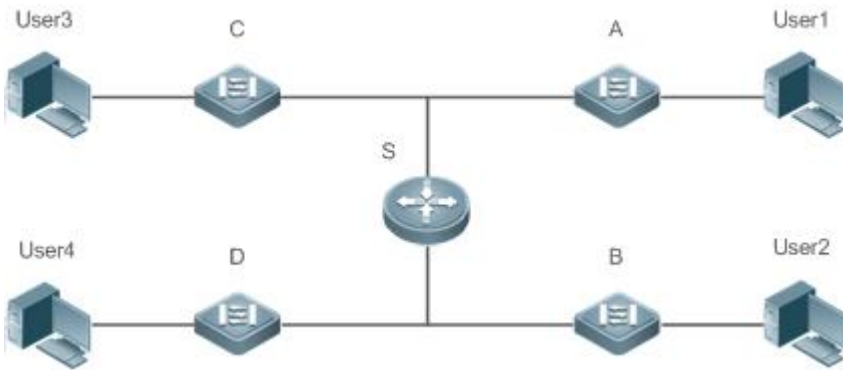

Remarks	<p>S is an egress gateway working as a DHCP server.</p> <p>A, B, C and D are access switches achieving layer-2 transparent transmission.</p> <p>User 1, User 2, User 3 and User 4 are LAN users.</p>
----------------	--

Deployment

- Enable DHCP Server on S.
- Deploy layer-2 VLAN transparent transmission on A, B, C and D.
- User 1, User 2, User 3 and User 4 initiate DHCP client requests.

4.2.2Enabling DHCP Client

Scenario

Access switches A, B, C and D in a LAN request server S to assign IP addresses.

For example, enable DHCP Client on the interfaces of A, B, C and D to request IP addresses, as shown in the following figure.

Figure 4- 2

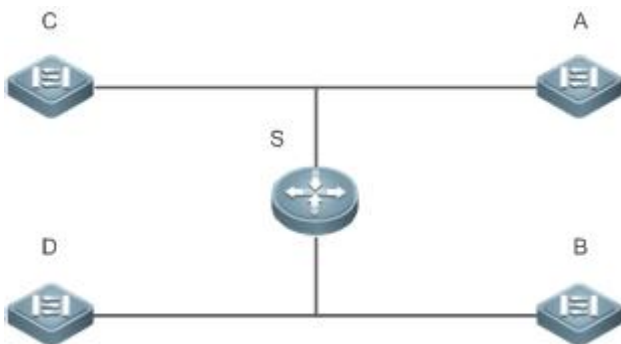

Remarks	<p>S is an egress gateway working as a DHCP server.</p> <p>A, B, C and D are access switches with DHCP Client enabled on the interfaces.</p>
----------------	--

Deployment

- Enable DHCP Server on S.

- Enable DHCP Client on the interfaces of A, B, C and D.

4.2.3 Applying AM Rule on DHCP Server

Scenario

As shown in Figure 4- 3, create a Super VLAN, configure an AM rule and enable DHCP Server on the core switch A. B is an aggregation switch, C an access switch, and D a wireless access device. The requirements are listed as follows:

- Assign IP addresses dynamically based on the VLAN and port;
- Assign IP addresses statically based on the VLAN;
- Assign IP addresses dynamically based on the default AM rule.

Figure 4- 3 Applying AM Rule on a DHCP Server

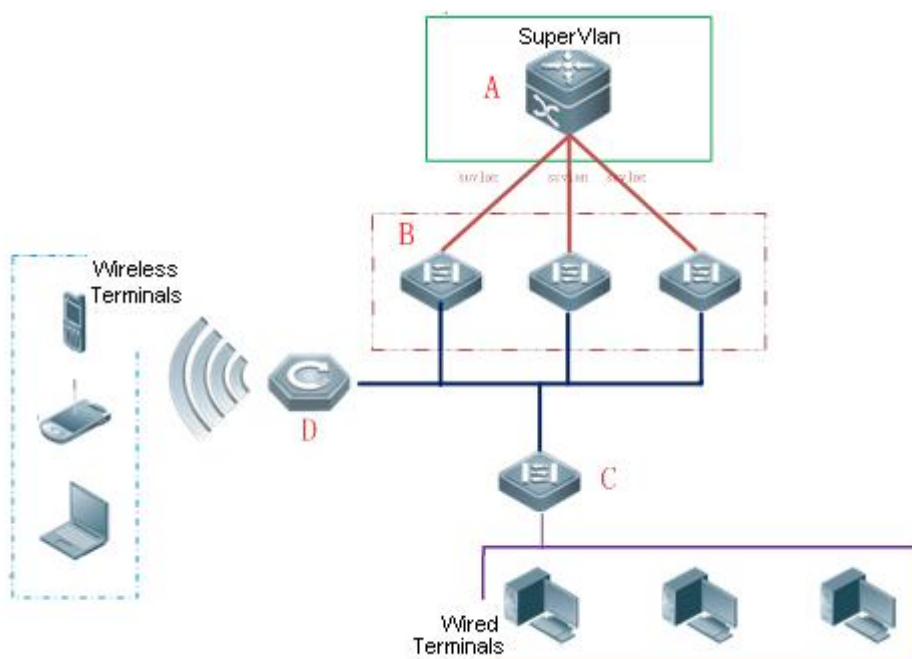

Remarks	A is a core device. B is an aggregation device. C is a wired access device. D is a wireless access device.
----------------	---

Deployment

- Configure an AM rule, enable DHCP Server and create a Super VLAN on A.
- Create VLANs on B and C to transparently transmit DHCP packets from wired users to A to request IP addresses.
- Enable the wireless function on D to transparently transmit DHCP packets from wireless users to A to request IP addresses.

4.2.4 Deploying DHCP Relay in Wired Network

Scenario

As shown in the following figure, Switch C and Switch D are access devices for the users in VLAN 10 and VLAN 20 respectively. Switch B is a gateway, and Switch A a core device. The requirements are listed as follows:

Switch A works as a DHCP server to assign IP addresses of different network segments dynamically to users in different VLANs.

Users in VLAN 10 and VLAN 20 obtain IP addresses dynamically.

Figure 4-4 DHCP Relay

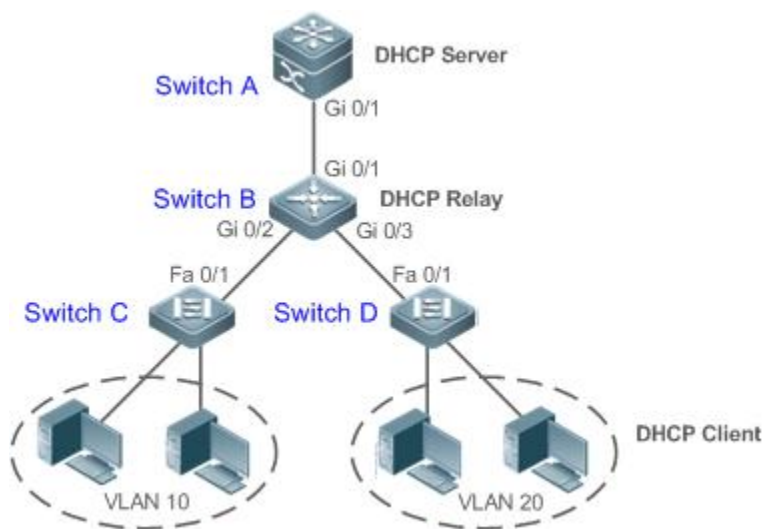

Remarks	Switch C and Switch D are access devices. Switch B is a gateway. Switch A is a core device.
----------------	---

Deployment

- Configure layer-2 communication between Switch B and Switch C as well as between Switch B and Switch D.
- On Switch B, specify a DHCP server address and enable DHCP Relay.
- On Switch A, create DHCP address pools for VLAN 10 and VLAN 20 respectively, and enable DHCP Server.

4.2.5 Applying AM Rule on DHCP Relay

Scenario

As shown in Figure 4-5, A is a DHCP server, B a core switch configured with Super VLAN, an AM rule and DHCP Relay, C an aggregation switch, D an access switch, and E a wireless access device. The requirements are listed as follows:

- Based on the VLAN-port AM rule, the DHCP relay agent chooses a subnet address as Giaddress of relay packets and forwards them to the DHCP server to request an IP address for the client.
- Based on default AM rule, the DHCP relay agent chooses a subnet address as Giaddress of relaying packets and forwards them to the DHCP server to request an IP address for the client.

Figure 4- 5 Applying AM Rule on DHCP Relay

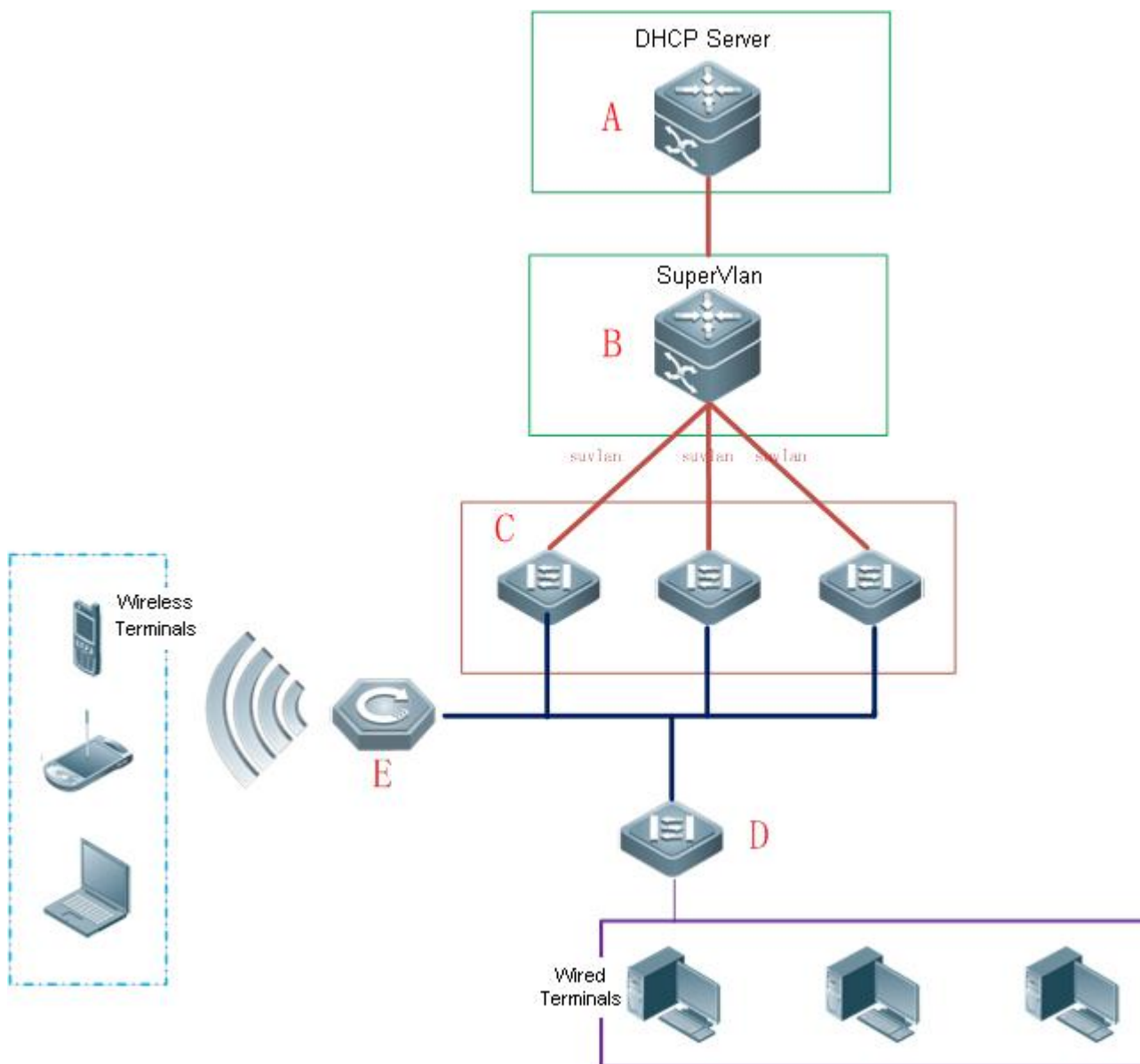

Remarks	A is a core device. B is a core device. C is an aggregation device. D is a wired access device. E is a wireless access device.
----------------	--

Deployment

- Enable DHCP Server on A.
- Configure an AM rule, enable DHCP Relay and create a Super VLAN on B.
- Create VLANs on C and D to transparently transmit DHCP packets from wired users to B to request IP addresses.
- Enable the wireless function on E to transparently transmit DHCP packets from wireless users to B to request IP addresses.

4.3 Features

Basic Concepts

➤ DHCP Server

Based on the RFC 2131, FS DHCP server assigns IP addresses to clients and manages these IP addresses.

➤ DHCP Client

DHCP Client enables a device to automatically obtain an IP address and configurations from a DHCP server.

➤ DHCP Relay

When a DHCP client and a DHCP server are not in a same subnet, they need a DHCP relay to forward DHCP request and reply packets.

➤ Lease

Lease is a period of time specified by a DHCP server for a client to use an assigned IP address. An IP address is active when leased to a client. Before a lease expires, a client needs to renew the lease through a server. When a lease expires or is deleted from a server, the lease becomes inactive.

➤ Excluded Address

An excluded address is a specified IP address not assigned to a client by a DHCP server.

➤ Address Pool

An address pool is a collection of IP addresses that a DHCP server may assign to clients.

➤ Option Type

An option type is a parameter specified by a DHCP server when it provides lease service to a DHCP client. For example, a public option include the IP addresses of a default gateway (router), WINS server and a DNS server. DHCP server allows configuration of other options. Though most options are defined in the RFC 2132, you can add user-defined options.

Overview

Feature	Description
DHCP Server	Enable DHCP Server on a device, and it may assign IP addresses dynamically and pushes configurations to DHCP clients.
<u>DHCP Relay</u>	Enable DHCP Relay on a device, and it may forward DHCP request and reply packets across different network segments.
DHCP Client	Enable DHCP Client on a device, and it may obtain IP addresses and configurations automatically from a DHCP server.
AM Rule	Enable an AM rule on a device, and it may assign IP addresses according to the rule.

4.3.1 DHCP Server

Working Principle

➤ DHCP Working Principle

Figure 4-6

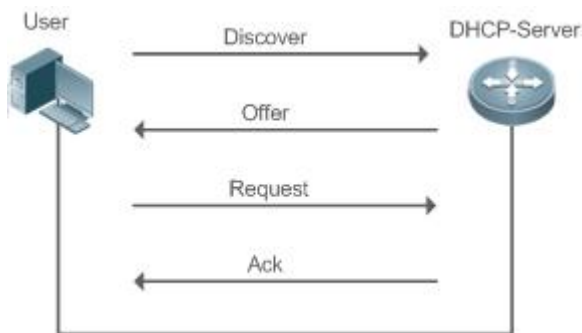

A host requests an IP address through DHCP as follows:

1. A host broadcasts a DHCP discover packet to find DHCP servers in a network.
2. DHCP servers unicast/broadcast (based on the property of the host packet) DHCP offer packets to the host, containing an IP address, a MAC address, a domain name and a lease.
3. The host broadcasts a DHCP request packet to formally request an IP address.
4. A DHCP server sends a DHCP ACK unicast packet to the host to acknowledge the request.

i A DHCP client may receive DHCP OFFER packets from multiple DHCP servers, but usually it accepts only the first DHCP OFFER packet. Besides, the address specified in a DHCP OFFER packet is not necessarily assigned. Instead, it is retained by the DHCP server until a client sends a formal request.

To formally request an IP address, a client broadcasts a DHCPREQUEST packet so that all DHCP servers sending DHCP OFFER packets may receive the packet and release OFFER IP addresses.

If a DHCP OFFER packet contains invalid configuration parameters, a client will send a DHCPDECLINE packet to the server to decline the configuration.

During the negotiation, if a client does not respond to the DHCP OFFER packets in time, servers will send DHCPNAK packets to the client and the client will reinitiate the process.

During network construction, FS DHCP servers have the following features:

- Low cost. Usually the static IP address configuration costs more than DHCP configuration.
- Simplified configuration. Dynamic IP address assignment dramatically simplifies device configuration.
- Centralized management. You can modify the configuration for multiple subnets by simply modifying the DHCP server configuration.

📌 Address Pool

After a server receives a client's request packet, it chooses a valid address pool, determines an available IP address from the pool through PING, and pushes the pool and address configuration to the client. The lease information is saved locally for validity check upon lease renewal.

An address pool may carry various configuration parameters as follows:

- An IP address range, which is the range of IP addresses that are available.
- A gateway address. A maximum of 8 gateway addresses are supported.
- A DNS address. A maximum of 8 DNS addresses are supported.
- A lease period notifying clients of when to age an address and request a lease renewal.

↘ VRRP Monitoring

In a Virtual Router Redundancy Protocol (VRRP) scenario, FS devices enabled with DHCP provide a command to monitor the VRRP status of the interface. To an interface configured with VRRP address and VRRP monitoring, a DHCP server only processes the DHCP clients' request packets from the interface in Master state, and other packets are discarded. If no VRRP address is configured, the DHCP server does not monitor the VRRP status, and all DHCP packets are processed. VRRP monitoring is configured on only layer-3 interfaces. It is disabled by default, namely, only the Master device processes the DHCP service.

↘ IP Address Assignment Based on VLANs, Ports and IP Range

After an IP address pool is deployed, the specified IP address range is assigned based on VLANs and ports. There are three scenarios. 1. Global configuration. 2. Configuration based on VLANs, ports and IP range. 3. Both 1 and 2. In scenario 1, the addresses are assigned globally. In scenario 2, the addresses in the specified IP range are assigned only to the clients of the specified VLANs and ports. In scenario 3, the clients of the specified VLANs and ports are assigned the addresses in the specified IP range, and the other clients are configured with default global addresses.

Related Configuration

↘ Enabling DHCP Server Globally

- By default, DHCP Server is disabled.
- Run the **service dhcp** command to enable the DHCP Server.
- Run the **service dhcp** command globally to enable DHCP service.

↘ Configuring Address Pool

- By default, no address pool is configured.
- Run the **ip dhcp pool** command to configure an IP address range, a gateway and a DNS.
- If no address pool is configured, no addresses will be assigned.

4.3.2DHCP Relay Agent

Working Principle

The destination IP address of DHCP request packets is 255.255.255.255, and these packets are forwarded within a subnet. To achieve IP address assignment across network segments, a DHCP relay agent is needed. The DHCP relay agent unicasts DHCP request packets to a DHCP server and forwards DHCP reply packets to a DHCP client. The DHCP relay agent serves as a repeater connecting a DHCP client and a DHCP server of different network segments by forwarding DHCP request packets and DHCP reply packets. The Client-Relay-Server mode achieves management of IP addresses across multiple network segments by only one DHCP server. See the following figure.

Figure 4- 7 DHCP Relay Scenario

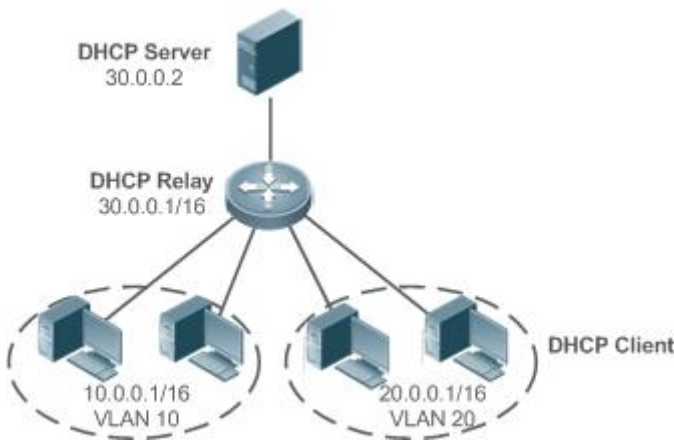

VLAN 10 and VLAN 20 correspond to the segments 10.0.0.1/16 and 20.0.0.1/16 respectively. A DHCP server with IP address 30.0.0.2 is in segment 30.0.0.1/16. To achieve management of dynamic IP addresses in VLAN 10 and VLAN 20 by the DHCP server, you only need to enable DHCP Relay on a gateway and configure IP address 30.0.0.2 for the DHCP server.

➤ **DHCP Relay Agent Information (Option 82)**

As defined in RFC3046, an option can be added to indicate a DHCP client's network information when DHCP Relay is performed, so that a DHCP server may assign IP addresses of various privileges based on more accurate information. The option is called Option 82. Currently, FS devices support four schemes of relay agent information, which are described respectively as follows:

- 20. Relay agent information option dot1x: This scheme should be implemented with 802.1X authentication and the RG-SAM products. Specifically, RG-SAM products push the IP privilege during 802.1X authentication. A DHCP relay agent forms a Circuit ID sub-option based on the IP privilege and the VLAN ID of a DHCP client. The option format is shown in the following figure.

Figure 4- 8 Option Format

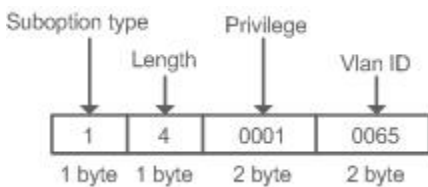

- 21. Relay agent information option82: This scheme serves without correlation with other protocol modules. A DHCP relay agent forms an Option 82 based on the physical port receiving DHCP request packets and the MAC address of the device. The option format is shown in the following figure.

Figure 4- 9 Agent Circuit ID

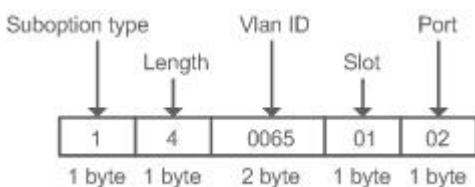
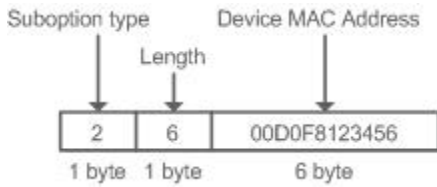
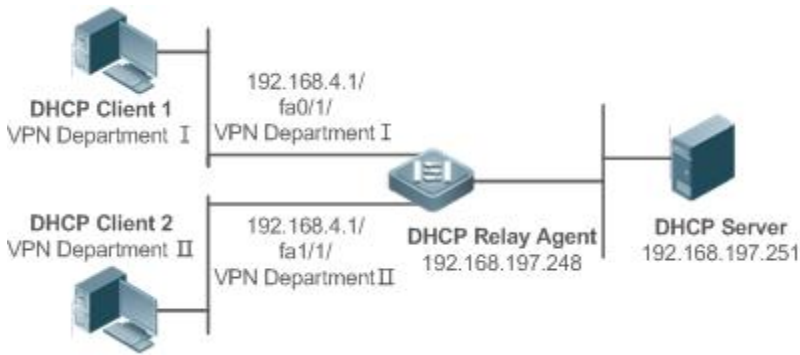

Figure 4- 10 Agent Remote ID



22. Relay agent information option VPN: This scheme should be implemented with MPLS VPN functions.

Figure 4- 11 Application in MPLS VPN Environment



As shown in Figure 4- 11, in MPLS VPN environment, DHCP Client 1 is connected to fa0/1 on a DHCP relay agent and DHCP Client 2 to fa1/1. Interfaces fa0/1 and fa1/1 belongs to different VRFs. DHCP Client 1 and DHCP Client 2 obtain IP addresses through DHCP. According to network planning, VPN Department I and VPN Department II are in a same segment 192.168.4.0/24. In this case, conventional DHCP application cannot meet the demand. To support DHCP Relay in MPLS VPN environment, **option vpn** is introduced, which includes the three sub-options, namely, VPN-ID, Subnet-Selection and Server-Identifier-Override.

- **VPN-ID:** When a DHCP relay agent receives a DHCP request packet, it adds the information of the VPN the DHCP client resides to the packet as an option. The DHCP server keeps the VPN-ID in a reply packet, and the DHCP relay agent forwards the packet to the corresponding VRF according to the option. The option format is shown in the following figure.

Figure 4- 12 VPN-ID

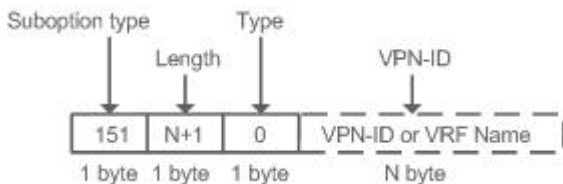

- **Subnet-Selection:** In conventional DHCP Relay, the information of a client network and the addresses of a DHCP server and a DHCP relay agent are indicated by the **gateway address[giaddr]** field. In MPLS VPN environment, set **giaddr** to the IP address of the interface of a DHCP relay agent connected to a DHCP server, so that the server may communicate directly with the relay agent. Besides, the information of the client subnet is indicated by a Subnet-Selection option. The option format is shown in the following figure.

Figure 4- 13 Subnet-Selection

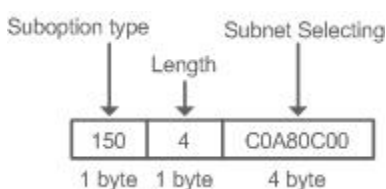

- **Server-Identifier-Override:** In MPLS VPN environment, request packets from a DHCP client cannot be sent directly to a DHCP server. A DHCP relay agent use this option to carry the information of the interface connecting the relay agent and the DHCP server. When the server sends a reply message, this option overrides the Server-Identifier option. In this way, the DHCP client sends packets to DHCP relay agent, and the DHCP relay agent forwards them to the DHCP server. The option format is shown in the following figure.

Figure 4- 14 Server-Identifier-Override

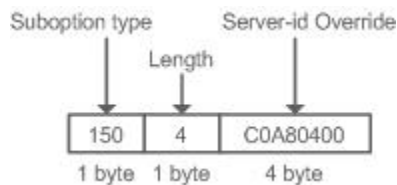

➤ DHCP Relay Check Server-ID

In DHCP environment, multiple DHCP servers are deployed for a network, achieving server backup to ensure uninterrupted network operation. After this function is enabled, the DHCP request packet sent by a client contains a **server-id** option specifying a DHCP server. In alleviating the burden on servers in specific environments, you need to enable this function on a relay agent to send a packet to a specified DHCP server rather than all DHCP servers.

➤ DHCP Relay suppression

After you configure the **ip DHCP Relay suppression** command on an interface, DHCP request packets received on the interface will be filtered, and the other DHCP request packets will be forwarded.

Related Configuration

➤ Enabling DHCP Relay

- By default, DHCP Relay is disabled.
- You may run the **service dhcp** command to enable DHCP Relay.
- You need to enable DHCP Relay before it works.

➤ Configuring IP Address for DHCP Server

- By default, no IP address is configured for a DHCP server.
- You may run the **ip helper-address** command to configure an IP address for a DHCP server. The IP address can be configured globally or on a layer-3 interface. A maximum of 20 IP addresses can be configured for a DHCP server.
- When an interface receives a DHCP request packet, the DHCP server configuration on the interface prevails over that configured globally. If the interface is not configured with DHCP server addresses, the global configuration takes effect.

➤ Enabling DHCP Option 82

- By default, DHCP Option 82 is disabled.
- You may run the **ip dhcp relay information option82** command to enable DHCP Option 82.

➤ Enabling DHCP Relay Check Server-ID

- By default, DHCP Relay check server-id is disabled.

- You may run the **ip dhcp relay check server-id** command to enable DHCP Relay check server-id.

↘ **Enabling DHCP Relay Suppression**

- By default, DHCP Relay suppression is disabled on all interfaces.
- You may run the **ip dhcp relay suppression** command to enable it on an interface.

↘ **Enabling the Function of Multiple Gateway IP Addresses**

- By default, the function of multiple gateway IP addresses is enabled.
- You may run the **ip dhcp relay multiple-giaddr** command to enable the function of multiple gateway IP addresses.

↘ **Enabling the Automatic Gateway Address Switching of the DHCP Relay**

- By default, the automatic gateway address switching of the DHCP relay is disabled.
- You can run the **ip dhcp smart-relay** command to enable the automatic gateway address switching.

↘ **Forcing the DHCP Relay to Send the Reply Message**

- By default, the DHCP Relay is not forced to send the reply message.
- You can run the **ip dhcp relay force-send-reply-pack** command to force the DHCP Relay to send the reply messages.

4.3.3DHCP Client

Working Principle

A DHCP client broadcasts a DHCP discover packet after entering the Init state. Then it may receive multiple DHCP offer packets. It chooses one of them and responds to the corresponding DHCP server. After that, it sends lease renewal request packets in the Renew and Rebind processes of an aging period to request lease renewal.

Related Configuration

↘ **Enabling DHCP Client on Interface**

- By default, DHCP Client is disabled.
- In interface configuration mode, you may run the **ip address dhcp** command to enable DHCP Client.
- You need to enable DHCP Client to enable DHCP service.
- The configuration takes effect on a layer-3 interface, for example, an SVI or a routed port.

4.3.4AM Rule

Working Principle

An AM rule defines the range of IP addresses assigned to DHCP clients in different VLANs and ports. It can be used to quickly identify the VLAN and port of a faulty DHCP client and effectively assign addresses. After an AM rule is configured, all DHCP clients from the set VLAN and ports may obtain IP addresses. If no AM rule is configured, there are two following cases: If a default AM rule is configured, the client obtains an IP address from the default range; if no default AM rule is configured, the client cannot obtain an IP address.





Related Configuration

↘ **Configuring AM Rule in Global Configuration Mode**

- In global configuration mode, run the **address-manage** command to enter AM rule configuration mode.
- Run the **match ip default** command to configure a default AM rule.
- Run the **match ip** command to configure an AM rule based on VLAN & port or port.

4.4 Configuration

⤵ Configuring DHCP Server

Configuration	Description and Command	
Configuring Dynamic IP Address	 (Mandatory) It is used to enable DHCP Server to achieve dynamic IP address assignment.	
	service dhcp	Enables DHCP Server.
	ip dhcp pool	Configures an address pool.
	network	Configures the network number and subnet mask of a DHCP address pool.
	 (Optional) It is used to configure the properties of an address pool.	
	default-router	Configures a default gateway of a client.
	lease	Configures an address lease.
	next-server	Configures a TFTP server address
	bootfile	Configures a boot file of a client.
	domain-name	Configures a domain name of a client.
	dns-server	Configures a domain name server.
	netbios-name-server	Configures a NetBIOS WINS server.
	netbios-node-type	Configures a NetBIOS node type on a client.
	lease-threshold	Configures an alarm threshold of an address pool.
	option	Configures a user-defined option.
pool-status	Enables or disables an address pool.	
Configuring Static IP Address	 (Optional) It is used to statically assign an IP address to a client.	
	ip dhcp pool	Configures an address pool name and enters address pool configuration mode.
	host	Configures the IP address and subnet mask of a client host.
	hardware-address	Configures a client hardware address.
	client-identifier	Configures a unique client identifier.
	client-name	Configures a client name.
Configuring AM Rule for DHCP Server	 (Optional) It is used to configure the properties of a DHCP server.	
	ip dhcp excluded-address	Configures an excluded IP address.
	ip dhcp force-send-nak	Configures Compulsory NAK reply by a DHCP server.
	ip dhcp monitor-vrrp-state	Configures VRRP status monitoring.

Configuration	Description and Command	
	ip dhcp ping packets	Configures ping times.
	ip dhcp ping timeout	Configures a ping timeout.
	ip dhcp server arp-detect	Configures a DHCP server to detect user offline.
Configuring Global Properties of DHCP Server	(Optional) It is used to configure the AM rule of a DHCP server.	
	match ip default	Configures a default AM rule.
	match ip ip-address	Configures an AM rule based on the VLAN and port.

➤ **Configuring DHCP Relay**

Configuration	Description and Command	
Configuring Basic DHCP Relay Functions	(Mandatory) It is used to enable DHCP Relay.	
	service dhcp	Enables DHCP Relay.
	ip helper-address	Configures an IP Address of a DHCP Server.
Configuring DHCP Relay Option 82	(Optional) It is used to assign IP addresses of different privileges to clients in combination with the information of a physical port. This function cannot be used together with the dhcp option dot1x command.	
	ip dhcp relay information option82	Enables DHCP option82.
	(Optional) It is used to configure user-defined Option 82 information.	
	ip dhcp relay information option82 user-defined {circuit-id remote-id} text	Configures option 82 user-definition function for a port.
	ip dhcp relay information option82 user-defined mac-format type	Configures the MAC address format.
Configuring DHCP Relay Check Server-ID	(Optional) It is used to enable a DHCP Relay agent to send DHCP request packets only to a specified server.	
	ip dhcp relay check server-id	Enables a DHCP Relay agent to send DHCP request packets only to a specified server
Configuring DHCP Relay Suppression	(Optional) It is used to shield DHCP request packets on an interface.	
	ip dhcp relay suppression	Enables DHCP Relay Suppression.
Configuring the Multi-giaddr IP Address Function	(Optional) It is used to enable the multi-gateway rela.	
	ip dhcp relay multiple-giaddr	Configures the multi-giaddr IP address function.
Configuring the Automatic Gateway IP Address Switching Function	(Optional) It is used to enable the automatic gateway address switching.	
	ip dhcp smart-relay	Configures the automatic gateway address switching.
Forcing the DHCP Relay to Send the Reply	(Optional) It is used to force the DHCP Relay to send the reply message.	

Configuration	Description and Command	
Message	ip dhcp relay force-send-reply-pack	Forces the DHCP Relay to send the reply message.

↘ **Configuring DHCP Client**

Configuration	Description and Command	
Configuring DHCP Client	(Mandatory) It is used to enable DHCP Client.	
	ip address dhcp	Enables an Ethernet interface, a PPP/HDLC-encapsulated or FR-encapsulated interface to obtain IP addresses through DHCP.

4.4.1 Configuring Dynamic IP Address

Configuration Effect

Provide all DHCP clients with DHCP service including assigning IP addresses and gateways.

Notes

A DHCP server and a DHCP relay share the **service dhcp** command, but a device cannot function as a DHCP server and relay at the same time. When a device is configured with a valid address pool, it acts as a server and forwards packets. Otherwise, it serves as a relay agent.

Configuration Steps

↘ **Enabling DHCP Server**

- Mandatory. It achieves dynamic IP address assignment.
- Run the **service dhcp** command in global configuration mode.

↘ **Configuring Address Pool**

- Mandatory. It is used to create an IP address pool.
- Run the **ip dhcp pool** command in global configuration mode.

↘ **Configuring Network Number and Subnet Mask of DHCP Address Pool**

- Mandatory. It defines a range of dynamically assigned addresses.
- Run the **network** command in DHCP address pool configuration mode.

↘ **Configuring Default Gateway of Client**

- Optional. It is used to configure a gateway address.
- Run the **default-router** command in DHCP address pool configuration mode.

↘ **Configuring Address Lease**

- Optional. It is used to configure an IP address lease, which is 24h by default.
- Run the **lease** command in DHCP address pool configuration mode.

✚ **Configuring TFTP Server Address**

- Optional. It is used to configure a TFTP server address.
- Run the **next-server** command in DHCP address pool configuration mode.

✚ **Configuring Domain Name of Client**

- Optional. It is used to configure the domain name of a client.
- Run the **domain-name** command in DHCP address pool configuration mode.

✚ **Configuring DNS**

- Optional. It is used to configure a DNS address.
- Run the **dns** command in DHCP address pool configuration mode.

✚ **Configuring NetBIOS WINS Server**

- Optional. It is used to configure a NetBIOS WINS server address.
- Run the **netbios-name-server** command in DHCP address pool configuration mode.

✚ **Configuring NetBIOS Node Type on Client**

- Optional. It is used to configure a NetBIOS node type.
- Run the **netbios-name-type** command in DHCP address pool configuration mode.

✚ **Configuring Alarm Threshold of Address Pool**

- Optional. It is used to manage the number of leases. When a threshold (90% by default) is reached, an alarm will be printed.
- Run the **lease-threshold** command in DHCP address pool configuration mode.

✚ **Configuring User-Defined Option**

- Optional. It is used to configure user-defined options.
- Run the **option** command in DHCP address pool configuration mode.

✚ **Enabling or Disabling Address Pool**

- Optional. It is used to enable or disable an address pool. It is enabled by default.
- Run the **pool-status** command in DHCP address pool configuration mode.

Verification

Connect a DHCP client and a DHCP server.

- Check whether the client obtains configurations on the server.

Related Commands

✚ **Enabling DHCP Server**

Command	service dhcp
Parameter	N/A

Description	
Command	Global configuration mode
Mode	
Usage Guide	Enable DHCP Server and DHCP Relay. A DHCP server and a DHCP relay share the service dhcp command. When a device is configured with a valid address pool, it acts as a server and forwards packets. Otherwise, it serves as a relay agent.

↘ Configuring Address Pool

Command	ip dhcp pool <i>dhcp-pool</i>
Parameter	<i>pool-name</i> : Indicates the name of an address pool.
Description	
Command	Global configuration mode
Mode	
Usage Guide	Before assigning an IP address to a client, you need to configure an address pool name and enter DHCP address pool configuration mode.

↘ Configuring Network Number and Subnet Mask of DHCP Address Pool

Command	network <i>network-number mask [low-ip-address high-ip-address]</i>
Parameter	<i>network-number</i> : Indicates the network number of an IP address pool.
Description	<i>mask</i> : Indicates the subnet mask of an IP address pool. If no subnet mask is defined, the natural subnet mask is applied.
Command	DHCP address pool configuration mode
Mode	
Usage Guide	<p>To configure dynamic address assignment, you need to configure a network number and subnet mask of an address pool to provide a DHCP server with a range of addresses. The IP addresses in a pool are assigned in order. If an address is assigned or exists in the target network segment, the next address will be checked until a valid address is assigned.</p> <p>FS wireless products provide available network segments by specifying start and end addresses. The configuration is optional. If the start and end address are not specified, all IP addresses in the network segment are assignable.</p> <p>For FS products, addresses are assigned based on the client's physical address and ID. Therefore, one client will not be assigned two leases from one address pool. In case of topological redundancy between a client and a server, address assignment may fail.</p> <p>To avoid such failures, a network administrator needs to prevent path redundancy in network construction, for example, by adjusting physical links or network paths.</p>

↘ Configuring Default Gateway of Client

Command	default-router <i>address [address2...address8]</i>
Parameter	<i>address</i> : Indicates the IP address of a default gateway. Configure at least one IP address.
Description	<i>ip-address2...ip-address8</i> : (Optional) A maximum of 8 gateways can be configured.
Command	DHCP address pool configuration mode
Mode	
Usage Guide	Configure a default gateway of a client, and a server will push the gateway configuration to the client. The IP addresses of the default gateway and the client should be in a same network.

↘ Configuring Address Lease

Command	lease { <i>days</i> [<i>hours</i>] [<i>minutes</i>] infinite }
Parameter	<i>days</i> : Defines a lease in the unit of day.
Description	<i>hours</i> : (Optional) Defines a lease in the unit of hour. Please define <i>days</i> before <i>hours</i> . <i>minutes</i> : (Optional) Defines a lease in the unit of minute. Please define <i>days</i> and <i>hours</i> before <i>minutes</i> . infinite : Defines an unlimited lease.
Command	DHCP address pool configuration mode
Mode	
Usage Guide	The default lease of an IP address assigned by a DHCP server is 1 day. When a lease is expiring soon, a client needs to request a lease renewal. Otherwise the IP address cannot be used after the lease is expired.

↘ Configures Boot File on Client

Command	bootfile <i>filename</i>
Parameter	<i>file-name</i> : Defines a boot file name.
Description	
Command	DHCP address pool configuration mode
Mode	
Usage Guide	A boot file is a bootable image file used when a client starts up. The file is usually an OS downloaded by a DHCP client.

↘ Configuring Domain Name of Client

Command	domain-name <i>domain</i>
Parameter	<i>domain-name</i> : Defines a domain name of a DHCP client.
Description	
Command	DHCP address pool configuration mode
Mode	
Usage Guide	You may define a domain name for a client. When the client accesses network through the host name, the domain name will be added automatically to complete the host name.

↘ Configuring DNS

Command	dns-server { <i>ip-address</i> [<i>ip-address2</i> ... <i>ip-address8</i>] }
Parameter	<i>ip-address</i> : Defines an IP address of a DNS server. Configure at least one IP address.
Description	<i>ip-address2</i> ... <i>ip-address8</i> : (Optional) A maximum of 8 DNS servers can be configured.
Command	DHCP address pool configuration mode
Mode	
Usage Guide	If a client accesses network resources through the domain name, you need to configure a DNS server to resolve the domain name.

↘ Configuring NetBIOS WINS Server

Command	netbios-name-server <i>address</i> [<i>address2</i> ... <i>address8</i>]
Parameter	<i>address</i> : Defines an IP address of a WINS server. Configure at least one IP address.
Description	<i>ip-address2</i> ... <i>ip-address8</i> : (Optional) A maximum of 8 WINS servers can be configured.
Command	DHCP address pool configuration mode

Mode	
Usage Guide	WINS is a domain name service through which a Microsoft TCP/IP network resolves a NetBIOS name to an IP address. A WINS server is a Windows NT server. When a WINS server starts, it receives a registration request from a WINS client. When the client shuts down, it sends a name release message, so that the computers in the WINS database and on the network are consistent.

📌 **Configuring NetBIOS Node Type on Client**

Command	netbios-node-type <i>type</i>
Parameter	<i>type</i> : Defines a NetBIOS node type with one of the following approaches.
Description	<p>1. A hexadecimal number, ranging from 0 to FF. Only followings values are available.</p> <ul style="list-style-type: none"> ● b-node ● p-node ● m-node ● 8 for h-node <p>2. A character string.</p> <ul style="list-style-type: none"> ● b-node for a broadcast node; ● p-node for a peer-to-peer node; ● m-node for a mixed node; ● h-node for a hybrid mode.
Command	DHCP address pool configuration mode
Mode	
Usage Guide	There are four types of NetBIOS nodes of a Microsoft DHCP client. 1) A broadcast node. For such a node, NetBIOS name resolution is requested through broadcast.2) A peer-to-peer node. The client sends a resolution request to the WINS server. 3) A mixed node. The client broadcasts a resolution request and sends the resolution request to the WINS server.. 4) A hybrid node. The client sends a resolution request to the WINS server. If no reply is received, the client will broadcast the resolution request. By default, a Microsoft operating system is a broadcast or hybrid node. If no WINS server is configured, it is a broadcast node. Otherwise, it is a hybrid node.

📌 **Configuring User-Defined Option**

Command	option <i>code</i> { ascii <i>string</i> hex <i>string</i> ip <i>ip-address</i> }
Parameter	<i>code</i> : Defines a DHCP option code.
Description	<p>ascii <i>string</i>: Defines an ASCII character string.</p> <p>hex <i>string</i>: Defines a hexadecimal character string.</p> <p>ip <i>ip-address</i>: Defines an IP address.</p>
Command	DHCP address pool configuration mode
Mode	
Usage Guide	<p>The DHCP allows transmitting configuration information to a host via a TCP/IP network. DHCP packets contain the option field of definable content. A DHCP client should be able to receive a DHCP packet carrying at least 312 bytes option. Besides, the fixed data field in a DHCP packet is also called an option.</p> <p>In a WLAN, a DHCP client on an AP dynamically requests the IP address of an AC. You may configure on a DHCP server the option command specifying the AC address.</p>

📌 **Enabling or Disabling Address Pool**

Command	pool-status { enable disable }
----------------	---

Parameter	enable: Enables an address pool.
Description	disable: Disable an address pool. It is enabled by default.
Command	DHCP address pool configuration mode
Mode	
Usage Guide	A FS wireless product provides a command for you to enable/disable a DHCP address pool.

Configuration Example

↘ Configuring Address Pool

Configuration Steps	<ul style="list-style-type: none"> ● Define an address pool net172. ● The network segment is 172.16.1.0/24. ● The default gateway is 172.16.1.254. ● The address lease is 1 day. ● xcluded addresses range from 172.16.1.2 to 172.16.1.100.
	<pre>FS(config)# ip dhcp excluded-address 172.16.1.2 172.16.1.100 FS(dhcp-config)# ip dhcp pool net172 FS(dhcp-config)# network 172.16.1.0 255.255.255.0 FS(dhcp-config)# default-router 172.16.1.254 FS(dhcp-config)# lease 1</pre>
Verification	Run the show run command to display the configuration.
	<pre>FS(config)#show run begin ip dhcp ip dhcp excluded-address 172.16.1.2 172.16.1.100 ip dhcp pool net172 network 172.16.1.0 255.255.255.0 default-router 172.16.1.254lease 1</pre>

4.4.2Configuring Static IP Address

Configuration Effect

Assign specific IP addresses and push configuration to specific DHCP clients.

Notes

N/A

Configuration Steps

↘ Configuring Address Pool Name and Entering Address Pool Configuration Mode

- Mandatory. It is used to create an IP address pool.
- Run the **ip dhcp pool** command in global configuration mode.

➤ **Configuring IP Address and Subnet Mask of Client**

- Mandatory. It is used to configure a static IP address and a subnet mask.
- Run the **host** command in DHCP address pool configuration mode.

➤ **Configuring Hardware Address of Client**

- Optional. It is used to configure a MAC address.
- Run the **hardware** command in DHCP address pool configuration mode.

➤ **Configures Unique Client Identifier**

- Optional. It is used to configure a static user identifier (UID).
- Run the **client-identifier** command in DHCP address pool configuration mode.

➤ **Configuring Client Name**

- Optional. It is used to configure a static client name.
- Run the **host-name** command in DHCP address pool configuration mode.

Verification

Check whether the client obtains the IP address when it is online.

Related Commands

➤ **Configuring Address Pool**

Command	ip dhcp pool <i>dhcp-pool</i>
Parameter Description	<i>pool-name</i> : Indicates the name of an address pool.
Command Mode	Global configuration mode
Usage Guide	Before assigning an IP address to a client, you need to configure an address pool name and enter address pool configuration mode.

➤ **Manual IP Address Binding**

Command	host <i>ip-address</i> [<i>netmask</i>] client-identifier <i>unique-identifier</i> client-name <i>name</i>
Parameter Description	<i>ip-address</i> : Defines the IP address of a DHCP client. <i>netmask</i> : Defines the subnet mask of a DHCP client. <i>unique-identifier</i> : Defines the hardware address (for example, aabb.bbbb.bb88) and identifier (for example, 01aa.bbbb.bbbb.88) of a DHCP client. <i>name</i> : (Optional) It defines a client name using ASCII characters. The name excludes a domain name. For example, name a host mary rather than mary.rg.com .
Command Mode	DHCP address pool configuration mode
Usage Guide	Address binding means mapping between an IP address and a client's MAC address. There are two kind of address

	<p>binding. 1) Manual binding. Manual binding can be deemed as a special DHCP address pool with only one address.</p> <p>2) Dynamic binding. A DHCP server dynamically assigns an IP address from a pool to a client when it receives a DHCP request, creating mapping between the IP address and the client's MAC address.</p> <p>To configure manual binding, you need to define a host pool and then specify a DHCP client's IP address and hardware address or identifier. A hardware address is a MAC address. A client identifier includes a network medium type and a MAC address. A Microsoft client is usually identified by a client identifier rather than a MAC address. For the codes of medium types, refer to the <i>Address Resolution Protocol Parameters</i> section in the RFC 1700. The Ethernet type is 01.</p>
--	---

Configuration Example

↘ **Dynamic IP Address Pool**

Configuration Steps	<ul style="list-style-type: none"> ● Configure address pool VLAN 1 with IP address 20.1.1.0 and subnet mask 255.255.255.0. ● The default gateway is 20.1.1.1. ● The lease time is 1 day.
	<pre>FS(config)# ip dhcp pool vlan1 FS(dhcp-config)# network 20.1.1.0 255.255.255.0 FS(dhcp-config)# default-router 20.1.1.1 FS(dhcp-config)# lease 1 0 0</pre>
Verification	Run the show run command to display the configuration.
	<pre>FS(config)#show run begin ip dhcp ip dhcp pool vlan1 network 20.1.1.0 255.255.255.0 default-router 20.1.1.1 lease 1 0 0</pre>

↘ **Manual Binding**

Configuration Steps	<ul style="list-style-type: none"> ● The host address is 172.16.1.101 and the subnet mask is 255.255.255.0. ● The host name is Billy.rg.com. ● The default gateway is 172.16.1.254. ● The MAC address is 00d0.df34.32a3.
	<pre>FS(config)# ip dhcp pool Billy FS(dhcp-config)# host 172.16.1.101 255.255.255.0 FS(dhcp-config)# client-name Billy FS(dhcp-config)# hardware-address 00d0.df34.32a3 Ethernet FS(dhcp-config)# default-router 172.16.1.254</pre>

Verification	Run the show run command to display the configuration.
	<pre>FS(config)#show run begin ip dhcp ip dhcp pool Billy host 172.16.1.101 255.255.255.0 client-name Billy hardware-address 00d0.df34.32a3 Ethernet default-router 172.16.1.254</pre>

4.4.3 Configuring AM Rule for DHCP Server

Configuration Effect

Assign IP addresses according to an AM rule based on a port and a VLAN.

Notes

FS products support AM rule configuration on Ethernet, GB, FR, PPP and HDLC interfaces.

Configuration Steps

⌵ Configuring Address Management

- Mandatory. Enter address management mode.
- Run the **address-manage** command in address management configuration mode.

⌵ Configuring AM Rule

- Mandatory. Configure an AM rule based on a port and a VLAN.
- Run the **match ip** command in address management configuration mode.

Verification

Check whether clients in different VLANs and ports obtain the valid IP addresses.

Related Commands

⌵ Configuring Default Range

Command	match ip default <i>ip-address netmask</i>
Parameter	<i>ip-address</i> : Defines an IP address.
Description	<i>netmask</i> : Defines a subnet mask.
Command Mode	Address management mode
Usage Guide	After configuration, all DHCP clients are assigned IP addresses from the default range based on the VLAN and port. If this command is not configured, IP addresses will be assigned through the regular process.

⌵ Assigning Dynamic IP Address Based on VLAN and Port

Command	match ip <i>ip-address netmask interface</i> [add/remove] vlan <i>vlan-list</i>
Parameter	<i>ip-address</i> : Defines an IP address.
Description	<i>netmask</i> : Defines a subnet mask. <i>interface</i> : Defines an interface name. <i>add/remove</i> : Adds or deletes a specific VLAN. <i>vlan-list</i> : Indicates a VLAN index.
Command Mode	Address management mode
Usage Guide	After configuration, DHCP clients are assigned IP addresses from the default address range based on the VLAN and port.

➤ **Assigning Static IP Address Based on VLAN**

Command	match ip <i>ip-address netmask</i> [add/remove] vlan <i>vlan-list</i>
Parameter	<i>ip-address</i> : Defines an IP address.
Description	<i>netmask</i> : Defines a subnet mask. <i>add/remove</i> : Adds or deletes a specific VLAN. <i>vlan-list</i> : Indicates a VLAN index.
Command Mode	Address management mode
Usage Guide	In a Super VLAN, a client may be assigned a fixed static address no matter which Super VLAN the client resides in. You do not need to configure an AM rule for this IP address based on all sub-VLANs and ports, but only configure an AM rule based on the VLAN. This rule takes effect for only static address assignment.

Configuration Example

➤ **Configuring AM Rule**

Configuration Steps	<ul style="list-style-type: none"> ● Configure a default rule. ● Configure a rule based on a specific VLAN + port + address range. ● Configure a rule based on a specific VLAN + address range.
	<pre>FS(config)# address-manage FS(config-address-manage)# match ip default 172.50.128.0 255.255.128.0 FS(config-address-manage)# match ip 10.1.5.0 255.255.255.0 Gi5/3 vlan 1005 FS(config-address-manage)# match ip 10.1.6.0 255.255.255.0 vlan 1006</pre>
Verification	1: Run the show run command to display the configuration.
	<pre>address-manage match ip default 172.50.128.0 255.255.128.0 match ip 10.1.5.0 255.255.255.0 Gi5/3 vlan 1005 match ip 10.1.6.0 255.255.255.0 vlan 1006</pre>

4.4.4 Configuring Global Properties of DHCP Server

Configuration Effect

Enable a server with specific functions, for example, ping and compulsory NAK.

Notes

Configuring the command may cause exceptions on other servers.

Configuration Steps

✚ Configuring Excluded IP Address

- Optional. Configure some addresses or address ranges as unavailable.
- Run the **ip dhcp excluded-address** command in global configuration mode.

✚ Configuring Compulsory NAK Reply

- Optional. A server replies to a wrong address request with a NAK packet.
- Run the **ip dhcp force-send-nak** command in global configuration mode.

✚ Configuring VRRP Status Monitoring

- Optional. After configuration, DHCP packets are processed by the Master server.
- Run the **ip dhcp monitor-vrrp-state** command in global configuration mode.

✚ Configuring Ping Times

- Optional. Check the address reachability with the **ping** command. The default is 2.
- Run the **ip dhcp ping packet** command in global configuration mode.

✚ Configuring Ping Timeout

- Optional. Check the address reachability with the **ping** command. The default is 500 ms.
- Run the **ip dhcp ping timeout** command in global configuration mode.

✚ Detecting User Offline Detection

- Configure a DHCP server to detect whether the client is offline or not. If a client does not get online after being offline for a period, the address assigned to the client will be retrieved.
- Run the **ip dhcp server arp-detect** command in global configuration mode.

Verification

Run the **dhcp-server** command, and check the configuration during address assignment.

Related Commands

✚ Configuring Excluded IP Address

Command	ip dhcp excluded-address <i>low-ip-address</i> [<i>high-ip-address</i>]
Parameter	<i>low-ip-address</i> : Indicates a start IP address.

Description	<i>high-ip-address</i> : Indicates an end IP address.
Command Mode	Global configuration mode
Usage Guide	Unless otherwise specified, a DHCP server assigns all the addresses from an IP address pool to DHCP clients. To reserve some addresses(e.g., addresses already assigned to the server or devices), you need to configure these addresses as excluded addresses. To configure a DHCP server, it is recommended to configure excluded addresses to avoid address conflict and shorten detection time during address assignment.

↘ Configuring Compulsory NAK Reply

Command	ip dhcp force-send-nak
Parameter Description	N/A
Command Mode	Global configuration mode
Usage Guide	<p>In a WLAN, a DHCP client often moves from one network to another. When a DHCP server receives a lease renewal request from a client but finds that the client crosses the network segment or that the lease is expired, it replies with a NAK packet to require the client to obtain an IP address again. This prevents the client from sending request packets continually before obtaining an IP address again after timeout.</p> <p>The server sends a NAK packet only when it finds the client's lease record. When a DHCP client crosses the network, a DHCP server cannot find lease record of the client and will not reply with a NAK packet. The client sends request packets continually before obtaining an IP address again after timeout. Consequently, it takes a long to obtain an IP address. This also occurs when a DHCP server loses a lease after restart and a client requests lease renewal. In this case, you may configure a command to force the DHCP server to reply with a NAK packet even though it cannot find the lease record so that the client may obtain an IP address rapidly. Please note that the command is disabled by default. To enable it, only one DHCP server can be configured in a broadcast domain.</p>

↘ Configuring Ping Times

Command	ip dhcp ping packets [<i>number</i>]
Parameter Description	<i>number</i> : (Optional) Ranges from 0 to 10. 0 indicates the ping function is disabled. The default is two pings.
Command Mode	Global configuration mode
Usage Guide	By default, when a DHCP server assigns an IP address from a pool, it runs the Ping command twice (one packet per time). If there is no reply, the server takes the address as idle and assigns it to a client. If there is a reply, the server takes the address as occupied and assigns another address.

↘ Configuring Ping Timeout

Command	ip dhcp ping timeout <i>milliseconds</i>
Parameter Description	<i>milli-seconds</i> : Indicates the time that it takes for a DHCP server to wait for a ping reply. The value ranges from 100 ms to 10,000 ms.
Command Mode	Global configuration mode
Usage Guide	By default, if a DHCP server receives no Ping reply within 500 ms, the IP address is available. You may adjust the ping timeout to change the time for a server to wait for a reply.

Configuration Example

Configuring Ping

Configuration Steps	<ul style="list-style-type: none"> ● Set ping times to 5. ● Set ping timeout to 800 ms.
	<pre>FS(config)# ip dhcp ping packet 5 FS(config)# ip dhcp ping timeout 800</pre>
Verification	Run the show run command to display the configuration.
	<pre>FS(config)#show run begin ip dhcp ip dhcp ping packet 5 ip dhcp ping timeout 800</pre>

Configuring Excluded IP Address

Configuration Steps	<ul style="list-style-type: none"> ● Configure the excluded IP address from 192.168.0.0 to 192.168.255.255.
	<pre>FS(config)# ip dhcp excluded-address 192.168.0.0 192.168.255.255</pre>
Verification	Run the show run command to display the configuration.
	<pre>FS(config)#show run begin ip dhcp ip dhcp excluded-address 192.168.0.0 192.168.255.255</pre>

4.4.5 Configuring Basic DHCP Relay Functions

Configuration Effect

- Deploy dynamic IP management in Client-Relay-Server mode to achieve communication between a DHCP client and a DHCP server, which are in different network segments.

Notes

- To enable DHCP Relay, you need to configure IPv4 unicast routing in a network.

Configuration Steps

Enabling DHCP Relay

- Mandatory.
- Unless otherwise specified, you need to enable DHCP Relay on a device.

Configuring IP Address for DHCP Server

- Mandatory.
- You need to configure an IP address for a DHCP server.

➤ **Disabling DHCP Relay on Interface**

- Optional.
- DHCP relay is enabled on the interface by default. Run the **ip dhcp relay disable** command to disable DHCP relay on the interface

Verification

- Check whether a client obtains an IP address through DHCP Relay.

Related Commands

➤ **Enabling DHCP Relay**

Command	service dhcp
Parameter	N/A
Description	
Command Mode	Global configuration mode
Usage Guide	N/A

➤ **Configuring IP Address for DHCP Server**

Command	ip helper-address { cycle-mode [[vrf { vrf-name }] A.B.C.D }
Parameter Description	<i>cycle-mode</i> : Indicates that DHCP request packets are forwarded to all DHCP servers. <i>vrf-name</i> : Indicates a VPN Routing & Forwarding (VRF) name. <i>A.B.C.D</i> : Indicates the IP address of a server.
Command Mode	Global configuration mode/interface configuration mode
Usage Guide	You may configure the function on a layer-3 interface, such as a routed port, a L3 AP port, SVI and loopback interface. The configured interface must be accessible via IPv4 unicast routing.

➤ **Disabling DHCP Relay on Interface**

Command	ip dhcp relay disable
Parameter Description	N/A
Command Mode	Interface configuration mode
Usage Guide	The function should be configured on a layer-3 interface. DHCP Relay function will be disabled on the interface.

Configuration Example

➤ **Configuring DHCP Relay in Wired Connection**



<p>Configuration Steps</p>	<ul style="list-style-type: none"> ● Enable a client with DHCP to obtain an IP address. ● Enable the DHCP Relay function on a DHCP relay agent. ● Configure DHCP Server.
<p>A</p>	<p>Enable a client with DHCP to obtain an IP address.</p>
<p>B</p>	<p>Enable DHCP Relay.</p> <pre>FS(config)# service dhcp</pre> <p>Configure a global IP address of a DHCP server.</p> <pre>FS(config)# ip helper-address 172.2.2.1</pre> <p>Configure an IP address for the port connected to the client.</p> <pre>FS(config)# interface gigabitEthernet 0/1 FS(config-if)# ip address 192.1.1.1 255.255.255.0</pre> <p>Configure an IP address for the port connected to the server.</p> <pre>FS(config)# interface gigabitEthernet 0/2 FS(config-if-gigabitEthernet 0/2)# ip address 172.2.2.2 255.255.255.0</pre>
<p>C</p>	<p>Enable DHCP Server.</p> <pre>FS(config)# service dhcp</pre> <p>Configure an address pool.</p> <pre>FS(config)# ip dhcp pool relay FS (dhcp-config)#network 192.1.1.0 255.255.255.0 FS (dhcp-config)#default-router 192.1.1.1</pre> <p>Configure an IP address for the port connected to the relay agent.</p> <pre>FS(config)# interface gigabitEthernet 0/1 FS(config-if-gigabitEthernet 0/2)# ip address 172.2.2.1 255.255.255.0</pre>
<p>Verification</p>	<p>Check whether the client obtains an IP address.</p> <ul style="list-style-type: none"> ● Check whether the client obtains an IP address. ● Check the DHCP Relay configuration.
<p>A</p>	<p>The user device obtains an IP address.</p>
<p>B</p>	<p>After login to the DHCP relay agent, run the show running-config command in privileged EXEC mode to display DHCP Relay configuration.</p> <pre>FS# show running-config service dhcp ip helper-address 172.2.2.1 ! interface GigabitEthernet 0/1</pre>

```
ip address 192.1.1.1 255.255.255.0
!
interface GigabitEthernet 0/2
ip address 172.2.2.2 255.255.255.0
!
```

Common Errors

- IPv4 unicast routing configuration is incorrect.
- DHCP Relay is disabled.
- No routing between DHCP relay agent and DHCP server is configured.
- No IP address is configured for the DHCP server.

4.4.6 Configuring DHCP Relay Option 82

Configuration Effect

- Through a DHCP relay agent, a server may assign IP addresses of different privileges to the clients more accurately based on the option information.

Notes

- You need to enable the DHCP Relay function.

Configuration Steps

➤ Enabling Basic DHCP Relay Functions

- Mandatory.
- Unless otherwise specified, you need to enable DHCP Relay on a device.

➤ Enables DHCP Option82

- By default, DHCP Option 82 is disabled.
- You may run the **ip dhcp relay information option82** command to enable or disable DHCP Option 82.

➤ Configuring the DHCP Option 82 User-definition Function for a Port

- Run the **ip dhcp relay information option82 user-defined {circuit-id | remote-id} text** command to configure the DHCP Option 82 user-definition function.
- Optional. The configuration takes effect in global configuration mode.

➤ Configuring the Format of the MAC Address in DHCP Option 82 for a Port

- Run the **ip dhcp relay information option82 user-defined user-defined mac-format type** command to configure the format of the MAC address in DHCP Option 82.
- Optional. The configuration takes effect in global configuration mode.

➤ Enabling DHCP Option 82 on Interface

- Optional. The configuration takes effect in interface configuration mode.
- Run the **ip dhcp relay-information enable** command to enable DHCP Option 82 on the interface.

➤ **Defining Circuit-ID of DHCP Option 82 on Layer-3 Interface**

- Optional. The configuration takes effect in interface configuration mode.
- Run the **ip dhcp relay-information layer3 circuit-id format {hex | ascii} string** command to define the circuit-ID of DHCP Option 82 on the layer-3 interface.

➤ **Defining Remote-ID of DHCP Option 82 on Layer-3 Interface**

- Optional. The configuration takes effect in interface configuration mode.
- Run the **ip dhcp relay-information layer3 remote-id format {hex | ascii} string** command to define the remote-ID of DHCP Option 82 on the layer-3 interface.

Verification

- Check whether the client obtains an IP address based on Option 82.

Related Commands

➤ **Enabling DHCP Option 82**

Command	ip dhcp relay information option82
Parameter	N/A
Description	
Command Mode	Global configuration mode
Usage Guide	N/A

➤ **Configuring the DHCP Option 82 User-definition Function for a Port**

Command	ip dhcp relay information option82 user-defined {circuit-id remote-id} text
Parameter	N/A
Description	
Command Mode	Global configuration mode
Usage Guide	N/A

➤ **Configuring the Format of the MAC Address in DHCP Option 82 for a Port**

Command	ip dhcp relay information option82 user-defined mac-format type
Parameter	N/A
Description	
Command Mode	Global configuration mode
Usage Guide	N/A

Configuration Example

➤ **Enabling DHCP Option 82**

Configuration Steps	<ul style="list-style-type: none"> ● Enable DHCP Option 82.
	<pre>FS(config)# ip dhcp relay information option82 FS(config)# ip dhcp relay information option82 user-defined circuit "%hostname-portname" FS(config)# ip dhcp relay infotmation option82 user-defined remote-id "%sysmac:%svlan" FS(config)# ip dhcp relay infotmation option82 user-defined mac-format 1</pre>
Verification	<p>After login to the DHCP relay agent, run the show running-config command in privileged EXEC mode to display DHCP Relay configuration.</p>
	<pre>FS#show ru incl ip dhcp relay ip dhcp relay information option82 ip dhcp relay information option82 user-defined circuit "%hostname-portname" ip dhcp relay infotmation option82 user-defined remote-id "%sysmac:%svlan" ip dhcp relay infotmation option82 user-defined mac-format 1</pre>

Common Errors

- Basic DHCP Relay functions are not configured.

4.4.7 Configuring DHCP Relay Check Server-ID

Configuration Effect

- After you configure the **ip dhcp relay check server-id**, a DHCP Relay agent will forward DHCP request packets only to the server specified by the **option server-id** command. Otherwise, they are forwarded to all DHCP servers.

Notes

- You need to enable basic DHCP Relay functions.

Configuration Steps

➤ **Enabling DHCP Relay Check Server-ID**

- By default, DHCP Relay check server-id is disabled.
- You may run the **ip dhcp relay check server-id** command to enable DHCP Relay check server-id.

Verification

Check whether a DHCP Relay agent sends DHCP request packets only to the server specified by the **option server-id** command.

Related Commands

➤ **Configuring DHCP Relay Check Server-ID**

Command	ip dhcp relay check server-id
----------------	--------------------------------------

Parameter	N/A
Description	
Command	Global configuration mode
Mode	
Usage Guide	N/A

Configuration Example

📌 **Configuring DHCP Relay Check Server-ID**

Configuration Steps	<ul style="list-style-type: none"> ● Enable DHCP Relay.Omitted. ● Enable DHCP Relay check server-id on an interface.
	<pre>FS# configure terminal FS(config)# ip dhcp relay check server-id</pre>
Verification	After login to the DHCP relay agent, run the show running-config command in privileged EXEC mode to display DHCP Relay configuration.
	<pre>FS# show running-config include check server-id ip dhcp relay check server-id FS#</pre>

Common Errors

- Basic DHCP Relay functions are not configured.

4.4.8Configuring DHCP Relay Suppression

Configuration Effect

- After you configure the **ip DHCP Relay suppression** command on an interface, DHCP request packets received on the interface will be filtered, and the other DHCP requests will be forwarded.

Notes

- You need to enable basic DHCP Relay functions.

Configuration Steps

📌 **Enabling DHCP Relay Suppression**

By default, DHCP Relay suppression is disabled on all interfaces.

You may run the **ip dhcp relay suppression** command to enable DHCP Relay suppression.

Verification

- Check whether the DHCP request packets received on the interface are filtered.

Related Commands

📌 **Configuring DHCP Relay Suppression**

Command	ip dhcp relay suppression
Parameter	N/A
Description	
Command Mode	Interface configuration mode
Usage Guide	N/A

Configuration Example

Configuring DHCP Relay Suppression

Configuration Steps	<ul style="list-style-type: none"> ● Configure basic DHCP Relay functions. ● Configure DHCP Relay suppression on an interface.
	<pre>FS# configure terminal FS(config)# interface gigabitEthernet 0/1 FS(config-if-GigabitEthernet 0/1)# ip dhcp relay suppression FS(config-if-GigabitEthernet 0/1)#end FS#</pre>
Verification	After login to the DHCP relay agent, run the show running-config command in privileged EXEC mode to display DHCP Relay configuration.
	<pre>FS# show running-config include relay suppression ip dhcp relay suppression FS#</pre>

Common Errors

Basic DHCP Relay functions are not configured.

4.4.9 Configuring Multiple Gateway IP Addresses on DHCP Relay

Configuration Effect

Enable the function of multiple gateway IP addresses by running the **ip dhcp relay multiple-giaddr** command.

Notes

Basic DHCP Relay functions should be configured.

Configuration Steps

By default, this function is disabled.

Run the **ip dhcp relay multiple-giaddr** command to enable this function.

Verification

When more than one IP address is configured on a specified interface, check whether the DHCP request packet forwarded to the DHCP server contains different IP addresses.

Related Commands

📄 **Configuring Multiple Gateway IP Addresses**

Command	<code>ip dhcp relay multiple-giaddr</code>
Parameter	N/A
Description	
Command Mode	Global configuration mode
Usage Guide	N/A

Configuration Example

📄 **Configuring Multiple Gateway IP Addresses**

Configuration Steps	<ul style="list-style-type: none"> 1: Configure basic DHCP Relay functions. 2: Configure the function of multiple gateway IP addresses.
	<pre>FS# configure terminal FS(config)# ip dhcp relay multiple-giaddr</pre>
Verification	<ul style="list-style-type: none"> 1: Log in the DHCP Relay Agent; and then in Privileged EXEC mode, run the show running-config command to display the DHCP Relay configuration.
	<pre>FS# show running-config ip dhcp relay multiple-giaddr</pre>

Common Errors

Basic DHCP Relay functions are not configured.

4.4.10 Configuring the Automatic Gateway Address Switching of the DHCP Relay

Configuration Effect

- Configure the `ip dhcp smart-relay` command to enable the automatic gateway address switching function.

Notes

- Basic functions of the DHCP relay must be configured.

Configuration Steps

📄 **Enabling the Automatic Gateway Address Switching Function of the DHCP Relay**

The function is disabled by default.

Run the `ip dhcp smart-relay` command to enable the function.

Verification

- Configure multiple IP addresses on an interface. If the DHCP relay fails to receive a response after forwarding three Discover packets, the DHCP relay switches the gateway address.

Related Commands

📌 **Configuring the Automatic Gateway Address Switching Function of the DHCP Relay**

Command	<code>ip dhcp smart-relay</code>
Parameter	N/A
Description	
Command Mode	Global configuration mode
Usage Guide	N/A

Configuration Example

📌 **Configuring the Automatic Gateway Address Switching Function of the DHCP Relay**

Configuration Steps	<ul style="list-style-type: none"> ● Configure basic functions of the DHCP relay. Omitted. ● Configure the automatic gateway address switching function of the DHCP relay.
	<pre>FS#configure terminal FS(config)# ip dhcp smart-relay</pre>
Verification	Log in to the DHCP relay agent. In privileged EXEC mode, run the show running-config command to display the DHCP relay configuration.
	<pre>FS# show running-config ip dhcp smart-relay</pre>

Common Errors

Basic functions of the DHCP relay are not configured or the configuration fails.

4.4.11 Forcing the DHCP Relay to Send the Reply Message

Configuration Effect

Run the **ip dhcp relay force-send-reply-pack** command to force the DHCP Relay to send the reply message.

Notes

- Basic DHCP Relay functions should be enabled.

Configuration Steps

📌 **Forcing the DHCP Relay to Send the Reply Message**

- By default, the DHCP Relay is not forced to send the reply message.
- Run the **ip dhcp relay force-send-reply-pack** command to enable this functionality.

Verification

The DHCP Relay does not receive the Discover message but receives the Offer message, and the Offer message can be forwarded to the gateway interface.

Related Commands

▾ **Forcing the DHCP Relay to Send the Reply Message**

Command	<code>ip dhcp relay force-send-reply-pack</code>
Parameter	N/A
Description	
Command Mode	Global configuration mode
Usage Guide	N/A

Configuration Example

▾ **Forcing the DHCP Relay to Send the Reply Message**

Configuration Steps	<ol style="list-style-type: none"> 1: Enable basic DHCP Relay functions. 2: Forcing the DHCP Relay to send the reply message.
	<pre>FS# configure terminal FS(config)# ip dhcp relay force-send-reply-pack</pre>
Verification	<ol style="list-style-type: none"> 1: Login the DHCP Relay Agent. 2: Enter the Privileged EXEC mode. 3: Run the show running-config command to display DHCP Relay configurations.

Common Errors

Basic DHCP Relay functions are not configured.

4.4.12 Configuring the Source IP Address of DHCP Relay Packets

Configuration Effect

Run the `ip dhcp relay source` command on an interface to configure the source IP address of DHCP Relay packets.

Notes

- Basic DHCP Relay functions should be enabled.
- Only one source IP address of DHCP Relay packets can be configured on one interface.
- To assign correct subnet addresses to users, this function should be used with Option 82.

Configuration Steps

▾ **Configuring the Source IP Address of DHCP Relay Packets**

- By default, no source IP address of DHCP Relay packets is configured.

- Run the **ip dhcp relay source** *ip-address* command on an interface to configure the source IP address of DHCP Relay packets.

Verification

After this function is enabled, the source IP address of Relay packets sent to the DHCP server is the configured address.

Related Commands

▾ **Configuring the Source IP Address of DHCP Relay Packets**

Command	ip dhcp relay source <i>ip-address</i>
Parameter Description	<i>ip-address</i> : Specifies the source IP address of DHCP Relay packets.
Command Mode	Interface configuration mode
Usage Guide	N/A

Configuration Example

▾ **Configuring the Source IP Address of DHCP Relay Packets**

Configuration Steps	1: Enable basic DHCP Relay functions. 2: Configure the source IP address of DHCP Relay packets.
	<pre>FS(config-if)# ip dhcp relay source 1.1.1.1</pre>
Verification	1: Login the DHCP Relay Agent. 2: Enter the Privileged EXEC mode. 3: Run the show running-config command to display DHCP Relay configurations.

Common Errors

Basic DHCP Relay functions are not configured.

4.4.13 Configuring DHCP Client

Configuration Effect

Enable DHCP Client on a device so that it obtains IP addresses and configurations dynamically.

Notes

FS products support DHCP Client configuration on Ethernet, FR, PPP and HDLC interfaces.

Configuration Steps

Run the **ip address dhcp** command on an interface.

Verification

Check whether the interface obtains an IP address.

Related Commands

➤ **Configuring DHCP Client**

Command	ip address dhcp
Parameter	N/A
Description	
Command Mode	Interface configuration mode
Usage Guide	<ul style="list-style-type: none"> ● FS products support dynamic IP address obtainment by an Ethernet interface. ● FS products support dynamic IP address obtainment by a PPP-encapsulated interface. ● FS products support dynamic IP address obtainment by an FR-encapsulated interface. ● FS products support dynamic IP address obtainment by an HDLC-encapsulated interface.

Configuration Example

➤ **Configuring DHCP Client**

Configuration Steps	1: Enable port FastEthernet 0/0 with DHCP to obtain an IP address.
	<pre>FS(config)# interface FastEthernet0/0 FS(config-if-FastEthernet 0/0)#ip address dhcp</pre>
Verification	1: Run the show run command to display the configuration.
	<pre>FS(config)#show run begin ip address dhcp ip address dhcp</pre>

4.4.14Configuring DHCP Relay Link Selection

Configuration Effect

Run the **ip dhcp relay link-selection** command on an interface to cofigure an IP address for Link Selection in Relay packets.

Notes

- Basic DHCP Relay functions should be enabled.
- Only one source IP address can be specified for Relay packets.
- Before enabling this feature, you need to enable DHCP Option 82 and configure the source IP address of DHCP Relay packets first.

Configuration Steps

➤ **Configuring DHCP Relay Link Selection**

- By default, the primary IP address of the interface is used for DHCP Link Selection.
- Run the **ip dhcp relay link-selection ip-address** command to specify an IP address for Link Selection in Relay packets.

Verification

Configure an IP address for Link Selection after enabling DHCP Option 82 and configuring the source IP address of DHCP Relay packets. The Link Selection address in the Relay packets sent to the DHCP server is the configured IP address.

Related Commands

↘ Configuring DHCP Relay Link Selection

Command	ip dhcp relay link-selection <i>ip-address</i>
Parameter Description	<i>ip-address</i> : Specifies an IP address for Link Selection in Relay packets.
Command Mode	Interface configuration mode
Usage Guide	N/A

Configuration Example

↘ Configuring DHCP Relay Link Selection

Configuration Steps	1: Enable basic DHCP Relay functions. 2: Configure an IP address for DHCP Relay Link Selection on an interface.
	<pre>FS(config-if)# ip dhcp relay link-selection 1.1.1.1</pre>
Verification	1: Login the DHCP Relay Agent. 2: Enter the Privileged EXEC mode. 3: Run the show running-config command to display DHCP Relay configurations.

Common Errors

- Basic DHCP Relay functions are not configured.
- DHCP Option 82 is not enabled.
- The source IP address of DHCP Relay packets is not configured.

4.5 Monitoring

Clearing

 Running the clear commands may lose vital information and interrupt services.

Description	Command
Clears DHCP address binding.	clear ip dhcp binding { <i>address</i> * }
Clears DHCP address conflict.	clear ip dhcp conflict { <i>address</i> * }
Clears statistics of a DHCP server.	clear ip dhcp server statistics
Clears statistics of a DHCP relay.	clear ip dhcp relay statistics
Clears statistics of DHCP server performance.	clear ip dhcp server rate

Displaying

Description	Command
-------------	---------

Displays DHCP lease.	show dhcp lease
Displays DHCP sockets.	show ip dhcp socket
Displays assigned IP addresses.	show ip dhcp binding
Displays created address pools.	show ip dhcp pool
Displays statistics of DHCP Server.	show ip dhcp server statistic
Displays statistics of DHCP Relay.	show ip dhcp relay statistic
Displays conflicted addresses.	show ip dhcp conflict
Displays DHCP lease history.	show ip dhcp history

Debugging



System resources are occupied when debugging information is output. Therefore, disable debugging immediately after use.

Description	Command
Debugs DHCP agent.	debug ip dhcp server agent
Debugs DHCP hot backup.	debug ip dhcp server ha
Debugs DHCP address pools.	debug ip dhcp server pool
Debugs DHCP VRRP.	debug ip dhcp server vrrp
Debugs all DHCP servers.	debug ip dhcp server all
Debugs DHCP packets.	debug ip dhcp client
Debugs DHCP Relay events.	debug ip dhcp relay

5 Configuring DHCPv6

5.1 Overview

The Dynamic Host Configuration Protocol for IPv6 (DHCPv6) is a protocol that allows a DHCP server to transfer configurations (such as IPv6 addresses) to IPv6 nodes.

As compared with other IPv6 address allocation methods, such as manual configuration and stateless automatic address configuration, DHCPv6 provides the address allocation, prefix delegation, and configuration parameter allocation.

- DHCPv6 is a stateful protocol for automatically configuring addresses and flexibly adding and reusing network addresses, which can record allocated addresses and enhance network manageability.
- By using the prefix delegation of DHCPv6, uplink network devices can allocate address prefixes to downlink network devices, which implements flexible station-level automatic configuration and flexible control of station address space.
- The DHCPv6 configuration parameter allocation solves the problem that parameters cannot be obtained through a stateless automatic address configuration protocol and allocates DNS server addresses and domain names to hosts.

DHCPv6 is a protocol based on the client/server model. A DHCPv6 client is used to obtain various configurations whereas a DHCPv6 server is used to provide various configurations. If the DHCPv6 client and DHCPv6 server are not on the same network link, they can interact with each other by using a DHCPv6 relay agent.

The DHCPv6 client usually discovers the DHCPv6 server by reserving multicast addresses within a link; therefore, the DHCPv6 client and DHCPv6 server must be able to directly communicate with each other, that is, they must be deployed within the same link. This may cause management inconvenience, economic waste (a DHCPv6 server is deployed for each subnet) and upgrade inconvenience. The DHCPv6 relay agent function can solve these problems by enabling a DHCPv6 client to send packets to a DHCPv6 server on a

different link. The DHCP relay agent is often deployed within the link where a DHCPv6 client resides and is used to relay interaction packets between the DHCPv6 client and DHCPv6 server. The DHCP relay agent is transparent to the DHCPv6 client.

Figure 5- 1

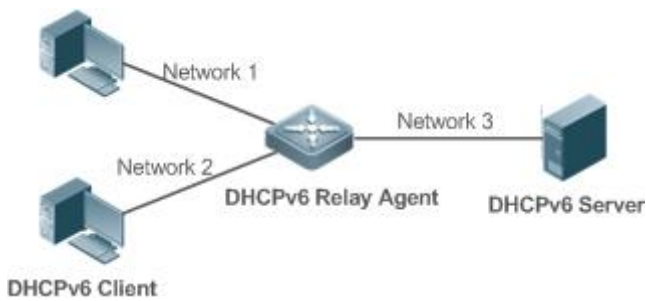

Protocols and Standards

- RFC3315: Dynamic Host Configuration Protocol for IPv6
- RFC3633: IPv6 Prefix Options for Dynamic Host Configuration Protocol (DHCP) Version 6
- RFC3646: DNS Configuration Options for Dynamic Host Configuration Protocol for IPv6 (DHCPv6)
- RFC3736: Stateless DHCP Service for IPv6
- RFC5417: Control And Provisioning of Wireless Access Points (CAPWAP) Access Controller DHCP Option

5.2 Applications

Application	Description
Requesting/Allocating Addresses and Configuration Parameters	A DHCPv6 client requests addresses from a DHCPv6 server. The DHCPv6 server allocates addresses and configuration parameters to the DHCPv6 client.
Requesting/Allocating Prefixes	The DHCPv6 client requests a prefix from the DHCPv6 server. The DHCPv6 server allocates a prefix to the DHCPv6 client and then the DHCPv6 client configures IPv6 addresses by using this prefix.
Relay Service	The DHCPv6 relay is used to enable communication between the DHCPv6 client and DHCPv6 server on different links.

5.2.1 Requesting/Allocating Addresses and Configuration Parameters

Scenario

In a subnet, a DHCPv6 client requests addresses from a DHCPv6 server. The DHCPv6 server allocates addresses and configuration parameters to the DHCPv6 client.

As shown in Figure 5- 2:

- The DHCPv6 server is configured with IPv6 addresses, DNS servers, domain names and other configuration parameters to be allocated.
- A host works as a DHCPv6 client to request an IPv6 address from the DHCPv6 server. After receiving the request, the DHCPv6 server selects an available address and allocates the address to the host.
- The host can also request a DNS server, domain name and other configuration parameters from the DHCPv6 server.

Figure 5-2

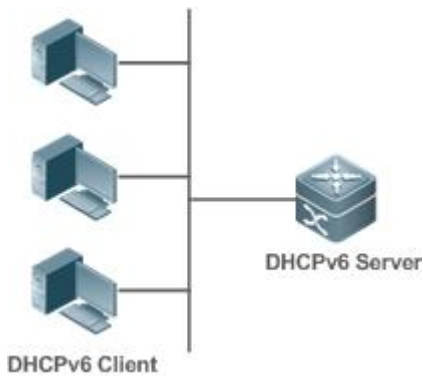

Deployment

- Run the DHCPv6 client on a host in the subnet to obtain an IPv6 address and other parameters.
- Run the DHCPv6 server on a device and configure the IPv6 address and other parameters to allocate the IPv6 address and parameters.

5.2.2 Requesting/Allocating Prefixes

Scenario

As shown in Figure 5-3, an uplink device (PE) allocates an IPv6 address prefix for a downlink device (CPE). The CPE generates a new address prefix for the internal subnet based on the obtained prefix. Hosts in the internal subnet of the CPE are configured with addresses through Router Advertisement (RA) by using the new address prefix.

- The PE provides the prefix delegation service as a DHCPv6 server.
- The CPE requests an address prefix from the PE as a DHCPv6 client. After obtaining the address prefix, the CPE generates a new address prefix for the internal subnet and sends an RA message to hosts in the internal subnet.
- The hosts in the internal subnet where CPE resides configure their addresses based on the RA message sent by the CPE.

Figure 5-3

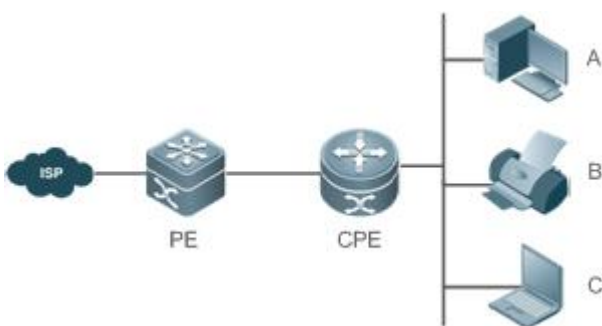

Remarks	<p>The Provider Edge (PE) works as a DHCPv6 server for providing prefixes and is also called a delegating router.</p> <p>The Customer Premises Equipment (CPE) works as a DHCPv6 client for requesting prefixes and is also called a requesting router.</p> <p>A, B and C are various hosts.</p>
----------------	--

Deployment

- Run the DHCPv6 server on the PE to implement the prefix delegation service.

- Run the DHCPv6 client on the CPE to obtain address prefixes.
- Deploy IPv6 ND between the CPE and the hosts to configure the host addresses in the subnet through RA.

5.2.3 Relay Service

Scenario

The DHCPv6 relay agent provides the relay service for the DHCPv6 client and DHCPv6 server on different links to enable communication between them.

As shown in Figure 5-4:

- Device 1 is enabled with the DHCPv6 relay agent and destined to 3001::2.
- Device 2 wants to forward packets to other servers through a next-level relay service. Enable the DHCPv6 relay agent on Device 2, set the destination address to FF02::1:2 (all servers and Relay multicast addresses) and specify the egress interface as the layer-3 interface gi 0/1.

Figure 5-4

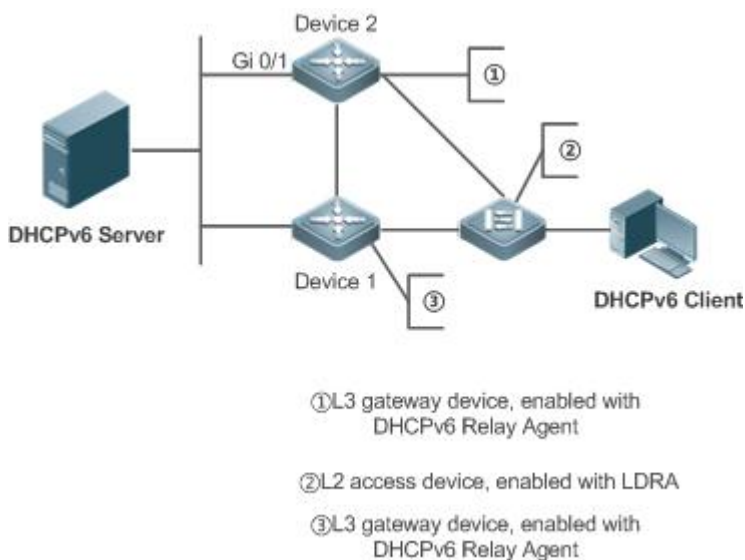

Deployment

- Enable the DHCPv6 relay agent on device 1 and specify the address as 3000::1.
- Enable the DHCPv6 relay agent on device 2 and specify the address as FF02::1:2.

5.3 Features

Basic Concept

↘ DUID

The DHCP Unique Identifier (DUID) identifies a DHCPv6 device. As defined in RFC3315, each DHCPv6 device (DHCPv6 client, relay or server) must have a DUID, which is used for mutual authentication during DHCPv6 message exchange.

RFC3315 defines three types of DUIDs:

- DUID Based on Link-Layer address plus Time (DUID-LLT).

- DUID Assigned by Vendor Based on Enterprise Number (DUID-EN).
- Link-Layer address (DUID-LL).

FS DHCPv6 devices use DUID-LLs. The structure of a DUID-LL is as follows:

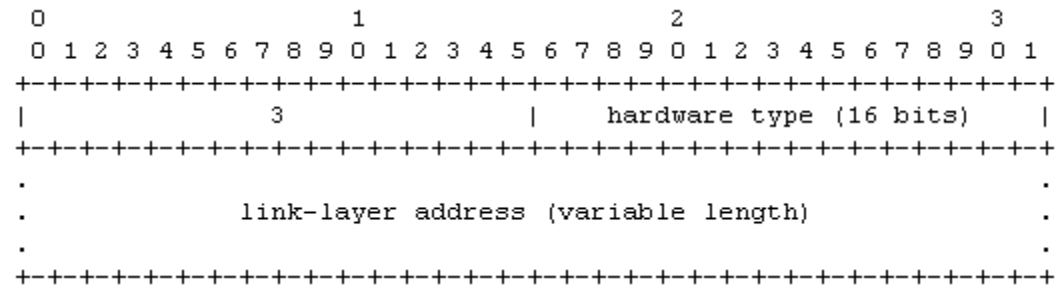

The values of *DUID-LL*, *Hardware type*, and *Link-layer address* are 0x0003, 0x0001 (indicating the Ethernet), and MAC address of a device respectively.

Identity Association (IA)

A DHCPv6 server allocates IAs to DHCPv6 clients. Each IA is uniquely identified by an identity association identifier (IAID). IAIDs are generated by DHCPv6 clients. A one-to-one mapping is established between IAs and clients. An IA may contain several addresses, which can be allocated by the client to other interfaces. An IA may contain one of the following types of addresses:

- Non-temporary Addresses (NAs), namely, globally unique addresses.
- Temporary Addresses (TAs), which are hardly used.
- Prefix Delegation (PD).

Based on the address type, IAs are classified into IA_NA, IA_TA, and IA_PD (three IA-Types). FS DHCPv6 servers support only IA_NA and IA_PD.

Binding

A DHCPv6 binding is a manageable address information structure. The address binding data on a DHCPv6 server records the IA and other configurations of every client. A client can request multiple bindings. The address binding data on a server is present in the form of an address binding table with DUID, IA-Type and IAID as the indexes. A binding containing configurations uses DUID as the index.

DHCPv6 Conflict

When an address allocated by a DHCPv6 client is in conflict, the client sends a Decline packet to notify the DHCPv6 server that the address is rebound. Then, the server adds the address to the address conflict queue. The server will not allocate the addresses in the address conflict queue. The server supports viewing and clearing of address information in the address conflict queue.

Packet Type

RFC3315 stipulates that DHCPv6 uses UDP ports 546 and 547 for packet exchange. Specifically, a DHCPv6 client uses port 546 for receiving packets, while a DHCPv6 server and DHCPv6 relay agent use port 547 for receiving packets. RFC3315 defines the following types of packets that can be exchanged among the DHCPv6 server, client, and relay agent:

- Packets that may be sent by a DHCPv6 client to a DHCPv6 server include Solicit, Request, Confirm, Renew, Rebind, Release, Decline, and Information-request.
- Packets that may be sent by a DHCPv6 server to a DHCPv6 client include Advertise, Reply, and Reconfigure.
- Packets that may be sent by a DHCPv6 relay agent to another DHCPv6 relay agent or a DHCPv6 server include Relay-forward.

- Packets that may be sent by a DHCPv6 relay agent to another DHCPv6 relay agent or a DHCPv6 server include Relay-reply.

FS DHCPv6 servers do not support the Reconfigure packet.

FS DHCPv6 clients do not support the Confirm and Reconfigure packets.

Overview

Feature	Description
Requesting/Allocating Addresses	Dynamically obtains/allocates IPv6 addresses in a network in the client/server mode.
Requesting/Allocating Prefixes	Dynamically obtains/allocates IPv6 prefixes in a network in the client/server mode.
Stateless Service	Provides stateless configuration service for hosts in a network.
Relay Service	Provides the DHCPv6 server service for hosts in different networks by using the relay service.

5.3.1 Requesting/Allocating Addresses

A DHCPv6 client can request IPv6 addresses from a DHCPv6 server.

After being configured with available addresses, a DHCPv6 server can provide IPv6 addresses to hosts in the network, record the allocated addresses and improve the network manageability.

Working Principle

Network hosts serve as DHCPv6 clients and DHCPv6 servers to implement address allocation, update, confirmation, release and other operations through message exchange.

Four-Message Exchange

Figure 5-5 shows the four-message exchange process.

Figure 5- 5

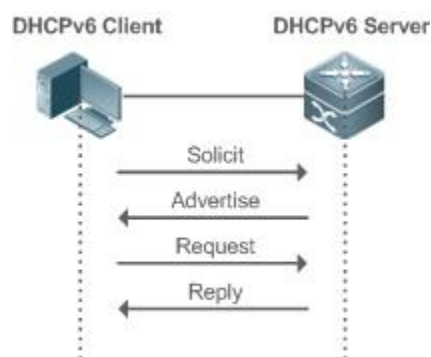

- A DHCPv6 client sends a Solicit message whose destination address is FF02::1:2 and destination port number is 547 within the local link to request address, prefix and configuration parameter allocation. All DHCPv6 servers or DHCPv6 relay agents within the link will receive the Solicit message.
- After receiving the Solicit message, a DHCPv6 server will send an Advertise message in the unicast mode if it can provide the information requested in the Solicit message. The Advertise message includes the address, prefix and configuration parameters.
- The DHCPv6 client may receive the Advertise message from multiple DHCPv6 servers. After selecting the most suitable DHCPv6 server, the DHCPv6 client sends a Request message whose destination address is FF02::1:2 and destination port number is 547 to request address, prefix and configuration parameter allocation.

- After receiving the Request message, the DHCPv6 server creates a binding locally and sends a Reply message in the unicast mode. The Reply message includes the address, prefix and configuration parameters that the DHCPv6 server will allocate to the DHCPv6 client. The DHCPv6 client obtains address, prefix or configuration parameters based on the information in the Reply message.

➤ **Two-Message Exchange**

Two-message exchange can be used to complete address, prefix and parameter configuration for DHCPv6 clients more quickly.

Figure 5-6

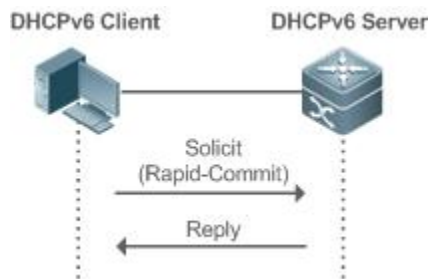

- A DHCPv6 client sends a Solicit message whose destination address is FF02::1:2 and destination port number is 547 within the local link to request address, prefix and configuration parameter allocation. The Solicit message contains Rapid Commit.
- If a DHCPv6 server supports the Rapid Commit option, the DHCPv6 server creates a binding locally and sends a Reply message in the unicast mode. The Reply message includes the address, prefix and configuration parameters to be allocated to the DHCPv6 client. The DHCPv6 client completes configuration based on the information in the Reply message.

➤ **Update and Rebinding**

The DHCPv6 server provides the control address and the updated T1 and T2 in the IA of the message sent to the DHCPv6 client.

Figure 5-7

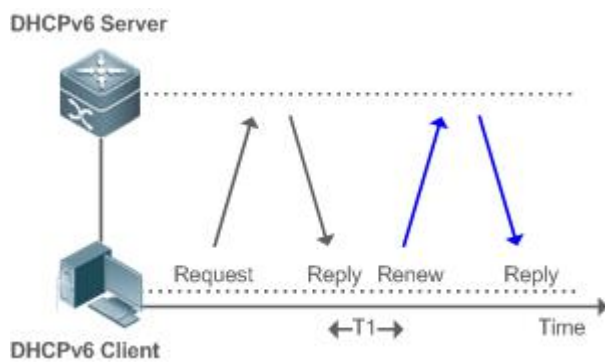

- The DHCPv6 client will send a Renew multicast message to the DHCPv6 server for updating the address and prefix after T1 seconds. The Renew message contains the DUID of the DHCPv6 server and the IA information to be updated.
- After receiving the Renew message, the DHCPv6 server checks whether the DUID value in the Renew message is equal to the DUID value of the local device. If yes, the DHCPv6 server updates the local binding and sends a Reply message in the unicast mode. The Reply message contains the new T1 and other parameter s.

Figure 5-8

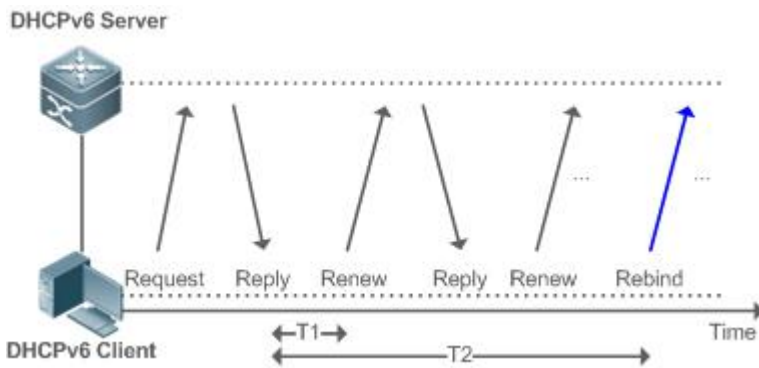

- If no response is received after the DHCPv6 client sends a Renew message to the DHCPv6 server, the DHCPv6 client will send a Rebind multicast message to the DHCPv6 server for rebinding the address and prefix after T2 expires.
- After receiving the Rebind message, the DHCPv6 server (perhaps a new DHCPv6 server) sends a Reply message according to the content of the Rebind message.

➤ **Release**

If a DHCPv6 client needs to release an address or a prefix, the DHCPv6 client needs to send a Release message to a DHCPv6 server to notify the DHCPv6 server of the released addresses or prefixes. In this way, the DHCPv6 server can allocate these addresses and prefixes to other DHCPv6 clients.

Figure 5-9

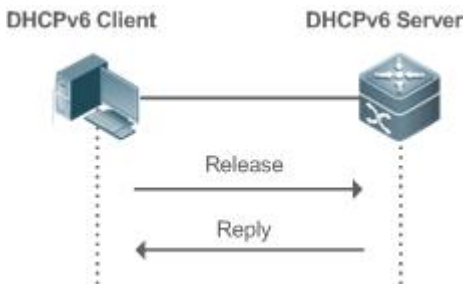

- After receiving the Release message, the DHCPv6 server removes the corresponding bindings based on the addresses or prefixes in the Release message, and sends a Reply message carrying the state option to the DHCPv6 client.

➤ **Confirmation**

After moving to a new link (for example, after restart), a DHCPv6 client will send a Confirm message to the DHCPv6 server on the new link to check whether the original addresses are still available.

Figure 5-10

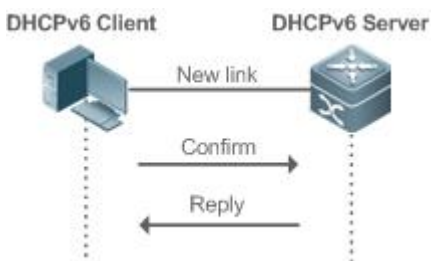

- After receiving the Confirm message, the DHCPv6 server performs confirmation based on the address information in the Confirm message, and sends a Reply message carrying the state option to the DHCPv6 client. If the confirmation fails, the DHCPv6 client may initiate a new address allocation request.

➤ DHCPv6 Conflict

If the DHCPv6 client finds that the allocated addresses have been used on the link after address allocation is completed, the DHCPv6 client sends a Decline message to notify the DHCPv6 server of the address conflict.

Figure 5- 11

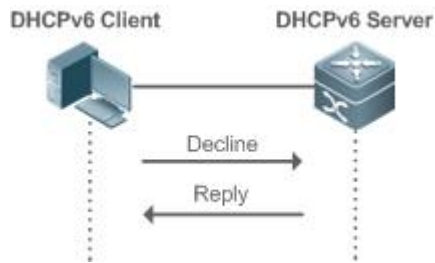

- The DHCPv6 client includes the IA information of the conflicted addresses in the Decline message.
- After receiving the Decline message, the DHCPv6 server marks the addresses in the Decline message as "declined" and will not allocate these addresses. Then, the DHCPv6 server sends a Reply message carrying the state option to the DHCPv6 client. You can manually clear addresses marked as "declined" to facilitate re-allocation.

Related Configuration

➤ Enabling the DHCPv6 Server Function on an Interface

- By default, an interface is not enabled with the DHCPv6 server function.
- You can run the **ipv6 dhcp server** command to enable the DHCPv6 server function for the interface.

 The DHCPv6 server function must be enabled on a layer-3 interface.

➤ Allocating Addresses Through the DHCPv6 Server

- By default, the DHCPv6 server has no configuration pool and is not configured with addresses to be allocated.
- You can run the **ipv6 dhcp pool** command to create a configuration pool.
- You can run the **iana-address** command to configure addresses to be allocated and the **preferred lifetime** and **valid lifetime** values.

➤ Clearing Conflicted Addresses Through the DHCPv6 Server

- By default, the DHCPv6 server does not clear conflicted addresses that are detected.
- You can run the **clear ipv6 dhcp conflict** command to clear conflicted addresses so that these addresses can be reused.

➤ Enabling the DHCPv6 Client Address Request Function on an Interface

- By default, an interface is not enabled with the DHCPv6 client address request function.
- You can run the **ipv6 dhcp client ia** command to enable the DHCPv6 client address request function for the interface.

 The DHCPv6 client address request function is effective only on a layer-3 interface.

5.3.2 Requesting/Allocating Prefixes

Configure available prefixes on the DHCPv6 server. By using the prefix delegation of DHCPv6, uplink network devices can allocate address prefixes to downlink network devices, which implements flexible station-level automatic configuration and flexible control of station address space.

Working Principle

Downlink network devices serve as DHCPv6 clients to exchange messages with the DHCPv6 server to implement address allocation, update, release and other operations. Downlink network devices obtain, update, rebind and release prefixes by using the four-/two-message exchange mechanism similar to that for allocating addresses. However, prefix allocation is different from address allocation in the following aspects:

- In message exchange using the prefix delegation, the Confirm and Decline messages are not used.
- If a DHCPv6 client moves to a new link and needs to check whether the prefix information is available, it performs confirmation through Rebind and Reply message exchange.
- The IA type in various messages is IA_PD.
-  For the message exchange using the prefix delegation, refer to the section "Requesting/Allocating Addresses".

Related Configuration

▾ Enabling the DHCPv6 Server Function on an Interface

- By default, an interface is not enabled with the DHCPv6 server function.
- You can run the **ipv6 dhcp server** command to enable the DHCPv6 server function for the interface.

 The DHCPv6 server function is effective only on a layer-3 interface.

▾ Prefix Delegation of the DHCPv6 Server

- By default, the DHCPv6 server has no configuration pool and is not configured with prefixes.
- You can run the **ipv6 dhcp pool** command to create a configuration pool.
- You can run the **prefix-delegation** command to allocate specified prefixes to a specific DHCPv6 client.
- You can run the **prefix-delegation pool** command to configure a prefix pool so that all prefixes requested by the DHCPv6 client are allocated from this pool.

▾ Enabling the DHCPv6 Client Prefix Request Function on an Interface

- By default, an interface is not enabled with the DHCPv6 client prefix request function.
- You can run the **ipv6 dhcp client pd** command to enable or disable the DHCPv6 client prefix request function for the interface.
- The DHCPv6 client prefix request function is effective only on a layer-3 interface.

5.3.3 Stateless Service

When a DHCPv6 client needs only configuration parameters, the DHCPv6 stateless service can be used to obtain related configuration parameters which cannot be obtained through a stateless automatic address configuration protocol, such as the DNS server address.

Working Principle

Network hosts serve as DHCPv6 clients to exchange messages with the DHCPv6 server to obtain and update configuration parameters.

Message Exchange Using the Stateless Service

Figure 5- 12

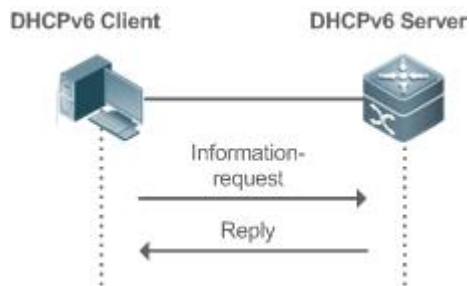

- A DHCPv6 client sends an Information-request message to a DHCPv6 server to request stateless messages. Usually, this message does not contain the DUID of the specified DHCPv6 server.
- The DHCPv6 server sends a Reply message containing the configuration parameters to the DHCPv6 client.

Related Configuration

Enabling the DHCPv6 Server Function on an Interface

- By default, an interface is not enabled with the DHCPv6 server function.
- You can run the **ipv6 dhcp server** command to enable or disable the DHCPv6 server function for the interface.

 The DHCPv6 server function is effective only on a layer-3 interface.

Stateless Service of a DHCPv6 Server

- By default, the DHCPv6 server has no configuration pool and is not configured with configuration parameters.
- You can run the **ipv6 dhcp pool** command to create a configuration pool.
- You can run the **dns-server** command to add a DNS server.
- You can run the **domain-name** command to add a domain name.
- You can run the **option52** command to add the IPv6 address of the CAPWAP AC.
- You can run the **bootfile-url** command to configure the BOOT file URL.

5.3.4 Relay Service

When the DHCPv6 client and DHCPv6 server are on different links, the DHCPv6 client can relay related messages to the DHCPv6 server through the DHCPv6 relay agent. The DHCPv6 server also relays the response to the DHCPv6 client through the relay agent.

Working Principle

When receiving a message from the DHCPv6 client, the DHCPv6 relay agent creates a Relay-forward message. This message contains the original message from the DHCPv6 client and some options added by the relay agent. Then, the relay agent sends the Relay-forward message to a specified DHCPv6 server or a specified multicast address FF05::1:3.

After receiving the Relay-forward message, the DHCPv6 server extracts the original message from the DHCPv6 client for processing. Then, the DHCPv6 server constructs a response to the original message, encapsulates the response in a Relay-reply message, and then sends the Relay-reply message to the DHCPv6 relay agent.

After receiving the Relay-reply message, the DHCPv6 relay agent extracts the original message from the DHCPv6 server for processing, and forwards the message to the DHCPv6 client.

Multi-level relay agents are allowed between the DHCPv6 client and DHCPv6 server.

➤ **DHCPv6 Relay Agent**

Figure 5- 13

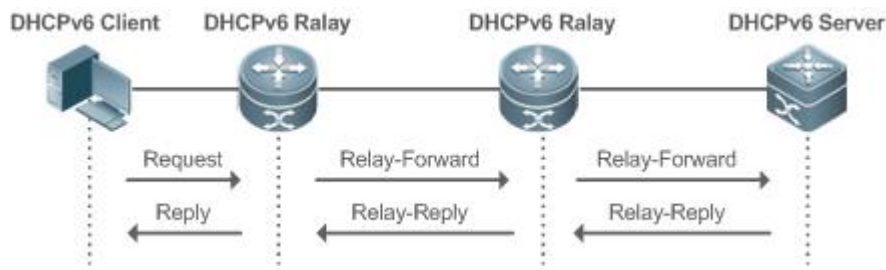

- The DHCPv6 relay agent performs message encapsulation and decapsulation between the DHCPv6 client and DHCPv6 server to enable communication between the DHCPv6 client and DHCPv6 server on different links.

5.3.5 Specifying the Source Interface of DHCPv6 Relay-Forward Packets

The DHCPv6 server may fail, based on the IP address of the uplink port, to identify a particular DHCPv6 relay agent. To solve this problem, you can specify the source interface of DHCPv6 relayed packets to ensure normal forwarding of packets.

Working Principle

By specifying the source interface, when DHCPv6 relay packets are forwarded to the DHCPv6 server, the source IP address of those packets are modified while the IP address of the DHCPv6 server remains to be their destination address. After receiving the packets with the specified source address, the DHCPv6 server records this address and uses it as the destination address of the reply packets. In this way, the DHCPv6 server can clearly identify DHCPv6 relay agents.

Related Configuration

➤ **Specifying the Source Interface of DHCPv6 Relay-Forward Packets in Global or Interface Configuration Mode**

- By default, no source interface is specified.
- Run the **ipv6 dhcp relay source** command to configure or remove a specified source interface.
- Run the **show ipv6 dhcp relay source** command to display the specified source interface and its configuration information.

⚠ In interface configuration mode, only a L3 interface can be configured as the source interface.

5.4 Configuration

Configuration	Description and Command
Configuring the DHCPv6 Server	⚠ (Mandatory) It is used to create a configuration pool.

Configuration	Description and Command	
Configuring the DHCPv6 Server	ipv6 dhcp pool	Configures a configuration pool for a DHCPv6 server.
	(Optional) It is used to allocate addresses.	
	iana-address prefix	Configures the address prefixes to be allocated on the DHCPv6 server.
	(Optional) It is used to allocate prefixes.	
	prefix-delegation	Configures prefixes of statically bound addresses on the DHCPv6 server.
	prefix-delegation pool	Configures the DHCPv6 server to allocate prefixes from a local prefix pool.
	ipv6 local pool	Configures a local IPv6 prefix pool.
	(Optional) It is used to allocate configuration parameters.	
	dns-server	Configures the DNS server on the DHCPv6 server.
	domain-name	Configures the domain name of the DHCPv6 server.
	option52	Configures the IPv6 address of the CAPWAP AC on the DHCPv6 server.
	bootfile-url	Configures the BOOT file URL of the DHCPv6 server.
	(Mandatory) It is used to enable the DHCPv6 server service.	
	ipv6 dhcp server	Enables the DHCPv6 server service on an interface.
Configuring the DHCPv6 Relay	(Mandatory) It is used to enable the DHCPv6 relay agent service.	
	ipv6 dhcp relay destination	Configures the DHCPv6 relay agent function.
	ipv6 dhcp relay source	Configures the source interface of DHCPv6 Relay-Forward packets.
Configuring the DHCPv6 Client	(Mandatory) It is used to request addresses or prefixes.	
	ipv6 dhcp client ia	Enables the DHCPv6 client and requests IANA addresses.
	ipv6 dhcp client pd	Enables the DHCPv6 client and requests address prefixes.

5.4.1 Configuring the DHCPv6 Server

Configuration Effect

- An uplink device can automatically allocate DHCPv6 addresses, prefixes and configuration parameters to a downlink device.

Notes

- To provide the DHCPv6 server service, you must specify a DHCPv6 server configuration pool.
- The name of the configuration pool cannot be too long.
- When enabling the DHCPv6 server service, you must specify a configuration pool.
- Only the Switch Virtual Interface (SVI), routed port and L3 aggregate port (AP) support this configuration.

Configuration Steps

↘ **Configuring a DHCPv6 Server Configuration Pool**

- Mandatory.
- Unless otherwise specified, you should configure a DHCPv6 server configuration pool on all devices that need to provide the DHCPv6 server service.

↘ **Configuring the Address Prefixes to Be Allocated on the DHCPv6 Server**

- Optional.
- To provide the address allocation service, you should configure address prefixes to be allocated on all devices that need to provide the DHCPv6 server service.

↘ **Configuring Prefixes of Static Addresses on the DHCPv6 Server**

- Optional.
- To provide the prefix delegation service for statically bound addresses, you should configure prefixes of statically bound addresses on all devices that need to provide the DHCPv6 server service.

↘ **Configuring the DHCPv6 Server to Allocate Prefixes from a Local Prefix Pool**

- Optional.
- To provide the prefix delegation service, you should specify a local prefix pool on all devices that need to provide the DHCPv6 server service.

↘ **Configuring a Local IPv6 Prefix Pool**

- Optional.
- To provide the prefix delegation service through a prefix pool, you should specify a local prefix pool on all devices that need to provide the DHCPv6 server service.

↘ **Configuring the DNS Server on the DHCPv6 Server**

- Optional.
- To allocate DNS servers, you should configure the DNS server on all devices that need to provide the DHCPv6 server service.

↘ **Configuring Domain Names on the DHCPv6 Server**

- Optional.
- To allocate domain names, you should configure domain names on all devices that need to provide the DHCPv6 server service.

↘ **Configuring the IPv6 Address of the CAPWAP AC on the DHCPv6 Server**

- Optional.
- To allocate CAPWAP AC information, you should configure the IPv6 address of the CAPWAP AC on all devices that need to provide the DHCPv6 server service.

↘ **Configuring the BOOT File URL of the DHCPv6 Server**

- Optional.

- To provide the URL of the BOOT file, you should specify a BOOT file URL on all devices that need to provide the DHCPv6 server service.

▾ Enabling the DHCPv6 Server Service

- Mandatory.
- Unless otherwise specified, you should enable the DHCPv6 server service on specific interfaces of all devices that need to provide the DHCPv6 server service.

Verification

The DHCPv6 server allocates addresses, prefixes or configuration parameters for the DHCPv6 client.

- The DHCPv6 client obtains the required information.
- The DHCPv6 server successfully creates a local binding.

Related Commands

▾ Configuring a DHCPv6 Server Configuration Pool

Command	ipv6 dhcp pool <i>poolname</i>
Parameter Description	poolname: Indicates the name of a user-defined DHCPv6 configuration pool.
Command Mode	Global configuration mode
Usage Guide	Run the ipv6 dhcp pool command to create a DHCPv6 server configuration pool. After configuring this command, you may enter the DHCPv6 pool configuration mode, in which you can configure the pool parameters such as the prefix and DNS server. After creating a DHCPv6 server configuration pool, you can run the ipv6 dhcp server command to associate the configuration pool with the DHCPv6 server service on an interface.

▾ Configuring the IA_NA Address Prefix for the DHCPv6 Server

Command	iana-address prefix <i>ipv6-prefix/prefix-length</i> [lifetime { <i>valid-lifetime</i> <i>preferred-lifetime</i> }]
Parameter Description	ipv6-prefix/prefix-length: Indicates an IPv6 address prefix and the prefix length. lifetime: Sets the valid time of the address allocated to a client. This keyword must be configured together with <i>valid-lifetime</i> and <i>preferred-lifetime</i> . valid-lifetime: Indicates the valid time of the address allocated to a client. preferred-lifetime: Indicates the time when an address is preferentially allocated to a client.
Command Mode	Interface configuration mode
Usage Guide	Run the iana-address prefix command to configure IA_NA address prefixes for a DHCPv6 server, some of which are allocated to the client. When receiving an IA_NA address request from a client, the DHCPv6 server selects an available address according to the IA_NA address range and allocates the address to the client. When the client does not use this address, the DHCPv6 server marks this address as available for another client.

▾ Configuring Prefixes of Statically Bound Addresses on the DHCPv6 Server

Command	prefix-delegation <i>ipv6-prefix/prefix-length client-DUID</i> [<i>lifetime</i>]
Parameter	<i>ipv6-prefix/prefix-length</i> : Indicates an IPv6 address prefix and the prefix length.
Description	<i>client-DUID</i> : Indicates the DUID of a client. <i>lifetime</i> : Sets the time when the client can use this prefix.
Command Mode	DHCPv6 pool configuration mode
Usage Guide	<p>You can run the prefix-delegation command to manually configure a prefix list for an IA_PD of a client and specify the valid time of these prefixes.</p> <p>Use the <i>client-DUID</i> parameter to specify the client to which the address prefix is allocated. The address prefix will be allocated to the first IA_PD of the client.</p> <p>After receiving a request for the address prefix from the client, the DHCPv6 server checks whether a static binding is available. If yes, the DHCPv6 server directly returns the static binding. If not, the DHCPv6 server allocates the address prefix from another prefix source.</p>

↘ Configuring the DHCPv6 Server to Allocate Prefixes from a local prefix pool

Command	prefix-delegation pool <i>poolname</i> [lifetime { <i>valid-lifetime</i> <i>preferred-lifetime</i> }]
Parameter	poolname : Indicates the name of a user-defined local prefix pool.
Description	lifetime : Sets the valid time of the prefix allocated to a client. This keyword must be configured together with <i>valid-lifetime</i> and <i>preferred-lifetime</i> . <i>valid-lifetime</i> : Indicates the valid time of the prefix allocated to the client. <i>preferred-lifetime</i> : Indicates the time when a prefix is preferentially allocated to a client.
Command Mode	DHCPv6 pool configuration mode
Usage Guide	<p>Run the prefix-delegation pool command to configure a prefix pool for a DHCPv6 server to allocate prefixes to clients. The ipv6 local pool command is used to configure a prefix pool.</p> <p>When receiving a prefix request from a client, the DHCPv6 server selects an available prefix from the prefix pool and allocates the prefix to the client. When the client does not use this prefix, the DHCPv6 server retrieves the prefix .</p>

↘ Configuring a Local IPv6 Prefix Pool

Command	ipv6 local pool <i>poolname prefix/prefix-length assigned-length</i>
Parameter	<i>poolname</i> : Indicates the name of a local prefix pool.
Description	<i>prefix/prefix-length</i> : Indicates the prefix and prefix length. <i>assigned-length</i> : Indicates the length of the prefix allocated to a user.
Command Mode	Global configuration mode
Usage Guide	Run the ipv6 local pool command to create a local prefix pool. If the DHCPv6 server needs prefix delegation, you can run the prefix-delegation pool command to specify a local prefix pool. Afterwards, prefixes will be allocated from the specified local prefix pool.

↘ Configuring the DNS Server on the DHCPv6 Server

Command	dns-server <i>ipv6-address</i>
Parameter	<i>ipv6-address</i> : Indicates the IPv6 address of the DNS server.
Description	
Command Mode	DHCPv6 pool configuration mode

Mode	
Usage Guide	You can run the dns-server command for multiple times to configure multiple DNS server addresses. A new DNS server address will not overwrite old DNS server addresses.

↘ Configuring Domain Names on the DHCPv6 Server

Command	domain-name <i>domain</i>
Parameter	<i>domain</i> : Defines a domain name to be allocated to a user.
Description	
Command	DHCPv6 pool configuration mode
Mode	
Usage Guide	You can run the domain-name command for multiple times to create multiple domain names. A new domain name will not overwrite old domain names.

↘ Configuring the option52 on the DHCPv6 Server

Command	option52 <i>ipv6-address</i>
Parameter	<i>ipv6-address</i> : Specifies the IPv6 address of the CAPWAP AC.
Description	
Command	DHCPv6 pool configuration mode
Mode	
Usage Guide	You can run the option52 command to configure IPv6 addresses for the multiple CAPWAP ACs. A new CAPWAP AC IPv6 address will not overwrite old IPv6 addresses.

↘ Configuring the BOOT File URL

Command	bootfile-url <i>url-string</i>
Parameter	<i>url-string</i> : Specifies the URL of the BOOT file.
Description	
Command	DHCPv6 address pool configuration mode
Mode	
Usage Guide	Only the latest configured BOOT file URL is valid. New BOOT file URL overlays the old one.

↘ Enabling the DHCPv6 Server Service

Command	ipv6 dhcp server <i>poolname</i> [rapid-commit] [preference <i>value</i>]
Parameter	<i>poolname</i> : Indicates the name of a user-defined DHCPv6 configuration pool.
Description	rapid-commit : Permits the two-message exchange process. preference value : Configures the priority of the advertise message, ranging from 0 to 255. The default value is 0.
Command	Interface configuration mode
Mode	
Usage Guide	Run the ipv6 dhcp server command to enable the DHCPv6 service on an interface. When the rapid-commit keyword is configured, the two-message exchange with a client is permitted during allocation of address prefixes and other configurations. After this keyword is configured, if the Solicit message from a client contains the rapid-commit option, the DHCPv6 server will send a Reply message directly. If preference is set to a non-0 value, the advertise message sent by the DHCPv6 server contains the preference option. The preference field affects the server selection by a client. If an advertise message does not contain this

	<p>field, the value of preference is considered 0. If the value of preference received by the client is 255, the client sends a request to the server immediately to obtain configurations.</p> <p>The DHCPv6 client, server, and relay functions are mutually exclusive. An interface can be configured with only one function at a time.</p>
--	---

Configuration Example

Configuring the DHCPv6 Server

Configuration Steps	<ul style="list-style-type: none"> ● Configure a configuration pool named "pool1". ● Configure the IA_NA address prefix for the DHCPv6 server. ● Configure prefixes of statically bound addresses on the DHCPv6 server. ● Configure two DNS servers. ● Configure the domain name. ● Enable the DHCPv6 server service on an interface.
	<pre> FS# configure terminal FS(config)# ipv6 dhcp pool pool1 FS(config-dhcp)# iana-address prefix 2008:50::/64 lifetime 2000 1000 FS(config-dhcp)# prefix-delegation 2008:2::/64 0003000100d0f82233ac FS(config-dhcp)# dns-server 2008:1::1 FS(config-dhcp)# dns-server 2008:1::2 FS(config-dhcp)# domain-name example.com FS(config-dhcp)# exit FS(config)# interface GigabitEthernet 0/1 FS(config-if)# ipv6 dhcp server pool1 </pre>
Verification	<ul style="list-style-type: none"> ● Run the show ipv6 dhcp pool command to display the created configuration pool.
	<pre> FS# show ipv6 dhcp pool DHCPv6 pool: pool1 Static bindings: Binding for client 0003000100d0f82233ac IA PD prefix: 2008:2::/64 preferred lifetime 3600, valid lifetime 3600 IANA address range: 2008:50::1/64 -> 2008:50::ffff:ffff:ffff:ffff/64 preferred lifetime 1000, valid lifetime 2000 DNS server: 2008:1::1 DNS server: 2008:1::2 Domain name: example.com </pre>

Common Errors

- The specified pool name is too long.
- The number of the configuration pools exceeds the system limit (256).
- The configuration is performed on other interfaces than the Switch Virtual Interface (SVI), routed port and L3 AP port.
- The number of interfaces configured with the DHCPv6 server service exceeds the system limit (256).
- The specified value of **valid lifetime** is smaller than that of **preferred lifetime**.
- An invalid IA_NA address is specified.
- The number of address ranges exceeds the system limit (20).
- When prefixes of statically bound addresses are configured, the specified DUIDs are too long.
- The number of prefixes of statically bound addresses exceeds the system limit (1024).
- When a local prefix pool is configured, the specified value of **valid lifetime** is larger than that of **preferred lifetime**.
- The number of DNS servers exceeds the system limit (10).
- The number of domain names exceeds the system limit (10).
- The number of option52 addresses exceeds the system limit (10).

5.4.2 Configuring the DHCPv6 Relay

Configuration Effect

- A DHCPv6 relay agent can be configured for address allocation, prefix delegation and parameter allocation to enable communication between the DHCPv6 client and server on different links.

Notes

- A destination address must be specified. If the destination address is a multicast address (such as FF05::1:3), you also need to specify an egress interface.

Configuration Steps

📌 Configuring the DHCPv6 Relay Agent Function

- Mandatory.
- Unless otherwise specified, you should configure the DHCPv6 relay agent function on all devices that need to provide the DHCPv6 relay agent service.

Verification

The DHCPv6 client and DHCPv6 server exchange messages through the relay agent.

- Check whether the interface is enabled with the DHCPv6 relay.
- Check whether the DHCPv6 relay agent can receive and send messages.

Related Commands

📌 Configuring the DHCPv6 Relay Agent Function

Command	ipv6 dhcp relay destination <i>ipv6-address</i> [<i>interface-type interface-number</i>]
Parameter	<i>ipv6-address</i> : Specifies the destination address of the relay agent.
Description	<i>interface-type</i> : Specifies the type of the destination interface (optional). <i>interface-number</i> : Specifies the destination interface number (optional).
Command Mode	Interface configuration mode
Usage Guide	All DHCPv6 packets from clients received by an interface enabled with the DHCPv6 relay function will be encapsulated and sent to a specified destination address (or multiple destination addresses) through a specified interface (optional).

Configuration Example

📌 **Configuring the DHCPv6 Relay**

Configuration Steps	Specify an interface enabled with the relay service to forward received DHCPv6 client packets to a specified destination address through the specified interface (optional).
	<pre>FS#configure terminal Enter configuration commands, one per line. End with CNTL/Z. FS(config)#interface vlan 1 FS(config-if)#ipv6 dhcp relay destination 3001::2 FS(config-if)#ipv6 dhcp relay destination ff02::1:2 vlan 2</pre>
Verification	Run the show ipv6 dhcp relay destination all command to display the configured destination addresses.
	<pre>Interface:VLAN 1 Destination address(es) Output Interface 3001::2 ff02::1:2 VLAN 2</pre>

Common Errors

- The configuration is performed on other interfaces than the Switch Virtual Interface (SVI), routed port and L3 AP port.

5.4.3 Configuring the DHCPv6 Client

Configuration Effect

- Enable a device to automatically request IPv6 addresses or related parameters from a server.

Notes

- The configuration must be performed on layer-3 interfaces.

Configuration Steps

📌 **Enabling the DHCPv6 Client and Requesting IANA Addresses**

- Mandatory.

- Unless otherwise specified, you should enable the DHCPv6 client address request function on all devices that need to request addresses.

➤ **Enabling the DHCPv6 Client and Requesting Address Prefixes**

- Mandatory.
- Unless otherwise specified, you should enable the DHCPv6 client prefix request function on all devices that need to request prefixes.

➤ **Enabling the Stateless Service of the DHCPv6 Client**

- It is mandatory if the DHCPv6 client needs to obtain configuration parameters.

Verification

Check whether the interface is enabled with the DHCPv6 client and check the addresses, prefixes and other configuration obtained on the interface.

Related Commands

➤ **Enabling the DHCPv6 Address Request Function**

Command	ipv6 dhcp client ia [rapid-commit]
Parameter Description	rapid-commit: Permits the simplified message exchange process.
Command Mode	Interface configuration mode
Usage Guide	If the DHCPv6 client mode is not enabled, this command will enable the DHCPv6 client mode on the interface. After the ipv6 dhcp client ia command is configured, an IANA address request will be sent to the DHCPv6 server. The rapid-commit keyword permits the two-message exchange process between the client and server. If this keyword is configured, the Solicit message sent by the client contains the rapid-commit option.

➤ **Enabling the DHCPv6 Client Prefix Request**

Command	ipv6 dhcp client pd <i>prefix-name</i> [rapid-commit]
Parameter Description	<i>prefix-name:</i> Indicates an IPv6 general prefix. rapid-commit: Permits the simplified message exchange process.
Command Mode	Interface configuration mode
Usage Guide	If the DHCPv6 client mode is not enabled, this command will enable the DHCPv6 client mode on the interface. After the ipv6 dhcp client pd command is configured, a prefix request will be sent to the DHCPv6 server. After receiving the prefix, the client will save the prefix in the IPv6 general prefix pool. Then, other commands and applications can use this prefix. The rapid-commit keyword permits the two-message exchange process between the client and server. If this keyword is configured, the Solicit message sent by the client contains the rapid-commit option.

Configuration Example

➤ **Enabling the DHCPv6 Address Request Function**

Configuration	● Configure the DHCPv6 client address request function on an interface.
----------------------	---

Steps	<pre>FS(config)# interface GigabitEthernet 0/1 FS(config-if)# ipv6 dhcp client ia</pre>
Verification	<ul style="list-style-type: none"> Run the show ipv6 dhcp interface command to display whether the interface is enabled with the DHCPv6 client.
	<pre>FS#show ipv6 dhcp interface GigabitEthernet 0/1 GigabitEthernet 0/1 is in client mode Rapid-Commit: disable</pre>

↘ Enabling the DHCPv6 Client Prefix Request

Configuration Steps	<ul style="list-style-type: none"> Configure the DHCPv6 client prefix request function on an interface.
	<pre>FS(config)# interface GigabitEthernet 0/1 FS(config-if)# ipv6 dhcp client pd pd_name</pre>
Verification	<ul style="list-style-type: none"> Run the show ipv6 dhcp interface command to display whether the interface is enabled with the DHCPv6 client.
	<pre>FS#show ipv6 dhcp interface GigabitEthernet 0/1 GigabitEthernet 0/1 is in client mode Rapid-Commit: disable</pre>

Common Errors

- The DHCPv6 client address request is enabled on non-layer-3 interfaces.
- The DHCPv6 address request is enabled on interfaces enabled with the DHCPv6 relay or DHCPV6 server.
- The DHCPv6 client prefix request is enabled on non-layer-3 interfaces.
- The DHCPv6 prefix request is enabled on interfaces enabled with the DHCPv6 relay or DHCPV6 server.

5.4.4 Specifying the Source Interface of DHCPv6 Relay-Forward Packets

Configuration Effect

- Configure the source IP address of DHCPv6 Relay-Forward packets and add a padding to their link-address field.

Notes

- When specifying a local interface as the source interface, make sure the local interface is a L3 interface. If it becomes a non-L3 interface, it is not the source interface any more.

Configuration Steps

↘ Configuring the Source IP Address as the Source Interface

- Optional.
- If you just need to change the source IP address of DHCP Relay-Forward packets, you can set the source IP address as the source interface on an interface or globally.

➤ **Configuring the Gateway IP Address as the Source Interface**

- Optional.
- If you need to change the segment information DHCPv6 clients obtain, you can set the gateway IP address as the source interface on an interface or globally.

Verification

Check whether the related fields in the DHCPv6 Relay-Forward packets are specified:

- Capture packets to check if the parameters in corresponding fields are the same as they are specified.
- Check if DHCPv6 relay agent can send and receive packets normally.

Related Commands

➤ **Specifying the Source Interface of DHCPv6 Relay-Forward Packets**

Command	ipv6 dhcp relay source {source-ip-address gateway-address} {ipv6 address interface-type interface-number }
Parameter Description	<p>source-ip-address: Specifies the source IP address, and adds padding to the source IP field.</p> <p>gateway-address: Specifies the gateway address, and adds padding to the source IP and link address fields.</p> <p><i>ipv6-address:</i> Specifies the IPv6 address of the source interface.</p> <p><i>interface-type:</i> Specifies the interface type of the source interface.</p> <p><i>interface-number:</i> Specifies the number of the source interface.</p>
Command Mode	Interface/Global configuration mode
Usage Guide	<p>Enabling the functionality of specifying the source interface of DHCPv6 Relay-Forward packets changes the source IP address and link address fields of the DHCPv6 Relay-Forward packets. By specifying the source IP address, the source IP address of the DHCPv6 Relay-Forward packets is changed; by specifying the gateway address, the source IP address and the link address fields are changed.</p> <p>This command can be run in both global configuration mode and interface configuration mode with configurations in interface configuration mode takes higher priority. When in the same mode, new configurations override the old ones.</p>

Configuration Example

➤ **Specifying the Source Interface of DHCPv6 Relay-Forward Packets**

Configuration Steps	<ul style="list-style-type: none"> ● Specify, in interface VLAN 1, the source interface of DHCPv6 Relay-Forward packets by choosing the gateway IP address as the source interface and configuring an IPv6 address. ● Specify, globally, the source interface of DHCPv6 Relay-Forward packets by choosing the source IP address as the source interface and configuring a local interface as the source interface.
	<pre>FS# configure terminal Enter configuration commands, one per line. End with CNTL/Z.</pre>

<pre>FS(config)# interface vlan 1 FS(config-if)# ipv6 dhcp relay source gateway-address 1000::1 FS(config-if)# exit FS(config)# ipv6 dhcp relay source source-ip-address loopback 0 FS(config)#</pre>
<p>Verification</p> <ul style="list-style-type: none"> Run the show ipv6 dhcp relay source command to display the specified source interface and its configuration information.
<pre>FS#show ipv6 dhcp relay source Interface-Name Source-Intf-Type Source-Intf-Parameter Global Source Address Loopback 0 VLAN 1 Gateway Address 1000::1</pre>

Common Errors

- This feature is enabled on ports that are not SVIs, routed ports, or L3 interfaces.

5.5 Monitoring

Clearing

Running the **clear** commands may lose vital information and thus interrupt services.

Description	Command
Clears DHCPv6 bindings.	clear ipv6 dhcp binding [<i>ipv6-address</i>]
Clears DHCPv6 server statistics.	clear ipv6 dhcp server statistics
Clears conflicted addresses on the DHCPv6 server.	clear ipv6 dhcp conflict { <i>ipv6-address</i> * }
Clears the statistics on sent and received packets after the DHCPv6 relay is enabled on the current device.	clear ipv6 dhcp relay statistics
Restarts the DHCPv6 client.	clear ipv6 dhcp client <i>interface-type interface-number</i>

Displaying

Description	Command
Displays the DUID of a device.	show ipv6 dhcp
Displays address bindings on the DHCPv6 server.	show ipv6 dhcp binding [<i>ipv6-address</i>]
Displays DHCPv6 interface.	show ipv6 dhcp interface [<i>interface-name</i>]
Displays DHCPv6 pool.	show ipv6 dhcp pool [<i>poolname</i>]
Displays conflicted DHCPv6 addresses.	show ipv6 dhcp conflict
Displays the statistics on the DHCPv6 server.	show ipv6 dhcp server statistics
Displays the destination address of the	show ipv6 dhcp relay destination { all <i>interface-type interface-number</i> }

DHCPv6 relay agent.	
Displays the statistics on sent and received packets after the DHCPv6 relay is enabled on a device.	show ipv6 dhcp relay statistics
Displays the local IPv6 prefix pool.	show ipv6 local pool [<i>poolname</i>]
Displays the specified source interface and its configuraton information.	show ipv6 dhcp relay source

Debugging



System resources are occupied when debugging information is output. Therefore, disable debugging immediately after use.

Description	Command
Debugs DHCPv6.	debug ipv6 dhcp [detail]

6 Configuring DNS

6.1 Overview

A Domain Name System (DNS) is a distributed database containing mappings between domain names and IP addresses on the Internet, which facilitate users to access the Internet without remembering IP strings that can be directly accessed by computers. The process of obtaining an IP address through the corresponding host name is called domain name resolution (or host name resolution).

Protocols and Standards

- RFC1034: DOMAIN NAMES - CONCEPTS AND FACILITIES
- RFC1035: DOMAIN NAMES - IMPLEMENTATION AND SPECIFICATION

6.2 Applications

Application	Description
Static Domain Name Resolution	Performs domain name resolution directly based on the mapping between a domain name and an IP address on a device.
Dynamic Domain Name Resolution	Obtains the IP address mapped to a domain name dynamically from a DNS server on the network.

6.2.1 Static Domain Name Resolution

Scenario

- Preset the mapping between a domain name and an IP address on a device.
- When you perform domain name operations (such as Ping and Telnet) through application programs, the system can resolve the IP address without being connected to a server on the network.

Deployment

- Preset the mapping between a domain name and an IP address on a device.

6.2.2 Dynamic Domain Name Resolution

Scenario

- DNS Server is deployed on the network to provide the domain name service.
- Domain name "host.com" is deployed on the network.
- Device-A applies to DNS Server for domain name "host.com".

Figure 6- 1 Dynamic Domain Name Resolution

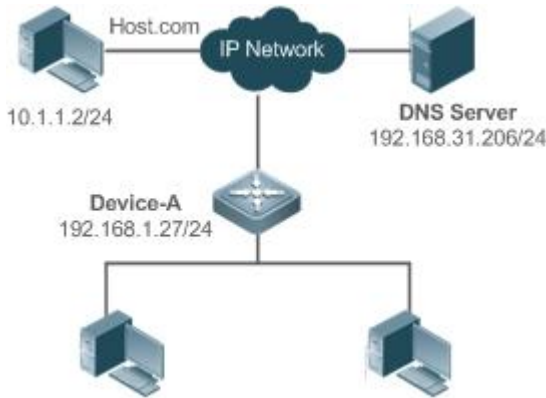

Deployment

- Deploy DNS Server as the DNS server of Device-A.

6.3 Features

Basic Concepts

📌 DNS

The DNS consists of a resolver and a DNS server. The DNS server stores the mappings between domain names and IP addresses of all hosts on the network, and implements mutual conversion between the domain names and IP addresses. Both the TCP and UDP port IDs of DNS are 53, and generally a UDP port is used.

Features

Feature	Description
Domain Name Resolution	IP addresses are obtained based on domain names from a DNS server or a local database.

6.3.1 Domain Name Resolution

Working Principle

📌 Static Domain Name Resolution

Static domain name resolution means that a user presets the mapping between a domain name and an IP address on a device. When you perform domain name operations (such as Ping and Telnet) through application programs, the system can resolve the IP address without being connected to a server on the network.

📌 Dynamic Domain Name Resolution

Dynamic domain name resolution means that when a user perform domain name operations through application programs, the DNS resolver of the system queries an external DNS server for the IP address mapped to the domain name.

The procedure of dynamic domain name resolution is as follows:

1. A user application program (such as Ping or Telnet) requests the IP address mapped to a domain name from the DNS resolver of the system.
2. The DNS resolver queries the dynamic cache at first. If the domain name on the dynamic cache does not expire, the DNS resolver returns the domain name to the application program.
3. If all domain names expire, the DNS resolver initiates a request for domain name-IP address conversion to the external DNS server.
4. After receiving a response from the DNS server, the DNS resolver caches and transfers the response to the application program.

Related Configuration

▾ **Enabling Domain Name Resolution**

- By default, domain name resolution is enabled.
- Run the **ip domain-lookup** command to enable or disable domain name resolution.

▾ **Configuring the IP Address Mapped to a Static Domain Name**

- By default, no mapping between a domain name and an IP address is configured.
- Run the **ip host** command to specify the IPv4 address mapped to a domain name.

▾ **Configuring a DNS Server**

- By default, no DNS server is configured.
- Run the **ip name-server** command to configure a DNS server.

6.4 Configuration

Configuration	Description and Command	
Configuring Static Domain Name Resolution	Optional.	
	ip domain-lookup [oob [via <i>mgmt-name</i>] vrf <i>vrf-name</i>]	Enables domain name resolution.
	ip host [oob [via <i>mgmt-name</i>] vrf <i>vrf-name</i>]	Configures the IPv4 address mapped to a domain name.
Configuring Dynamic Domain Name Resolution	Optional.	
	ip domain-lookup [oob [via <i>mgmt-name</i>] vrf <i>vrf-name</i>]	Enables domain name resolution.
	ip name-server [oob [via <i>mgmt-name</i>]]	Configures a DNS server.

6.4.1 Configuring Static Domain Name Resolution

Configuration Effect

The system resolver resolves the IP address mapped to a domain name on a local device.

Configuration Steps

➤ **Enabling Domain Name Resolution**

- The domain name resolution function is enabled by default.
- If this function is disabled, static domain name resolution does not take effect.

➤ **Configuring the IPv4 Address Mapped to a Domain Name**

- (Mandatory) Domain names to be used must be configured with mapped IP addresses.

Verification

- Run the **show run** command to check the configuration.
- Run the **show hosts [oob [via mgmt-name] | vrf vrf-name]** command to check the mapping between the domain name and the IP address.

Related Commands

➤ **Configuring the IPv4 Address Mapped to a Domain Name**

Command	ip host [oob vrf vrf-name] host-name ip-address [via mgmt-name]
Parameter Description	<p>vrf vrf-name: specifies the name of a VRF instance. If this parameter is not specified, it indicates the public network.</p> <p>oob: enables the out-of-band channel. It must be set when MGMT is specified as the source port.</p> <p>via: configures MGMT port.</p> <p><i>mgmt-name:</i> specifies the MGMT port in oob mode.</p> <p><i>host-name:</i> indicates a domain name.</p> <p><i>ip-address:</i> indicates a mapped IPv4 address.</p>
Command Mode	Global configuration mode
Usage Guide	N/A

Configuration Example

➤ **Configuring Static Domain Name Resolution**

Configuration Steps	<ul style="list-style-type: none"> ● On a MVRF, set the IP address of static domain name www.test.com to 192.168.1.1. ● On an MGMT port, set the IP address of static domain name www.test.com to 192.168.1.1.
	<pre>FS#configure terminal FS(config)# ip host vrf VRFM www.test.com 192.168.1.1 FS(config)# ip oob host www.test.com 192.168.1.1 FS(config)# exit</pre>
Verification	<p>Run the show hosts vrf VRFM command to check whether the static domain name entry is configured.</p> <p>Run the show hosts oob command to check whether the static domain name entry is configured.</p> <p>Run the show hosts command to check whether the static domain name entry is configured.</p>
	<pre>FS#show hosts vrf VRFM</pre>

```

Name servers are:

Host                type    Address    TTL(sec)
www.test.com        static  192.168.1.1  ---

FS#show hosts oob

Name servers are:

Host                type    Address    TTL(sec)
www.test.com        static  192.168.1.1  ---

FS#show hosts

Name servers are:

Host                type    Address    TTL(sec)
www.test.com        static  192.168.1.1  ---
    
```

6.4.2 Configuring Dynamic Domain Name Resolution

Configuration Effect

The system resolver resolves the IP address mapped to a domain name through a DNS server.

Configuration Steps

▾ Enabling Domain Name Resolution

- Domain name resolution is enabled by default.
- If this function is disabled, dynamic domain name resolution does not take effect.

▾ Configuring a DNS Server

- (Mandatory) To use dynamic domain name resolution, you must configure an external DNS server.

Verification

- Run the **show run** command to check the configuration.

Related Commands

▾ Configuring a DNS Server

Command	ip name-server [oob vrf vrf-name] { ip-address } [via mgmt-name]
Parameter	<i>ip-address</i> : indicates the IPv4 address of the DNS server.
Description	oob : indicates that the DNS server supports an out-of-band management interface (interface of mgmt). via : configures an egress management interface.

	<p><i>mgmt-name</i>: specifies the egress management interface for packets in oob mode.</p> <p><i>vrf vrf-name</i>: specifies the name of a VRF instance. If this parameter is not specified, it indicates the public network.</p>
Command Mode	Global configuration mode
Usage Guide	N/A

Configuration Example

▾ **Configuring Dynamic Domain Name Resolution**

<p>Scenario Figure 6-2</p>	
	<p>Device resolves the domain name through the DNS server (192.168.10.1) on the network.</p>
<p>Configuration Steps</p>	<p>Set the IP address of the DNS server of the MGMT port to 192.168.10.1 on the device.</p> <p>Set the IP address of the DNS server of the VRFM to 192.168.10.1 on the device.</p> <p>Set the IP address of the DNS server to 192.168.10.1 on the device.</p>
	<pre> DEVICE#configure terminal DEVICE(config)# ip name-server oob 192.168.10.1 DEVICE(config)# ip name-server vrf VRFM 192.168.10.1 DEVICE(config)# ip name-server 192.168.10.1 DEVICE(config)# exit </pre>
<p>Verification</p>	<p>Run the show hosts oob command to check whether the DNS server is specified.</p> <p>Run the show hosts vrf VRFM command to check whether the DNS server is specified.</p> <p>Run the show hosts command to check whether the DNS server is specified.</p>
	<pre> FS(config)#show hosts Name servers are: 192.168.10.1 static 2001::1 static Host type Address TTL(sec) FS(config)#show hosts oob Name servers are: 192.168.10.1 static 2001::1 static Host type Address TTL(sec) FS(config)#show hosts vrf VRFM Name servers are: 192.168.10.1 static 2001::1 static </pre>

Host	type	Address	TTL(sec)
------	------	---------	----------

6.4.3 Configuring the Source IP Address for DNS Query

Configuration Effect

The prime IP address of the interface is configured as the source IP address of DNS query.

Configuration Steps

Configuring the Source IP Address for DNS Query

- (Optional) You can configure the source IP address of DNS query.
- By default, no source IP address is specified for DNS query.

Verification

- Run the **show run** command to check the configuration.

Related Commands

Configuring the Source IP Address for DNS Query

Command	ip domain-lookup [oob [via <i>mgmt-name</i>] vrf <i>vrf-name</i>] [source { <i>interface</i> ip <i>ip-address</i> }]
Parameter Description	<p>oob: indicates that the DNS server supports an out-of-band management interface (interface of mgmt).</p> <p>via: configures an egress management interface.</p> <p><i>mgmt-name</i>: specifies the egress management interface for packets in oob mode.</p> <p>vrf <i>vrf-name</i>: specifies the name of a VRF instance. If this parameter is not specified, it indicates the public network.</p> <p><i>interface</i>: indicates a Layer 3 interface.</p> <p><i>ip-address</i>: indicates the IPv4 address of the DNS server.</p>
Command Mode	Global configuration mode
Usage Guide	<p>By default, no source IP address of DNS query is configured, so the source IP address of DNS query is decided through the routing process.</p> <p>If the <i>interface</i> parameter is specified, when IPv4 DNS query is sent, its source address is the prime IPv4 address of the source interface.</p> <p>If the ipv4 <i>ip-address</i> field is specified, the configured IPv4 address serves as the source address of IPv4 DNS query.</p>

Configuration Example

Configuring the Source IP Address for DNS Query

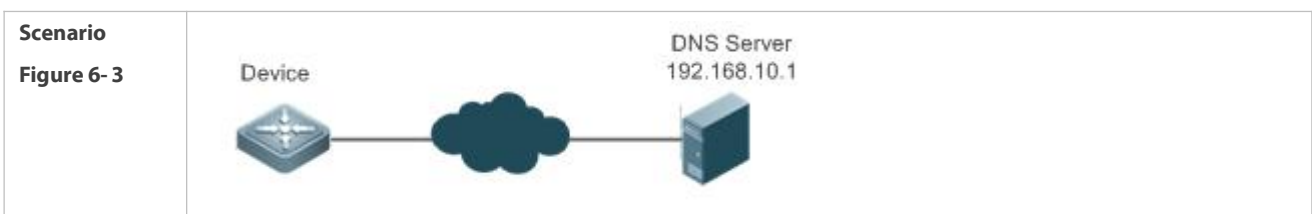

	The source address configured on the device is 10.1.1.1.
Configuration	Set 10.1.1.1 as the source IP address for DNS query on the device.
Steps	Set 10.1.1.1 as the source IP address for DNS query on the MGMT port. Set 10.1.1.1 as the source IP address for DNS query on the VRFM of VRF.
	<pre> DEVICE#configure terminal DEVICE(config)# ip domain-lookup source ip 10.1.1.1 DEVICE(config)# exit DEVICE#configure terminal DEVICE(config)# ip domain-lookup oob source ip 10.1.1.1 DEVICE(config)# exit DEVICE#configure terminal DEVICE(config)# ip domain-lookup vrf VRFM source ip 10.1.1.1 DEVICE(config)# exit </pre>
Verification	Run the show run command to check whether the source IP address is specified.
	<pre> FS(config)#show run include domain-lookup ip domain-lookup source ip 10.1.1.1 ip domain-lookup oob source ip 10.1.1.1 ip domain-lookup vrf VRFM source ip 10.1.1.1 </pre>

6.5 Monitoring

Clearing



Running the **clear** command during device operation may cause data loss or even interrupt services.

Description	Command
Clears the dynamic host name cache table.	clear host [<i>host-name</i>]

Displaying

Description	Command
Displays DNS parameters.	show hosts [oob [via <i>mgmt-name</i>] vrf <i>vrf-name</i>] [<i>host-name</i>]

Debugging



System resources are occupied when debugging information is output. Therefore, disable debugging immediately after use.

Description	Command
Debugs the DNS function.	debug ip dns

7 Configuring FTP Server

7.1 Overview

The File Transfer Protocol (FTP) server function enables a device to serve as an FTP server. In this way, a user can connect an FTP client to the FTP server and upload files to and download files from the FTP server through FTP.

A user can use the FTP server function to easily obtain files such as syslog files from a device and copy files to the file system of the device through FTP.

Protocols and Standards

- RFC959: FILE TRANSFER PROTOCOL (FTP)
- RFC3659: Extensions to FTP
- RFC2228: FTP Security Extensions
- RFC2428: FTP Extensions for IPv6 and NATs
- RFC1635: How to Use Anonymous FTP

7.2 Applications

Application	Description
Providing FTP Services in a LAN	Provides the uploading and downloading services for a user in a Local Area Network (LAN).

7.2.1 Providing FTP Services in a LAN

Scenario

Provide the uploading and downloading services for a user in a LAN.

As shown in Figure 7- 1, enable the FTP server function only in a LAN.

- G and S are enabled with the FTP server function and layer-2 transparent transmission function respectively.
- A user initiates a request for FTP uploading and downloading services.

Figure 7- 1



Remarks G is an egress gateway device.
S is an access device.

Deployment

- G is enabled with the FTP server function.
- As a layer-2 switch, S provides the function of layer-2 transparent transmission.

7.3 Features

Basic Concepts

FTP

FTP is a standard protocol defined by the IETF Network Working Group. It implements file transfer based on the Transmission Control Protocol (TCP). FTP enables a user to transfer files between two networked computers and is the most important approach to transferring files on the Internet. A user can obtain abundant Internet for free through anonymous FTP. In addition, FTP provides functions such as login, directory query, file operation, and other session control. Among the TCP/IP protocol family, FTP is an application-layer protocol and uses TCP ports 20 and 21 for transmission. Port 20 is used to transmit data and port 21 is used to transmit control messages. Basic operations of FTP are described in RFC959.

User Authorization

To connect an FTP client to an FTP server, you should have an account authorized by the FTP server. That is, a user can enjoy services provided by the FTP server after logging in to the FTP server with a user name and password. A maximum of 10 accounts can be configured, a maximum of 2 connections are allowed for each account, and a maximum of 10 connections are supported by the server.

FTP File Transmission Modes

FTP provides two file transmission modes:

- Text transmission mode (ASCII mode): It is used to transfer text files (such as .txt, .bat, and .cfg files). This mode is different from the binary mode in carriage return and line feed processing. In ASCII mode, carriage return and line feed are changed to local CRC characters, for example, \n in Unix, \r\n in Windows, and \r in Mac. Assume that a file being copied contains ASCII text. If a remote computer does not run Unix, FTP automatically converts the file format to suit the remote computer.
- Binary transmission mode: It is used to transfer program files (for example, .app, .bin and .btm files), including executable files, compressed files and image files without processing data. Therefore, Binary mode facilitates faster transfer of all files and more reliable transfer of ASCII files.

FTP Working Modes

FTP provides two working modes:

Figure 7-2

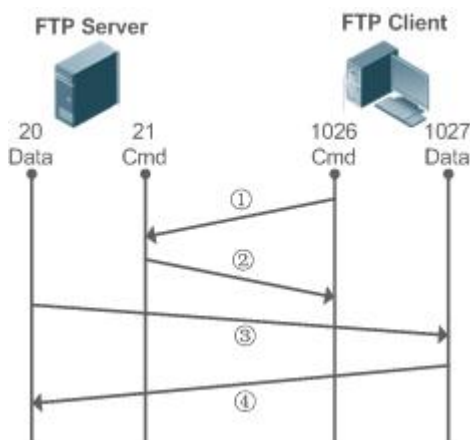
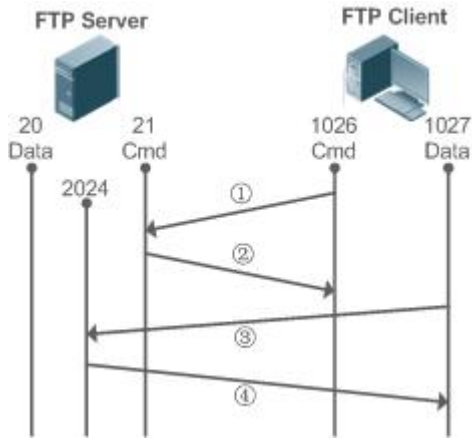

Figure 7-3



- Figure 7-2 shows the active (PORT) mode. The FTP client uses port 1026 to connect to the FTP server through port 21. The client sends commands through this channel. Before receiving data, the client sends the **PORT** command on this channel. The **PORT** command contains information on the channel port (1027) of the client for receiving data. The server uses port 20 to connect to the client through port 1027 for establishing a data channel to receive and transmit data. The FTP server must establish a new connection with the client for data transmission.
- Figure 7-3 shows the passive (PASV) mode. The process for establishing a control channel is similar to that in the PORT mode. However, after the connection is established, the client sends the **PASV** command rather than the **PORT** command. After receiving the **PASV** command, the FTP server enables a high-end port (2024) at random and notifies the client that data will be transmitted on this port. The client uses port 1027 to connect the FTP server through port 2024. Then, the client and server can transmit and receive data on this channel. In this case, the FTP server does not need to establish a new connection with the client.

➤ **Supported FTP Commands**

After receiving an FTP connection request, the FTP server requires the client to provide the user name and password for authentication.

If the client passes the authentication, the FTP client commands can be executed for operations. The available FTP client commands are listed as follows:

ascii	delete	mdelete	mput	quit	send
bin	dir	mmdir	nlist	recv	size
bye		mget		rename	system
cd	get	mkdir	passive		type
cdup		mls	put	rmdir	user
close	ls		pwd		

For usage of these FTP client commands, please refer to your FTP client software document. In addition, many FTP client tools (such as CuteFTP and FlashFXP) provide the graphic user interface. These tools facilitate operations by freeing users from configuring FTP commands.

Overview

Feature	Description
Enabling the FTP	Provides the functions of uploading, downloading, displaying, creating and deleting files for an FTP client.

Server Function	
-----------------	--

7.3.1 Enabling the FTP Server Function

Working Principle

The basic working principle is described in the previous chapter. FS devices provide FTP services after the user name, password, and top-level directory are configured.

Related Configuration

✚ Enabling the FTP Server Function Globally

The FTP server function is disabled by default.

Run the **ftp-server enable** command to enable the FTP server function.

You must enable the FTP server function globally before using it.

✚ Configuring a User Name, Password, and Top-Level Directory

There is no authorized user or top-level directory by default.

Run the **ftp-server user password** and **ftp-server topdir** commands to set an authorized user and top-level directory.

The three configurations above are mandatory; otherwise, the FTP server function cannot be enabled.

✚ Specifying an AAA Method

The default method is enabled if no method is specified.

Run the **ftp-server authentication { default | username }** command to enable a specific AAA method.

Global enabling of the FTP server, enabling of AAA authentication, and configuration of AAA methods are mandatory. Otherwise, AAA methods cannot be specified.

7.4 Configuration

Configuration	Description and Command	
Configuring Basic Functions	(Mandatory) It is used to enable an FTP server.	
	ftp-server enable	Enables the FTP server function.
	ftp-server login timeout	Configures Login timeout for an FTP session.
	ftp-server login times	Configures the valid login count.
	ftp-server topdir	Configures the top-level directory of the FTP server.
	ftp-server username password	Configures a username and password.
	ftp-server timeout	Configures the idle timeout of an FTP session.
	ftp-server authentication { default username } Specifies an AAA method.	

7.4.1 Configuring Basic Functions

Configuration Effect

- Create an FTP server to provide FTP services for an FTP client.

Notes

- The user name, password, and top-level directory need to be configured.
- To enable the server to close an abnormal session within a limited period, you need to configure the idle timeout of a session.

Configuration Steps

↘ **Enabling the FTP Server Function**

- Mandatory.
- Unless otherwise noted, enable the FTP server function on every router.

↘ **Configuring a Top-Level Directory**

- Mandatory.
- Unless otherwise noted, configure the top-level directory as the root directory on every router.

↘ **Configuring a User Name and Password for Login**

- Mandatory.
- The lengths of the user name and password are restricted.

↘ **Configuring the Login Timeout for an FTP Session**

- Optional.
- When a client is disconnected from the server due to an error or other abnormal causes, the FTP server may not know that the user is disconnected and continues to keep the connection. Consequently, the FTP connection is occupied for a long time and the server cannot respond to the login requests of other users. This configuration can ensure that other users can connect to the FTP server within a period of time upon an error.

Verification

Connect an FTP client to the FTP server.

- Check whether the client is connected.
- Check whether operations on the client are normal.

Related Commands

↘ **Enabling the FTP Server Function**

Command	ftp-server enable
Parameter	-
Description	
Command Mode	Global configuration mode
Usage Guide	The client cannot access the FTP server unless the top-level directory, user name and password are configured. Therefore, it is recommended that you configure the top-level directory, user name and password for login by referring to the subsequent chapters before enabling the service for the first time.

↘ Configuring the Valid Login Count

Command	ftp-server login times <i>times</i>
Parameter Description	<i>times</i> : Indicates the valid login count, ranging from 1 to 10.
Command Mode	Global configuration mode
Usage Guide	The valid login count refers to the number of times you can perform account verification during an FTP session. The default value is 3, which means that your session will be terminated if you enter an incorrect user name or password for three times and other users can go online.

↘ Configuring the Login Timeout for an FTP Session

Command	ftp-server login timeout <i>timeout</i>
Parameter Description	<i>timeout</i> : Indicates the login timeout, ranging from 1 to 30 minutes.
Command Mode	Global configuration mode
Usage Guide	The login timeout refers to the maximum duration that the session lasts since being established. If you do not pass the password verification again during the login timeout, the session will be terminated to ensure that other users can log in.

↘ Configuring the Top-Level Directory of the FTP Server

Command	ftp-server topdir <i>directory</i>
Parameter Description	<i>directory</i> : Indicates the user access path.
Command Mode	Global configuration mode
Usage Guide	If the top-level directory of the server is set to "/syslog", the FTP client can access only the files and directories in the "/syslog" directory on the device after login. Due to restriction on the top-level directory, the client cannot return to the upper directory of "/syslog".

↘ Configuring a User Name and Password for Server Login

Command	ftp-server username <i>username</i> password [<i>type</i>] <i>password</i>
Parameter Description	username : Indicates a user name. <i>type</i> : 0 or 7. 0 indicates that the password is not encrypted (plaintext) and 7 indicates that the password is encrypted (cipher text). password : Indicates a password.
Command Mode	Global configuration mode

Usage Guide	<p>The FTP server does not support anonymous login; therefore, a user name must be configured.</p> <p>A user name consists of up to 64 characters including letters, half-width digits and symbols without spaces.</p> <p>A password consists of only letters or digits. Spaces at the beginning and end of the password are ignored. Spaces inside the password are viewed as part of the password.</p> <p>A plaintext password consists of 1 to 25 characters. A cipher text password consists of 4 to 52 characters.</p> <p>User names and passwords must match. A maximum of 10 users can be configured.</p>
--------------------	--

↘ **Configuring the Idle Timeout for an FTP Session**

Command	ftp-server timeout <i>time</i>
Parameter	<i>time</i> : Indicates the idle timeout, ranging from 1 to 3,600 minutes.
Description	
Command	Global configuration mode
Mode	
Usage Guide	The idle timeout of a session refers to the duration from the end of an FTP operation to the start of the next FTP operation in an FTP session. After the server responds to an FTP client command operation (for example, after a file is completely transferred), the server starts to count the idle time again, and stops when the next FTP client command operation arrives. Therefore, the configuration of the idle timeout has no effect on some time-consuming file transfer operations.

↘ **Configuring an AAA Method on the FTP Server**

Command	ftp-server authentication { default <i>username</i> }
Parameter	default : Indicates the default AAA method.
Description	<i>username</i> : Enters the name of an AAA method.
Command	Global configuration mode
Mode	
Usage Guide	Run this command to specify an AAA method that applies to clients logging in the FTP server.

↘ **Displaying Server Status**

Command	show ftp-server
Parameter	N/A
Description	
Command	Privileged EXEC mode
Mode	
Usage Guide	Run this command to display FTP server status.

↘ **Debugging**

Command	debug ftp-server pro/err
Parameter	N/A
Description	
Command	Privileged EXEC mode
Mode	
Usage Guide	Run this command to debug message/error events of the FTP server.

Configuration Example

➤ **Creating an FTP Server on an IPv4 Network**

<p>Configuration Steps</p>	<ul style="list-style-type: none"> ● Establish TCP connections between the server and the client. ● Configure the top-level directory/syslog. ● Set the user name user and password to password. ● Set the session idle timeout to 5 minutes. ● Specify an AAA method.
	<pre>FS(config)#ftp-server username user FS(config)#ftp-server password password FS(config)#ftp-server timeout 5 FS(config)#ftp-server topdir / FS(config)#ftp-server enable FS(config)# ftp-server authentication name</pre>
<p>Verification</p>	<p>Run the show ftp-server command to check whether the configuration takes effect.</p>
	<pre>FS#show ftp-server ftp-server information ===== enable : Y topdir : tmp/ timeout: 10min username:aaaa password:(PLAIN)bbbb connect num[2] [0]trans-type:BINARY (ctrl)server IP:192.168.21.100[21] client IP:192.168.21.26[3927] [1]trans-type:ASCII (ctrl)server IP:192.168.21.100[21] client IP:192.168.21.26[3929] username:a1 password:(PLAIN)bbbb connect num[0] username:a2 password:(PLAIN)bbbb connect num[0] username:a3 password:(PLAIN)bbbb connect num[0] username:a4 password:(PLAIN)bbbb connect num[0] username:a5 password:(PLAIN)bbbb connect num[0] username:a6 password:(PLAIN)bbbb connect num[0] username:a7 password:(PLAIN)bbbb connect num[0] username:a8 password:(PLAIN)bbbb connect num[0] username:a9 password:(PLAIN)bbbb connect num[0]</pre>

Common Errors

- No user name is configured.
- No password is configured.
- No top-level directory is configured.

7.5 Monitoring

Displaying

Description	Command
Displays the FTP server configuration.	show ftp-server

Debugging



System resources are occupied when debugging information is output. Therefore, disable debugging immediately after use.

Description	Command
Debugs the FTP server error events.	debug ftp-server err
Debugs the FTP server message events.	debug ftp-server pro

8 Configuring FTP Client

8.1 Overview

The File Transfer Protocol (FTP) is an application of TCP/IP. By establishing a connection-oriented and reliable TCP connection between the FTP client and server, a user can access a remote computer that runs the FTP server program.

An FTP client enables file transfer between a device and the FTP server over the FTP protocol. A user uses the client to send a command to the server. The server responds to the command and sends the execution result to the client. By means of command interaction, the user can view files in the server directory, copy files from a remote computer to a local computer, or transfer local files to a remote computer.

FTP is intended to facilitate sharing of program/data files and encourage remote operation (by using programs). Users do not need to be concerned with differences of different files systems on different hosts. Data is transmitted in an efficient and reliable manner. FTP enables remote file operation securely.

FS FTP clients are different from standard FTP clients that run interactive commands. Instead, you enter the **copy** command in CLI to perform control-connection instructions such as **open**, **user**, and **pass**. After a control connection is established, the file transfer process starts, and then a data connection is established to upload or download files.



Old devices support TFTP. However, TFTP is used to transfer small files whereas FTP is used to transfer large files. Implementing FTP on a device enables the file transfer between the local device and other clients or servers.

Protocols and Standards

- RFC959: FILE TRANSFER PROTOCOL (FTP)

8.2 Applications

Application	Description
Uploading a Local File to a Remote Server	Local and remote files need to be shared, for example, uploading a local file to a remote server.
Downloading a File from a Remote Server to a Local Device	Local and remote files need to be shared, for example, downloading a file from a remote server to a local device.

8.2.1 Uploading a Local File to a Remote Server

Scenario

Local and remote files need to be shared, for example, uploading a local file to a remote server.

As shown in Figure 8-1, resources are shared only on the Intranet.

Figure 8-1



Deployment

- Implement only communication on the Intranet.
- Enable file uploading on the FTP client.
- Enable file uploading on the FTP server.

8.2.2 Downloading a File from a Remote Server to a Local Device

Scenario

Local and remote files need to be shared, for example, downloading a file from a remote server to a local device.

As shown in Figure 8-2, resources are shared only on the Intranet.

Figure 8-2



Deployment

- Implement only communication on the Intranet.
- Enable file downloading on the FTP client.
- Enable file downloading on the FTP server.

8.3 Features

Basic Concepts

↘ Uploading FTP Files

Upload files from an FTP client to an FTP server.

↘ Downloading FTP Files

Download files from an FTP server to an FTP client.

↘ FTP Connection Mode

An FTP client and an FTP server can be connected in the active or passive mode.

↘ FTP Transmission Mode

The transmission between an FTP client and an FTP server is available in two modes, namely, text (ASCII) and binary (Binary).

↘ Specifying the Source Interface IP Address for FTP Transmission

An FTP client is configured with a source IP address for communication with an FTP server.

Overview

Feature	Description
Uploading FTP Files	Uploads files from an FTP client to an FTP server.
Downloading FTP Files	Downloads files from an FTP server to an FTP client.
FTP Connection Mode	Specifies the connection mode between an FTP client and an FTP server.
FTP Transmission Mode	Specifies the transmission mode between an FTP client and an FTP server.
Specifying the Source Interface IP Address for FTP Transmission	Configures a source IP address of an FTP client for communication with an FTP server.
Checking FTP File Size	Disabling size check of files downloaded from an FTP server.

8.3.1 Uploading FTP Files

FTP enables file uploading. Start the FTP client and FTP server simultaneously, and upload files from the FTP client to the FTP server.

8.3.2 Downloading FTP Files

FTP enables file downloading. Start the FTP client and FTP server simultaneously, and download files from the FTP server to the FTP client.

8.3.3 FTP Connection Mode

FTP needs to use two TCP connections: one is a control link (command link) that is used to transfer commands between the FTP client and server; the other one is a data link that is used to upload or download data.

- Control connection: Some simple sessions are enabled with the control connection only. A client sends a command to a server. After receiving the command, the server sends a response. The process is shown in Figure 8-3.

Figure 8-3 Control Connection

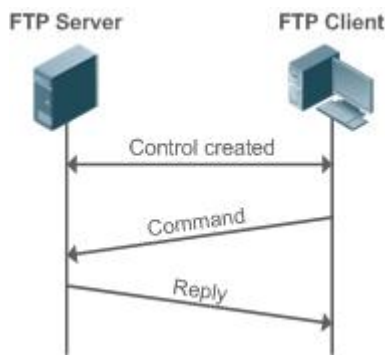

- Control connection and data connection: When a client sends a command for uploading or downloading data, both the control connection and data connection need to be established.

FTP supports two data connection modes: active (PORT) and passive (PASC). The two modes are different in establishing a data connection.

- Active mode

In this mode, an FTP server connects to an FTP client actively when a data connection is established. This mode comprises four steps:

- The client uses source port 5150 to communicate with the server through port 21 as shown in Figure 1-1 to send a connection request and tell the server that the port to be used is port 5151.
- After receiving the request, the server sends a response OK(ACK). The client and server exchanges control signaling by console ports.
- The server enables port 20 as the source port to send data to port 5151 of the client.
- The client sends a response. Data transmission ends.

Figure 8-4 Active (PORT) Mode

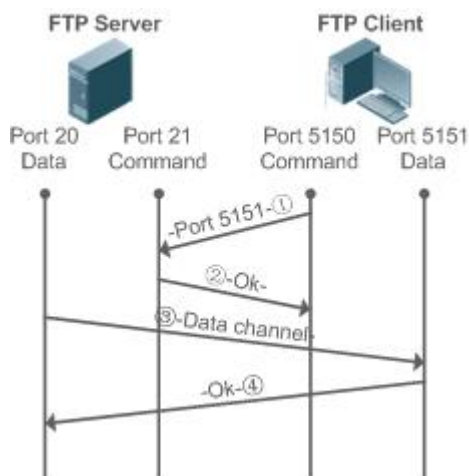

- Passive mode

Figure 8- 5 Passive (PASV) Mode

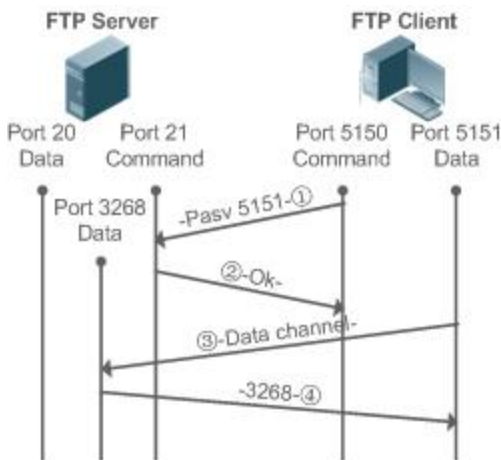

This mode is often set by the **passive** command. When a data connection is established, the FTP server is connected to the FTP client passively. This mode comprises four steps:

1. In the passive mode, the client initializes the control signaling connection. The client uses source port 5150 to connect to the server through port 21 as shown in Figure 1-5, and runs the **passive** command to request the server to enter the PASV mode.
2. The server agrees to enter the PASV mode, selects a port number greater than 1024 at random, and tells the port number to the client.
3. After receiving the message, the client uses port 5151 as shown in Figure 1-5 to communicate with the server through port 3268. Here, port 5151 is the source port and port 3268 is the destination port.
4. After receiving the message, the server sends data and responds an ACK(OK) response.

After the data connection is established, you can perform file uploading and downloading. Besides, you can perform some operations on the server file from the client.

i The control connection for command and feedback transmission is always present whereas the data connection is established as required. Only an FTP client has the right to select and set the PASV or PORT mode. The FTP client sends a command to establish a data connection. FS FTP clients use the PASV mode by default.

8.3.4 FTP Transmission Mode

FTP provides two transmission modes: text (ASCII) and binary (Binary). At present, FS FTP clients support both the ASCII and Binary modes and use the BINARY mode by default.

- ASCII mode

The difference between the ASCII and Binary modes lies in carriage return and line feed processing. In ASCII mode, carriage return and line feed are changed to a local Carriage Return Character (CRC), for example, \n in Unix, \r\n in Windows, and \r in Mac.



- Binary mode

The Binary mode can be used to transfer executable files, compressed files and image files without processing data. For example, a text file needs to be transferred from Unix to Windows. When the Binary mode is used, the line breaks in Unix will not be converted from \r to \r\n; therefore in Windows, this file has no line feeds and displays many black squares. Therefore, Binary mode facilitates faster transfer of all files and more reliable transfer of ASCII files.

8.3.5 Specifying the Source Interface IP Address for FTP Transmission

An FTP client is configured with a source IP address for communication with an FTP server. In this way, the FTP client connects to the server and shares files with the server through the specified source IP address.

8.4 Configuration

Configuration	Description and Command
Configuring Basic Functions	 (Mandatory) It is used to configure the functions of an FTP client.
	copy flash Uploads a file.
	copy ftp Downloads a file.
Configuring Optional Functions	 (Optional) It is used to configure the working mode of the FTP client.
	ftp-client port Sets the connection mode to active (port).
	ftp-client ascii Sets the transmission mode to ASCII.
	ftp-client source-address Configures the source IP address of the FTP client.
	default ftp-client Restores the default settings, namely, connection mode set to passive (PASV), transmission mode to Binary and source IP address removed.
ftp-client disable-size-check Disables size check of FTP files.	

8.4.1 Configuring Basic Functions

Configuration Effect

- Implement file uploading and downloading.

Notes

- Pay attention to the command formats for uploading and downloading.

Configuration Steps

↘ Uploading a File

- This configuration is mandatory when a file needs to be uploaded.
- Configure the FTP URL as the destination address of **copy** in Privileged EXEC mode.

↘ Downloading a File

- This configuration is mandatory when a file needs to be downloaded.
- Configure the FTP URL as the source address of **copy** in Privileged EXEC mode.

Verification

- Check whether the uploaded file exists on the FTP server.
- Check whether the downloaded file exists at the destination address.

Related Commands

↘ Uploading a File

Command	copy flash: <i>[local-directory/]local-file</i> ftp: <i>//username:password@dest-address[/remote-directory]/remote-file</i>
Parameter Description	<i>local-directory</i> : Specifies a directory on the local device. If it is not specified, it indicates the current directory. <i>local-file</i> : Specifies a local file to be uploaded. <i>username</i> : Specifies a user name for accessing the FTP server, consisting of no more than 32 bytes and excluding delimiters such as /, :, @ and space. This parameter is mandatory. <i>password</i> : Specifies a password for accessing the FTP server, consisting of no more than 32 bytes and excluding delimiters such as /, :, @ and space. This parameter is mandatory. <i>dest-address</i> : Specifies an IP address for the FTP server. <i>remote-directory</i> : Specifies a directory on the server. <i>remote-file</i> : Renames the file on the server.  The directory specified by the <i>local-directory</i> field must have been created on the device. This command will not automatically create a directory.
Command Mode	Global configuration mode
Usage Guide	Run this command to upload a file from the flash of a local device to an FTP server.

↘ Downloading an FTP File

Command	copy ftp: <i>//username:password@dest-address[/remote-directory]/remote-file</i> flash: <i>[local-directory/]local-file</i>
Parameter Description	<i>username</i> : Specifies a user name for accessing the FTP server, consisting of no more than 32 bytes and excluding delimiters such as /, :, @ and space. This parameter is mandatory. <i>password</i> : Specifies a password for accessing the FTP server, consisting of no more than 32 bytes and excluding delimiters such as /, :, @ and space. This parameter is mandatory. <i>dest-address</i> : Specifies an IP address for the FTP server. <i>remote-directory</i> : Specifies a directory on the server. <i>remote-file</i> : Specifies a file to be downloaded. <i>local-directory</i> : Specifies a directory on the local device. If it is not specified, it indicates the current directory. <i>local-file</i> : Renames the file in the local flash.  The directory specified by the <i>local-directory</i> field must have been created on the device. This command will not automatically create a directory.
Command Mode	Global configuration mode
Usage Guide	Run this command to download a file from an FTP server to the flash of a local device.

Configuration Example

↘ Uploading a File

Configuration	Upload the local-file file in the home directory of a device to the root directory of an FTP server whose user name is user , password is pass and IP address is 192.168.23.69 and name the file as remote-file .
----------------------	--

Steps	
	FS# copy flash: home/local-file ftp://user:pass@192.168.23.69/root/remote-file
Verification	Check whether the remote-file file exists on the FTP server.

⤵ **Downloading a File**

Configuration Steps	Download the remote-file file from the root directory of an FTP server whose user name is user , password is pass and IP address is 192.168.23.69 to the home directory of a device and save the file as local-file .
	FS# copy ftp://user:pass@192.168.23.69/root/remote-file flash: home/local-file
Verification	Check whether the remote-file file exists in the home directory of the flash.

Common Errors

- The command formats for uploading and downloading are incorrect.
- The user name or password is incorrect.

8.4.2 Configuring Optional Functions

Configuration Effect

- Set the connection and transmission modes and configure a source IP address of the client for file uploading and download.

Notes

- If an FTP client needs to be configured based on VRF, specify a VRF first.

Configuration Steps

⤵ **Setting the Connection Mode to Active (Port)**

- Optional.
- Configure the connection mode of FTP.

⤵ **Setting the Transmission Mode to ASCII**

- Optional.
- Configure the transmission mode of FTP.

⤵ **Configuring the Source IP Address of the FTP Client**

- Optional.
- Configure the source IP address of the FTP client.

⤵ **Restoring the Default Settings**

- Optional.
- Restore the default settings of the FTP client.

Verification

Run the **show run** command to check whether the configuration takes effect.

Related Commands

↳ Setting the Connection Mode to Active (Port)

Command	ftp-client [vrf vrf-name] port
Parameter	vrf vrf-name: Specifies a VRF.
Description	
Command Mode	Global configuration mode
Usage Guide	Run this command to set the connection mode to active (port). The default connection mode is passive (PASV).

↳ Configuring the Source IP Address of the FTP Client

Command	ftp-client [vrf vrfname] source-address {ip-address ipv6-address}
Parameter	vrf vrf-name: Specifies a VRF.
Description	<i>ip-address:</i> Specifies the IPv4 address of a local interface. <i>ipv6-address:</i> Specifies the IPv6 address of a local interface.
Command Mode	Global configuration mode
Usage Guide	Run this command to configure an interface IP address of the client for connection to the server. By default, the client is not configured with a local IP address. Instead, the route selects an IP address for the client.

↳ Setting the Transmission Mode to ASCII

Command	ftp-client [vrf vrf-name] ascii
Parameter	vrf vrf-name: Specifies a VRF.
Description	
Command Mode	Global configuration mode
Usage Guide	Run this command to set the transmission mode to ASCII. The default transmission mode is Binary.

↳ Restoring the Default Settings

Command	default ftp-client [vrf vrf-name]
Parameter	vrf vrf-name: Specifies a VRF.
Description	
Command Mode	Global configuration mode
Usage Guide	Run this command to restore the default settings, namely, connection mode set to passive (PASV), transmission mode to Binary and source IP address removed.

↳ Disabling Size Check of FTP Files

Command	ftp-client disable-size-check
----------------	--------------------------------------

Parameter	N/A
Description	
Command	Global configuration mode
Mode	
Usage Guide	Run this command to disable size check of FTP files downloaded from an FTP server.

Configuration Example

Configuring Optional Functions

Configuration Steps	<ul style="list-style-type: none"> ● Set the connection mode of FTP to port. ● Set the transmission mode to ASCII. ● Set the source IP address to 192.168.23.167. ● Set the connection mode of vrf 123 to port. ● Set the transmission mode of vrf 123 to ASCII.
	<pre> FS# configure terminal FS(config)# ftp-client ascii FS(config)# ftp-client port FS(config)# ftp-client source-address 192.168.23.167 FS(config)# ftp-client vrf 123 port FS(config)# ftp-client vrf 123 ascii FS(config)# end </pre>
Verification	<p>Run the show run command on the device to check whether the configuration takes effect.</p> <pre> FS# show run ! ftp-client ascii ftp-client port ftp-client source-address 192.168.23.167 ! </pre>

Common Errors

- The source IP address is not a local IP address.
- Before configuring the **ftp-client vrf** command, configure the **vrf** command.

8.5 Monitoring

Displaying

Description	Command
-------------	---------

Displays the FTP client configuration.	show run
--	-----------------

Debugging



System resources are occupied when debugging information is output. Therefore, disable debugging immediately after use.

Description	Command
Debugs the FTP Client.	debug ftp-client

9 Configuring Tunnel Interfaces

9.1 Overview

Tunnel interfaces are virtual interfaces used to implement tunneling. A tunnel interface provides a standard transmission link and you do not need to specify a transport protocol or payload protocol. Each tunnel interface represents a transmission link.

Tunneling function includes the following parts:

- **Payload protocol:** Is used to encapsulate the data transmitted in tunnels. For example, the IPv4 and IPv6 protocols work as payload protocols. Generic routing encapsulation (GRE) tunnels can carry IPv4 or IPv6 data.
- **Bearer protocol:** Is used for secondary encapsulation and identification of the data to be transmitted. Among the tunnels described in this document, only the GRE tunnel uses a bearer protocol, that is, the GRE protocol. The other tunnels use the IPv4 and IPv6 protocols. Packets are encapsulated with outer IPv4 and IPv6 headers.
- **Transport protocol:** Is used to transmit the data encapsulated for the second time through a bearer protocol. FS products use the widely applied IPv4 and IPv6 protocols as transport protocols.

The tunnel mode can be used to set up communication between two private networks running the same protocol through a heterogeneous public network.

Tunneling is applicable to the following scenarios:

- Because tunneling supports different payload protocols, it allows the communication between local networks running non-IP protocols through a single network (IP network). Because tunneling operates on routes running transport protocols (IP protocols), it allows wider application of the protocols with hop limit.
- Tunneling allows discrete subnets to be connected through a single network (IP network).
- Tunneling allows the virtual private network (VPN) feature to be enabled on wide area networks (WANs).

Encapsulated data is transmitted through tunnels, which is a complex process. In some cases, you need to pay attention to the following changes:

- Because a tunnel is a logical link, it appears to be a single hop in routing. However, actually its path cost may be more than one hop. When you use a tunnel for transmission, note that the route of the tunnel link is different from the actual route.
- When you configure a firewall or an access control list (ACL), take the tunnel configuration into consideration. The transmission bandwidth and maximum transmission unit (MTU) allowed by payload protocols are smaller than the theoretical values.

Protocols and Standards

- RFC2784: Generic Routing Encapsulation (GRE)

- RFC2890: Key and Sequence Number Extensions to GRE
- RFC3056: Connection of IPv6 Domains via IPv4 Clouds
- RFC3068: An Anycast Prefix for 6to4 Relay Routers
- RFC3964: Security Considerations for 6to4
- RFC4023: Encapsulating MPLS in IP or Generic Routing Encapsulation (GRE)
- RFC4087: IP Tunnel MIB
- RFC4213: Basic Transition Mechanisms for IPv6 Hosts and Routers
- RFC4797: Use of Provider Edge to Provider Edge (PE-PE) Generic Routing Encapsulation (GRE) or IP in BGP/MPLS IP Virtual Private Networks
- RFC5158: 6to4 Reverse DNS Delegation Specification
- RFC5214: Intra-Site Automatic Tunnel Addressing Protocol (ISATAP)
- RFC5332: MPLS Multicast Encapsulations
- RFC5579: Transmission of IPv4 Packets over Intra-Site Automatic Tunnel Addressing Protocol (ISATAP) Interfaces
- RFC5845: Generic Routing Encapsulation (GRE) Key Option for Proxy Mobile IPv6
- RFC6245: Generic Routing Encapsulation (GRE) Key Extension for Mobile IPv4
- RFC6343: Advisory Guidelines for 6to4 Deployment
- RFC6372: 6to4 Provider Managed Tunnels
- draft-zhou-dhc-gre-option-00 DHCPv4 and DHCPv6 options for GRE
- draft-templin-v6ops-isops-18 Operational Guidance for IPv6 Deployment in IPv4 Sites using ISATAP

9.2 Applications

Application	Description
Accessing the IPv6 Sites on a Campus Network	Accesses the IPv6 sites on a campus network.
Connecting a Campus Network to an IPv6 Backbone Network	Connects a campus network to an IPv6 backbone network.

9.2.1 Accessing the IPv6 Sites on a Campus Network

Scenario

IPv6 servers are deployed on some campus networks, and PCs need to access the servers. The Intra-Site Automatic Tunnel Addressing Protocol (ISATAP) can be used to realize the access.

Figure 9-1

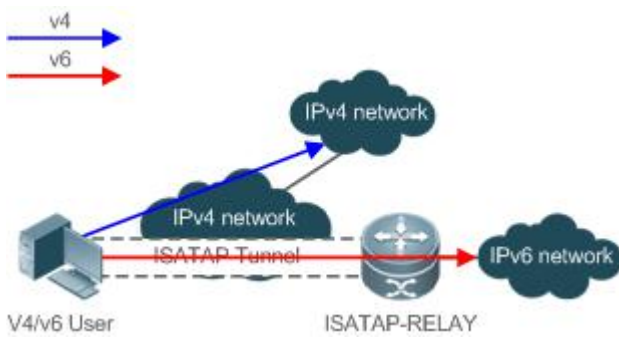

Remarks	ISATAP-RELAY supports tunneling. Users on the campus network can access IPv4 servers directly through the IPv4 network, but need to access IPv6 servers through the ISATAP tunnel.
----------------	--

Deployment

- IPv4 and IPv6 users access the IPv4 network by using IPv4 addresses.
- IPv4 and IPv6 users access the IPv6 network through the ISATAP tunnel.
- The ISATAP tunnel is established between PCs and the ISATAP-RELAY router.

9.3 Configuration

Configuration	Description and Command	
Configuring Tunnel Interfaces	⚠ (Mandatory) It is used to create tunnels.	
	interface tunnel	Creates a tunnel interface.
	tunnel source	Configures the local address of a tunnel.
Configuring a Tunnel Mode	⚠ (Optional) It is used to configure a tunnel mode.	
	tunnel mode	Configures a tunnel encapsulation mode.
Configuring a Local Address	⚠ (Optional) It is used to configure the local address of a tunnel.	
	tunnel source	Configures the address of a tunnel.
Configuring a Peer Address	⚠ (Optional) It is used to configure the peer address of a tunnel.	
	tunnel destination	Configures the peer address of a tunnel.
Configuring the TOS of a Tunnel	⚠ (Optional) It is used to configure the type of service (TOS) of a tunnel.	
	tunnel tos	Configures the TOS of a tunnel.
Configuring the TTL of a Tunnel	⚠ (Optional) It is used to configure the time to live (TTL) of a tunnel.	
	tunnel ttl	Configures the TTL of a tunnel.

9.3.1 Configuring Tunnel Interfaces

Configuration Effect

- Create a tunnel interface.

Configuration Steps

➤ **Creating a Tunnel Interface**

- Run the **interface tunnel** *number* command in global configuration mode to create a tunnel interface.
- The tunneling service is available only after a tunnel interface is created.

Verification

- Run the **show interfaces tunnel** *number* command to check whether the tunnel interface is created successfully.

Related Commands

➤ **Configuring a Tunnel Interface**

Command	interface tunnel <i>number</i>
Parameter	<i>number</i> : Indicates the number of a tunnel interface.
Description	
Command	Global configuration mode
Mode	
Usage Guide	N/A

➤ **Checking the Tunnel Configuration**

Command	show interfaces tunnel <i>number</i>
Parameter	<i>number</i> : Indicates the number of a tunnel interface.
Description	
Command	Global configuration mode
Mode	
Usage Guide	N/A

Configuration Example

➤ **Creating a Tunnel Interface**

Configuration Steps	<ul style="list-style-type: none"> ● Create a tunnel interface.
	<pre>FS# configure terminal FS(config)# interface tunnel 1 FS(config-if-Tunnel 1)# end</pre>
Verification	<ul style="list-style-type: none"> ● Check the configuration of the tunnel interface.
	<pre>FS# show interfaces tunnel 1 Tunnel attributes: Tunnel protocol/transport is gre ip</pre>

Common Errors

- A tunnel interface cannot be created due to memory deficiency.
- A tunnel interface cannot be created due to insufficient hardware resource deficiency.

9.3.2 Configuring a Tunnel Mode

Configuration Effect

- Configure a tunnel encapsulation mode in tunnel interface configuration mode when you need to use a tunnel in non-default encapsulation mode.

Configuration Steps

▾ Configuring a Tunnel Mode

- Optional.
- The default encapsulation mode for switches is tunnel mode ipv6ip.
- To change the default encapsulation mode, run the **tunnel mode** command in tunnel interface configuration mode.

Verification

- Run the **show interfaces tunnel number** command to check whether the tunnel encapsulation mode is configured.

Related Commands

▾ Configuring a Tunnel Mode

Command	tunnel mode { gre {ip ipv6} ipv6 ipip ipv6ip [6to4 isatap] }
Parameter Description	Each mode corresponds to different encapsulation format of the packets sent out by the tunnel interface. gre ip indicates that a packet is encapsulated with a GRE header and an IPv4 header in sequence and then is transmitted over a new IPv4 network. gre ipv6 indicates that a packet is encapsulated with a GRE header and an IPv6 header in sequence and then is transmitted over a new IPv6 network. ipv6 indicates that a packet sent out by the tunnel interface is encapsulated with an IPv6 header and then transmitted over a new IPv6 network. ipip indicates that the tunnel interface carries only IPv4 packets and a packet sent out by the tunnel interface is encapsulated with an IPv4 header and then transmitted over a new IPv4 network. ipv6ip indicates that the tunnel interface carries only IPv6 packets and a packet sent out by the tunnel interface is encapsulated with an IPv4 header and then transmitted over a new IPv4 network. The preceding tunnels are manual tunnels, whereas IPv6IP, 6to4, and ISATAP are automatic tunnels. During packet encapsulation, the destination IPv4 address is mapped from the destination IPv6 address.
Command Mode	Interface configuration mode
Usage Guide	Both ends of a tunnel must be configured with the same encapsulation mode. Otherwise, the tunnel cannot work.

Configuration Example

▾ Configuring the IPv4 over IPv4 Encapsulation Mode

Configuration Steps	<ul style="list-style-type: none"> ● Configure the IPv4 over IPv4 encapsulation mode on a tunnel interface.
----------------------------	--

	<pre>FS# configure terminal FS(config)# interface tunnel 1 FS(config-if-Tunnel 1)# tunnel mode ipip FS(config)# end</pre>
Verification	<ul style="list-style-type: none"> ● Check the configuration of the tunnel interface.
	<pre>FS# show interfaces tunnel 1 Tunnel attributes: Tunnel protocol/transport is ipv6ip</pre>

Common Errors

- A 6to4 tunnel or ISATAP tunnel is configured for a virtual routing and forwarding (VRF) instance that is already configured with a 6to4/ISATAP tunnel.

9.3.3 Configuring a Local Address

Configuration Effect

- Configure the local address of a tunnel.

Notes

- The local address of a tunnel must match the transport protocol used by the tunnel. Otherwise, the tunnel interface will not be up (be disabled).
- When the local address is specified indirectly by configuring another interface, the local address is the primary IPv4 address or the first global public IPv6 address of IPv6.

Configuration Steps

➤ **Configuring a Local Address**

- Mandatory.
- Run the **tunnel source** command in tunnel interface configuration mode to specify the local address of a tunnel.

Verification

- Run the **show interfaces tunnel** *number* command to display the local address of the tunnel.

Related Commands

➤ **Configuring a Local Address**

Command	tunnel source { <i>ip-address</i> <i>interface-name interface-number</i> }
Parameter	ip-address: Indicates an IPv4 or IPv6 address.

Description	<i>Interface-name interface-number</i> : Indicates a Layer-3 interface.
Command	Interface configuration mode
Mode	
Usage Guide	If you specify an IPv4 or IPv6 address directly, you need to configure the address of the device.

Configuration Example

📌 **Configuring a Local Address**

Configuration Steps	<ul style="list-style-type: none"> Configure the local address of a tunnel as 1.1.1.1.
	<pre>FS# configure terminal FS(config)# interface tunnel 1 FS(config-if-Tunnel 1)# tunnel mode ipv6ip FS(config-if-Tunnel 1)# tunnel source 1.1.1.1</pre>
Verification	<ul style="list-style-type: none"> Check the configuration of the tunnel interface.
	<pre>FS# show interfaces tunnel 1 Tunnel attributes: Tunnel source 1.1.1.1, destination UNKNOWN, unroutable Tunnel TOS/Traffic Class not set, Tunnel TTL 254 Tunnel config nested limit is 0, current nested number is 0 Tunnel protocol/transport ipv6ip Tunnel transport VPN is no set</pre>

9.3.4 Configuring a Peer Address

Configuration Effect

- A manual tunnel can be used (the tunnel interface is up) only after its peer address is configured.

Notes

- Peer addresses cannot be configured for automatic tunnels.

Configuration Steps

📌 **Configuring a Peer Address**

- The peer addresses must be configured for all tunnels except 6to4, and ISATAP tunnels.
- Run the **tunnel destination** command in interface configuration mode to configure the peer address of a tunnel.

Verification

- Run the **show interfaces tunnel** command to check whether the destination address is configured.

Related Commands

▾ **Configuring a Peer Address**

Command	tunnel destination { ip-address }
Parameter Description	<i>ip-address</i> : Indicates an IPv4 or IPv6 address.
Command Mode	Interface configuration mode
Usage Guide	The peer address of a manual tunnel must be configured. The protocol suite type of the configured peer address must be consistent with the transport protocol used by the tunnel. If they are not consistent, the tunnel interface will be disabled (down).

Configuration Example

▾ **Configuring a Peer Address**

Configuration Steps	<ul style="list-style-type: none"> ● Configure the peer address of a tunnel as 2.2.2.2. <pre>FS# configure terminal FS(config)# interface tunnel 1 FS(config-if-Tunnel 1)# tunnel mode ipv6ip FS(config-if-Tunnel 1)# tunnel destination 2.2.2.2</pre>
Verification	<ul style="list-style-type: none"> ● Check the configuration of the tunnel interface. <pre>FS# show interfaces tunnel 1 Tunnel attributes: Tunnel source: UNKNOWN, destination 2.2.2.2, unroutable Tunnel TOS/Traffic Class not set, Tunnel TTL 254 Tunnel config nested limit is 0, current nested number is 0 Tunnel protocol/transport ipv6ip</pre>

Common Errors

- A peer address is configured for an automatic tunnel.
- The peer address configured for a tunnel is the same as that of another tunnel.

9.3.5Configuring the TTL of a Tunnel

Configuration Effect

- Specify the TTL or hop limit of tunnel encapsulation protocol headers.

Configuration Steps

➤ **Configuring the TTL of a Tunnel**

- Optional.
- By default, the TTL is 254.
- To change the tunnel link length limit, run the **tunnel ttl** command.

Verification

- Run the **show interfaces tunnel** command to check whether the TTL is configured.

Related Commands

➤ **Configuring the TTL of a Tunnel**

Command	tunnel ttl <i>hop-limit</i>
Parameter	<i>hop-limit</i> : Indicates the hop limit of a tunnel.
Description	
Command Mode	Global configuration mode
Usage Guide	The hop limit specifies the maximum number of routers that a packet can pass through. The default value is 254. This command is used to change the hop quantity limit.

Configuration Example

➤ **Configuring the TTL of a Tunnel**

Configuration Steps	<ul style="list-style-type: none"> ● Configure the TTL of a tunnel.
	<pre>FS# configure terminal FS(config)# interface tunnel 1 FS(config-if-Tunnel 1)# tunnel mode ipv6ip FS(config-if-Tunnel 1)# tunnel ttl 3</pre>
Verification	<ul style="list-style-type: none"> ● Check the configuration of the tunnel interface.
	<pre>FS# show interfaces tunnel 1 Tunnel attributes: Tunnel source 1.1.1.1, destination UNKNOWN, unrouteable Tunnel TOS/Traffic Class 0x2, Tunnel TTL 3 Tunnel config nested limit is 0, current nested number is 0 Tunnel protocol/transport ipv6ip</pre>

Tunnel transport VPN is VPN1

9.3.6 Configuring the TOS of a Tunnel

Configuration Effect

- Specify the TOS or Traffic Class field in the transport protocol header.

Notes

- If the TOS or Traffic Class field in the transport protocol header is not specified, the TOS or Traffic Class field of the protocol is copied to the header.

Configuration Steps

↘ Configuring the TOS of a Tunnel

- Optional.
- To change the priority of tunnel data on a network, run the **tunnel tos** command in interface configuration mode.

Verification

- Run the **show interfaces tunnel** command to check whether the TOS is configured.

Related Commands

↘ Configuring the TOS of a Tunnel

Command	tunnel tos <i>number</i>
Parameter	<i>number</i> : Indicates the TOS of a tunnel.
Description	
Command Mode	Interface configuration mode
Usage Guide	By default, if the IPv4 protocol is used for the inner bearer and outer encapsulation in a tunnel, the TOS bytes in the inner IPv4 header are copied to the outer IPv4 header. If the IPv6 protocol is used for the inner bearer and outer encapsulation in a tunnel, the Traffic Class 8 bit in the inner IPv6 header is copied to the outer IPv6 header. In other cases, the TOS field in the outer IPv4 header and the Traffic Class field in the IPv6 header are 0.

Configuration Example

↘ Configuring the TOS of a Tunnel

Configuration Steps	<ul style="list-style-type: none"> ● Configure the TOS of a tunnel.
	<pre>FS# configure terminal FS(config)# interface tunnel 1 FS(config-if-Tunnel 1)# tunnel mode ipv6ip FS(config-if-Tunnel 1)# tunnel tos 2</pre>

Verification	<ul style="list-style-type: none"> ● Check the configuration of the tunnel interface. <pre style="background-color: #f0f0f0; padding: 10px;"> Tunnel source 1.1.1.1, destination UNKNOWN, unroutable Tunnel TOS/Traffic Class 0x2, Tunnel TTL 254 Tunnel config nested limit is 0, current nested number is 0 Tunnel protocol/transport ipv6ip Tunnel transport VPN is VPN1 </pre>
---------------------	---

9.4 Monitoring

Displaying

Description	Command
Displays the information about a tunnel interface.	show interfaces tunnel <i>number</i>

Debugging



System resources are occupied when debugging information is output. Therefore, disable debugging immediately after use.

Description	Command
Enables tunnel interface debugging.	debug tunnel

10 Configuring Network Communication Test Tools

10.1 Overview

Network communication test tools can be used to check the connectivity of a network and helps you analyze and locate network faults. Network communication test tools include Packet Internet Groper (PING) and Traceroute. Ping is used to check the connectivity and delay of a network. A greater delay indicates a slower network speed. Traceroute helps you learn about the topology of physical and logical links and transmission rate. On a network device, you can run the **ping** and **traceroute** commands to use the two tools respectively.

Protocols and Standards

- RFC792: Internet Control Message Protocol
- RFC4443: Internet Control Message Protocol (ICMPv6) for the Internet Protocol Version 6 (IPv6) Specification

10.2 Applications

Application	Description
End-to-End Connectivity Test	Both the network device and the destination host are connected to the IP network and

	configured with IP addresses.
Host Route Test	Both the network device and the destination host are connected to the IP network and configured with IP addresses.

10.2.1 End-to-End Connectivity Test

Scenario

As shown in Figure 10- 1, Network Device A and Target Host B are connected to the IP network.

If both the network device and the target host are connected to the IP network, the end-to-end connectivity test aims to check whether IP packets can be transmitted between the two ends. The target host can be the network device itself. In this case, the connectivity test aims to check the network interface and TCP/IP configurations on the device.

Figure 10- 1



Deployment

Execute the ping function on the network device.

10.2.2 Host Route Test

Scenario

As shown in Figure 10- 2, Network Device A and Target Host B are connected to the IP network.

If both the network device and the target host are connected to the IP network, the host route test aims to check gateways (or routers) that IP packets pass through between the two ends. Generally, the target host is not within the same IP network segment as the network device.

Figure 10- 2



Deployment

Execute the traceroute function on the network device.

10.3 Features

Overview

Feature	Description
Ping Test	Test whether the specified IPv4 or IPv6 address is reachable and display the related information.
Traceroute Test	Display the gateways that IPv4 or IPv6 packets pass through when transmitted from the source to the destination.

10.3.1 Ping Test

Working Principle

The ping tool sends an Internet Control Message Protocol (ICMP) Request message to the destination host to request the for an ICMP Echo Reply message. In this way, the ping tool determines the delay and the connectivity between the two network devices.

Related Configuration

- Run the **ping** command.

10.3.2 Traceroute Test



Working Principle

The traceroute tool uses the Time To Live (TTL) field in the headers of the ICMP and IP messages for the test First, the traceroute tool on the network device sends an ICMP Request message with TTL 1 to the destination host. After receiving the message, the first router on the path decreases the TTL by 1. As the TTL becomes 0, the router drops the packets and returns an ICMP time exceeded message to the network device. After receiving this message, the traceroute tool learns that this router exists on this path, and then sends an ICMP Request packet with TTL 2 to the destination host to discover the second router. Each time the traceroute tool increases the TTL in the ICMP Request message by 1 to discover one more router. This process is repeated until a data packet reaches the destination host. After the packet reaches the destination host, the host returns an ICMP Echo message instead of an ICMP time exceeded message to the network device. Then, the traceroute tool finishes the test and displays the path from the network device to the destination host.

Related Configuration

- Run the **traceroute** command.

10.4 Configuration

Configuration	Description and Command
Ping Test	 (Optional) It is used to check whether an IPv4 or IPv6 address is reachable.
	ping Executes the Ping function.
Traceroute Test	 (Optional) It is used to display the gateways that IPv4 or IPv6 packets pass through when transmitted from the source to the destination.
	traceroute Executes the traceroute function.

10.4.1 Ping Test

Configuration Effect

After conducting a ping test on a network device, you can learn whether the network device is connected to the destination host and whether packets can be transmitted between the network device and the destination host.

Notes

The network device must be configured with an IP address.

Configuration Steps

- To check whether an IPv4 address is reachable, use the **ping IPv4** command.
- To check whether an IPv6 address is reachable, use the **ping IPv6** command.

Verification

Run the **ping** command to display related information on the command line interface (CLI) window.

Related Commands

📌 **Ping IPv4**

Command	ping [oob vrf <i>vrf-name</i> ip] [<i>address</i> [via <i>mgmt-name</i>]] [length <i>length</i>] [ntimes <i>times</i>] [timeout <i>seconds</i>] [data <i>data</i>] [source <i>source</i>] [df-bit] [validate] [detail] [interval millisecond]]
Parameter Description	<p>oob: Indicates out-of-band management. This parameter must be configured if the MGMT port is specified as the source port.</p> <p><i>vrf-name</i>: Indicates the VPN routing and forwarding (VRF) name.</p> <p><i>address</i>: Specifies the destination IPv4 address or domain name.</p> <p><i>mgmt-name</i>: Specifies the MGMT port in OOB mode.</p> <p><i>length</i>: Specifies the length of the data packet. The value ranges from 36 to 18,024. The default length is 100.</p> <p><i>times</i>: Specifies the number of probes. The value ranges from 1 to 4,294,967,295</p> <p><i>seconds</i>: Specifies the timeout. The value ranges from 1s to 10s.</p> <p><i>data</i>: Specifies the data in the packet. The data is a string of 1 to 255 bytes. By default, the string is "abcd".</p> <p><i>source</i>: Specifies the source IPv4 address or source port of the packet. The loopback interface address, for example, 127.0.0.1, cannot be used as the source address.</p> <p>df-bit: Configures the DF bit of the IP address. When the DF bit is set to 1, the packet is not fragmented. By default, the DF bit is 0.</p> <p>validate: Configures whether to verify the response packet.</p> <p>detail: Configures whether to display the Echo Reply message in detail. By default, only the exclamation mark (!) and dot (.) are displayed.</p> <p>millisecond: Specifies the interval at which the ping packet is sent. The value ranges from 10 ms to 300,000 ms. The default interval is 100 ms.</p>
Command Mode	<p>In User EXEC mode, you can execute only the basic ping function. In Privileged EXEC mode, you can execute the extended ping function.</p> <p>In other configuration modes, you can run the do command to execute the extended ping function. For details about the configuration, see the description about the do command.</p>
Configuration Usage	<p>When the ping function is executed, information about the response (if any) will be displayed, and then related statistics will be output. Using the extended ping function, you can specify the number, length and timeout of packets to be sent. Like the basic ping function, related statistics will be output.</p> <p>To use the domain name, you must first configure the domain name server (DNS). For details about the configuration, see <i>Configuring DNS</i>.</p>

📌 **Ping IPv6**

Command	ping [vrf <i>vrf-name</i> [oob] ipv6] [<i>address</i> [via <i>mgmt-name</i>]] [length <i>length</i>] [ntimes <i>times</i>] [timeout <i>seconds</i>] [data <i>data</i>] [source <i>source</i>] [detail] [interval millisecond] [out-interface interface]]
Parameter Description	<p>oob: Indicates out-of-band management. This parameter must be configured if the MGMT port is specified as the source port.</p>

	<p><i>vrf-name</i>: Indicates the VRF name.</p> <p><i>address</i>: Specifies the destination IPv6 address or domain name.</p> <p><i>mgmt-name</i>: Specifies the MGMT port in OOB mode.</p> <p><i>length</i>: Specifies the length of data packet. The value ranges from 16 to 18,024. The default length is 100.</p> <p><i>times</i>: Specifies the number of probes. The value ranges from 1 to 4,294,967,295.</p> <p><i>seconds</i>: Specifies the timeout. The value ranges from 1s to 10s.</p> <p><i>data</i>: Specifies the data in the packet. The data is a string of 1 to 255 bytes.</p> <p><i>source</i>: Specifies the source IPv6 address or source port of the packet. The loopback interface address, for example, ::1, cannot be used as the source address.</p> <p>detail: Configures whether to display the Echo Reply message in detail. By default, only the exclamation mark (!) and dot (.) are displayed.</p> <p><i>millisecond</i>: Specifies the interval at which the ping packet is sent. The value ranges from 10 ms to 300,000 ms. The default interval is 100 ms.</p>
Command Mode	<p>In User EXEC mode, you can execute only the basic ping IPv6 function. In Privileged EXEC mode, you can execute the extended ping IPv6 function.</p> <p>In other configuration modes, you can run the do command to execute the extended ping function. For details about the configuration, see the description about the do command.</p>
Configuration Usage	<p>When the ping IPv6 function is executed, information about the response (if any) will be displayed, and then related statistics will be output.</p> <p>Using the extended ping IPv6 function, you can specify the number, length and timeout of packets to be sent. Like the basic ping IPv6 function, related statistics will be output.</p> <p>To use the domain name, you must first configure the DNS. For details about the configuration, see <i>Configuring DNS</i>.</p>

Configuration Example

▾ **Executing the Common Ping Function**

Configuration Steps	<p>In Privileged EXEC mode, run the ping 192.168.21.26 command.</p>
	<pre> Common ping command: FS# ping 192.168.21.26 Sending 5, 100-byte ICMP Echoes to 192.168.21.26, timeout is 2 seconds: < press Ctrl+C to break > !!!! Success rate is 100 percent (5/5), round-trip min/avg/max = 1/2/10 ms Detailed ping command: FS#ping 192.168.21.26 detail Sending 5, 100-byte ICMP Echoes to 192.168.21.26, timeout is 2 seconds: < press Ctrl+C to break > Reply from 192.168.21.26: bytes=100 time=4ms TTL=64 Reply from 192.168.21.26: bytes=100 time=3ms TTL=64 </pre>

	<pre> Reply from 192.168.21.26: bytes=100 time=1ms TTL=64 Reply from 192.168.21.26: bytes=100 time=1ms TTL=64 Reply from 192.168.21.26: bytes=100 time=1ms TTL=64 Success rate is 100 percent (5/5), round-trip min/avg/max = 1/2/4 ms. </pre>
Verification	Send five 100-byte packets to the specified IP address, and the response information will be displayed in the specified time (2s by default). Finally the statistics is output.

↘ Executing the Extended Ping Function

Configuration Steps	In Privileged EXEC mode, run the ping 192.168.21.26 command. In addition, specify the length, number, and timeout of the packets.
	<pre> Common ping command: FS# ping 192.168.21.26 length 1500 ntimes 100 data ffff source 192.168.21.99 timeout 3 Sending 100, 1500-byte ICMP Echoes to 192.168.21.26, timeout is 3 seconds: < press Ctrl+C to break > ##### Success rate is 100 percent (100/100), round-trip min/avg/max = 2/2/3 ms Detailed ping command: ping 192.168.21.26 length 1500 ntimes 20 data ffff source 192.168.21.99 timeout 3 detail Sending 20, 1500-byte ICMP Echoes to 192.168.21.26, timeout is 3 seconds: < press Ctrl+C to break > Reply from 192.168.21.26: bytes=1500 time=1 ms TTL=64 Reply from 192.168.21.26: bytes=1500 time=1 ms TTL=64 Reply from 192.168.21.26: bytes=1500 time=1 ms TTL=64 Reply from 192.168.21.26: bytes=1500 time=1 ms TTL=64 Reply from 192.168.21.26: bytes=1500 time=1 ms TTL=64 Reply from 192.168.21.26: bytes=1500 time=1 ms TTL=64 Reply from 192.168.21.26: bytes=1500 time=1 ms TTL=64 Reply from 192.168.21.26: bytes=1500 time=2ms TTL=64 Reply from 192.168.21.26: bytes=1500 time=1 ms TTL=64 Reply from 192.168.21.26: bytes=1500 time=1 ms TTL=64 Reply from 192.168.21.26: bytes=1500 time=1 ms TTL=64 Reply from 192.168.21.26: bytes=1500 time=1 ms TTL=64 Reply from 192.168.21.26: bytes=1500 time=1 ms TTL=64 Reply from 192.168.21.26: bytes=1500 time=1 ms TTL=64 </pre>

	<pre> Reply from 192.168.21.26: bytes=1500 time=1 ms TTL=64 Reply from 192.168.21.26: bytes=1500 time=1 ms TTL=64 Reply from 192.168.21.26: bytes=1500 time=1 ms TTL=64 Reply from 192.168.21.26: bytes=1500 time=3ms TTL=64 Reply from 192.168.21.26: bytes=1500 time=1 ms TTL=64 Reply from 192.168.21.26: bytes=1500 time=1 ms TTL=64 Success rate is 100 percent (20/20), round-trip min/avg/max = 1/1/3 ms. </pre>
Verification	Send twenty 1500-byte packets to the specified IP address, and the response information (if any) will be displayed in the specified time (3s by default). Finally the statistics is output.

↘ Executing the Common Ping IPv6 Function

Configuration Steps	In Privileged EXEC mode, run the ping ipv6 2001::1 command.
	<pre> Common ping command: FS# ping ipv6 2001::1 Sending 5, 100-byte ICMP Echoes to 2001::1, timeout is 2 seconds: < press Ctrl+C to break > !!!! Success rate is 100 percent (5/5), round-trip min/avg/max = 1/2/10 ms Detailed ping command: FS#ping 2001::1 detail Sending 5, 100-byte ICMP Echoes to 2001::1, timeout is 2 seconds: < press Ctrl+C to break > Reply from 2001::1: bytes=100 time=1ms Reply from 2001::1: bytes=100 time=1ms Reply from 2001::1: bytes=100 time=1ms Reply from 2001::1: bytes=100 time=1ms Reply from 2001::1: bytes=100 time=1ms Success rate is 100 percent (5/5), round-trip min/avg/max = 1/1/1 ms. </pre>
Verification	Send five 100-byte packets to the specified IP address, and the response information will be displayed in the

specified time (2s by default). Finally the statistics is output.

↘ Executing the Extended Ping IPv6 Function

Configuration Steps	In Privileged EXEC mode, run the ping ipv6 2001::5 command. In addition, specify the length, number, and timeout of the packets.
	<pre> Common ping command: FS# ping ipv6 2001::5 length 1500 ntimes 100 data ffff source 2001::9 timeout 3 Sending 100, 1500-byte ICMP Echoes to 2000::1, timeout is 3 seconds: < press Ctrl+C to break > !! Success rate is 100 percent (100/100), round-trip min/avg/max = 2/2/3 ms Detailed ping command: FS#ping 2001::5 length 1500 ntimes 10 data ffff source 2001::9 timeout 3 Sending 10, 1500-byte ICMP Echoes to 2001::5, timeout is 3 seconds: < press Ctrl+C to break > Reply from 2001::5: bytes=1500 time=1ms Reply from 2001::5: bytes=1500 time=1ms Reply from 2001::5: bytes=1500 time=1ms Reply from 2001::5: bytes=1500 time=1ms Reply from 2001::5: bytes=1500 time=1ms Reply from 2001::5: bytes=1500 time=1ms Reply from 2001::5: bytes=1500 time=1ms Reply from 2001::5: bytes=1500 time=1ms Reply from 2001::5: bytes=1500 time=1ms Reply from 2001::5: bytes=1500 time=1ms Reply from 2001::5: bytes=1500 time=1ms Reply from 2001::5: bytes=1500 time=1ms Reply from 2001::5: bytes=1500 time=1ms Success rate is 100 percent (10/10), round-trip min/avg/max = 1/1/1 ms. </pre>
Verification	Send one hundred 1500-byte packets to the specified IPv6 address, and the response information (if any) will be displayed in the specified time (3s by default). Finally the statistics is output.

10.4.2Traceroute Test

Configuration Effect

After conducting a traceroute test on a network device, you can learn about the routing topology between the network device and the destination host, and the gateways through which packets are sent from the network device to the destination host.

Notes

The network device must be configured with an IP address.

Configuration Steps

- To trace the route an IPv4 packet would follow to the destination host, run the **traceroute IPv4** command.
- To trace the route an IPv6 packet would follow to the destination host, run the **traceroute IPv6** command.

Verification

Run the **traceroute** command to display related information on the CLI window.

Related Commands

Traceroute IPv4

Command	traceroute [oob vrf <i>vrf-name</i> ip] [<i>address</i> [via <i>mgmt-name</i>] [probe <i>number</i>] [source <i>source</i>] [timeout <i>seconds</i>] [tll <i>minimum maximum</i>]]
Parameter Description	<p>oob: Indicates out-of-band management. This parameter must be configured if the MGMT port is specified as the source port.</p> <p><i>vrf-name</i>: Indicates the VRF name.</p> <p><i>address</i>: Specifies the destination IPv4 address or domain name.</p> <p><i>mgmt-name</i>: Specifies the MGMT port in OOB mode.</p> <p><i>number</i>: Specifies the number of probes. The value ranges from 1 to 255.</p> <p><i>source</i>: Specifies the source IPv4 address or source port of the packet. The loopback interface address, for example, 127.0.0.1, cannot be used as the source address.</p> <p><i>seconds</i>: Specifies the timeout. The value ranges from 1s to 10s.</p> <p><i>minimum maximum</i>: Specifies the minimum and maximum TTL values. The value ranges from 1 to 255.</p>
Command Mode	In User EXEC mode, you can execute only the basic traceroute function. In privileged EXEC mode, you can execute the extended traceroute function.
Configuration Usage	The traceroute command is used to test the network connectivity and accurately locate a fault when the fault occurs. To use the domain name, you must first configure the DNS. For details about the configuration, see <i>Configuring DNS</i> .

Traceroute IPv6

Command	traceroute [vrf <i>vrf-name</i> [oob] ipv6] [<i>address</i> [via <i>mgmt-name</i>] [probe <i>number</i>] [timeout <i>seconds</i>] [tll <i>minimum maximum</i>]
Parameter Description	<p>oob: Indicates out-of-band management. This parameter must be configured if the MGMT port is specified as a source port.</p> <p><i>vrf-name</i>: Indicates the VRF name.</p> <p><i>address</i>: Specifies the destination IPv6 address or domain name.</p> <p><i>mgmt-name</i>: Specifies the MGMT port in OOB mode.</p> <p><i>number</i>: Specifies the number of probes. The value ranges from 1 to 255.</p> <p><i>seconds</i>: Specifies the timeout. The value ranges from 1s to 10s.</p> <p><i>minimum maximum</i>: Specifies the minimum and maximum TTL values. The value ranges from 1 to 255.</p>
Command Mode	In User EXEC mode, you can execute only the basic traceroute IPv6 function. In privileged EXEC mode, you can execute the extended traceroute IPv6 function.
Configuration	The traceroute IPv6 command is used to test the network connectivity and accurately locate a fault when the fault

Usage	occurs. To use the domain name, you must first configure the DNS. For details about the configuration, see <i>Configuring DNS</i> .
--------------	---

Configuration Example

↘ **Executing the Traceroute Function on a Properly Connected Network**

Configuration Steps	In Privileged EXEC mode, run the traceroute 2002::1 command.
	<pre> FS# FS# traceroute ipv6 3004::1 < press Ctrl+C to break > Tracing the route to 3004::1 1 3000::1 0 msec 0 msec 0 msec 2 3001::1 4 msec 4 msec 4 msec 3 3002::1 8 msec 8 msec 4 msec </pre>
	The preceding test result indicates that the network device accesses host 2002::1 by transmitting packets through gateways 1–3. In addition, the time required to reach each gateway is displayed.

↘ **Executing the Traceroute Function on a Faulty Network**

Configuration Steps	In Privileged EXEC mode, run the traceroute 202.108.37.42 command.
----------------------------	---

<pre> FS# traceroute 202.108.37.42 < press Ctrl+C to break > Tracing the route to 202.108.37.42 1 192.168.12.1 0 msec 0 msec 0 msec 2 192.168.9.2 0 msec 4 msec 4 msec 3 192.168.110.1 16 msec 12 msec 16 msec 4 * * * 5 61.154.8.129 12 msec 28 msec 12 msec 6 61.154.8.17 8 msec 12 msec 16 msec 7 61.154.8.250 12 msec 12 msec 12 msec 8 218.85.157.222 12 msec 12 msec 12 msec 9 218.85.157.130 16 msec 16 msec 16 msec 10 218.85.157.77 16 msec 48 msec 16 msec 11 202.97.40.65 76 msec 24 msec 24 msec 12 202.97.37.65 32 msec 24 msec 24 msec 13 202.97.38.162 52 msec 52 msec 224 msec 14 202.96.12.38 84 msec 52 msec 52 msec 15 202.106.192.226 88 msec 52 msec 52 msec 16 202.106.192.174 52 msec 52 msec 88 msec 17 210.74.176.158 100 msec 52 msec 84 msec 18 202.108.37.42 48 msec 48 msec 52 msec </pre>	<p>The preceding test result indicates that the network device accesses host 202.108.37.42 by transmitting packets through gateways 1–17, and Gateway 4 is faulty.</p>
--	--

↘ Executing the Traceroute IPv6 Function on a Properly Connected Network

<p>Configuration Steps</p>	<p>In Privileged EXEC mode, run the traceroute ipv6 3004::1 command.</p>
<pre> FS# traceroute ipv6 3004::1 < press Ctrl+C to break > Tracing the route to 3004::1 1 3000::1 0 msec 0 msec 0 msec 2 3001::1 4 msec 4 msec 4 msec 3 3002::1 8 msec 8 msec 4 msec 4 3004::1 4 msec 28 msec 12 msec </pre>	

The preceding test result indicates that the network device accesses host 3004::1 by transmitting packets through gateways 1-4. In addition, the time required to reach each gateway is displayed.

↘ Executing the Traceroute IPv6 Function on a Faulty Network

Configuration Steps	In Privileged EXEC mode, run the traceroute ipv6 3004::1 command.
	<pre> FS# traceroute ipv6 3004::1 < press Ctrl+C to break > Tracing the route to 3004::1 1 3000::1 0 msec 0 msec 0 msec 2 3001::1 4 msec 4 msec 4 msec 3 3002::1 8 msec 8 msec 4 msec 4 * * * 5 3004::1 4 msec 28 msec 12 msec </pre>
	The preceding test result indicates that the network device accesses host 3004::1 by transmitting packets through gateways 1–5, and Gateway 4 is faulty.

11 Configuring TCP

11.1 Overview

The Transmission Control Protocol (TCP) is a transport-layer protocol providing reliable connection-oriented and IP-based services to for the application layer.

Internetwork data flows in 8-bit bytes are sent from the application layer to the TCP layer, and then fragmented into packet segments of a proper length via the TCP. The Maximum Segment Size (MSS) is usually limited by the Maximum Transmission Unit (MTU) of the data link layer. After that, the packets are sent to the IP layer and then to the TCP layer of a receiver through the network.

To prevent packet loss, every byte is identified by a sequence number via the TCP, and this ensures that packets destined for the peer are received in order. Then, the receiver responds with a TCP ACK packet upon receiving a packet. If the sender does not receive ACK packets in a reasonable Round-Trip Time (RTT), the corresponding packets (assumed lost) will be retransmitted.

- TCP uses the checksum function to check data integrity. Besides, MD5-based authentication can be used to verify data.
- Timeout retransmission and piggyback mechanism are adopted to ensure reliability.
- The Sliding Window Protocol is adopted to control flows. As documented in the Protocol, unidentified groups in a window should be retransmitted.

Protocols and Standards

- RFC 793: Transmission Control Protocol
- RFC 1122: Requirements for Internet Hosts -- Communication Layers
- RFC 1191: Path MTU Discovery
- RFC 1213: Management Information Base for Network Management of TCP/IP-based Internets: MIB-II

- RFC 2385: Protection of BGP Sessions via the TCP MD5 Signature Option
- RFC 4022: Management Information Base for the Transmission Control Protocol (TCP)

11.2 Applications

Application	Description
Optimizing TCP Performance	To avoid TCP packet fragmentation on a link with a small MTU, Path MTU Discovery (PMTUD) is enabled.
Detecting TCP Connection Exception	TCP checks whether the peer works normally.

11.2.1 Optimizing TCP Performance

Scenario

For example, TCP connection is established between A and D, as shown in the following figure. The MTU of the link between A and B is 1500 bytes, 1300 bytes between B and C, and 1500 bytes between C and D. To optimize TCP transmission performance, packet fragmentation should be avoided between B and C.

Figure 11- 1



Remarks:	A, B, C and D are routers.
-----------------	----------------------------

Deployment

- Enable PMTUD on A and D.

11.2.2 Detecting TCP Connection Exception

Scenario

For example, in the following figure, User logs in to A through telnet but is shut down abnormally, as shown in the following figure. In case of TCP retransmission timeout, the User's TCP connection remains for a long period. Therefore, TCP keepalive can be used to rapidly detect TCP connection exception.

Figure 11- 2

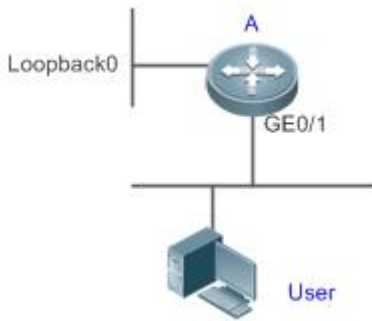

Remarks: A is a router.

Deployment

- Enable TCP keepalive on A.

11.3Features

Basic Concepts

▾ **TCP Header Format**



- **Source Port** is a 16-bit source port number.
- **Destination Port** is a 16-bit destination port number.
- **Sequence Number** is a 32-bit sequence number.
- **Acknowledgment Number** is a 32-bit number that identifies the next sequence number that the receiver is expecting to receive.
- **Data Offset** is a 4-bit number that indicates the total number of bytes in the TCP header (option included) divided by 4.
- A flag bit is 6-bit. URG: the urgent pointer field is significant; ACK: the acknowledgment field is significant; PSH: indicates the push function; RST: resets TCP connection; SYN: synchronizes the sequence number (establishing a TCP connection); FIN: no more data from the sender (closing a TCP connection).
- A 16-bit Window value is used to control flows. It specifies the amount of data that may be transmitted from the peer between ACK packets.
- **Checksum** is a 16-bit checksum.
- **Urgent Pointer** is 16-bit and shows the end of the urgent data so that interrupted data flows can continue. When the URG bit is set, the data is given priority over other data flows.

➤ **TCP Three-Way Handshake**

- The process of TCP three-way handshake is as follows:
 23. A client sends a SYN packet to the server.
 24. The server receives the SYN packet and responds with a SYN ACK packet.
 25. The client receives the SYN packet from the server and responds with an ACK packet.
- After the three-way handshake, the client and server are connected successfully and ready for data transmission.

Overview

Feature	Description
Configuring SYN Timeout	Configure a timeout waiting for a response packet after an SYN or SYN ACK packet is sent.
Configuring Window Size	Configure a window size.
Configuring Reset Packet Sending	Configure the sending of TCP reset packets after receiving port unreachable messages.
Configuring MSS	Configure an MSS for TCP connection.
Path MTU Discovery	Discover the smallest MTU on TCP transmission path, and adjust the size of TCP packets based on this MTU to avoid fragmentation.
TCP Keepalive	Check whether the peer works normally.

11.3.1 Configuring SYN Timeout

Working Principle

A TCP connection is established after three-way handshake: The sender sends an SYN packet, the receiver replies with a SYN ACK packet, and then the sender replies with an ACK packet.

- If the receiver does not reply with a SYN ACK packet after the sender sends an SYN packet, the sender keeps retransmitting the SYN packet for certain times or until timeout period expires.

- If the receiver replies with a SYN ACK packet after the sender sends an SYN packet but the sender does not reply with an ACK packet, the receiver keeps retransmitting the SYN ACK packet for certain times or until timeout period expires. (This occurs in the case of SYN flooding.)

Related Configuration

↘ **Configuring TCP SYN Timeout**

- The default TCP SYN timeout is 20 seconds.
 - Run the **ip tcp synwait-time** *seconds* command in global configuration mode to configure an SYN timeout ranging from 5 to 300 seconds.
 - In case of SYN flooding, shortening SYN timeout reduces resource consumption. However, it does not work in continuous SYN flooding. When a device actively makes a request for a connection with an external device, through telnet for example, shortening SYN timeout reduces user's wait time. You may prolong SYN timeout properly on a poor network.
-  In version 11.0 or later, it applies to both IPv4 TCP and IPv6 TCP.

11.3.2 Configuring Window Size

Working Principle

Data from the peer is cached in the TCP receiving buffer and subsequently read by applications. The TCP window size indicates the size of free space of the receiving buffer. For wide-bandwidth bulk-data connection, enlarging the window size dramatically promotes TCP transmission performance.

Related Configuration

↘ **Configuring Window Size**

- Run the **ip tcp window-size** *size* command in global configuration mode to configure a window size ranging from 128 to (65535<< 14) bytes. The default is 65535 bytes. If the window size is greater than 65535 bytes, window enlarging will be enabled automatically.
 - The window size advertised to the peer is the smaller value between the configured window size and the free space of the receiving buffer.
-  In version 11.0 or later, it applies to both IPv4 TCP and IPv6 TCP.

11.3.3 Configuring Reset Packet Sending

Working Principle

When TCP packets are distributed to applications, if the TCP connection a packet belongs to cannot be identified, the local end sends a reset packet to the peer to terminate the TCP connection. Attackers may use port unreachable messages to attack the device.

Related Configuration

↘ **Configuring the Sending of TCP Reset Packets After Receiving Port Unreachable Messages**

By default, TCP reset packet sending upon receiving port unreachable messages is enabled.

Run the **no ip tcp send-reset** command in global configuration mode to disable TCP reset packet sending upon receiving port unreachable messages.

After this function is enabled, attackers may use port unreachable messages to attack the device.

 In version 11.0 or later, it applies to both IPv4 TCP and IPv6 TCP.

11.3.4 Configuring MSS

Working Principle

The MSS refers to the total amount of data contained in a TCP segment excluding TCP options.

Three-way handshake is implemented through MSS negotiation. Both parties add the MSS option to SYN packets, indicating the largest amount of data that the local end can handle, namely, the amount of data allowed from the peer. Both parties take the smaller MSS between them as the advertised MSS.

The MSS value is calculated as follows:

- IPv4 TCP: $MSS = \text{Outgoing interface MTU} - \text{IP header size (20-byte)} - \text{TCP header size (20-byte)}$.

- IPv6 TCP: $MSS = \text{IPv6 Path MTU} - \text{IPv6 header size (40-byte)} - \text{TCP header size (20-byte)}$.

 In version 11.0 or later, it applies to both IPv4 TCP and IPv6 TCP.

 The effective MSS is the smaller one between the calculated MSS and the configured MSS.

 If a connection supports certain options, the option length (with **data offset** taken into consideration) should be deducted from an MSS value. For example, 20 bytes for MD5 digest (with **data offset** taken into consideration) should be subtracted from the MSS.

Related Configuration

Configuring MSS

- Run the **ip tcp mss max-segment-size** command in global configuration mode to set an MSS. It ranges from 68 to 1000 bytes. By default, the MSS is calculated based on MTU. If an MSS is configured, the effective MSS is the smaller one between the calculated MSS and the configured MSS.

- An excessively small MSS reduces transmission performance. You can promote TCP transmission by increasing the MSS. Choose an MSS value by referring to the interface MTU. If the former is bigger, TCP packets will be fragmented and transmission performance will be reduced.

11.3.5 Path MTU Discovery

Working Principle

The Path MTU Discovery stipulated in RFC1191 is used to discover the smallest MTU in a TCP path to avoid fragmentation, enhancing network bandwidth utilization. The process of TCPv4 Path MTU Discovery is described as follows:

1. The source sends TCP packets with the Don't Fragment (DF) bit set in the outer IP header.
2. If the outgoing interface MTU value of a router in the TCP path is smaller than the IP packet length, the packet will be discarded and an ICMP error packet carrying this MTU will be sent to the source.
3. Through parsing the ICMP error packet, the source knows the smallest MTU in the path (path MTU) is.
4. The size of subsequent data segments sent by the source will not surpass the MSS, which is calculated as follows: $\text{TCP MSS} = \text{Path MTU} - \text{IP header size} - \text{TCP header size}$.

Related Configuration

↳ Enabling Path MTU Discovery

By default, Path MTU Discovery is disabled.

Run the **ip tcp path-mtu-discovery** command to enable PMTUD in global configuration mode.

In version 11.0 or later, it applies to only IPv4 TCP. TCPv6 PMTUD is enabled permanently and cannot be disabled.

11.3.6TCP Keepalive

Working Principle

You may enable TCP keepalive to check whether the peer works normally. If a TCP end does not send packets to the other end for a period of time (namely idle period), the latter starts sending keepalive packets successively to the former for several times. If no response packet is received, the TCP connection is considered inactive and then closed.

Related Configuration

↳ Enabling Keepalive

- By default, TCP keepalive is disabled.

- Run the **ip tcp keepalive [interval num1] [times num2] [idle-period num3]** command to in global configuration mode to enable TCP keepalive. See **Configuration** for parameter description.

In version 11.0 or later, it applies to both IPv4 TCP and IPv6 TCP.

This command applies to both TCP server and client.

11.4Configuration

Configuration	Description and Command	
Optimizing TCP Performance	(Optional) It is used to optimize TCP connection performance.	
	ip tcp synwait-time	Configures a timeout for TCP connection.
	ip tcp window-size	Configures a TCP window size.
	ip tcp send-reset	Configures the sending of TCP reset packets after receiving port unreachable messages.
	ip tcp mss	Configures an MSS for TCP connection.
Detecting TCP Connection Exception	(Optional) It is used to detect whether the peer works normally.	
	ip tcp keepalive	Enables TCP keepalive.

11.4.1Optimizing TCP Performance

Configuration Effect

- Ensure optimal TCP performance and prevent fragmentation.

Notes

N/A

Configuration Steps

➤ **Configuring SYN Timeout**

- Optional.
- Configure this on the both ends of TCP connection.

➤ **Configuring TCP Window Size**

- Optional.
- Configure this on the both ends of TCP connection.

➤ **Configuring the Sending of TCP Reset Packets After Receiving Port Unreachable Messages.**

- Optional.
- Configure this on the both ends of TCP connection.

➤ **Configuring MSS**

- Optional.
- Configure this on the both ends of TCP connection.

➤ **Enabling Path MTU Discovery**

- Optional.
- Configure this on the both ends of TCP connection.

Verification

N/A

Related Commands

➤ **Configuring SYN Timeout**

Command	ip tcp synwait-time <i>seconds</i>
Parameter Description	<i>seconds</i> : Indicates SYN packet timeout. It ranges from 5 to 300 seconds. The default is 20 seconds.
Command Mode	Global configuration mode
Usage Guide	In case of SYN flooding, shortening SYN timeout reduces resource consumption. However, it does not work in continuous SYN flooding. When a device actively makes a request for a connection with an external device, through telnet for example, shortening SYN timeout reduces user's wait time. You may prolong SYN timeout properly on a poor network.

➤ **Configuring TCP Window Size**

Command	ip tcp window-size <i>size</i>
Parameter	<i>size</i> : Indicates a TCP window size. It ranges from 128 to (65535 << 14) bytes. The default is 65535 bytes.

Description	
Command	Global configuration mode
Mode	
Usage Guide	N/A

↘ Configuring the Sending of TCP Reset Packets After Receiving Port Unreachable Messages

Command	ip tcp send-reset
Parameter	N/A
Description	
Command	Global configuration mode
Mode	
Usage Guide	By default, TCP reset packet sending upon receiving port unreachable messages is enabled.

↘ Configuring MSS

Command	ip tcp mss <i>max-segment-size</i>
Parameter	<i>max-segment-size</i> : Indicates the maximum segment size. It ranges from 68 to 10000 bytes. By default, the MSS is calculated based on MTU.
Description	
Command	Global configuration mode
Mode	
Usage Guide	This command defines the MSS for a TCP communication to be established. The negotiated MSS for a new connection should be smaller than this MSS. If you want to reduce the MSS, run this command. Otherwise, do not perform the configuration.

↘ Configuring Path MTU Discovery

Command	ip tcp path-mtu-discovery [age-timer <i>minutes</i> age-timer infinite]
Parameter	age-timer <i>minutes</i> : Indicates the interval for a new probe after a path MTU is discovered. It ranges from 10 to 30 minutes. The default is 10 minutes.
Description	age-timer infinite : No probe is implemented after a path MTU is discovered.
Command	Global configuration mode
Mode	
Usage Guide	The PMTUD is an algorithm documented in RFC1191 aimed to improve bandwidth utilization. When the TCP is applied to bulk data transmission, this function may facilitate transmission performance. If the MSS used for the connection is smaller than what the peer connection can handle, a larger MSS is tried every time the age timer expires. The age timer is a time interval for how often TCP estimates the path MTU with a larger MSS. The discovery process is stopped when either the send MSS is as large as the peer negotiated, or the user has disabled the timer on the router. You may turn off the timer by setting it to infinite .

Configuration Example

↘ Enabling Path MTU Discovery

Configuration Steps	Enable PMTUD for a TCP connection. Adopt the default age timer settings.
----------------------------	--

	<pre>FS# configure terminal FS(config)# ip tcp path-mtu-discovery FS(config)# end</pre>
Verification	Run the show tcp pmtu command to display the IPv4 TCP PMTU.
	<pre>FS# show tcp pmtu Number Local Address Foreign Address PMTU 1 192.168.195.212.23 192.168.195.112.13560 1440</pre>
	Run the show ipv6 tcp pmtu command to display the IPv6 TCP PMTU.
	<pre>FS# show ipv6 tcp pmtu Number Local Address Foreign Address PMTU 1 1000::1:23 1000::2.13560 1440</pre>

Common Errors

N/A

11.4.2 Detecting TCP Connection Exception

Configuration Effect

- Check whether the peer works normally.

Notes

N/A

Configuration Steps

↳ Enabling TCP Keepalive

- Optional.

Verification

N/A

Related Commands

↳ Enabling TCP Keepalive

Command	ip tcp keepalive [interval num1] [times num2] [idle-period num3]
Parameter Description	<p>interval num1: Indicates the interval to send keepalive packets. Ranging from 1 to 120 seconds. The default is 75 seconds.</p> <p>times num2: Indicates the maximum times for sending keepalive packets. It ranges from 1 to 10. The default is 6.</p> <p>idle-period num3: Indicates the time when the peer sends no packets to the local end, It ranges from 60 to 1800 seconds. The default is 15 minutes.</p>

Command Mode	Global configuration mode
Usage Guide	You may enable TCP keepalive to check whether the peer works normally. The function is disabled by default. Suppose a user enables TCP keepalive function with the default interval, times and idle period settings. The user does not receive packets from the other end within 15 minutes and then starts sending Keepalive packets every 75 seconds for 6 times. If the user receives no TCP packets, the TCP connection is considered inactive and then closed.

Configuration Example

📌 **Enabling TCP Keepalive**

Configuration Steps	Enable TCP keepalive on a device with interval and idle-period set to 3 minutes and 60 seconds respectively. If the user receives no TCP packets from the other end after sending keepalive packets four times, the TCP connection is considered inactive.
	<pre>FS# configure terminal FS(config)# ip tcp keepalive interval 60 times 4 idle-period 180 FS(config)# end</pre>
Verification	A user logs in to a device through telnet, and then shuts down the local device. Run the show tcp connect command on the remote device to observe when IPv4 TCP connection is deleted.

Common Errors

N/A

11.5 Monitoring

Displaying

Description	Command
Displays basic information on IPv4 TCP connection.	show tcp connect [local-ip <i>a.b.c.d</i>] [local-port <i>num</i>] [peer-ip <i>a.b.c.d</i>] [peer-port <i>num</i>]
Displays IPv4 TCP connection statistics.	show tcp connect statistics
Displays IPv4 TCP PMTU.	show tcp pmtu [local-ip <i>a.b.c.d</i>] [local-port <i>num</i>] [peer-ip <i>a.b.c.d</i>] [peer-port <i>num</i>]
Displays IPv4 TCP port information.	show tcp port [<i>num</i>]
Displays IPv4 TCP parameters.	show tcp parameter
Displays IPv4 TCP statistics.	show tcp statistics
Displays basic information on IPv6 TCP connection.	show ipv6 tcp connect [local-ipv6 <i>X:X:X::X</i>] [local-port <i>num</i>] [peer-ipv6 <i>X:X:X::X</i>] [peer-port <i>num</i>]
Displays IPv6 TCP connection statistics.	show ipv6 tcp connect statistics
Displays IPv6 TCP PMTU.	show ipv6 tcp pmtu [local-ipv6 <i>X:X:X::X</i>] [local-port <i>num</i>] [peer-ipv6 <i>X:X:X::X</i>] [peer-port <i>num</i>]
Displays IPv6 TCP port information.	show ipv6 tcp port [<i>num</i>]

Debugging



System resources are occupied when debugging information is output. Therefore, disable debugging immediately after use.

Description	Command
Displays the debugging information on IPv4 TCP packets.	debug ip tcp packet [in out] [local-ip a.b.c.d] [peer-ip a.b.c.d] [global vrf vrf-name] [local-port num] [peer-port num] [deeply]
Displays the debugging information on IPv4 TCP connection.	debug ip tcp transactions [local-ip a.b.c.d] [peer-ip a.b.c.d] [local-port num] [peer-port num]
Displays the debugging information on IPv6 TCP packets.	debug ipv6 tcp packet [in out] [local-ipv6 X:X:X::X] [peer-ipv6 X:X:X::X] [global vrf vrf-name] [local-port num] [peer-port num] [deeply]
Displays the debugging information on IPv6 TCP connection.	debug ipv6 tcp transactions [local-ipv6 X:X:X::X] [peer-ipv6 X:X:X::X] [local-port num] [peer-port num]

12 Configuring IPv4/IPv6 REF

12.1 Overview

On products incapable of hardware-based forwarding, IPv4/IPv6 packets are forwarded through the software. To optimize the software-based forwarding performance, FS introduces IPv4/IPv6 express forwarding through software (FS Express Forwarding, namely REF).

REF maintains two tables: forwarding table and adjacency table. The forwarding table is used to store route information. The adjacency table is derived from the ARP table and IPv6 neighbor table, and it contains Layer 2 rewrite(MAC) information for the next hop..

REF is used to actively resolve next hops and implement load balancing.

Protocols and Standards

N/A

12.2 Applications

Application	Description
Load Balancing	During network routing, when a route prefix is associated with multiple next hops, REF can implement load balancing among the multiple next hops.

12.2.1 Load Balancing

Scenario

As shown in Figure12-1, a route prefix is associated with three next hops on router A, namely, link 1, link 2, and link 3. By default, REF implements load balancing based on the destination IP address. Load balancing can be implemented based on the source IP address and destination IP address as well.

Figure 12- 1

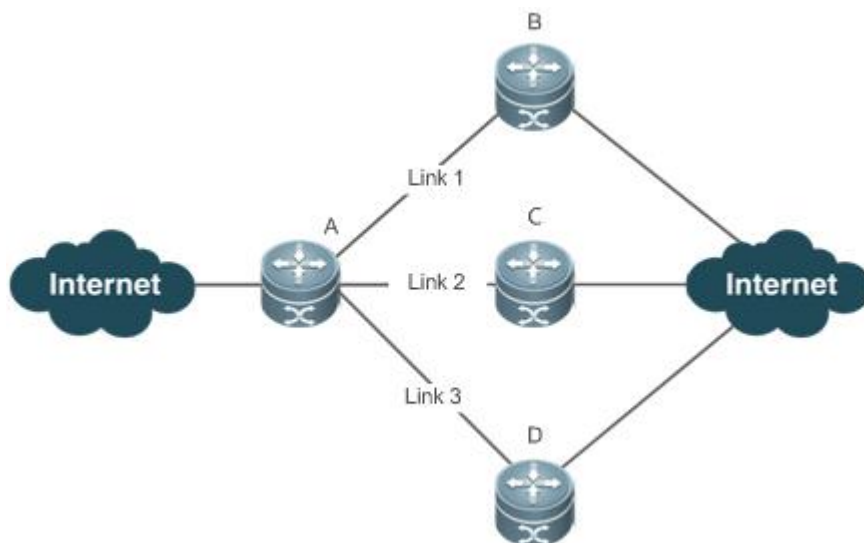

Remarks	A is a router that runs REF. B, C and D are forwarding devices.
----------------	--

Deployment

- Run REF on router A.

12.3Features

Basic Concepts

IPv4/IPv6 REF involves the following basic concepts:

➤ **Routing table**

An IPv4/IPv6 routing table stores routes to the specific destinations and contains the topology information. During packet forwarding, IPv4/IPv6 REF selects packet transmission paths based on the routing table.

➤ **Adjacent node**

An adjacent node contains output interface information about routed packets, for example, the next hop, the next component to be processed, and the link layer encapsulation. When a packet is matched with an adjacent node, the packet is directly encapsulated and then forwarded. For the sake of query and update, an adjacent node table is often organized into a hash table. To support routing load balancing, the next hop information is organized into a load balance entry. An adjacent node may not contain next hop information. It may contain indexes of next components (such as other line cards and multi-service cards) to be processed.

➤ **Active resolution**

REF supports next hop resolution. If the MAC address of the next hop is unknown, REF will actively resolve the next hop. IPv4 REF requests the ARP module for next hop resolution while IPv6 REF applies the ND module to resolution.

➤ **Packet forwarding path**

Packets are forwarded based on their IPv4/IPv6 addresses. If the source and destination IPv4/IPv6 addresses of a packet are specified, the forwarding path of this packet is determined.

12.3.1 Load Balancing Policies

Load balancing is configured to distribute traffic load among multiple network links.

Working Principle

So far, the switch supports two load balancing policies based on destination IP addresses. In the REF model, a route prefix is associated with multiple next hops, in other words, it is a multi-path route. The route will be associated with a load balance table and implement weight-based load balancing. When an IPv4/IPv6 packet is matched with a load balance entry based on the longest prefix match, REF performs hash calculation based on the IPv4/IPv6 address of the packet and selects a path to forward the packet.

12.4 Configuration

By default, the switch supports destination address-based load balancing. Run the following commands for monitoring.

Displaying REF Packet Statistics

REF packet statistics includes the number of forwarded packets and the number of packets discarded due to various causes. You can determine whether packets are forwarded as expected by displaying and clearing REF packet statistics.

Command	Description
show ip ref packet statistics	Displays IPv4 REF packet statistics.
clear ip ref packet statistics	Clears IPv4 REF packet statistics.
show ipv6 ref packet statistics	Displays IPv6 REF packet statistics.
clear ipv6 ref packet statistics	Clears IPv6 REF packet statistics.

Displaying Adjacency Information

You can run the following commands to display adjacency information:

Command	Description
show ip ref adjacency [glean local ip-address {interface interface_type interface_number} discard statistics]	Displays the gleaned adjacencies, local adjacencies, adjacencies of a specified IP address, adjacencies associated with a specified interface, and all adjacent nodes in IPv4 REF.
show ipv6 ref adjacency [glean local ipv6-address (interface interface_type interface_number) discard statistics]	Displays the gleaned adjacencies, local adjacencies, adjacencies of a specified IPv6 address, adjacencies associated with a specified interface, and all adjacent nodes in IPv6 REF.

Displaying Active Resolution Information

You can run the following commands to display next hops to be resolved:

Command	Description
show ip ref resolve-list	Displays the next hop to be resolved .
show ipv6 ref resolve-list	Displays the next hop to be resolved.

Displaying Packet Forwarding Path Information

Packets are forwarded based on their IPv4/IPv6 addresses. If the source and destination IPv4/IPv6 addresses of a packet are specified, the forwarding path of this packet is determined. Run the following commands and specify the IPv4/IPv6 source and destination addresses of a packet. The forwarding path of the packet is displayed, for example, the packet is discarded, submitted to a CPU, or forwarded. Furthermore, the interface that forwards the packet is displayed.

Command	Description
<code>show ip ref exact-route [oob vrf vrf_name] source-ipaddress dest-ipaddress</code>	Displays the forwarding path of a packet. oob indicates out-of-band management network. oob indicates out-of-band management network.
<code>show ipv6 ref exact-route [oob vrf vrf-name] src-ipv6-address dst-ipv6-address</code>	Displays the forwarding path of an IPv6 packet. oob indicates out-of-band, management network. oob indicates out-of-band management network.

Displaying Route Information in an REF Table

Run the following commands to display the route information in an REF table:

Command	Description
<code>show ip ref route [oob vrf vrf_name] [default {ip mask} statistics]</code>	Displays route information in the IPv4 REF table. The parameter default indicates a default route. oob indicates out-of-band management network.
<code>show ipv6 ref route [oob vrf vrf-name] [default statistics prefix/len]</code>	Displays route information in the IPv6 REF table. The parameter default indicates a default route. oob indicates out-of-band management network.

13 Configuring ECMP CLUSTER

13.1 Overview

Equal Cost Multipath (ECMP)-CLUSTER is a technology for implementing load balancing when the next-hop path of ECMP changes.

A load balancing cluster in a data center is usually interconnected to a Top of Rack (TOR) device via ECMP, and the TOR device distributes data traffic in a balanced way to members of the load balancing cluster via ECMP.

If an ECMP route is generated between the TOR device and the load balancing cluster through a dynamic routing protocol, the dynamic routing protocol enables route re-convergence when a link of the ECMP route fails. The traffic from the TOR device to the load balancing cluster is re-balanced, which disturbs the original session status of members in the cluster. As a result, the entire cluster needs to re-establish sessions, causing interruption of some sessions.

ECMP-CLUSTER overcomes traffic re-balancing caused by changes in the ECMP path quantity. After ECMP-CLUSTER is configured, if ECMP paths decrease, only traffic carried on a failed link is balanced to active links and original traffic carried on the active links keep unchanged. If ECMP paths increase, some traffic carried on the active links is distributed to the new links.

When the next hop of ECMP is session-sensitive, that is, the next-hop egress of traffic is a terminal serving device (such as a server), ECMP-CLUSTER is recommended. If the next-hop egress is an intermediate network node, ECMP-CLUSTER is not advantageous.

13.2 Applications

Application	Description
Interconnecting LVS Load Balancing Cluster to TOR Device Via ECMP	The TOR device is interconnected to a session-sensitive server via ECMP.

13.2.1 Interconnecting LVS Load Balancing Cluster to TOR Device Via ECMP

Scenario

As shown in Figure 13- 1, the TOR device is interconnected to the Linux Virtual Server (LVS) load balancing cluster via ECMP.

Figure 13- 1 Interconnection Between TOR Device and LVS Load Balancing Cluster via ECMP

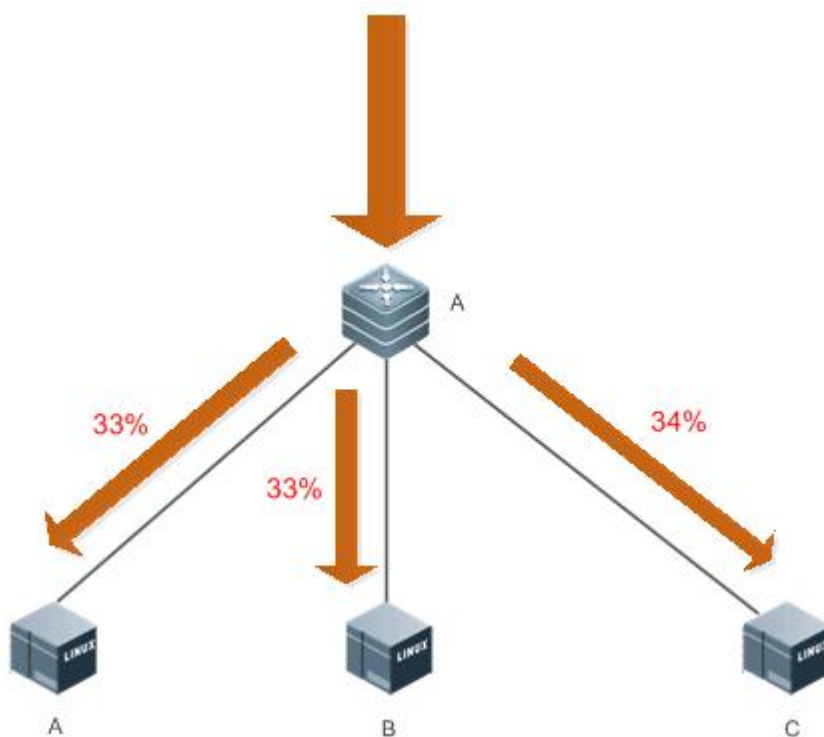

When the link between Device A and Device C fails, the traffic is forwarded as shown in Figure 13- 2.

Figure 13- 2 Traffic Forwarding

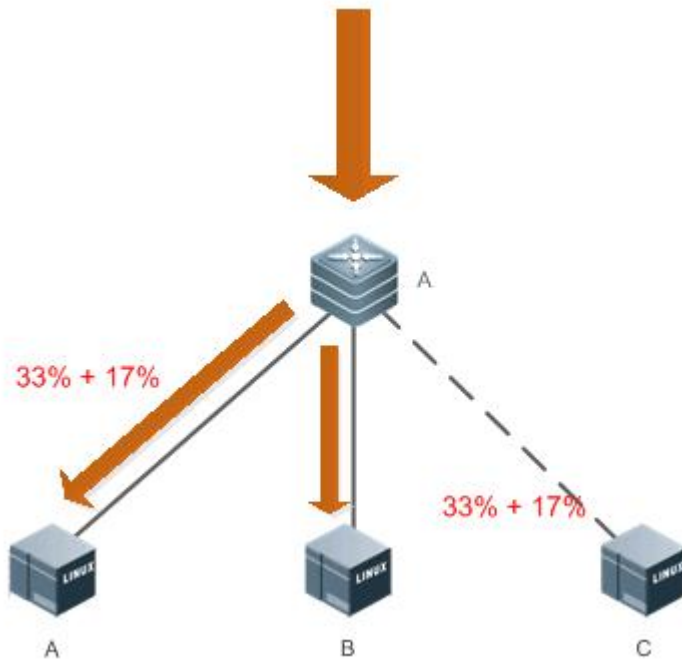

i A is a TOR device, and B, C, and D are members of a load balancing cluster.

Deployment

- Run the Open Shortest Path First (OSPF) protocol between the TOR device and members of a load balancing cluster, to implement multipath routing.
- Enable ECMP-CLUSTER on the TOR device.

13.3 Features

Basic Concepts

↘ ECMP Routing

There are multiple routes to a next hop destined for the destination network, for example, the IP address of the destination network is 192.168.0.0/24, and the IP addresses of routers to the next hop include 1.1.1.1, 2.2.2.2, and 3.3.3.3.

Overview

Feature	Description
ECMP_CLUSTER	When the next-hop link of an ECMP route changes, maintain load balancing and evenly distributes traffic carried by a failed link to other active links while keeping original traffic carried by the active links unchanged.

Working Principle

Keep the modulo of the hash function used in route calculation unchanged during ECMP routing of packets. Ensure that the total number of next hops remains unchanged during ECMP hardware routing and when a next-hop link of an ECMP route fails, an active link is used to replace the failed link.

13.4 Configuration

Configuration	Description and Command	
Configuring ECMP-CLUSTER	 (Mandatory) It is used to enable ECMP-CLUSTER.	
	<table border="1"> <tr> <td>ecmp cluster enable</td> <td>Enables ECMP-CLUSTER.</td> </tr> </table>	ecmp cluster enable
ecmp cluster enable	Enables ECMP-CLUSTER.	

13.4.1 Configuring ECMP-CLUSTER

Configuration Effect

- Increase or decrease ECMP next hops to minimize impact of original forwarded traffic after ECMP-CLUSTER is enabled.

Notes

- ECMP-CLUSTER is effective to ECMP. Therefore, ECMP must be configured on the network.
- VSU scenario limitation: it requires active-standby NIC, or the ECMP egress is connected with an AP which is up both on the active and standby device.
- ECMP CLUSTER only supports one port to be shut down. When the port is up, the balancing mode does not change.

Configuration Steps

▾ Enabling ECMP-CLUSTER

- Mandatory.

Command	ecmp cluster enable
Parameter Description	N/A
Defaults	ECMP-CLUSTER is disabled by default.
Command Mode	Global configuration mode
Usage Guide	Run the no form of this command to disable ECMP-CLUSTER: no ecmp cluster enable .

Verification

- After ECMP-CLUSTER is enabled, check whether traffic forwarded by multiple paths is balanced.
- After a link fails, check whether traffic carried by the failed link is balanced to other active links, and whether original traffic carried by the active links keeps unchanged.

Configuration Examples

- Enable ECMP-CLUSTER on a device and check whether the function is enabled successfully.

```
FS(config)#ecmp cluster enable
FS(config)#show run | in ecmp
ecmp cluster enable
FS(config)#
```

13.5 Monitoring

Displaying

Description	Command
Displays whether ECMP-CLUSTER is enabled.	show run

IP Routing Configuration

1. Configuring Routing Policies
2. Configuring Keys
3. Configuring RIP
4. Configuring OSPFv2
5. Configuring OSPFv3
6. Configuring IS-IS
7. Configuring BGP
8. Configuring RIPng
9. Configuring PBR
10. Managing Routes
11. Configuring VRF
12. Configuring L3MAC
13. Configuring Hardware Capacity Query

1 Configuring Routing Policies

1.1 Overview

Routing policies are a policy set for changing the packet forwarding path or routing information and are often implemented by a filtering list and a route map. Routing policies are flexibly and widely applied in the following methods:

- Use a filtering list in a routing protocol to filter or modify routing information.
- Use a route map in a routing protocol to filter or modify routing information. Where, the route map can further use a filtering list.
- Use a route map in policy-based routing (PBR) to control packet forwarding or modify packet fields.

1.2 Applications

Application	Description
Route Filtering	Use a filtering list in a routing protocol to filter the routing information sent or received by the protocol.
Route Re-distribution	Use a route map in a routing protocol to filter or modify routing information and re-distribute RIP routes to OSPF. Only RIP routes with 4 hops can be re-distributed.
PBR	Use a route map in PBR to control packet forwarding or modify packet fields and specify optimum output interfaces for packets from different subnets.

1.2.1 Route Filtering

By default, a routing protocol advertises and learns all routing information. When a filtering list is used, the routing protocol advertises only required routes or receives only required routing information.

Scenario

Figure 1- 1

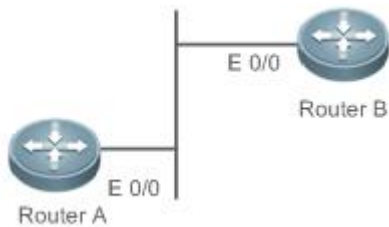

As shown in Figure 1- 1, router A has routes to 3 networks: 10.0.0.0, 20.0.0.0 and 30.0.0.0.

Configure a filtering list on the routers to achieve the following purposes:

- Filter the sent routing information on router A to filter routes that router A does not need to send.
- Filter the received routing information on router B to filter routes that router B does not need to learn.

Deployment

- Filter the sent routing information 30.0.0.0 on router A.
- Filter the received routing information 20.0.0.0 on router B to ensure that router B learns only routing information 10.0.0.0.

1.2.2 Route Re-distribution

By default, route re-distribution will re-distribute all routing information in a routing protocol to another routing protocol. All routing attributes will also be inherited. You can use a route map to perform conditional control for re-distribution between two routing protocols, including:

- Specify the range for re-distributing routes and re-distribute only routing information that meets certain rules.
- Set the attributes of routes generated by re-distribution.

Scenario

Figure 1- 2



As shown in Figure 1- 2, configure route re-distribution on the devices to achieve the following purposes:

- Re-distribute only RIP routes with 4 hops to OSPF.
- In the OSPF routing domain, the initial metric of this route is 40, the route type is the external route type-1 and the route tag value is set to 40.

Deployment

- Configure a route with 4 hops in the route map `rip_to_ospf`: match, and set the initial metric of this route to 40, the route type to the external route type-1 and the route tag value to 40.
- Configure route re-distribution to re-distribute RIP routes to OSPF and use the route map `rip_to_ospf`.

1.2.3 PBR

PBR is implemented by applying a route map including policies to interfaces and devices.

Similar to static routing, PBR is also manually configured, where recursive routing supports automatic update with network changes.

As compared with static and dynamic routing, PBR is more flexible. Static and dynamic routing can forward packets only based on destination addresses. PBR can forward packets based on the source and destination addresses, packet length and input interface.

Scenario

Figure 1- 3

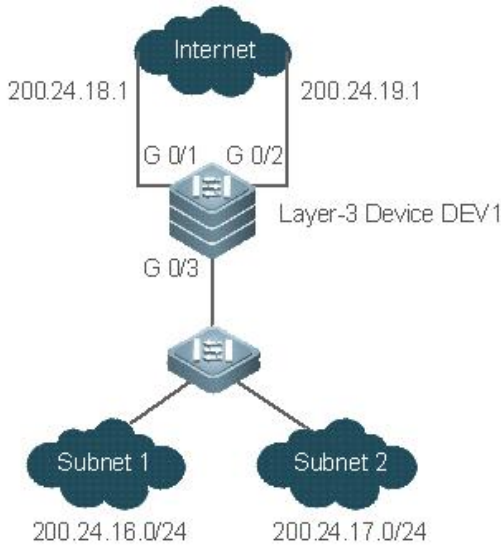

Configure PBR on the layer-3 device DEV1 to achieve the following purposes:

- Packets from subnet 1 (200.24.16.0/24) are sent from GE0/1 first.
- Packets from subnet 2 (200.24.17.0/24) are sent from GE0/2 first.

Deployment

- Configure two different ACLs to match packets from subnets 1 and 2 respectively.
- Configure the route map RM_FOR_PBR: policy 10 is used to ensure that "packets from subnet 1 are sent from GE0/1 first"; policy 20 is used to ensure that "packets from subnet 2 are sent from GE0/2 first".
- Perform PBR for packets received from GE0/3 and use the route map RM_FOR_PBR.

1.3 Features

Overview

Feature	Description
Filtering List	Define a group of lists based on a route attribute, which can be used by a routing protocol for route filtering.
Route Map	A policy defines "if certain conditions are matched, you can perform certain processing actions".

1.3.1 Filtering List

Filtering lists are a group of lists defined based on a routing attribute and are a tool for filtering routing policies. Independent filtering lists are meaningless and can be used to filter routes only when they are applied in a routing protocol.

Working Principle

Based on different routing attributes, filtering lists are classified into the following types:

➤ **Access Control List (ACL)**

ACLs comprise IPv4 and IPv6 ACLs. When defining ACLs, you can specify IPv4/IPv6 addresses and masks to match the destination network segment or next-hop addresses of routing information.

For description about ACLs, see the *ACL Configuration Guide*.

➤ Address Prefix List (prefix-list)

Similar to ACLs, prefix-lists, including IPv4 prefix-lists and IPv6 prefix-lists, are used to match destination network segments of routing information during route filtering.

➤ AS-Path List

AS-path lists are used only for BGP. They are used to match AS paths during BGP route filtering.

➤ Community Attribute Filtering List (Community-List)

Community-lists are used only for BGP. They are used to match community attributes during BGP route filtering.

➤ Extended Community Attribute Filtering List (Extcommunity-List)

Extcommunity-lists are used only for BGP. They are used to match extended community attributes during BGP route filtering.

Related Configuration

➤ Creating an ACL

By default, no ACL is configured and no policy is set.

In the global configuration mode, run the **ip access-list { extended | standard } { id | name }** command to create an IPv4 ACL.

You can set multiple policies in an ACL, sorted by their sequence numbers. Policies have two working modes: permit and deny.

➤ Creating a Prefix-List

By default, no prefix-list is configured and no entry is set.

In the global configuration mode, run the **ip prefix-list prefix-list-name [seq seq-number] { deny | permit } ip-prefix [ge minimum-prefix-length] [le maximum-prefix-length]** command to create an IPv4 prefix-list and add a prefix entry to the list.

You can set multiple entries in the prefix-list, sorted by their sequence numbers. Entries have two working modes: permit and deny.

Run the **ip prefix-list prefix-list-name description description-text** command to add description to the prefix-list.

Run the **ip prefix-list sequence-number** command to enable the sorting function for the prefix-list.

➤ Creating an AS-Path List

By default, no AS-path list is configured and no entry is set.

In the global configuration mode, run the **ip as-path access-list path-list-num { permit | deny } regular-expression** command to create an AS-path list and add an entry to the list.

You can set multiple entries in the AS-path list. Entries have two working modes: permit and deny.

➤ Creating a Community-List

By default, no community-list is configured and no entry is set.

In the global configuration mode, run the **ip community-list { standard | expanded } community-list-name | community-list-number { permit | deny } [community-number..]** command to create a community-list and add an entry to the list.

You can set multiple entries in the community-list. Entries have two working modes: permit and deny.

↘ Creating an Extcommunity-List

By default, no extcommunity-list is configured and no entry is set.

In the global configuration mode, run the **ip extcommunity-list** *{standard-list | standard list-name}* **{ permit | deny }** [*rt value*] [*soo value*] command to create a standard extcommunity list and add an entry to the list.

Run the **ip extcommunity-list** *{expanded-list | expanded list-name}* **{ permit | deny }** [*regular-expression*] command to create an extcommunity list and add an entry to the list.

You can also run the **ip extcommunity-list** *{expanded-list | expanded list-name| standard-list | standard list-name}* command to create an extcommunity list and enter the configuration mode of **ip extcommunity-list** to add entries.

You can set multiple entries in the extcommunity-list. Entries have two working modes: permit and deny.

1.3.2Route Map

A policy is a "match ..., set..." statement, which indicates that "if certain conditions are matched, you can perform some processing actions".

Working Principle

↘ Executing policies

A route map may contain multiple policies. Each policy has a corresponding sequence number. A smaller sequence number means a higher priority. Policies are executed based on their sequence numbers. Once the matching condition of a policy is met, the processing action for this policy needs to be performed and the route map exits. If no matching condition of any policy is met, no processing action will be performed.

↘ Working Modes Of Policies

Policies have two working modes:

- permit: When the matching condition of a policy is met, the processing action for this policy will be performed and the route map will exit.
- deny: When the matching condition of a policy is met, the processing action for this policy will not be performed and the route map will exit.

↘ Matching Conditions Of Policies

The matching condition of a policy may contain 0, 1 or more match rules.

- If the matching condition contains 0 match rule, no packet will be matched.
- If the matching condition contains one or more match rules, all rules must be matched.

↘ Processing Action for a Policy

The processing action of a policy may contain 0, 1 or more set rules.

- If the processing action contains 0 set rule, no processing action will be performed and the route map will directly exit.
- If the processing action contains one or more set rules, all processing actions will be performed and then the route map will exit.



If set rules have different priorities, the set rule with the highest priority will take effect.

Related Configuration

📌 Creating a Route Map (Policy)

By default, no route map is configured and no policy is set.

In the global configuration mode, you can run the **route-map** *route-map-name* [**permit** | **deny**] [*sequence-number*] command to create a route map and add a policy to the route map.

You can set multiple policies in a route map. Each policy uses different sequence numbers.

📌 Setting Matching Conditions of a Policy

By default, no match rule is set (that is, the matching condition of a policy contains 0 match rule).

In the route map mode, run the **match** command to set match rules. One **match** command is mapped to one match rule.

FSOS provides abundant **match** commands for setting flexible matching conditions.

Command	Description
match as-path	Uses the AS_PATH attribute of a BGP route as the matching condition.
match community	Uses the community attribute of a BGP route as the matching condition.
match extcommunity	Uses the extended community attribute of a BGP route as the matching condition.
match interface	Uses the output interface of a route as the matching condition.
match ip address	Uses the destination IPv4 address of a route as the matching condition.
match ip next-hop	Uses the next-hop IPv4 address of a route as the matching condition.
match ip route-source	Uses the source IPv4 address of a route as the matching condition.
match ipv6 address	Uses the destination IPv6 address of a route as the matching condition.
match ipv6 next-hop	Uses the next-hop IPv6 address of a route as the matching condition.
match ipv6 route-source	Uses the source IPv6 address of a route as the matching condition.
match metric	Uses the metric of a route as the matching condition.
match origin	Uses the source of a route as the matching condition.
match route-type	Uses the type of a route as the matching condition.
match tag	Uses the tag value of a route as the matching condition.

📌 Setting the Processing Actions of a Policy

By default, no set rule is configured (that is, the processing action of a policy contains 0 set rule).

In the route map mode, run the **set** command to configure set rules. One **set** command is mapped to one set rule.

FSOS provides abundant **set** commands for setting flexible processing actions.

Command	Description
set aggregator as	Modifies the AS attribute value of a route aggregator.
set as-path prepend	Adds a specified as-path attribute value.
set as-path replace	Replace the specified as-path attribute value.
set atomic-aggregate	Sets the atomic-aggregate attribute of a route.
set comm-list delete	Deletes all community attribute values from the community attribute list for a route matching the match rules.
set community	Sets the community attribute value of a route.
set dampening	Sets the flapping parameters of a route.
set extcomm-list delete	Deletes all extended community attribute values from the extcommunity attribute list for a

Command	Description
	route matching the match rules.
set extcommunity	Sets the extended community attribute value of a route.
set fast-reroute	Sets the backup output interface and next hop of a fast reroute.
set ip default nexthop	Specifies the default next hop of a route. This command has a lower priority than a common route and a higher priority than set default interface .
set ip dscp	Modifies the dscp field of an IP packet.
set ip global next-hop	Specifies the next hop of a route.
set ip global default next-hop	Specifies the default next hop of a route.
set ip nexthop	Specifies the next hop of a route. This command has a higher priority than set interface .
set ip next-hop recursive	Specifies the recursive next-hop IP address of a route.
set ip next-hop verify-availability	Specifies the next-hop IP address of a route and checks the accessibility of the next hop by using BFD.
set ip precedence	Modifies the precedence field of an IP packet.
set ip tos	Modifies the tos field of an IP packet.
set ipv6 fast-reroute	Specifies the backup egress and backup next hop of FRR.
set ipv6 default next-hop	Specifies the default next hop of a route. This command has a lower priority than a common route and a higher priority than the default route.
set ipv6 global next-hop	Specifies the IPv6 next hop of a route.
set ipv6 global default next-hop	Specifies the default IPv6 next hop of a route.
set ipv6 next-hop	Specifies the IPv6 next hop of a route. This command has a higher priority than a common route.
set ipv6 next-hop verify-availability	Specifies the next-hop IP address of a route and checks the accessibility of the next hop by using BFD.
set ipv6 precedence	Sets the priority of an IPv6 packet header.
set level	Sets the destination area type to which a route will be directed.
set local-preference	Sets the local-preference attribute value of a route.
set metric	Modifies the metric value of a route.
set metric-type	Sets the metric type of a route.
set next-hop	Sets the next-hop IP address of a route.
set ip next-hop verify-availability	Specifies the next-hop IP address of a route and checks the accessibility of the next hop by using a third-party protocol.
set origin	Sets the source attribute of a route.
set originator-id	Sets the originator IP address of a route.
set tag	Sets the tag value of a route.
set distance	Sets the administrative distance.
set weight	Sets the weight value of a route.

1.4 Configuration

Configuration	Description and Command
Configuring a Route Map	 (Optional) It is used to define a policy.
	route-map Creates a policy (route map).

Configuration	Description and Command	
	match	Sets the matching conditions of the policy.
	set	Sets the processing actions of the policy.
	Statement-name	Sets the statement name of route map (not associated with policy).
Configuring a Filtering List	(Optional) It is used to define a filtering list.	
	ip as-path	Defines AS path filtering rules.
	ip community-list	Defines a community list.
	ip extcommunity-list	Defines an extcommunity list.
	ip prefix-list	Creates a prefix-list.
	ip prefix-list description	Adds description to a prefix-list.
	ip prefix-list sequence-number	Enables the sorting function for a prefix-list.
	ipv6 prefix-list	Creates an IPv6 prefix-list.
	ipv6 prefix-list description	Adds description to an IPv6 prefix-list.
	ipv6 prefix-list sequence-number	Enables the sorting function for an IPv6 prefix-list.

1.4.1 Configuring a Route Map

Configuration Effect

- Define a set of routing policies to be used by routing protocols or PBR.

Notes

- If a **match** command uses an ACL to define packet matching conditions, the ACL must be configured.
- The following **match** commands cannot be configured at the same time:

The Following match Commands	Cannot Be Configured with the Following match Commands At the Same Time
match ipv6 address	match ipv6 prefix-list
match ip next-hop	match ip next-hop prefix-list
match ipv6 next-hop	match ipv6 next-hop prefix-list
match ip route-source	match ip route-source prefix-list
match ipv6 route-source	match ipv6 route-source prefix-list

- The following **set** commands cannot be configured at the same time:

The Following set Commands	Cannot Be Configured with the Following set Commands At the Same Time
set ip next-hop	set ip next-hop verify-availability
set ip dscp	set ip tos
set ip dscp	set ip precedence

Configuration Steps

📌 Creating a Policy (Route Map)

- Mandatory.
- Perform this configuration on a device to which a policy needs to be applied.

➤ **Setting Matching Conditions of a Policy**

- Optional.
- If no match rule is configured, no packet will be matched.
- If multiple match rules are configured, all the match rules must be matched.
- Perform this configuration on a device to which a policy needs to be applied.

➤ **Setting the Processing Actions of a Policy**

- Optional.
- If no set rule is configured, no processing action will be performed.
- If multiple set rules are configured, all set rules must be executed (if the set rules have different priorities, the set rule with the highest priority takes effect).
- Perform this configuration on a device to which a policy needs to be applied.

Verification

- Check the configurations of the route map.

Related Commands

➤ **Creating a Policy (Route Map)**

Command	route-map <i>route-map-name</i> [{ permit deny } <i>sequence</i>]
Parameter Description	<i>route-map-name</i> : Indicates the name of a route map, comprising not more than 32 characters. (200 characters for some versions) permit: Specifies the working mode of this policy as permit, which is the default mode. deny: Specifies the working mode of this policy as deny. The default mode is permit. <i>sequence</i> : Specifies the sequence number of this policy. A smaller value means a higher priority. The default value is 10.
Command Mode	Global configuration mode
Usage Guide	If this route map is unavailable, this command will create a route map and add a policy to the route map. If this route map is available, this command will add a policy to the route map.

➤ **Setting Matching Conditions of a Policy**

Command	match as-path <i>as-path-acl-list-number</i> [<i>as-path-acl-list-number....</i>]
Parameter Description	<i>as-path-acl-list-number</i> : Indicates the AS-PATH list number, ranging from 1 to 500.
Command Mode	Route map configuration mode
Usage Guide	This match rule is used to match the AS-PATH attribute of a BGP route. Run the ip as-path access-list <i>path-list-num</i> { permit deny } <i>regular-expression</i> command to configure the AS-PATH list.

Command	match community { <i>community-list-number</i> <i>community-list-name</i> } [exact-match] [{ <i>community-list-number</i>
----------------	--

	<i>community-list-name</i> { exact-match } ...]
Parameter Description	<p><i>community-list-number</i>: Indicates the community list number. For a standard community list, the value ranges from 1 to 99. For an extcommunity list, the value ranges from 100 to 199.</p> <p><i>community-list-name</i>: Indicates the community list name, comprising not more than 80 characters.</p> <p>exact-match: Indicates the exact match list. It is a non-exact match list by default, that is, the match rule is met as long as the routing attributes contain the attributes specified by a community list.</p>
Command Mode	Route map configuration mode
Usage Guide	This match rule is used to match the community attribute specified in a community list.

Command	match extcommunity { <i>standard-list-number</i> <i>standard-list-name</i> <i>expanded-list-num</i> <i>expanded-list-name</i> }
Parameter Description	<p><i>standard-list-number</i>: Indicates an ID, ranging from 1 to 99. It is used to identify a standard extcommunity list. One extcommunity list may contain multiple extcommunity values.</p> <p><i>standard-list-name</i>: Indicates the name of a standard extcommunity list. It is used to identify the name of a standard extcommunity list. One extcommunity list may contain multiple extcommunity values.</p> <p><i>expanded-list-num</i>: Indicates an ID, ranging from 100 to 199. It is used to identify an extcommunity list. One extcommunity list may contain multiple extcommunity values.</p> <p><i>expanded-list-name</i>: Indicates the name of an extcommunity. It is used to identify the name of an extcommunity list. One extcommunity list may contain multiple extcommunity values.</p>
Command Mode	Route map configuration mode
Usage Guide	This match rule is used to match the extended community attribute specified in an extcommunity list.

Command	match interface <i>interface-type interface-number</i> [... <i>interface-type interface-number</i>]
Parameter Description	<i>interface-type interface-number</i> : Indicates the interface type and interface number.
Command Mode	Route map configuration mode
Usage Guide	This match rule is used to match the next-hop output interface of a route or a packet.

Command	match ip address { <i>access-list-number</i> [<i>access-list-number...</i> <i>access-list-name...</i>] <i>access-list-name</i> [<i>access-list-number...</i> <i>access-list-name</i>] prefix-list <i>prefix-list-name</i> [<i>prefix-list-name...</i>] }
Parameter Description	<p><i>access-list-number</i>: Indicates the access list number. For a standard access list, the value ranges are 1 to 99 and 1300 to 1999. For an extended access list, the value ranges are 100 to 199 and 2000 to 2699.</p> <p><i>access-list-name</i>: Indicates the access list name.</p> <p>prefix-list <i>prefix-list-name</i>: Indicates the name of a prefix-list to be matched.</p>
Command Mode	Route map configuration mode
Usage Guide	This match rule matches the destination IPv4 address of a packet or route by using an ACL or a prefix-list.

Command	match ip next-hop { <i>access-list-number</i> [<i>access-list-number...</i> <i>access-list-name...</i>] <i>access-list-name</i> [<i>access-list-number...</i> <i>access-list-name</i>] prefix-list <i>prefix-list-name</i> [<i>prefix-list-name...</i>] }
Parameter	<i>access-list-number</i> : Indicates the access list number. For a standard access list, the value ranges are 1 to 99 and 1300

Description	to 1999. For an extended access list, the value ranges are 100 to 199 and 2000 to 2699. <i>access-list-name</i> : Indicates the access list name. prefix-list <i>prefix-list-name</i> : Indicates the name of a prefix-list to be matched.
Command Mode	Route map configuration mode
Usage Guide	This match rule matches the next-hop IPv4 address of a route by using an ACL or a prefix-list. An ACL and a prefix-list cannot be configured at the same time.

Command	match ip route-source { <i>access-list-number</i> [<i>access-list-number...</i> <i>access-list-name...</i>] <i>access-list-name</i> [<i>access-list-number...</i> <i>access-list-name</i>] prefix-list <i>prefix-list-name</i> [<i>prefix-list-name...</i>] }
Parameter Description	<i>access-list-number</i> : Indicates the access list number. For a standard access list, the value ranges are 1 to 99 and 1300 to 1999. For an extended access list, the value ranges are 100 to 199 and 2000 to 2699. <i>access-list-name</i> : Indicates the access list name. prefix-list <i>prefix-list-name</i> : Indicates the name of a prefix-list to be matched.
Command Mode	Route map configuration mode
Usage Guide	This match rule matches the source IPv4 address of a route by using an ACL or a prefix-list. An ACL and a prefix-list cannot be configured at the same time.

Command	match ipv6 address { <i>access-list-name</i> prefix-list <i>prefix-list-name</i> }
Parameter Description	<i>access-list-name</i> : Indicates the access list name. prefix-list <i>prefix-list-name</i> : Indicates the name of an IPv6 prefix-list to be matched.
Command Mode	Route map configuration mode
Usage Guide	This match rule matches the destination IPv6 address of a packet or route by using an ACL or a prefix-list. An ACL and a prefix list cannot be configured at the same time.

Command	match ipv6 next-hop { <i>access-list-name</i> prefix-list <i>prefix-list-name</i> }
Parameter Description	<i>access-list-name</i> : Indicates the access list name. prefix-list <i>prefix-list-name</i> : Indicates the name of an IPv6 prefix-list to be matched.
Command Mode	Route map configuration mode
Usage Guide	This match rule matches the next-hop IPv6 address of a route by using an ACL or a prefix-list. An ACL and a prefix-list cannot be configured at the same time.

Command	match ipv6 route-source { <i>access-list-name</i> prefix-list <i>prefix-list-name</i> }
Parameter Description	<i>access-list-name</i> : Indicates the access list name. prefix-list <i>prefix-list-name</i> : Indicates the name of an IPv6 prefix-list to be matched.
Command Mode	Route map configuration mode
Usage Guide	This match rule matches the source IPv6 address of a route by using an ACL or a prefix-list. An ACL and a prefix-list cannot be configured at the same time.

Command	match metric <i>metric</i>
Parameter Description	<i>metric</i> : Indicates the metric value of a route, ranging from 0 to 4,294,967,295.
Command Mode	Route map configuration mode
Usage Guide	This match rule is used to match the metric value of a route.

Command	match origin { egp igp incomplete }
Parameter Description	egp : Indicates the source is remote EGP. igp : Indicates the source is local IGP. incomplete : Indicates that the source is an incomplete type.
Command Mode	Route map configuration mode
Usage Guide	This match rule is used to match the source of a route.

Command	match route-type { local internal external [type-1 type-2] level-1 level-2 }
Parameter Description	local : Indicates a route locally generated. Internal : Indicates an internal OSPF route. external : Indicates an external route (that of BGP or OSPF). type-1 type-2 : Indicates type-1 or type-2 external route of OSPF. level-1 level-2 : Indicates level-1 or level-2 route of ISIS.
Command Mode	Route map configuration mode
Usage Guide	This match rule is used to match the type of a route.

Command	match tag <i>tag</i> [... <i>tag</i>]
Parameter Description	<i>tag</i> : Indicates the tag value of a route.
Command Mode	Route map configuration mode
Usage Guide	This match rule is used to match the tag value of a route.

⚡ Setting the Processing Actions of a Policy

Command	set aggregator as <i>as-number ip-address</i>
Parameter Description	<i>as-number</i> : Indicates the AS number of an aggregator. The AS number ranges from 1 to 4,294,967,295, which can be indicated by 1 to 65535.65535 in the dot mode. <i>ip-address</i> : Indicates the address of an aggregator.
Command Mode	Route map configuration mode
Usage Guide	This set rule is used to modify the AS attribute value of a route's aggregator.

Command	set as-path prepend <i>as-number</i>
----------------	---

Parameter	<i>as-number</i> : Indicates the AS number to be added to the AS_PATH attribute. The AS number ranges from 1 to 4,294,967,295, which can be indicated by 1 to 65535.65535 in the dot mode.
Description	
Command	Route map configuration mode
Mode	
Usage Guide	This set rule is used to add a specified as-path attribute value.

Command	set as-path replace as-number
Parameter	<i>as-number</i> : Indicates the AS number which will replace the AS_PATH attribute. The AS number ranges from 1 to 4,294,967,295, which can be indicated by 1 to 65535.65535 in the dot mode.
Description	
Command	Route map configuration mode
Mode	
Usage Guide	This set rule is used to replace the specified as-path attribute value.

Command	set atomic-aggregate
Parameter	-
Description	
Command	Route map configuration mode
Mode	
Usage Guide	This set rule is used to set the atomic-aggregate attribute of a route.

Command	set comm-list { <i>community-list-number</i> <i>community-list-name</i> } delete
Parameter	<i>community-list-number</i> : Indicates the community list number. For a standard community list, the value ranges from 1 to 99. For an extcommunity list, the value ranges from 100 to 199.
Description	<i>community-list-name</i> : Indicates the community list name, comprising not more than 80 characters.
Command	Route map configuration mode
Mode	
Usage Guide	This rule is used to delete all community attribute values from the community list for a route matching the match rules.

Command	set community { <i>community-number</i> [<i>community-number</i> ...] additive none }
Parameter	<i>community-number</i> : Indicates the community attribute value.
Description	additive : Adds a number based on the original community attribute. none : Keeps the community attribute empty.
Command	Route map configuration mode
Mode	
Usage Guide	This set rule is used to set the community attribute value of a route.

Command	set dampening <i>half-life reuse suppress max-suppress-time</i>
Parameter	<i>half-life</i> : half-life when a route is accessible or not accessible, ranging from 1 to 45 minutes. The default value is 15 minutes.
Description	<i>reuse</i> : When the penalty value of a route is smaller than this value, route suppression will be canceled. The value ranges from 1 to 20,000 and the default value is 750. <i>suppress</i> : When the penalty value of a route is greater than this value, the route will be suppressed. The value ranges

	from 1 to 20,000 and the default value is 2,000. <i>max-suppress-time</i> : Indicates the longest time that a route can be suppressed, ranging from 1 to 255 minutes. The default value is 4 x half-life .
Command	Route map configuration mode
Mode	
Usage Guide	This set rule is used to set the flapping parameters of a route.

Command	set extcomm-list { <i>extcommunity-list-number</i> <i>extcommunity-list-name</i> } delete
Parameter	<i>extcommunity-list-number</i> : Indicates the extcommunity list number. For a standard extcommunity list, the value ranges from 1 to 99. For an extended extcommunity list, the value ranges from 100 to 199.
Description	<i>extcommunity-list-name</i> : Indicates the extcommunity list name, comprising not more than 80 characters.
Command	Route map configuration mode
Mode	
Usage Guide	This set rule is used to delete all extended community attribute values from the extcommunity attribute list for a route matching the match rules.

Command	set extcommunity { rt <i>extend-community-value</i> soo <i>extend-community-value</i> }
Parameter	rt : Sets the RT attribute value of a route.
Description	soo : Sets the SOO attribute value of a route. <i>extend-community-value</i> : Indicates the value of an extended community.
Command	Route map configuration mode
Mode	
Usage Guide	This set rule is used to set the extended community attribute value of a route.

Command	set fast-reroute backup-interface <i>interface-type interface-number</i> [backup-nexthop <i>ip-address</i>]
Parameter	<i>interface-type interface-number</i> : Specifies a backup output interface.
Description	backup-nexthop <i>ip-address</i> : Specifies a backup next hop. For a non-point-to-point interface, a backup next hop must be specified.
Command	Route map configuration mode
Mode	
Usage Guide	This set rule is used to set the backup output interface and next hop of a fast reroute.

Command	set ip default next-hop <i>ip-address</i> [<i>weight</i>] [... <i>ip-address</i> [<i>weight</i>]]
Parameter	<i>ip-address</i> : Indicates the next-hop IP address.
Description	<i>weight</i> : Indicates the weight of this next hop.
Command	Route map configuration mode
Mode	
Usage Guide	This set rule is used to specify the default next hop of a route.

Command	set ip dscp <i>dscp_value</i>
Parameter	<i>dscp_value</i> : Sets the DSCP value in the IP header of an IP packet.

Description	
Command	Route map configuration mode
Mode	
Usage Guide	This set rule is used to modify the dscp field of an IP packet.

Command	set ip next-hop recursive <i>ip-address</i>
Parameter	<i>ip-address</i> : Indicates the recursive next-hop IP address.
Description	
Command	Route map configuration mode
Mode	
Usage Guide	<p>This command is used only for PBR configuration.</p> <p>This set rule is used to specify the recursive next hop of a route. An IP address can recur to a static or dynamic route that has an output interface and a next-hop IP address. A maximum of 32 next hops are supported. If a recursive route is a static route, only one next hop is supported for the static recursive route.</p>

Command	set ip next-hop verify-availability <i>ip-address</i> [track <i>track-obj-number</i> bfd <i>interface-type interface-number gateway</i>]
Parameter	<i>ip-address</i> : Indicates the next-hop IP address.
Description	<p>track: Judges whether the next hop is effective by using <i>Track</i>.</p> <p>bfd: Indicates that BFD is used for neighbor detection.</p> <p><i>interface-type</i>: Configures the interface type.</p> <p><i>interface-number</i>: Configures the interface number.</p> <p><i>gateway</i>: Configures the gateway IP address, which is the neighbor IP address of BFD. If the next hop is configured as the neighbor, BFD will be used to detect the accessibility of the forwarding path.</p>
Command	Route map configuration mode
Mode	
Usage Guide	This set rule is used to specify the next hop of a route, and BFD is used to fast detect the effectiveness of the next hop.
Command	set ip precedence { <i>number</i> critical flash flash-override immediate internet network priority routine }
Parameter	<i>number</i> : Indicates the priority of the IP header with a number, ranging from 0 to 7.
Description	<p>7: critical</p> <p>6: flash</p> <p>5: flash-override</p> <p>4: immediate</p> <p>3: internet</p> <p>2: network</p> <p>1: priority</p> <p>0: routine</p> <p>critical flash flash-override immediate internet network priority routine: priority of an IP header.</p>
Command	Route map configuration mode
Mode	
Usage Guide	This set rule is used to modify the precedence field of an IP packet header.

Command	set ip tos { <i>number</i> max-reliability max-throughput min-delay min-monetary-cost normal }
Parameter Description	<p><i>number</i>: Indicates the TOS value of an IP header with a number, ranging from 0 to 15.</p> <p>2: max-reliability</p> <p>4: max-throughput</p> <p>8: min-delay</p> <p>1: min-monetary-cost</p> <p>0: normal</p> <p>max-reliability max-throughput min-delay min-monetary-cost normal: priority of an IP header.</p>
Command Mode	Route map configuration mode
Usage Guide	This set rule is used to modify the tos field of an IP packet.

Command	set ipv6 default next-hop <i>global-ipv6-address</i> [<i>weight</i>] [<i>global-ipv6-address</i> [<i>weight</i>] ...]
Parameter Description	<p><i>global-ipv6-address</i>: Indicates the next-hop IPv6 address for packet forwarding. The next-hop router must be a neighbor router.</p> <p><i>weight</i>: Indicates the weight in the load balancing mode, ranging from 1 to 8. A larger value means larger packet traffic to be shared by the next hop.</p>
Command Mode	Route map configuration mode
Usage Guide	This set rule is used to specify the default next hop IPv6 address of a route.

Command	set ipv6 next-hop <i>global-ipv6-address</i> [<i>weight</i>] [<i>global-ipv6-address</i> [<i>weight</i>] ...]
Parameter Description	<p><i>global-ipv6-address</i>: Indicates the next-hop IPv6 address for packet forwarding. The next-hop router must be a neighbor router.</p> <p><i>weight</i>: Indicates the weight in the load balancing mode, ranging from 1 to 8. A larger value means larger packet traffic to be shared by the next hop.</p>
Command Mode	Route map configuration mode
Usage Guide	This set rule is used to specify the next hop IPv6 address of a route.

Command	set ipv6 next-hop verify-availability <i>global-ipv6-address</i> bfd <i>interface-type</i> <i>interface-number</i> <i>gateway</i>
Parameter Description	<p><i>global-ipv6-address</i>: Indicates the next-hop IPv6 address.</p> <p>bfd: Indicates that BFD is used for neighbor detection.</p> <p><i>interface-type</i>: Configures the interface type.</p> <p><i>interface-number</i>: Configures the interface number.</p> <p><i>gateway</i>: Configures the gateway IPv6 address, which is the neighbor IPv6 address of BFD. If the next hop is configured as the neighbor, BFD will be used to detect the accessibility of the forwarding path.</p>
Command Mode	Route map configuration mode
Usage Guide	This set rule is used to specify the next hop of a route and BFD is used to fast detect the effectiveness of the next hop.

Command	set ipv6 fast-reroute backup-interface <i>interface-type</i> <i>interface-number</i> [backup-nexthop <i>ip-address</i>]
----------------	---

Parameter	<i>interface-type interface-number</i> : Specifies the backup egress.
Description	backup-nexthop ip-address : Specified the backup next hop, which is mandatory for non-P2P interfaces.
Command Mode	Routing map configuration mode
Usage Guide	This set rule is used to specify the backup egress and next hop of FRR.

Command	set ipv6 precedence { <i>number</i> critical flash flash-override immediate internet network priority routine }
Parameter Description	<p><i>number</i>: Indicates the priority of the IP header with a number, ranging from 0 to 7.</p> <p>7: critical 6: flash 5: flash-override 4: immediate 3: internet 2: network 1: priority 0: routine</p> <p>critical flash flash-override immediate internet network priority routine: priority of an IP header.</p>
Command Mode	Route map configuration mode
Usage Guide	This set rule is used to set the priority of an IPv6 packet header.

Command	set level { level-1 level-2 level-1-2 stub-area backbone }
Parameter Description	<p>level-1: Indicates that the re-distribution route is advertised to ISIS Level 1.</p> <p>level-2: Indicates that the re-distribution route is advertised to ISIS Level 2.</p> <p>level-2: Indicates that the re-distribution route is advertised to ISIS Level 1 and Level 2.</p> <p>stub-area: Indicates that the re-distribution route is advertised to OSPF Stub Area.</p> <p>backbone: Indicates that the re-distribution route is advertised to the OSPF backbone area.</p>
Command Mode	Route map configuration mode
Usage Guide	This set rule is used to set the destination area type to which a route will be redirected.

Command	set local-preference <i>number</i>
Parameter Description	<i>number</i> : Indicates the metric value of a local priority, ranging from 0 to 4,294,967,295. A larger value means a higher priority.
Command Mode	Route map configuration mode
Usage Guide	This set rule is used to set the local-preference attribute value of a route.

Command	set metric [+ <i>metric-value</i> - <i>metric-value</i> <i>metric-value</i>]
Parameter Description	<p>+: Increases (based on the metric value of the original route).</p> <p>-: Decreases (based on the metric value of the original route).</p> <p><i>metric-value</i>: Sets the metric value of a re-distribution route. A larger value means a lower priority.</p>

Command	Route map configuration mode
Mode	
Usage Guide	This set rule is used to modify the metric value of a route.

Command	set metric-type <i>type</i>
Parameter	<i>type</i> : Sets the type of a re-distribution route. The default type of an OSPF re-distribution route is type-2.
Description	
Command	Route map configuration mode
Mode	
Usage Guide	This set rule is used to set the metric type.

Command	set next-hop <i>ip-address</i>
Parameter	<i>ip-address</i> : Indicates the next-hop IP address.
Description	
Command	Route map configuration mode
Mode	
Usage Guide	This set rule is used to set the next-hop IP address.

Command	set origin { egp igp incomplete }
Parameter	egp : Indicates the source is remote EGP.
Description	igp : Indicates the source is local IGP. incomplete : Indicates that the source is the incomplete type and generally refers to a route generated due to re-distribution.
Command	Route map configuration mode
Mode	
Usage Guide	This set rule is used to set the source attribute of a route.

Command	set originator-id <i>ip-address</i>
Parameter	<i>ip-address</i> : Indicates the address of an originator.
Description	
Command	Route map configuration mode
Mode	
Usage Guide	This set rule is used to set the originator IP address of a route.

Command	set tag <i>tag</i>
Parameter	<i>tag</i> : Sets the tag of a re-distribution route.
Description	
Command	Route map configuration mode
Mode	
Usage Guide	This set rule is used to set the tag value of a route.

Command	set distance <i>number</i>
Parameter	<i>number</i> : The greater the administrative value, the lower the priority.

Description	
Command Mode	Route map configuration mode
Usage Guide	This set rule is used to set the administrative distance.

Command	set weight <i>number</i>
Parameter Description	<i>number</i> : Sets the weight of a route, ranging from 0 to 65,535. A larger value means a higher priority.
Command Mode	Route map configuration mode
Usage Guide	This set rule is used to set the weight of a route.

📌 **Setting Configuration not Associated with Policy**

Command	statement-name [<i>name</i>]
Parameter Description	<i>name</i> : Statement name
Command Mode	Route map configuration mode
Usage Guide	Run the show route-map command to display the configurations of a route map. If an ACL is used when a route map is configured, you can run the show access-list command to display the configurations of the ACL.

📌 **Displaying the Configurations of a Route Map**

Command	show route-map [<i>name</i>]
Parameter Description	<i>name</i> : Specifies a route map.
Command Mode	Privilege, global and interface configuration modes
Usage Guide	Run the show route-map command to display the configurations of a route map. If an ACL is used when a route map is configured, you can run the show access-list command to display the configurations of the ACL.

Configuration Example

📌 **Using a Route Map in Route Re-distribution to Filter and Modify Routing Information**

Scenario Figure 1-4	As shown in Figure 1-4, a device is connected to both an OSPF routing domain and RIP routing domain. 
	<ul style="list-style-type: none"> ● Re-distribute only RIP routes with 4 hops to OSPF. In the OSPF route domain, if the route type is the external route type-1, set the tag value of the route to 40. ● Re-distribute only OSPF routes with the tag value 10 to RIP. In the RIP route domain, set the initial metric value of this route to 10.
Configuration	<ul style="list-style-type: none"> ● Configure the route map redrip: Match a route with 4 hops, set the initial metric value of the route to 40, set

<p>Steps</p>	<p>the route type to the external route type-1, and set the tag value of the route to 40.</p> <ul style="list-style-type: none"> ● Configure the route map redospf: match a route with the tag value 10 and set the initial metric value of the route to 10. ● Configure re-distribution of the RIP route to OSPF and apply the route map redrip. ● Configure re-distribution of the OSPF route to RIP and apply the route map redospf.
	<pre> FS(config)# route-map redrip permit 10 FS(config-route-map)# match metric 4 FS(config-route-map)# set metric-type type-1 FS(config-route-map)# set tag 40 FS(config-route-map)# exit FS(config)# route-map redospf permit 10 FS(config-route-map)# match tag 10 FS(config-route-map)# set metric 10 FS(config-route-map)# exit FS(config)# router ospf 1 FS(config-router)# redistribute rip subnets route-map redrip FS(config-router)# exit FS(config)# router rip FS(config-router)# redistribute ospf 1 route-map redospf FS(config-router)# exit </pre>
<p>Verification</p>	<ul style="list-style-type: none"> ● Check the configurations of the route map to verify the policy rules. ● Check the OSPF routing information library to verify that the rules matching the policy rules are re-distributed.
	<pre> FS# show route-map route-map redrip, permit, sequence 10 Match clauses: metric 4 Set clauses: metric 40 metric-type type-1 tag 40 route-map redospf, permit, sequence 10 Match clauses: tag 10 Set clauses: </pre>

metric 10
<pre> FS# show ip ospf database external OSPF Router with ID (192.100.1.9) (Process ID 1) AS External Link States LS age: 5 Options: 0x2 (- - - - E -) LS Type: AS-external-LSA Link State ID: 192.168.199.0 (External Network Number) Advertising Router: 192.100.1.9 LS Seq Number: 80000001 Checksum: 0x554d Length: 36 Network Mask: /24 Metric Type: 1 TOS: 0 Metric: 4 Forward Address: 0.0.0.0 External Route Tag: 40 </pre>

📌 Applying a Route Map in PBR

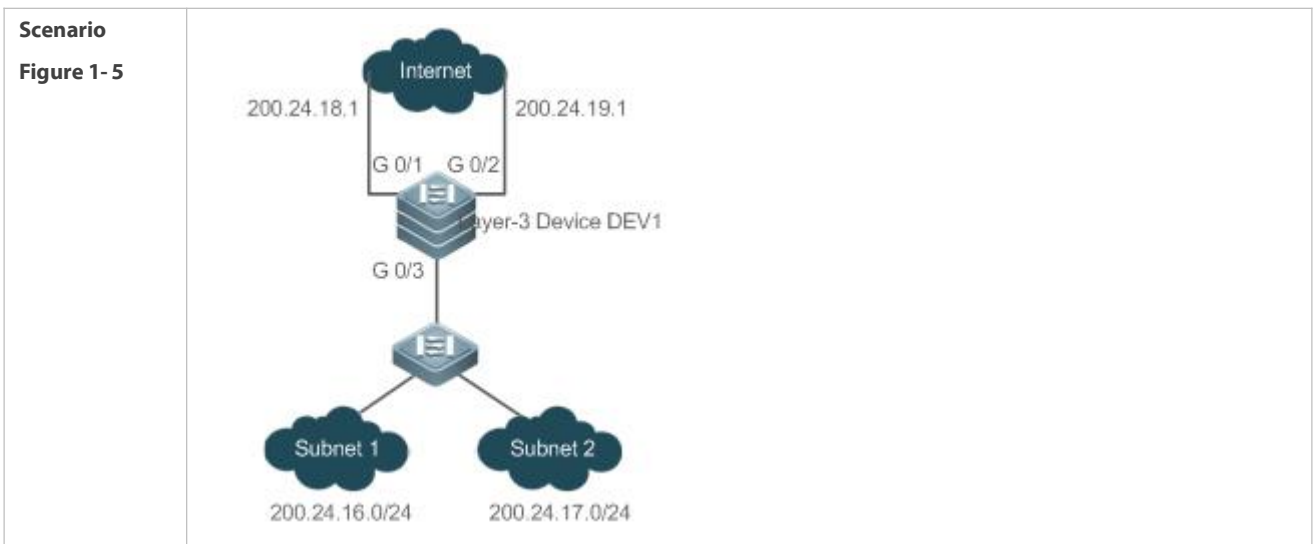

	<p>Configure PBR on the device DEV1 to achieve the following purposes:</p> <ul style="list-style-type: none"> ● Packets from subnet 1 (200.24.16.0/24) are sent from GE0/1 first. ● Packets from subnet 2 (200.24.17.0/24) are sent from GE0/2 first. ● The two output links work in the mutual backup mode.
<p>Configuration Steps</p>	<ul style="list-style-type: none"> ● Configure two different ACLs to match packets from subnets 1 and 2 respectively. ● Configure the route map RM_FOR_PBR: policy 10 is used to ensure that "packets from subnet 1 are sent from GE0/1 first"; policy 20 is used to ensure that "packets from subnet 2 are sent from GE0/2 first". ● Configure PBR for packets received from GE0/3 and apply the route map RM_FOR_PBR. ● Set PBR to implement redundant backup among multiple next hops. <p> In the redundant backup mode, the sequence of multiple set next hops is the sequence of the priorities for taking effect.</p>
	<pre> FS(config)# access-list 1 permit 200.24.16.0 0.0.0.255 FS(config)# access-list 2 permit 200.24.17.0 0.0.0.255 FS(config)# route-map RM_FOR_PBR 10 FS(config-route-map)# match ip address 1 FS(config-route-map)# set ip next-hop 200.24.18.1 FS(config-route-map)# set ip next-hop 200.24.19.1 FS(config-route-map)# exit FS(config)# route-map RM_FOR_PBR 20 FS(config-route-map)# match ip address 2 FS(config-route-map)# set ip next-hop 200.24.19.1 FS(config-route-map)# set ip next-hop 200.24.18.1 FS(config-route-map)# exit FS(config)# interface GigabitEthernet 0/3 FS(config-if)# ip policy route-map RM_FOR_PBR FS(config)# ip policy redundancy </pre>
<p>Verification</p>	<ul style="list-style-type: none"> ● Check the configurations of PBR to verify that the route map is applied to the interfaces. ● Check the configurations of the route map to verify the policy rules. ● Check the ACL configurations to verify the packet filtering rules.
	<pre> FS# show ip policy Balance mode: redundancy Interface Route map GigabitEthernet 0/3 RM_FOR_PBR ! </pre>
	<pre> FS# show route-map </pre>

<pre> route-map RM_FOR_PBR, permit, sequence 10 Match clauses: ip address 1 Set clauses: ip next-hop 200.24.18.1 ip next-hop 200.24.19.1 route-map RM_FOR_PBR, permit, sequence 20 Match clauses: ip address 2 Set clauses: ip next-hop 200.24.19.1 ip next-hop 200.24.18.1 </pre>
<pre> FS# show access-lists ip access-list standard 1 10 permit 200.24.16.0 0.0.0.255 10 permit 200.24.16.0 0.0.0.255 ip access-list standard 2 10 permit 200.24.17.0 0.0.0.255 </pre>

Common Errors

- After matching of ACLs and prefix-lists is configured, the corresponding ACLs and prefix lists are not defined.

1.4.2 Configuring a Filtering List

Configuration Effect

- Define a set of route filtering rules to be used by routing protocols.

Notes

- A configured filtering list can take effect only after it is associated with a routing protocol.

Configuration Steps

➤ Configuring a Prefix-List

- To filter address prefixes, you should perform this configuration.
- If there is no special requirement, you should perform this configuration on a route for which filtering based on a prefix-list needs to be performed.

➤ Configuring an AS Path List

- To filter address prefixes, you should perform this configuration.

- If there is no special requirement, you should perform this configuration on a route for which filtering based on an AS path needs to be performed.

➤ **Configuring a Community List**

- To filter community attributes, you should perform this configuration.
- If there is no special requirement, you should perform this configuration on a route for which community attributes need to be filtered.

➤ **Configuring an Extcommunity List**

- To filter extended community attributes, you should perform this configuration.
- If there is no special requirement, you should perform this configuration on a route for which extended community attributes need to be filtered.

Verification

- Check whether the filtering list is correctly configured.
- Check the routing table to verify that routes can be correctly filtered.

Related Commands

➤ **Defining AS Path Filtering Rules**

Command	ip as-path access-list <i>path-list-num</i> { permit deny } <i>regular-expression</i>
Parameter Description	<p>path-list-num: Indicates an AS-path ACL name based on a regular expression and is an AS path list identifier, ranging from 1 to 500.</p> <p>permit: Permits access.</p> <p>deny: Denies access.</p> <p>regular-expression: Indicates a regular expression, ranging from 1 to 255.</p>
Command Mode	Global configuration mode
Usage Guide	-

➤ **Defining a Community List**

Command	ip community-list { { standard expanded } <i>community-list-name</i> <i>community-list-number</i> } { permit deny } [<i>community-number..</i>]
Parameter Description	<p>standard: Indicates a standard community list.</p> <p>expanded: Indicates an extended community list.</p> <p>community-list-name: Indicates the community list name, comprising not more than 80 characters.</p> <p>community-list-number: Indicates the community list number. For a standard community list, the value ranges from 1 to 99. For an extended community list, the value ranges from 100 to 199.</p> <p>permit: Permits access.</p> <p>deny: Denies access.</p> <p>community-number: Indicates the community attribute value.</p>
Command Mode	Global configuration mode

Usage Guide	Use this command to define a community list used for BGP.
--------------------	---

↘ **Defining an Extcommunity List**

Command	ip extcommunity-list <i>{expanded-list expanded list-name}</i> { permit deny } [<i>regular-expression</i>]
Parameter Description	<p>expand-list: Indicates an extended extcommunity list, ranging from 100 to 199. One extcommunity list may contain multiple rules.</p> <p>standard-list: Indicates a standard extcommunity list, ranging from 1 to 99. One extcommunity list may contain multiple rules.</p> <p>expanded list-name: Indicates the name of an extended extcommunity, comprising not more than 32 characters. When using this parameter, you enter the extcommunity list configuration mode.</p> <p>standard list-name: Indicates the name of a standard extcommunity list, comprising not more than 32 characters. When using this parameter, you enter the extcommunity list configuration mode.</p> <p>permit: Defines an extcommunity rule for permitting.</p> <p>deny: Defines an extcommunity rule for denying.</p> <p>regular-expression: (optional) Defines a matching template that is used to match an extcommunity.</p> <p>sequence-number: (Optional) Defines the sequence number of a rule, ranging from 1 to 2,147,483,647. If no sequence number is specified, the sequence number automatically increases by 10 when a rule is added by default. The initial number is 10.</p> <p>rt: (Optional) Sets the RT attribute value. This command can be used only for the standard extcommunity configuration, but not for the extended extcommunity configuration.</p> <p>soo: (Optional) Sets the SOO attribute value. This command can be used only for the standard extcommunity configuration, but not for the extended extcommunity configuration.</p> <p>value: Indicates the value of an extended community (extend_community_value).</p>
Command Mode	Global configuration mode and ip extcommunity-list configuration mode
Usage Guide	-

↘ **Creating a Prefix-List**

Command	ip prefix-list <i>prefix-list-name</i> [seq seq-number] { deny permit } <i>ip-prefix</i> [ge minimum-prefix-length] [le maximum-prefix-length]
Parameter Description	<p>prefix-list-name: Indicates the prefix-list name.</p> <p>seq-number: Assigns a sequence number to an prefix-list entry, ranging from 1 to 2,147,483,647. If this command does not contain the sequence number, the system will assign a default sequence number to the prefix-list entry. The default sequence number of the first entry is 5. Subsequently, the default sequence number of each entry not assigned with a value is the first multiple of 5 greater than the previous sequence number.</p> <p>deny: Denies access when certain conditions are matched.</p> <p>permit: Permits access when certain conditions are matched.</p> <p>ip-prefix: Configures the IP address and mask, ranging from 0 to 32 digits.</p> <p>minimum-prefix-length: Specifies the minimum range (namely, the start length of a range).</p> <p>maximum-prefix-length: Specifies the maximum range (namely, the end length of a range).</p>
Command Mode	Global configuration mode
Usage Guide	-

➤ Adding Description to a Prefix-List

Command	ip prefix-list <i>prefix-list-name</i> description <i>descripton-text</i>
Parameter	prefix-list-name: Indicates the prefix-list name.
Description	descripton-text: Describes the prefix-list.
Command Mode	Global configuration mode
Usage Guide	-

➤ Enabling the Sorting Function for a Prefix-List

Command	ip prefix-list sequence-number
Parameter	-
Description	
Command Mode	Global configuration mode
Usage Guide	-

➤ Creating an IPv6 Prefix-List

Command	ipv6 prefix-list <i>prefix-list-name</i> [seq <i>seq-number</i>] { deny permit } <i>ipv6-prefix</i> [ge <i>minimum-prefix-length</i>] [le <i>maximum-prefix-length</i>]
Parameter	prefix-list-name: Indicates the prefix-list name.
Description	<p>seq-number: Assigns a sequence number to an prefix-list entry, ranging from 1 to 2,147,483,647. If this command does not contain the sequence number, the system will assign a default sequence number to the prefix-list entry. The default sequence number of the first entry is 5. Subsequently, the default sequence number of each entry not assigned with a value is the first multiple of 5 greater than the previous sequence number.</p> <p>deny: Denies access when certain conditions are matched.</p> <p>permit: Permits access when certain conditions are matched.</p> <p>ipv6-prefix: Configures the IP address and mask, ranging from 0 to 128 digits.</p> <p>minimum-prefix-length: Specifies the minimum range (namely, the start length of a range).</p> <p>maximum-prefix-length: Specifies the maximum range (namely, the end length of a range).</p>
Command Mode	Global configuration mode
Usage Guide	-

➤ Adding Description to an IPv6 Prefix List

Command	ipv6 prefix-list <i>prefix-list-name</i> description <i>descripton-text</i>
Parameter	prefix-list-name: Indicates the prefix list name.
Description	descripton-text: Describes the prefix list.
Command Mode	Global configuration mode
Usage Guide	-

➤ Enabling the Sorting Function for an IPv6 Prefix-List

Command	ipv6 prefix-list sequence-number
----------------	---

Parameter Description	-
Command Mode	Global configuration mode
Usage Guide	-

Configuration Example

▾ **Configuring a Prefix-List**

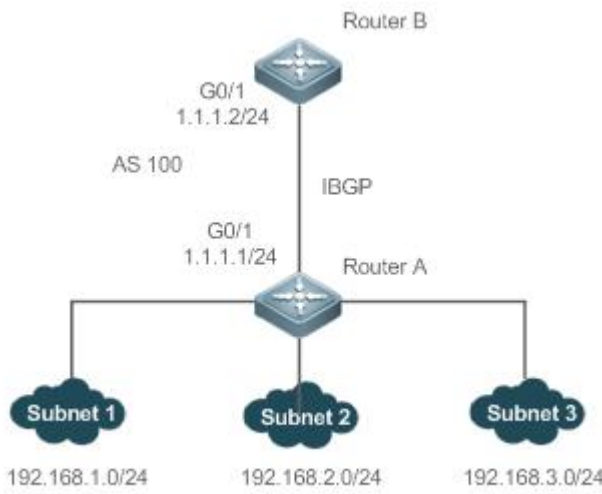
<p>Scenario Figure 1-6</p>	
<p>Configuration Steps</p>	<ul style="list-style-type: none"> ● Configure an IBGP neighbor and advertise the neighbor to the three connected subnets. ● Configure a prefix-list. ● Associate a prefix-list with A to filter sent routes.
<p>A</p>	<pre>A# configure terminal A(config)# ip prefix-list pre1 permit 192.168.1.0/24 A(config)# router bgp 100 A(config-router)# neighbor 1.1.1.2 prefix-list pre1 out A(config-router)# end</pre>
<p>Verification</p>	<ul style="list-style-type: none"> ● Run the show command to display the prefix-list. ● Run the show command to display the BGP routing table to check whether the filtering behavior is correct.

A	<pre> A# show ip prefix-list ip prefix-list pre1: 1 entries seq 5 permit 192.168.1.0/24 A# show ip bgp BGP table version is 2, local router ID is 1.1.1.1 Status codes: s suppressed, d damped, h history, * valid, > best, i - internal, S Stale, b - backup entry Origin codes: i - IGP, e - EGP, ? - incomplete Network Next Hop Metric LocPrf Weight Path * > 192.168.1.0 0.0.0.0 0 0 32768 i * > 192.168.2.0 0.0.0.0 0 0 32768 i * > 192.168.3.0 0.0.0.0 0 0 32768 i Total number of prefixes 3 </pre>
B	<pre> B# show ip bgp BGP table version is 4, local router ID is 1.1.1.2 Status codes: s suppressed, d damped, h history, * valid, > best, i - internal, S Stale Origin codes: i - IGP, e - EGP, ? - incomplete Network Next Hop Metric LocPrf Weight Path * > i192.168.1.0 1.1.1.1 0 100 0 i Total number of prefixes 1 </pre>

↘ Configuring an AS Path List

<p>Scenario Figure 1-7</p>	
<p>Configuration Steps</p>	<ul style="list-style-type: none"> ● Create an AS-path filtering rule to match path information including only AS 200. ● Establish EBGP neighborship on A with B and C. ● Associate an AS-path list with A to filter the routes received from B and C.
<p>A</p>	<pre>A(config)# ip as-path access-list 123 permit ^200\$ A(config)# router bgp 100 A(config)# neighbor 192.168.1.2 filter-list 123 in A(config)# neighbor 192.168.2.2 filter-list 123 in</pre>
<p>Verification</p>	<ul style="list-style-type: none"> ● Run the show command to display the AS-path list. ● Run the show command to display the BGP routing table to check whether the filtering behavior is correct.
<p>A</p>	<pre>A# show ip as-path-access-list AS path access list 123 permit ^200\$ //When no AS-path list is associated with A, run the show command to check the BGP routing table. A(config)# show ip bgp BGP table version is 1, local router ID is 1.1.1.1 Status codes: s suppressed, d damped, h history, * valid, > best, i - internal, S Stale, b - backup entry Origin codes: i - IGP, e - EGP, ? - incomplete Network Next Hop Metric LocPrf Weight Path *> 10.0.0.0/24 192.168.1.2 0 0 200 i *> 20.0.0.0/24 192.168.2.2 0 0 300 i Total number of prefixes 2</pre>

```
//When an AS-path list is associated with A, run the show command to display the BGP routing table and check whether the filtering behavior is correct.

A(config)# show ip bgp

BGP table version is 1, local router ID is 1.1.1.1

Status codes: s suppressed, d damped, h history, * valid, > best, i - internal,
                S Stale, b - backup entry

Origin codes: i - IGP, e - EGP, ? - incomplete

Network          Next Hop          Metric      LocPrf      Weight Path
* > 10.0.0.0/24   192.168.1.2      0           0           200 i

Total number of prefixes 1
```

📌 **Configuring a Community List**

<p>Scenario Figure 1-8</p>	
<p>Configuration Steps</p>	<ul style="list-style-type: none"> ● Define a standard community list to match the community attribute 100:20. ● Establish EBGP neighborhood between A and B. ● Advertise a route with the community attribute on B. ● Associate the community list on A (BGP can be applied only through a route map) to filter routes received on B.
<p>A</p>	<pre>A(config)# ip community-list standard test permit 100:20 A(config)# route-map COM A(config-route-map)# match community test A(config-route-map)# exit A(config)# router bgp 100 A(config-router)# neighbor 192.168.1.2 route-map COM in</pre>
<p>B</p>	<pre>B(config)# route-map comm1 B(config-route-map)# set community 100:20 200:20 B(config-route-map)# route-map comm2</pre>

	<pre> B(config-route-map)# set community 100:20 B(config-route-map)# route-map comm3 B(config-route-map)# set community 200:20 B(config-route-map)# exit B(config)# router bgp 200 B(config-router)# neighbor 192.168.1.1 send-community B(config-router)# network 10.0.0.0 mask 255.255.255.0 route-map comm1 B(config-router)# network 20.0.0.0 mask 255.255.255.0 route-map comm2 B(config-router)# network 30.0.0.0 mask 255.255.255.0 route-map comm3 B(config-router)# network 40.0.0.0 mask 255.255.255.0 </pre>
<p>Verification</p>	<ul style="list-style-type: none"> ● Run the show command to display the community list. ● Run the show command to display the BGP routing table to check whether the filtering behavior is correct.
<p>A</p>	<pre> A# show ip community-list Named Community standard list test permit 100:20 </pre>
	<p>//When no community list is associated with A, run the show command to check the BGP routing table.</p> <pre> A# show ip bgp BGP table version is 1, local router ID is 192.168.1.1 Status codes: s suppressed, d damped, h history, * valid, > best, i - internal, S Stale, b - backup entry Origin codes: i - IGP, e - EGP, ? - incomplete Network Next Hop Metric LocPrf Weight Path * > 10.0.0.0/24 192.168.1.2 0 0 200 i * > 20.0.0.0/24 192.168.1.2 0 0 200 i * > 30.0.0.0/24 192.168.1.2 0 0 200 i * > 40.0.0.0/24 192.168.1.2 0 0 200 i Total number of prefixes 4 A# show ip bgp 10.0.0.0 BGP routing table entry for 10.0.0.0/24 </pre>

```
Paths: (1 available, best #1, table Default-IP-Routing-Table)

  Not advertised to any peer

  200

  192.168.1.2 from 192.168.1.2 (192.168.1.2)

  Origin IGP, metric 0, localpref 100, valid, external, best

  Community: 100:20 200:20

  Last update: Wed Nov 6 18:58:18 2013

A# show ip bgp 20.0.0.0
BGP routing table entry for 20.0.0.0/24
Paths: (1 available, best #1, table Default-IP-Routing-Table)

  Not advertised to any peer

  200

  192.168.1.2 from 192.168.1.2 (192.168.1.2)

  Origin IGP, metric 0, localpref 100, valid, external, best

  Community: 100:20

  Last update: Wed Nov 6 18:58:18 2013

A# show ip bgp 30.0.0.0
BGP routing table entry for 30.0.0.0/24
Paths: (1 available, best #1, table Default-IP-Routing-Table)

  Not advertised to any peer

  200

192.168.1.2 from 192.168.1.2 (192.168.1.2)
Origin IGP, metric 0, localpref 100, valid, external, best
  Community: 200:20

  Last update: Wed Nov 6 18:58:18 2013

A# show ip bgp 40.0.0.0
BGP routing table entry for 40.0.0.0/24
Paths: (1 available, best #1, table Default-IP-Routing-Table)

  Not advertised to any peer

  200

  192.168.1.2 from 192.168.1.2 (192.168.1.2)
```

<p>Origin IGP, metric 0, localpref 100, valid, external, best</p> <p>Last update: Wed Nov 6 18:58:18 2013</p>															
<p>//When a community list is associated with A, run the show command to display the BGP routing table and check whether the filtering behavior is correct.</p> <p>A# show ip bgp</p> <p>BGP table version is 1, local router ID is 192.168.1.1</p> <p>Status codes: s suppressed, d damped, h history, * valid, > best, i - internal,</p> <p style="padding-left: 40px;">S Stale, b - backup entry</p> <p>Origin codes: i - IGP, e - EGP, ? - incomplete</p> <table border="1" style="width: 100%; border-collapse: collapse; margin-top: 10px;"> <thead> <tr> <th style="text-align: left;">Network</th> <th style="text-align: left;">Next Hop</th> <th style="text-align: left;">Metric</th> <th style="text-align: left;">LocPrf</th> <th style="text-align: left;">Weight Path</th> </tr> </thead> <tbody> <tr> <td>*> 10.0.0.0/24</td> <td>192.168.1.2</td> <td>0</td> <td></td> <td>0 200 i</td> </tr> <tr> <td>*> 20.0.0.0/24</td> <td>192.168.1.2</td> <td>0</td> <td></td> <td>0 200 i</td> </tr> </tbody> </table> <p>Total number of prefixes 2</p> <p>A#</p> <p>A# show ip bgp 10.0.0.0</p> <p>BGP routing table entry for 10.0.0.0/24</p> <p>Paths: (1 available, best #1, table Default-IP-Routing-Table)</p> <p style="padding-left: 20px;">Not advertised to any peer</p> <p style="padding-left: 20px;">200</p> <p style="padding-left: 40px;">192.168.1.2 from 192.168.1.2 (192.168.1.2)</p> <p style="padding-left: 40px;">Origin IGP, metric 0, localpref 100, valid, external, best</p> <p style="padding-left: 40px;">Community: 100:20 200:20</p> <p style="padding-left: 40px;">Last update: Wed Nov 6 19:02:49 2013</p> <p>A# show ip bgp 20.0.0.0</p> <p>BGP routing table entry for 20.0.0.0/24</p> <p>Paths: (1 available, best #1, table Default-IP-Routing-Table)</p> <p style="padding-left: 20px;">Not advertised to any peer</p> <p style="padding-left: 20px;">200</p> <p style="padding-left: 40px;">192.168.1.2 from 192.168.1.2 (192.168.1.2)</p> <p style="padding-left: 40px;">Origin IGP, metric 0, localpref 100, valid, external, best</p>	Network	Next Hop	Metric	LocPrf	Weight Path	*> 10.0.0.0/24	192.168.1.2	0		0 200 i	*> 20.0.0.0/24	192.168.1.2	0		0 200 i
Network	Next Hop	Metric	LocPrf	Weight Path											
*> 10.0.0.0/24	192.168.1.2	0		0 200 i											
*> 20.0.0.0/24	192.168.1.2	0		0 200 i											

Community: 100:20 Last update: Wed Nov 6 19:02:49 2013

📌 **Configuring an Extcommunity List**

<p>Scenario Figure 1-9</p>	
<p>Configuration Steps</p>	<ul style="list-style-type: none"> ● Define an extcommunity list to match the extcommunity attribute RT 1: 100. ● Establish EBGp neighborship between A and B. ● Advertise a route with the extcommunity attribute on B. ● Associate the extcommunity list with A (BGP can be applied only through a route map) to filter routes received on B.
<p>A</p>	<pre>A(config)# ip extcommunity-list 10 permit rt 1:100 A(config)# route-map EXTCOM A(config-route-map)# match extcommunity 10 A(config-route-map)# exit A(config)# router bgp 100 A(config-router)# neighbor 192.168.1.2 route-map EXTCOM in</pre>
<p>B</p>	<pre>B(config)# route-map ecomm1 B(config-route-map)# set extcommunity rt 1:100 2:200 B(config-route-map)# route-map ecomm2 B(config-route-map)# set extcommunity rt 1:100 B(config-route-map)# route-map ecomm3 B(config-route-map)# set extcommunity rt 2:200 B(config-route-map)# exit B(config)# router bgp 200 B(config-router)# neighbor 192.168.1.1 send-community both B(config-router)# network 10.0.0.0 mask 255.255.255.0 route-map ecomm1 B(config-router)# network 20.0.0.0 mask 255.255.255.0 route-map ecomm2 B(config-router)# network 30.0.0.0 mask 255.255.255.0 route-map ecomm3</pre>

	<pre>B(config-router)# network 40.0.0.0 mask 255.255.255.0</pre>
<p>Verification</p>	<p>Run the show command to display the extcommunity list.</p> <p>Run the show command to display the BGP routing table to check whether the filtering behavior is correct.</p>
<p>A</p>	<pre>EG1000M(config)#show ip extcommunity-list Extended community standard list 10 10 permit RT:1:100</pre>
	<pre>//When no extcommunity list is associated with A, run the show command to check the BGP routing table. A# show ip bgp BGP table version is 1, local router ID is 192.168.1.1 Status codes: s suppressed, d damped, h history, * valid, > best, i - internal, S Stale, b - backup entry Origin codes: i - IGP, e - EGP, ? - incomplete Network Next Hop Metric LocPrf Weight Path * > 10.0.0.0/24 192.168.1.2 0 0 200 i * > 20.0.0.0/24 192.168.1.2 0 0 200 i * > 30.0.0.0/24 192.168.1.2 0 0 200 i * > 40.0.0.0/24 192.168.1.2 0 0 200 i Total number of prefixes 4 A# A# show ip bgp 10.0.0.0 BGP routing table entry for 10.0.0.0/24 Paths: (1 available, best #1, table Default-IP-Routing-Table) Not advertised to any peer 200 192.168.1.2 from 192.168.1.2 (192.168.1.2) Origin IGP, metric 0, localpref 100, valid, external, best Extended Community: RT:1:100 RT:2:200 Last update: Wed Nov 6 19:15:12 2013 A# show ip bgp 20.0.0.0</pre>

	<p>BGP routing table entry for 20.0.0.0/24</p> <p>Paths: (1 available, best #1, table Default-IP-Routing-Table)</p> <p>Not advertised to any peer</p> <p>200</p> <p>192.168.1.2 from 192.168.1.2 (192.168.1.2)</p> <p>Origin IGP, metric 0, localpref 100, valid, external, best</p> <p>Extended Community: RT:1:100</p> <p>Last update: Wed Nov 6 19:15:12 2013</p>
	<p>A# show ip bgp 30.0.0.0</p> <p>BGP routing table entry for 30.0.0.0/24</p> <p>Paths: (1 available, best #1, table Default-IP-Routing-Table)</p> <p>Not advertised to any peer</p> <p>200</p> <p>192.168.1.2 from 192.168.1.2 (192.168.1.2)</p> <p>Origin IGP, metric 0, localpref 100, valid, external, best</p> <p>Extended Community: RT:2:200</p> <p>Last update: Wed Nov 6 19:15:12 2013</p> <p>A# show ip bgp 40.0.0.0</p> <p>BGP routing table entry for 40.0.0.0/24</p> <p>Paths: (1 available, best #1, table Default-IP-Routing-Table)</p> <p>Not advertised to any peer</p> <p>200</p> <p>192.168.1.2 from 192.168.1.2 (192.168.1.2)</p> <p>Origin IGP, metric 0, localpref 100, valid, external, best</p> <p>Last update: Wed Nov 6 19:15:12 2013</p>
	<p>//When an extcommunity list is associated with A, run the show command to display the BGP routing table and check whether the filtering behavior is correct.</p> <p>A# show ip bgp</p> <p>BGP table version is 1, local router ID is 192.168.1.1</p> <p>Status codes: s suppressed, d damped, h history, * valid, > best, i - internal,</p> <p>S Stale, b - backup entry</p>

<p>Origin codes: i - IGP, e - EGP, ? - incomplete</p> <table border="1" style="width: 100%; border-collapse: collapse; margin-top: 10px;"> <thead> <tr> <th style="text-align: left;">Network</th> <th style="text-align: left;">Next Hop</th> <th style="text-align: left;">Metric</th> <th style="text-align: left;">LocPrf</th> <th style="text-align: left;">Weight Path</th> </tr> </thead> <tbody> <tr> <td>*> 10.0.0.0/24</td> <td>192.168.1.2</td> <td>0</td> <td></td> <td>0 200 i</td> </tr> <tr> <td>*> 20.0.0.0/24</td> <td>192.168.1.2</td> <td>0</td> <td></td> <td>0 200 i</td> </tr> </tbody> </table> <p>Total number of prefixes 2</p> <p>A#</p> <p>A# show ip bgp 10.0.0.0</p> <p>BGP routing table entry for 10.0.0.0/24</p> <p>Paths: (1 available, best #1, table Default-IP-Routing-Table)</p> <p style="padding-left: 20px;">Not advertised to any peer</p> <p style="padding-left: 20px;">200</p> <p style="padding-left: 40px;">192.168.1.2 from 192.168.1.2 (192.168.1.2)</p> <p style="padding-left: 60px;">Origin IGP, metric 0, localpref 100, valid, external, best</p> <p style="padding-left: 60px;">Extended Community: RT:1:100 RT:2:200</p> <p>Last update: Wed Nov 6 19:17:04 2013</p>	Network	Next Hop	Metric	LocPrf	Weight Path	*> 10.0.0.0/24	192.168.1.2	0		0 200 i	*> 20.0.0.0/24	192.168.1.2	0		0 200 i
Network	Next Hop	Metric	LocPrf	Weight Path											
*> 10.0.0.0/24	192.168.1.2	0		0 200 i											
*> 20.0.0.0/24	192.168.1.2	0		0 200 i											
<p>A# show ip bgp 20.0.0.0</p> <p>BGP routing table entry for 20.0.0.0/24</p> <p>Paths: (1 available, best #1, table Default-IP-Routing-Table)</p> <p style="padding-left: 20px;">Not advertised to any peer</p> <p style="padding-left: 20px;">200</p> <p style="padding-left: 40px;">192.168.1.2 from 192.168.1.2 (192.168.1.2)</p> <p style="padding-left: 60px;">Origin IGP, metric 0, localpref 100, valid, external, best</p> <p style="padding-left: 60px;">Extended Community: RT:1:100</p> <p style="padding-left: 20px;">Last update: Wed Nov 6 19:17:04 2013</p>															

Common Errors

- A filtering list is configured but is not correctly applied in a routing protocol, which causes that the filtering list cannot take effect.

1.5Monitoring

Displaying

Description	Command
Displays the configurations of a route map.	show route-map [<i>route-map-name</i>]
Displays the configurations of an ACL.	show access-lists [<i>id</i> <i>name</i>]
Displays the configurations of an IPv4 prefix-list.	show ip prefix-list [<i>prefix-name</i>]
Displays the configurations of an IPv6 prefix-list.	show ipv6 prefix-list [<i>prefix-name</i>]
Displays the configurations of an AS-path list.	show ip as-path-access-list [<i>num</i>]
Displays the configurations of a community list.	show ip community-list [<i>community-list-number</i> <i>community-list-name</i>]
Displays the configurations of an extcommunity list.	show ip extcommunity-list [<i>extcommunity-list-num</i> <i>extcommunity-list-name</i>]

2 Configuring Keys

2.1 Overview

Keys are a kind of parameters that are used in algorithms for conversion from plain text to cipher text or from cipher text to plain text. Plain text and cipher text authentication are supported for packet authentication in a routing protocol, during which keys need to be used.

At present, keys are used only for RIP and ISIS packet authentication.

2.2 Applications

Application	Description
RIP Authentication	RIP uses keys for packet authentication.

2.2.1 RIP Authentication

Scenario

Network devices run RIP and use the MD5 authentication mode to increase the protocol security.

Figure 2- 1

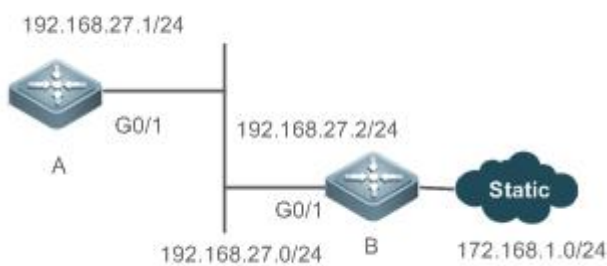

Deployment

- Configure a key chain on A. Configure RIP to enable packet authentication and use the key chain.
- Configure a key chain on B. Configure RIP to enable packet authentication and use the key chain.

2.3 Features

Overview

Feature	Description
Key Chain	Provide a tool for authentication in a routing protocol.

2.3.1 Key Chain

Working Principle

A key chain may contain multiple different keys. Each key contains the following attributes:

- Key ID: Identifies a key. In the current key chain, keys and IDs are mapped in the one-to-one manner.
- Authentication string: Indicates a set of key characters used for verifying the consistency of authentication strings in a routing protocol.
- Lifetime: Specifies the lifetime of the current key for sending or receiving packets. Different authentication keys can be used in different periods.

Related Configuration

↘ Creating a Key Chain and a Key

In the global configuration mode, run the **key chain** *key-chain-name* command to define a key chain and enter the key chain configuration mode.

In the key chain configuration mode, run the **key** *key-id* command to define a key and enter the key chain key configuration mode.

↘ Configuring an Authentication String

In the key chain key configuration mode, run the **key-string** **[0|7]** *text* command to specify an authentication string.

- A plain text authentication string is configured by default. The value **0** indicates that a plain text authentication key is configured.
- The value **7** indicates that a cipher text authentication string is configured.
- The encryption authentication service is disabled by default. You can run the **service password-encryption** command to enable the encryption service to forcibly convert plain text authentication into cipher text.

↘ Configuring Lifetime

In the key chain key configuration mode, you can configure the lifetime of a key chain in the receiving and sending directions.

- **accept-lifetime** *start-time* { **infinite** | *end-time* | **duration** *seconds* }: Configures the lifetime of a key chain in the receiving direction.
- **send-lifetime** *start-time* { **infinite** | *end-time* | **duration** *seconds* }: Configures the lifetime of a key chain in the sending direction.

2.4 Configuration

Configuration	Description and Command	
Configuring a Key Chain	(Mandatory) It is used to create a key.	
	key chain	Creates a key chain.
	key	Configures a key ID.
	key-string	Configures a key string.
	accept-lifetime	Configures the lifetime in the receiving direction.
	send-lifetime	Configures the lifetime in the sending direction.

2.4.1 Configuring a Key Chain

Configuration Effect

- Define a key chain to be used by a routing protocol.

Notes

- A key chain can take effect only after it is associated with a routing protocol.

Configuration Steps

↘ Creating a Key Chain

- This configuration is mandatory if a key chain needs to be used.
- If there is no special requirement, you should perform this configuration on all routers for which routing protocol authentication needs to be performed.

↘ Configuring a Key ID

- This configuration is mandatory if a key chain needs to be used.
- If there is no special requirement, you should perform this configuration on all routers for which routing protocol authentication needs to be performed.

↘ Configuring a Key String

- This configuration is mandatory if a key chain needs to be used.
- If there is no special requirement, you should perform this configuration on all routers for which routing protocol authentication needs to be performed.

↘ Configure the Lifetime in the Receiving Direction

- Optional.
- If the lifetime in the sending direction is not configured, the key chain will be always effective.

↘ Configure the Lifetime in the Sending Direction

- Optional.
- If the lifetime in the sending direction is not configured, the key chain will be always effective.

Verification

- Use keys in a routing protocol and observe the neighborhood established by the routing protocol. If the keys are inconsistent, the neighborhood fails to be established.

Related Commands

↘ Configuring a Key Chain

Command	key chain <i>key-chain-name</i>
Parameter	<i>key-chain-name</i> : Indicates the name of a key chain.
Description	
Command Mode	Global configuration mode
Usage Guide	To make a key chain take effect, you must configure at least one key.

↘ Configuring a Key ID

Command	key <i>key-id</i>
Parameter	<i>key-id</i> : Indicates the authentication key ID in a key chain, ranging from 0 to 2,147,483,647.
Description	
Command Mode	Key chain configuration mode.
Usage Guide	-

↘ Configuring a Key Authentication String

Command	key-string [0 7] <i>text</i>
Parameter	0 : Specifies that the key is displayed in plain text.
Description	7 : Specifies that the key is displayed in cipher text. text : Specifies the authentication string characters.
Command Mode	Key chain key configuration mode.
Usage Guide	-

↘ Configuring the Lifetime in the Sending Direction

Command	send-lifetime <i>start-time</i> { infinite <i>end-time</i> duration <i>seconds</i> }
Parameter	start-time : Indicates the start time of the lifetime.
Description	infinite : Indicates that the key is always effective. end-time : Indicates the end time of the lifetime, which must be later than start-time. duration seconds : Specifies the duration from the start time to the end time, ranging from 1 to 2,147,483,646.
Command Mode	Key chain key configuration mode.
Usage Guide	Run this command to define the lifetime of the key in the sending direction.

↘ Configuring the Lifetime in the Receiving Direction

Command	accept-lifetime <i>start-time</i> { infinite <i>end-time</i> duration <i>seconds</i> }
----------------	---

Parameter	start-time: Indicates the start time of the lifetime.
Description	infinite: Indicates that the key is always effective. end-time: Indicates the end time of the lifetime, which must be later than start-time. duration seconds: Specifies the duration from the start time to the end time, ranging from 1 to 2,147,483,646.
Command	Key chain key configuration mode.
Mode	
Usage Guide	Run this command to define the lifetime of the key in the receiving direction.

Configuration Example

📌 **Configuring a Key Chain and Using the Key Chain in RIP Packet Authentication**

<p>Scenario Figure 2- 2</p>	
<p>Configuration Steps</p>	<ul style="list-style-type: none"> ● Configure a key on all routers. ● Configure RIP on all routers. ● Enable RIP authentication on all routers.
<p>A</p>	<pre> A>enable A#configure terminal A(config)#key chain ripchain A(config-keychain)#key 1 A(config-keychain-key)#key-string Hello A(config-keychain-key)#accept-lifetime 16:30:00 Oct 1 2013 duration 43200 A(config-keychain-key)#send-lifetime 16:30:00 Oct 1 2013 duration 43200 A(config-keychain-key)#exit A(config-keychain)#key 2 A(config-keychain-key)#key-string World A(config-keychain-key)#accept-lifetime 04:00:00 Oct 2 2013 infinite A(config-keychain-key)#send-lifetime 04:00:00 Oct 2 2013 infinite A(config-keychain-key)#exit A(config)#interface gigabitEthernet 0/1 A(config-if)#ip address 192.168.27.1 255.255.255.0 A(config-if)#ip rip authentication key-chain ripchain </pre>

	<pre>A(config-if)#ip rip authentication mode md5 A(config-if)#exit A(config)#router rip A(config-router)#version 2 A(config-router)#network 192.168.27.0</pre>
<p>B</p>	<pre>B>enable B#configure terminal B(config)#key chain ripchain B(config-keychain)#key 1 B(config-keychain-key)#key-string Hello B(config-keychain-key)#accept-lifetime 16:30:00 Oct 1 2013 duration 43200 B(config-keychain-key)#send-lifetime 16:30:00 Oct 1 2013 duration 43200 B(config-keychain-key)#exit B(config-keychain)#key 2 B(config-keychain-key)#key-string World B(config-keychain-key)#accept-lifetime 04:00:00 Oct 2 2013 infinite B(config-keychain-key)#send-lifetime 04:00:00 Oct 2 2013 infinite B(config-keychain-key)#exit B(config)#interface gigabitEthernet 0/1 B(config-if)#ip address 192.168.27.2 255.255.255.0 B(config-if)#ip rip authentication key-chain ripchain B(config-if)#ip rip authentication mode md5 B(config-if)#exit B(config)#router rip B(config-router)#version 2 B(config-router)#network 192.168.27.0 B(config-router)#redistribute static</pre>
<p>Verification</p>	<p>Run the show ip route rip command to check whether router A can receive an RIP route from router B.</p>
<p>A</p>	<pre>A(config)#show ip route rip R 172.168.0.0/16 [120/1] via 192.168.27.2, 00:05:16, GigabitEthernet 0/1</pre>

Common Errors

- A key is not correctly associated with a routing protocol, which causes that authentication does not take effect.
- The keys configured on multiple routers are not consistent, which causes authentication failure.

2.5 Monitoring

Displaying

Description	Command
Displays the configurations of a key chain.	show key chain [<i>key-chain-name</i>]

3 Configuring RIP

3.1 Overview

Routing Information Protocol (RIP) is a unicast routing protocol applied on IPv4 networks. RIP-enabled routers exchange routing information to obtain routes to remote networks.

As an Interior Gateway Protocol (IGP), RIP can run only within the autonomous system (AS) and is applicable to small-sized networks whose longest path involves less than 16 hops.

Protocols and Standards

- RFC1058: Defines RIPv1.
- RFC2453: Defines RIPv2.

3.2 Applications

Application	Description
Basic RIP Application	The routing information is automatically maintained through RIP on a small-sized network.
Interworking Between RIP and BGP	Several ASs are interconnected. RIP runs within each AS, and Border Gateway Protocol (BGP) runs between ASs.

3.2.1 Basic RIP Application

Scenario

On a network with a simple structure, you can configure RIP to implement network interworking. Configuring RIP is simpler than configuring other IGP protocols like Open Shortest Path First (OSPF). Compared with static routes, RIP can dynamically adapt to the network structure changes and is easier to maintain.

As shown in Figure 3- 1, to implement interworking between PC1, PC2, and PC3, you can configure RIP routes on R1, R2, and R3.

Figure 3- 1

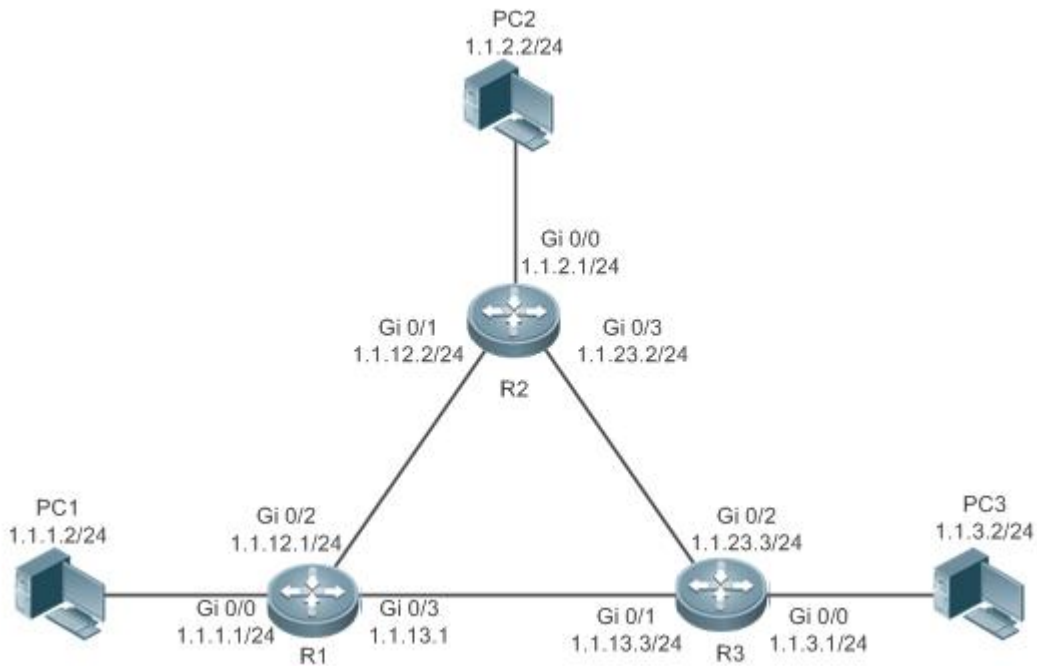

Deployment

- Configure IP addresses and gateways on three PCs.
- Configure IP addresses and subnet masks on three routers.
- Configure RIP on three routers.

3.2.2 Interworking Between RIP and BGP

Scenario

Several ASs are interconnected. RIP runs within each AS, and BGP runs between ASs. Generally, RIP and BGP learn the routing information from each other.

As shown in Figure 3- 2, unicast routing is implemented within AS 100 and AS 200 using RIP, and between the two ASs using BGP.

Figure 3- 2 Interworking Between RIP and BGP

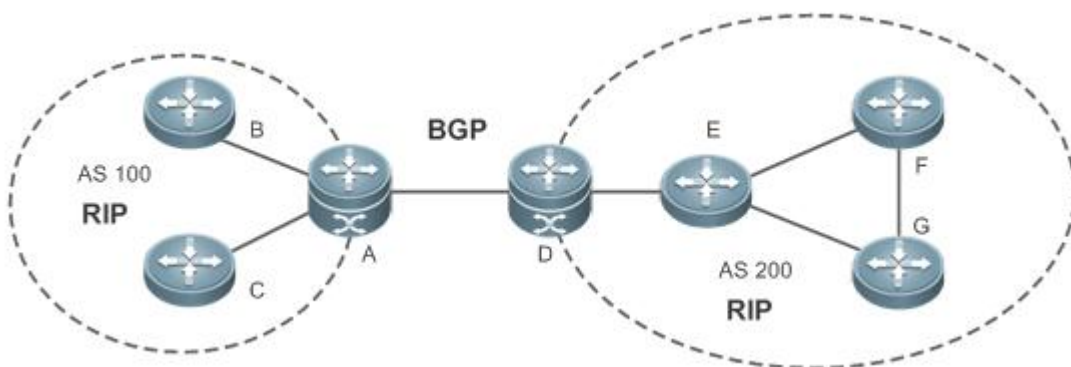

Remarks	RIP and BGP run concurrently on Router A and Router D.
----------------	--

Deployment

- RIP runs within AS 100 and AS 200 to implement unicast routing.
- BGP runs between the two ASs to implement unicast routing.

3.3Features

Basic Concepts

↘ **IGP and EGP**

IGP runs within an AS. For example, RIP is a type of IGP.

Exterior Gateway Protocol (EGP) runs between ASs. For example, BGP is a type of EGP.

↘ **Classful Routing Protocol and Classless Routing Protocol**

Protocols can be classified based on the type of routes supported:

- Classful routing protocol: It supports classful routes. For example, RIPv1 is a classful routing protocol.
- Classless routing protocol: It supports classless routes. For example, RIPv2 is a classless routing protocol.

Overview

Feature	Description
RIPv1 and RIPv2	RIP is available in two versions: RIPv1 and RIPv2.
Exchanging Routing Information	By exchanging routing information, RIP-enabled devices can automatically obtain routes to a remote network and update the routes in real time.
Routing Algorithm	RIP is a protocol based on the distance-vector algorithm. It uses the vector addition method to compute the routing information.
Avoiding Route Loops	RIP uses functions, such as split horizon and poison reverse, to avoid route loops.
Security Measures	RIP uses functions, such as authentication and source address verification, to ensure protocol security.
Reliability Measures	RIP uses functions, such as bidirectional forwarding detection (BFD) correlation, fast reroute, and graceful restart (GR), to enhance reliability of the protocol.
Multiple Instances	RIP supports multiple instances and VPN applications.

3.3.1RIPv1 and RIPv2

Two RIP versions are available: RIPv1 and RIPv2.

Working Principle

↘ **RIPv1**

RIPv1 packets are broadcast. The broadcast address is 255.255.255.255, and the UDP port ID is 520. RIPv1 cannot identify the subnet mask, and supports only classful routes.

↘ **RIPv2**

RIPv2 packets are multicast. The multicast address is 224.0.0.9, and the UDP port ID is 520. RIPv2 can identify the subnet mask, and supports classless routes, summarized route, and supernetting routes. RIPv2 supports plain text authentication and message digest 5 (MD5) authentication.

Related Configuration

↳ Enabling the RIP Process

The RIP process is disabled by default.

Run the **router rip** command to enable the RIP process.

You must enable the RIP process on a device; otherwise, all functions related to RIP cannot take effect.

↳ Running RIP on an Interface

By default, RIP does not run on an interface.

Run the **network** command to define an address range. RIP runs on interfaces that belong to this address range.

After RIP runs on an interface, RIP packets can be exchanged on the interface and RIP can learn routes to the network segments directly connected to the device.

↳ Defining the RIP Version

By default, an interface receives RIPv1 and RIPv2 packets, and sends RIPv1 packets.

Run the **version** command to define the version of RIP packets sent or received on all interfaces.

Run the **ip rip send version** command to define the version of RIP packets sent on an interface.

Run the **ip rip receive version** command to define the version of RIP packets received on an interface.

 If the versions of RIP running on adjacent routers are different, the RIPv1-enabled router will learn incorrect routes.

↳ Preventing an Interface from Sending or Receiving Packets

By default, a RIP-enabled interface is allowed to send and receive RIP packets.

Run the **no ip rip receive enable** command to prevent an interface from receiving RIP packets.

Run the **no ip rip send enable** command to prevent an interface from sending RIP packets.

Run the **passive-interface** command to prevent an interface from sending broadcast or multicast RIP packets.

↳ Configuring the Mode for Sending RIP Packets

By default, broadcast RIPv1 packets and multicast RIPv2 are sent.

Run the **ip rip v2-broadcast** command to send broadcast RIPv2 packets on an interface.

Run the **neighbor** command to send unicast RIP packets to a specified neighbor router.

3.3.2 Exchanging Routing Information

Compared with static routing, the dynamic routing protocol has a significant advantage, that is, by exchanging routing information, devices can automatically obtain routes to a remote network and update the routes in real time.

Working Principle

↳ Initialization

After RIP is enabled on a router, the router sends a request packet to its neighbor router, requesting for all routing information, that is, the routing table. After receiving the request message, the neighbor router returns a response packet containing the local routing

table. After receiving the response packet, the router updates the local routing table, and sends an update packet to the neighbor router, informing the neighbor router of the route update information. After receiving the update packet, the neighbor router updates the local routing table, and sends the update packet to other adjacent routers. After a series of updates, all routers can obtain and retain the latest routing information.

↘ Periodical Update

By default, periodical update is enabled for RIP. Adjacent routers exchange complete routing information with each other every 30s (update timer), that is, the entire routing table is sent to neighbor routers. One update packet contains at most 25 routes. Therefore, a lot of update packets may be required to send the entire routing table. You can set the sending delay between update packets to avoid loss of routing information.

-  For every non-local route, if the route is not updated within 180s (invalid timer), the metric of the route is changed to 16 (unreachable). If the route is still not updated in the next 120s (flush timer), the route is deleted from the routing table.

↘ Triggered Updates

After the triggered updates function is enabled, periodical update is automatically disabled. When routing information changes on a router, the router immediately sends routes related to the change (instead of the complete routing table) to the neighbor router, and use the acknowledgment and retransmission mechanisms to ensure that the neighbor router receives the routes successfully. Compared with periodical update, triggered updates help reduce flooding and accelerates route convergence.

Events that can trigger update include router startup, interface status change, changes in routing information (such as the metric), and reception of a request packet.

↘ Route Summarization

When sending routing information to a neighbor router, the RIP-enabled router summarizes subnet routes that belong to the same classful network into a route, and sends the route to the neighbor router. For example, summarize 80.1.1.0/24 (metric=2) and 80.1.2.0/24 (metric=3) into 80.0.0.0/8 (metric=2), and set the metric of the summarized route to the optimum metric.

Only RIPv2 supports route summarization. Route summarization can reduce the size of the routing table and improve the efficiency of routing information exchange.

↘ Supernetting Route

If the subnet mask length of a route is smaller than the natural mask length, this route is called supernetting route. For example, in the 80.0.0.0/6 route, as 80.0.0.0 is a Class A network address and the natural mask is 8 bits, 80.0.0.0/6 route is a supernetting route.

Only RIPv2 supports supernetting routes.

↘ Default Route

In the routing table, a route to the destination network 0.0.0.0/0 is called default route.

The default route can be learned from a neighbor router, or sent to a neighbor router.

↘ Route Redistribution

For RIP, other types of routes (such as direct routes, static routes, and routes of other routing protocols) are called external routes.

External routes (excluding the default route) can be redistributed to RIP and advertised to neighbors.

↘ Route Filtering

Filtering conditions can be configured to limit the routing information exchanged between adjacent routers. Only the routing information that meets filtering conditions can be sent or received.

Related Configuration

↘ Sending Delay Between Update Packets

By default, the update packets are sent continuously without any delay.

Run the **output-delay** command to set the sending delay between update packets.

↘ RIP Timers

By default, the update timer is 30s, the invalid timer is 180s, and the flush timer is 120s.

Run the **timers basic** command to modify durations of the RIP timers.

Increasing the duration of the flush timer can reduce the route flapping. Decreasing the duration of the flush timer helps accelerate route convergence.

The durations of RIP timers must be consistent on adjacent routers. Unless otherwise required, you are advised not to modify the RIP timers.

↘ Triggered Updates

By default, periodical update is enabled.

Run the **ip rip triggered** command to enable triggered updates on the interface and disable periodical update.

Run the **ip rip triggered retransmit-timer** command to modify the retransmission interval of update packets. The default value is 5s.

Run the **ip rip triggered retransmit-count** command to modify the maximum retransmission times of update packets. The default value is 36.

↘ Route Summarization

By default, route summarization is automatically enabled if an interface is allowed to send RIPv2 packets.

Run the **no auto-summary** command to disable route summarization.

Run the **ip rip summary-address** command to configure route summarization on an interface.

↘ Supernetting Route

By default, supernetting routes can be sent if an interface is allowed to send RIPv2 packets.

Run the **no ip rip send supernet-routes** command to prevent the sending of supernetting routes.

↘ Default Route

Run the **ip rip default-information** command to advertise the default route to neighbors on an interface.

Run the **default-information originate** command to advertise the default route to neighbors from all interfaces.

↘ Route Redistribution

Run the **redistribute** command to redistribute external routes (excluding the default route) to RIP and advertise them to neighbors.

↘ Route Filtering

Run the **distribute-list out** command to set filtering rules to limit the routing information sent by the device.

Run the **distribute-list in** command to set filtering rules to limit the routing information received by the device.

3.3.3 Routing Algorithm

RIP is a protocol based on the distance-vector algorithm. It uses the vector addition method to compute the routing information.

Working Principle

Distance-Vector Algorithm

RIP is a protocol based on the distance-vector algorithm. The distance-vector algorithm treats a route as a vector that consists of the destination network and distance (metric). The router obtains a route from its neighbor and adds the distance vector from itself to the neighbor to the route to form its own route.

RIP uses the hop count to evaluate the distance (metric) to the destination network. By default, the hop count from a router to its directly connected network is 0, the hop count from a router to a network that can be reached through the router is 1, and so on. That is, the metric is equal to the number of routers from the local network to the destination network. To restrict the convergence time, RIP stipulates that the metric must be an integer between 0 and 15. If the metric is equal to or greater than 16, the destination network or host is unreachable. For this reason, RIP cannot be applied on a large-scale network.

As shown in Figure 3- 3, Router A is connected to the network 10.0.0.0. Router B obtains the route (10.0.0.0,0) from Router A and adds the metric 1 to the route to obtain its own route ((10.0.0.0,1), and the next hop points to Router A.

Figure 3- 3

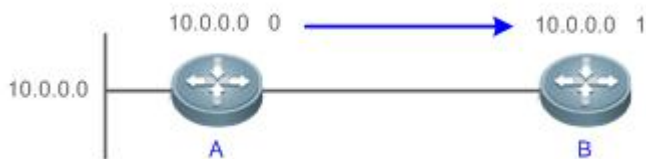

Selecting the Optimum Route

RIP selects an optimum route based on the following principle: If multiple routes to the same destination network is available, a router preferentially selects the route with the smallest metric.

As shown in Figure 3- 4, Router A is connected to the network 10.0.0.0. Router C obtains the route (10.0.0.0,0) from Router A and the route (10.0.0.0,1) from Router B. Router C will select the route that is obtained from Router A and add metric 1 to this route to form its own route (10.0.0.0,1), and the next hop points to Router A.

Figure 3- 4

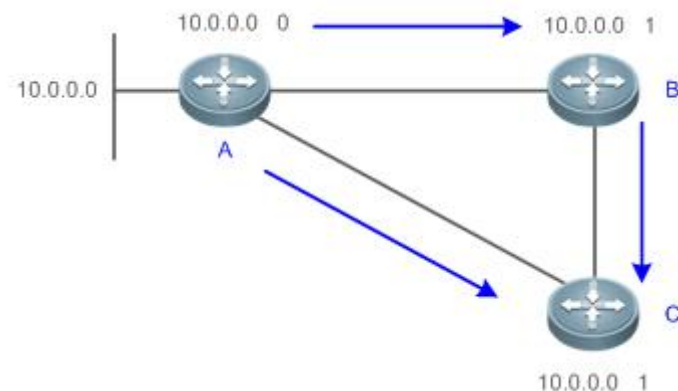

i When routes coming from different sources exist on a router, the route with the smallest distance is preferentially selected.

Route Source	Default Distance
Directly-connected network	0
Static route	1
OSPF route	110
IS-IS route	115
RIP route	120
Unreachable route	255

Related Configuration

↳ Modifying the Distance

By default, the distance of a RIP route is 120.

Run the **distance** command to modify the distance of a RIP route.

↳ Modifying the Metric

For a RIP route that is proactively discovered by a device, the default metric is equal to the number of hops from the local network to the destination network. For a RIP router that is manually configured (default route or redistributed route), the default metric is 1.

Run the **offset-list in** command to increase the metric of a received RIP route.

Run the **offset-list out** command to increase the metric of a sent RIP route.

Run the **default-metric** command to modify the default metric of a redistributed route.

Run the **redistribute** command to modify the metric of a route when the route is redistributed.

Run the **default-information originate** command to modify the metric of a default route when the default route is introduced.

Run the **ip rip default-information** command to modify the metric of a default route when the default route is created.

3.3.4 Avoiding Route Loops

RIP uses functions, such as split horizon and poison reverse, to avoid route loops.

Working Principle

↳ Route Loop

A RIP route loop occurs due to inherent defects of the distance-vector algorithm.

As shown in Figure 3- 5, Router A is connected to the network 10.0.0.0, and sends an update packet every 30s. Router B receives the route 10.0.0.0 from Router A every 30s. If Router A is disconnected from 10.0.0.0, the route to 10.0.0.0 will be deleted from the routing table on Router A. Next time, the update packet sent by Router A no longer contains this route. As Router B does not receive an update packet related to 10.0.0.0, Router B determines that the route to 10.0.0.0 is valid within 180s and uses the Update packet to send this route to Router A. As the route to 10.0.0.0 does not exist on Router A, the route learned from Router B is added to the routing table. Router B determines that data can reach 10.0.0.0 through Router A, and Router A determines that data can reach 10.0.0.0 through Router B. In this way, a route loop is formed.

Figure 3- 5

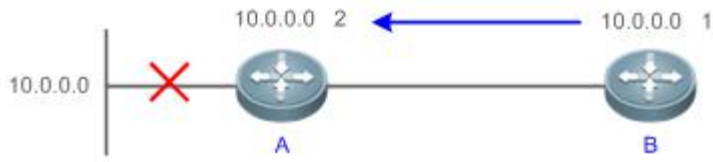

Split Horizon

Split horizon can prevent route loops. After split horizon is enabled on an interface, a route received on this interface will not be sent out from this interface.

As shown in Figure 3-6, after split horizon is enabled on the interface between Router A and Router B, Router B will not send the route 10.0.0.0 back to Router A. Router B will learn 180s later that 10.0.0.0 is not reachable.

Figure 3-6

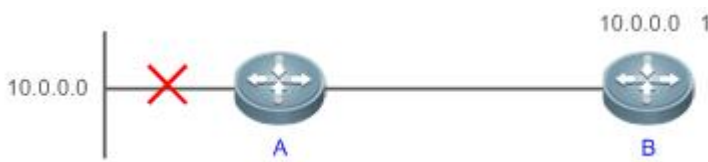

Poison Reverse

Poison reverse can also prevent route loops. Compared with split horizon, poison reverse is more reliable, but brings more protocol packets, which makes network congestion more severe.

After poison reverse is enabled on an interface, a route received from this interface will be sent out from this interface again, but the metric of this router will be changed to 16 (unreachable).

As shown in Figure 3-7, after learning the route 10.0.0.0 from Router A, Router B sets the metric of this route to 16 and sends the route back to Router A. After this route becomes invalid, Router B advertises the route 10.0.0.0 (metric = 16) to Router A to accelerate the process of deleting the route from the routing table.

Figure 3-7

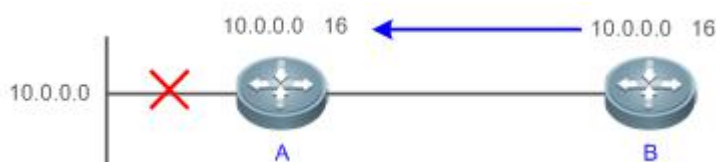

Related Configuration

Split Horizon

By default, split horizon is enabled.

Run the **no ip rip split-horizon** command to disable split horizon.

Poison Reverse

By default, poison reverse is disabled.

Run the **ip rip split-horizon poisoned-reverse** command to enable poison reverse. (After poison reverse is enabled, split horizon is automatically disabled.)

3.3.5 Security Measures

RIP uses functions, such as authentication and source address verification, to ensure protocol security.

Working Principle

➤ Authentication



RIPv2 supports authentication, but RIPv1 does not.

After authentication is enabled on an interface, the routing information cannot be exchanged between adjacent devices if authentication fails. The authentication function is used to prevent unauthorized devices from accessing the RIP routing domain.

RIPv2 supports plain text authentication and MD5 authentication.

➤ Source Address Verification

When a RIP-enabled device receives an Update packet, it checks whether the source IP address in the packet and the IP address of the inbound interface are in the same network segment. If not, the device drops the packet. Source address verification is used to ensure that RIP routing information is exchanged only between adjacent routing devices.

-  On an unnumbered IP interface, source address verification is not performed (not configurable).
-  If the triggered updates function is enabled, source address verification is automatically enabled (not configurable).
-  If split horizon is disabled, source address verification is automatically enabled (not configurable).

Related Configuration

➤ Authentication

By default, authentication is disabled.

Run the **ip rip authentication mode text** command to enable plain text authentication on an interface.

Run the **ip rip authentication mode md5** command to enable MD5 authentication on an interface.

Run the **ip rip authentication text-password** command to set the password for plain text authentication on an interface.

Run the **ip rip authentication key-chain** command to reference the key in the configured key chain as the authentication key on an interface.

➤ Source Address Verification

By default, source address verification is enabled.

Run the **no validate-update-source** command to disable source address verification.

3.3.6 Reliability Measures

RIP uses functions, such as BFD correlation, fast reroute, and GR to enhance reliability of the protocol.

Working Principle

➤ BFD Correlation and Fast Reroute

When a link or a device is faulty on the network, packets transmitted through this route will be lost until the route is converged again.

As shown in Figure 3-8, after the link between Router A and Router S is faulty, Router B may wait 180s before it can detect the failure of the route (Destination network: 10.0.0.0; Next hop: Router A). Later, Router B may need to wait 30s to re-obtain the route (Destination network: 10.0.0.0; Next hop: Router C) from Router C. Therefore, the traffic is interrupted for 210s.

Figure 3-8

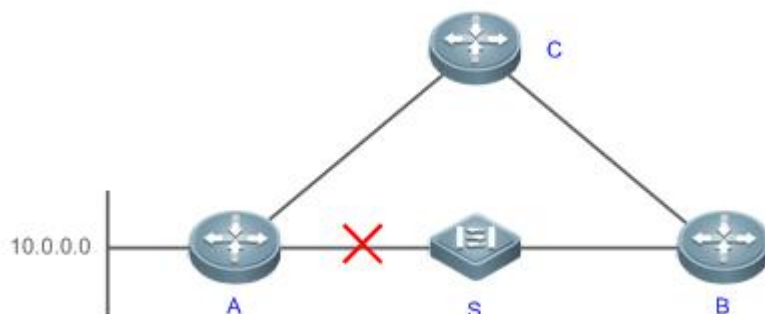

Quick detection of a route failure or fast switchover to the standby route helps shorten the traffic interruption time.

- A BFD session can be set up between Router A and Router B, and correlated with RIP. BFD can quickly test the connectivity between adjacent routers. Once a link is faulty, RIP can detect the route failure within 1s.
- The fast reroute function can be enabled. A standby route (Destination network: 10.0.0.0; Next hop: Router C) can be configured on Router B in advance. Once RIP detects a route failure, the standby route is immediately enabled.
- GR

GR ensures uninterrupted data transmission when the protocol is restarted. If RIP is restarted on a GR-enabled device, the forwarding table before restart will be retained and a request packet will be sent to the neighbor so that the route can be learned again. During the GR period, RIP completes re-convergence of the route. After the GR period expires, RIP updates the forwarding entry and advertises the routing table to the neighbor.

Related Configuration

📌 BFD Correlation

By default, RIP is not correlated with BFD.

Run the **bfd all-interfaces** command to set up the correlation between RIP and BFD. This configuration takes effect on all interfaces.

Run the **ip rip bfd** command to set up the correlation between RIP and BFD on the current interface.

📌 Fast Reroute

By default, fast reroute is disabled.

Run the **fast-reroute route-map** command to enable fast reroute and reference the route map.

Run the **set fast-reroute backup-interface backup-nexthop** command to configure a standby route in the route map.

3.3.7 Multiple Instances

Working Principle

Multiple VPN instances may exist on a device.

RIP supports multiple instances. You can enable the RIP process in VPN routing and forwarding (VRF) address family mode to run RIP on VPN instances. One VRF address family is mapped to one VPN instance.

VPN instances cannot be distinguished from each other when you perform RIP operations using SNMP. You must bind the management information base (MIB) of RIP with a VPN instance before the SNMP operations take effect on the VPN instance.

Related Configuration

↘ VRF Address Family

By default, the RIP process runs on a public network instance.

Run the **address-family** command to create a VRF address family and enter VRF address family mode.

Run the **exit-address-family** command to exit from VRF address family mode.





Run the **no address-family** command to delete a VRF address family.









↘ MIB Binding



By default, the RIP MIB is bound with a public network instance.

Run the **enable mib-binding** command to bind the RIP MIB with a VPN instance.

3.4 Configuration

Configuration	Description and Command	
Configuring RIP Basic Functions	 (Mandatory) It is used to build a RIP routing domain.	
	router rip	Enables a RIP routing process and enters routing process configuration mode.
	network	Runs RIP on interfaces in the specified address range.
	version	Defines the RIP version.
	ip rip split-horizon	Enables split horizon or poison reverse on an interface.
	passive-interface	Configures a passive interface.
Controlling Interaction of RIP Packets	 (Optional) This configuration is required if you wish to change the default mechanism for sending or receiving RIP packets.	
	neighbor	Sends unicast RIP packets to a specified neighbor.
	ip rip v2-broadcast	Sends broadcast RIPv2 packets on an interface.
	ip rip receive enable	Allows the interface to receive RIP packets.
	ip rip send enable	Allows the interface to send RIP packets.
	ip rip send version	Defines the version of RIP packets sent on an interface.
	ip rip receive version	Defines the version of RIP packets received on an interface.
Enabling Triggered Updates	 Optional.	
	ip rip triggered	Enables triggered updates on an interface.
Enabling Source Address	 Optional.	

Configuration	Description and Command	
Verification	validate-update-source	Enables source address verification.
Enabling Authentication	 (Optional) Only RIPv2 supports authentication.	
	ip rip authentication mode	Enables authentication and sets the authentication mode on an interface.
	ip rip authentication text-password	Configures the password for plain text authentication on an interface.
	ip rip authentication key-chain	Configures the authentication key chain on an interface.
Enabling Route Summarization	 (Optional) Only RIPv2 supports route summarization.	
	auto-summary	Enables automatic summarization of RIP routes.
	ip rip summary-address	Configures route summarization on an interface.
Enabling Supernetting Routes	 (Optional) Only RIPv2 supports supernetting routes.	
	ip rip send supernet-routes	Enables advertisement of RIP supernetting routes on an interface
Advertising the Default Route or External Routes	 Optional.	
	ip rip default-information	Advertises the default route to neighbors on an interface.
	default-information originate	Advertises the default route to neighbors.
	redistribute	Redistributes routes and advertises external routes to neighbors.
Setting Route Filtering Rules	 Optional.	
	distribute-list in	Filters the received RIP routing information.
	distribute-list out	Filters the sent RIP routing information.
Modifying Route Selection Parameters	 Optional.	
	distance	Modifies the administrative distance (AD) of a RIP route.
	offset-list	Increases the metric of a received or sent RIP route.
	default-metric	Configures the default metric of an external route redistributed to RIP.
Modifying Timers	 Optional.	
	timers basic	Modifies the update timer, invalid timer, and flush timer.
	output-delay	Sets the sending delay between RIP route update packets.
Enabling BFD Correlation	 Optional.	
	bfd all-interfaces	Correlates RIP with BFD on all interfaces.
	ip rip bfd	Correlates RIP with BFD on an interface.
Enabling Fast Reroute	 Optional.	
	fast-reroute route-map	Enables fast reroute and references the route map.
	set fast-reroute backup-interface	Configures the standby interface and standby next

Configuration	Description and Command	
	backup-nexthop	hop for fast reroute in the route map.
Enabling GR	 Optional.	
	graceful-restart	Configures the GR restarter capability.
Enabling Multiple Instances	 (Optional) It is used to run RIP on VPN instances.	
	address-family ipv4 vrf	Creates a VRF address family and enters IPv4 VRF address family mode.
	exit-address-family	Exits from an IPv4 VRF address family.
	enable mib-binding	Binds RIP MIB with a VPN instance.

3.4.1 Configuring RIP Basic Functions

Configuration Effect

- Build a RIP routing domain on the network.
- Routers in the domain obtain routes to a remote network through RIP.

Notes

- IPv4 addresses must be configured.
- IPv4 unicast routes must be enabled.

Configuration Steps

▾ Enabling a RIP Routing Process

- Mandatory.
- Unless otherwise required, this configuration must be performed on every router in the RIP routing domain.

▾ Associating with the Local Network

- Mandatory.
- Unless otherwise required, this configuration must be performed on every router in the RIP routing domain.
- Unless otherwise required, the local network associated with RIP should cover network segments of all L3 interfaces.

▾ Defining the RIP Version

- If RIPv2 functions (such as the variable length subnet mask and authentication) are required, enable the RIPv2.
- Unless otherwise required, you must define the same RIP version on every router.

▾ Enabling Split Horizon or Poison Reverse

- By default, split horizon is enabled and poison reverse is disabled.
- Unless otherwise required, enable split horizon on every interface connected to the broadcast network, such as the Ethernet. (Retain the default setting.)
- Unless otherwise required, enable split horizon on every interface connected to the point-to-point (P2P) network, such as the PPP and HDLC. (Retain the default setting.)

- It is recommended that split horizon and poison reverse be disabled on an interface connected to a non-broadcast multi-access (NBMA) network, such as FR and X.25; otherwise, some devices may fail to learn the complete routing information.
- If the secondary IP address is configured for an interface connected to a non-broadcast, it is recommended that split horizon and poison reverse be disabled.

➤ **Configuring a Passive Interface**

- If you want to suppress Update packets on a RIP interface, configure the interface as a passive interface.
- Use the passive interface to set the boundary of the RIP routing domain. The network segment of the passive interface belongs to the RIP routing domain, but RIP packets cannot sent over the passive interface.
- If RIP routes need to be exchanged on an interface (such as the router interconnect interface) in the RIP routing domain, this interface cannot be configured as a passive interface.

Verification

- Check the routing table on a router to verify that the route to a remote network can be obtained through RIP.

Related Commands

➤ **Enabling a RIP Routing Process**

Command Syntax	router rip
Parameter Description	N/A
Command Mode	Global configuration mode
Configuration Usage	This command is used to create a RIP routing process and enter routing process configuration mode.

➤ **Associating with the Local Network**

Command Syntax	network <i>network-number</i> [<i>wildcard</i>]
Parameter Description	<i>network-number</i> : Indicates the number of a network. <i>wildcard</i> : Defines the IP address comparison bit. 0 indicates accurate matching, and 1 indicates that no comparison is performed.
Command Mode	Routing process configuration mode
Configuration Usage	RIP can run and learn direct routes and RIP packets can be exchanged only on an interface covered by network . If network 0.0.0.0 255.255.255.255 is configured, all interfaces are covered. If <i>wildcard</i> is not configured, the classful address range is used by default, that is, the interfaces whose addresses fall into the classful address range participate in RIP operations.

➤ **Defining the RIP Version**

Command Syntax	version { 1 2 }
-----------------------	--

Parameter	1: Indicates RIPv1.
Description	2: Indicates RIPv2.
Command Mode	Global configuration mode
Configuration Usage	This command takes effect on the entire router. You can run this command to define the version of RIP packets sent or received on all interfaces.

➤ **Enabling Split Horizon**

Command Syntax	ip rip split-horizon [poisoned-reverse]
Parameter Description	poisoned-reverse: Indicates poison reverse.
Command Mode	Interface configuration mode
Configuration Usage	After poison reverse is enabled, split horizon is automatically disabled.

➤ **Configuring a Passive Interface**

Command Syntax	passive-interface { default interface-type interface-num }
Parameter Description	default: Indicates all interfaces. interface-type interface-num: Specifies an interface.
Command Mode	Routing process configuration mode
Configuration Usage	First, run the passive-interface default command to configure all interfaces as passive interfaces. Then, run the no passive-interface interface-type interface-num command to cancel the interfaces used for interconnection between routers in the domain.

Configuration Example

➤ **Building a RIP Routing Domain**

<p>Scenario Figure 3-9</p>	
<p>Remarks</p>	<p>The interface IP addresses are as follows:</p> <p>A: GE0/1 110.11.2.1/24 GE0/2 155.10.1.1/24</p> <p>B: GE0/1 110.11.2.2/24 GE0/2 196.38.165.1/24</p> <p>C: GE0/1 110.11.2.3/24 GE0/2 117.102.0.1/16</p>

Configuration Steps	<ul style="list-style-type: none"> ● Configure the interface IP addresses on all routers. ● Configure the RIP basic functions on all routers.
A	<pre> A# configure terminal A(config)# interface GigabitEthernet 0/1 A(config-if-GigabitEthernet 0/1)# ip address 110.11.2.1 255.255.255.0 A(config-if-GigabitEthernet 0/1)# exit A(config)# interface GigabitEthernet 0/2 A(config-if-GigabitEthernet 0/2)# ip address 155.10.1.1 255.255.255.0 A(config)# router rip A(config-router)# version 2 A(config-router)# network 0.0.0.0 255.255.255.255 A(config-router)# passive-interface default A(config-router)# no passive-interface GigabitEthernet 0/1 </pre>
B	<pre> B# configure terminal B(config)# interface GigabitEthernet 0/1 B(config-if-GigabitEthernet 0/1)# ip address 110.11.2.2 255.255.255.0 B(config-if-GigabitEthernet 0/1)# exit B(config)# interface GigabitEthernet 0/2 B(config-if-GigabitEthernet 0/2)# ip address 196.38.165.1 255.255.255.0 B(config-if-GigabitEthernet 0/2)# exit B(config)# router rip B(config-router)# version 2 B(config-router)# network 0.0.0.0 255.255.255.255 B(config-router)# passive-interface default B(config-router)# no passive-interface GigabitEthernet 0/1 </pre>
C	<pre> C# configure terminal C(config)# interface GigabitEthernet 0/1 C(config-if-GigabitEthernet 0/1)# ip address 110.11.2.3 255.255.255.0 C(config-if-GigabitEthernet 0/1)# exit C(config)# interface GigabitEthernet 0/2 C(config-if-GigabitEthernet 0/2)# ip address 117.102.0.1 255.255.0.0 C(config-if-GigabitEthernet 0/2)# exit C(config)# router rip </pre>

	<pre>C(config-router)# version 2 C(config-router)#no auto-summary C(config-router)# network 0.0.0.0 255.255.255.255 C(config-router)# passive-interface default C(config-router)# no passive-interface GigabitEthernet 0/1</pre>
<p>Verification</p>	<p>Check the routing tables on Router A, Router B, and Router C. Verify that RIP learns the routes to remote networks (contents marked in blue).</p>
<p>A</p>	<pre>A# show ip route Codes: C - connected, S - static, R - RIP, B - BGP O - OSPF, IA - OSPF inter area N1 - OSPF NSSA external type 1, N2 - OSPF NSSA external type 2 E1 - OSPF external type 1, E2 - OSPF external type 2 i - IS-IS, su - IS-IS summary, L1 - IS-IS level-1, L2 - IS-IS level-2 ia - IS-IS inter area, * - candidate default Gateway of last resort is no set C 110.11.2.0/24 is directly connected, GigabitEthernet 0/1 C 110.11.2.1/32 is local host. R 117.0.0.0/8 [120/1] via 110.11.2.2, 00:00:47, GigabitEthernet 0/1 C 155.10.1.0/24 is directly connected, GigabitEthernet 0/2 C 155.10.1.1/32 is local host. C 192.168.217.0/24 is directly connected, VLAN 1 C 192.168.217.233/32 is local host. R 196.38.165.0/24 [120/1] via 110.11.2.3, 00:19:18, GigabitEthernet 0/1</pre>
<p>B</p>	<pre>B# show ip route Codes: C - connected, S - static, R - RIP, B - BGP O - OSPF, IA - OSPF inter area N1 - OSPF NSSA external type 1, N2 - OSPF NSSA external type 2 E1 - OSPF external type 1, E2 - OSPF external type 2 i - IS-IS, su - IS-IS summary, L1 - IS-IS level-1, L2 - IS-IS level-2 ia - IS-IS inter area, * - candidate default</pre>

	<pre> Gateway of last resort is no set C 110.11.2.0/24 is directly connected, GigabitEthernet 0/1 C 110.11.2.2/32 is local host. R 155.10.0.0/16 [120/1] via 110.11.2.1, 00:15:21, GigabitEthernet 0/1 C 196.38.165.0/24 is directly connected, GigabitEthernet 0/2 C 196.38.165.1/32 is local host. R 117.0.0.0/8 [120/1] via 110.11.2.2, 00:00:47, GigabitEthernet 0/1 </pre>
<p>C</p>	<pre> C# show ip route Codes: C - connected, S - static, R - RIP, B - BGP O - OSPF, IA - OSPF inter area N1 - OSPF NSSA external type 1, N2 - OSPF NSSA external type 2 E1 - OSPF external type 1, E2 - OSPF external type 2 i - IS-IS, su - IS-IS summary, L1 - IS-IS level-1, L2 - IS-IS level-2 ia - IS-IS inter area, * - candidate default Gateway of last resort is no set C 110.11.2.0/24 is directly connected, GigabitEthernet 0/1 C 110.11.2.3/32 is local host. C 117.102.0.0/16 is directly connected, GigabitEthernet 0/2 C 117.102.0.1/32 is local host. R 155.10.0.0/16 [120/1] via 110.11.2.1, 00:20:55, GigabitEthernet 0/1 R 196.38.165.0/24 [120/1] via 110.11.2.3, 00:19:18, GigabitEthernet 0/1 </pre>

Common Errors

- The IPv4 address is not configured on an interface.
- The RIP version is not defined on a device, or the RIP version on the device is different from that on other routers.
- The address range configured by the **network** command does not cover a specific interface.
- The **wildcard** parameter in the **network** command is not correctly configured. **0** indicates accurate matching, and **1** indicates that no comparison is performed.
- The interface used for interconnection between devices is configured as a passive interface.

3.4.2Controlling Interaction of RIP Packets

Configuration Effect

Change the default running mechanism of RIP through configuration and manually control the interaction mode of RIP packets, including:

- Allowing or prohibiting the sending of unicast RIP packets to a specified neighbor on an interface
- Allowing or prohibiting the sending of unicast RIPv2 packets instead of broadcast packets to a specified neighbor on an interface
- Allowing or prohibiting the receiving of RIP packets on an interface
- Allowing or prohibiting the sending of RIP packets on an interface
- Allowing or prohibiting the receiving of RIP packets of a specified version on an interface
- Allowing or prohibiting the sending of RIP packets of a specified version on an interface

Notes

- The RIP basic functions must be configured.
- On an interface connecting to a neighbor device, the configured version of sent RIP packets must be the same as the version of received RIP packets.

Configuration Steps

➤ **Sending Unicast RIP Route Update Packets to a Specified Neighbor**

- Configure this function if you wish that only some of devices connected to an interface can receive the updated routing information.
- By default, RIPv1 uses the IP broadcast address (255.255.255.255) to advertise the routing information, whereas RIPv2 uses the multicast address (224.0.0.9) to advertise the routing information. If you do not wish all devices on the broadcast network or NBMA network to receive routing information, configure the related interface as the passive interface and specify the neighbors that can receive the routing information. This command does not affect the receiving of RIP packets. RIPv2 packets are broadcast on an interface.
- Unless otherwise required, this function must be enabled on a router that sends the unicast Update packets.

➤ **Broadcasting RIPv2 Packets on an Interface**

- This function must be configured if the neighbor router does not support the receiving of multicast RIPv2 packets.
- Unless otherwise required, this function must be configured on every router interface that broadcasts RIPv2 packets.

➤ **Allowing an Interface to Receive RIP Packets**

- This function is enabled by default, and must be disabled if an interface is not allowed to receive RIP packets.
- Unless otherwise required, this function must be configured on every router interface that is not allowed to receive RIP packets.

➤ **Allowing an Interface to Send RIP Packets**

- This function is enabled by default, and must be disabled if an interface is not allowed to send RIP packets.
- Unless otherwise required, this function must be configured on every router interface that is not allowed to send RIP packets.

➤ **Allowing an Interface to Send RIP Packets of a Specified Version**

- This function must be configured if the version of RIP packets that can be sent on an interface is required to be different from the global configuration.
- Unless otherwise required, this function must be configured on every router interface that is allowed to send RIP packets of a specified version.

↘ **Allowing an Interface to Receive RIP Packets of a Specified Version**

- This function must be configured if the version of RIP packets that can be received on an interface is required to be different from the global configuration.
- Unless otherwise required, this function must be configured on every router interface that is allowed to receive RIP packets of a specified version.

Verification

Run the **debug ip rip packet** command to verify the packet sending result and packet type.

Related Commands

↘ **Sending Unicast RIP Route Update Packets to a Specified Neighbor**

Command Syntax	neighbor <i>ip-address</i>
Parameter Description	<i>ip-address</i> : Indicates the IP address of the neighbor. It should be the address of the network directly connected to the local device.
Command Mode	Routing process configuration mode
Configuration Usage	Generally, you can first run the passive-interface command in routing process configuration mode to configure the related interface as a passive interface, and then specify the neighbors that can receive the routing information. This command does not affect the receiving of RIP packets. After an interface is configured as a passive interface, the interface does not send the request packets even after the device is restarted.

↘ **Broadcasting RIPv2 Packets on an Interface**

Command Syntax	ip rip v2-broadcast
Parameter Description	N/A
Command Mode	Interface configuration mode
Configuration Usage	The default behavior is determined by the configuration of the version command. The configuration result of this command can overwrite the default configuration of the version command. This command affects the behavior of sending RIP packets on the current interface, and the interface is allowed to send RIPv1 and RIPv2 packets simultaneously. If this command does not contain any parameter, the behavior of receiving RIP packets is determined by the configuration of the version command.

↘ **Allowing an Interface to Receive RIP Packets**

Command Syntax	ip rip receive enable
-----------------------	------------------------------

Parameter Description	N/A
Command Mode	Interface configuration mode
Configuration Usage	To prohibit the receiving of RIP packets on an interface, use the no form of this command. This command takes effect only on the current interface. You can use the default form of the command to restore the default setting, that is, allowing the interface to receive RIP packets.

▾ Allowing an Interface to Send RIP Packets

Command Syntax	ip rip send enable
Parameter Description	N/A
Command Mode	Interface configuration mode
Configuration Usage	To prohibit the sending of RIP packets on an interface, use the no form of this command in interface configuration mode. This command takes effect only on the current interface. You can use the default form of the command to restore the default setting, that is, allowing the interface to send RIP packets.

▾ Allowing an Interface to Send RIP Packets of a Specified Version

Command Syntax	ip rip send version [1] [2]
Parameter Description	1: Indicates that only RIPv1 packets are sent. 2: Indicates that only RIPv2 packets are sent.
Command Mode	Interface configuration mode
Configuration Usage	The default behavior is determined by the configuration of the version command. The configuration result of this command can overwrite the default configuration of the version command. This command affects the behavior of sending RIP packets on the current interface, and the interface is allowed to send RIPv1 and RIPv2 packets simultaneously. If this command does not contain any parameter, the behavior of receiving RIP packets is determined by the configuration of the version command.

▾ Allowing an Interface to Receive RIP Packets of a Specified Version

Command Syntax	ip rip receive version [1] [2]
Parameter Description	1: Indicates that only RIPv1 packets are received. 2: Indicates that only RIPv2 packets are received.
Command Mode	Interface configuration mode
Configuration Usage	The default behavior is determined by the configuration of the version command. The configuration result of this command can overwrite the default configuration of the version command. This command affects the behavior of receiving RIP packets on the current interface, and the interface is allowed to receive RIPv1 and RIPv2 packets simultaneously. If this command does not contain any parameter, the behavior of receiving RIP packets is

determined by the configuration of the **version** command.

Configuration Example

▾ **Prohibiting an Interface from Sending RIP Packets**

<p>Scenario Figure 3- 10</p>	
<p>Configuration Steps</p>	<ul style="list-style-type: none"> ● Configure the interface IP addresses on all routers. (Omitted) ● Configure the RIP basic functions on all routers. (Omitted) ● Prohibit the sending of RIP packets on an interface of Router A.
<p>A</p>	<pre>A# configure terminal A(config)# interface GigabitEthernet 0/1 FS(config-if-GigabitEthernet 0/1)# no ip rip send enable</pre>
<p>Verification</p>	<p>Run the debug ip rip packet send command on Router A, and verify that packets cannot be sent.</p>
<p>A</p>	<pre>A# debug ip rip packet recv *Nov 4 08:19:31: %RIP-7-DEBUG: [RIP] Prepare to send BROADCAST response... *Nov 4 08:19:31: %RIP-7-DEBUG: [RIP] Building update entries on GigabitEthernet 0/1 *Nov 4 08:19:31: %RIP-7-DEBUG: 117.0.0.0/8 via 0.0.0.0 metric 1 tag 0 *Nov 4 08:19:31: %RIP-7-DEBUG: [RIP] Interface GigabitEthernet 0/1 is disabled to send RIP packet!</pre>

Common Errors

A compatibility error occurs because the RIP version configured on the neighbor is different from that configured on the local device.

3.4.3 Enabling Triggered Updates

Configuration Effect

- Enable the RIP triggered updates function, after which RIP does not periodically send the route update packets.

Notes

- The RIP basic functions must be configured.
- It is recommended that split horizon with poisoned reverse be enabled; otherwise, invalid routing information may exist.
- This function cannot be enabled together with the function of correlating RIP with BFD.
- Ensure that the triggered updates function is enabled on every router on the same link; otherwise, the routing information cannot be exchanged properly.

Configuration Steps

➤ **Enabling Triggered Updates**

- This function must be enabled if demand circuits are configured on the WAN interface.
- The triggered updates function can be enabled in either of the following cases: (1) The interface has only one neighbor; (2) The interface has multiple neighbors but the device interacts with these neighbors in unicast mode.
- It is recommended that triggered updates be enabled on a WAN interface (running the PPP, Frame Relay, or X.25 link layer protocol) to meet the requirements of demand circuits.
- If the triggered updates function is enabled on an interface, source address verification is performed no matter whether the source address verification function is enabled by the **validate-update-source** command.
- Unless otherwise required, triggered updates must be enabled on demand circuits of every router.

Verification

When the RIP triggered updates function is enabled, RIP cannot periodically send the route update packets. RIP sends the route update packets to the WAN interface only in one of the following cases:

- A route request packet is received.
- The RIP routing information changes.
- The interface state changes.
- The router is started.

Related Commands

➤ **Enabling Triggered Updates**

Command Syntax	ip rip triggered { retransmit-timer <i>timer</i> retransmit-count <i>count</i> }
Parameter Description	<p>retransmit-timer <i>timer</i>: Configures the interval at which the update request or update response packet is retransmitted. The default value is 5s. The value ranges from 1 to 3,600.</p> <p>retransmit-count <i>count</i>: Configures the maximum retransmission times of the update request or update response packet. The default value is 36. The value ranges from 1 to 3,600.</p>
Command Mode	Interface configuration mode
Configuration Usage	<p>You can run the ip rip triggered command to enable the RIP triggering function.</p> <p>When this function is enabled, the RIP periodical update function is automatically disabled. Therefore, the acknowledgment and retransmission mechanisms must be used to ensure that the Update packets are successfully sent or received on the WAN. You can use the retransmit-timer and retransmit-count parameters to specify the retransmission interval and maximum retransmission times of the request and update packets.</p>

Configuration Example

➤ **Enabling Triggered Updates**

<p>Scenario Figure 3- 11</p>	
<p>Configuration Steps</p>	<ul style="list-style-type: none"> ● Configure the interface IP addresses on all routers. (Omitted) ● Configure the RIP basic functions on all routers. (Omitted) ● On Router A, enable the RIP triggered updates function, and set the retransmission interval and maximum retransmission times of the request and update packets to 10s and 18, respectively.
<p>A</p>	<pre>A# configure terminal A(config)# interface GigabitEthernet 0/1 A(config-if-GigabitEthernet 0/1)# encapsulation ppp A(config-if-GigabitEthernet 0/1)# ip rip triggered A(config-if-GigabitEthernet 0/1)# ip rip triggered retransmit-timer 10 A(config-if-GigabitEthernet 0/1)# ip rip triggered retransmit-count 18 A(config-if-GigabitEthernet 0/1)# ip rip split-horizon poisoned-reverse A(config)# router rip A(config-router)# network 192.168.1.0 A(config-router)# network 200.1.1.0</pre>
<p>B</p>	<pre>B# configure terminal B(config)# interface GigabitEthernet 0/1 B(config-if-GigabitEthernet 0/1)# encapsulation ppp B(config-if-GigabitEthernet 0/1)# ip rip triggered B(config-if-GigabitEthernet 0/1)# ip rip split-horizon poisoned-reverse B(config)# router rip B(config-router)# network 192.168.1.0 B(config-router)# network 201.1.1.0</pre>
<p>Verification</p>	<p>On Router A and Router B, check the RIP database and verify that the corresponding routes are permanent.</p>
<p>A</p>	<pre>A# sho ip rip database 201.1.1.0/24 auto-summary 201.1.1.0/24</pre>

	[1] via 192.168.12.2 GigabitEthernet 0/1 06:25 permanent
B	<pre> B# sho ip rip database 200.1.1.0/24 auto-summary 200.1.1.0/24 [1] via 192.168.12.1 GigabitEthernet 0/1 06:25 permanent </pre>

Common Errors

- The triggered updates function is enabled when the RIP configurations at both ends of the link are consistent.
- Both the triggered updates and BFD functions are enabled.
- The triggered updates function is not enabled on all routers on the same link.

3.4.4 Enabling Source Address Verification

Configuration Effect

- The source address of the received RIP route update packet is verified.

Notes

- The RIP basic functions must be configured.

Configuration Steps

↘ Enabling Source Address Verification

- This function is enabled by default, and must be disabled when source address verification is not required.
- After split horizon is disabled on an interface, the RIP routing process will perform source address verification on the Update packet no matter whether the **validate-update-source** command is executed in routing process configuration mode.
- For an IP unnumbered interface, the RIP routing process does not perform source address verification on the Update packet no matter whether the **validate-update-source** command is executed in routing process configuration mode.
- Unless otherwise required, this function must be disabled on every router that does not requires source address verification.

Verification

Only the route update packets coming from the same IP subnet neighbor are received.

Related Commands

Command	validate-update-source
Syntax	
Parameter Description	N/A
Command Mode	Routing process configuration mode
Configuration Usage	Source address verification of the Update packet is enabled by default. After this function is enabled, the source address of the RIP route update packet is verified. The purpose is to ensure that the RIP routing process receives only

the route update packets coming from the same IP subnet neighbor.

Configuration Example

<p>Scenario Figure 3- 12</p>	
<p>Configuration Steps</p>	<ul style="list-style-type: none"> ● Configure the interface IP addresses on all routers. (Omitted) ● Configure the RIP basic functions on all routers. (Omitted) ● Disable source address verification of Update packets on all routers.
<p>A</p>	<pre>A# configure terminal A(config)# router rip A(config-router)# no validate-update-source</pre>
<p>B</p>	<pre>B# configure terminal B(config)# router rip B(config-router)# no validate-update-source</pre>
<p>Verification</p>	<ul style="list-style-type: none"> ● On Router A, check the routing table and verify that the entry 201.1.1.0/24 is loaded. ● On Router B, check the routing table and verify that the entry 200.1.1.0/24 is loaded.
<p>A</p>	<pre>A# show ip route rip R 201.1.1.0/24 [120/1] via 192.168.2.2, 00:06:11, GigabitEthernet 0/1</pre>
<p>B</p>	<pre>B# show ip route rip R 200.1.1.0/24 [120/1] via 192.168.1.1, 00:06:11, GigabitEthernet 0/1</pre>

3.4.5 Enabling Authentication

Configuration Effect

- Prevent learning unauthenticated and invalid routes and advertising valid routes to unauthorized devices, ensuring stability of the system and protecting the system against intrusions.

Notes

- The RIP basic functions must be configured.
- Only RIPv2 supports authentication of RIP packets, and RIPv1 does not.

Configuration Steps

➤ **Enabling Authentication and Specifying the Key Chain Used for RIP Authentication**

- This configuration is mandatory if authentication must be enabled.
- If the key chain is already specified in the interface configuration, run the **key chain** command in global configuration mode to define the key chain; otherwise, authentication of RIP packets may fail.
- Unless otherwise required, this configuration must be performed on every router that requires authentication.

➤ **Defining the RIP Authentication Mode**

- This configuration is mandatory if authentication must be enabled.
- The RIP authentication modes configured on all devices that need to directly exchange RIP routing information must be the same; otherwise, RIP packets may fail to be exchanged.
- If plain text authentication is used, but the key chain for plain text authentication is not configured or associated, authentication is not performed. Similarly, if MD5 authentication is used, but the key chain is not configured or associated, authentication is not performed.
- Unless otherwise required, this configuration must be performed on every router that requires authentication.

➤ **Enabling RIP Plain Text Authentication and Configuring the Key Chain**

- This configuration is mandatory if authentication must be enabled.
- If RIP plain text authentication should be enabled, use this command to configure the key chain for plain text authentication. Alternatively, you can obtain the key chain for plain text authentication by associating the key chain. The key chain obtained using the second method takes precedence over that obtained using the first method.
- Unless otherwise required, this configuration must be performed on every router that requires authentication.

Verification

- RIP plain text authentication provides only limited security because the password transferred through the packet is visible.
- RIP MD5 authentication can provide higher security because the password transferred through the packet is encrypted using the MD5 algorithm.
- Routes can be learned properly if the correct authentication parameters are configured.
- Routes cannot be learned if the incorrect authentication parameters are configured.

Related Commands

➤ **Enabling Source Address Verification**

Command Syntax	ip rip authentication key-chain <i>name-of-keychain</i>
Parameter Description	<i>name-of-keychain</i> : Specifies the name of the key chain used for RIP authentication.
Command Mode	Interface configuration mode
Configuration Usage	The specified key chain must be defined by the key chain command in global configuration mode in advance.

➤ Defining the RIP Authentication Mode

Command Syntax	<code>ip rip authentication mode { text md5 }</code>
Parameter Description	text: Indicates that the RIP authentication mode is plain text authentication. md5: Indicates that the RIP authentication mode is MD5 authentication.
Command Mode	Interface configuration mode
Configuration Usage	For all devices that need to directly exchange the RIP routing information, the RIP authentication mode of these devices must be the same.

➤ Enabling RIP Plain Text Authentication and Configuring the Key Chain

Command Syntax	<code>ip rip authentication text-password [0 7] password-string</code>
Parameter Description	0: Indicates that the key is displayed in plain text. 7: Indicates that the key is displayed in cipher text. <i>password-string:</i> Indicates the key chain used for plain text authentication. The key chain is a string of 1 to 16 bytes.
Command Mode	Interface configuration mode
Configuration Usage	This commands takes effect only in plain text authentication mode.

Configuration Example

➤ Configuring RIP Basic Functions and Enabling MD5 Authentication

<p>Scenario Figure 3-13</p>	
Configuration Steps	<ul style="list-style-type: none"> ● Configure the interface IP addresses on all routers. (Omitted) ● Configure the RIP basic functions on all routers. (Omitted) ● Configure the authentication type and MD5 authentication key on all routers.

<p>A</p>	<pre>A# configure terminal A(config)# key chain hello A(config-keychain)# key 1 A(config-keychain-key)# key-string world A(config-keychain-key)# exit A(config-keychain)# exit A(config)# interface GigabitEthernet 0/1 A(config-if-GigabitEthernet 0/1)# ip rip authentication mode md5 A(config-if-GigabitEthernet 0/1)# ip rip authentication key-chain hello</pre>
<p>B</p>	<pre>B# configure terminal B(config)# key chain hello B(config-keychain)# key 1 B(config-keychain-key)# key-string world B(config-keychain-key)# exit B(config-keychain)# exit B(config)# interface GigabitEthernet 0/1 B(config-if-GigabitEthernet 0/1)# ip rip authentication mode md5 B(config-if-GigabitEthernet 0/1)# ip rip authentication key-chain hello</pre>
<p>Verification</p>	<ul style="list-style-type: none"> ● On Router A, check the routing table and verify that the entry 201.1.1.0/24 is loaded. ● On Router B, check the routing table and verify that the entry 200.1.1.0/24 is loaded.
<p>A</p>	<pre>A# show ip route rip R 201.1.1.0/24 [120/1] via 192.168.1.2, 00:06:11, GigabitEthernet 0/1</pre>
<p>B</p>	<pre>A# show ip route rip R 200.1.1.0/24 [120/1] via 192.168.1.1, 00:06:11, GigabitEthernet 0/1</pre>

Common Errors

- The keys configured on routers that need to exchange RIP routing information are different.
- The authentication modes configured on routers that need to exchange RIP routing information are different.

3.4.6 Enabling Route Summarization

Configuration Effect

Reduce the size of the routing table, improve the routing efficiency, avoid route flapping to some extent, and improve scalability and effectiveness of the network.

- i** If a summarized route exists, subroutes included by the summarized route cannot be seen in the routing table, which greatly reduces the size of the routing table.
- i** Advertising a summarized route is more efficient than advertising individual routes because: (1) A summarized route is processed first when RIP looks through the database; (2) All subroutes are ignored when RIP looks through the database, which reduces the processing time required.

Notes

- The RIP basic functions must be configured.
- The range of supernetting routes is larger than that of the classful network. Therefore, the automatic route summarization function is invalid for supernetting routes.
- RIPv1 always performs automatic route summarization. If the detailed routes should be advertised, you must set the RIP version to RIPv2.

Configuration Steps

↘ Enabling Automatic Route Summarization

- This function is enabled by default.
- To learn specific subnet routes instead of summarized network routes, you must disable automatic route summarization.
- You can disable automatic route summarization only in RIPv2. RIPv1 always performs automatic route summarization.

↘ Configuring RIP Route Summarization on an Interface

- This function must be configured if it is required to summarize classful subnets.
- The **ip rip summary-address** command is used to summarize an address or a subnet under a specified interface. RIP automatically summarizes to the classful network boundary. Each classful subnet can be configured only in the **ip rip summary-address** command.
- The summary range configured in this command cannot be supernetting routes, that is, the configured subnet mask length cannot be smaller than the natural mask length of the network.
- Unless otherwise required, this configuration should be performed on a router that requires classful subnet summarization.

Verification

Verify that the routes are summarized in the routing table of the peer end.

Related Commands

↘ Enabling Automatic Route Summarization

Command	auto-summary
Syntax	
Parameter	N/A
Description	
Command Mode	Routing process configuration mode
Configuration Usage	Route summarization is enabled by default for RIPv1 and RIPv2. You can disable automatic route summarization only in RIPv2. RIPv1 always performs automatic route

	summarization.
--	----------------

➤ **Configuring RIP Route Summarization on an Interface**

Command Syntax	ip rip summary-address <i>ip-address ip-network-mask</i>
Parameter Description	<i>ip-address</i> : Indicates the IP address to be summarized. <i>ip-network-mask</i> : Indicates the subnet mask of the IP address to be summarized.
Command Mode	Interface configuration mode
Configuration Usage	This command is used to summarize an address or a subnet under a specified interface.

Configuration Example

➤ **Configuring Route Summarization**

<p>Scenario Figure 3- 14</p>			
	<table border="1" style="width: 100%;"> <tr> <td style="width: 15%;">Remarks</td> <td> The interface IP addresses are as follows: A: GE0/1 192.168.1.1 B: GE0/1 192.168.1.2 GE0/2 172.16.2.1 GE0/3 172.16.3.1 C: GE0/2 172.16.2.2 GE0/3 172.16.4.2 D: GE0/2 172.16.3.2 GE0/3 172.16.5.2 </td> </tr> </table>	Remarks	The interface IP addresses are as follows: A: GE0/1 192.168.1.1 B: GE0/1 192.168.1.2 GE0/2 172.16.2.1 GE0/3 172.16.3.1 C: GE0/2 172.16.2.2 GE0/3 172.16.4.2 D: GE0/2 172.16.3.2 GE0/3 172.16.5.2
Remarks	The interface IP addresses are as follows: A: GE0/1 192.168.1.1 B: GE0/1 192.168.1.2 GE0/2 172.16.2.1 GE0/3 172.16.3.1 C: GE0/2 172.16.2.2 GE0/3 172.16.4.2 D: GE0/2 172.16.3.2 GE0/3 172.16.5.2		
<p>Configuration Steps</p>	<ul style="list-style-type: none"> ● Configure the interface IP addresses on all routers. (Omitted) ● Configure the RIP basic functions on all routers. (Omitted) ● Configure route summarization on Router B. 		
	<pre> B# configure terminal B(config)# interface GigabitEthernet 0/1 B(config-if-GigabitEthernet 0/1)# ip rip summary-address 172.16.0.0 255.255.0.0 B(config)# router rip B(config-router)# version 2 B(config-router)# no auto-summary </pre>		

Verification	Check the routing table on Router A, and verify that the entry 172.16.0.0/16 is generated.
	<pre>A# show ip route rip R 172.16.0.0/16 [120/2] via 192.168.1.2, 00:01:04, GigabitEthernet 0/1</pre>

Common Errors

- RIP basic functions are not configured or fail to be configured.

3.4.7 Enabling Supernetting Routes

Configuration Effect

- Allow RIP to send RIP supernetting routes on a specified interface.

Notes

- The RIP basic functions must be configured.

Configuration Steps

↳ Enabling Supernetting Routes

- If a supernetting route is detected when a RIPv1-enabled router monitors the RIPv2 route response packets, the router will learn an incorrect route because RIPv1 ignores the subnet mask in the routing information of the packet. In this case, the **no** form of the command must be used on the RIPv2-enabled router to prohibit advertisement of supernetting routes on the related interface. This command takes effect only on the current interface.
- The command is effective only when RIPv2 packets are sent on the interface, and is used to control the sending of supernetting routes.

Verification

Verify that the peer router cannot learn the supernetting route.

Related Commands

Command Syntax	ip rip send supernet-routes
Parameter Description	N/A
Command Mode	Interface configuration mode
Configuration Usage	By default, an interface is allowed to send RIP supernetting routes.

Configuration Example

↳ Disabling Supernetting Routes

<p>Scenario Figure 3- 15</p>	
<p>Configuration Steps</p>	<ul style="list-style-type: none"> ● Configure the interface IP addresses on all routers. (Omitted) ● Configure the RIP basic functions on all routers. (Omitted) ● Prohibit the sending of RIP supernetting routes on the GigabitEthernet 0/1 interface of Router B.
	<pre>B# configure terminal B(config)# ip route 207.0.0.0 255.0.0.0 Null 0 B(config)# ip route 208.1.1.0 255.255.255.0 Null 0 B(config)# router rip B(config-router)# redistribute static B(config)# interface GigabitEthernet 0/1 B(config-if-GigabitEthernet 0/1)# no ip rip send supernet-routes</pre>
<p>Verification</p>	<p>Check the routing table on Router A, and verify that Router A can learn only the non-supernetting route 208.1.1.0/24, but not the supernetting route 207.0.0.0/8.</p>
	<pre>A#show ip route rip R 208.1.1.0/24 [120/1] via 192.168.1.2, 00:06:11, GigabitEthernet 0/1</pre>

3.4.8 Advertising the Default Route or External Routes

Configuration Effect

- In the RIP domain, introduce a unicast route of another AS so that the unicast routing service to this AS can be provided for users in the RIP domain.
- In the RIP domain, inject a default route to another AS so that the unicast routing service to this AS can be provided for users in the RIP domain.

Notes

- The RIP basic functions must be configured.
- Route redistribution cannot introduce default routes of other protocols to the RIP routing domain.

Configuration Steps

🔻 Advertising the Default Route to Neighbors

This function must be enabled if it is required to advertise the default route to neighbors.

By default, a default route is not generated, and the metric of the default route is 1.

If the RIP process can generate a default route using this command, RIP does not learn the default route advertised by the neighbor.

Unless otherwise required, this configuration should be performed on a router that needs to advertise the default route.

↘ Advertising the Default Route to Neighbors on an Interface

This function must be enabled if it is required to advertise the default route to neighbors on a specified interface.

By default, a default route is not configured and the metric of the default route is 1.

After this command is configured on an interface, a default route is generated and advertised through this interface.

Unless otherwise required, this configuration should be performed on a router that needs to advertise the default route.

↘ Redistributes Routes and Advertises External Routes to Neighbors

This function must be enabled if routes of other protocols need to be redistributed.

By default,

- If OSPF redistribution is configured, redistribute the routes of all sub-types of the OSPF process.
- If IS-IS redistribution is configured, redistribute the level-2 routes of the IS-IS process.
- In other cases, redistribute all external routes.
- The metric of a redistributed route is 1 by default.
- The route map is not associated by default.

During route redistribution, it is not necessary to convert the metric of one routing protocol to the metric of another routing protocol because different routing protocols use completely different metric measurement methods. RIP measures the metric based on the hop count, and OSPF measures the metric based on the bandwidth. Therefore, the computed metrics cannot be compared with each other. During route redistribution, however, it is necessary to configure a symbolic metric; otherwise, route redistribution fails.

Unless otherwise required, this configuration should be performed on a router that needs to redistribute routes.

Verification

- On a neighbor device, verify that a default route exists in the RIP routing table.
- On the local and neighbor devices, verify that external routes (routes to other ASs) exist in the RIP routing table.

Related Commands

↘ Advertising the Default Route to Neighbors

Command Syntax	default-information originate [always] [metric <i>metric-value</i>] [route-map <i>map-name</i>]
Parameter Description	always: Enables RIP to generate a default route no matter whether the local router has a default route. metric <i>metric-value:</i> Indicates the initial metric of the default route. The value ranges from 1 to 15. route-map <i>map-name:</i> Indicates the associated route map name. By default, no route map is associated.
Command Mode	Routing process configuration mode
Configuration Usage	If a default route exists in the routing table of a router, RIP does not advertise the default route to external entities by default. You need to run the default-information originate command in routing process configuration mode to advertise the default route to neighbors. If the always parameter is selected, the RIP routing process advertises a default route to neighbors no matter the default route exists, but this default route is not displayed in the local routing table. To check whether the default

route is generated, run the **show ip rip database** command to check the RIP routing information database.

To further control the behavior of advertising the RIP default route, use the **route-map** parameter. For example, run the **set metric** rule to set the metric of the default route.

You can use the **metric** parameter to set the metric of the advertised default value, but the priority of this configuration is lower than that of the set metric rule of the **route-map** parameter. If the **metric** parameter is not configured, the default route uses the default metric configured for RIP.

You still need to run the **default-information originate** command to introduce the default route generated by **ip default-network** to RIP.

↘ **Advertising the Default Route to Neighbors on an Interface**

Command Syntax	ip rip default-information { only originate } [metric <i>metric-value</i>]
Parameter Description	only : Indicates that only the default route is advertised. originate : Indicates that the default route and other routes are advertised. metric <i>metric-value</i> : Indicates the metric of the default route. The value ranges from 1 to 15.
Command Mode	Interface configuration mode
Configuration Usage	If you configure the ip rip default-information command for the interface, and the default-information originate command for the RIP process, only the default route configured for the interface is advertised. So far as ip rip default-information is configured for one interface, RIP does not learn the default route advertised by the neighbor.

↘ **Redistributes Routes and Advertises External Routes to Neighbors**

Command Syntax	redistribute { bgp connected isis [<i>area-tag</i>] ospf <i>process-id</i> static } [{ level-1 level-1-2 level-2 }] [match { internal external [1 2] nssa-external [1 2] }] [metric <i>metric-value</i>] [route-map <i>route-map-name</i>]
Parameter Description	bgp : Indicates redistribution from BGP. connected : Indicates redistribution from direct routes. isis <i>area-tag</i> : Indicates redistribution from IS-IS. <i>area-tag</i> indicates the IS-IS process ID. ospf <i>process-id</i> : Indicates redistribution from OSPF. <i>process-id</i> indicates the OSPF process ID. The value ranges from 1 to 65535. static : Indicates redistribution from static routes. level-1 level-1-2 level-2 : Used only when IS-IS routes are redistributed. Only the routes of the specified level are redistributed. match : Used only when OSPF routes are redistributed. Only the routes that match the filtering conditions are redistributed. metric <i>metric-value</i> : Sets the metric of the redistributed route. The value ranges from 1 to 16. route-map <i>route-map-name</i> : Sets the redistribution filtering rules.
Command Mode	Routing process configuration mode
Configuration Usage	When you configure redistribution of IS-IS routes without specifying the level parameter, only level-2 routes can be redistributed by default. If you specify the level parameter during initial configuration of redistribution, routes of the specified level can be redistributed. If both level-1 and level-2 are configured, the two levels are combined and saved as level-1-2 for the convenience sake.

If you configure redistribution of OSPF routes without specifying the **match** parameter, OSPF routes of all sub-types can be distributed by default. The latest setting of the **match** parameter is used as the initial **match** parameter. Only routes that match the sub-types can be redistributed. You can use the **no** form of the command to restore the default value of **match**.

The configuration rules for the **no** form of the **redistribute** command are as follows:

1. If some parameters are specified in the **no** form of the command, default values of these parameters will be restored.
2. If no parameter is specified in the **no** form of the command, the entire command will be deleted.

For example, if **redistribute isis 112 level-2** is configured, you can run the **no redistribute isis 112 level-2** command to restore the default value of **level-2**. As level-2 itself is the default value of the parameter, the configuration saved is still **redistribute isis 112 level-2** after the preceding **no** form of the command is executed.

To delete the entire command, run the **no redistribute isis 112** command.

Configuration Example

↘ **Redistributing Routes and Advertising External Routes to Neighbors**

<p>Scenario Figure 3- 16</p>	
<p>Configuration Steps</p>	<ul style="list-style-type: none"> ● Configure the interface IP addresses on all routers. (Omitted) ● Configure the RIP basic functions on all routers. (Omitted) ● On Router B, configure redistribution of static routes.
<p>B</p>	<pre>B# configure terminal B(config)# router rip B(config-router)# redistribute static</pre>
<p>Verification</p>	<p>On Router A, check the routing table and verify that the entry 172.10.10.0/24 is loaded.</p>
	<pre>A# show ip route rip R 172.10.10.0/24 [120/1] via 192.168.1.2, 00:06:11, GigabitEthernet 0/1</pre>

3.4.9 Setting Route Filtering Rules

Configuration Effect

- Routes that do not meet filtering criteria cannot be loaded to the routing table, or advertised to neighbors. In this way, users within the network can be prevented from accessing specified destination networks.

Notes

- The RIP basic functions must be configured.

- In regard to the filtering rules of sent routes, you must configure route redistribution first, and then filter the redistributed routes.

Configuration Steps

↘ **Filtering the Received RIP Routing Information**

- This function must be configured if it is required to filter received routing information.
- To refuse receiving some specified routes, you can configure the route distribution control list to process all the received route update packets. If no interface is specified, route update packets received on all interfaces will be processed.
- Unless otherwise required, this configuration should be performed on a router that requires route filtering.

↘ **Filtering the Sent RIP Routing Information**

- This function must be configured if it is required to filter the redistributed routing information that is sent.
- If this command does not contain any optional parameter, route update advertisement control takes effect on all interfaces. If the command contains the interface parameter, route update advertisement control takes effect only on the specified interface. If the command contains other routing process parameters, route update advertisement control takes effect only on the specified routing process.
- Unless otherwise required, this configuration should be performed on a router that requires route filtering.

Verification

- Run the **show ip route rip** command to verify that the routes that have been filtered out are not loaded to the routing table.

Related Commands

↘ **Filtering the Received RIP Routing Information**

Command	distribute-list { [<i>access-list-number</i> <i>name</i>] } prefix <i>prefix-list-name</i> [gateway <i>prefix-list-name</i>] } in [<i>interface-type</i>
Syntax	<i>interface-number</i>]
Parameter Description	<i>access-list-number</i> <i>name</i> : Specifies the access list. Only routes permitted by the access list can be received. prefix <i>prefix-list-name</i> : Uses the prefix list to filter routes. gateway <i>prefix-list-name</i> : Uses the prefix list to filter the route sources. <i>interface-type</i> <i>interface-number</i> : Indicates that the distribution list is applied to the specified interface.
Command Mode	Routing process configuration mode
Configuration Usage	N/A

↘ **Filtering the Sent RIP Routing Information**

Command	distribute-list { [<i>access-list-number</i> <i>name</i>] } prefix <i>prefix-list-name</i> } out [<i>interface</i> [bgp connected isis
Syntax	[<i>area-tag</i>] ospf <i>process-id</i> rip static]]
Parameter Description	<i>access-list-number</i> <i>name</i> : Specifies the access list. Only routes permitted by the access list can be sent. prefix <i>prefix-list-name</i> : Uses the prefix list to filter routes. <i>Interface</i> : Applies route update advertisement control only on the specified interface. bgp : Applies route update advertisement control only on the routes introduced from BGP.

	<p>connected: Applies route update advertisement control only on direct routes introduced through redistribution.</p> <p>isis [area-tag]: Applies route update advertisement control only on the routes introduced from IS-IS. <i>area-tag</i> specifies an IS-IS process.</p> <p>ospf process-id: Applies route update advertisement control only on the routes introduced from OSPF. <i>process-id</i> specifies an OSPF process.</p> <p>rip: Applies route update advertisement control only on RIP routes.</p> <p>static: Applies route update advertisement control only on static routes introduced through redistribution.</p>
Command Mode	Routing process configuration mode
Configuration Usage	N/A

Configuration Example

📌 **Filtering the Received RIP Routing Information**

<p>Scenario Figure 3- 17</p>	
<p>Configuration Steps</p>	<ul style="list-style-type: none"> ● Configure the interface IP addresses on all routers. (Omitted) ● Configure the RIP basic functions on all routers. (Omitted) ● Enable the RIP routing process to control routes received over the GigabitEthernet 0/1 port and receive only the route 200.1.1.0.
<p>A</p>	<pre>A# configure terminal A(config)# router rip A(config-router)# distribute-list 10 in GigabitEthernet 0/1 A(config-router)# no auto-summary A(config)# access-list 10 permit 200.1.1.0 0.0.0.255</pre>
<p>Verification</p>	<p>On Router A, check the routing table and verify that only the entry 200.1.1.0/24 exists.</p>
<p>A</p>	<pre>A# show ip route rip R 200.1.1.0/24 [120/1] via 192.168.1.2, 00:06:11, GigabitEthernet 0/1</pre>

📌 **Filtering the Sent RIP Routing Information**

<p>Scenario Figure 3- 18</p>	
<p>Configuration Steps</p>	<ul style="list-style-type: none"> ● Configure the interface IP addresses on all routers. (Omitted) ● Configure the RIP basic functions on all routers. (Omitted) ● Enable the RIP routing process to advertise only the route 200.1.1.0/24.
<p>B</p>	<pre>B# configure terminal B(config)# router rip B(config-router)# redistribute connected B(config-router)# distribute-list 10 out B(config-router)# version 2 B(config)# access-list 10 permit 200.1.1.0 0.0.0.255</pre>
<p>Verification</p>	<p>Check the routing table on Router A, and verify that route in the 200.1.1.0 network segment exists.</p>
<p>A</p>	<pre>A# show ip route rip R 200.1.1.0/24 [120/1] via 192.168.1.2, 00:06:11, GigabitEthernet 0/1</pre>

Common Errors

- Filtering fails because the filtering rules of the access list are not properly configured.

3.4.10 Modifying Route Selection Parameters

Configuration Effect

- Change the RIP routes to enable the traffic pass through specified nodes or avoid passing through specified nodes.
- Change the sequence that a router selects various types of routes so as to change the priorities of RIP routes.

Notes

- The RIP basic functions must be configured.

Configuration Steps

📌 Modifying the Administrative Distance of a RIP Route

- Optional.
- This configuration is mandatory if you wish to change the priorities of RIP routes on a router that runs multiple unicast routing protocols.

➤ **Increasing the Metric of a Received or Sent RIP Route**

- Optional.
- Unless otherwise required, this configuration should be performed on a router where the metrics of routes need to be adjusted.

➤ **Configuring the Default Metric of an External Route Redistributed to RIP**

- Optional.
- Unless otherwise required, this configuration must be performed on an ASBR to which external routes are introduced.

Verification

Run the **show ip rip** command to display the administrative distance currently configured. Run the **show ip rip data** command to display the metrics of redistributed routes to verify that the configuration takes effect.

Related Commands

➤ **Modifying the Administrative Distance of a RIP Route**

Command	distance <i>distance</i> [<i>ip-address wildcard</i>]
Syntax	
Parameter	<i>distance</i> : Sets the administrative distance of a RIP route. The value is an integer ranging from 1 to 255.
Description	<i>ip-address</i> : Indicates the prefix of the source IP address of the route. <i>wildcard</i> : Defines the IP address comparison bit. 0 indicates accurate matching, and 1 indicates that no comparison is performed.
Command	Routing process configuration mode
Mode	
Configuration	Run this command to configure the administrative distance of a RIP route.
Usage	

➤ **Increasing the Metric of a Received or Sent RIP Route**

Command	offset-list { <i>access-list-number</i> <i>name</i> } { in out } <i>offset</i> [<i>interface-type interface-number</i>]
Syntax	
Parameter	<i>access-list-number</i> <i>name</i> : Specifies the access list.
Description	in : Uses the ACL to modify the metric of a received route. out : Uses the ACL to modify the metric of a sent route. <i>offset</i> : Indicates the offset of the modified metric. The value ranges from 0 to 16. <i>interface-type</i> : Uses the ACL on the specified interface. <i>interface-number</i> : Specifies the interface number.
Command	Routing process configuration mode
Mode	
Configuration	Run this command to increase the metric of a received or sent RIP route. If the interface is specified, the configuration takes effect only on the specified interface; otherwise, the configuration takes effect globally.
Usage	

➤ **Configuring the Default Metric of an External Route Redistributed to RIP**

Command	default-metric <i>metric-value</i>
Syntax	

Parameter	<i>metric-value</i> : Indicates the default metric. The valid value ranges from 1 to 16. If the value is equal to or greater than 16, the FSOS determines that this route is unreachable.
Description	
Command Mode	Routing process configuration mode
Configuration Usage	This command must be used together with the routing protocol configuration command redistribute .

Configuration Example

📌 **Increasing the Metric of a Received or Sent RIP Route**

<p>Scenario Figure 3- 19</p>	
<p>Configuration Steps</p>	<ul style="list-style-type: none"> ● Configure the interface IP addresses on all routers. (Omitted) ● Configure the RIP basic functions on all routers. (Omitted) ● Increase by 7 the metric of each RIP route in the range specified by ACL 7. ● Increase by 7 the metric of each learned RIP route in the range specified by ACL 8.
<p>A</p>	<pre>A# configure terminal A(config)# access-list 7 permit host 200.1.1.0 A(config)# access-list 8 permit host 201.1.1.0 A(config)# router rip A(config-router)# offset-list 7 out 7 A(config-router)# offset-list 8 in 7</pre>
<p>Verification</p>	<p>Check the routing table on Router A and Router B to verify that the metrics of RIP routes are 8.</p>
<p>A</p>	<pre>A# show ip route rip R 201.1.1.0/24 [120/8] via 192.168.1.2, 00:06:11, GigabitEthernet 0/1</pre>
<p>B</p>	<pre>B# show ip route rip R 200.1.1.0/24 [120/8] via 192.168.1.1, 00:06:11, GigabitEthernet 0/1</pre>

3.4.11 Modifying Timers

Configuration Effect

- Change the duration of RIP timers to accelerate or slow down the change of the protocol state or occurrence of an event.

Notes

- The RIP basic functions must be configured.
- Modifying the protocol control parameters may result in protocol running failures. Therefore, you are advised not to modify the timers.

Configuration Steps

➤ **Modifying the Update Timer, Invalid Timer, and Flush Timer**

This configuration must be performed if you need to adjust the RIP timers.

By adjusting the timers, you can reduce the convergence time and fault rectification time of the routing protocol. For routers connected to the same network, values of the three RIP timers must be the same. Generally, you are advised not to modify the RIP timers unless otherwise required.

Setting timers to small values on a low-speed link brings risks because a lot of Update packets consume the bandwidth. You can set timers to small values generally on the Ethernet or a 2 Mbps (or above) link to reduce the convergence time of network routes.

Unless otherwise required, this configuration should be performed on a router where RIP timers need to be modified.

➤ **Setting the Sending Delay Between RIP Route Update Packets**

This configuration must be performed if you need to adjust the sending delay between RIP Update packets.

Run the **output-delay** command to increase the sending delay between packets on a high-speed device so that a low-speed device can receive and process all Update packets.

Unless otherwise required, this configuration should be performed on a router where the sending delay needs to be adjusted.

Verification

Run the **show ip rip** command to display the current settings of RIP timers.

Related Commands

➤ **Modifying the Update Timer, Invalid Timer, and Flush Timer**

Command	timers basic update invalid flush
Syntax	
Parameter Description	<p><i>update</i>: Indicates the route update time in second. It defines the interval at which the device sends the route update packet. Each time an Update packet is received, the invalid timer and flush timer are reset. By default, a routing update packet is sent every 30s.</p> <p><i>invalid</i>: Indicates the route invalid time in second, counted from the last time when a valid update packet is received. It defines the time after which the route in the routing list becomes invalid because the route is not updated. The duration of the invalid timer must be at least three times the duration of the update timer. If no Update packet is received before the invalid timer expires, the corresponding route enters the invalid state. If the Update packet is received before the invalid timer expires, the timer is reset. The default duration of the invalid timer is 180s.</p> <p><i>flush</i>: Indicates the route flushing time in second, counted from the time when the RIP route enters the invalid state. When the flush timer expires, the route in the invalid state will be deleted from the routing table. The default duration of the flush timer is 120s.</p>
Command Mode	Routing process configuration mode
Configuration	By default, the update timer is 30s, the invalid timer is 180s, and the flush timer is 120s.

Usage	
--------------	--

▾ **Setting the Sending Delay Between RIP Route Update Packets**

Command Syntax	output-delay <i>delay</i>
Parameter Description	<i>delay</i> : Sets the sending delay between packets in ms. The value ranges from 8 to 50.
Command Mode	Interface configuration mode
Configuration Usage	Normally, a RIP route update packet is 512 bytes long and can contain 25 routes. If the number of routes to be updated exceeds 25, more than one update packet will be sent as fast as possible. When a high-speed device sends a lot of update packets to a low-speed device, the low-speed device may not be able to process all update packets in time, causing a loss of routing information. In this case, you need to run the output-delay command to increase the sending delay between packets on a high-speed device so that a low-speed device can receive and process all update packets.

Configuration Example

▾ **Setting the Sending Delay Between RIP Route Update Packets**

Scenario Figure 3-20	
Configuration Steps	<ul style="list-style-type: none"> ● Configure the interface IP addresses on all routers. (Omitted) ● Configure the RIP basic functions on all routers. (Omitted) ● Configure the sending delay of update packets on Router A.
A	<pre>A# configure terminal A(config)# router rip A(config-router)# output-delay 30</pre>
Verification	Capture packets on Router A and compare the sending time of update packets before and after the configuration, and verify that a delay of 30 ms is introduced.

Common Errors

For routers connected to the same network, values of the three RIP timers are not the same.

3.4.12 Enabling BFD Correlation

Configuration Effect

- Once a link is faulty, RIP can quickly detect the failure of the route. This configuration helps shorten the traffic interruption time.

Notes

- The RIP basic functions must be configured.
- The BFD correlation configured in interface configuration mode takes precedence over the global configuration.

Configuration Steps

↘ **Correlating RIP with BFD on All Interfaces**

- This configuration must be performed if you need to enable BFD correlation.
- After BFD is enabled on RIP, a BFD session will be set up for the RIP routing information source (that is, the source address of RIP route update packets). Once the BFD neighbor fails, the corresponding RIP route directly enters the invalid state and is not forwarded.
- You can also run the **ip ospf bfd [disable]** command in interface configuration mode to enable or disable the BFD function on a specified interface, and this configuration takes precedence over the **bfd all-interfaces** command used in routing process configuration mode.
- Unless otherwise required, this configuration should be performed on every router.

↘ **Correlating RIP with BFD on an Interface**

- This configuration must be performed if you need to enable or disable BFD correlation on a specified interface.
- The interface-based configuration takes precedence over the **bfd all-interfaces** command used in routing process configuration mode.
- Based on the actual environment, you can run the **ip ospf bfd** command to enable BFD on a specified interface for link detection, or run the **bfd all-interfaces** command in RIP process configuration mode to enable BFD on all interface of the OSPF process, or run the **ospf bfd disable** command to disable BFD on a specified interface.
- Unless otherwise required, configure this function on a router interface where BFD correlation should be configured separately.

Verification

- Verify that the BFD session is properly set up with RIP.
- After a link fails, the RIP route can quickly converges.

Related Commands

↘ **Correlating RIP with BFD on All Interfaces**

Command Syntax	bfd all-interfaces
Parameter Description	N/A
Command Mode	Routing process configuration mode
Configuration Usage	N/A

↘ **Correlating RIP with BFD on an Interface**

Command Syntax	ip rip bfd [disable]
Parameter Description	disable: Disables BFD for link detection on a specified RIP-enabled interface.
Command Mode	Interface configuration mode
Configuration Usage	By default, BFD correlation is not configured for a specified interface, and the configuration is subject to that configured in routing process configuration mode.

Configuration Example

↘ **Enabling BFD Correlation with RIP**

Scenario Figure 3- 21	
Configuration Steps	<ul style="list-style-type: none"> ● Configure the interface IP addresses on all routers. (Omitted) ● Configure the RIP basic functions on all routers. (Omitted) ● Configure the BFD parameters for interfaces of all routers. ● Correlate RIP with BFD on all routers.
A	<pre>A# configure terminal A(config)# interface GigabitEthernet 0/1 A(config-if-GigabitEthernet 0/1)# bfd interval 200 min_rx 200 multiplier 5 A(config)# router rip A(config-router)# bfd all-interfaces</pre>
B	<pre>B# configure terminal B(config)# interface GigabitEthernet 0/1 B(config-if-GigabitEthernet 0/1)# bfd interval 200 min_rx 200 multiplier 5 B(config)# router rip B(config-router)# bfd all-interfaces</pre>
Verification	<ul style="list-style-type: none"> ● On routers A and B, verify that the BFD session is in Up state. ● Disconnect Router B from the switch, and verify that the RIP route is deleted on Router A.
A	<pre>A# show ip rip peer Peer 192.168.1.2: Local address: 192.168.1.1</pre>

	<pre> Input interface: GigabitEthernet 0/1 Peer version: RIPv2 Received bad packets: 0 Received bad routes: 0 BFD session state up </pre>
B	<pre> A# show ip rip peer Peer 192.168.1.1: Local address: 192.168.1.2 Input interface: GigabitEthernet 0/1 Peer version: RIPv2 Received bad packets: 0 Received bad routes: 0 BFD session state up </pre>

Common Errors

- The preceding two commands are executed in RIP before the BFD function is enabled.

3.4.13 Enabling Fast Reroute

Configuration Effect

- Once RIP detects a route failure, the router can immediately switch to the second-best route. This configuration helps shorten the traffic interruption time.

Notes

- The RIP basic functions must be configured.
- The route map and the standby next hop must be configured.
- To accelerate the convergence, set carrier-delay of the interface to 0 and enable BFD correlation with RIP.

Configuration Steps

📌 Enabling Fast Reroute and Referencing the Route Map

This configuration must be performed if you need to enable fast reroute.

If **route-map** is configured, a standby path can be specified for a successfully matched route through the route map.

When the RIP fast reroute function is used, it is recommended that BFD be enabled at the same time so that the device can quickly detect any link failure and therefore shorten the forwarding interruption time. If the interface is up or down, to shorten the forwarding interruption time during RIP fast reroute, you can configure **carrier-delay 0** in interface configuration mode to achieve the fastest switchover speed.

Unless otherwise required, this configuration should be performed on every router.

Verification

- The standby route can be correctly computed and generated.
- When the active link fails, the data can be quickly switch over to the standby link for forwarding.

Related Commands

📌 **Enabling Fast Reroute and Referencing the Route Map**

Command	fast-reroute route-map <i>route-map-name</i>
Syntax	
Parameter	<i>route-map-name</i> : Specifies a standby path through the route map.
Description	
Command Mode	Routing process configuration mode
Configuration Usage	Currently, the RIP fast reroute function is subject to the following constraints: (1) Only one standby next hop can be generated for one route; (2) No standby next hop can be generated for equal and equal-cost multi-path routing (ECMP).

Configuration Example

📌 **Enabling Fast Reroute and Referencing the Route Map**

<p>Scenario Figure 3- 22</p>			
	<table border="1"> <tr> <td>Remarks</td> <td> The interface IP addresses are as follows: A: GE0/1 192.168.1.1 GE0/2 192.168.2.1] B: GE0/1 192.168.1.2 GE0/2 192.168.3.1 GE0/3 192.168.4.1 C: GE0/1 192.168.3.2 GE 0/2 192.168.2.2 </td> </tr> </table>	Remarks	The interface IP addresses are as follows: A: GE0/1 192.168.1.1 GE0/2 192.168.2.1] B: GE0/1 192.168.1.2 GE0/2 192.168.3.1 GE0/3 192.168.4.1 C: GE0/1 192.168.3.2 GE 0/2 192.168.2.2
Remarks	The interface IP addresses are as follows: A: GE0/1 192.168.1.1 GE0/2 192.168.2.1] B: GE0/1 192.168.1.2 GE0/2 192.168.3.1 GE0/3 192.168.4.1 C: GE0/1 192.168.3.2 GE 0/2 192.168.2.2		
<p>Configuration Steps</p>	<ul style="list-style-type: none"> ● Configure the interface IP addresses on all routers. (Omitted) ● Configure the RIP basic functions on all routers. (Omitted) ● Configure fast re-route on Router A. ● Configure carrier-delay 0 for the interface on Router A. 		

A	<pre> A# configure terminal A(config)# route-map fast-reroute A(config-route-map)# match interface GigabitEthernet 0/2 A(config-route-map)# set fast-reroute backup-interface GigabitEthernet 0/1 backup-nexthop 192.168.1.1 A(config)# router rip A(config-router)# fast-reroute route-map fast-reroute A(config)# interface GigabitEthernet 0/1 A(config-if-GigabitEthernet 0/1)# carrier-delay 0 A(config-if-GigabitEthernet 0/1)# exit A(config)# interface GigabitEthernet 0/2 A(config-if-GigabitEthernet 0/2)# carrier-delay 0 </pre>
Verification	On Router A, check the routing table and verify that a standby route exists for the entry 192.168.4.0/24.
A	<pre> A# show ip route fast-reroute begin 192.168.4.0 R 192.168.4.0/24 [ma] via 192.168.1.2, 00:39:28, GigabitEthernet 0/1 [b] via 192.168.2.2, 00:39:28, GigabitEthernet 0/2 </pre>

Common Errors

- The standby next hop is not properly configured for the route map.
- The carrier-delay is not configured for the interface or BFD correlation is not configured. Consequently, the switchover speed of the forwarding line is slow.

3.4.14 Enabling GR

Configuration Effect

- When a distributed route switches services from the active board to the standby board, traffic forwarding continues and is not interrupted.
- When the RIP process is being restarted, traffic forwarding continues and is not interrupted.

Notes

- The RIP basic functions must be configured.
- The GR period is at least twice the RIP route update period.
- During the RIP GR process, ensure that the network environment is stable.

Configuration Steps

📌 Configuring the GR Restarter Capability

This configuration must be performed if RIP needs to be gracefully restarted to ensure data forwarding during hot standby switchover.

The GR function is configured based on the RIP process. You can configure different parameters for different RIP processes based on the actual conditions.

The GR period is the maximum time from restart of the RIP process to completion of GR. During this period, the forwarding table before the restart is retained, and the RIP route is restored so as to restore the RIP state before the restart. After the restart period expires, RIP exits from the GR state and performs common RIP operations.

Unless otherwise required, this configuration should be performed on every router that needs to be gracefully restarted.

Verification

- Run the **show ip rip** command to display the GR state and configured time.
- Trigger a hot standby switchover, and verify that data forwarding is not interrupted.

Related Commands

📌 **Configuring the GR Restarter Capability**

Command Syntax	graceful-restart [grace-period <i>grace-period</i>]
Parameter Description	<p>graceful-restart: Enables the GR function.</p> <p>grace-period: Explicitly configures the grace period.</p> <p><i>grace-period:</i> Indicates the GR period. The value ranges from 1s to 1800s.</p> <p>The default value is twice the update time or 60s, whichever is the smaller.</p>
Command Mode	Routing process configuration mode
Configuration Usage	<p>This command allows you to explicitly modify the GR period. Note that GR must be completed after the update timer of the RIP route expires and before the invalid timer of the RIP route expires. An inappropriate GR period cannot ensure uninterrupted data forwarding during the GR process. A typical case is as follows: If the GR period is longer than the duration of the invalid timer, GR is not completed when the invalid timer expires. The route is not re-advertised to the neighbor, and forwarding of the route of the neighbor stops after the invalid timer expires, causing interruption of data forwarding on the network. Unless otherwise required, you are advised not to adjust the GR period. If it is necessary to adjust the GR period, ensure that the GR period is longer than the duration of the update timer but shorter than the duration of the invalid timer based on the configuration of the timers basic command.</p>

Configuration Example

📌 **Configuring the GR Restarter Capability**

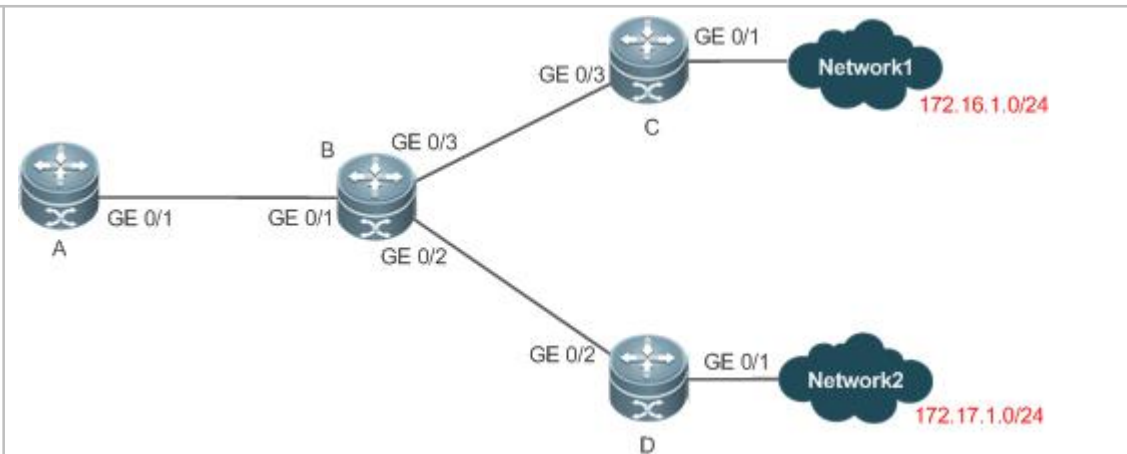
<p>Scenario Figure 3-23</p>	 <table border="1" data-bbox="313 638 1431 862"> <tr> <td>Remarks</td> <td>The interface IP addresses are as follows: A: GE 0/1 192.168.1.1 B: GE 0/1 192.168.1.1 GE 0/2 192.168.2.1 GE 0/3 192.168.3.1 C: GE 0/1 192.168.4.2 GE 0/3 192.168.3.2 D: GE 0/1 192.168.5.2 GE 0/2 192.168.2.2</td> </tr> </table>	Remarks	The interface IP addresses are as follows: A: GE 0/1 192.168.1.1 B: GE 0/1 192.168.1.1 GE 0/2 192.168.2.1 GE 0/3 192.168.3.1 C: GE 0/1 192.168.4.2 GE 0/3 192.168.3.2 D: GE 0/1 192.168.5.2 GE 0/2 192.168.2.2
Remarks	The interface IP addresses are as follows: A: GE 0/1 192.168.1.1 B: GE 0/1 192.168.1.1 GE 0/2 192.168.2.1 GE 0/3 192.168.3.1 C: GE 0/1 192.168.4.2 GE 0/3 192.168.3.2 D: GE 0/1 192.168.5.2 GE 0/2 192.168.2.2		
<p>Configuration Steps</p>	<ul style="list-style-type: none"> ● Configure the interface IP addresses on all routers. (Omitted) ● Configure the RIP basic functions on all routers. (Omitted) ● On Router B, enable the GR function. 		
	<pre>B# configure terminal B(config)# router rip B(config-router)# graceful-restart grace-period 90</pre>		
<p>Verification</p>	<ul style="list-style-type: none"> ● Trigger a hot standby switchover on Router B, and verify that the routing tables of destination Network 1 and Network 2 remain unchanged on Router A during the switchover. ● Trigger a hot standby switchover on Router B, ping destination Network 1 from Router A, and verify that traffic forwarding is not interrupted during the switchover. 		

3.4.15 Enabling Multiple Instances

Configuration Effect

- Run RIP on VPN instances.

Notes

- The RIP basic functions (with the VRF parameter) must be configured.

Configuration Steps

📌 **Creating a VRF Instance and Entering the IPv4 VRF Address Family**

- This configuration must be performed if you need to configure RIP multiple instances and associate these RIP instances with VRF.
- Unless otherwise required, this configuration should be performed on every router that requires the RIP multiple instances.

➤ **Binding the RIP MIB with a VPN Instance**

- This configuration must be performed if you configure RIP multiple instances and wish to manage non-default RIP instances using the MIB.
- The RIP MIB does not have the RIP instance information. Therefore, you must perform operations only on one instance through SNMP. By default, the RIP MIB is bound with the RIP instance of the default VRF, and all user operations take effect on this instance.
- If you wish to perform operations on a specified RIP instance through SNMP, run this command to bind the MIB with the instance.
- Unless otherwise required, this configuration should be performed on a router where the instance is managed using the MIB.

Verification

- Check the VRF routing table on a router to verify that the route to a remote network can be obtained through RIP.
- Use the MIB management software to manage the bound instance.

Related Commands

➤ **Creating a VRF Instance and Entering the IPv4 VRF Address Family**

Command Syntax	address-family ipv4 vrf vrf-name
Parameter Description	vrf vrf-name: Specifies the name of the VRF associated with the address family configuration sub-mode.
Command Mode	Routing process configuration mode
Configuration Usage	Run the address-family command to enter address family configuration sub-mode, the prompt of which is (config-router-af)#. When the VRF associated with the address family configuration sub-mode is specified for the first time, the RIP instance corresponding to the VRF will be created. In this submode, you can configure the RIP routing information for the related VRF. To exit from address family configuration sub-mode and return routing process configuration mode, run the exit-address-family or exit command.

➤ **Exiting From an IPv4 VRF Address Family**

Command Syntax	exit-address-family
Parameter Description	N/A
Command Mode	Address family configuration mode
Configuration Usage	Run this command in address family configuration mode to exit from this configuration mode. This command can be abbreviated as exit .

➤ **Binding the RIP MIB with a VPN Instance**

Command	enable mib-binding
----------------	---------------------------

Syntax	
Parameter	N/A
Description	
Command Mode	Routing process configuration mode
Configuration Usage	N/A

Configuration Example

📌 **Creating a VRF Instance and Enabling Network Management of This Instance**

<p>Scenario Figure 3-24</p>	
<p>Configuration Steps</p>	<ul style="list-style-type: none"> ● Configure the interface IP addresses on all routers. (Omitted) ● Configure the RIP basic functions on all routers. (Omitted) ● Create a VRF named "vpn1" and create a RIP instance for this VRF. ● On Router A, bind the MIB with the RIP vpn1 instance.
	<pre> A# configure terminal A(config)# snmp-server community public rw A(config)# ip vrf vpn1 A(config-vrf)# exit A(config)# interface GigabitEthernet 0/1 A(config-if-GigabitEthernet0/1)# ip vrf forwarding vpn1 A(config-if-GigabitEthernet0/1)# ip address 192.168.1.1 255.255.255.0 A(config)# router rip A(config-router)# address-family ipv4 vrf vpn1 A(config-router)# enable mib-binding A(config-router-af)# network 192.168.1.0 A(config-router-af)# exit-address-family </pre>
<p>Verification</p>	<ul style="list-style-type: none"> ● Check the routing table on Router A, and verify that the VRF route 201.1.1.0/24 can be learned. ● Read and configure parameters of the RIP vpn1 instance using the MIB tool.

```
A# show ip route vrf vpn1 rip
R    201.1.1.0/24 [120/1] via 192.168.1.2, 00:06:11, GigabitEthernet 0/1
```

3.5 Monitoring

Displaying

Description	Command
Displays the basic information about a RIP process.	show ip rip
Displays the RIP routing table.	show ip rip database [vrf vrf-name] [network-number network-mask] [count]
Displays information about external routes redistributed by RIP.	show ip rip external [bgp connected isis [process-id] ospf process-id static] [vrf vrf-name]
Displays the RIP interface information.	show ip rip interface [vrf vrf-name] [interface-type interface-number]
Displays the RIP neighbor information.	show ip rip peer [ip-address] [vrf vrf-name]

Debugging



System resources are occupied when debugging information is output. Therefore, disable debugging immediately after use.

Description	Command
Debugs events that occur when the RIP process is running.	debug ip rip event
Debugs interaction with the NSM process.	debug ip rip nsm
Debugs the sent and received packets.	debug ip rip packet [interface interface-type interface-number recv send]
Debugs the RIP GR process.	debug ip rip restart
Debugs the route changes of the RIP process.	debug ip rip route

4 Configuring OSPFv2

4.1 Overview

Open Shortest Path First (OSPF) is an Interior Gateway Protocol (IGP) that is used within the Autonomous System (AS) to allow routers to obtain a route to a remote network.



OSPF Version 2 (OSPFv2) is applicable to IPv4, and OSPF Version 3 (OSPFv3) is applicable to IPv6. The protocol running mechanism and most configurations are the same.

OSPF has the following characteristics:

- Wide scope of application: OSPF is applicable to a larger-scale network that supports hundreds of routers.
- Fast convergence: Once the network topology changes, notifications can be quickly sent between routers to update routes.
- No self-loop: Only the link status information is synchronized between routers. Each router computes routes independently, and a self-loop will not occur.

- Area division: A large routing domain is divided into multiple small areas to save system resources and network bandwidth and ensure stability and reliability of routes.
- Route classification: Routes are classified into several types to support flexible control.
- Equivalent routes: OSPF supports equivalent routes.
- Authentication: OSPF supports packet authentication to ensure security of protocol interaction.
- Multicast transmission: Protocol packets are sent using the multicast address to avoid interfering with irrelevant entities and save system resources.

i In this chapter, the term "router" refers to any network device that supports the routing function. These network devices can be L3 switches, routers, or firewall.

i Unless otherwise specified, "OSPF" in the following descriptions refers to OSPFv2.

Protocols and Standards

RFC2328	This memo documents version 2 of the OSPF protocol. OSPF is a link-state routing protocol.
RFC 2370	This memo defines enhancements to the OSPF protocol to support a new class of link-state advertisements (LSA) called Opaque LSAs. Opaque LSAs provide a generalized mechanism to allow for the future extensibility of OSPF.
RFC3137	This memo describes a backward-compatible technique that may be used by OSPF (Open Shortest Path First) implementations to advertise unavailability to forward transit traffic or to lower the preference level for the paths through such a router.
RFC3623	This memo documents an enhancement to the OSPF routing protocol, whereby an OSPF router can stay on the forwarding path even as its OSPF software is restarted.
RFC3630	This document describes extensions to the OSPF protocol version 2 to support intra-area Traffic Engineering (TE), using Opaque Link State Advertisements.
RFC3682	The use of a packet's Time to Live (TTL) (IPv4) or Hop Limit (IPv6) to protect a protocol stack from CPU-utilization based attacks has been proposed in many settings.
RFC3906	This document describes how conventional hop-by-hop link-state routing protocols interact with new Traffic Engineering capabilities to create Interior Gateway Protocol (IGP) shortcuts.
RFC4576	This document specifies the necessary procedure, using one of the options bits in the LSA (Link State Advertisements) to indicate that an LSA has already been forwarded by a PE and should be ignored by any other PEs that see it.
RFC4577	This document extends that specification by allowing the routing protocol on the PE/CE interface to be the OSPF protocol.
RFC4750	This memo defines a portion of the Management Information Base (MIB) for use with network management protocols in TCP/IP-based Internets. In particular, it defines objects for managing version 2 of the Open Shortest Path First Routing Protocol. Version 2 of the OSPF protocol is specific to the IPv4 address family.

4.2 Applications

Application	Description
Intra-Domain Interworking	OSPF runs within the AS, which is divided into several areas.

Inter-Domain Interworking	Several ASs are interconnected. OSPF runs within each AS, and Border Gateway Protocol (BGP) runs between ASs.
---------------------------	---

4.2.1 Intra-Domain Interworking

Scenario

OSPF runs within the AS. If the number of routers exceeds 40, it is recommended that the AS be divided into several areas. Generally, high-end devices featuring reliable performance and fast processing speed are deployed in a backbone area, and low-end or medium-range devices with relatively lower performance can be deployed in a normal area. All normal areas must be connected to the backbone area. It is recommended that a normal area allocated on the stub be configured as a stub area. As shown in Figure 4-1, the network is divided into four areas. Communication between these areas must go through the backbone area, that is area 0.

Figure 4-1 Division of the OSPF Areas

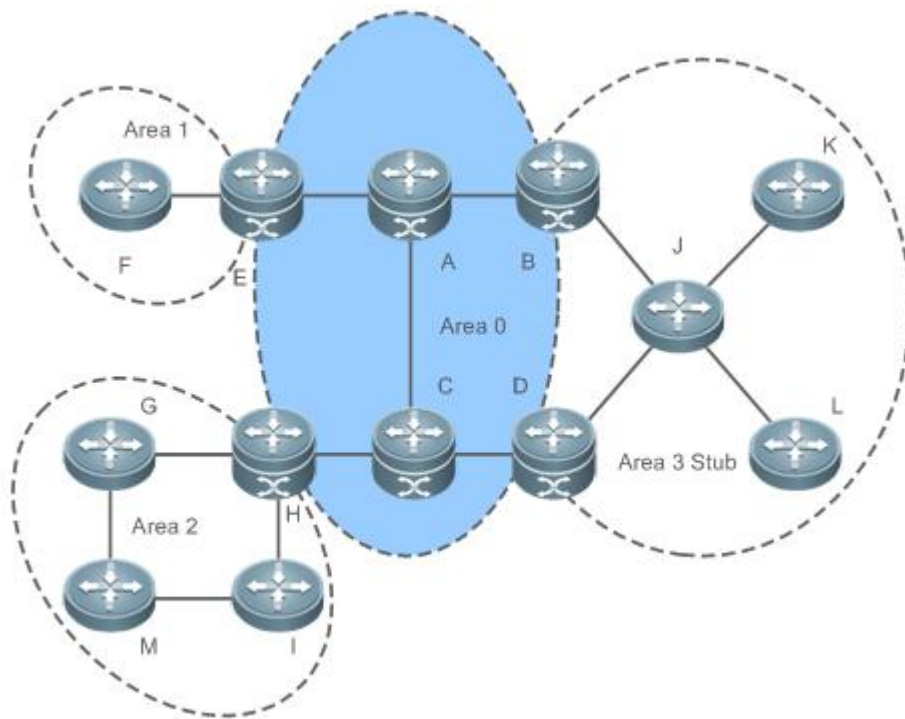

Remarks	A, B, C, D, E, and H are located in the backbone area, and are backbone routers. Area 3 is configured as a stub area.
----------------	--

Deployment

- OSPF runs on all routers within the AS to implement unicast routing.

4.2.2 Inter-Domain Interworking

Scenario

Several ASs are interconnected. OSPF runs within each AS, and BGP runs between ASs. Generally, OSPF and BGP learn the routing information from each other.

As shown in Figure 4-2, unicast routing is implemented within AS 100 and AS 200 using OSPF, and between the two ASs using BGP.

Figure 4- 2Interworking Between OSPF and BGP

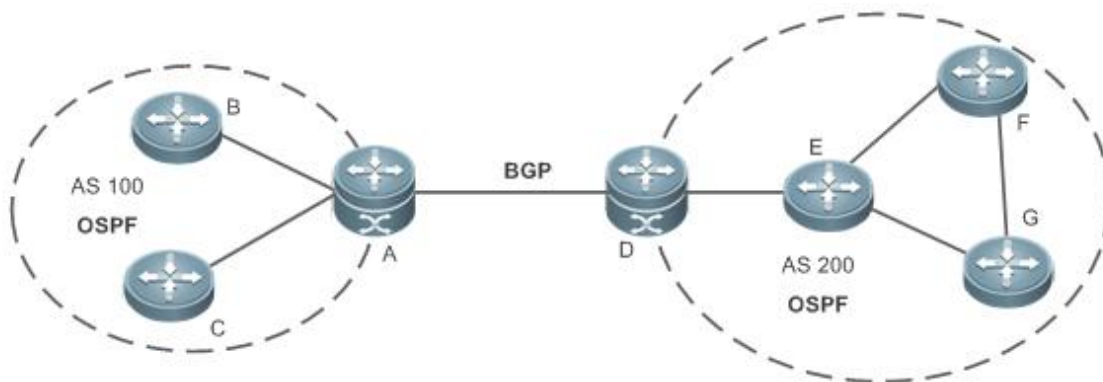

Remarks	OSPF and BGP run concurrently on Router A and Router D.
----------------	---

Deployment

- OSPF runs within AS 100 and AS 200 to implement unicast routing.
- BGP runs between the two ASs to implement unicast routing.

4.3Features

Basic Concepts

➤ **Routing Domain**

All routers in an AS must be interconnected and use the same routing protocol. Therefore, the AS is also called routing domain.

An AS on which OSPF runs is also called OSPF routing domain, or OSPF domain for short.

➤ **OSPF Process**

OSPF supports multiple instances, and each instance corresponds to an OSPF process.

One or more OSPF processes can be started on a router. Each OSPF process runs OSPF independently, and the processes are mutually isolated.

The process ID takes effect only on the local router, and does not affect exchange of OSPF packets on adjacent interfaces.

➤ **RouterID**

The router ID uniquely identifies a router in an OSPF domain. Router IDs of any two routers cannot be the same.

If multiple OSPF processes exist on a router, each OSPF process uses one router ID. Router IDs of any two OSPF processes cannot be the same.

➤ **Area**

OSPF supports multiple areas. An OSPF domain is divided into multiple areas to ease the computing pressure of a large-scale network.

An area is a logical group of routers, and each group is identified by an area ID. The border between areas is a router. A router may belong to one area or multiple areas. One network segment (link) can belong to only one area, or each OSPF-enabled interface must belong to a specified area.

Area 0 is the backbone area, and other areas are normal areas. Normal areas must be directly connected to the backbone area.

Figure 4-3 Division of the OSPF Areas

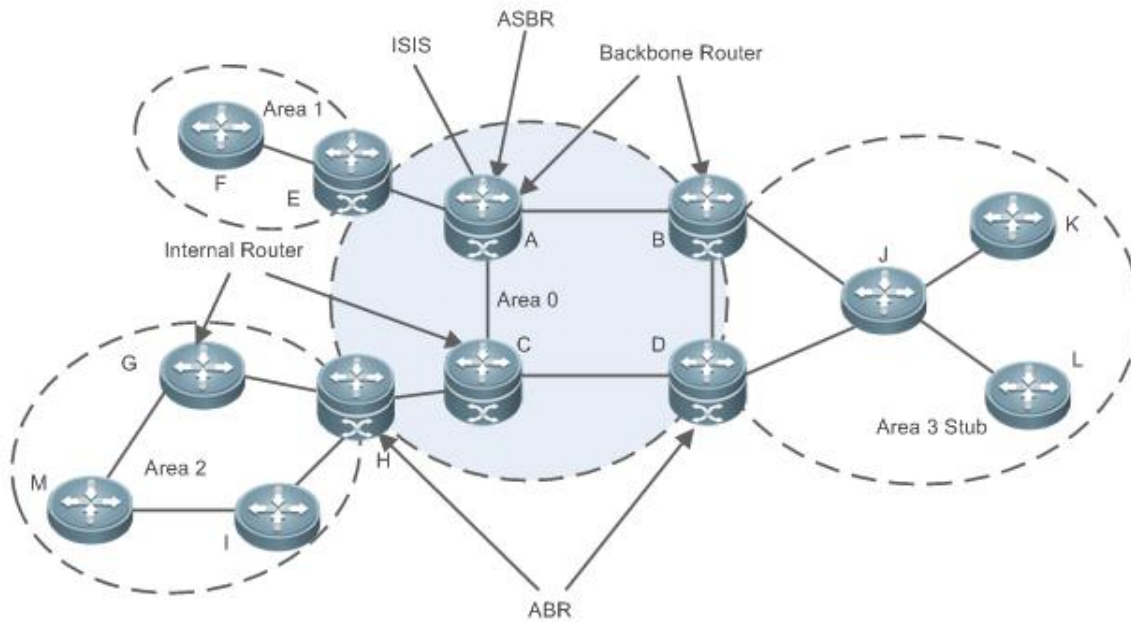

➤ **OSPF Router**

The following types of routers are defined in OSPF, and assigned with different responsibilities:

- **Internal router**
All interface of an interval router belong to the same OSPF area. As shown in Figure 1-3, A, C, F, G, I, M, J, K, and L are internal routers.
- **Area border router (ABR)**
An ABR is used to connect the backbone area with a normal area. An ABR belongs to two or more areas, and one of the areas must be the backbone area. As shown in Figure 1-3, B, D, E, and H are ABRs.
- **Backbone router**
A backbone router has at least one interface that belongs to the backbone area. All ABRs and all routers in area 0 are backbone routers. As shown in Figure 4-3, A, B, C, D, E, and H are backbone routers.
- **AS boundary router (ASBR)**
An ASBR is used to exchange routing information with other ASs. An ASBR is not necessarily located on the border of an AS. It may be a router inside an area, or an ABR. As shown in Figure 1-3, A is an ASBR.

➤ **Virtual Link**

OSPF supports virtual links. A virtual link is a logical link that belongs to the backbone area. It is used to resolve the problems such as a discontinuous backbone area or a failure to directly connect a normal area to the backbone area on the physical network. A virtual link supports traversal of only one normal area, and this area is called transit area. Routers on both ends of a virtual link are ABRs.

Figure 4-4 Discontinuous Backbone Area on the Physical Network

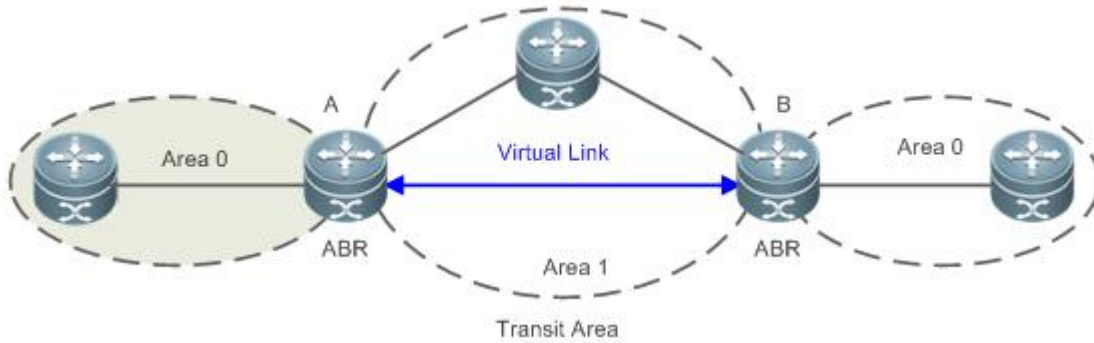

As shown in Figure 4- 4, a virtual link is set up between A and B to connect two separated area 0s. Area 1 is a transit area, and A and B are ABRs of area 1.

Figure 4- 5 Failure to Directly Connect a Normal Area to the Backbone Area on the Physical Network

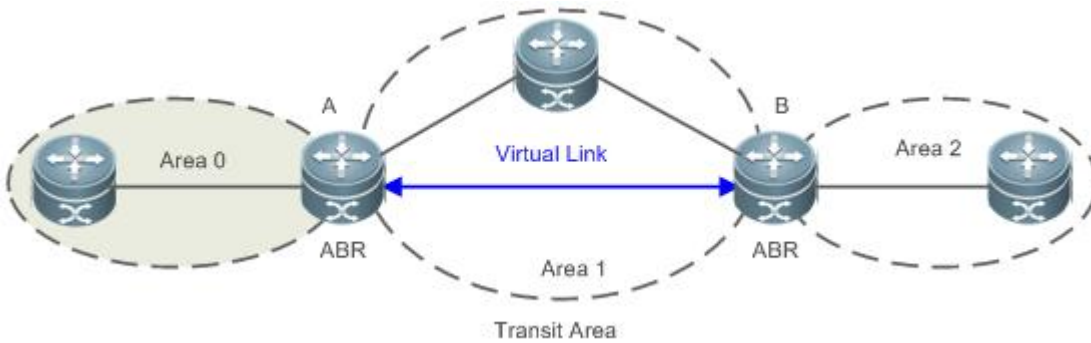

As shown in Figure 4- 4, a virtual link is set up between A and B to extend area 0 to B so that area 0 can be directly connected to area 2 on B. Area 1 is a transit area, A is an ABR of area 1, and B is an ABR of area 0 and area 2.

➤ **LSA**

OSPF describes the routing information by means of Link State Advertisement (LSA).

LSA Type	Description
Router-LSA(Type 1)	This LSA is originated by every router. It describes the link state and cost of the router, and is advertised only within the area where the originating router is located.
Network-LSA(Type 2)	This LSA is originated by a designated routers (DR) on the NBMA network. It describes the link state in the current network segment, and is advertised only within the area where the DR is located.
Network-summary-LSA(Type 3)	This LSA is originated by an ABR. It describes a route to another area, and is advertised to areas except totally stub areas or Not-So-Stubby Area (NSSA) areas.
ASBR-summary-LSA(Type 4)	This LSA is originated by an ABR. It describes a route to an ASBR, and is advertised to areas except areas where the ASBR is located.
AS-external-LSA(Type 5)	This LSA is originated by an ABR. It describes a route to a destination outside the AS, and is advertised to all areas except the stub and NSSA areas.
NSSA LSA(Type 7)	This LSA is originated by an ABR. It describes a route to a destination outside the AS, and is advertised only within the NASSA areas.
Opaque LSA(Type 9/Type 10/Type 11)	Opaque LSAs provide a generalized mechanism to allow for the future extensibility of OSPF, wherein, <ul style="list-style-type: none"> ● Type 9 LSAs are only advertised within the network segment where interfaces resides. The

LSA Type	Description
	Grace LSA used to support graceful restart (GR) is one of Type 9 LSAs. <ul style="list-style-type: none"> Type 10 LSAs are advertised within an area. The LSA used to support Traffic Engineering (TE) is one of Type 10 LSAs. Type 11 LSAs are advertised within an AS. At present, there are no application examples of Type 11 LSAs.

i Stub areas, NSSA areas, totally stub areas, and totally NSSA areas are special forms of normal areas and help reduce the load of routers and enhance reliability of OSPF routes.

↘ OSPF Packet

The following table lists the protocol packets used by OSPF. These OSPF packets are encapsulated in IP packets and transmitted in multicast or unicast mode.

Packet Type	Description
Hello	Hello packets are sent periodically to discover and maintain OSPF neighbor relationships.
Database Description (DD)	DD packets carry brief information about the local Link-State Database (LSDB) and are used to synchronize the LSDBs between OSPF neighbors.
Link State Request (LSR)	LSR packets are used to request the required LSAs from neighbors. LSR packets are sent only after DD packets are exchanged successfully between OSPF neighbors.
Link State Update (LSU)	LSU packets are used to send the required LSAs to peers.
Link State Acknowledgment (LSAck)	LSAck packets are used to acknowledge the received LSAs.

Overview

Feature	Description
Link-State Routing Protocols	Run OSPF on the router to obtain routes to different destinations on the network.
OSPF Route Management	Plan or optimize OSPF routes through manual configuration to implement management of OSPF routes.
Enhanced Security and Reliability	Use functions such as authentication and bidirectional forwarding detection (BFD) correlation to enhance security, stability, and reliability of OSPF.
Network Management	Use functions such as the management information base (MIB) and Syslog to facilitate OSPF management.

4.3.1 Link-State Routing Protocols

OSPF is a type of link-state routing protocols. Its working process is as follows:

- Neighbor discovery → Bidirectional communication
An OSPF neighbor relationship is set up between adjacent routers, and bidirectional communication is maintained.
- Database synchronization → Full adjacency
A router uses LSAs to advertise all its link states. LSAs are exchanged between neighbors and the link state database (LSDB) is synchronized to achieve full adjacency.
- Shortest Path Tree (SPT) computation → Formation of a routing table
The router computes the shortest path to each destination network based on the LSDB and forms an OSPF routing table.

Working Principle

↘ Neighbor Discovery → Bidirectional Communication

Routers send Hello packets through all OSPF-enabled interfaces (or virtual links). If Hello packets can be exchanged between two routers, and parameters carried in the Hello packets can be successfully negotiated, the two routers become neighbors. Routers that are mutually neighbors find their own router IDs from Hello packets sent from neighbors, and bidirectional communication is set up.

A Hello packet includes, but is not limited to, the following information:

- Router ID of the originating router
- Area ID of the originating router interface (or virtual link)
- Subnet mask of the originating router interface (or virtual link)
- Authentication information of the originating router interface (or virtual link)
- Hello interval of the originating router interface (or virtual link)
- Neighbor dead interval of the originating router interface (or virtual link)
- Priority of the originating router interface (used for DR/BDR election)
- IP addresses of the DR and Backup Designated Router (BDR)
- Router ID of the neighbor of the originating router

↘ Database Synchronization → Full Adjacency

After bidirectional communication is set up between neighbor routers, the DD, LSR, LSU, and LSAck packets are used to exchange LSAs and set up the adjacency. The brief process is as follows:

- A router generates an LSA to describe all link states on the router.
- The LSA is exchanged between neighbors. When a router receives the LSA from its neighbor, it copies the LSA and saves the copy in the local LSDB, and then advertises the LSA to other neighbors.
- When the router and its neighbors obtain the same LSDB, full adjacency is achieved.
-  OSPF will be very quiet without changes in link costs or network addition or deletion. If any change takes place, the changed link states are advertised to quickly synchronize the LSDB.

↘ SPT Computation → Formation of a Routing Table

After the complete LSDB is obtained from the router, the Dijkstra algorithm is run to generate an SPT from the local router to each destination network. The SPT records the destination networks, next-hop addresses, and costs. OSPF generates a routing table based on the SPT.

If changes in link costs or network addition or deletion take place, the LSDB will be updated. The router again runs the Dijkstra algorithm, generates a new SPT, and updates the routing table.

-  The Dijkstra algorithm is used to find a shortest path from a vertex to other vertices in a weighted directed graph.

↘ OSPF Network Types

A router does not necessarily need to exchange LSAs with every neighbor and set up an adjacency with every neighbor. To improve efficiency, OSPF classifies networks that use various link layer protocols into five types so that LSAs are exchanged in different ways to set up an adjacency:

- Broadcast
Neighbors are discovered, and the DR and BDR are elected.

The DR (or BDR) exchanges LSAs with all other routers to set up an adjacency. Except the DR and BDR, all other routers do not exchange LSAs with each other, and the adjacency is not set up.

Ethernet and fiber distributed data interface (FDDI) belong to the broadcast network type by default.

- Non-broadcast multiple access (NBMA)

Neighbors are manually configured, and the DR and BDR are elected.

The DR (or BDR) exchanges LSAs with all other routers to set up an adjacency. Except the DR and BDR, all other routers do not exchange LSAs with each other, and the adjacency is not set up.

X.25, frame relay, and ATM belong to NBMA networks by default.
- Point-to-point (P2P)

Neighbors are automatically discovered, and the DR or BDR is not elected.

LSAs are exchanged between routers at both ends of the link, and the adjacency is set up.

PPP, HDLC, and LAPB belongs to the P2P network type by default.
- Point-to-multipoint (P2MP)

Neighbors are automatically discovered, and the DR or BDR is not elected.

LSAs are exchanged between any two routers, and the adjacency is set up.

Networks without any link layer protocol belong to the P2MP network type by default. P2MP broadcast

Neighbors are manually configured, and the DR or BDR is not elected.

LSAs are exchanged between any two routers, and the adjacency is set up.

Networks without any link layer protocol belong to the P2MP network type by default.

📌 **OSPF Route Types**

Figure 4-6

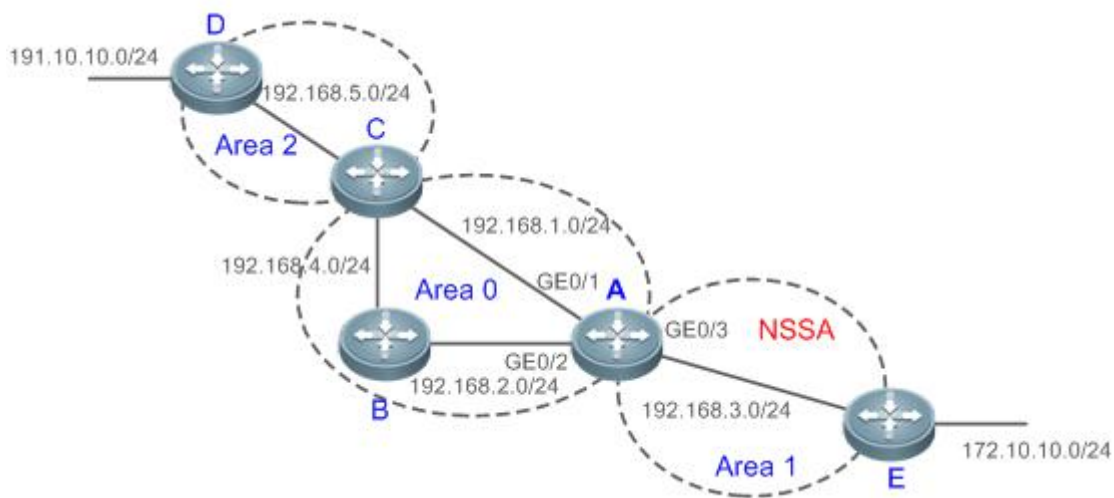

Display the OSPF routes (marked in red) in the routing table of Router A.

```
A#show ip route

Codes: C - connected, S - static, R - RIP, B - BGP
O - OSPF, IA - OSPF inter area
N1 - OSPF NSSA external type 1, N2 - OSPF NSSA external type 2
```

```

E1 - OSPF external type 1, E2 - OSPF external type 2
i - IS-IS, su - IS-IS summary, L1 - IS-IS level-1, L2 - IS-IS level-2
ia - IS-IS inter area, * - candidate default

Gateway of last resort is no set

O N2 172.10.10.0/24 [110/20] via 192.168.3.2, 00:01:00,GigabitEthernet 0/3
O E2 191.10.10.0/24 [110/20] via 192.168.1.2, 01:11:26,GigabitEthernet 0/1
C   192.168.1.0/24 is directly connected,GigabitEthernet 0/1
C   192.168.1.1/32 is local host.
C   192.168.2.0/24 is directly connected,GigabitEthernet 0/2
C   192.168.2.1/32 is local host.
C   192.168.3.0/24 is directly connected,GigabitEthernet 0/3
C   192.168.3.1/32 is local host.
O   192.168.4.0/24 [110/2] via 192.168.2.2, 00:00:02,GigabitEthernet 0/2
O IA 192.168.5.0/24 [110/3] via 192.168.1.2, 00:01:02,GigabitEthernet 0/1

```

A mark is displayed in front of each OSPF route to indicate the type of the route. There are six types of OSPF routes:

- **O: Intra-area route**
This type of route describes how to arrive at a destination network in the local area. The cost of this type of route is equal to the cost of the route from the local router to the destination network.
- **IA: Inter-area route**
This type of route describes how to arrive at a destination network in another area. The cost of this type of route is equal to the cost of the route from the local router to the destination network.
- **E1: Type 1 external route**
This type of route describes how to arrive at a destination network outside the AS. The cost of this type of route is equal to the cost of the route from the local router to the ASBR plus the cost of the route from the ASBR to the destination network. This type of route does not exist on routers in the stub or NSSA area.
- **E2: Type 2 external route**
This type of route describes how to arrive at a destination network outside the AS. The cost of this type of route is equal to the cost of the route from the ASBR to the destination network. This type of route does not exist on routers in the stub or NSSA area.
- **N1: Type 1 external route of the NSSA area**
This type of route describes how to arrive at a destination network outside the AS through the ASBR in the NSSA area. The cost of this type of route is equal to the cost of the route from the local router to the ASBR plus the cost of the route from the ASBR to the destination network. This type of route exists only on routers in the NSSA area.
- **N2: Type 2 external route of the NSSA area**
This type of route describes how to arrive at a destination network outside the AS through the ASBR in the NSSA area. The cost of this type of route is equal to the cost of the route from the ASBR to the destination network. This type of route exists only on routers in the NSSA area.

- i** Reliability of E2 and N2 routes is poor. OSPF believes that the cost of the route from the ASBR to a destination outside an AS is far greater than the cost of the route to the ASBR within the AS. Therefore, when the route cost is computed, only the cost of the route from the ASBR to a destination outside an AS is considered.

Related Configuration

↳ Enabling OSPF

OSPF is disabled by default.

Run the **router ospf 1** command to create an OSPF process on the router.

Run the **network area** command to enable OSPF on the interface and specify the area ID.

Run the **area virtual-link** command to create a virtual link on the router. The virtual link can be treated as a logical interface.

↳ Router ID

By default, the OSPF process elects the largest IP address among the IP addresses of all the loopback interfaces as the router ID. If the loopback interfaces configured with IP addresses are not available, the OSPF process elects the largest IP address among the IP addresses of all the loopback interfaces as the router ID.

Alternatively, you can run the **router-id** command to manually specify the router ID.

↳ Protocol Control Parameters

Run the **ip ospf hello-interval** command to modify the Hello interval on the interface. The default value is 10s (or 30s for NBMA networks).

Run the **ip ospf dead-interval** command to modify the neighbor dead interval on the interface. The default value is four times the Hello interval.

Use the **poll-interval** parameter in the **neighbor** command to modify the neighbor polling interval on the NBMA interface. The default value is 120s.

Run the **ip ospf transmit-delay** command to modify the LSU packet transmission delay on the interface. The default value is 1s.

Run the **ip ospf retransmit-interval** command to modify the LSU packet retransmission interval on the interface. The default value is 5s.

Use the **hello-interval** parameter in the **area virtual-link** command to modify the Hello interval on the virtual link. The default value is 10s.

Use the **dead-interval** parameter in the **area virtual-link** command to modify the neighbor dead interval on the virtual link. The default value is four times the Hello interval.

Use the **transmit-delay** parameter in the **area virtual-link** command to modify the LSU packet transmission delay on the virtual link. The default value is 1s.

Use the **retransmit-interval** parameter in the **area virtual-link** command to modify the LSU packet retransmission interval on the virtual link. The default value is 5s.

Run the **timers throttle lsa all** command to modify parameters of the exponential backoff algorithm that generates LSAs. The default values of these parameters are 0 ms, 5000 ms, and 5000 ms.

Run the **timers spacing lsa-group** command to modify the LSA group update interval. The default value is 30s.

Run the **timers pacing lsa-transmit** command to modify the LS-UPD packet sending interval and the number of sent LS-UPD packets. The default values are 40 ms and 1.

Run the **timers lsa arrival** command to modify the delay after which the same LSA is received. The default value is 1000 ms.

Run the **timers throttle spf** command to modify the SPT computation delay, minimum interval between two SPT computations, and maximum interval between two SPT computations. The default values are 1000 ms, 5000 ms, and 10000 ms.

📌 OSPF Network Types

By default, Ethernet and FDDI belong to the broadcast type, X.25, frame relay, and ATM belong to the NBMA type, and PPP, HDLC, and LAPB belong to the P2P type.

Run the **ip ospf network** command to manually specify the network type of an interface.

Run the **neighbor** command to manually specify a neighbor. For the NBMA and P2MP non-broadcast types, you must manually specify neighbors.

Run the **ip ospf priority** command to adjust the priorities of interfaces, which are used for DR/BDR election. The DR/BDR election is required for the broadcast and NBMA types. The router with the highest priority wins in the election, and the router with the priority of 0 does not participate in the election. The default value is 1.

4.3.2 OSPF Route Management

Plan or optimize OSPF routes through manual configuration to implement management of OSPF routes.

Working Principle

📌 (Totally) Stub Area and (Totally)NSSA Area

The (totally) stub and (totally)NSSA areas help reduce the protocol interaction load and the size of the routing table.

- If an appropriate area is configured as a (totally) stub or NSSA area, advertisement of a large number of Type 5 and Type 3 LSAs can be avoided within the area.

Area	Type 1 and Type 2 LSAs	Type 3 LSA	Type 4 LSA	Type 5 LSA	Type 7 LSA
Non (totally) stub area and NSSA area	Allowed	Allowed	Allowed	Allowed	Not allowed
Stub area	Allowed	Allowed (containing one default route)	Not allowed	Not allowed	Not allowed
Totally stub area	Allowed	Only one default route is allowed.	Not allowed	Not allowed	Not allowed
NSSA area	Allowed	Allowed (containing one default route)	Allowed	Not allowed	Allowed
Totally NSSA area	Allowed	Only one default route is allowed.	Allowed	Not allowed	Allowed

- 📘 The ABR uses Type 3LSAs to advertise a default route to the (totally) stub or NSSA area.
- 📘 The ABR converts Type 7 LSAs in the totally NSSA area to Type 5LSAs, and advertise Type5LSAs to the backbone area.
- If an area is appropriately configured as a (totally) stub area or an NSSA area, a large number of E1, E2, and IA routes will not be added to the routing table of a router in the area.

Area	Routes Available in the Routing Table of a Router Inside the Area
Non (totally) stub area and NSSA area	O: a route to a destination network in the local area IA: a route to a destination network in another area E1 or E2: a route or default route to a destination network segment outside the AS (via any ASBR in the AS)
Stub area	O: a route to a destination network in the local area IA: a route or a default route to a destination network in another area
Totally stub area	O: a route to a destination network in the local area IA: a default route
NSSA area	O: a route to a destination network in the local area IA: a route or a default route to a destination network in another area N1 or N2: a route or default route to a destination network segment outside the AS (via any ASBR in the local area)
Totally NSSA area	O: a route to a destination network in the local area IA: a default route N1 or N2: a route or default route to a destination network segment outside the AS (via any ASBR in the local area)

↘ Route Redistribution

Route redistribution refers to the process of introducing routes of other routing protocols, routes of other OSPF processes, static routes, and direct routes that exist on the device to an OSPF process so that these routes can be advertised to neighbors using Type 5 and Type 7 LSAs. A default route cannot be introduced during route redistribution.

Route redistribution is often used for interworking between ASs. You can configure route redistribution on an ASBR to advertise routes outside an AS to the interior of the AS, or routes inside an AS to the exterior of the AS.

↘ Default Route Introduction

By configuring a command on an ASBR, you can introduce a default route to an OSPF process so that the route can be advertised to neighbors using Type 5 and Type 7 LSAs.

Default route introduction is often used for interworking between ASs. One default route is used to replace all the routes outside an AS.

↘ Route Summarization

Route summarization is a process of summarizing routing information with the same prefix into one route, and advertising the summarized route (replacing a large number of individual routes) to neighbors. Route summarization helps reduce the protocol interaction load and the size of the routing table.

By default, the ABR advertises inter-area routing information by using Type3 LSAs within a network segment, and advertises redistributed routing information by using Type 5 and Type 7 LSAs. If continuous network segments exist, it is recommended that you configure route summarization.

When configuring route summarization, the summarization range may exceed the actual network scope of routes. If data is sent to a network beyond the summarization range, a routing loop may be formed and the router processing load may increase. To prevent these problems, the ABR or ASBR automatically adds a discard route to the routing table. This route will not be advertised.

↘ Route Filtering

OSPF supports route filtering to ensure security and facilitate control when the routing information is being learned, exchanged, or used.

Using configuration commands, you can configure route filtering for the following items:

- Interface: The interface is prevented from sending routing information (any LSAs) or exchanging routing information (any LSAs) with neighbors.
- Routing information advertised between areas: Only the routing information that meets the filtering conditions can be advertised to another area (Type 3 LSAs).
- Routing information outside an AS: Only the routing information that meets the filtering conditions can be redistributed to the OSPF process (Type 5 and Type 7 LSAs).
- LSAs received by a router: In the OSPF routing table, only the routes that are computed based on the LSAs meeting the filtering conditions can be advertised.

➤ **Route Cost**

If redundancy links or devices exist on the network, multiple paths may exist from the local device to the destination network. OSPF selects the path with the minimum total cost to form an OSPF route. The total cost of a path is equal to the sum of the costs of individual links along the path. The total cost of a path can be minimized by modifying the costs of individual links along the path. In this way, OSPF selects this path to form a route.

Using configuration commands, you can modify the link costs:

- Cost from an interface to a directly connected network segment and cost from the interface to a neighbor
 - Cost from an ABR to the inter-area summarization network segment and cost from the ABR to the default network segment
 - Cost from an ASBR to an external network segment and cost from the ASBR to the default network segment
- Both the cost and the metric indicate the cost and are not differentiated from each other.

➤ **OSPF Administrative Distance**

The administrative distance (AD) evaluates reliability of a route, and the value is an integer ranging from 0 to 255. A smaller AD value indicates that the route is more trustworthy. If multiples exist to the same destination, the route preferentially selects a route with a smaller AD value. The route with a greater AD value becomes a floating route, that is, a standby route of the optimum route.

By default, the route coming from one source corresponds to an AD value. The AD value is a local concept. Modifying the AD value affects route selection only on the current router.

Route Source	Directly-Connected Network	Static Route	EBGP Route	OSPF Route	IS-IS Route	RIP Route	IBGP Route	Unreachable Route
Default AD	0	1	20	110	115	120	200	255



Related Configuration

➤ **Stub Area and NSSA Area**

No stub or NSSA area is configured by default.

Run the **area stub** command to configure a specified area as a stub area.

Run the **area nssa** command to configure a specified area as an NSSA area.

-  The backbone area cannot be configured as a stub or an NSSA area.
-  A transit area (with virtual links going through) cannot be configured as a stub or an NSSA area.
-  An area containing an ASBR cannot be configured as a stub area.

↘ **Route Redistribution and Default Route Introduction**

By default, routes are not redistributed and the default route is not introduced.

Run the **redistribute** command to configure route redistribution.

Run the **default-information originate** command to introduce the default route.

After configuring route redistribution and default route introduction, the route automatically becomes an ASBR.

↘ **Route Summarization**

By default, routes are not summarized. If route summarization is configured, a discard route will be automatically added.

Run the **aggregate** command to summarize routes distributed between areas (Type 3 LSA) on the ABR.

Run the **summary-address** command to summarize redistributed routes (Type 5 and Type 7 LSAs) on the ASBR.

Run the **discard-route** command to add a discard route to the routing table.

↘ **Route Filtering**

By default, routes are not filtered.

Run the **passive-interface** command to configure a passive interface. Routing information (any LSAs) cannot be exchanged on a passive interface.

Run the **ip ospfdatabase-filter all out** command to prohibit an interface from sending routing information (any LSAs).

Run the **area filter-list** command to filter routing information advertised between areas on the ABR. Only the routing information that meets the filtering conditions can be advertised to another area (Type 3 LSAs).

Use the **route-map** parameter in the **redistribute** command, or use the **distribute-list out** command to filter the external routing information of the AS on the ASBR. Only the routing information that meets the filtering conditions can be redistributed to the OSPF process (Type 5 and Type 7 LSAs).

Run the **distribute-list in** command to filter LSAs received by the router. In the OSPF routing table, only the routes that are computed based on the LSAs meeting the filtering conditions can be advertised.

↘ **Route Cost**

- Cost from the interface to the directly-connected network segment (cost on the interface)
The default value is the auto cost. $\text{Auto cost} = \text{Reference bandwidth} / \text{Interface bandwidth}$
Run the **auto-costreference-bandwidth** command to set the reference bandwidth of auto cost. The default value is 100 Mbps.
Run the **ip ospf cost** command to manually set the cost of the interface. The configuration priority of this item is higher than that of the auto cost.
- Cost from the interface to a specified neighbor (that is, cost from the local device to a specified neighbor)
The default value is the auto cost.
Use the **cost** parameter in the **neighbor** command to modify the cost from the interface to a specified neighbor. The configuration priority of this item is higher than that of the cost of the interface.
This configuration item is applicable only to P2MP-type interfaces.

- Cost from the ABR to the inter-area summarization network segment (that is, the cost of the summarized inter-area route)
If OSPF routing is compatible with RFC1583, the default value is the minimum cost among all costs of the summarized links; otherwise, the default value is the maximum cost among all costs of the summarized links.
Run the **compatible rfc1583** command to make OSPF routing compatible with RFC1583. By default, OSPF routing is compatible with RFC1583.
Use the **cost** parameter in the **area range** command to modify the cost of inter-area route summarization.
- Cost from the ABR to the default network segment (that is, the cost of the default route that is automatically advertised by the ABR to the stub or NSSA areas)
The default value is 1.
Run the **area default-cost** command to modify the cost of the default route that the ABR automatically advertise to the stub or NSSA areas.
- Cost from the ASBR to an external network segment (that is, the metric of an external route)
By default, the metric of a redistributed BGP route is 1, the metric of other types of redistributed routes is 20, and the route type is Type 2 External.
Run the **default-metric** command to modify the default metric of the external route.
Use the **metric,metric-type** and **route-map** parameters in the **redistribute** command to modify the metric and route type of the external route.
- Cost from the ASBR to the default network segment (that is, the metric of the default route that is manually introduced)
By default, the metric is 1, and the route type is Type 2 External.
Use the **metric,metric-type** and **route-map** parameters in the **default-information originate** command to modify the metric and route type of the default route that is manually introduced.
Use the **metric** and **metric-type** parameters of **default-information originate** in the **area nssa** command to modify the metric and type of the default route that is manually introduced to the NSSA area.
- Run the **max-metric router-lsa** command to set metrics of all routes advertised on the router to the maximum value. In this way, the total cost of any path that passes through this router will become very large, and the path can hardly become the shortest path.

📌 OSPF Administrative Distance

By default, the OSPF AD is 110.

Run the **distance** command to set the AD of an OSPF route.

4.3.3 Enhanced Security and Reliability

Use functions such as authentication and BFD correlation to enhance security, stability, and reliability of OSPF.

Working Principle

📌 Authentication

Authentication prevents routers that illegally access the network and hosts that forge OSPF packet from participating in the OSPF process. OSPF packets received on the OSPF interface (or at both ends of the virtual link) are authenticated. If authentication fails, the packets are discarded and the adjacency cannot be set up.

Enabling authentication can avoid learning unauthenticated or invalid routes, thus preventing advertising valid routes to unauthenticated devices. In the broadcast-type network, authentication also prevents unauthenticated devices from becoming designated devices, ensuring stability of the routing system and protecting the routing system against intrusions.

➤ **MTU Verification**

On receiving a DD packet, OSPF checks whether the MTU of the neighbor interface is the same as the MTU of the local interface. If the MTU of the interface specified in the received DD packet is greater than the MTU of the interface that receives the packet, the adjacency cannot be set up. Disabling MTU verification can avoid this problem.

➤ **Source Address Verification**

Generally, the source address of a packet received by OSPF is in the same network segment as the receiving interface. The addresses at both ends of a P2P link are configured separately and are not necessarily in the same network segment. In this scenario, as the peer address information will be notified during the P2P link negotiation process, OSPF checks whether the source address of the packet is the address advertised by the peer during negotiation. If not, OSPF determines that the packet is invalid and discards this packet. In particular, OSPF does not verify the address of an unnumbered interface.

In some scenarios, the source address of a packet received by OSPF may not be in the same network segment as the receiving interface, and therefore OSPF address verification fails. For example, the negotiated peer address cannot be obtained on a P2P link. In this scenario, source address verification must be disabled to ensure that the OSPF adjacency can be properly set up.

➤ **Two-Way Maintenance**

OSPF routers periodically send Hello packets to each other to maintain the adjacency. On a large network, a lot of packets may be sent or received, occupying too much CPU and memory. As a result, some packets are delayed or discarded. If the processing time of Hello packets exceeds the dead interval, the adjacency will be destroyed.

If the two-way maintenance function is enabled, in addition to the Hello packets, the DD, LSU, LSR, and LSAck packets can also be used to maintain the bidirectional communication between neighbors, which makes the adjacency more stable.

➤ **Concurrent Neighbor Interaction Restriction**

When a router simultaneously exchanges data with multiple neighbors, its performance may be affected. If the maximum number of neighbors that concurrently initiate or accept interaction with the OSPF process, the router can interact with neighbors by batches, which ensures data forwarding and other key services.

➤ **Overflow**

OSPF requires that routers in the same area store the same LSDB. The number of routers keeps increasing on the network. Some routers, however, cannot store so much routing information due to the limited system resources. The large amount of routing information may exhaust the system resources of routers, causing failures of the routers.

The overflow function limits the number of external routes in the LSDB to control the size of the LSDB.

When the number of external routes on a router exceeds the upper limit, the router enters the overflow state. The router deletes the external routes generated by itself from the LSDB, and does not generate new external routes. In addition, the router discards the newly received external routes. After the overflow state timer (5s) expires, if the number of external routes is lower than the upper limit, the normal state is restored.

➤ **GR**

The control and forwarding separated technology is widely used among routers. On a relatively stable network topology, when a GR-enabled router is restarted on the control plane, data forwarding can continue on the forwarding plane. In addition, actions (such as adjacency re-forming and route computation) performed on the control plane do not affect functions of the forwarding plane. In this way, service interruption caused by route flapping can be avoided, thus enhancing reliability of the entire network.

Currently, the GR function is used only during active/standby switchover and system upgrade.

Figure 4- 7Normal OSPF GR Process

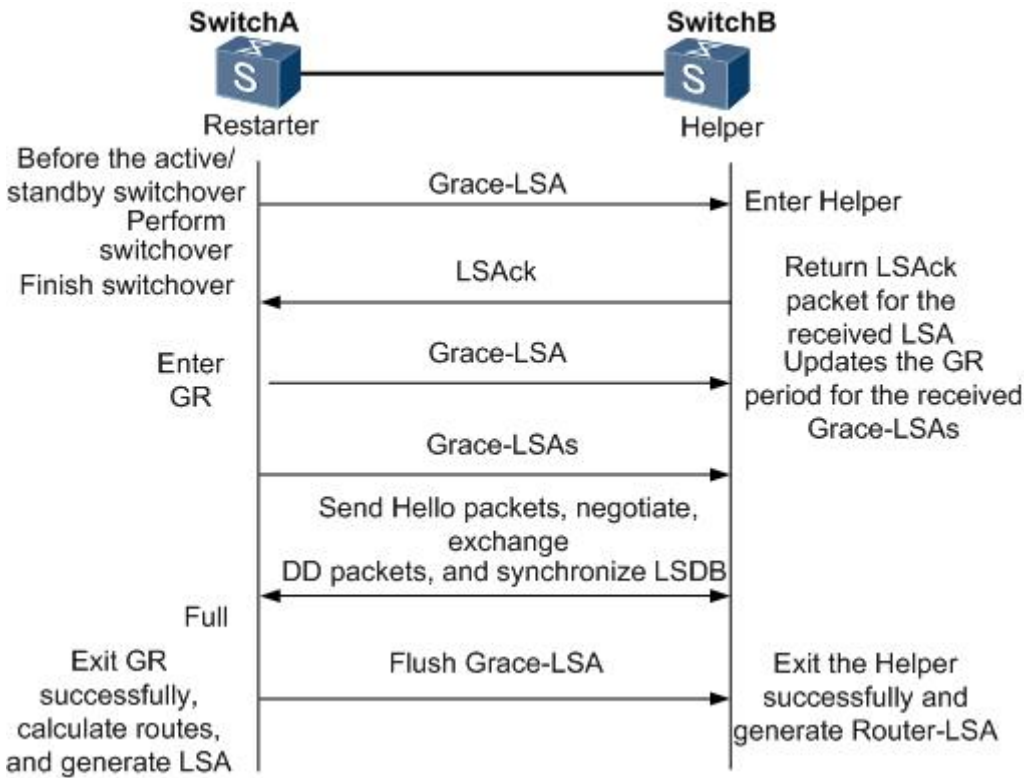

- The GR process requires collaboration between the restarter and the helper. The restarter is the router where GR occurs. The helper is a neighbor of the restarter.
- When entering or exiting the GR process, the restarter sends a Grace-LSA to the neighbor, notifying the neighbor to enter or exit the helper state.
- When the adjacency between the restarter and the helper reaches the Full state, the router can exit the GR process successfully.

➤ **NSR**

During nonstop routing (NSR), OSPF-related information is backed up from the active supervisor module of a distributed device to the standby supervisor module. In this way, the device can automatically recover the link state and re-generate routes without the help of the neighbor devices during the active/standby switchover. Information that should be backed up includes the adjacency and link state.

➤ **Fast Hello, BFD Correlation, and Fast Reroute**

After a link fault occurs, OSPF senses the death of the neighbor only after a period of time (about 40s). Then, OSPF advertises the information and re-computes the SPT. During this period, traffic is interrupted.

- After the fast Hello function is enabled (that is, the neighbor dead interval is set to 1s), OSPF can sense the death of a neighbor within 1s once a link is faulty. This greatly accelerates route convergence and prevents traffic interruption.
- BFD is used to test connectivity between devices. A link fault can be detected in as short as 150 ms. After OSPF is correlated with BFD, OSPF can sense the death of a neighbor in as short as 150 ms once a link is faulty. This greatly accelerates route convergence and prevents traffic interruption.

- Fast reroute prepares a standby route for OSPF. Once the OSPF senses the death of a neighbor, the traffic is immediately switched over to the standby route, thus preventing traffic interruption.

↘ iSPF

- The OSPF topology is area based. The SPF algorithm is run for independent computation in each area. The standard SPF algorithm re-computes the topology of the entire area each time even if only the leaf nodes change in the area topology.
- When computing the network topology, the incremental SPF (iSPF) corrects only the nodes on the SPT that are affected by the topological changes, and does not re-build the entire SPT. This can effectively ease the pressure on the router processors on a large network, especially when the network is not stable.

Related Configuration

↘ OSPF Packet Authentication

By default, authentication is disabled.

- Run the **area authentication** command to enable the authentication function in the entire area so that the function takes effect on all interfaces in this area. If authentication is enabled in area 0, the function takes effect on the virtual link.
- Run the **ip ospf authentication** command to enable authentication on an interface. This configuration takes precedence over the area-based configuration.
- Run the **ip ospf authentication-key** command to set the text authentication key on an interface.
- Run the **ip ospf message-digest-key** command to set the message digest 5 (MD5) authentication key on an interface.
- Use the **authentication** parameter in the **area virtual-link** command to enable authentication at both ends of a virtual link. This configuration takes precedence over the area-based configuration.
- Use the **authentication-key** parameter in the **area virtual-link** command to set the text authentication key at both ends of a virtual link.
- Use the **message-digest-key** parameter in the **area virtual-link** command to set the MD5 authentication key at both ends of a virtual link.

↘ MTU Verification

By default, MTU verification is disabled.

Run the **ip ospf mtu-ignore** command to disable MTU verification on an interface.

↘ Source address verification

By default, source address verification is enabled on a P2P interface.

Run the **ip ospf source-check-ignore** command to disable source address verification on an interface.

↘ Two-Way Maintenance

By default, bidirectional maintenance is enabled.

Run the **two-way-maintain** command to enable two-way maintenance.

↘ Concurrent neighbor Interaction Restriction

Run the **max-concurrent-dd** command to modify the maximum number of neighbors that are concurrently interacting with the current OSPF process. The default value is 5.

Run the **ipv6 router ospf max-concurrent-dd** command to modify the maximum number of neighbors that are concurrently interacting with all OSPF processes on the router. The default value is 10.

📌 Overflow

Run the **overflow memory-lack** command to allow the router to enter the overflow state when the memory is insufficient. By default, the router is allowed to enter the overflow state when the memory is insufficient.

Run the **overflow database** command to allow the router to enter the overflow state when the number of LSAs is too large. By default, the router is not allowed to enter the overflow state when the number of LSAs is too large.

Run the **overflow database external** command to allow the router to enter the overflow state when the number of external LSAs is too large. By default, the router is not allowed to enter the overflow state when the number of external-LSAs is too large.

📌 GR

By default, the restarter function is disabled, and the helper function is enabled.

Run the **graceful-restart** command to configure the restarter function.

Run the **graceful-restart helper** command to configure the helper function.

📌 NSR

By default, NSR is disabled.

Run the **nsr** command to enable NSR on the current OSPF process.

📌 Fast Hello

By default, the neighbor dead interval on the interface is 40s.

Run the **ip ospf dead-interval-minimal hello-multiplier** command to enable the Fast Hello function on an interface, that is, the neighbor dead interval is 1s.

📌 Correlating OSPF with BFD

By default, OSPF is not correlated with BFD.

Run the **bfd interval min_rx multiplier** command to set the BFD parameters.

Run the **bfd all-interfaces** command to correlate OSPF with BFD on all interfaces.

Run the **ip ospf bfd** command to correlate OSPF with BFD on the current interface.

📌 Fast Reroute

By default, fast reroute is disabled.

Run the **fast-reroute route-map** command to enable fast reroute on an OSPF process so that the standby route defined in the route map can be used.

Run the **fast-reroute lfa** command to enable fast reroute on an OSPF process so that the standby route can be computed by using the loop-free standby path.

Run the **fast-reroute lfdownstream-paths** command to enable fast reroute on an OSPF process so that the standby route can be computed by using the downstream path.

Run the **set fast-reroute backup-interface backup-next-hop** command to define a standby route in the route map.

Run the **ip ospf fast-reroute protection** command to specify the loop-free alternate (LFA) protection mode of an interface.

Run the **ip ospf fast-reroute no-eligible-backup** command to prevent an interface from becoming a standby interface.

↳ iSPF

By default, iSPF is disabled.

Run the **ispf enable** command to enable iSPF on the OSPF process.

4.3.4 Network Management

Use functions such as the MIB and Syslog to facilitate OSPF management.

Working Principle

↳ MIB

MIB is the device status information set maintained by a device. You can use the management program to view and set the MIB node.

Multiple OSPF processes can be simultaneously started on a router, but the OSPF MIB can be bound with only one OSPF process.

↳ Trap

A Trap message is a notification generated when the system detects a fault. This message contains the related fault information.

If the Trap function is enabled, the router can proactively send the Trap messages to the network management device.

↳ Syslog

The Syslog records the operations (such as command configuration) performed by users on routers and specific events (such as network connection failures).

If the Syslog is allowed to record the adjacency changes, the network administrator can view the logs to learn the entire process that the OSPF adjacency is set up and maintained.

Related Configuration

↳ MIB

By default, the MIB is bound with the OSPF process with the smallest process ID.

Run the **enable mib-binding** command to bind the MIB with the current OSPF process.

↳ Trap

By default, all traps are disabled, and the device is not allowed to send OSPF traps.

Run the **enable traps** command to enable a specified trap for an OSPF process.

Run the **snmp-server enable traps ospf** command to allow the device to send OSPF traps.





↳ SYSLOG









By default, the Syslog is allowed to record the adjacency changes.



Run the **log-adj-changes** command to allow the Syslog to record the adjacency changes.

4.4 Configuration

Configuration	Description and Command	
Configuring OSPF Basic Functions	(Mandatory) It is used to build an OSPF routing domain.	
	routerospf	Creates an OSPF process.
	router-id	Configures a router ID.
	network area	Enables OSPF on an interface and specifies an area ID.
	ip ospf area	Same configuration effects with the last command. Configuration on interface takes effect first.
	area virtual-link	Creates a virtual link.
Setting the Network Type	(Optional) The configurations are mandatory if the physical network is the X.25, frame relay, or ATM network.	
	ip ospf network	Defines the network type.
	neighbor	Specifies a neighbor.
	ip ospf priority	Configures the DR priority.
Configuring Route Redistribution and Default Route	(Optional) The configurations are recommended if the OSPF routing domain is connected with an external network.	
	redistribute	Configures route redistribution.
	router ospf redistribute	Route redistribution based on VRF.
	default-information originate	Introduces a default route.
Configuring Stub Area and NSSA Area	(Optional) It is used to reduce interaction of routing information and the size of routing table, and enhance stability of routes.	
	areastub	Configures a stub area.
	areanssa	Configures an NSSA area.
Configuring Route Summarization	(Optional) It is used to reduce interaction of routing information and the size of routing table, and enhance stability of routes.	
	area range	Summarizes routes that are advertised between areas.
	summary-address	Summarizes routes that are introduced through redistribution.
Configuring Route Filtering	(Optional) It is used to manually control interaction of routing information and filter available OSPF routes.	
	passive-interface	Configures a passive interface.
	ip ospf database-filter all out	Prohibits an interface from sending LSAs.
	area filter-list	Filters routes that are advertised between areas..
	distribute-list out	Filters routes that are introduced through

Configuration	Description and Command	
		redistribution.
	distribute-listin	Filters routes that are calculated based on the received LSAs.
Modifying Route Cost and AD	 (Optional) It is used to manually control the shortest route computed by OSPF and determine whether to select an OSPF route preferentially.	
	auto-costreference-bandwidth	Modifies the reference bandwidth of the auto cost.
	ip ospf cost	Modifies the cost in the outbound direction of an interface.
	areadefault-cost	Modifies the cost of the default route in a stub or an NSSA area.
	default-metric	Modifies the default metric of a redistributed route.
	max-metric router-lsa	Configures the maximum metric.
	compatible rfc1583	Enables the routing rules to be compatible with RFC1583.
Enabling Authentication	 (Optional) It is used to prevent routers that illegally access the network and hosts that forge OSPF packets from participating in the OSPF protocol process.	
	areaauthentication	Enables authentication and sets the authentication mode in an area.
	ip ospf authentication	Enables authentication and sets the authentication mode on an interface.
	ip ospf authentication-key	Sets the text authentication key on an interface.
	ip ospfmessage-digest-keymd5	Sets the MD5 authentication key on an interface.
Enabling Overflow	 (Optional) It is used to prevent the problem that OSPF processes stop running due to over-consumption of the memory.	
	overflow memory-lack	Allows the router to enter the overflow state when the memory is insufficient.
	overflow database	Allows the router to enter the overflow state when the number of LSAs exceeds the preset limit.
	overflow database external	Allows the router to enter the overflow state when the number of external LSAs exceeds the preset limit.
Modifying the Maximum Number of Concurrent Neighbors	 (Optional) It is used to prevent the problem of performance deterioration caused by over-consumption of the CPU.	
	max-concurrent-dd	Modifies the maximum number of con current neighbors on the current OSPF process.

Configuration	Description and Command	
	router ospf max-concurrent-dd	Modifies the maximum number of concurrent neighbors on all OSPF processes.
Disabling Source Address Verification	 (Optional) It is used to prevent the problem that the adjacency cannot be set up due to the failure to obtain the peer address.	
	ip ospf source-check-ignore	Disables source address verification on an interface.
Disabling MTU Verification	 (Optional) It is used to prevent the problem that the adjacency cannot be set up due to MTU inconsistency on the neighbor interface.	
	ip ospf mtu-ignore	Disables MTU verification on an interface.
Enabling Two-Way Maintenance	 (Optional) It is used to prevent termination of the adjacency due to the delay or loss of Hello packets.	
	two-way-maintain	Enables two-way maintenance.
Enabling GR	 (Optional) It is used to retain OSPF routing forwarding during restart or active/standby switchover of the OSPF processes to prevent traffic interruption.	
	graceful-restart	Configures the restarter function.
	graceful-restart helper	Configures the helper function.
Enabling NSR	 (Optional) It is used to retain OSPF routing forwarding during active/standby switchover of the OSPF processes to prevent traffic interruption.	
	nsr	Enables NSR.
Enabling Fast Hello	 (Optional) It is used to quickly discover the death of a neighbor to prevent traffic interruption when a link is faulty.	
	ip ospf dead-interval minimal hello-multiplier	Enabling Fast Hello.
Correlating OSPF with BFD	 (Optional) It is used to quickly discover the death of a neighbor to prevent traffic interruption when a link is faulty.	
	bfd interval min_rx multiplier	Sets BFD parameters.
	bfd all-interfaces	Correlates OSPF with BFD on all interfaces.
	ip ospf bfd	Correlates OSPF with BFD on the current interface.
Enabling Fast Reroute	 (Optional) It is used to quickly switch over services to the standby route to prevent traffic interruption.	
	fast-reroute route-map	Enables fast reroute on the OSPF process so that the standby route defined in the route map can be used.
	fast-reroute lfa	Enables fast reroute on an OSPF process so that the standby route can be computed by using the loop-free standby path.
	fast-reroute lfa downstream-paths	Enables fast reroute on an OSPF process so that the standby route can be computed by using

Configuration	Description and Command	
		the downstream path.
	set fast-reroute backup-interface backup-nexthop	Defines a standby route in the route map.
	ip ospf fast-reroute protection	Specifies the LFA protection mode of an interface.
	ip ospf fast-reroute no-eligible-backup	Prevents an interface from becoming a standby interface.
Enabling iSPF	 (Optional) It is used to enable the incremental topology computation to ease the pressure on the processor.	
	ispf enable	Enables iSPF on an OSPF process.
Configuring the Network Management Function	 (Optional) The configurations enable users to use the SNMP network management software to manage OSPF.	
	enable mib-binding	Binds the MIB with the current OSPF process.
	enable traps	Enables a specified trap for an OSPF process.
	snmp-server enable traps ospf	Allows the device to send OSPF traps.
	log-adj-changes	Allows the Syslog to record the adjacency changes.
Modifying Protocol Control Parameters	 (Optional) You are advised not to modify protocol control parameters unless necessary.	
	ip ospf hello-interval	Modifies the Hello interval.
	ip ospf dead-interval	Modifies the neighbor death interval.
	timers throttle lsa all	Modifies parameters of the exponential backoff algorithm that generates LSAs.
	timers throttle route inter-area	Modifies the inter-area route computation delay.
	timers throttle route ase	Modifies the external route computation delay.
	timers spacing lsa-group	Modifies the LSA group update interval.
	timers pacing lsa-transmit	Modifies the LS-UPD packet sending interval.
	ip ospf transmit-delay	Modifies the LSU packet transmission delay.
	ip ospf retransmit-interval	Modifies the LSU packet retransmission interval.
	timers lsa arrival	Modifies the delay after which the same LSA is received.
timers throttlespf	Modifies the SPT computation timer.	

4.4.1 Configuring OSPF Basic Functions

Configuration Effect

- Set up an OSPF routing domain on the network to provide IPv4 unicast routing service for users on the network.

Notes

- Ensure that the IP unicast routing function is enabled, that is, **ip routing** is not disabled; otherwise, OSPF cannot be enabled.
- It is strongly recommended that you manually configure the router ID.

- After **ip ospf disable all** is configured, the interface neither sends or receives any OSPF packet, nor participates in OSPF computation even if the interface belongs to the network.

Configuration Steps

↳ **Creating an OSPF Process**

- Mandatory.
- The configuration is mandatory for every router.

↳ **Configuring a Router ID**

- (Optional) It is strongly recommended that you manually configure the router ID.
- If the router ID is not configured, OSPF selects an interface IP address. If the IP address is not configured for any interface, or the configured IP addresses have been used by other OSPF instances, you must manually configure the router ID.

↳ **Adding Interface IP to OSPF and Specifying Area ID**

- Mandatory, unless OSPF is enabled by command on interface.
- The configuration is mandatory for every router.

↳ **Enabling OSPF on an Interface and Specifying an Area ID**

- Mandatory, unless the interface is added to OSPF on instance.
- The configuration is mandatory for every router.

Verification

- Run the **show ip route ospf** command to verify that the entries of the OSPF routing table are correctly loaded.
- Run the **ping** command to verify that the IPv4 unicast service is correctly configured.

Related Commands

↳ **Creating an OSPF Process**

Command	router ospf <i>process-id</i> [vrf <i>vrf-name</i>]
Parameter Description	<i>process-id</i> : Indicates the OSPF process ID. If the process ID is not specified, the process ID is 1. <i>vrf-name</i> : Specifies the VPN routing and forwarding (VRF) to which the OSPF process belongs.
Command Mode	Global configuration mode
Usage Guide	Different OSPF processes are independent of each other, and can be treated as different routing protocols that run independently.

↳ **Configuring a Router ID**

Command	router-id <i>router-id</i>
Parameter Description	<i>router-id</i> : Indicates the router ID to be configured. It is expressed in the IP address.
Command Mode	OSPF routing process configuration mode

Usage Guide	Different OSPF processes are independent of each other, and can be treated as different routing protocols that run independently. Each OSPF process uses a unique router ID.
--------------------	---

▾ Adding Interface IP to OSPF and Specifying Area ID

Command	network <i>ip-address wildcard area area-id</i>
Parameter	<i>ip-address</i> : Indicates the IP address of the interface.
Description	<i>wildcard</i> : Indicates the IP address comparison mode. 0 indicates accurate matching, and 1 indicates that no comparison is performed. <i>area-id</i> : Indicates the ID of an OSPF area. An OSPF area is always associated with an address range. To facilitate management, you can use a subnet as the ID of an OSPF area.
Command Mode	OSPF routing process configuration mode
Usage Guide	By defining <i>ip-address</i> and <i>wildcard</i> , you can use one command to associate multiple interfaces with one OSPF area. To run OSPF on one interface, you must include the primary IP address of the interface in the IP address range defined by network area . If the IP address range defined by network area contains only the secondary IP address of the interface, OSPF does not run on this interface. If the interface address matches the IP address ranges defined in the network commands of multiple OSPF processes, the OSPF process that the interface is associated with is determined based on the best match method. You can also add an interface to OSPF instance by the ip ospf area command on interface. If two commands are run at the same time, the configuration on interface takes effect first.

▾ Enabling OSPF on an Interface and Specifying an Area ID

Command	ip ospf <i>process-id area area-id</i>
Parameter	<i>process-id</i> : OSPF instance ID
Description	<i>area-id</i> : OSPF area ID
Command Mode	Interface configuration mode
Usage Guide	Running this command will add all IPs on the interface to OSPF instance. You can also add an interface to OSPF instance with network command on instance. If two commands are run at the same time, the configuration on interface takes effect first.

▾ Enabling OSPF on an Interface and Specifying an Area ID

Command	network <i>ip-address wildcard area area-id</i>
Parameter	<i>ip-address</i> : Indicates the IP address of the interface.
Description	<i>wildcard</i> : Indicates the IP address comparison mode. 0 indicates accurate matching, and 1 indicates that no comparison is performed. <i>area-id</i> : Indicates the ID of an OSPF area. An OSPF area is always associated with an address range. To facilitate management, you can use a subnet as the ID of an OSPF area.
Command Mode	OSPF routing process configuration mode
Usage Guide	By defining <i>ip-address</i> and <i>wildcard</i> , you can use one command to associate multiple interfaces with one OSPF area. To run OSPF on one interface, you must include the primary IP address of the interface in the IP address range defined by network area . If the IP address range defined by network area contains only the secondary IP address of the interface,

	OSPF does not run on this interface. If the interface address matches the IP address ranges defined in the network commands of multiple OSPF processes, the OSPF process that the interface is associated with is determined based on the best match method.
--	---

↳ Creating a Virtual Link

Command	area <i>area-id</i> virtual-link <i>router-id</i> [authentication [message-digest null]] [dead-interval { <i>seconds</i> minimal hello-multiplier <i>multiplier</i> }] [hello-interval <i>seconds</i>] [retransmit-interval <i>seconds</i>] [transmit-delay <i>seconds</i>] [[authentication-key [0 7] <i>key</i>] [message-digest-key <i>key-id</i> md5 [0 7] <i>key</i>]]
Parameter Description	<p>area-id: Indicates the ID of the OSPF transit area. The area ID can be a decimal integer or an IP address.</p> <p>router-id: Indicates the ID of a neighborrouter on the virtual link.</p> <p>dead-interval<i>seconds</i>: Indicates the time that the neighbor is declared lost. The unit is second. The value ranges from 0 to 2,147,483,647. The setting of this parameter must be consistent with that on a neighbor.</p> <p>minimal: Indicates that the Fast Hello function is enabled to set the dead interval to 1s.</p> <p>hello-multiplier: Indicates the result of the dead interval multiple by the Hello interval in the Fast Hello function.</p> <p>multiplier: Indicates the number of Hello packets sent per second in the Fast Hello function. The value ranges from 3 to 20.</p> <p>hello-interval <i>seconds</i>: Indicates the interval at which OSPF sends the Hello packet to the virtual link. The unit is second. The value ranges from 1 to 65,535. The setting of this parameter must be consistent with that on a neighbor.</p> <p>retransmit-interval <i>seconds</i>: Indicates the OSPF LSA retransmission time. The unit is second. The value ranges from 1 to 65,535.</p> <p>transmit-delay <i>seconds</i>: Indicates the delay after which OSPF sends the LSA. The unit is second. The value ranges from 1 to 65,535.</p> <p>authentication-key [0 7]<i>key</i>: Defines the key for OSPF plain text authentication.</p> <p>message-digest-key <i>key-id</i>md5 [0 7]<i>key</i>: Defines the key ID and key for OSPF MD5 authentication.</p> <p>authentication: Sets the authentication type to plain text authentication.</p> <p>message-digest: Sets the authentication type to MD5 authentication.</p> <p>null: Indicates that authentication is disabled.</p>
Command Mode	OSPF routing process configuration mode
Usage Guide	<p>In the OSPF routing domain, all areas must be connected to the backbone area. If the backbone area is disconnected, a virtual link must be configured to connect to the backbone area; otherwise, network communication problems will occur. A virtual link must be created between two ABRs, and the area to which both ABRs belong is the transit area. A stub area or an NSSA area cannot be used as a transit area. A virtual link can also be used to connect other non-backbone areas.</p> <p>router-id is the ID of an OSPF neighbor router. If you are sure about the value of router-id, run the show ip ospf neighbor command to confirm the value. You can configure the loopback address as the router ID.</p> <p>The area virtual-link command defines only the authentication key of the virtual link. To enable OSPF packet authentication in the areas connected to the virtual link, you must run the area authentication command.</p> <p>OSPF supports the Fast Hello function.</p> <p>After the OSPF Fast Hello function is enabled, OSPF finds neighbors and detects neighbor failures faster. You can enable the OSPF Fast Hello function by specifying the minimal and hello-multiplier keywords and the multiplier parameter. The minimal keyword indicates that the death interval is set to 1s, and hello-multiplier indicates the number of Hello packets sent per second. In this way, the interval at which the Hello packet is sent decreases to less than 1s.</p> <p>If the Fast Hello function is configured for a virtual link, the Hello interval field of the Hello packet advertised on the</p>

virtual link is set to 0, and the Hello interval field of the Hello packet received on this virtual link is ignored.

No matter whether the Fast Hello function is enabled, the death interval must be consistent and the **hello-multiplier** values can be inconsistent on routers at both ends of the virtual link. Ensure that at least one Hello packet can be received within the death interval.

Run the **show ip ospf virtual-links** command to monitor the death interval and Fast Hello interval configured for the virtual link.

The **dead-interval minimal hello-multiplier** and **hello-interval** parameters introduced for the Fast Hello function cannot be configured simultaneously.

Configuration Example

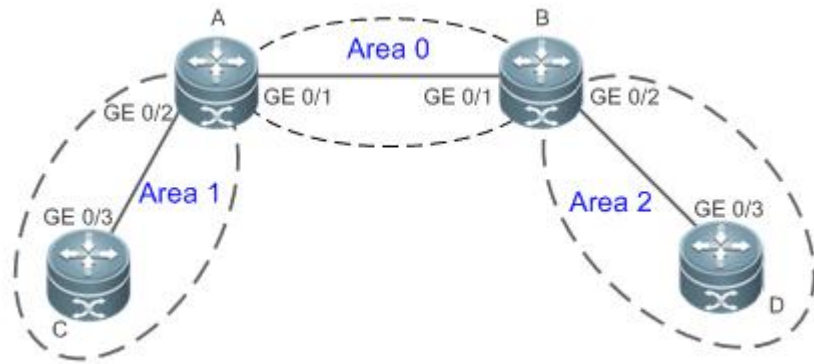
<p>Scenario Figure 4-8</p>	 <table border="1" data-bbox="329 1064 1411 1265"> <tr> <td>Remarks</td> <td>The interface IP addresses are as follows: A: GE 0/1 192.168.1.1 GE 0/2 192.168.2.1 B: GE 0/1 192.168.1.2 GE 0/2 192.168.3.1 C: GE 0/3 192.168.2.2 D: GE 0/3 192.168.3.2</td> </tr> </table>	Remarks	The interface IP addresses are as follows: A: GE 0/1 192.168.1.1 GE 0/2 192.168.2.1 B: GE 0/1 192.168.1.2 GE 0/2 192.168.3.1 C: GE 0/3 192.168.2.2 D: GE 0/3 192.168.3.2
Remarks	The interface IP addresses are as follows: A: GE 0/1 192.168.1.1 GE 0/2 192.168.2.1 B: GE 0/1 192.168.1.2 GE 0/2 192.168.3.1 C: GE 0/3 192.168.2.2 D: GE 0/3 192.168.3.2		
<p>Configuration Steps</p>	<ul style="list-style-type: none"> ● Configure the interface IP addresses on all routers. ● Enable the IPv4 unicast routing function on all routers. (This function is enabled by default.) ● Configure the OSPF instances and router IDs on all routers. ● Enable OSPF on the interfaces configured on all routers. 		
<p>A</p>	<pre> A#configure terminal A(config)#interface GigabitEthernet 0/1 A(config-if-GigabitEthernet 0/1)#ip address 192.168.1.1 255.255.255.0 A(config-if-GigabitEthernet 0/1)#exit A(config)#interface GigabitEthernet 0/2 A(config-if-GigabitEthernet 0/2)#ip address 192.168.2.1 255.255.255.0 A(config-if-GigabitEthernet 0/2)#exit A(config)#router ospf 1 A(config-router)#router-id 192.168.1.1 A(config-router)#network 192.168.1.0 0.0.0.255 area 0 </pre>		

	A(config-router)#network 192.168.2.0 0.0.0.255 area 1
B	<pre> B#configure terminal B(config)#interface GigabitEthernet 0/1 B(config-if-GigabitEthernet 0/1)#ip address 192.168.1.2 255.255.255.0 B(config-if-GigabitEthernet 0/1)#exit B(config)#interface GigabitEthernet 0/2 B(config-if-GigabitEthernet 0/2)#ip address 192.168.3.1 255.255.255.0 B(config-if-GigabitEthernet 0/2)#exit B(config)#router ospf 1 B(config-router)#router-id 192.168.1.2 B(config-router)#network 192.168.1.0 0.0.0.255 area 0 B(config-router)#network 192.168.3.0 0.0.0.255 area 2 </pre>
C	<pre> C#configure terminal C(config)#interface GigabitEthernet 0/3 C(config-if-GigabitEthernet 0/3)#ip address 192.168.2.2 255.255.255.0 C(config-if-GigabitEthernet 0/3)#exit C(config)#router ospf 1 C(config-router)#router-id 192.168.2.2 C(config-router)#network 192.168.2.0 0.0.0.255 area 1 </pre>
D	<pre> D#configure terminal D(config)#interface GigabitEthernet 0/3 D(config-if-GigabitEthernet 0/3)#ip address 192.168.3.2 255.255.255.0 D(config-if-GigabitEthernet 0/3)#exit D(config)#router ospf 1 D(config-router)#router-id 192.168.3.2 D(config-router)#network 192.168.3.0 0.0.0.255 area 2 </pre>
Verification	<ul style="list-style-type: none"> ● Verify that the OSPF neighbors are correct on all routers. ● Verify that the routing table is correctly loaded on all routers. ● On Router D, verify that the IP address 192.168.2.2 can be pinged successfully.
A	<pre> A# show ip ospf neighbor OSPF process 1, 2 Neighbors, 2 is Full: Neighbor ID Pri State Dead Time Address Interface 192.168.1.2 1 Full/DR 00:00:40 192.168.1.2 GigabitEthernet 0/1 </pre>

	<pre> 192.168.2.2 1 Full/BDR00:00:34 192.168.2.2 GigabitEthernet 0/2 A# show ip route ospf O IA 192.168.3.0/24 [110/2] via 192.168.1.2, 00:18:03, GigabitEthernet 0/1 </pre>
B	<pre> B# show ip ospf neighbor OSPF process 1, 2 Neighbors, 2 is Full: Neighbor ID Pri State Dead Time Address Interface 192.168.1.1 1 Full/BDR 00:00:32 192.168.1.1 GigabitEthernet 0/1 192.168.3.2 1 Full/BDR00:00:30 192.168.3.2 GigabitEthernet 0/2 B# show ip route ospf O IA 192.168.2.0/24 [110/2] via 192.168.1.2, 00:18:03, GigabitEthernet 0/1 </pre>
C	<pre> C# show ip ospf neighbor OSPF process 1,1 Neighbors,1 is Full: Neighbor ID Pri State Dead Time Address Interface 192.168.1.1 1 Full/BDR 00:00:32 192.168.2.1 GigabitEthernet 0/3 C# show ip route ospf O IA 192.168.1.0/24 [110/2] via 192.168.2.1, 00:19:05, GigabitEthernet 0/3 O IA 192.168.3.0/24 [110/3] via 192.168.2.1, 00:19:05, GigabitEthernet 0/3 </pre>
D	<pre> D# show ip ospf neighbor OSPF process 1,1 Neighbors,1 is Full: Neighbor ID Pri State Dead Time Address Interface 192.168.1.21 Full/BDR00:00:30 192.168.3.1 GigabitEthernet 0/3 D# show ip route ospf O IA 192.168.1.0/24 [110/2] via 192.168.3.1, 00:19:05, GigabitEthernet 0/3 O IA 192.168.2.0/24 [110/3] via 192.168.3.1, 00:19:05, GigabitEthernet 0/3 D# ping 192.168.2.2 Sending 5, 100-byte ICMP Echoes to 192.168.2.2, timeout is 2 seconds: < press Ctrl+C to break > !!!! </pre>

Success rate is 100 percent (5/5), round-trip min/avg/max = 1/1/1 ms.

Common Errors

- OSPF cannot be enabled because the IP unicast routing function is disabled.
- The network segment configured by the **network** command does not include the interface IP addresses.
- The area IDs enabled on adjacent interfaces are inconsistent.
- The same router ID is configured on multiple routers, resulting in a router ID conflict.
- The same interface IP address is configured on multiple routers, resulting in a running error of the OSPF network.

4.4.2 Setting the Network Type

Configuration Effect

- Run OSPF to provide the IPv4 unicast routing service if the physical network is X.25, frame relay, or ATM.

Notes

- The OSPF basic functions must be configured.
- The broadcast network sends OSPF packets in multicast mode. Neighbors are automatically discovered, and the DR/BDR election is required.
- The P2P network sends OSPF packets in multicast mode. Neighbors are automatically discovered.
- The NBMA network sends OSPF packets in unicast mode. Neighbors must be manually specified, and the DR/BDR election is required.
- The P2MP network (without the **non-broadcast** parameter) sends OSPF packets in multicast mode. Neighbors are automatically discovered.
- The P2MP network (with the **non-broadcast** parameter) sends OSPF packets in unicast mode. Neighbors must be manually specified.

Configuration Steps

⌵ Configuring the Interface Network Type

- Optional.
- The configuration is required on routers at both ends of the link.

⌵ Configuring Neighbors

- (Optional) If the interface network type is set to NBMA or P2MP (with the **non-broadcast** parameter), neighbors must be configured.
- Neighbors are configured on routers at both ends of the NBMA or P2MP (with the **non-broadcast** parameter) network.

⌵ Configuring the Interface Priority

- (Optional) You must configure the interface priority if a router must be specified as a DR, or a router cannot be specified as a DR.
- Configure the interface priority on a router that must be specified as a DR, or cannot be specified as a DR.

Verification

- Run the **show ip ospf interface** command to verify that the network type of each interface is correct.

Related Commands

▾ Configuring the Interface Network Type

Command	ip ospf network { broadcast non-broadcast point-to-multipoint[non-broadcast] point-to-point}
Parameter Description	<p>broadcast: Sets the interface network type to broadcast.</p> <p>non-broadcast: Sets the interface network type to non-broadcast.</p> <p>point-to-multipoint [non-broadcast]: Sets the interface network type to P2MP. If the interface does not have the broadcast capability, the non-broadcast parameter must be available.</p> <p>point-to-point: Sets the interface network type to P2P.</p>
Command Mode	Interface configuration mode
Usage Guide	<p>The broadcast type requires that the interface must have the broadcast capability.</p> <p>The P2P type requires that the interfaces are interconnected in one-to-one manner.</p> <p>The NBMA type requires full-meshed connections, and all interconnected routers can directly communicate with each other.</p> <p>The P2MP type does not raise any requirement.</p>

▾ Configuring Neighbors

Command	neighbor ip-address [poll-intervalseconds] [prioritypriority] [cost cost]
Parameter Description	<p>ip-address: Indicates the IP address of the neighbor interface.</p> <p>poll-intervalseconds: Indicates the neighbor polling interval. The unit is second. The value ranges from 0 to 2,147,483,647. This parameter is applicable only to the NBMA interface.</p> <p>prioritypriority: Indicates the neighbor priority. The value ranges from 0 to 255. This parameter is applicable only to the NBMA interface.</p> <p>costcost: Indicates the cost required to reach each neighbor. There is no default value. The value ranges from 0 to 65,535. This parameter is applicable only to the P2MP interface.</p>
Command Mode	OSPF routing process configuration mode
Usage Guide	<p>Neighbors must be specified for the NBMA or P2MP (non-broadcast) interfaces. The neighbor IP address must be the primary IP address of this neighbor interface.</p> <p>If a neighbor router becomes inactive on the NBMA network, OSPF still sends Hello packets to this neighbor even if no Hello packet is received within the router death time. The interval at which the Hello packet is sent is called polling interval. When running for the first time, OSPF sends Hello packets only to neighbors whose priorities are not 0. In this way, neighbors with priorities set to 0 do not participate in the DR/BDR election. After a DR/BDR is elected, the DR/BDR sends the Hello packets to all neighbors to set up the adjacency.</p> <p>The P2MP (non-broadcast) network cannot dynamically discover neighbors because it does not have the broadcast capability. Therefore, you must use this command to manually configure neighbors for the P2MP (non-broadcast) network. In addition, you can use the cost parameter to specify the cost to reach each neighbor on the P2MP network.</p>

▾ Configuring the Interface Priority

Command	ip ospf priority priority
----------------	----------------------------------

Parameter Description	<i>priority</i> : Indicates the OSPF priority of an interface. The value ranges from 0 to 255.
Command Mode	Interface configuration mode
Usage Guide	The OSPF interface priority is contained in the Hello packet. When the DR/BDR election occurs on the OSPF broadcast network, the router with the highest priority becomes the DR or BDR. If the priorities are the same, the router with the largest router ID becomes the DR or BDR. A router with the priority set to 0 does not participate in the DR/BDR election. This command is applicable only to the OSPF broadcast and NBMA interfaces.

Configuration Example

i The following configuration examples assume that the OSPF basic functions have been configured. For details about the OSPF basic functions, see section 4.4.1 "Configuring OSPF Basic Functions."

Setting the Interface Network Type to P2MP

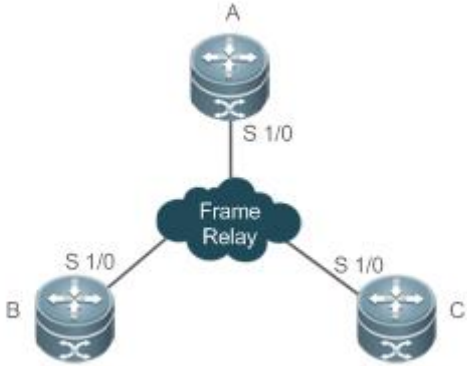
<p>Scenario Figure 4-9</p>	 <table border="1" data-bbox="330 1223 1417 1388"> <tr> <td>Remarks</td> <td>The interface IP addresses are as follows: A: S1/0 192.168.1.2 B: S1/0 192.168.1.3 C: S1/0 192.168.1.4</td> </tr> </table>	Remarks	The interface IP addresses are as follows: A: S1/0 192.168.1.2 B: S1/0 192.168.1.3 C: S1/0 192.168.1.4
Remarks	The interface IP addresses are as follows: A: S1/0 192.168.1.2 B: S1/0 192.168.1.3 C: S1/0 192.168.1.4		
<p>Configuration Steps</p>	<ul style="list-style-type: none"> Configure the interface IP addresses on all routers. (Omitted) Configure the OSPF basic functions on all routers. (Omitted) Set the interface network type to P2MP on all routers. 		
<p>A</p>	<pre>A#configure terminal A(config)# interface Serial1/0 A(config-Serial1/0)# encapsulation frame-relay A(config-Serial1/0)# ip ospf network point-to-multipoint</pre>		
<p>B</p>	<pre>B#configure terminal B(config)# interface Serial1/0 B(config-Serial1/0)# encapsulation frame-relay B(config-Serial1/0)# ip ospf network point-to-multipoint</pre>		

<p>C</p>	<pre>C#configure terminal C(config)# interface Serial1/0 C(config-Serial1/0)# encapsulation frame-relay C(config-Serial1/0)# ip ospf network point-to-multipoint</pre>
<p>Verification</p>	<p>Verify that the interface network type is P2MP.</p> <pre>A# show ip ospf interface Serial1/0 Serial1/0 is up, line protocol is up Internet Address 192.168.1.2/24, Iindex 2, Area 0.0.0.1, MTU 1500 Matching network config: 192.168.1.0/24 Process ID 1, Router ID 192.168.1.2, Network Type POINTOMULTIPOINT, Cost: 1 Transmit Delay is 1 sec, State Point-To-Point Timer intervals configured, Hello 10, Dead 40, Wait 40, Retransmit 5 Hello due in 00:00:02 Neighbor Count is 1, Adjacent neighbor count is 0 Crypt Sequence Number is 4787 Hello received 465 sent 466, DD received 8 sent 8 LS-Req received 2 sent 2, LS-Upd received 8 sent 21 LS-Ack received 14 sent 7, Discarded 3</pre>

Common Errors

- The network types configured on interfaces at two ends are inconsistent, causing abnormal route learning.
- The network type is set to NBMA or P2MP (with the **non-broadcast** parameter), but neighbors are not specified.

4.4.3 Configuring Route Redistribution and Default Route

Configuration Effect

- In the OSPF domain, introduce a unicast route to other AS domains so that the unicast routing service to other AS domains can be provided for users in the OSPF domain.
- In the OSPF domain, inject a default route to other AS domains so that the unicast routing service to other AS domains can be provided for users in the OSPF domain.

Notes

- The OSPF basic functions must be configured.

Configuration Steps

📌 Configuring External Route Redistribution

- (Optional) This configuration is required if external routes of the OSPF domain should be introduced to an ASBR.
- This configuration is performed on an ASBR.

📌 **Generating a Default Route**

- (Optional) This configuration is required if the default route should be introduced to an ASBR so that other routers in the OSPF domain access other AS domains through this ASBR by default.
- This configuration is performed on an ASBR.

Verification

- On a router inside the OSPF domain, run the **show ip route** command to verify that the unicast routes to other AS domains are loaded.
- On a router inside the OSPF domain, run the **show ip route** command to verify that the default route to the ASBR is loaded.
- Run the **ping** command to verify that the IPv4 unicast service to other AS domains is correct.

Related Commands

📌 **Configuring External Route Redistribution**

Command	redistribute { bgp connected isis [<i>area-tag</i>] ospf <i>process-id</i> rip arp-host static } [{ level-1 level-1-2 level-2 }] [match { internal external [1 2] nssa-external [1 2] }] [metric <i>metric-value</i>] [metric-type { 1 2 }] [route-map <i>route-map-name</i>] [subnets] [tag <i>tag-value</i>]
Parameter Description	<p>bgp: Indicates redistribution from BGP.</p> <p>connected: Indicates redistribution from direct routes.</p> <p>isis [<i>area-tag</i>]: Indicates redistribution from IS-IS. <i>area-tag</i> specifies the IS-IS instance.</p> <p>ospf process-id: Indicates redistribution from OSPF. <i>process-id</i> specifies an OSPF process. The value ranges from 1 to 65,535.</p> <p>rip: Indicates redistribution from RIP.</p> <p>static: Indicates redistribution from static routes.</p> <p>arp-host: Indicates redistribution from arp routes.</p> <p>level-1 level-1-2 level-2: Used only when IS-IS routes are redistributed. Only the routes of the specified level are redistributed. By default, only level-2 IS-IS routes can be redistributed.</p> <p>match: Used only when OSPF routes are redistributed. Only the routes meeting the filtering conditions are redistributed. By default, all OSPF routes can be redistributed.</p> <p>metric metric-value: Specifies the metric of the OSPF external LSA. <i>metric-value</i> specifies the size of the metric. The value ranges from 0 to 16,777,214.</p> <p>metric-type { 1 2 }: Sets the external route type, which can be E-1 or E-2.</p> <p>route-map route-map-name: Sets the redistribution filtering rules.</p> <p>subnets: Specifies the non-standard networks for redistribution.</p> <p>tag tag-value: Specifies the tag value of the route that is redistributed into the OSPF routing domain. The value ranges from 0 to 4,294,967,295.</p>
Command Mode	OSPF routing process configuration mode
Usage Guide	After this command is configured, the router becomes an ASBR, imports related routing information to the OSPF domain, and advertises the routing information as Type 5 LSAs to other OSPF routers in the domain.

	<p>If you configure redistribution of IS-IS routes without specifying the level parameter, only level-2 routes can be redistributed by default. If you specify the level parameter during initial configuration of redistribution, routes of the specified level can be redistributed. If both level-1 and level-2 are configured, the two levels are combined and saved as level-1-2. For details, see the configuration example.</p> <p>If you configure redistribution of OSPF routes without specifying the match parameter, OSPF routes of all sub-types can be distributed by default. The latest setting of the match parameter is used as the initial match parameter. Only routes that match the sub-types can be redistributed. You can use the no form of the command to restore the default value of match. For details, see the configuration example.</p> <p>If route-map is specified, the filtering rules specified in route-map are applicable to original parameters of redistribution. For redistribution of OSPF or IS-IS routes, the routemap is used for filtering only when the redistributed routes meet criteria specified by match or level.</p> <p>The set metric value associated with route-map should fall into the range of 0 to 16,777,214. If the value exceeds this range, routes cannot be introduced.</p> <p>The configuration rules for the no form of the redistribute command are as follows:</p> <ol style="list-style-type: none"> 1. If some parameters are specified in the no form of the command, default values of these parameters will be restored. 2. If no parameter is specified in the no form of the command, the entire command will be deleted. <p>For example, if redistribute isis 112 level-2 is configured, you can run the no redistribute isis 112 level-2 command to restore the default value of level-2.</p> <p>As level-2 itself is the default value of the parameter, the configuration saved is still redistribute isis 112 level-2 after the preceding no form of the command is executed. To delete the entire command, run the no redistribute isis 112 command.</p> <p>If VRF redistribution configuration (router ospf redistribute) and instance redistribution are configured at the same time, the later one takes effect first.</p>
--	---

↘ **Configuring Route Redistribution based on VRF**

Command	router ospf redistribute { bgp connected isis ospf rip arp-host static } [route-map <i>route-map-name</i>] [vrf <i>vrf-name</i>]
Parameter Description	<p>bgp: Indicates redistribution from BGP.</p> <p>connected: Indicates redistribution from direct routes.</p> <p>isis [<i>area-tag</i>]: Indicates redistribution from IS-IS. <i>area-tag</i> specifies the IS-IS instance.</p> <p>ospf <i>process-id</i>: Indicates redistribution from OSPF. <i>process-id</i> specifies an OSPF process.</p> <p>rip: Indicates redistribution from RIP.</p> <p>static: Indicates redistribution from static routes.</p> <p>arp-host: Redistribute from arp-host routes</p> <p>route-map <i>route-map-name</i>: Sets the redistribution filtering rules.</p> <p>vrf <i>vrf-name</i>: Redistribution VRF. Global VRF if not specified.</p>
Command Mode	Global configuration mode
Usage Guide	<p>After this command is configured, the router becomes an ASBR, imports related routing information to the OSPF domain, and advertises the routing information as Type 5 LSAs to other OSPF routers in the domain.</p> <p>If this command and redistribute on instance are configured at the same time, the later one takes effect.</p>

↘ **Introducing a Default Route**

Command	default-information originate [always] [metric <i>metric</i>] [metric-type <i>type</i>] [route-map <i>map-name</i>]
----------------	--

<p>Parameter</p> <p>Description</p>	<p>always: Enables OSPF to generate a default route regardless of whether the local router has a default route.</p> <p>metric <i>metric</i>: Indicates the initial metric of the default route. The value ranges from 0 to 16,777,214.</p> <p>metric-type <i>type</i>: Indicates the type of the default route. OSPF external routes are classified into two types: Type 1: The metric varies with routers; Type 2: The metric is the same for all routers. Type 1 external routes are more trustworthy than Type 2 external routes.</p> <p>route-map <i>map-name</i>: Indicates the associated route-map name. By default, no route-map is associated.</p>
<p>Command</p> <p>Mode</p>	<p>OSPF routing process configuration mode</p>
<p>Usage Guide</p>	<p>When the redistribute or default-information command is executed, the OSPF router automatically becomes an ASBR. The ASBR, however, does not automatically generate or advertise a default route to all routers in the OSPF routing domain. To have the ASBR generate a default route, configure the default-information originate command.</p> <p>If always is specified, the OSPF routing process advertises an external default route to neighbors regardless of whether a default route exists. This default route, however, is not displayed on the local router. To confirm whether the default route is generated, run the show ip ospf database command to display the OSPF link status database. The external link with the ID 0.0.0.0 describes the default route. On an OSPF neighbor, you can run the show ip route command to see the default route.</p> <p>The metric of the external default route can only be defined in the default-information originate command, instead of the default-metric command.</p> <p>OSPF has two types of external routes. The metric of the Type 1 external route changes, but the metric of the Type 2 external route is fixed. If two parallel paths to the same destination have the same route metric, the priority of the Type 1 route is higher than that of the Type 2 route. Therefore, the show ip route command displays only the Type 1 route.</p> <p>A router in the stub area cannot generate an external default route.</p> <p>The set metric value associated with route-map should fall into the range of 0 to 16,777,214. If the value exceeds this range, routes cannot be introduced.</p>

Configuration Example

 The following configuration examples assume that the OSPF basic functions have been configured. For details about the OSPF basic functions, see section 4.4.1 "Configuring OSPF Basic Functions."

 **Configuring Static Route Redistribution**

<p>Scenario Figure 4-10</p>	<p>Remarks</p> <p>The interface IP addresses are as follows:</p> <p>A: GE 0/1 192.168.1.1 GE 0/2 192.168.2.1 B: GE 0/1 192.168.1.2 GE 0/2 192.168.3.1 C: GE 0/2 192.168.2.2 D: GE 0/1 192.168.6.2 GE 0/2 192.168.3.2</p>
<p>Configuration Steps</p>	<ul style="list-style-type: none"> ● Configure the interface IP addresses on all routers. (Omitted) ● Configure the OSPF basic functions on all routers. (Omitted) ● Introduce an external static route to Router D.
<p>D</p>	<pre>D# configure terminal D(config)# ip route 172.10.10.0 255.255.255.0 192.168.6.3 D(config)#router ospf 1 D(config-router)# redistribute staticsubnets</pre>
<p>Verification</p>	<ul style="list-style-type: none"> ● On Router D, run the show ip ospf database external brief command to verify that an LSA corresponding to an external route is generated. ● On Router C, run the show ip route ospf command to verify that the external static route has been introduced.
<p>D</p>	<pre>D# show ip ospf database external brief OSPF Router with ID (192.168.22.30) (Process ID 1) AS External Link States Link ID ADV Router Age Seq# CkSum Route Tag ----- 172.10.10.0 192.168.22.30 11 0x80000001 0xa4bb E2 172.10.10.0/24 0</pre>
<p>C</p>	<pre>C# show ip route ospf O E2 172.10.10.0/24 [110/20] via 192.168.2.1, 00:18:03, GigabitEthernet 0/2</pre>

➤ **Configuring the Default Route**

<p>Scenario Figure 4-11</p>	<table border="1" data-bbox="337 560 1466 772"> <tr> <td>Remarks</td> <td> The interface IP addresses are as follows: A: GE 0/1 192.168.1.1 GE 0/2 192.168.2.1 B: GE 0/1 192.168.1.2 GE 0/2 192.168.3.1 C: GE 0/2 192.168.2.2 D: GE 0/2 192.168.3.2 </td> </tr> </table>	Remarks	The interface IP addresses are as follows: A: GE 0/1 192.168.1.1 GE 0/2 192.168.2.1 B: GE 0/1 192.168.1.2 GE 0/2 192.168.3.1 C: GE 0/2 192.168.2.2 D: GE 0/2 192.168.3.2
Remarks	The interface IP addresses are as follows: A: GE 0/1 192.168.1.1 GE 0/2 192.168.2.1 B: GE 0/1 192.168.1.2 GE 0/2 192.168.3.1 C: GE 0/2 192.168.2.2 D: GE 0/2 192.168.3.2		
<p>Configuration Steps</p>	<ul style="list-style-type: none"> ● Configure the interface IP addresses on all routers. (Omitted) ● Configure the OSPF basic functions on all routers. (Omitted) ● Configure the default route on Router D. 		
<p>D</p>	<pre>D# configure terminal D(config)#router ospf 1 D(config-router)#default-information originate always</pre>		
<p>Verification</p>	<ul style="list-style-type: none"> ● On Router D, run the show ip ospf database external brief command to verify that an LSA corresponding to the default route is generated. ● On Router C, run the show ip route ospf command to verify that the OSPF default route exists. 		
<p>D</p>	<pre>D#show ip ospf database external brief OSPF Router with ID (192.168.22.30) (Process ID 1) AS External Link States Link ID ADV Router Age Seq# CkSum Route Tag ----- 0.0.0.0 192.168.22.30 565 0x80000002 0xa190 E2 0.0.0.0/0 1</pre>		
<p>C</p>	<pre>C# show ip route ospf O E20.0.0.0/0 [110/20] via 192.168.2.1, 00:18:03, GigabitEthernet 0/2</pre>		

Common Errors

- The subnet route is not introduced because the **subnets** parameter in the **redistribute** command is not configured.
- A routing loop is formed because the **default-information originate always** command is configured on multiple routers.
- Routes cannot be introduced because route redistribution is configured on a router in the stub area.

4.4.4 Configuring Stub Area and NSSA Area

Configuration Effect

- Configure an area located on the stub as a stub area to reduce interaction of routing information and the size of routing table, and enhance stability of routes.

Notes

- The OSPF basic functions must be configured.
- A backbone or transit area cannot be configured as a stub or an NSSA area.
- A router in the stub area cannot introduce external routes, but a router in the NSSA area can introduce external routes.

Configuration Steps

↘ Configuring a Stub Area

- (Optional) This configuration is required if you wish to reduce the size of the routing table on routers in the area.
- The area must be configured as a stub area on all routers in this area.

↘ Configuring an NSSA Area

- (Optional) This configuration is required if you wish to reduce the size of the routing table on routers in the area and introduce OSPF external routes to the area.
- The area must be configured as an NSSA area on all routers in this area.

Verification

↘ Verifying the Stub Area

- On a router in the stub area, run the **show ip route** command to verify that the router is not loaded with any external routes.

↘ Verifying the NSSA Area

- On a router in the NSSA area, run the **show ip ospf database** command to verify that the introduced external route generates Type 7 LSAs.
- On a router in the backbone area, run the **show ip route** command to verify that the router is loaded with external routes introduced from the NSSA area.

Related Commands

↘ Configuring a Stub Area

Command	area area-id stub [no-summary]
Parameter	<i>area-id</i> : Indicates the ID of the stub area.
Description	no-summary : Prohibits the ABR from sending network summary LSAs. At this time, the stub can be called totally stub area. This parameter is configured only when the router is an ABR.
Command Mode	OSPF routing process configuration mode
Usage Guide	You must run the area stub command on all routers in the OSPF stub area. The ABR sends only three types of LSAs to the stub area: (1) Type 1: Router LSA; (2) Type 2: Network LSA; (3) Type 3: Network Summary LSA. From the routing table point

	<p>of view, a router in the stub area can learn only the internal routes of the OSPF routing domain, including the internal default route generated by an ABR. A router in the stub area cannot learn external routes of the OSPF routing domain. To configure a totally stub area, add the no-summary keyword when running the area stub command on the ABR. A router in the totally stub area can learn only the internal routes of the local area, including the internal default route generated by an ABR.</p> <p>You can run either the area stub or area default-cost command to configure an OSPF area as a stub area. If area stub is used, you must configure this command on all routers connected to the stub area. If area default-cost is used, run this command only on the ABR in the stub area. The area default-cost command defines the initial cost (metric) of the internal default route.</p>
--	--

➤ **Configuring an NSSA Area**

Command	area <i>area-id</i> nssa [no-redistribution] [default-information-originate [<i>metric</i> <i>value</i>] [metric-type <i>type</i>]] [no-summary] [translator [stability-interval <i>seconds</i> always]]
Parameter Description	<p><i>area-id</i>: Indicates the ID of the NSSA area.</p> <p>no-redistribution: Select this option if the router is an NSSA ABR and you want to use only the redistribute command to introduce the routing information into a common area instead of an NSSA area.</p> <p>default-information-originate: Indicates that a default Type 7 LSA is generated and introduced to the NSSA area. This option takes effect only on an NSSA ABR or ASBR.</p> <p>metric<i>value</i>: Specifies the metric of the generated default LSA. The value ranges from 0 to 16,777,214. The default value is 1.</p> <p>metric-type<i>type</i>: Specifies the route type of the generated default LSA. The values include 1 and 2. 1 represents N-1, and 2 represents N-2. The default value is 2.</p> <p>no-summary: Prohibits the ABR in the NSSA area from sending summary LSAs (Type-3 LSA).</p> <p>translator: Indicates that the NSSA ABR is a translator.</p> <p>stability-interval<i>seconds</i>: Indicates the stability interval after the NSSA ABR is changed from a translator to a non-translator. The unit is second. The default value is 40. The value ranges from 0 to 2,147,483,647.</p> <p>always: Indicates that the current NSSA ABR always acts as a translator. The default value is the standby translator.</p>
Command Mode	OSPF routing process configuration mode
Usage Guide	<p>The default-information-originate parameter is used to generate a default Type 7 LSA. This parameter has different functions on the ABR and the ASBR in the NSSA area. On the ABR, a Type 7 LSA default route is generated regardless of whether the default route exists in the routing table. On the ASBR (not an ABR), a Type 7 LSA default route is generated only when the default route exists in the routing table.</p> <p>If the no-redistribution parameter is configured on the ASBR, other external routes introduced by OSPF through the redistribute command cannot be advertised to the NSSA area. This parameter is generally used when a router in the NSSA area acts both as the ASBR and the ABR. It prevents external routing information from entering the NSSA area. To further reduce the number of LSAs sent to the NSSA area, you can configure the no-summary parameter on the ABR to prevent the ABR from sending the summary LSAs (Type 3 LSA) to the NSSA area.</p> <p>area default-cost is used on an ABR or ASBR connected to the NSSA area. This command configures the cost of the default route sent from the ABR/ASBR to the NSSA area. By default, the cost of the default route sent to the NSSA area is 1. If an NSSA area has two or more ABRs, the ABR with the largest router ID is elected by default as the translator for converting Type 7 LSAs into Type 5 LSAs. If the current device is always the translator ABR for converting Type 7 LSAs into Type 5 LSAs, use the translator always parameter.</p>

If the translator role of the current device is replaced by another ABR, the conversion capability is retained during the time specified by **stability-interval**. If the router does not become a translator again during **stability-interval**, LSAs that are converted from Type 7 to Type 5 will be deleted from the AS after **stability-interval** expires.

To prevent a routing loop, LSAs that are converted from Type 7 to Type 5 will be deleted from the AS immediately after the current device loses the translator role even if **stability-interval** does not expire.

In the same NSSA area, it is recommended that **translator always** be configured on only one ABR.

Configuration Example

i The following configuration examples assume that the OSPF basic functions have been configured. For details about the OSPF basic functions, see section 4.4.1 "Configuring OSPF Basic Functions."

Configuring a Stub Area

<p>Scenario Figure 4-12</p>	<table border="1" data-bbox="337 1064 1466 1265"> <tr> <td>Remarks</td> <td>The interface IP addresses are as follows: A: GE 0/1 192.168.1.1 GE 0/2 192.168.2.1 B: GE 0/1 192.168.1.2 GE 0/2 192.168.3.1 C: GE 0/2 192.168.2.2 D: GE 0/1 192.168.6.2 GE 0/2 192.168.3.2</td> </tr> </table>	Remarks	The interface IP addresses are as follows: A: GE 0/1 192.168.1.1 GE 0/2 192.168.2.1 B: GE 0/1 192.168.1.2 GE 0/2 192.168.3.1 C: GE 0/2 192.168.2.2 D: GE 0/1 192.168.6.2 GE 0/2 192.168.3.2
Remarks	The interface IP addresses are as follows: A: GE 0/1 192.168.1.1 GE 0/2 192.168.2.1 B: GE 0/1 192.168.1.2 GE 0/2 192.168.3.1 C: GE 0/2 192.168.2.2 D: GE 0/1 192.168.6.2 GE 0/2 192.168.3.2		
<p>Configuration Steps</p>	<ul style="list-style-type: none"> ● Configure the interface IP addresses on all routers. (Omitted) ● Configure the OSPF basic functions on all routers. (Omitted) ● Introduce an external static route to Router D. ● Configure area 1 as the stub area on Router A and Router C. 		
<p>D</p>	<pre>D# configure terminal D(config)#router ospf 1 D(config-router)# redistribute staticsubnets</pre>		
<p>A</p>	<pre>A# configure terminal A(config)#router ospf 1 A(config-router)#area 1 stubno-summary</pre>		
<p>C</p>	<pre>C# configure terminal C(config)#router ospf 1 C(config-router)#area 1 stub</pre>		

Verification	On Router C, run the show ip route ospf command to display the routing table. Verify that there is only one default inter-area route, and no external static route is introduced from Router D.
	<pre>C#show ip route ospf O*IA 0.0.0.0/0 [110/2] via 192.168.2.1, 00:30:53, GigabitEthernet 0/2</pre>

➤ **Configuring an NSSA Area**

Scenario Figure 4-13	
Remarks	<p>The interface IP addresses are as follows:</p> <p>A: GE 0/1 192.168.1.1 GE 0/2 192.168.2.1</p> <p>B: GE 0/1 192.168.1.2 GE 0/2 192.168.3.1</p> <p>C: GE 0/2 192.168.2.2</p> <p>D: GE 0/1 192.168.6.2 GE 0/2 192.168.3.2</p>
Configuration Steps	<ul style="list-style-type: none"> ● Configure the interface IP addresses on all routers. (Omitted) ● Configure the OSPF basic functions on all routers. (Omitted) ● Introduce an external static route to Router D. ● Configure area 2 as the NSSA area on Router B and Router D.
B	<pre>B# configure terminal B(config)#router ospf 1 B(config-router)#area 2 nssa</pre>
D	<pre>D# configure terminal D(config)#ip route 172.10.10.0 255.255.255.0 192.168.6.2 D(config)#router ospf 1 D(config-router)#redistribute static subnets D(config-router)#area 2 nssa</pre>
Verification	<ul style="list-style-type: none"> ● On Router D, verify that the Type 7 LSA, 172.10.10.0/24, is generated. ● On Router B, verify that Type 5 and Type 7 LSAs coexist on 172.10.10.0/24. ● On Router B, verify that the N-2 route of 172.10.10.0/24 is generated.

D	<pre> D# show ip ospf database nssa-external OSPF Router with ID (192.168.6.2) (Process ID 1) NSSA-external Link States (Area 0.0.0.1 [NSSA]) LS age: 61 Options: 0x8 (- - - N/P - -) LS Type: AS-NSSA-LSA Link State ID: 172.10.10.0 (External Network Number For NSSA) Advertising Router: 192.168.6.2 LS Seq Number: 80000001 Checksum: 0xc8f8 Length: 36 Network Mask: /24 Metric Type: 2 (Larger than any link state path) TOS: 0 Metric: 20 NSSA: Forward Address: 192.168.6.2 External Route Tag: 0 </pre>
B	<pre> B# show ip ospf database nssa-external OSPF Router with ID (192.168.3.1) (Process ID 1) NSSA-external Link States (Area 0.0.0.1 [NSSA]) LS age: 314 Options: 0x8 (- - - N/P - -) LS Type: AS-NSSA-LSA Link State ID: 172.10.10.0 (External Network Number For NSSA) Advertising Router: 192.168.6.2 LS Seq Number: 80000001 Checksum: 0xc8f8 Length: 36 Network Mask: /24 Metric Type: 2 (Larger than any link state path) TOS: 0 Metric: 20 NSSA: Forward Address: 192.168.6.2 </pre>

```

External Route Tag: 0
B# show ip ospf database external
      OSPF Router with ID (192.168.3.1) (Process ID 1)
          AS External Link States
LS age: 875
Options: 0x2 (-|-|-|-|E|-)
LS Type: AS-external-LSA
Link State ID: 172.10.10.0 (External Network Number)
Advertising Router: 192.168.3.1
LS Seq Number: 80000001
Checksum: 0xd0d3
Length: 36
Network Mask: /24
      Metric Type: 2 (Larger than any link state path)
      TOS: 0
      Metric: 20
      Forward Address: 192.168.6.2
      External Route Tag: 0

B# show ip route ospf
O N2 172.10.10.0/24 [110/20] via 192.168.3.2, 00:06:53, GigabitEthernet 0/2

```

Common Errors

- Configurations of the area type are inconsistent on routers in the same area.
- External routes cannot be introduced because route redistribution is configured on a router in the stub area.

4.4.5 Configuring Route Summarization

Configuration Effect

- Summarize routes to reduce interaction of routing information and the size of routing table, and enhance stability of routes.
- Shield or filter routes.

Notes

- The OSPF basic functions must be configured.
- The address range of summarized routes may exceed the actual network range in the routing table. If data is sent to a network beyond the summarization range, a routing loop may be formed and the router processing load may increase. To prevent these problems, a discard route must be added to the routing table or shield or filter routes.

Configuration Steps

➤ Configuring Inter-Area Route Summarization

- (Optional) This configuration is required when routes of the OSPF area need to be summarized.
- Unless otherwise required, this configuration should be performed on an ABR in the area where routes to be summarized are located.

➤ Configuring External Route Summarization

- (Optional) This configuration is required when routes external to the OSPF domain need to be summarized.
- Unless otherwise required, this configuration should be performed on an ASBR to which routes to be summarized are introduced.

Verification

Run the **show ip route ospf** command to verify that individual routes do not exist and only the summarized route exists.

Related Commands

➤ Configuring Inter-Area Route Summarization

Command	area <i>area-id</i> range <i>ip-address net-mask</i> [advertise not-advertise] [cost <i>cost</i>]
Parameter Description	<p><i>area-id</i>: Specifies the ID of the OSPF area to which the summarized route should be injected. The area ID can be a decimal integer or an IP address.</p> <p><i>ip-address net-mask</i>: Defines the network segment of the summarized route.</p> <p>advertise not-advertise: Specifies whether the summarized route should be advertised.</p> <p>cost <i>cost</i>: Indicates the metric of the summarized route. The value ranges from 0 to 16777215.</p>
Command Mode	OSPF routing process configuration mode
Usage Guide	<p>This command can be executed only on the ABR. It is used to combine or summarize multiple routes of an area into one route, and advertise the route to other areas. Combination of the routing information occurs only on the boundary of an area. Routers inside the area can learn specific routing information, whereas routers in other areas can learn only one summarized route. In addition, you can set advertise or not-advertise to determine whether to advertise the summarized route to shield and filter routes. By default, the summarized route is advertised. You can use the cost parameter to set the metric of the summarized route.</p> <p>You can configure route summarization commands for multiple areas. This simplifies routes in the entire OSPF routing domain, and improve the network forwarding performance, especially for a large-sized network.</p> <p>When multiple route summarization commands are configured and have the inclusive relationship with each other, the area range to be summarized is determined based on the maximum match principle.</p>

➤ Configuring External Route Summarization

Command	summary-address <i>ip-address net-mask</i> [not-advertise tag <i>value</i>]
Parameter Description	<p><i>ip-address</i>: Indicates the IP address of the summarized route.</p> <p><i>net-mask</i>: Indicates the subnet mask of the summarized route.</p> <p>not-advertise: Indicates that the summarized route is not advertised. If this parameter is not specified, the summarized route is advertised.</p> <p>tag <i>value</i>: Indicates the tag of the summarized route. The value ranges from 0 to 4,294,967,295.</p>

Command Mode	OSPF routing process configuration mode
Usage Guide	<p>When routes are redistributed from other routing processes and injected to the OSPF routing process, each route is advertised to the OSPF routers using an external LSA. If the injected routes are a continuous address space, the ABR can advertised only one summarized route to significantly reduce the size of the routing table.</p> <p>area range summarizes the routes between OSPF routes, whereas summary-address summarizes external routes of the OSPF routing domain.</p> <p>When configured on the NSSA ABR translator, summary-address summarizes redistributed routes and routes obtained based on the LSAs that are converted from Type 7 to Type 5. When configured on the ASBR (not an NSSA ABR translator), summary-address summarizes only redistributed routes.</p>

📌 **Configuring a Discard Route**

Command	discard-route { internal external }
Parameter Description	<p>internal: Indicates that the discard route generated by the area range command can be added.</p> <p>external: Indicates that the discard route generated by the summary-address command can be added.</p>
Command Mode	OSPF routing process configuration mode
Usage Guide	<p>The address range of summarized routes may exceed the actual network range in the routing table. If data is sent to a network beyond the summarization range, a routing loop may be formed and the router processing load may increase. To prevent these problems, a discard route must be added to the routing table on the ABR or ASBR. This route is automatically generated, and is not advertised.</p>

Configuration Example

i The following configuration examples assume that the OSPF basic functions have been configured. For details about the OSPF basic functions, see section 4.4.1 "Configuring OSPF Basic Functions."

<p>Scenario Figure 4-14</p>		
	Remarks	<p>The interface IP addresses are as follows:</p> <p>A: GE0/1 192.168.1.1</p> <p>B: GE0/1 192.168.1.2 GE0/2 172.16.2.1 GE0/3 172.16.3.1</p> <p>C: GE0/2 172.16.2.2 GE0/1 172.16.4.2</p> <p>D: GE0/2 172.16.3.2 GE0/1 172.16.5.2</p>
Configuration Steps	<ul style="list-style-type: none"> ● Configure the interface IP addresses on all routers. (Omitted) ● Configure the OSPF basic functions on all routers. (Omitted) ● Summarize routes of area 2 on Router B. 	

B	<pre>B# configure terminal B(config)#router ospf 1 B(config-router)#area 2 range 172.16.0.0 255.255.0.0</pre>
Verification	On Router A, verify that the entry 172.16.0.0/16 is added to the routing table.
A	<pre>A#show ip route ospf O IA 172.16.0.0/16 [110/2] via 192.168.1.2, 00:01:04, GigabitEthernet 0/1</pre>

Common Errors

- Inter-area route summarization cannot be implemented because the **area range** command is configured on a non-ABR device.

4.4.6 Configuring Route Filtering

Configuration Effect

- Routes that do not meet filtering conditions cannot be loaded to the routing table, or advertised to neighbors. Network users cannot access specified destination network.

Notes

- The OSPF basic functions must be configured.
- Filtering routes by using the **distribute-list in** command affects forwarding of local routes, but does not affect route computation based on LSAs. Therefore, if route filtering is configured on the ABR, Type 3 LSAs will still be generated and advertised to other areas because routes can still be computed based on LSAs. As a result, black-hole routes are generated. In this case, you can run the **area filter-list** or **area range** (containing the **not-advertise** parameter) command on the ABR to prevent generation of black-hole routes.

Configuration Steps

↘ Configuring Inter-Area Route Filtering

- (Optional) This configuration is recommended if users should be restricted from accessing the network in a certain OSPF area.
- Unless otherwise required, this configuration should be performed on an ABR in the area where filtered routes are located.

↘ Configuring Redistributed Route Filtering

- (Optional) This configuration is required if external routes introduced by the ASBR need to be filtered.
- Unless otherwise required, this configuration should be performed on an ASBR to which filtered routes are introduced.

↘ Configuring Learned Route Filtering

- (Optional) This configuration is required if users should be restricted from accessing a specified destination network.
- Unless otherwise required, this configuration should be performed on a router that requires route filtering.

Verification

- Run the **show ip route** command to verify that the router is not loaded with routes that have been filtered out.

- Run the **ping** command to verify that the specified destination network cannot be accessed.

Related Commands

↘ **Configuring a Passive Interface**

Command	passive-interface { default <i>interface-type interface-number</i> <i>interface-type interface-number ip-address</i> }
Parameter Description	<i>interface-type interface-number</i> : Indicates the interface that should be configured as a passive interface. default : Indicates that all interface will be configured as passive interfaces. <i>interface-type interface-number ip-address</i> : Specifies an address of the interface as the passive address.
Command Mode	OSPF routing process configuration mode
Usage Guide	To prevent other routers on the network from learning the routing information of the local router, you can configure a specified network interface of the local router as the passive interface, or a specified IP address of a network interface as the passive address.

↘ **Configuring the LSA Update Packet Filtering**

Command	ip ospf database-filter all out
Parameter Description	N/A
Command Mode	Interface configuration mode
Usage Guide	Enable this function on an interface to prevent sending the LSA update packet on this interface. After this function is enabled, the local router does not advertise the LSA update packet to neighbors, but still sets up the adjacency with neighbors and receives LSAs from neighbors.

↘ **Configuring Inter-Area Route Filtering**

Command	area <i>area-id</i> filter-list { access <i>acl-name</i> prefix <i>prefix-name</i> } { in out }
Parameter Description	<i>area-id</i> : Indicates the area ID. access <i>acl-name</i> : Indicates the associated ACL. prefix <i>prefix-name</i> : Indicates the associated prefix list. in out : Filters routes that are received by or sent from the area.
Command Mode	OSPF routing process configuration mode
Usage Guide	This command can be configured only on an ABR. Use this command when it is required to configure filtering conditions for inter-area routes on the ABR.

↘ **Configuring Redistributed Route Filtering**

Command	distribute-list { [<i>access-list-number</i> <i>name</i>] prefix <i>prefix-list-name</i> } out [bgp connected isis [<i>area-tag</i>] ospf <i>process-id</i> rip arp-host static]
Parameter Description	<i>access-list-number</i> <i>name</i> : Uses the ACL for filtering. prefix <i>prefix-list-name</i> : Uses the prefixlist for filtering. bgp connected isis [<i>area-tag</i>] ospf <i>process-id</i> rip arp-host static : Indicates the source of routes to be filtered.
Command Mode	OSPF routing process configuration mode

Usage Guide	distribute-list out is similar to redistribute route-map , and is used to filter routes that are redistributed from other protocols to OSPF. The distribute-list out command itself does not redistribute routes, and is generally used together with the redistribute command. The ACL and the prefixlist filtering rules are mutually exclusive in the configuration. That is, if the ACL is used for filtering routes coming from a certain source, the prefixlist cannot be configured to filter the same routes.
--------------------	---

📌 **Configuring Learned Route Filtering**

Command	distribute-list {[<i>access-list-number</i> <i>name</i>] prefix <i>prefix-list-name</i> [gateway <i>prefix-list-name</i>] route-map <i>route-map-name</i> } in [<i>interface-type</i> <i>interface-number</i>]
Parameter Description	<i>access-list-number</i> <i>name</i> : Uses the ACL for filtering. gateway <i>prefix-list-name</i> : Uses the gateway for filtering. prefix <i>prefix-list-name</i> : Uses the prefixlist for filtering. route-map <i>route-map-name</i> : Uses the route map for filtering. <i>interface-type</i> <i>interface-number</i> : Specifies the interface for which LSA routes are filtered.
Command Mode	OSPF routing process configuration mode
Usage Guide	Filter routes that are computed based on received LSAs. Only routes meeting the filtering conditions can be forwarded. The command does not affect the LSDB or the routing tables of neighbors. The ACL, prefix list, and route map filtering rules are mutually exclusive in the configuration. That is, if the ACL is used for filtering routes of a specified interface, the prefix list or router map cannot be configured for filtering routes of the same interface.

Configuration Example

i The following configuration examples assume that the OSPF basic functions have been configured. For details about the OSPF basic functions, see section 4.4.1 "Configuring OSPF Basic Functions."

<p>Scenario Figure 4-15</p>	<table border="1"> <tr> <td data-bbox="321 1630 503 1839">Remarks</td> <td data-bbox="503 1630 1489 1839"> The interface IP addresses are as follows: A: GE0/1 192.168.1.1 B: GE0/1 192.168.1.2 GE0/2 172.16.2.1 GE0/3 172.16.3.1 C: GE0/2 172.16.2.2 GE0/3 172.16.4.2 D: GE0/2 172.16.3.2 GE0/3 172.16.5.2 </td> </tr> </table>	Remarks	The interface IP addresses are as follows: A: GE0/1 192.168.1.1 B: GE0/1 192.168.1.2 GE0/2 172.16.2.1 GE0/3 172.16.3.1 C: GE0/2 172.16.2.2 GE0/3 172.16.4.2 D: GE0/2 172.16.3.2 GE0/3 172.16.5.2
Remarks	The interface IP addresses are as follows: A: GE0/1 192.168.1.1 B: GE0/1 192.168.1.2 GE0/2 172.16.2.1 GE0/3 172.16.3.1 C: GE0/2 172.16.2.2 GE0/3 172.16.4.2 D: GE0/2 172.16.3.2 GE0/3 172.16.5.2		
<p>Configuration Steps</p>	<ul style="list-style-type: none"> ● Configure the interface IP addresses on all routers. (Omitted) ● Configure the OSPF basic functions on all routers. (Omitted) ● On Router A, configure route filtering. 		
<p>A</p>	<pre>A# configure terminal</pre>		

	<pre>A(config)#access-list 3 permit host 172.16.5.0 A(config)#router ospf 1 A(config-router)#distribute-list 3 in GigabitEthernet 0/1</pre>
Verification	<ul style="list-style-type: none"> On Router A, check the routing table. Verify that only the entry 172.16.5.0/24 is loaded.
A	<pre>A# show ip route ospf O 172.16.5.0/24 [110/2] via 192.168.1.2, 10:39:40, GigabitEthernet 0/1</pre>

Common Errors

- Filtering routes by using the **distribute-list in** command affects forwarding of local routes, but does not affect route computation based on LSAs. Therefore, if route filtering is configured on the ABR, Type 3 LSAs will still be generated and advertised to other areas because routes can still be computed based on LSAs. As a result, black-hole routes are generated.

4.4.7 Modifying Route Cost and AD

Configuration Effect

- Change the OSPF routes to enable the traffic pass through specified nodes or avoid passing through specified nodes.
- Change the sequence that a router selects routes so as to change the priorities of OSPF routes.

Notes

- The OSPF basic functions must be configured.
- If you run the **ip ospf cost** command to configure the cost of an interface, the configured cost will automatically overwrite the cost that is computed based on the auto cost.

Configuration Steps

➤ **Configuring the Reference Bandwidth**

- Optional.
- A router is connected with lines with different bandwidths. This configuration is recommended if you wish to preferentially select the line with a larger bandwidth.

➤ **Configuring the Cost of an Interface**

- Optional.
- A router is connected with multiple lines. This configuration is recommended if you wish to manually specify a preferential line.

➤ **Configuring the Default Metric for Redistribution**

- Optional.
- This configuration is mandatory if the cost of external routes of the OSPF domain should be specified when external routes are introduced to an ASBR.

➤ **Configuring the Maximum Metric**

- Optional.
- A router may be unstable during the restart process or a period of time after the router is restarted, and users do not want to forward data through this router. In this case, this configuration is recommended.

↘ **Configuring the AD**

- Optional.
- This configuration is mandatory if you wish to change the priorities of OSPF routes on a router that runs multiple unicast routing protocols.

Verification

- Run the **show ip ospf interface** command to verify that the costs of interfaces are correct.
- Run the **show ip route** command to verify that the costs of external routes introduced to the ASBR are correct.
- Restart the router. Within a specified period of time, data is not forwarded through the restarted router.

Related Commands

↘ **Configuring the Reference Bandwidth**

Command	auto-costreference-bandwidth <i>ref-bw</i>
Parameter Description	<i>ref-bw</i> : Indicates the reference bandwidth. The unit is Mbps. The value ranges from 1 to 4,294,967.
Command Mode	OSPF routing process configuration mode
Usage Guide	<p>By default, the cost of an OSPF interface is equal to the reference value of the auto cost divided by the interface bandwidth.</p> <p>Run the auto-cost command to obtain the reference value of the auto cost. The default value is 100 Mbps.</p> <p>Run the bandwidth command to set the interface bandwidth.</p> <p>The costs of OSPF interfaces on several typical lines are as follows:</p> <p>64Kbps serial line: The cost is 1562.</p> <p>E1 line: The cost is 48.</p> <p>10M Ethernet: The cost is 10.</p> <p>100M Ethernet: The cost is 1.</p> <p>If you run the ip ospf cost command to configure the cost of an interface, the configured cost will automatically overwrite the cost that is computed based on the auto cost.</p>

↘ **Configuring the Cost of an Interface**

Command	ip ospf cost <i>cost</i>
Parameter Description	<i>cost</i> : Indicates the cost of an OSPF interface. The value ranges from 0 to 65,535.
Command Mode	Interface configuration mode
Usage Guide	<p>By default, the cost of an OSPF interface is equal to the reference value of the auto cost divided by the interface bandwidth.</p> <p>Run the auto-cost command to obtain the reference value of the auto cost. The default value is 100 Mbps.</p>

	<p>Run the bandwidth command to set the interface bandwidth.</p> <p>The costs of OSPF interfaces on several typical lines are as follows:</p> <p>64Kbps serial line: The cost is 1562.</p> <p>E1 line: The cost is 48.</p> <p>10M Ethernet: The cost is 10.</p> <p>100M Ethernet: The cost is 1.</p> <p>If you run the ip ospf cost command to configure the cost of an interface, the configured cost will automatically overwrite the cost that is computed based on the auto cost.</p>
--	---

↘ **Configuring the Cost of the Default Route in a Stub or an NSSA Area**

Command	area <i>area-id</i> default-cost <i>cost</i>
Parameter	<i>area-id</i> : Indicates the ID of the stub or NSSA area.
Description	<i>cost</i> : Indicates the cost of the default summarized route injected to the stub or NSSA area. The value ranges from 0 to 16,777,215.
Command Mode	OSPF routing process configuration mode
Usage Guide	<p>This command takes effect only on an ABR in a stub area or an ABR/ASBR in an NSSA area.</p> <p>An ABR in a stub area or an ABR/ASBR in an NSSA area is allowed to advertise an LSA indicating the default route in the stub or NSSA area. You can run the area default-cost command to modify the cost of the advertised LSA.</p>

↘ **Configuring the Default Metric for Redistribution**

Command	default-metric <i>metric</i>
Parameter Description	<i>metric</i> : Indicates the default metric of the OSPF redistributed route. The value ranges from 1 to 16,777,214.
Command Mode	OSPF routing process configuration mode
Usage Guide	<p>The default-metric command must be used together with the redistribute command to modify the initial metrics of all redistributed routes.</p> <p>The default-metric command does not take effect on external routes that are injected to the OSPF routing domain by the default-information originate command.</p>

↘ **Configuring the Maximum Metric**

Command	max-metric router-lsa [external-lsa [<i>max-metric-value</i>]] [include-stub] [on-startup [<i>seconds</i>]] [summary-lsa [<i>max-metric-value</i>]]
Parameter Description	<p>router-lsa: Sets the metrics of non-stub links in the Router LSA to the maximum value (0xFFFF).</p> <p>external-lsa: Allows a router to replace the metrics of external LSAs (including Type 5 and Type 7 LSAs) with the maximum metric.</p> <p><i>max-metric-value</i>: Indicates the maximum metric of the LSA. The default value is 16711680. The value ranges from 1 to 16,777,215.</p> <p>include-stub: Sets the metrics of stub links in the Router LSA advertised by the router to the maximum value.</p> <p>on-startup: Allows a router to advertise the maximum metric when started.</p> <p><i>seconds</i>: Indicates the interval at which the maximum metric is advertised. The default value is 600s. The value ranges from 5 to 86,400.</p> <p>summary-lsa: Allows a router to replace the metrics of summary LSAs (including Type 3 and Type 4 LSAs) with the</p>

	maximum metric.
Command	OSPF routing process configuration mode
Mode	
Usage Guide	<p>After the max-metric router-lsa command is executed, the metrics of the non-stub links in the Router LSAs generated by the router will be set to the maximum value (0xFFFF). If you cancel this configuration or the timer expires, the normal metrics of the links are restored.</p> <p>By default, if the max-metric router-lsa command is executed, the stub links still advertise common metrics, that is, the costs of outbound interfaces. If the include-stub parameter is configured, the stub links will advertise the maximum metric.</p> <p>If an ABR does not wish to transfer inter-area traffic, use the summary-lsa parameter to set the metric of the Summary LSA to the maximum metric.</p> <p>If an ASBR does not wish to transfer external traffic, use the external-lsa parameter to set the metric of the external LSA to the maximum metric.</p> <p>The max-metric router-lsa command is generally used in the following scenarios:</p> <p>Restart a device. After the device is restarted, IGP generally converges faster, and other devices attempt to forward traffic through the restarted device. If the current device is still building the BGP routing table and some BGP routes are not learned yet, packets sent these networks will be discarded. In this case, you can use the on-startup parameter to set a delay after which the restarted device acts as the transmission mode.</p> <ul style="list-style-type: none"> ● Add a device to the network but the device is not used to transfer traffic. The device is added to the network. If a candidate path exists, the current device is not used to transfer traffic. If a candidate path does not exist, the current device is still used to transfer traffic. ● Delete a device gracefully from the network. After the max-metric router-lsa command is executed, the current device advertises the maximum metric among all metrics of routes. In this way, other devices on the network can select the standby path for data transmission before the device is shut down. <p>In the earlier OSPF version (RFC1247 or earlier), the links with the maximum metric (0xFFFF) in the LSAs do not participate in the SPF computation, that is, no traffic is sent to routers that generate these LSAs.</p>

⌵ **Configuring RFC1583Compatibility**

Command	compatible rfc1583
Parameter	N/A
Description	
Command	OSPF routing process configuration mode
Mode	
Usage Guide	When there are multiple paths to an ASBR or the forwarding address of an external route, RFC1583 and RFC2328 define different routing rules. If RFC1583 compatibility is configured, a path in the backbone area or an inter-area path is preferentially selected. If RFC1583 compatibility is not configured, a path in a non-backbone area is preferentially selected.

⌵ **Configuring the AD**

Command	distance { <i>distance</i> [route-map <i>map-name</i>] ospf { intra-area <i>distance</i> [route-map <i>map-name</i>] inter-area <i>distance</i> [route-map <i>map-name</i>] external <i>distance</i> [route-map <i>map-name</i>] } }
Parameter	<i>distance</i> : Indicates the AD of a route. The value ranges from 1 to 255.
Description	intra-area <i>distance</i> : Indicates the AD of an intra-area route. The value ranges from 1 to 255. inter-area <i>distance</i> : Indicates the AD of an inter-area route. The value ranges from 1 to 255.

	<p>external distance: Indicates the AD of an external route. The value ranges from 1 to 255.</p> <p>route-map map-name: Indicates the AD of a specified route by policy.</p>
Command Mode	OSPF routing process configuration mode
Usage Guide	<p>Use this command to specify different ADs for different types of OSPF routes.</p> <p>Configure the route-map parameter to set the AD for a specified route by policy. If route-map has configured set distance,</p> <p>through matched route: AD is set by set distance</p> <p>through unmatched route: AD is set by the distance command</p>

Configuration Example

i The following configuration examples assume that the OSPF basic functions have been configured. For details about the OSPF basic functions, see section 4.4.1 "Configuring OSPF Basic Functions."

Configuring the Cost of an Interface

<p>Scenario Figure 4-16</p>	<table border="1" data-bbox="337 1232 1466 1400"> <tr> <td>Remarks</td> <td> The interface IP addresses are as follows: A: GE0/1 192.168.1.1 GE0/2 192.168.2.1 B: GE0/1 192.168.1.2 GE0/2 192.168.3.2 C: GE0/1 192.168.4.2 GE0/2 192.168.2.2 </td> </tr> </table>	Remarks	The interface IP addresses are as follows: A: GE0/1 192.168.1.1 GE0/2 192.168.2.1 B: GE0/1 192.168.1.2 GE0/2 192.168.3.2 C: GE0/1 192.168.4.2 GE0/2 192.168.2.2
Remarks	The interface IP addresses are as follows: A: GE0/1 192.168.1.1 GE0/2 192.168.2.1 B: GE0/1 192.168.1.2 GE0/2 192.168.3.2 C: GE0/1 192.168.4.2 GE0/2 192.168.2.2		
<p>Configuration Steps</p>	<ul style="list-style-type: none"> Configure the interface IP addresses on all routers. (Omitted) Configure the OSPF basic functions on all routers. (Omitted) On Router A, configure the cost of each interface. 		
<p>A</p>	<pre> A# configure terminal A(config)# interface GigabitEthernet 0/1 A(config-if-GigabitEthernet 0/1)# ip ospf cost 10 A(config)# interface GigabitEthernet 0/2 A(config-if-GigabitEthernet 0/2)# ip ospf cost 20 </pre>		
<p>Verification</p>	<p>On Router A, check the routing table. The next hop of the optimum path to 172.16.1.0/24 is Router B.</p>		
<p>A</p>	<pre> A# show ip route ospf O E2172.16.1.0/0 [110/20] via 192.168.1.2, 00:18:03, GigabitEthernet 0/1 </pre>		

Common Errors

- If the cost of an interface is set to 0 in the **ip ospf cost** command, a route computation error may occur. For example, a routing loop is obtained.

4.4.8 Enabling Authentication

Configuration Effect

- All routers connected to the OSPF network must be authenticated to ensure stability of OSPF and protect OSPF against intrusions.

Notes

- The OSPF basic functions must be configured.
- If authentication is configured for an area, the configuration takes effect on all interfaces that belong to this area.
- If authentication is configured for both an interface and the area to which the interface belongs, the configuration for the interface takes effect preferentially.

Configuration Steps

▾ Configuring the Authentication Type of an Area

- (Optional) This configuration is recommended if the same authentication type should be used on all interfaces in the same area.
- This configuration is required if a router accesses a network that requires authentication.

▾ Configuring the Authentication Type of an Interface

- (Optional) This configuration is recommended if the different authentication types should be used on different interfaces in the same area.
- This configuration is required if a router accesses a network that requires authentication.

▾ Configuring a Plain Text Authentication Key for an Interface

- Optional.
- This configuration is required if a router accesses a network that requires plain text authentication.

▾ Configuring an MD5 Authentication Key for an Interface

- (Optional) MD5 authentication features a high security, and therefore is recommended. You must configure either plain text authentication or MD5 authentication.
- This configuration is required if a router accesses a network that requires MD5 authentication.

Verification

- If routers are configured with different authentication keys, run the **show ip ospf neighbor** command to verify that there is no OSPF neighbor.
- If routers are configured with the same authentication key, run the **show ip ospf neighbor** command to verify that there are OSPF neighbors.

Related Commands

▾ Configuring the Authentication Type of an Area

Command	area <i>area-id</i> authentication [message-digest]
Parameter Description	<i>area-id</i> : Indicates the ID of the area where OSPF authentication is enabled. The area ID can be a decimal integer or an IP address. message-digest : Enables MD5 authentication.
Command Mode	OSPF routing process configuration mode
Usage Guide	The FSOS supports three authentication types: (1) Type 0: No authentication is required. If this command is not configured to enable OSPF authentication, the authentication type in the OSPF data packet is 0. (2) Type 1: The authentication type is plain text authentication if this command is configured but does not contain the message-digest parameter. (3) Type 3: The authentication type is MD5 authentication if this command is configured and contains the message-digest parameter. All routers in the same OSPF area must use the same authentication type. If authentication is enabled, the authentication key must be configured on interfaces that are connected to neighbors. You can run the interface configuration command ip ospf authentication-key to configure the plain text authentication key, or ip ospf message-digest-key to configure the MD5 authentication key.

▾ Configuring the Authentication Type of an Interface

Command	ip ospf authentication [message-digest null]
Parameter Description	message-digest : Indicates that MD5 authentication is enabled on the current interface. null : Indicates that authentication is disabled.
Command Mode	Interface configuration mode
Usage Guide	If the ip ospf authentication command does not contain any option, it indicates that plain text authentication is enabled. If you use the no form of the command to restore the default authentication mode, whether authentication is enabled is determined by the authentication type that is configured in the area to which the interface belongs. If the authentication type is set to null, authentication is disabled forcibly. When authentication is configured for both an interface and the area to which the interface belongs, the authentication type configured for the interface is used preferentially.

▾ Configuring a Plain Text Authentication Key for an Interface

Command	ip ospf authentication-key [0 7]key
Parameter Description	0 : Indicates that the key is displayed in plain text. 7 : Indicates that the key is displayed in cipher text. <i>key</i> : Indicates the key. The key is a string of up to eight characters.
Command Mode	Interface configuration mode
Usage Guide	The key configured by the ip ospf authentication-key command will be inserted to the headers of all OSPF packets. If the keys are inconsistent, two directly connected devices cannot set up the OSPF adjacency and therefore cannot exchange the routing information. Different keys can be configured for different interface, but all routers connected to the same physical network segment must be configured with the same key.

	<p>You can enable or disable authentication in an OSPF area by running the areaauthentication command in OSPF routing process configuration mode.</p> <p>You can also enable authentication on an individual interface by running the ip ospf authentication command in interface configuration mode. When authentication is configured for both an interface and the area to which the interface belongs, the authentication type configured for the interface is used preferentially.</p>
--	---

📌 **Configuring an MD5 Authentication Key for an Interface**

Command	ip ospf message-digest-key <i>key-id</i> md5 [0 7] <i>key</i>
Parameter	<i>key-id</i> : Indicates the key ID. The value ranges from 1 to 255.
Description	<p>0: Indicates that the key is displayed in plain text.</p> <p>7: Indicates that the key is displayed in cipher text.</p> <p><i>key</i>: Indicates the key. The key is a string of up to 16 characters.</p>
Command Mode	Interface configuration mode
Usage Guide	<p>The key configured by the ip ospf message-digest-key command will be inserted to the headers of all OSPF packets. If the keys are inconsistent, two directly connected devices cannot set up the OSPF adjacency and therefore cannot exchange the routing information.</p> <p>Different keys can be configured for different interface, but all routers connected to the same physical network segment must be configured with the same key. The same key ID on neighbor routers must correspond to the same key.</p> <p>You can enable or disable authentication in an OSPF area by running the area authentication command in OSPF routing process configuration mode. You can also enable authentication on an individual interface by running the ip ospf authentication command in interface configuration mode. When authentication is configured for both an interface and the area to which the interface belongs, the authentication type configured for the interface is used preferentially.</p> <p>The FSOS software supports smooth modification of the MD5 authentication key. A new MD5 authentication key must be first added before the old key can be deleted. When an OSPF MD5 authentication key is added to a router, the router determines that other routers do not use the new key yet and therefore uses different keys to send multiple OSPF packets until it confirms that the new key has been configured on neighbors. After configuring the new key all routers, you can delete the old key.</p>

Configuration Example

i The following configuration examples assume that the OSPF basic functions have been configured. For details about the OSPF basic functions, see section 4.4.1 "Configuring OSPF Basic Functions."

Scenario Figure 4-17	
Configuration Steps	<ul style="list-style-type: none"> ● Configure the interface IP addresses on all routers. (Omitted) ● Configure the OSPF basic functions on all routers. (Omitted) ● Configure the authentication type and MD5 authentication key on all routers.

<p>A</p>	<pre>A# configure terminal A(config)#router ospf 1 A(config-router)#area 0 authentication message-digest A(config-router)#exit A(config)#interface GigabitEthernet 0/1 A(config-if-GigabitEthernet 0/1)#ip ospf message-digest-key 1 md5 hello</pre>
<p>B</p>	<pre>B# configure terminal B(config)#router ospf 1 B(config-router)#area 0 authentication message-digest B(config-router)#exit B(config)#interface GigabitEthernet 0/3 B(config-if-GigabitEthernet 0/3)#ip ospf message-digest-key 1 md5 hello</pre>
<p>Verification</p>	<p>On Router A and Router B, verify that the OSPF neighbor status is correct.</p>
<p>A</p>	<pre>A#show ip ospf neighbor OSPF process 1, 1 Neighbors, 1 is Full: Neighbor ID Pri State Dead Time Address Interface 192.168.1.2 1 Full/DR 00:00:32 192.168.1.2 GigabitEthernet 0/1</pre>
<p>B</p>	<pre>A#show ip ospf neighbor OSPF process 1, 1 Neighbors, 1 is Full: Neighbor ID Pri State Dead Time Address Interface 192.168.1.1 1 Full/DR 00:00:32 192.168.1.1 GigabitEthernet 0/1</pre>

Common Errors

- The authentication modes configured on routers are inconsistent.
- The authentication keys configured on routers are inconsistent.

4.4.9 Enabling Overflow

Configuration Effect

- New routes are not loaded to routers when the router memory is insufficient.
- New routes are not loaded to routers when the usage of the database space reaches the upper limit.

Notes

- The OSPF basic functions must be configured.

- After a router enters the overflow state, you can run the **clear ip ospf process** command, or stop and then restart the OSPF to exit the overflow state.

Configuration Steps

▾ **Configuring the Memory Overflow Function**

- Optional.
- This configuration is recommended if a large number of routes exist in the domain and may cause insufficiency of the router memory.

▾ **Configuring the Database Overflow Function**

- Optional.
- This configuration is recommended if a large number of routes exist in the domain and may cause insufficiency of the router memory.

▾ **Configuring the External LSA Database Overflow Function**

- Optional.
- This configuration is recommended if the ASBR introduces a large number of external routes and the router memory may be insufficient.

Verification

- After the memory becomes insufficient, add new routers to the network, and run the **show ip route** command to verify that new routes are not loaded.
- After the usage of the database space reaches the upper limit, add new routers to the network, and run the **show ip route** command to verify that new routes are not loaded.

Related Commands

▾ **Configuring the Memory Overflow Function**

Command	overflow memory-lack
Parameter	N/A
Description	
Command Mode	OSPF routing process configuration mode
Usage Guide	<p>The OSPF process enters the overflow state to discard newly-learned external routes. This behavior can effectively ensure that the memory usage does not increase.</p> <p>After the overflow function is enabled, the OSPF process enters the overflow state and discards newly-learned external routes, which may cause a routing loop on the entire network. To reduce the occurrence probability of this problem, OSPF generates a default route to the null interface, and this route always exists in the overflow state.</p> <p>You can run the clear ip ospf process command to reset the OSPF process so that the OSPF process can exit the overflow state. You can use the no form of the command to prevent the OSPF process from entering the overflow state when the memory is insufficient. This, however, may lead to over-consumption of the memory resource, after which the OSPF process will stop and delete all the learned routes.</p>

➤ **Configuring the Database Overflow Function**

Command	overflow database <i>number</i> [hard soft]
Parameter	<i>number</i> : Indicates the maximum number of LSAs. The value ranges from 1 to 4,294,967,294.
Description	hard : Indicates that the OSPF process will be stopped if the number of LSAs exceeds the limit. soft : Indicates that a warning will be generated if the number of LSAs exceeds the limit.
Command Mode	OSPF routing process configuration mode
Usage Guide	If the number of LSAs exceeds the limit, use the hard parameter if the OSPF process should be stopped, and use the soft parameter if a warning should be generated without stopping the OSPF process.

➤ **Configuring the External LSA Database Overflow Function**

Command	overflow database external <i>max-dbsize wait-time</i>
Parameter	<i>max-dbsize</i> : Indicates the maximum number of external LSAs. This value must be the same on all routers in the same AS. The value ranges from 0 to 2,147,483,647.
Description	<i>wait-time</i> : Indicates the waiting time after a router in overflow state attempts to restore the normal state. The value ranges from 0 to 2,147,483,647.
Command Mode	OSPF routing process configuration mode
Usage Guide	When the number of external LSAs of a router exceeds the configured max-dbsize , the router enters the overflow state. In this state, the router no longer loads external LSAs and deletes external LSAs that are generated locally. After <i>wait-time</i> elapses, the device restores the normal state, and loads external LSAs again. When using the overflow function, ensure that the same max-dbsize is configured on all routers in the OSPF backbone area and common areas; otherwise, the following problems may occur: Inconsistent LSDBs throughout network are inconsistent, and the failure to achieve the full adjacency Incorrect routes, including routing loops Frequent retransmission of AS external LSAs

Configuration Example

i The following configuration examples assume that the OSPF basic functions have been configured. For details about the OSPF basic functions, see section 4.4.1 "Configuring OSPF Basic Functions."

➤ **Configuring the External LSA Database Overflow Function**

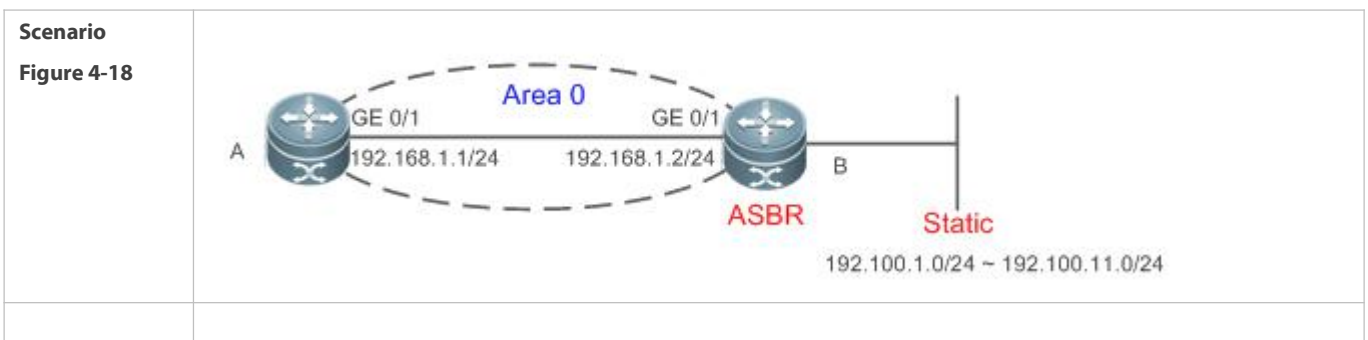

<p>Configuration Steps</p>	<ul style="list-style-type: none"> ● Configure the interface IP addresses on all routers. (Omitted) ● Configure the OSPF basic functions on all routers. (Omitted) ● On Router B, configure redistribution and introduce external static routes. ● On Router B, configure the maximum number of external LSAs.
<p>B</p>	<pre>B# configure terminal B(config)# router ospf 1 B(config-router)# redistribute static subnets</pre>
<p>A</p>	<pre>A# configure terminal A(config)# router ospf 1 A(config-router)# overflow database external 10 3</pre>
<p>Verification</p>	<p>On Router B, configure 11 static routes (192.100.1.0/24 to 192.100.11.0/24). On Router A, verify that only 10 static routes are loaded.</p>
<p>A</p>	<pre>A# show ip route ospf O E2 192.100.1.0/24 [110/20] via 192.168.1.2, 00:18:03, GigabitEthernet 0/1 O E2 192.100.2.0/24 [110/20] via 192.168.1.2, 00:18:03, GigabitEthernet 0/1 O E2 192.100.3.0/24 [110/20] via 192.168.1.2, 00:18:03, GigabitEthernet 0/1 O E2 192.100.4.0/24 [110/20] via 192.168.1.2, 00:18:03, GigabitEthernet 0/1 O E2 192.100.5.0/24 [110/20] via 192.168.1.2, 00:18:03, GigabitEthernet 0/1 O E2 192.100.6.0/24 [110/20] via 192.168.1.2, 00:18:03, GigabitEthernet 0/1 O E2 192.100.7.0/24 [110/20] via 192.168.1.2, 00:18:03, GigabitEthernet 0/1 O E2 192.100.8.0/24 [110/20] via 192.168.1.2, 00:18:03, GigabitEthernet 0/1 O E2 192.100.9.0/24 [110/20] via 192.168.1.2, 00:18:03, GigabitEthernet 0/1 O E2 192.100.10.0/24 [110/20] via 192.168.1.2, 00:18:03, GigabitEthernet 0/1</pre>

Common Errors

- The OSPF adjacency is abnormal because the maximum number of LSAs is inconsistent on different routers.

4.4.10 Modifying the Maximum Number of Concurrent Neighbors

Configuration Effect

- Control the maximum number of concurrent neighbors on the OSPF process to ease the pressure on the device.

Notes

- The OSPF basic functions must be configured.

Configuration Steps

➤ **Configuring the Maximum Number of Concurrent Neighbors on the OSPF Process**

- (Optional) This configuration is recommended if you wish to set up the OSPF adjacency more quickly when a router is connected with a lot of other routers.
- This configuration is performed on a core router.

Verification

- Run the **show ip ospf neighbor** command to display the number of neighbors that are concurrently interacting with the OSPF process.

Related Commands

➤ **Configuring the Maximum Number of Concurrent Neighbors on the Current Process**

Command	max-concurrent-dd <i>number</i>
Parameter Description	<i>number</i> : Specifies the maximum number of neighbors that are concurrently interacting with the OSPF process. The value ranges from 1 to 65,535.
Command Mode	OSPF routing process configuration mode
Usage Guide	When the performance of a router is affected because the router exchanges data with multiple neighbors, you can configure this command to restrict the maximum of neighbors with which one OSPF process can concurrently initiate or accept interaction.

➤ **Configuring the Maximum Number of Concurrent Neighbors on All Processes**

Command	router ospf max-concurrent-dd <i>number</i>
Parameter Description	<i>number</i> : Specifies the maximum number of neighbors that are concurrently interacting with the OSPF process. The value ranges from 1 to 65,535.
Command Mode	Global configuration mode
Usage Guide	When the performance of a router is affected because the router exchanges data with multiple neighbors, you can configure this command to restrict the maximum of neighbors with which all OSPF processes can concurrently initiate or accept interaction.

Configuration Example

- **i** The following configuration examples assume that the OSPF basic functions have been configured. For details about the OSPF basic functions, see section 4.4.1 "Configuring OSPF Basic Functions."

➤ **Configuring the Maximum Number of Concurrent Neighbors on the OSPF Process**

<p>Scenario Figure 4-19</p>	
<p>Configuration Steps</p>	<ul style="list-style-type: none"> ● Configure the interface IP addresses on all routers. (Omitted) ● Configure the OSPF basic functions on all routers. (Omitted) ● On the router Core, set the maximum number of concurrent neighbors to 4.
<p>Core</p>	<pre>Core# configure terminal Core(config)# router ospf max-concurrent-dd 4</pre>
<p>Verification</p>	<p>On the router Core, check the neighbor status and verify that at most eight neighbors concurrently interact with the OSPF process.</p>

4.4.11 Disabling Source Address Verification

Configuration Effect

- The unicast routing service can be provided even if the interface IP addresses of neighbor routers are not in the same network segment.

Notes

- The OSPF basic functions must be configured.
- Source address verification cannot be disabled on a broadcast or NBMA network.

Configuration Steps

📌 Disabling Source Address Verification

- (Optional) This configuration is mandatory if an adjacency should be set up between routers with interface IP addresses in different network segments.
- This configuration is performed on routers with interface IP addresses in different network segments.

Verification

- An adjacency can be set up between routers in different network segments.

Related Commands

➤ **Disabling Source Address Verification**

Command	ip ospf source-check-ignore
Parameter Description	N/A
Command Mode	Interface configuration mode
Usage Guide	Generally, the source address of a packet received by OSPF is in the same network segment as the receiving interface. The addresses at both ends of a P2P link are configured separately and are not necessarily in the same network segment. In this scenario, as the peer address information will be notified during the P2P link negotiation process, OSPF checks whether the source address of the packet is the address advertised by the peer during negotiation. If not, OSPF determines that the packet is invalid and discards this packet. In particular, OSPF does not verify the address of an unnumbered interface. In some scenarios, the source address may not meet the preceding requirement, and therefore OSPF address verification fails. For example, the negotiated peer address cannot be obtained on a P2P link. In this scenario, source address verification must be disabled to ensure that the OSPF adjacency can be properly set up.

Configuration Example

i The following configuration examples assume that the OSPF basic functions have been configured. For details about the OSPF basic functions, see section 4.4.1 "Configuring OSPF Basic Functions."

➤ **Disabling Source Address Verification**

Scenario Figure 4-20	
Configuration Steps	<ul style="list-style-type: none"> ● Configure the interface IP addresses on all routers. (Omitted) ● Configure the OSPF basic functions on all routers. (Omitted) ● Set the network types of interfaces on all routers to P2P. ● Disable source address verification on all routers.
A	<pre>A# configure terminal A(config)# interface GigabitEthernet 0/1 A(config-if-GigabitEthernet 0/1)# ip ospf network point-to-point A(config-if-GigabitEthernet 0/1)# ip ospf source-check-ignore</pre>
B	<pre>B# configure terminal B(config)# interface GigabitEthernet 0/1 B(config-if-GigabitEthernet 0/1)# ip ospf network point-to-point B(config-if-GigabitEthernet 0/1)# ip ospf source-check-ignore</pre>
Verification	On Router A, verify that the OSPF neighbor information is correct.

<p>Scenario Figure 4-20</p>	
<p>Configuration Steps</p>	<ul style="list-style-type: none"> ● Configure the interface IP addresses on all routers. (Omitted) ● Configure the OSPF basic functions on all routers. (Omitted) ● Set the network types of interfaces on all routers to P2P. ● Disable source address verification on all routers.
<p>A</p>	<pre>A# configure terminal A(config)# interface GigabitEthernet 0/1 A(config-if-GigabitEthernet 0/1)# ip ospf network point-to-point A(config-if-GigabitEthernet 0/1)# ip ospf source-check-ignore</pre>
<p>B</p>	<pre>B# configure terminal B(config)# interface GigabitEthernet 0/1 B(config-if-GigabitEthernet 0/1)# ip ospf network point-to-point B(config-if-GigabitEthernet 0/1)# ip ospf source-check-ignore</pre>
<p>Verification</p>	<p>On Router A, verify that the OSPF neighbor information is correct.</p>
<p>A</p>	<pre>A# show ip ospfneighbor OSPF process 1, 1 Neighbors, 1 is Full: Neighbor ID Pri State Dead Time Address Interface 192.100.2.2 1 Full/- 00:00:34 192.100.2.2 GigabitEthernet 0/1</pre>

4.4.12 Disabling MTU Verification

Configuration Effect

- The unicast routing service can be provided even if the MTUs of interfaces on neighbor routers are different.

Notes

- The OSPF basic functions must be configured.

Configuration Steps

Disabling MTU Verification

- (Optional) MTU verification is disabled by default. You are advised to retain the default configuration.
- This configuration is performed on two routers with different interface MTUs.

Verification

The adjacency can be set up between routers with different MTUs.

Related Commands

Disabling MTU Verification

Command	ip ospf mtu-ignore
Parameter Description	N/A
Command Mode	Interface configuration mode
Usage Guide	On receiving the database description packet, OSPF checks whether the MTU of the interface on the neighbor is the same as the MTU of its own interface. If the interface MTU specified in the received database description packet is greater than the MTU of the local interface, the adjacency cannot be set up. To resolve this problem, you can disable MTU verification.

Configuration Example

i The following configuration examples assume that the OSPF basic functions have been configured. For details about the OSPF basic functions, see section 4.4.1 "Configuring OSPF Basic Functions."

Scenario Figure 4-21	
Configuration Steps	<ul style="list-style-type: none"> ● Configure the interface IP addresses on all routers. (Omitted) ● Configure the OSPF basic functions on all routers. (Omitted) ● Configure different MTUs for interfaces on two routers. ● Disable MTU verification on all routers. (By default, the function of disabling MTU verification is enabled.)
A	<pre>A# configure terminal A(config)# interface GigabitEthernet 0/1 A(config-if-GigabitEthernet 0/1)# ip mtu 1400 A(config-if-GigabitEthernet 0/1)# ip ospf mtu-ignore</pre>
B	<pre>B# configure terminal B(config)# interface GigabitEthernet 0/1 A(config-if-GigabitEthernet 0/1)# ip mtu 1600 B(config-if-GigabitEthernet 0/1)# ip ospf mtu-ignore</pre>
Verification	<ul style="list-style-type: none"> ● On Router A, verify that the OSPF neighbor information is correct.
A	<pre>A# show ip ospfneighbor OSPF process 1, 1 Neighbors, 1 is Full: Neighbor ID Pri State Dead Time Address Interface 192.168.1.2 1 Full/DR 00:00:34 192.168.1.2 GigabitEthernet 0/1</pre>

4.4.13 Enabling Two-Way Maintenance

Configuration Effect

- Non-Hello packets can also be used to maintain the adjacency.

Notes

- The OSPF basic functions must be configured.

Configuration Steps

▾ Enabling Two-Way Maintenance

- (Optional) This function is enabled by default. You are advised to retain the default configuration.
- This configuration is performed on all routers.

Verification

Non-Hello packets can also be used to maintain the adjacency.

Related Commands

▾ Enabling Two-Way Maintenance

Command	two-way-maintain
Parameter	N/A
Description	
Command Mode	OSPF routing process configuration mode
Usage Guide	On a large network, a lot of packets may be sent or received, occupying too much CPU and memory. As a result, some packets are delayed or discarded. If the processing time of Hello packets exceeds the dead interval, the adjacency will be destroyed due to timeout. If the two-way maintenance function is enabled, in addition to the Hello packets, the DD, LSU, LSR, and LSAck packets can also be used to maintain the bidirectional communication between neighbors when a large number of packets exist on the network. This prevents termination of the adjacency caused by delayed or discarded Hello packets.

Configuration Example

- i** The following configuration examples assume that the OSPF basic functions have been configured. For details about the OSPF basic functions, see section 4.4.1 "Configuring OSPF Basic Functions."

Scenario Figure 4-22	
Configuration Steps	<ul style="list-style-type: none"> ● Configure the interface IP addresses on all routers. (Omitted) ● Configure the OSPF basic functions on all routers. (Omitted) ● On Router A, enable the two-way maintenance function. (This function is enabled by default.)

A	<pre>A# configure terminal A(config)#routerospf 1 A(config-router)#two-way-maintain</pre>
Verification	When the adjacency is being set up, Router A checks the neighbor dead interval and updates the dead interval without waiting for Router B to send a Hello packet.
A	<pre>A# show ip ospfneighbor OSPF process 1, 1 Neighbors, 1 is Full: Neighbor ID Pri State Dead Time Address Interface 192.168.1.2 1 Full/BDR 00:00:40 192.168.1.2 GigabitEthernet 0/1</pre>

4.4.14 Enabling GR

Configuration Effect

- When a distributed router switches services from the active board to the standby board, data forwarding continues and is not interrupted.
- When the OSPF process is being restarted, data forwarding continues and is not interrupted.

Notes

- The OSPF basic functions must be configured.
- The neighbor router must support the GR helper function.
- The grace period cannot be shorter than the neighbor dead time of the neighbor router.

Configuration Steps

▾ Configuring the OSPF GR Function

- (Optional) This function is enabled by default. You are advised to retain the default configuration.
- This configuration is performed on all routers.

▾ Configuring the OSPF GR Helper Function

- (Optional) This function is enabled by default. You are advised to retain the default configuration.
- This configuration is performed on all routers.

Verification

- When a distributed router switches services from the active board to the standby board, data forwarding continues and is not interrupted.
- When the OSPF process is being restarted, data forwarding continues and is not interrupted.

Related Commands

▾ Configuring the OSPF GR Function

Command	graceful-restart [grace-period <i>grace-period</i> inconsistent-lsa-checking]
Parameter Description	<p>grace-period <i>grace-period</i>: Indicates the grace period, which is the maximum time from occurrence of an OSPF failure to completion of the OSPF GR. The value of the graceperiod varies from 1s to 1800s. The default value is 120s.</p> <p>inconsistent-lsa-checking: Enables topological change detection. If any topological change is detected, OSPF exits the GR process to complete convergence. After GR is enabled, topological change detection is enabled by default.</p>
Command Mode	OSPF routing process configuration mode
Usage Guide	<p>The GR function is configured based on the OSPF process. You can configure different parameters for different OSPF processes based on the actual conditions. This command is used to configure the GR restarter capability of a device. The grace period is the maximum time of the entire GR process, during which link status is rebuilt so that the original state of the OSPF process is restored. After the grace period expires, OSPF exits the GR state and performs common OSPF operations.</p> <p>Run the graceful-restart command to set the grace period to 120s. The graceful-restart grace-period command allows you to modify the grace period explicitly.</p> <p>The precondition for successful execution of GR and uninterrupted forwarding is that the topology remains stable. If the topology changes, OSPF quickly converges without waiting for further execution of GR, thus avoiding long-time forwarding black-hole.</p> <p>Disabling topology detection: If OSPF cannot converge in time when the topology changes during the hot standby process, forwarding black-hole may appear in a long time.</p> <p>Enabling topology detection: Forwarding may be interrupted when topology detection is enabled, but the interruption time is far shorter than that when topology detection is disabled.</p> <p>In most cases, it is recommended that topology detection be enabled. In special scenarios, topology detection can be disabled if the topology changes after the hot standby process, but it can be ensured that the forwarding black-hole will not appear in a long time. This can minimize the forwarding interruption time during the hot standby process.</p> <p>If the Fast Hello function is enabled, the GR function cannot be enabled.</p>

📌 **Configuring the OSPF GR Helper Function**

Command	graceful-restart helper { disable strict-lsa-checking internal-lsa-checking }
Parameter Description	<p>disable: Prohibits a device from acting as a GR helper for another device.</p> <p>strict-lsa-checking: Indicates that changes in Type 1 to Type 5 and Type 7 LSAs will be checked during the period that the device acts as a GR helper to determine whether the network changes. If the network changes, the device will stop acting as the GR helper.</p> <p>internal-lsa-checking: Indicates that changes in Type 1 to Type 3 LSAs will be checked during the period that the device acts as a GR helper to determine whether the network changes. If the network changes, the device will stop acting as the GR helper.</p>
Command Mode	OSPF routing process configuration mode
Usage Guide	<p>This command is used to configure the GR helper capability of a router. When a neighbor router implements GR, it sends a Grace-LSA to notify all neighbor routers. If the GR helper function is enabled on the local router, the local router becomes the GR helper on receiving the Grace-LSA, and helps the neighbor to complete GR. The disable option indicates that GR helper is not provided for any device that implements GR.</p> <p>After a device becomes the GR helper, the network changes are not detected by default. If any change takes place on the network, the network topology converges after GR is completed. If you wish that network changes can be quickly detected during the GR process, you can configure strict-lsa-checking to check Type 1 to 5 and Type 7 LSAs that indicate</p>

the network information or **internal-lsa-checking** to check Type 1 to 3 LSAs that indicate internal routes of the AS domain. When the network scale is large, it is recommended that you disable the LSA checking options (**strict-lsa-checking** and **internal-lsa-checking**) because regional network changes may trigger termination of GR and consequently reduce the convergence of the entire network.

Configuration Example

i The following configuration examples assume that the OSPF basic functions have been configured. For details about the OSPF basic functions, see section 4.4.1 "Configuring OSPF Basic Functions."

<p>Scenario Figure 4-23</p>	<table border="1" data-bbox="337 1041 1466 1249"> <tr> <td>Remarks</td> <td>The interface IP addresses are as follows: A: GE 0/1 192.168.1.1 B: GE 0/1 192.168.1.1 GE 0/2 192.168.2.1 GE 0/3 192.168.3.1 C: GE 0/1 192.168.4.2 GE 0/3 192.168.3.2 D: GE 0/1 192.168.5.2 GE 0/2 192.168.2.2</td> </tr> </table>	Remarks	The interface IP addresses are as follows: A: GE 0/1 192.168.1.1 B: GE 0/1 192.168.1.1 GE 0/2 192.168.2.1 GE 0/3 192.168.3.1 C: GE 0/1 192.168.4.2 GE 0/3 192.168.3.2 D: GE 0/1 192.168.5.2 GE 0/2 192.168.2.2
Remarks	The interface IP addresses are as follows: A: GE 0/1 192.168.1.1 B: GE 0/1 192.168.1.1 GE 0/2 192.168.2.1 GE 0/3 192.168.3.1 C: GE 0/1 192.168.4.2 GE 0/3 192.168.3.2 D: GE 0/1 192.168.5.2 GE 0/2 192.168.2.2		
<p>Configuration Steps</p>	<ul style="list-style-type: none"> ● Configure the interface IP addresses on all routers. (Omitted) ● Configure the OSPF basic functions on all routers. (Omitted) ● On Router A, Router C, and Router D, enable the GR helper function. (This function is enabled by default.) ● On Router B, enable the GR function. 		
<p>B</p>	<pre>B# configure terminal B(config)# router ospf1 B(config-router)# graceful-restart</pre>		
<p>Verification</p>	<ul style="list-style-type: none"> ● Trigger a hot standby switchover on Router B, and verify that the routing tables of destination networks 1 and 2 remain unchanged on Router A during the switchover. ● Trigger a hot standby switchover on Router B, ping destination network 1 from Router A, and verify that data forwarding is not interrupted during the switchover. 		

Common Errors

- Traffic forwarding is interrupted during the GR process because the configured grace period is shorter than the neighbor dead time of the neighbor router.

4.4.15 Enabling NSR

Configuration Effect

- During the active/standby switchover of a distributed router, data forwarding continues and is not interrupted.

Notes

- The OSPF basic functions must be configured.

Configuration Steps

↳ Enabling the OSPF NSR Function

- (Optional) This function is disabled by default and enabled only when the function needs to be used.

Verification

- During the active/standby switchover of a distributed router, data forwarding continues and is not interrupted.

Related Commands

↳ Enabling NSR

Command	nsr
Parameter	N/A
Description	
Command Mode	OSPF routing process configuration mode
Usage Guide	<p>This command is used to enable the NSR function. Enable either NSR or GR for the same OSPF process. That is, when GR is enabled, NSR is automatically disabled. When NSR is enabled, GR is automatically disabled, but the GR helper capability is not affected.</p> <p>The switchover of a distributed router takes some time. If the OSPF neighbor dead time is shorter than the switchover time, the OSPF adjacency will be destroyed, causing service interruption during the switchover. Therefore, when enabling the NSR function, you are advised to configure an OSPF neighbor dead time that is equal to or greater than the default value. When the Fast Hello function is enabled, the OSPF neighbor dead time is shorter than 1s, and therefore it is recommended that the NSR function be disabled.</p>

Configuration Example

- i** The following configuration examples assume that the OSPF basic functions have been configured. For details about the OSPF basic functions, see section 4.4.1 "Configuring OSPF Basic Functions."

<p>Scenario Figure 4-24</p>	
<p>Configuration Steps</p>	<p>Remarks</p> <p>The interface IP addresses are as follows:</p> <p>A: GE 0/1 192.168.1.1</p> <p>B: GE 0/1 192.168.1.2 GE 0/2 192.168.2.1 GE 0/3 192.168.3.1</p> <p>C: GE 0/1 192.168.4.2 GE 0/3 192.168.3.2</p> <p>D: GE 0/1 192.168.5.2 GE 0/2 192.168.2.2</p>
<p>B</p>	<pre>B# configure terminal B(config)# router ospf1 B(config-router)# nsr</pre>
<p>Verification</p>	<ul style="list-style-type: none"> ● Trigger a hot standby switchover on Router B, and verify that the routing tables of destination networks 1 and 2 remain unchanged on Router A during the switchover. ● Trigger a hot standby switchover on Router B, ping destination network 1 from Router A, and verify that data forwarding is not interrupted during the switchover.

Common Errors

- The configured OSPF neighbor dead interval is too short. If the Fast Hello function is enabled, the OSPF adjacency will be destroyed during the switchover, causing interruption of data forwarding.

4.4.16 Correlating OSPF with BFD

Configuration Effect

- Once a link is faulty, OSPF can quickly detect the failure of the route. This configuration helps shorten the traffic interruption time.

Notes

- The OSPF basic functions must be configured.
- The BFD parameters must be configured for the interface in advance.

- If BFD is configured for both a process and an interface, the configuration for the interface takes effect preferentially.

Configuration Steps

↘ **Correlating OSPF with BFD**

- (Optional) This configuration is required if you wish to accelerate OSPF network convergence.
- The configuration must be performed on routers at both ends of the link.

Verification

- Run the **show bfd neighbor** command to verify that the BFD neighbors are normal.

Related Commands

↘ **Correlating an OSPF Interface with BFD**

Command	ip ospf bfd [disable]
Parameter Description	disable: Disables BFD for link detection on a specified OSPF-enabled interface.
Command Mode	Interface configuration mode
Usage Guide	The interface-based configuration takes precedence over the bfd all-interfaces command used in process configuration mode. Based on the actual environment, you can run the ip ospf bfd command to enable BFD on a specified interface for link detection, or run the bfd all-interfaces command in OSPF process configuration mode to enable BFD on all interface of the OSPF process, or run the ospf bfd disable command to disable BFD on a specified interface.

↘ **Correlatingan OSPF Process with BFD**

Command	bfd all-interfaces
Parameter Description	N/A
Command Mode	OSPF process configuration mode
Usage Guide	OSPF dynamically discovers neighbors through the Hello packets. After OSPF enables the BFD function, a BFD session will be set up to achieve the full adjacency, and use the BFD mechanism to detect the neighbor status. Once a neighbor failure is detected through BFD, OSPF performs network convergence immediately. You can also run the ip ospf bfd [disable] command in interface configuration mode to enable or disable the BFD function on a specified interface, and this configuration takes precedence over the bfd all-interfaces command used in OSPF process configuration mode.

Configuration Example

-  The following configuration examples assume that the OSPF basic functions have been configured. For details about the OSPF basic functions, see section 4.4.1 "Configuring OSPF Basic Functions."

<p>Scenario Figure 4-25</p>	
<p>Configuration Steps</p>	<ul style="list-style-type: none"> ● Configure the interface IP addresses on all routers. (Omitted) ● Configure the OSPF basic functions on all routers. (Omitted) ● Configure the BFD parameters for interfaces of all routers. ● Correlate OSPF with BFD on all routers.
<p>A</p>	<pre>A# configure terminal A(config)# interface GigabitEthernet 0/1 A(config-if-GigabitEthernet 0/1)#bfd interval 200 min_rx 200 multiplier 5 A(config)# router ospf 1 A(config-router)#bfd all-interfaces</pre>
<p>B</p>	<pre>B(config)# interface GigabitEthernet 0/1 B(config-if-GigabitEthernet 2/1)#bfd interval 200 min_rx 200 multiplier 5 B(config)# router ospf 1 B(config-router)#bfd all-interfaces</pre>
<p>Verification</p>	<ul style="list-style-type: none"> ● On Router A and Router B, verify that the BFD state is Up. ● Disconnect Router A from the switch. On Router A, verify that a neighbor is found disconnected during BFD, and the corresponding OSPF route is deleted.
<p>A</p>	<pre>A# show ip ospf neighbor OSPF process 1, 1 Neighbors, 1 is Full: Neighbor ID Pri State BFD State Dead Time Address Interface 192.168.1.2 1 Full/BDR Up 00:00:40 192.168.1.2 GigabitEthernet 0/1</pre>
<p>B</p>	<pre>B# show ip ospf neighbor OSPF process 1, 1 Neighbors, 1 is Full: Neighbor ID Pri State BFD State Dead Time Address Interface 192.168.1.1 1 Full/BDR Up 00:00:40 192.168.1.1 GigabitEthernet 0/1</pre>

4.4.17 Enabling Fast Reroute

Configuration Effect

- Once OSPF detects a route failure, the router can immediately switch to the second-best route. This configuration helps shorten the traffic interruption time.

Notes

- The OSPF basic functions must be configured.
- The LAF configuration for fast reroute is mutually exclusive with the virtual link configuration.
- You must set **carrier-delay** of an interface to 0.

Configuration Steps

➤ **Configuring Fast Reroute**

- (Optional) This configuration is required if you wish to increase the OSPF network convergence speed to the millisecond level.
- This configuration is performed on a router that has multiple paths to a destination network.

➤ **Preventing an Interface From Becoming a Standby Interface**

- (Optional) This configuration is mandatory if you wish that data traffic is not switched over to a specified path after the best path fails. After the best path fails, the traffic will be switched over another second-best path, but a new best path will be selected based on the interface costs after OSPF converges again.
- This configuration is performed on a device where fast reroute is enabled.

Verification

Run the **show ip route fast-reroute** command to verify that both the best and second-best paths exist.

Related Commands

➤ **Configuring Fast Reroute**

Command	fast-reroute { lfa [downstream-paths] route-map <i>route-map-name</i> }
Parameter	lfa : Enables computation of the loop-free standby path.
Description	downstream-paths : Enables computation of the downstream path. route-map <i>route-map-name</i> : Specifies a standby path through the route map.
Command Mode	OSPF routing process configuration mode
Usage Guide	<p>If the lfa parameter is configured, computation of the loop-free standby path is enabled. In this case, you can use the interface mode command to specify the path protection mode of the interface.</p> <p>It is recommended that computation of the loop-free standby path be disabled if any of the following case exists on the network:</p> <ol style="list-style-type: none"> 1. Virtual links exist. 2. Alternative ABRs exist. 3. An ASBR is also an ABR. 4. Multiple ABSRs advertise the same external route. <p>If both lfa and downstream-paths are configured, computation of the downstream path is enabled.</p> <p>If route-map is configured, a standby path can be specified for a matched route through the route-map.</p> <p>When the OSPF fast reroute function is used, it is recommended that BFD be enabled at the same time so that the device can quickly detect any link failure and therefore shorten the forwarding interruption time. If the interface is up or down,</p>

	to shorten the forwarding interruption time during OSPF fast reroute, you can configure carrier-delay 0 in L3 interface configuration mode to achieve the fastest switchover speed.
--	--

➤ **Configuring the Interface LFA Protection**

Command	ip ospf fast-reroute protection { node link-node disable}
Parameter Description	node: Enables the LFA node protection. link-node: Enables the LFA link node protection. disable: Disables LFA protection.
Command Mode	Interface configuration mode
Usage Guide	If the fast-reroute lfa command is executed in OSPF route process configuration mode, the OSPF fast reroute computation function will be generated, and a standby route will be generated for the active route based on the LFA protection mode specified in interface configuration mode. Link protection is enabled by default for each OSPF interface. Under this protection mode, the failure of the active link does not affect data forwarding on the standby route. Use the node parameter to enable node protection for the interface, that is, data forwarding on the standby route will not be affected by the failure of a neighbor node corresponding to the active link. Use the link-node parameter to protect both the link and neighbor node corresponding to the active link. Use the disable parameter to disable the LFA protection function of the interface, that is, not to generate a standby entry for the route whose next hop is the interface. This command does not take effect if fast-reroute route-map is configured.

➤ **Preventing an Interface From Becoming a Standby Interface**

Command	ip ospf fast-reroute no-eligible-backup
Parameter Description	N/A
Command Mode	Interface configuration mode
Usage Guide	If the remaining bandwidth of an interface is small or if the interface and its active interface may fail at the same time, the interface cannot be used as a standby interface. Therefore, you need to run this command in interface configuration mode to prevent this interface from becoming a standby interface during OSPF fast reroute computation. After this command is executed, the standby interface is selected from other interface. This command does not take effect if fast-reroute route-map is configured.

Configuration Example

The following configuration examples assume that the OSPF basic functions have been configured. For details about the OSPF basic functions, see section 4.4.1 "Configuring OSPF Basic Functions."

➤ **Configuring Fast Reroute**

<p>Scenario Figure 4-26</p>	<p>Remarks The interface IP addresses are as follows: A: GE0/1 192.168.1.1 GE0/2 192.168.2.1 B: GE0/1 192.168.1.2 GE0/2 192.168.3.1 GE0/3 192.168.4.1 C: GE0/1 192.168.3.2 GE 0/2 192.168.2.2</p>
<p>Configuration Steps</p>	<ul style="list-style-type: none"> ● Configure the interface IP addresses on all routers. (Omitted) ● Configure the OSPF basic functions on all routers. (Omitted) ● Configure fast reroute on Router A. ● Configure carrier-delay 0 for the interface on Router A.
<p>A</p>	<pre>A# configure terminal A(config)# router ospf 1 A(config-router)# fast-reroute lfa A(config-router)# exit A(config)# interface GigabitEthernet 0/1 A(config-if-GigabitEthernet 0/1)#carrier-delay 0 A(config-if-GigabitEthernet 0/1)# exit A(config)# interface GigabitEthernet 0/2 A(config-if-GigabitEthernet 0/2)#carrier-delay 0</pre>
<p>Verification</p>	<p>On Router A, check the routing table and verify that a standby route exists for the entry 192.168.4.0/24.</p>
	<pre>A# show ip route fast-reroute begin 192.168.4.0 O 192.168.4.0/24 [ma] via 192.168.1.2, 00:39:28, GigabitEthernet 0/1 [b] via 192.168.2.2, 00:39:28, GigabitEthernet 0/2</pre>

4.4.18 Enabling iSPF

Configuration Effect

- OSPF adopts the iSPF algorithm to compute the network topology.

Notes

- The OSPF basic functions must be configured.

Configuration Steps

➤ **Configuring iSPF**

- (Optional) This configuration is recommended if you wish to accelerate route convergence in a single area with more than 100 routers.
- This configuration is performed on all routers in the area.

Verification

Run the **show ip ospf** command to verify that iSPF is enabled.

Related Commands

➤ **Configuring iSPF**

Command	ispf enable
Parameter Description	N/A
Command Mode	OSPF routing process configuration mode
Usage Guide	After iSPF is enabled, OSPF will use the iSPF algorithm to compute the network topology. That is, after the network topology changes, OSPF corrects only the nodes affected by the topological change, instead of re-building the entire SPT. The iSPF function is generally used on a large-sized network to ease the pressure on router processors.

Configuration Example

i The following configuration examples assume that the OSPF basic functions have been configured. For details about the OSPF basic functions, see section 4.4.1 "Configuring OSPF Basic Functions."

➤ **Configuring iSPF**

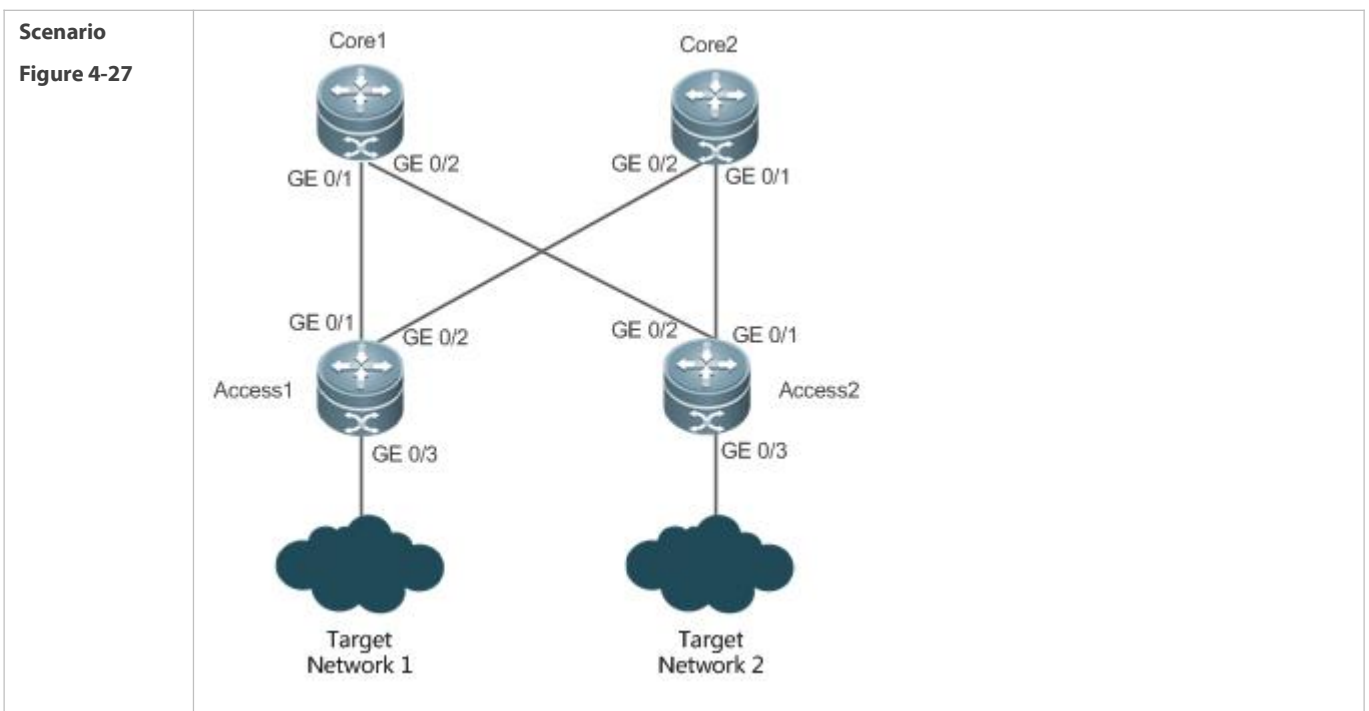

	<p>Remarks</p> <p>The interface IP addresses are as follows:</p> <p>Core1: GE0/1 192.168.1.1 GE0/2 192.168.2.1</p> <p>Core2: GE0/1 192.168.3.1 GE0/2 192.168.4.1</p> <p>Access1: GE0/1 192.168.1.2 GE 0/2 192.168.3.2</p> <p>Access2: GE0/1 192.168.4.2 GE 0/2 192.168.2.2</p>
<p>Configuration Steps</p>	<ul style="list-style-type: none"> ● Configure the interface IP addresses on all routers. (Omitted) ● Configure the OSPF basic functions on all routers. (Omitted) ● Configure iSPF on all routers.
<p>Core1</p>	<pre>Core1# configure terminal Core1(config)# router ospf 1 Core1(config-router)# ispf enable</pre>
<p>Core2</p>	<pre>Core2# configure terminal Core2(config)# router ospf 1 Core2(config-router)# ispf enable</pre>
<p>Access1</p>	<pre>Access1# configure terminal Access1(config)# router ospf 1 Access1(config-router)# ispf enable</pre>
<p>Access2</p>	<pre>Access2# configure terminal Access2(config)# router ospf 1 Access2(config-router)# ispf enable</pre>
<p>Verification</p>	<p>On router Core1, verify that iSPF is enabled.</p>
	<pre>Core1# show ip ospf Routing Process "ospf 1" with ID 1.1.1.1 Process uptime is 17 hours 48 minutes Process bound to VRF default Memory Overflow is enabled. Router is not in overflow state now. Conforms to RFC2328, and RFC1583Compatibility flag is enabled Supports only single TOS(TOS0) routes Supports opaque LSA Enable two-way-maintain Enable ispf Initial SPF schedule delay 1000 msecs</pre>

	<p>Minimum hold time between two consecutive SPFs 5000 msecs</p> <p>Maximum wait time between two consecutive SPFs 10000 msecs</p> <p>Initial LSA throttle delay 0 msecs</p> <p>Minimum hold time for LSA throttle 5000 msecs</p> <p>Maximum wait time for LSA throttle 5000 msecs</p> <p>Lsa Transmit Pacing timer 40 msecs, 1 LS-Upd</p> <p>Minimum LSA arrival 1000 msecs</p> <p>Pacing lsa-group: 30 secs</p> <p>Number of incoming current DD exchange neighbors 0/5</p> <p>Number of outgoing current DD exchange neighbors 0/5</p> <p>Number of external LSA 0. Checksum 0x000000</p> <p>Number of opaque AS LSA 0. Checksum 0x000000</p> <p>Number of non-default external LSA 0</p> <p>External LSA database is unlimited.</p> <p>Number of LSA originated 2</p> <p>Number of LSA received 93</p> <p>Log Neighbor Adjacency Changes : Enabled</p> <p>Graceful-restart disabled</p> <p>Graceful-restart helper support enabled</p> <p>Number of areas attached to this router: 1: 1 normal 0 stub 0 nssa</p> <p>Area 1</p> <p style="padding-left: 20px;">Number of interfaces in this area is 1(1)</p> <p style="padding-left: 20px;">Number of fully adjacent neighbors in this area is 0</p> <p style="padding-left: 20px;">Number of fully adjacent virtual neighbors through this area is 0</p> <p style="padding-left: 20px;">Area has no authentication</p> <p style="padding-left: 20px;">SPF algorithm executed 0 times</p> <p style="padding-left: 20px;">iSPF algorithm last executed 00:04:14.534 ago</p> <p style="padding-left: 20px;">iSPF algorithm executed 12 times</p> <p style="padding-left: 20px;">Number of LSA 1. Checksum 0x0029b3</p>
--	---

4.4.19 Configuring the Network Management Function

Configuration Effect

- Use the network management software to manage OSPF parameters and monitor the OSPF running status.

Notes

- The OSPF basic functions must be configured.
- You must enable the MIB function of the SNMP-Server before enabling the OSPF MIB function.
- You must enable the Trap function of the SNMP-Server before enabling the OSPF Trap function.
- You must enable the logging function of the device before outputting the OSPF logs.

Configuration Steps

➤ **Binding the MIB with the OSPF Process**

- (Optional) This configuration is required if you want to use the network management software to manage parameters of a specified OSPF process.
- This configuration is performed on all routers.

➤ **Enabling the Trap Function**

- (Optional) This configuration is required if you want to use the network management software to monitor the OSPF running status.
- This configuration is performed on all routers.

➤ **Configuring the Logging Function**

- (Optional) This function is enabled by default. You are advised to retain the default configuration. If you want to reduce the log output, disable this function.
- This configuration is performed on all routers.

Verification

- Use the network management software to manage the OSPF parameters.
- Use the network management software to monitor the OSPF running status.

Related Commands

➤ **Binding the MIB with the OSPF Process**

Command	enable mib-binding
Parameter	N/A
Description	
Command Mode	OSPF routing process configuration mode
Usage Guide	The OSPFv2 MIB does not have the OSPFv2 process information. Therefore, you must perform operations on a single OSPFv2 process through SNMP. By default, the OSPFv2 MIB is bound with the OSPFv2 process with the smallest process ID, and all user operations take effect on this process. If you wish to perform operations on a specified OSPFv2 through SNMP, run this command to bind the MIB with the process.

➤ **Enabling the Trap Function**

Command	enable traps[error [IfAuthFailure IfConfigError IfRxBadPacket VirtIfAuthFailure VirtIfConfigError VirtIfRxBadPacket] Isa [LsdbApproachOverflow LsdbOverflow MaxAgeLsa OriginateLsa] retransmit
----------------	--

	[IfTxRetransmit VirtIfTxRetransmit] state-change [IfStateChange NbrRestartHelperStatusChange NbrStateChange NssaTranslatorStatusChange RestartStatusChange VirtIfStateChange VirtNbrRestartHelperStatusChange VirtNbrStateChange]
Parameter Description	<p>IfAuthFailure: Indicates that an interface authentication failure occurs.</p> <p>IfConfigError: Indicates that an interface parameter configuration error occurs.</p> <p>IfRxBadPacket: Indicates that the interface receives a bad packet.</p> <p>IfRxBadPacket: Indicates that the interface receives a bad packet.</p> <p>VirtIfAuthFailure: Indicates that a virtual interface authentication failure occurs.</p> <p>VirtIfConfigError: Indicates that a virtual interface parameter configuration error occurs.</p> <p>VirtIfRxBadPacket: Indicates that the virtual interface receives a bad packet.</p> <p>LsdbApproachOverflow: Indicates that the number of external LSAs has reached 90% of the upper limit.</p> <p>LsdbOverflow: Indicates that the number of external LSAs has reached the upper limit.</p> <p>MaxAgeLsa: Indicates that the LSA aging timer expires.</p> <p>OriginateLsa: Indicates that a new LSA is generated.</p> <p>IfTxRetransmit: Indicates that a packet is retransmitted on the interface.</p> <p>VirtIfTxRetransmit: Indicates that a packet is retransmitted on the virtual interface.</p> <p>IfStateChange: Indicates that interface state changes.</p> <p>NbrRestartHelperStatusChange:Indicates that the state of the neighbor GR process changes.</p> <p>NbrStateChange: Indicates that the neighbor state changes.</p> <p>NssaTranslatorStatusChange: Indicates that the NSSA translation state changes.</p> <p>RestartStatusChange: Indicates that the GR state of the local device changes.</p> <p>VirtIfStateChange: Indicates that the virtual interface state changes.</p> <p>VirtNbrRestartHelperStatusChange: Indicates that the GR state of the virtual neighbor changes.</p> <p>VirtNbrStateChange: Indicates that the virtual neighbor state changes.</p>
Command Mode	OSPF routing process configuration mode
Usage Guide	The function configured by this command is restricted by the snmp-server enable traps ospf and then enable traps command before the corresponding OSPF traps can be correctly sent out. This command is not restricted by the MIB bound with the process. The trap function can be enabled concurrently for different processes.

📌 **Configuring the Logging Function**

Command	log-adj-changes [detail]
Parameter Description	detail: Records all status change information.
Command Mode	OSPF routing process configuration mode
Usage Guide	N/A

Configuration Example

i The following configuration examples assume that the OSPF basic functions have been configured. For details about the OSPF basic functions, see section 4.4.1 "Configuring OSPF Basic Functions."

<p>Scenario Figure 4-28</p>	
<p>Configuration Steps</p>	<ul style="list-style-type: none"> ● Configure the interface IP addresses on all routers. (Omitted) ● Configure the OSPF basic functions on all routers. (Omitted) ● Bind the MIB with the OSPF process on Router A. ● Enable the trap function on Router A.
<p>A</p>	<pre>A# configure terminal A(config)# snmp-server host 192.168.2.2 traps version 2c public A(config)# snmp-server community public rw A(config)# snmp-server enable traps A(config)# router ospf 10 A(config-router)# enable mib-binding A(config-router)# enable traps</pre>
<p>Verification</p>	<p>Use the MIB tool to read and set the OSPF parameters and display the OSPF running status.</p>

Common Errors

Configurations on the SNMP-Server are incorrect. For example, the MIB or trap function is not enabled.

4.4.20 Modifying Protocol Control Parameters

Configuration Effect

Modify protocol control parameters to change the protocol running status.

Notes

- The OSPF basic functions must be configured.
- The neighbor dead time cannot be shorter than the Hello interval.

Configuration Steps

↘ Configuring the Hello Interval

- (Optional) You are advised to retain the default configuration.
- This configuration is performed on routers at both end of a link.

↘ Configuring the Dead Interval

- (Optional) You are advised to retain the default configuration. This configuration can be adjusted if you wish to accelerate OSPF convergence when a link fails.

- This configuration is performed on routers at both end of a link.

↘ **Configuring LSU Retransmission Interval**

- (Optional) You are advised to adjust this configuration if a lot of routes exist in the user environment and network congestion is serious.

↘ **Configuring the LSA Generation Time**

- (Optional) You are advised to retain the default configuration.

↘ **Configuring the LSA Group Refresh Time**

- (Optional) You are advised to retain the default configuration. This configuration can be adjusted if a lot of routes exist in the user environment.

- This configuration is performed on an ASBR or ABR.

↘ **Configuring LSA Repeated Receiving Delay**

- (Optional) You are advised to retain the default configuration.

↘ **Configuring the SPF Computation Delay**

- (Optional) This configuration can be adjusted if network flapping frequently occurs.

↘ **Configuring the Inter-Area Route Computation Delay**

- (Optional) You are advised to retain the default configuration.
- This configuration is performed on all routers.

↘ **Configuring the External Route Computation Delay**

- (Optional) You are advised to retain the default configuration.
- This configuration is performed on all routers.

Verification

Run the **show ip ospfandshow ip ospf neighbor** commands to display the protocol running parameters and status.

Related Commands

↘ **Configuring the Hello Interval**

Command	ip ospf hello-interval <i>seconds</i>
Parameter Description	<i>seconds</i> : Indicates the interval at which OSPF sends the Hello packet. The unit is second. The value ranges from 1 to 65,535.
Command Mode	Interface configuration mode
Usage Guide	The Hello interval is contained in the Hello packet. A shorter Hello interval indicates that OSPF can detect topological changes more quickly, but the network traffic increases. The Hello interval must be the same on all routers in the same network segment. If you want to manually modify the neighbor dead interval, ensure that the neighbor dead interval is longer than the Hello interval.

↘ Configuring the Dead Interval

Command	ip ospf dead-interval <i>seconds</i>
Parameter Description	<i>seconds</i> : Indicates the time that the neighbor is declared lost. The unit is second. The value ranges from 0 to 2,147,483,647.
Command Mode	Interface configuration mode
Usage Guide	<p>The OSPF dead interval is contained in the Hello packet. If OSPF does not receive a Hello packet from a neighbor within the dead interval, it declares that the neighbor is invalid and deletes this neighbor record from the neighbor list. By default, the dead interval is four times the Hello interval. If the Hello interval is modified, the dead interval is modified automatically.</p> <p>When using this command to manually modify the dead interval, pay attention to the following issues:</p> <ol style="list-style-type: none"> 1. The dead interval cannot be shorter than the Hello interval. 2. The dead interval must be the same on all routers in the same network segment.

↘ Configuring the LSU Transmission Delay

Command	ip ospf transmit-delay <i>seconds</i>
Parameter Description	<i>seconds</i> : Indicates the LSU transmission delay on the OSPF interface. The unit is second. The value ranges from 1 to 65,535.
Command Mode	Interface configuration mode
Usage Guide	<p>Before an LSU packet is transmitted, the Age fields in all LSAs in this packet will increase based on the amount specified by the ip ospf transmit-delay command. Considering the transmit and line propagation delays on the interface, you need to set the LSU transmission delay to a greater value for a low-speed line or interface. The LSU transmission delay of a virtual link is defined by the transmit-delay parameter in the area virtual-link command.</p> <p>If the value of the Age field of an LSA reaches 3600, the packet will be retransmitted or a retransmission will be requested. If the LSA is not updated in time, the expired LSA will be deleted from the LSDB.</p>

↘ Configuring LSU Retransmission Interval

Command	ip ospf retransmit-interval <i>seconds</i>
Parameter Description	<i>seconds</i> : Indicates the LSU retransmission interval. The unit is second. The value ranges from 0 to 65,535. This interval must be longer than the round-trip transmission delay of data packets between two neighbors.
Command Mode	Interface configuration mode
Usage Guide	<p>After a router finishes sending an LSU packet, this packet is still kept in the transmit buffer queue. If an acknowledgment from the neighbor is not received within the time defined by the ip ospf retransmit-interval command, the router retransmits the LSU packet.</p> <p>The retransmission delay can be set to a greater value on a serial line or virtual link to prevent unnecessary retransmission. The LSU retransmission delay of a virtual link is defined by the retransmit-interval parameter in the area virtual-link command.</p>

↘ Configuring the LSA Generation Time

Command	timers throttle lsa all <i>delay-time hold-time max-wait-time</i>
Parameter	<i>delay-time</i> : Indicates the minimum delay for LSA generation. The first LSA in the database is always generated instantly.

Description	<p>The value ranges from 0 to 600,000. The unit is ms.</p> <p><i>hold-time</i>: Indicates the minimum interval between the first LSA update and the second LSA update. The value ranges from 0 to 600,000. The unit is ms.</p> <p><i>max-wait-time</i>: Indicates the maximum interval between two LSA updates when the LSA is updated continuously. This interval is also used to determine whether the LSA is updated continuously. The value ranges from 0 to 600,000. The unit is ms.</p>
Command	OSPF routing process configuration mode
Mode	
Usage Guide	<p>If a high convergence requirement is raised when a link changes, you can set delay-time to a smaller value. You can also appropriately increase values of the preceding parameters to reduce the CPU usage.</p> <p>When configuring this command, the value of hold-time cannot be smaller than the value of delay-time, and the value of max-wait-time cannot be smaller than the value of hold-time.</p>

↘ **Configuring the LSA Group Refresh Time**

Command	timers pacinglsa-group <i>seconds</i>
Parameter Description	<i>seconds</i> : Indicates the LSA group pacing interval. The value ranges from 10 to 1,800. The unit is second.
Command Mode	OSPF routing process configuration mode
Usage Guide	<p>Every LSA has a time to live (LSA age). When the LSA age reaches 1800s, a refreshment is needed to prevent LSAs from being cleared because their ages reaching the maximum. If LSA update and aging computation are performed for every LSA, the device will consume a lot of CPU resources. In order to use CPU resources effectively, you can refresh LSAs by group on the device. The interval of group refreshment is called group pacing interval. The group refreshment operation is to organize the LSAs generated within a group pacing interval into a group and refresh the group as a whole.</p> <p>If the total number of LSAs does not change, a larger group pacing interval indicates that more LSAs need to be processed after timeout. To maintain the CPU stability, the number of LSAs processes upon each timeout cannot be too large. If the number of LSAs is large, you are advised to reduce the group pacing interval. For example, if there are 1000 LSAs in the database, you can reduce the pacing interval; if there are 40 to 100 LSAs, you can set the pacing interval to 10-20 minutes.</p>

↘ **Configuring the LSA Group Refresh Interval**

Command	timers pacing lsa-transmit <i>transmit-time transmit-count</i>
Parameter Description	<p><i>transmit-time</i>: Indicates the LSA group transmission interval. The value ranges from 10 to 1,000. The unit is ms.</p> <p><i>transmit-count</i>: Indicates the number of LS-UPD packets in a group. The value ranges from 1 to 200.</p>
Command Mode	OSPF routing process configuration mode
Usage Guide	<p>If the number of LSAs is large and the device load is heavy in an environment, properly configuring transimit-time and transimit-count can limit the number of LS-UPD packets flooded on a network.</p> <p>If the CPU usage is not high and the network bandwidth load is not heavy, reducing the value of transimit-time and increasing the value of transimit-count can accelerate the environment convergence.</p>

↘ **Configuring LSA Repeated Receiving Delay**

Command	timers lsa arrival <i>arrival-time</i>
Parameter	<i>arrival-time</i> : Indicates the delay after which the same LSA is received. The value ranges from 0 to 600,000. The unit is ms.

Description	
Command	OSPF routing process configuration mode
Mode	
Usage Guide	No processing is performed if the same LSA is received within the specified time.

↘ **Configuring the Inter-Area Route Computation Delay**

Command	timers throttle route inter-area <i>ia-delay</i>
Parameter Description	<i>ia-delay</i> : Indicates the inter-area route computation delay. The unit is ms. The value ranges from 0 to 600,000.
Command Mode	OSPF routing process configuration mode
Usage Guide	This delay cannot be modified if strict requirements are raised for the network convergence time.

↘ **Configuring the External Route Computation Delay**

Command	timers throttle route ase <i>ase-delay</i>
Parameter Description	<i>ase-delay</i> : Indicates the external route computation delay. The unit is ms. The value ranges from 0 to 600,000.
Command Mode	OSPF routing process configuration mode
Usage Guide	This delay cannot be modified if strict requirements are raised for the network convergence time.

↘ **Configuring the SPF Computation Delay**

Command	timers throttle spf <i>spf-delay spf-holdtime spf-max-waittime</i>
Parameter Description	<p><i>spf-delay</i>: Indicates the SPF computation delay. The unit is ms. The value ranges from 0 to 600,000. When detecting a topological change, the OSPF routing process triggers the SPF computation at least after spf-delay elapses.</p> <p><i>spf-holdtime</i>: Indicates the minimum interval between two SPF computations. The unit is ms. The value ranges from 0 to 600,000.</p> <p><i>spf-max-waittime</i>: Indicates the maximum interval between two SPF computations. The unit is ms. The value ranges from 0 to 600,000.</p> <p><i>number</i>: indicates the metric of the summarized route.</p>
Command Mode	OSPF routing process configuration mode
Usage Guide	<p>spf-delay indicates the minimum time between the occurrence of the topological change and the start of SPF computation. spf-holdtime indicates the minimum interval between the first SPF computation and the second SPF computation. After that, the interval between two SPF computations must be at least twice of the previous interval. When the interval reaches spf-max-waittime, the interval cannot increase again. If the interval between two SPF computations already exceeds the required minimum value, the interval is computed by starting from spf-holdtime. You can set spf-delay and spf-holdtime to smaller values to accelerate topology convergence, and set spf-max-waittime to a larger value to reduce SPF computation. Flexible settings can be used based on stability of the network topology.</p> <p>Compared with the timers spf command, this command supports more flexible settings to accelerate the convergence speed of SPF computation and further reduce the system resources consumed by SPF computation when the topology continuously changes. Therefore, you are advised to use the timers throttle spf command for configuration.</p> <ol style="list-style-type: none"> The value of spf-holdtime cannot be smaller than the value of spf-delay; otherwise, spf-holdtime will be

	<p>automatically set to the value of spf-delay.</p> <ol style="list-style-type: none"> 2. The value of spf-max-waittime cannot be smaller than the value of spf-holdtime; otherwise, spf-max-waittime will be automatically set to the value of spf-holdtime. 3. The configurations of timers throttle spf and timers spf are mutually overwritten. 4. When both timers throttle spf and timers spf are not configured, the default values of timers throttle spf prevail.
--	---

Configuration Example

i The following configuration examples assume that the OSPF basic functions have been configured. For details about the OSPF basic functions, see section 4.4.1 "Configuring OSPF Basic Functions."

▾ Configuring the Hello Interval and Dead Interval

Scenario Figure 4-29	
Configuration Steps	<ul style="list-style-type: none"> ● Configure the interface IP addresses on all routers. (Omitted) ● Configure the OSPF basic functions on all routers. (Omitted) ● Configure the Hello interval and dead interval on all routers.
A	<pre>A# configure terminal A(config)# interface GigabitEthernet 0/1 A(config-if-GigabitEthernet 0/1)# ip ospf hello-interval 15 A(config-if-GigabitEthernet 0/1)# ip ospf dead-interval 50</pre>
B	<pre>B# configure terminal B(config)# interface GigabitEthernet 0/1 B(config-if-GigabitEthernet 0/1)# ip ospf hello-interval 15 A(config-if-GigabitEthernet 0/1)# ip ospf dead-interval 50</pre>
Verification	Check the interface parameters on Router A. Verify that the Hello interval is 10s and the dead interval is 50s.

```

A
A# show ip ospf interface

GigabitEthernet 0/1 is up, line protocol is up

  Internet Address 192.168.1.1/24, Ifindex 2, Area 0.0.0.0, MTU 1500

  Matching network config: 192.168.1.0/24

  Process ID 1, Router ID 192.168.1.2, Network Type POINTOMULTIPOINT, Cost: 1

  Transmit Delay is 1 sec, State Point-To-Point

  Timer intervals configured, Hello 15, Dead 50, Wait 40, Retransmit 5

    Hello due in 00:00:02

  Neighbor Count is 1, Adjacent neighbor count is 0

  Crypt Sequence Number is 4787

  Hello received 465 sent 466, DD received 8 sent 8

  LS-Req received 2 sent 2, LS-Upd received 8 sent 21

  LS-Ack received 14 sent 7, Discarded 3
    
```

Common Errors

- The configured neighbor dead time is shorter than the Hello interval.

4.5 Monitoring

Clearing

Running the **clear** commands may lose vital information and thus interrupt services.

Description	Command
Clears and resets an OSPF process.	clear ip ospf [process-id] process

Displaying

Description	Command
Displays the OSPF process configurations.	show ip ospf [process-id]
Displays the OSPF internal routing table, including routes to ABRs and ASBRs.	show ip ospf [process-id] border-routers
Displays information about the OSPF LSDB.	show ip ospf [process-id area-id] database [{ asbr-summary external network nssa-external opaque-area opaque-as opaque-link router summary }] [{ adv-router ip-address self-originate } link-state-id] [brief] [database-summary max-age detail]
Displays OSPF-enabled interfaces.	show ip ospf [process-id] interface [interface-type interface-number brief]
Displays the OSPF neighbor list.	show ip ospf [process-id] neighbor [detail] [interface-type interface-number] [neighbor-id]
Displays the OSPF routing table.	show ip ospf [process-id] route [count]
Displays the number of times SPT is	show ip ospf [process-id] spf

Description	Command
computed in the OSPF area.	
Displays the summarized route of OSPF redistributed routes.	show ip ospf [<i>process-id</i>] summary-address
Displays the OSPF network topology information.	show ip ospf [<i>process-id</i> [<i>area-id</i>]] topology [<i>adv-router</i> <i>adv-router-id</i> [<i>router-id</i>]] self-originate [<i>router-id</i>]
Displays OSPF virtual links.	show ip ospf [<i>process-id</i>] virtual-links [<i>ip-address</i>]

Debugging



System resources are occupied when debugging information is output. Therefore, disable debugging immediately after use.

Description	Command
Debugs OSPF events.	debug ip ospf events [<i>abr</i> <i>asbr</i> <i>lsa</i> <i>nssa</i> <i>os</i> <i>restart</i>] router <i>slink</i> <i>vlink</i>
Debugs OSPF interfaces.	debug ip ospf ifsm [<i>events</i> <i>status</i> <i>timers</i>]
Debugs OSPF neighbors.	debug ip ospf nfm [<i>events</i> <i>status</i> <i>timers</i>]
Debugs the OSPF NSM.	debug ip ospf nsm [<i>interface</i> <i>redistribute</i> <i>route</i>]
Debugs OSPF LSAs.	debug ip ospf lsa [<i>flooding</i> <i>generate</i> <i>install</i> <i>maxage</i> <i>refresh</i>]
Debugs OSPF packets.	debug ip ospf packet [<i>dd</i> <i>detail</i> <i>hello</i> <i>ls-ack</i> <i>ls-request</i> <i>ls-update</i> <i>rcv</i> <i>send</i>]
Debugs OSPF routes.	debug ip ospf route [<i>ase</i> <i>ia</i> <i>install</i> <i>spf</i> <i>time</i>]

5 Configuring OSPFv3

5.1 Overview

Open Shortest Path First (OSPF) is an Interior Gateway Protocol (IGP) that is used within the Autonomous System (AS) to allow routers to obtain a route to a remote network.

- i** OSPF Version 2 (OSPFv2) is applicable to IPv4, and OSPF Version 3 (OSPFv3) is applicable to IPv6. The protocol running mechanism and most configurations are the same.

OSPF has the following characteristics:

- Wide scope of application: OSPF is applicable to a larger-scale network that supports hundreds of routers.
 - Fast convergence: Once the network topology changes, notifications can be quickly sent between routers to update routes.
 - No self-loop: Only the link status information is synchronized between routers. Each router computes routes independently, and a self-loop will not occur.
 - Area division: A large routing domain is divided into multiple small areas to save system resources and network bandwidth and ensure stability and reliability of routes.
 - Route classification: Routes are classified into several types to support flexible control.
 - Equivalent routes: OSPF supports equivalent routes.
 - Authentication: OSPF supports packet authentication to ensure security of protocol interaction.
 - Multicast transmission: Protocol packets are sent using the multicast address to avoid interfering with irrelevant entities and save system resources.
- i** In this chapter, the term "router" refers to any network device that supports the routing function. These network devices can be L3 switches, routers, or firewall.

i Unless otherwise specified, "OSPF" in the following descriptions refers to OSPFv3.

Protocols and Standards

RFC2740	This document describes the modifications to OSPF to support version 6 of the Internet Protocol (IPv6).
draft-ietf-ospf-ospfv3-graceful-restart	This document describes the OSPFv3 graceful restart. The OSPFv3 graceful restart is identical to OSPFv2 except for the differences described in this document. These differences include the format of the grace Link State Advertisements (LSA) and other considerations.
draft-ietf-ospf-ospfv3-mib-11	This memo defines a portion of the Management Information Base (MIB) for use with network management protocols in IPv6-based internets. In particular, it defines objects for managing the Open Shortest Path First Routing Protocol for IPv6.

5.2 Applications

Application	Description
Intra-Domain Interworking	OSPF runs within the AS, which is divided into several areas.
Inter-Domain Interworking	Several ASs are interconnected. OSPF runs within each AS, and BGP runs between ASs.

5.2.1 Intra-Domain Interworking

Scenario

OSPF runs within the AS. If the number of routers exceeds 40, it is recommended that the AS be divided into several areas. Generally, high-end devices featuring reliable performance and fast processing speed are deployed in a backbone area, and low-end or medium-range devices with relatively lower performance can be deployed in a normal area. All normal areas must be connected to the backbone area. It is recommended that a normal area located on the stub be configured as a stub area. As shown in Figure 5- 1, the network is divided into four areas. Communication between these areas must go through the backbone area, that is, area 0.

Figure 5- 1 Division of the OSPF Areas

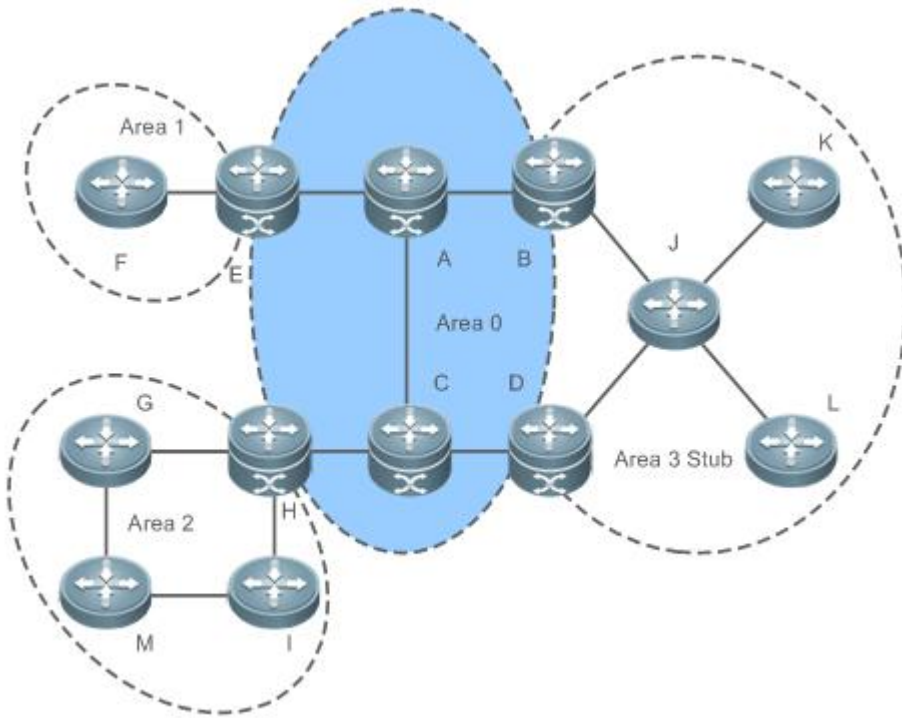

Remarks	A, B, C, D, E, and H are located in the backbone area, and are backbone routers. Area 3 is configured as a stub area.
----------------	--

Deployment

- OSPF runs on all routers within the AS to implement unicast routing.

5.2.2 Inter-Domain Interworking

Scenario

Several ASs are interconnected. OSPF runs within each AS, and BGP runs between ASs. Generally, OSPF and BGP learn the routing information from each other.

As shown in Figure 5- 2, unicast routing is implemented within AS 100 and AS 200 using OSPF, and between the two ASs using BGP.

Figure 5- 2 Interworking Between OSPF and BGP

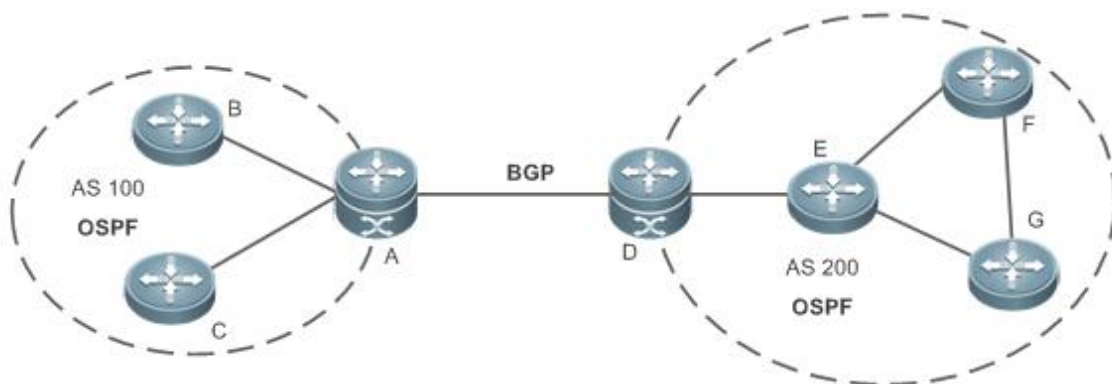

Remarks	OSPF and BGP run concurrently on Router A and Router D.
----------------	---

Deployment

- OSPF runs within AS 100 and AS 200 to implement unicast routing.
- BGP runs between the two ASs to implement unicast routing.

5.3 Features

Basic Concepts

↳ Routing Domain

All routers in an AS must be interconnected and use the same routing protocol. Therefore, an AS is also called a routing domain. An AS on which OSPF runs is also called OSPF routing domain, or OSPF domain for short.

↳ OSPF Process

OSPF supports multiple instances, and each instance corresponds to an OSPF process.

One or more OSPF processes can be started on a router. Each OSPF process runs OSPF independently, and the processes are mutually isolated.

An OSPF packet header contains the Instance ID field, and multiple OSPF instances can run concurrently on a single link. The process ID is valid only on the local device.

↳ RouterID

The router ID uniquely identifies a router in an OSPF domain. Router IDs of any two routers cannot be the same.

If multiple OSPF processes exist on a router, each OSPF process uses one router ID. Router IDs of any two OSPF processes cannot be the same.

↳ Area

OSPF supports multiple areas. An OSPF domain is divided into multiple areas to ease the computing pressure of a large-scale network.

An area is a logical group of routers, and each group is identified by an area ID. The border between areas is a router. A router may belong to one area or multiple areas. One network segment (link) can belong to only one area, or each OSPF-enabled interface must belong to a specified area.

Area 0 is the backbone area, and other areas are normal areas. Normal areas must be directly connected to the backbone area.

Figure 5-3 Division of the OSPF Areas

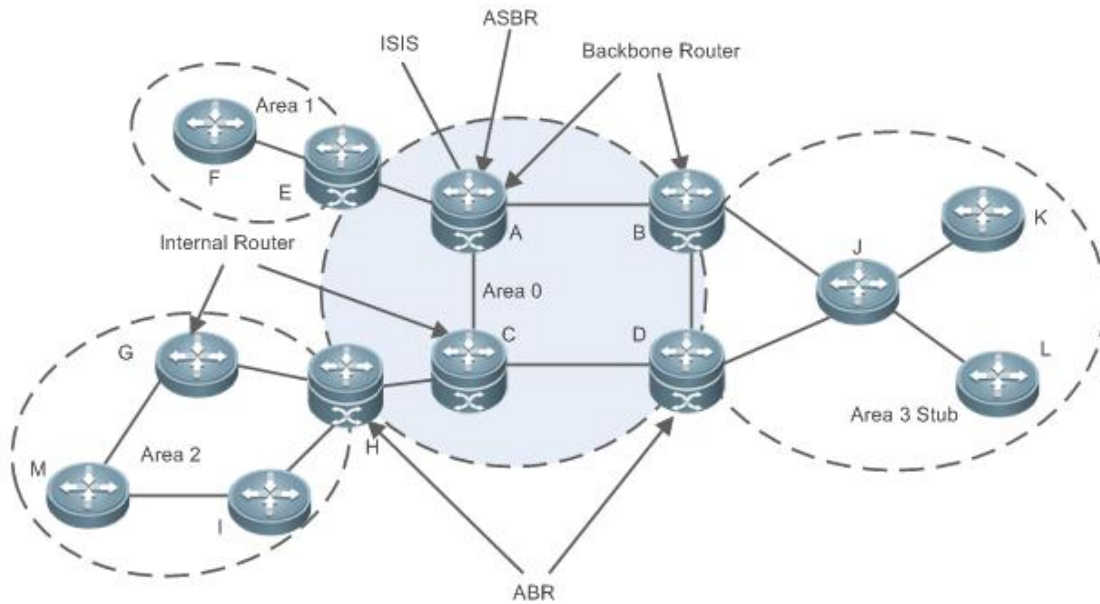

OSPF Router

The following types of routers are defined in OSPF, and assigned with different responsibilities:

- **Internal router**
All interface of an interval router belong to the same OSPF area. As shown in Figure 5-3, A, C, F, G, I, M, J, K, and L are internal routers.
- **Area border router (ABR)**
An ABR is used to connect the backbone area with a normal area. An ABR belongs to two or more areas, and one of the areas must be the backbone area. As shown in Figure 5-3, B, D, E, and H are ABRs.
- **Backbone router**
A backbone router has at least one interface that belongs to the backbone area. All ABRs and all routers in area 0 are backbone routers. As shown in Figure 5-3, A, B, C, D, E, and H are backbone routers.
- **AS boundary router (ASBR)**
An ASBR is used to exchange routing information with other ASs. An ASBR is not necessarily located on the border of an AS. It may be a router inside an area, or an ABR. As shown in Figure 5-3, A is an ASBR.

Virtual Link

OSPF supports virtual links. A virtual link is a logical link that belongs to the backbone area. It is used to resolve the problems such as a discontinuous backbone area or a failure to directly connect a normal area to the backbone area on the physical network. A virtual link supports traversal of only one normal area, and this area is called transit area. Routers on both ends of a virtual link are ABRs.

Figure 5-4 Discontinuous Backbone Area on the Physical Network

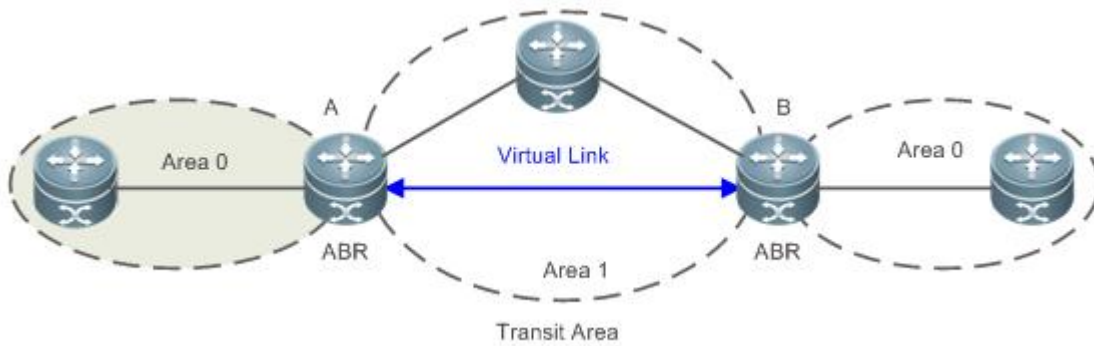

As shown in Figure 5- 4, a virtual link is set up between A and B to connect two separated parts of Area 0. Area 1 is a transit area, and A and B are ABRs of Area 1.

Figure 5- 5Failure to Directly Connect a Normal Area to the Backbone Area on the Physical Network

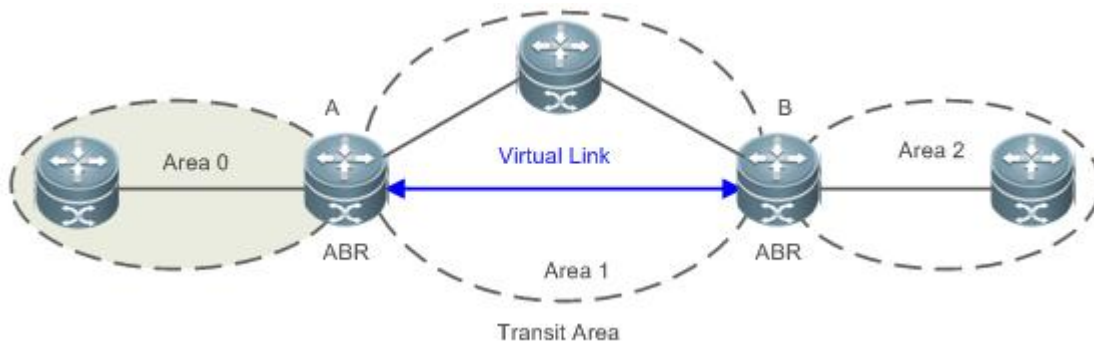

As shown in Figure 5- 5, a virtual link is set up between A and B to extend Area 0 to B so that Area 0 can be directly connected to Area 2 on B. Area 1 is a transit area, A is an ABR of Area 1, and B is an ABR of Area 0 and Area 2.

↳ LSA

OSPF describes the routing information by means of Link State Advertisement (LSA).

LSA Type	Description
Router-LSA(Type1)	This LSA is originated by every router. It describes the link state and cost of the router, and is advertised only within the area where the originating router is located.
Network-LSA(Type2)	This LSA is originated by a designated router (DR). It describes the state of the current link, and is advertised only within the area where the DR is located.
Inter-Area-Prefix-LSA(Type3)	This LSA is originated by an ABR. It describes a route to another area, and is advertised to areas except totally stub areas or Not-So-Stubby Area (NSSA) areas.
Inter-Area-Router-LSA(Type4)	This LSA is originated by an ABR. It describes a route to an ASBR, and is advertised to areas except areas where the ASBR is located.
AS-external-LSA(Type5)	This LSA is originated by an ABR. It describes a route to a destination outside the AS, and is advertised to all areas except the stub and NSSA areas.
NSSA LSA(Type7)	This LSA is originated by an ABR. It describes a route to a destination outside the AS, and is advertised only within the NASSA areas.
Link-LSA(Type8)	This LSA is originated by every router. It describes the link-local address and IPv6 prefix address of each link, and provides the link option that will be set in the Network-LSA. It advertised only on the current link.
Intra-Area-Prefix-LSA(Type9)	Every router or DR generates one or more Intra-Area-Prefix-LSAs, which are advertised in the area to which the router or DR belongs.

LSA Type	Description
	<ul style="list-style-type: none"> The Intra-Area-Prefix-LSA generated by a router describes the IPv6 prefix address associated with the Route-LSA. The Intra-Area-Prefix-LSA generated by a DR describes the IPv6 prefix address associated with the Network-LSA.

i Stub areas, NSSA areas, totally stub areas, and totally NSSA areas are special forms of normal areas and help reduce the load of routers and enhance reliability of OSPF routes.

↘ OSPF Packet

The following table lists the protocol packets used by OSPF. These OSPF packets are encapsulated in IP packets and transmitted in multicast or unicast mode.

Packet Type	Description
Hello	Hello packets are sent periodically to discover and maintain OSPF neighbor relationships.
Database Description (DD)	DD packets carry brief information about the local Link-State Database (LSDB) and are used to synchronize the LSDBs between OSPF neighbors.
Link State Request (LSR)	LSR packets are used to request the required LSAs from neighbors. LSR packets are sent only after DD packets are exchanged successfully between OSPF neighbors.
Link State Update (LSU)	LSU packets are used to send the required LSAs to peers.
Link State Acknowledgment (LSAck)	LSAck packets are used to acknowledge the received LSAs.

Overview

Feature	Description
Link-State Routing Protocols	Run OSPF on the router to obtain routes to different destinations on the network.
OSPF Route Management	Properly plan or optimize OSPF routes through manual configuration to implement management of OSPF routes.
Enhanced Security and Reliability	Use functions such as authentication and BFD correlation to enhance security, stability, and reliability of OSPF.
Network Management Functions	Use functions such as the MIB and Syslog to facilitate OSPF management.

5.3.1 Link-State Routing Protocols

OSPF is a type of link-state routing protocols. Its working process is as follows:

- Neighbor discovery → Bidirectional communication
An OSPF neighbor relationship is set up between adjacent routers, and bidirectional communication is maintained.
- Database synchronization → Full adjacency
A router uses LSAs to advertise all its link states. LSAs are exchanged between neighbors and the link state database (LSDB) is synchronized to achieve full adjacency.
- Shortest Path Tree (SPT) computation → Formation of a routing table
The router computes the shortest path to each destination network based on the LSDB and forms an OSPF routing table.

Working Principle

↘ Neighbor Discovery → Bidirectional Communication

Routers send Hello packets through all OSPF-enabled interfaces (or virtual links). If Hello packets can be exchanged between two routers, and parameters carried in the Hello packets can be successfully negotiated, the two routers become neighbors. Routers that are mutually neighbors find their own router IDs from Hello packets sent from neighbors, and bidirectional communication is set up.

A Hello packet includes, but is not limited to, the following information:

- Router ID of the originating router
- Area ID of the originating router interface (or virtual link)
- Instance ID of the originating router interface (or virtual link)
- Interface ID of the originating router interface (or virtual link)
- Priority of the originating router interface (used for DR/BDR election)
- Hello interval of the originating router interface (or virtual link)
- Neighbor dead interval of the originating router interface (or virtual link)
- IP addresses of the DR and Backup Designated Router (BDR)
- Router ID of the neighbor of the originating router

📌 Database Synchronization → Full Adjacency

After bidirectional communication is set up between neighbor routers, the DD, LSR, LSU, and LSAck packets are used to exchange LSAs and set up the adjacency. The brief process is as follows:

- A router generates an LSA to describe all link states on the router.
- The LSA is exchanged between neighbors. When a router receives the LSA from its neighbor, it copies the LSA and saves the copy in the local LSDB, and then advertises the LSA to other neighbors.
- When the router and its neighbors obtain the same LSDB, full adjacency is achieved.
- 📘 OSPF will be very quiet without changes in link costs or network addition or deletion. If any change takes place, the changed link states are advertised to quickly synchronize the LSDB.

📌 SPT Computation → Formation of a Routing Table

After the complete LSDB is obtained from the router, the Dijkstra algorithm is run to generate an SPT from the local router to each destination network. The SPT records the destination networks, next-hop addresses, and costs. OSPF generates a routing table based on the SPT.

If changes in link costs or network addition or deletion take place, the LSDB will be updated. The router again runs the Dijkstra algorithm, generates a new SPT, and updates the routing table.

- 📘 The Dijkstra algorithm is used to find a shortest path from a vertex to other vertices in a weighted directed graph.

📌 OSPF Network Types

A router does not necessarily need to exchange LSAs with every neighbor and set up an adjacency with every neighbor. To improve efficiency, OSPF classifies networks that use various link layer protocols into five types so that LSAs are exchanged in different ways to set up an adjacency:

- Broadcast
 - Neighbors are discovered, and the DR and BDR are elected.

The DR (or BDR) exchanges LSAs with all other routers to set up an adjacency. Except the DR and BDR, all other routers do not exchange LSAs with each other, and the adjacency is not set up.

Ethernet and fiber distributed data interface (FDDI) belong to the broadcast network type by default.

- Non-broadcast multiple access (NBMA)

Neighbors are manually configured, and the DR and BDR are elected.

The DR (or BDR) exchanges LSAs with all other routers to set up an adjacency. Except the DR and BDR, all other routers do not exchange LSAs with each other, and the adjacency is not set up.

X.25, frame relay, and ATM belong to NBMA networks by default.

- Point-to-point (P2P)

Neighbors are automatically discovered, and the DR or BDR is not elected.

LSAs are exchanged between routers at both ends of the link, and the adjacency is set up.

PPP, HDLC, and LAPB belong to the P2P network type by default.

- Point-to-multipoint(P2MP)

Neighbors are automatically discovered, and the DR or BDR is not elected.

LSAs are exchanged between any two routers, and the adjacency is set up.

Networks without any link layer protocol belong to the P2MP network type by default.

- P2MP broadcast

Neighbors are manually configured, and the DR or BDR is not elected.

LSAs are exchanged between any two routers, and the adjacency is set up.

Networks without any link layer protocol belong to the P2MP network type by default.

↘ OSPF Route Types

Figure 5-6

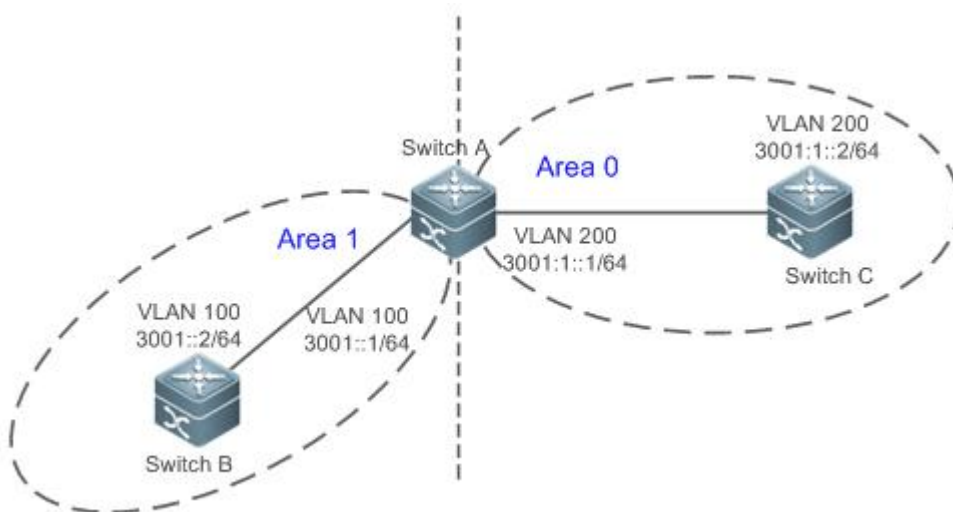

Display the OSPF routes (marked in red) in the routing table of Router C.

```
C#show ipv6 route ospf
```

IPv6 routing table name is Default(0) global scope - 7 entries

Codes: C - Connected, L - Local, S - Static, R - RIP, B - BGP

I1 - ISIS L1, I2 - ISIS L2, IA - ISIS interarea, IS - ISIS summary

O - OSPF intra area, OI - OSPF inter area, OE1 - OSPF external type 1, OE2 - OSPF external type 2

ON1 - OSPF NSSA external type 1, ON2 - OSPF NSSA external type 2

[*] - NOT in hardware forwarding table

```
L   ::1/128   via Loopback, local host
OI  3001::/64 [110/2] via FE80::21A:A9FF:FE15:4CB9, VLAN 200
C   3001:1::/64 via VLAN 200, directly connected
L   3001:1::2/128 via VLAN 200, local host
L   FE80::/10 via ::1, Null0
C   FE80::/64 via VLAN 200, directly connected
L   FE80::21A:A9FF:FE01:FB1F/128 via VLAN 200, local host
```

A mark is displayed in front of each OSPF route to indicate the type of the route. There are six types of OSPF routes:

- O: Intra-area route

This type of route describes how to arrive at a destination network in the local area. The cost of this type of route is equal to the cost of the route from the local router to the destination network.
- OI: Inter-area route

This type of route describes how to arrive at a destination network in another area. The cost of this type of route is equal to the cost of the route from the local router to the destination network.
- OE1: Type 1 external route

This type of route describes how to arrive at a destination network outside the AS. The cost of this type of route is equal to the cost of the route from the local router to the ASBR plus the cost of the route from the ASBR to the destination network. This type of route does not exist on routers in the stub or NSSA area.
- OE2: Type 2 external route

This type of route describes how to arrive at a destination network outside the AS. The cost of this type of route is equal to the cost of the route from the ASBR to the destination network. This type of route does not exist on routers in the stub or NSSA area.
- ON1: Type 1 external route of the NSSA area

This type of route describes how to arrive at a destination network outside the AS through the ASBR in the NSSA area. The cost of this type of route is equal to the cost of the route from the local router to the ASBR plus the cost of the route from the ASBR to the destination network. This type of route exists only on routers in the NSSA area.
- ON2: Type 2 external route of the NSSA area

This type of route describes how to arrive at a destination network outside the AS through the ASBR in the NSSA area. The cost of this type of route is equal to the cost of the route from the ASBR to the destination network. This type of route exists only on routers in the NSSA area.

- i** Reliability of OE2 and ON2 routes is poor. OSPF believes that the cost of the route from the ASBR to a destination outside an AS is far greater than the cost of the route to the ASBR within the AS. Therefore, when the route cost is computed, only the cost of the route from the ASBR to a destination outside an AS is considered.

Related Configuration

↘ Enabling OSPF

OSPF is disabled by default.

Run the **ipv6 router ospf 1** command to create an OSPF process on the router.

Run the **ipv6 ospf area** command to enable OSPF on an interface and specify the area ID.

Run the **area virtual-link** command to create a virtual link on the router. The virtual link can be treated as a logical interface.

↘ Router ID

By default, the OSPF process elects the largest IPv4 address among the IPv4 addresses of all the loopback interfaces as the router ID. If the loopback interfaces configured with IPv4 addresses are not available, the OSPF process elects the largest IPv4 address among the IPv4 addresses of all the physical ports as the router ID.

Alternatively, you can run the **router-id** command to manually specify the router ID.

↘ Protocol Control Parameters

Run the **ipv6 ospf hello-interval** command to modify the Hello interval on the interface. The default value is 10s (or 30s for NBMA networks).

Run the **ipv6 ospf dead-interval** command to modify the neighbor dead interval on the interface. The default value is four times the Hello interval.

Use the **poll-interval** parameter in the **ipv6 ospf neighbor** command to modify the neighbor polling interval on the NBMA interface. The default value is 120s.

Run the **ipv6 ospf transmit-delay** command to modify the LSU packet transmission delay on the interface. The default value is 1s.

Run the **ipv6 ospf retransmit-interval** command to modify the LSU packet retransmission interval on the interface. The default value is 5s.

Use the **hello-interval** parameter in the **area virtual-link** command to modify the Hello interval on the virtual link. The default value is 10s.

Use the **dead-interval** parameter in the **area virtual-link** command to modify the neighbor dead interval on the virtual link. The default value is four times the Hello interval.

Use the **transmit-delay** parameter in the **area virtual-link** command to modify the LSU packet transmission delay on the virtual link. The default value is 1s.

Use the **retransmit-interval** parameter in the **area virtual-link** command to modify the LSU packet retransmission interval on the virtual link. The default value is 5s.

Run the **timers throttle lsa all** command to modify parameters of the exponential backoff algorithm that generates LSAs. The default values of these parameters are 0 ms, 5000 ms, and 5000 ms.

Run the **timers pacing lsa-group** command to modify the LSA group update interval. The default value is 30s.

Run the **timers pacing lsa-transmit** command to modify the LS-UPD packet sending interval and the number of sent LS-UPD packets. The default values are 40 ms and 1.

Run the **timers lsa arrival** command to modify the delay after which the same LSA is received. The default value is 1000 ms.

Run the **timers throttle spf** command to modify the SPT computation delay, minimum interval between two SPT computations, and maximum interval between two SPT computations. The default values are 1000 ms, 5000 ms, and 10000 ms.

↘ OSPF Network Types

By default, Ethernet and FDDI belong to the broadcast type, X.25, frame relay, and ATM belong to the NBMA type, and PPP, HDLC, and LAPB belong to the P2P type.

Run the **ipv6 ospf network** command to manually specify the network type of an interface.

Run the **ipv6 ospf neighbor** command to manually specify a neighbor. For the NBMA and P2MP non-broadcast types, you must manually specify neighbors.

Run the **ipv6 ospf priority** command to adjust the priorities of interfaces, which are used for DR/BDR election. The DR/BDR election is required for the broadcast and NBMA types. The router with the highest priority wins in the election, and the router with the priority of 0 does not participate in the election. The default value is 1.

5.3.2 OSPF Route Management

Properly plan or optimize OSPF routes through manual configuration to implement management of OSPF routes.

Working Principle

↘ (Totally) Stub Area and (Totally) NSSA Area

The (totally) stub and (totally) NSSA areas help reduce the protocol interaction load and the size of the routing table.

- If an appropriate area is configured as a (totally) stub or NSSA area, advertisement of a large number of Type 5 and Type 3 LSAs can be avoided within the area.

Area	Type 1 and Type 2 LSAs	Type 3 LSA	Type 4 LSA	Type 5 LSA	Type 7 LSA
Non (totally) stub area and NSSA area	Allowed	Allowed	Allowed	Allowed	Not allowed
Stub area	Allowed	Allowed (containing one default route)	Not allowed	Not allowed	Not allowed
Totally stub area	Allowed	Only one default route is allowed.	Not allowed	Not allowed	Not allowed
NSSA area	Allowed	Allowed (containing one default route)	Allowed	Not allowed	Allowed
Totally NSSA area	Allowed	Only one default route is allowed.	Allowed	Not allowed	Allowed

- The ABR uses Type 3 LSAs to advertise a default route to the (totally) stub or NSSA area.
- The ABR converts Type 7 LSAs in the totally NSSA area to Type 5 LSAs, and advertise Type 5 LSAs to the backbone area.
- If an area is appropriately configured as a (totally) stub area or an NSSA area, a large number of OE1, OE2, and OI routes will not be added to the routing table of a router in the area.

Area	Routes Available in the Routing Table of a Router Inside the Area
Non (totally) stub area and NSSA area	O: a route to a destination network in the local area OI: a route to a destination network in another area OE1 or OE2: a route or default route to a destination network segment outside the AS (via any ASBR in the AS)
Stub area	O: a route to a destination network in the local area OI: a route or a default route to a destination network in another area

Area	Routes Available in the Routing Table of a Router Inside the Area
Totally stub area	O: a route to a destination network in the local area OI: a default route
NSSA area	O: a route to a destination network in the local area OI: a route or a default route to a destination network in another area ON1 or ON2: a route or default route to a destination network segment outside the AS (via an ASBR in the local area)
Totally NSSA area	O: a route to a destination network in the local area OI: a default route ON1 or ON2: a route or default route to a destination network segment outside the AS (via an ASBR in the local area)

↘ Route Redistribution

Route redistribution refers to the process of introducing routes of other routing protocols, routes of other OSPF processes, static routes, and direct routes that exist on the device to an OSPF process so that these routes can be advertised to neighbors using Type 5 and Type 7 LSAs. A default route cannot be introduced during route redistribution.

Route redistribution is often used for interworking between ASs. You can configure route redistribution on an ASBR to advertise routes outside an AS to the interior of the AS, or routes inside an AS to the exterior of the AS.

↘ Default Route Introduction

By configuring a command on an ASBR, you can introduce a default route to an OSPF process so that the route can be advertised to neighbors using Type 5 and Type 7 LSAs.

Default route introduction is often used for interworking between ASs. One default route is used to replace all the routes outside an AS.

↘ Route Summarization

Route summarization is a process of summarizing routing information with the same prefix into one route, and advertising the summarized route (replacing a large number of individual routes) to neighbors. Route summarization helps reduce the protocol interaction load and the size of the routing table.

By default, the ABR advertises inter-area routing information by using Type3 LSAs within a network segment, and advertises redistributed routing information by using Type 5 and Type 7 LSAs. If continuous network segments exist, it is recommended that you configure route summarization.

↘ Route Filtering

OSPF supports route filtering to ensure security and facilitate control when the routing information is being learned, exchanged, or used.

Using configuration commands, you can configure route filtering for the following items:

- Interface: The interface is prevented from sending routing information (any LSAs) or exchanging routing information (any LSAs) with neighbors.
- Routing information outside an AS: Only the routing information that meets the filtering conditions can be redistributed to the OSPF process (Type 5 and Type 7 LSAs).
- LSAs received by a router: In the OSPF routing table, only the routes that are computed based on the LSAs meeting the filtering conditions can be advertised.

Route Cost

If redundancy links or devices exist on the network, multiple paths may exist from the local device to the destination network. OSPF selects the path with the minimum total cost to form an OSPF route. The total cost of a path is equal to the sum of the costs of individual links along the path. The total cost of a path can be minimized by modifying the costs of individual links along the path. In this way, OSPF selects this path to form a route.

Using configuration commands, you can modify the following link costs:

- Cost from an interface to a directly connected network segment and cost from the interface to a neighbor
- Cost from an ABR to the default network segment
- Cost from an ASBR to an external network segment and cost from the ASBR to the default network segment

i Both the cost and the metric indicate the cost and are not differentiated from each other.

OSPF Administrative Distance

The administrative distance (AD) evaluates reliability of a route, and the value is an integer ranging from 0 to 255. A smaller AD value indicates that the route is more trustworthy. If multiples exist to the same destination, the route preferentially selects a route with a smaller AD value. The route with a greater AD value becomes a floating route, that is, a standby route of the optimum route.

By default, the route coming from one source corresponds to an AD value. The AD value is a local concept. Modifying the AD value affects route selection only on the current router.

Route Source	Directly-connected network	Static route	EBGP Route	OSPF Route	IS-IS Route	RIP Route	IBGP Route	Unreachable Route
Default AD	0	1	20	110	115	120	200	255

Related Configuration

Stub/NSSA Area

By default, no stub or nssa area is configured.

Run the **area stub** command to configure a specified area as a stub area.

Run the **area nssa** command to configure a specified area as a nssa area.

- i** A backbone area cannot be configured as a stub or nssa area.
- i** A transit area (with virtual links going through) cannot be configured as a stub or nssa area.
- i** An area containing an ASBR cannot be configured as a stub area.

Route Redistribution and Default Route Introduction

By default, routes are not redistributed and the default route is not introduced.

Run the **redistribute** command to configure route redistribution.

Run the **default-information originate** command to introduce a default route.

After configuring route redistribution and default route introduction, the router automatically becomes an ASBR.

Route Summarization

By default, routes are not summarized. If route summarization is configured, a discard route will be automatically added.

Run the **area range** command to summarize routes (Type 3 LSA) distributed between areas on the ABR.

Run the **summary-prefix** command to summarize redistributed routes (Type 5 and Type 7 LSAs) on the ASBR.

Route Filtering

By default, routes are not filtered.

Run the **passive-interface** command to configure a passive interface. Routing information (any LSAs) cannot be exchanged on a passive interface.

Use the **route-map** parameter in the **redistribute** command, or use the **distribute-list out** command to filter the external routing information of the AS on the ASBR. Only the routing information that meets the filtering conditions can be redistributed to the OSPF process (Type 5 LSAs).

Run the **distribute-list in** command to filter LSAs received by the router. In the OSPF routing table, only the routes that are computed based on the LSAs meeting the filtering conditions can be advertised.

Route Cost

- Cost from the interface to the directly-connected network segment (cost on the interface)

The default value is the auto cost. Auto cost = Reference bandwidth/Interface bandwidth

Run the **auto-cost reference-bandwidth** command to set the reference bandwidth of the auto cost. The default value is 100 Mbps.

Run the **ipv6 ospf cost** command to manually set the cost of the interface. The configuration priority of this item is higher than that of the auto cost.
- Cost from the interface to a specified neighbor (that is, cost from the local device to a specified neighbor)

The default value is the auto cost.

Use the **cost** parameter in the **ipv6 ospf neighbor** command to modify the cost from the interface to a specified neighbor. The configuration priority of this item is higher than that of the cost of the interface.

This configuration item is applicable only to P2MP-type interfaces.
- Cost from the ABR to the default network segment (that is, the cost of the default route that is automatically advertised by the ABR to the stub area)

The default value is 1.

Run the **area default-cost** command to modify the cost of the default route that the ABR automatically advertise to the stub or nssa areas.
- Cost from the ASBR to an external network segment (that is, the metric of an external route)

By default, the metric of a redistributed BGP route is 1, the metric of other types of redistributed routes is 20, and the route type is Type 2 External.

Run the **default-metric** command to modify the default metric of the external route.

Use the **metric,metric-type**, and **route-map** parameters in the **redistribute** command to modify the metric and route type of the external route.
- Cost from the ASBR to the default network segment (that is, the metric of the default route that is manually introduced)

By default, the metric is 1, and the route type is Type 2 External.

Use the **metric,metric-type**, and **route-map** parameters in the **default-information originate** command to modify the metric and route type of the default route that is manually introduced.
- Use the **metric** and **metric-type** parameters of **default-information originate** in the **area nssa** command to modify the metric and type of the default route that is manually introduced to the NSSA area.

➤ **OSPF Administrative Distance**

By default, the OSPF AD is 110.

Run the **distance** command to set the AD of an OSPF route.

5.3.3 Enhanced Security and Reliability

Use functions such as authentication and BFD correlation to enhance security, stability, and reliability of OSPF.

Working Principle

➤ **Authentication**

OSPFv3 uses the authentication mechanism, that is, IP authentication header (AH) and IP Encapsulating Security Payload (ESP), provided by IPv6 to prevent unauthorized routers that access the network and hosts that forge OSPF packets to participate in OSPF routing. OSPF packets received on the OSPF interface (or at both ends of a virtual link) are authenticated. If authentication fails, the packets are discarded and the adjacency cannot be set up.

Enabling authentication can avoid learning unauthenticated or invalid routes, thus preventing advertising valid routes to unauthenticated devices. In the broadcast-type network, authentication also prevents unauthenticated devices from becoming designated devices, ensuring stability of the routing system and protecting the routing system against intrusions.

➤ **MTU Verification**

On receiving a DD packet, OSPF checks whether the MTU of the neighbor interface is the same as the MTU of the local interface. If the MTU of the interface specified in the received DD packet is greater than the MTU of the interface that receives the packet, the adjacency cannot be set up. Disabling MTU verification can avoid this problem.

➤ **Two-Way Maintenance**

OSPF routers periodically send Hello packets to each other to maintain the adjacency. On a large network, a lot of packets may be sent or received, occupying too much CPU and memory. As a result, some packets are delayed or discarded. If the processing time of Hello packets exceeds the dead interval, the adjacency will be destroyed.

If the two-way maintenance function is enabled, in addition to the Hello packets, the DD, LSU, LSR, and LSAck packets can also be used to maintain the bidirectional communication between neighbors, which makes the adjacency more stable.

➤ **Concurrent neighbor Interaction Restriction**

When a router simultaneously exchanges data with multiple neighbors, its performance may be affected. If the maximum number of neighbors that concurrently initiate or accept interaction with the OSPF process, the router can interact with neighbors by batches, which ensures data forwarding and other key services.

➤ **Compatibility with Type-9 LSA with IPv6 Prefix**

By default, type-9 LSA can not have IPv6 prefix.

Run the **ipv6 router ospf compatible lsa type-9** command, the type-9 LSA generated by device will have ipv6 prefix.

➤ **GR**

The control and forwarding separated technology is widely used among routers. On a relatively stable network topology, when a GR-enabled router is restarted on the control plane, data forwarding can continue on the forwarding plane. In addition, actions (such

as adjacency re-forming and route computation) performed on the control plane do not affect functions of the forwarding plane. In this way, service interruption caused by route flapping can be avoided, thus enhancing reliability of the entire network.

Currently, the GR function is used only during active/standby switchover and system upgrade.

Figure 5- 7Normal OSPF GR Process

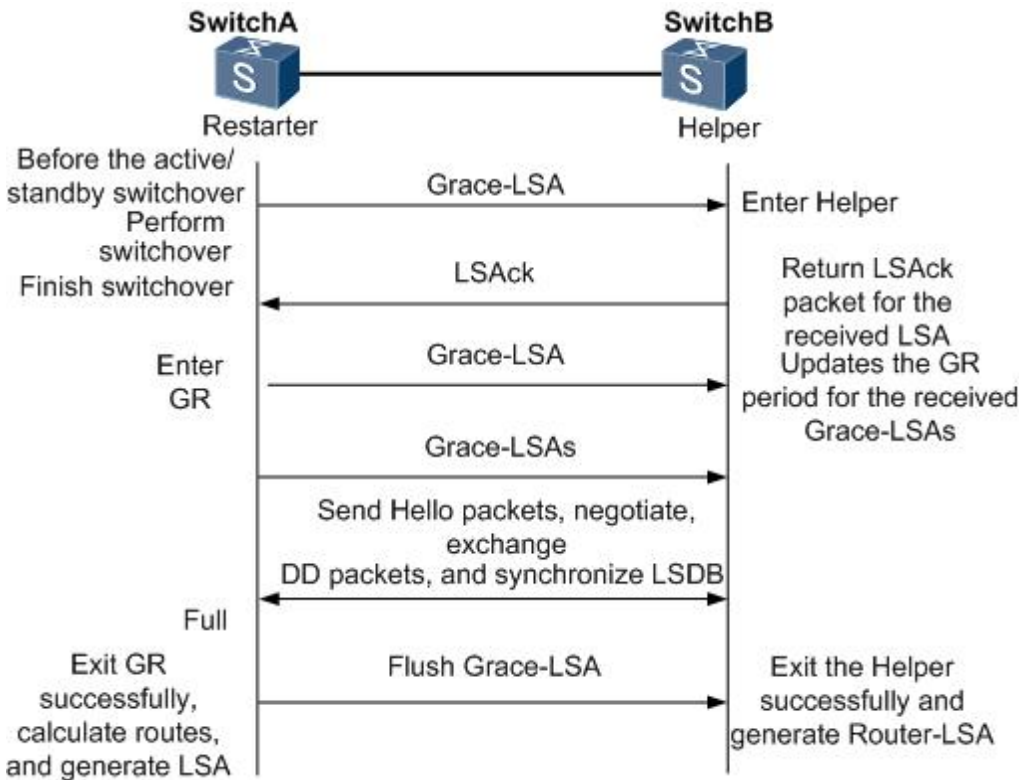

- The GR process requires collaboration between the restarter and the helper. The restarter is the router where GR occurs. The helper is a neighbor of the restarter.
- When entering or exiting the GR process, the restarter sends a Grace-LSA to the neighbor, notifying the neighbor to enter or exit the helper state.
- When the adjacency between the restarter and the helper reaches the Full state, the router can exit the GR process successfully.

📌 **Fast Hello and BFD Correlation**

After a link fault occurs, it takes a period of time (about 40s) before OSPF can sense the death of the neighbor. Then, OSPF advertises the information and re-computes the SPT. During this period, traffic is interrupted.

- After the fast Hello function is enabled (that is, the neighbor dead interval is set to 1s), OSPF can sense the death of a neighbor within 1s once a link is faulty. This greatly accelerates route convergence and prevents traffic interruption.
- BFD is used to test connectivity between devices. A link fault can be detected in as short as 150 ms. After OSPF is correlated with BFD, OSPF can sense the death of a neighbor in as short as 150 ms once a link is faulty. This greatly accelerates route convergence and prevents traffic interruption.

Related Configuration

📌 **OSPF Packet Authentication**

By default, authentication is disabled.

- Run the **area authentication** command to enable authentication in the entire area so that the authentication function takes effect on all interfaces in this area. If authentication is enabled in area 0, the function also takes effect on the virtual link.
- Run the **area encryption** command to enable encryption and authentication in the entire area so that the encryption and authentication functions take effect on all interfaces in this area. If encryption and authentication are enabled in area 0, the functions also take effect on the virtual link.
- Run the **ipv6 ospf authentication** command to enable authentication on an interface. This configuration takes precedence over the area-based configuration.
- Run the **ipv6 ospf encryption** command to enable encryption and authentication on an interface. This configuration takes precedence over the area-based configuration.
- Use the **authentication** parameter in the **area virtual-link** command to enable authentication at both ends of a virtual link. This configuration takes precedence over the area-based configuration.
- Use the **encryption** parameter in the **area virtual-link** command to enable encryption and authentication at both ends of a virtual link. This configuration takes precedence over the area-based configuration.

↘ **MTU Verification**

By default, MTU verification is disabled.

Run the **ipv6 ospf mtu-ignore** command to disable MTU verification on an interface.

↘ **Two-Way Maintenance**

By default, bidirectional maintenance is enabled.

Run the **two-way-maintain** command to enable two-way maintenance.

↘ **Concurrent neighbor Interaction Restriction**

Run the **max-concurrent-dd** command to modify the maximum number of neighbors that are concurrently interacting with the current OSPF process. The default value is 5.

Run the **ipv6 router ospf max-concurrent-dd** command to modify the maximum number of neighbors that are concurrently interacting with all OSPF processes on the router. The default value is 10.

↘ **GR**

By default, the restarter function is disabled, and the helper function is enabled.

Run the **graceful-restart** command to configure the restarter function.

Run the **graceful-restart helper** command to configure the helper function.

↘ **Fast Hello**

By default, the neighbor dead interval on the interface is 40s.

Run the **ipv6 ospf dead-interval minimal hello-multiplier** command to enable the Fast Hello function on an interface, that is, the neighbor dead interval is 1s.

↘ **Correlating OSPF with BFD**

By default, OSPF is not correlated with BFD.

Run the **bfd interval min_rx multiplier** command to set the BFD parameters.

Run the **bfd all-interfaces** command to correlate OSPF with BFD on all interfaces.

Run the **ipv6 ospf bfd** command to correlate OSPF with BFD on the current interface.

5.3.4 Network Management Functions

Use functions such as the MIB and Syslog to facilitate OSPF management.

Working Principle

↳ MIB

MIB is the device status information set maintained by a device. You can use the management program to view and set the MIB node.

Multiple OSPF processes can be simultaneously started on a router, but the OSPF MIB can be bound with only one OSPF process.

↳ Trap

A trap message is a notification generated when the system detects a fault. This message contains the related fault information.

If the trap function is enabled, the router can proactively send the trap messages to the network management device.

↳ Syslog

The Syslog records the operations (such as command configuration) performed by users on routers and specific events (such as network connection failures).

If the syslog is allowed to record the adjacency changes, the network administrator can view the logs to learn the entire process that the OSPF adjacency is set up and maintained.

Related Configuration

↳ MIB

By default, the MIB is bound with the OSPF process with the smallest process ID.

Run the **enable mib-binding** command to bind the MIB with the current OSPF process.

↳ Trap

By default, all traps functions are disabled, and the device is not allowed to send OSPF traps.

Run the **snmp-server enable traps ospf** command to allow the device to send OSPF traps.

Run the **enable traps** command to enable a specified trap function for an OSPF process.







↳ Syslog









By default, the Syslog is allowed to record the adjacency changes.

Run the **log-adj-changes** command to allow the Syslog to record the adjacency changes.

5.4 Configuration

Configuration	Description and Command
Configuring OSPF Basic Functions	(Mandatory) It is used to build an OSPF routing domain.
	ipv6routerospf Creates an OSPF process.

Configuration	Description and Command	
	router-id	Configures a router ID.
	ipv6 ospf area	Enables OSPF on an interface and specifies an area ID.
	area virtual-link	Creates a virtual link.
Setting the Network Type	 (Optional) The configurations are mandatory if the physical network is the X.25, frame relay, or ATM network.	
	ipv6 ospf network	Defines the network type.
	ipv6 ospf neighbor	Specifies a neighbor.
	ipv6 ospf priority	Configures the DR priority.
Configuring Route Redistribution and Default Route	 (Optional) The configurations are recommended if the OSPF routing domain is connected with an external network.	
	redistribute	Configures route redistribution.
	default-information originate	Introduces a default route.
Configuring the Stub/NSSA Area	 (Optional) It is used to reduce interaction of routing information and the size of routing table, and enhance stability of routes.	
	Area stub	Configures a stub area.
	Area nssa	Configures a nssa area.
Configuring Route Summarization	 (Optional) It is used to reduce interaction of routing information and the size of routing table, and enhance stability of routes.	
	arearange	Summarizes routes that are advertised between areas.
	summary-prefix	Summarizes routes that are introduced through redistribution.
Configuring Route Filtering	 (Optional) It is used to manually control interaction of routing information and filter available OSPF routes.	
	passive-interface	Configures a passive interface.
	distribute-list out	Filters routes that are introduced through redistribution.
	distribute-listin	Filters received LSAs.
Modifying the Route Cost and AD	 (Optional) It is used to manually control the shortest route computed by OSPF and determine whether to select an OSPF route preferentially.	
	auto-costreference-bandwidth	Modifies the reference bandwidth of the auto cost.
	ipv6 ospf cost	Modifies the cost in the outbound direction of an interface.
	areadefault-cost	Modifies the cost of the default route in a stub/nssa area.
	default-metric	Modifies the default metric of a redistributed route.
	distance	Modifies the OSPF AD.
Enabling Authentication	 (Optional) It is used to prevent routers that illegally access the network and hosts that forge OSPF	

Configuration	Description and Command	
	packets from participating in the OSPF protocol process.	
	areaauthentication	Enables authentication and sets the authentication mode in an area.
	areaencryption	Enables encryption and authentication and sets the authentication mode in an area.
	ipv6 ospf authentication	Enables authentication and sets the authentication mode on an interface.
	ipv6 ospf encryption	Enables encryption and authentication and sets the authentication mode on an interface.
Modifying the Maximum Number of Concurrent Neighbors	 (Optional) It is used to prevent the problem of performance deterioration caused by over-consumption of the CPU.	
	max-concurrent-dd	Modifies the maximum number of concurrent neighbors on the current OSPF process.
	ipv6 router ospf max-concurrent-dd	Modifies the maximum number of concurrent neighbors on all OSPF processes.
Disabling MTU Verification	 (Optional) It is used to prevent the problem that the adjacency cannot be set up due to MTU inconsistency on the neighbor interface.	
	ipv6 ospf mtu-ignore	Disables MTU verification on an interface.
Enabling Two-Way Maintenance	 (Optional) It is used to prevent termination of the adjacency due to the delay or loss of Hello packets.	
	two-way-maintain	Enables two-way maintenance.
Enabling GR	 (Optional) It is used to retain OSPF routing forwarding during restart or active/standby switchover of the OSPF processes to prevent traffic interruption.	
	graceful-restart	Enables the restarter function.
	graceful-restart helper	Enables the helper function.
Enabling Fast Hello	 (Optional) It is used to quickly discover the death of a neighbor to prevent traffic interruption when a link is faulty.	
	ipv6 ospf dead-intervalminimal hello-multiplier	Enabling the Fast Hello function on an interface.
Enabling GR	 (Optional) It is used to retain OSPF routing forwarding during restart or active/standby switchover of the OSPF processes to prevent traffic interruption.	
	graceful-restart	Enables the restarter function.
	graceful-restart helper	Enables the helper function.
Enabling NSR	 (Optional) It is used to maintain OSPF route forwarding and prevent traffic interruption during an OSPF process restart or active/standby switchover.	
	nsr	Enables the NSR function.
Correlating OSPF with BFD	 (Optional) It is used to quickly discover the death of a neighbor to prevent traffic interruption when a link is faulty.	
	bfd all-interfaces	Correlates OSPF with BFD on all interfaces.
	ipv6 ospf bfd	Correlates OSPF with BFD on the current interface.

Configuration	Description and Command	
Configuring Network Management Functions	(Optional) The configurations enable users to use the SNMP network management software to manage OSPF.	
	enable mib-binding	Bind MIB to the OSPF process.
	enable traps	Enables the trap function of the OSPF process.
	log-adj-changes	Allows the syslogs to record the changes in adjacency status.
Modifying Protocol Control Parameters	(Optional) You are advised not to modify protocol control parameters unless necessary.	
	ipv6 ospf hello-interval	Modifies the Hello interval on an interface.
	ipv6 ospf dead-interval	Modifies the neighbor death interval on an interface.
	ipv6 ospf transmit-delay	Modifies the LSU packet transmission delay on an interface.
	ipv6 ospf retransmit-interval	Modifies the LSU packet retransmission interval on an interface.
	timers throttle lsa all	Modifies parameters of the exponential backoff algorithm that generates LSAs.
	timers pacing lsa-group	Modifies the LSA group update interval.
	timers pacing lsa-transmit	Modifies the LS-UPD packet sending interval.
	timers lsa arrival	Modifies the delay after which the same LSA is received.
	timers throttlespf	Modifies the SPT computation timer.
	timers throttle route inter-area	Modifies the inter-area route computation delay.
timers throttle route ase	Modifies the inter-area route computation delay.	

5.4.1 Configuring OSPF Basic Functions

Configuration Effect

- Set up an OSPF routing domain on the network to provide IPv6 unicast routing service for users on the network.

Notes

- Ensure that the IPv6 routing function is enabled, that is, **ipv6 routing** is not disabled; otherwise, OSPF cannot be enabled.
- IPv6 must be enabled on the interface.
- It is strongly recommended that you manually configure the router ID.

Configuration Steps

➤ Creating an OSPF Process

- Mandatory.
- The configuration is mandatory for every router.

➤ Configuring a Router ID

- (Optional) It is strongly recommended that you manually configure the router ID.
- If the router ID is not configured, OSPF selects an interface IP address. If the IP address is not configured for any interface, or the configured IP addresses have been used by other OSPF instances, you must manually configure the router ID.

➤ **Enabling OSPF on an Interface and Specifying an Area ID**

- Mandatory.
- The configuration is mandatory for every router.

Verification

- Run the **show ipv6 route ospf** command to verify that the entries of the OSPF routing table are correctly loaded.
- Run the **ping** command to verify that the IPv6 unicast service is correctly configured.

Related Commands

➤ **Creating an OSPF Process**

Command	ipv6 router ospf <i>process-id</i> [<i>vrfvrf-name</i>]
Parameter	<i>process-id</i> : Indicates the OSPFv3 process ID. If the process ID is not specified, process 1 is enabled.
Description	<i>vrf-name</i> : Specifies the VPN routing and forwarding (VRF) to which the OSPFv3 process belongs.
Command Mode	Global configuration mode
Usage Guide	After enabling the OSPFv3 process, the device enters the routing process configuration mode.

➤ **Configuring a Router ID**

Command	router-id <i>router-id</i>
Parameter Description	<i>router-id</i> : Indicates the ID of the device, which is expressed in the IPv4 address.
Command Mode	OSPF routing process configuration mode
Usage Guide	Every device where OSPFv3 run must be identified by using a router ID. You can configure any IPv4 address as the router ID of the device, and ensure that the router ID is unique in an AS. If multiple OSPFv3 processes run on the same device, the router ID of each process must also be unique. After the router ID changes, OSPF performs a lot of internal processing. Therefore, you are advised not to change the router ID unless necessary. When an attempt is made to modify the router ID, a prompt is displayed, requesting you to confirm the modification. After the OSPFv3 process is enabled, you are advised to specify the router ID before configuring other parameters of the process.

➤ **Enabling OSPF on an Interface and Specifying an Area ID**

Command	ipv6 ospf <i>process-id</i> area <i>area-id</i> [instance <i>instance-id</i>]
Parameter Description	<i>process-id</i> : Indicates the ID of an OSPFv3 process. The value ranges from 1 to 65,535. Area <i>area-id</i> : Indicates the ID of the OSPFv3 area in which the interface participates. It can be an integer or an IPv4 prefix. Instance <i>instance-id</i> : Indicates the ID of a specified OSPFv3 process of the interface. The value ranges from 0 to 255.
Command Mode	Interface configuration mode

Usage Guide	<p>Run this command in interface configuration mode to enable the interface to participate in OSPFv3, and then run the ipv6 router ospf command to configure the OSPFv3 process. After the OSPFv3 process is configured, the interface will automatically participate in the related process.</p> <p>Run the no ipv6 ospf area command so that the specified interface no longer participates in the OSPFv3 routing process.</p> <p>Run the no ipv6 router ospf command so that all interfaces no longer participate in the OSPFv3 routing process.</p> <p>The adjacency can be set up only between devices with the same <i>instance-id</i>.</p> <p>After this command is configured, all prefix information on the interface will participate in the OSPFv3 process.</p>
--------------------	---

📌 **Creating a Virtual Link**

Command	<pre>area area-id virtual-link router-id [hello-interval seconds] [dead-interval seconds] [retransmit-interval seconds] [transmit-delay seconds] [instance instance-id] [authentication ipsec spi spi [md5 sha1] [0 7] key] [encryption ipsec spi spi esp null [md5 sha1] [0 7] key]</pre>
Parameter Description	<p>area-id: Indicates the ID of the area where the virtual link is located. It can be an integer or an IPv4 prefix.</p> <p>router-id: Indicates the router ID of the neighbor connected to the virtual link.</p> <p>dead-interval seconds: Indicates the time that the local interface of the virtual link detects the failure of the neighbor. The unit is second. The value ranges from 1 to 65,535.</p> <p>hello-interval seconds: Indicates the time that the Hello packet is sent on the local interface of the virtual link. The unit is second. The value ranges from 1 to 65,535.</p> <p>retransmit-interval seconds: Indicates the interval at which the LSA is retransmitted on the local interface of the virtual link. The unit is second. The value ranges from 1 to 65,535.</p> <p>transmit-delay seconds: Indicates the delay after which the LSA is sent on the local interface of the virtual link. The unit is second. The value ranges from 1 to 65,535.</p> <p>instance instance-id: Indicates the ID of the instance corresponding to the virtual link. The value ranges from 0 to 255. A virtual link cannot be set up between devices with different instance IDs.</p> <p>spi: Indicates the security parameter index (SPI). The value ranges from 256 to 4,294,967,295.</p> <p>md5: Enables message digest 5 (MD5) authentication.</p> <p>sha1: Enables Secure Hash Algorithm 1 (SHA1) authentication.</p> <p>0: Indicates that the key is displayed in plain text.</p> <p>7: Indicates that the key is displayed in cipher text.</p> <p>key: Indicates the authentication key.</p> <p>null: Indicates that no encryption mode is used.</p>
Command Mode	OSPF routing process configuration mode
Usage Guide	<p>In an OSPFv3 AS, all areas must be connected to the backbone area to properly learn the routing information of the entire OSPFv3 AS. If an area cannot be directly connected to the backbone area, the virtual link can be used to connect this area to the backbone area.</p> <p>The area where the virtual link is located cannot be a stub or nssa area.</p> <p>At both ends of neighbors between which the virtual link is set up, settings of hello-interval, dead-interval, and instance must be consistent; otherwise, the adjacency cannot be set up properly.</p>

Configuration Example

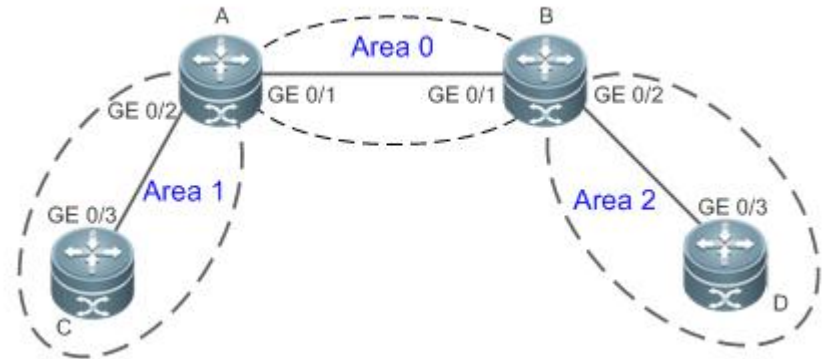
<p>Scenario Figure 5-8</p>	 <table border="1" data-bbox="329 604 1411 806"> <thead> <tr> <th>Remarks</th> <th>The interface IP addresses are as follows:</th> </tr> </thead> <tbody> <tr> <td></td> <td>A: GE 0/1 2001:1::1/64 GE 0/2 2001:2::1/64</td> </tr> <tr> <td></td> <td>B: GE 0/1 2001:1::2/64 GE 0/2 2001:3::1/64</td> </tr> <tr> <td></td> <td>C: GE 0/3 2001:2::2/64</td> </tr> <tr> <td></td> <td>D: GE 0/3 2001:3::2/64</td> </tr> </tbody> </table>	Remarks	The interface IP addresses are as follows:		A: GE 0/1 2001:1::1/64 GE 0/2 2001:2::1/64		B: GE 0/1 2001:1::2/64 GE 0/2 2001:3::1/64		C: GE 0/3 2001:2::2/64		D: GE 0/3 2001:3::2/64
Remarks	The interface IP addresses are as follows:										
	A: GE 0/1 2001:1::1/64 GE 0/2 2001:2::1/64										
	B: GE 0/1 2001:1::2/64 GE 0/2 2001:3::1/64										
	C: GE 0/3 2001:2::2/64										
	D: GE 0/3 2001:3::2/64										
<p>Configuration Steps</p>	<ul style="list-style-type: none"> ● Configure the interface IP addresses on all routers. ● Enable the IPv4 unicast routing function on all routers. (This function is enabled by default.) ● Configure the OSPF instances and router IDs on all routers. ● Enable OSPF on the interfaces configured on all routers. 										
<p>A</p>	<pre> A#configure terminal A(config)#interface GigabitEthernet 0/1 A(config-if-GigabitEthernet 0/1)#ipv6 enable A(config-if-GigabitEthernet 0/1)#ipv6 address 2001:1::1/64 A(config-if-GigabitEthernet 0/1)#ipv6 ospf 1 area 0 A(config-if-GigabitEthernet 0/1)#exit A(config)#interface GigabitEthernet 0/2 A(config-if-GigabitEthernet 0/2)#ipv6 enable A(config-if-GigabitEthernet 0/2)#ipv6 address 2001:2::1/64 A(config-if-GigabitEthernet 0/2)#ipv6 ospf 1 area 1 A(config-if-GigabitEthernet 0/2)#exit A(config)#ipv6 router ospf 1 A(config-router)#router-id 1.1.1.1 </pre>										
<p>B</p>	<pre> B#configure terminal B(config)#interface GigabitEthernet 0/1 B(config-if-GigabitEthernet 0/1)#ipv6 enable B(config-if-GigabitEthernet 0/1)#ipv6 address 2001:1::2/64 B(config-if-GigabitEthernet 0/1)#ipv6 ospf 1 area 0 B(config-if-GigabitEthernet 0/1)#exit </pre>										

	<pre>B(config)#interface GigabitEthernet 0/2 B(config-if-GigabitEthernet 0/2)#ipv6 enable B(config-if-GigabitEthernet 0/2)#ipv6 address 2001:3::1/64 B(config-if-GigabitEthernet 0/2)#ipv6 ospf 1 area 2 B(config-if-GigabitEthernet 0/2)#exit B(config)#ipv6 router ospf 1 B(config-router)#router-id2.2.2.2</pre>
C	<pre>C#configure terminal C(config)#interface GigabitEthernet 0/3 C(config-if-GigabitEthernet 0/3)#ipv6 enable C(config-if-GigabitEthernet 0/3)#ipv6 address 2001:2::2/64 C(config-if-GigabitEthernet 0/3)#ipv6 ospf 1 area 1 C(config-if-GigabitEthernet 0/3)#exit C(config)#ipv6 router ospf 1 C(config-router)#router-id3.3.3.3</pre>
D	<pre>D#configure terminal D(config)#interface GigabitEthernet 0/3 D(config-if-GigabitEthernet 0/3)#ipv6 enable D(config-if-GigabitEthernet 0/3)#ipv6 address 2001:4::2/64 D(config-if-GigabitEthernet 0/3)#ipv6 ospf 1 area 2 D(config-if-GigabitEthernet 0/3)#exit D(config)#ipv6 router ospf 1 D(config-router)#router-id4.4.4.4</pre>
Verification	<ul style="list-style-type: none"> ● Verify that the OSPF neighbors are correct on all routers. ● Verify that the routing table is correctly loaded on all routers. ● Verify that 2001:2::2/64 can be pinged successfully on Router D.
A	<pre>A#show ipv6 ospf neighbor OSPFv3 Process (1), 1 Neighbors, 1 is Full: Neighbor ID Pri State Dead Time Instance ID Interface 2.2.2.2 1 Full/BDR 00:00:30 0 GigabitEthernet 0/1 3.3.3.31 Full/BDR 00:00:35 0 GigabitEthernet 0/2 A#show ipv6 route ospf</pre>

	<p>IPv6 routing table name - Default - 0 entries</p> <p>Codes: C - Connected, L - Local, S - Static</p> <p>R - RIP, O - OSPF, B - BGP, I - IS-IS, V - Overflow route</p> <p>N1 - OSPF NSSA external type 1, N2 - OSPF NSSA external type 2</p> <p>E1 - OSPF external type 1, E2 - OSPF external type 2</p> <p>SU - IS-IS summary, L1 - IS-IS level-1, L2 - IS-IS level-2</p> <p>IA - Inter area</p> <p>O IA2001:3::/64 [110/20] via FE80::2D0:F8FF:FE22:4524, GigabitEthernet 0/1</p>																		
<p>B</p>	<p>B# show ipv6 ospf neighbor</p> <p>OSPFv3 Process (1), 1 Neighbors, 1 is Full:</p> <table border="1"> <thead> <tr> <th>Neighbor ID</th> <th>Pri</th> <th>State</th> <th>Dead Time</th> <th>Instance ID</th> <th>Interface</th> </tr> </thead> <tbody> <tr> <td>1.1.1.11</td> <td>Full/DR</td> <td>00:00:30</td> <td>0</td> <td></td> <td>GigabitEthernet 0/1</td> </tr> <tr> <td>4.4.4.41</td> <td>Full/BDR</td> <td>00:00:35</td> <td>0</td> <td></td> <td>GigabitEthernet 0/2</td> </tr> </tbody> </table> <p>B#show ipv6 route ospf</p> <p>IPv6 routing table name - Default - 0 entries</p> <p>Codes: C - Connected, L - Local, S - Static</p> <p>R - RIP, O - OSPF, B - BGP, I - IS-IS, V - Overflow route</p> <p>N1 - OSPF NSSA external type 1, N2 - OSPF NSSA external type 2</p> <p>E1 - OSPF external type 1, E2 - OSPF external type 2</p> <p>SU - IS-IS summary, L1 - IS-IS level-1, L2 - IS-IS level-2</p> <p>IA - Inter area</p> <p>O IA2001:2::/64 [110/20] via FE80::2D0:F8FF:FE22:4536, GigabitEthernet 0/1</p>	Neighbor ID	Pri	State	Dead Time	Instance ID	Interface	1.1.1.11	Full/DR	00:00:30	0		GigabitEthernet 0/1	4.4.4.41	Full/BDR	00:00:35	0		GigabitEthernet 0/2
Neighbor ID	Pri	State	Dead Time	Instance ID	Interface														
1.1.1.11	Full/DR	00:00:30	0		GigabitEthernet 0/1														
4.4.4.41	Full/BDR	00:00:35	0		GigabitEthernet 0/2														
<p>C</p>	<p>C# show ipv6 ospf neighbor</p> <p>OSPFv3 Process (1), 1 Neighbors, 1 is Full:</p> <table border="1"> <thead> <tr> <th>Neighbor ID</th> <th>Pri</th> <th>State</th> <th>Dead Time</th> <th>Instance ID</th> <th>Interface</th> </tr> </thead> <tbody> <tr> <td>1.1.1.11</td> <td>Full/DR</td> <td>00:00:30</td> <td>0</td> <td></td> <td>GigabitEthernet 0/3</td> </tr> </tbody> </table> <p>C#show ipv6 route ospf</p>	Neighbor ID	Pri	State	Dead Time	Instance ID	Interface	1.1.1.11	Full/DR	00:00:30	0		GigabitEthernet 0/3						
Neighbor ID	Pri	State	Dead Time	Instance ID	Interface														
1.1.1.11	Full/DR	00:00:30	0		GigabitEthernet 0/3														

	<p>IPv6 routing table name - Default - 0 entries</p> <p>Codes: C - Connected, L - Local, S - Static</p> <p>R - RIP, O - OSPF, B - BGP, I - IS-IS, V - Overflow route</p> <p>N1 - OSPF NSSA external type 1, N2 - OSPF NSSA external type 2</p> <p>E1 - OSPF external type 1, E2 - OSPF external type 2</p> <p>SU - IS-IS summary, L1 - IS-IS level-1, L2 - IS-IS level-2</p> <p>IA - Inter area</p> <p>O IA2001:1::/64 [110/2] via FE80::2D0:F8FF:FE22:4537, GigabitEthernet 0/3</p> <p>O IA2001:3::/64 [110/3] via FE80::2D0:F8FF:FE22:4537, GigabitEthernet 0/3</p>
<p>D</p>	<pre> D# show ipv6 ospf neighbor OSPFv3 Process (1), 1 Neighbors, 1 is Full: Neighbor ID Pri State Dead Time Instance ID Interface 2.2.2.2 1 Full/DR 00:00:30 0 GigabitEthernet 0/3 D#show ipv6 route ospf IPv6 routing table name - Default - 0 entries Codes: C - Connected, L - Local, S - Static R - RIP, O - OSPF, B - BGP, I - IS-IS, V - Overflow route N1 - OSPF NSSA external type 1, N2 - OSPF NSSA external type 2 E1 - OSPF external type 1, E2 - OSPF external type 2 SU - IS-IS summary, L1 - IS-IS level-1, L2 - IS-IS level-2 IA - Inter area O IA2001:1::/64 [110/2] via FE80::2D0:F8FF:FE22:4547, GigabitEthernet 0/3 O IA2001:2::/64 [110/3] via FE80::2D0:F8FF:FE22:4547, GigabitEthernet 0/3 D# D#ping 2001:2::2 Sending 5, 100-byte ICMP Echoes to 2001:2::2, timeout is 2 seconds: < press Ctrl+C to break > !!!! Success rate is 100 percent (5/5), round-trip min/avg/max = 5/9/14 ms. </pre>

Common Errors

- IPv6 is disabled on the interface.
- OSPF cannot be enabled because the IPv6 unicast routing function is disabled.
- The area IDs enabled on adjacent interfaces are inconsistent.
- The same router ID is configured on multiple routers, resulting in a router ID conflict.

5.4.2 Setting the Network Type

Configuration Effect

- If the physical network is X.25, Frame Relay, or ATM, OSPF can also run to provide the IPv6 unicast routing service.

Notes

- The OSPF basic functions must be configured.
- The broadcast network sends multicast OSPF packets, automatically discovers neighbors, and elects a DR and a BDR.
- The P2P network sends multicast OSPF packets and automatically discovers neighbors.
- The NBMA network sends unicast OSPF packets. Neighbors must be manually specified, and a DR and a BDR must be elected.
- The P2MP network (without carrying the **non-broadcast** parameter) sends multicast OSPF packets. Neighbors are automatically discovered.
- The P2MP network (carrying the **non-broadcast** parameter) sends unicast OSPF packets. Neighbors must be manually specified.

Configuration Steps

▾ Configuring the Interface Network Type

- Optional.
- Perform this configuration on routers at both ends of the link.

▾ Configuring a Neighbor

- (Optional) If the interface network type is set to NBMA or P2MP (carrying the **non-broadcast** parameter), neighbors must be configured.
- Neighbors are configured on routers at both ends of the NBMA or P2MP (carrying the **non-broadcast** parameter) network.

▾ Configuring the Interface Priority

- (Optional) You must configure the interface priority if a router must be specified as a DR, or a router cannot be specified as a DR.
- Configure the interface priority on a router that must be specified as a DR, or cannot be specified as a DR.

Verification

- Run the **show ipv6 ospf interface** command to verify that the network type of each interface is correct.

Related Commands

▾ Configuring the Interface Network Type

Command	<code>ipv6 ospf network {broadcast non-broadcast point-to-point </code>
---------	--

	point-to-multipoint [non-broadcast]][instanceinstance-id]
Parameter Description	<p>broadcast: Indicates the broadcast network type.</p> <p>non-broadcast: Indicates the non-broadcast network type.</p> <p>point-to-multipoint: Indicates the point-to-multipoint (P2MP) network type.</p> <p>point-to-multipoint non-broadcast: Indicates the P2MP non-broadcast network type.</p> <p>point-to-point: Indicates the point-to-point (P2P) network type.</p> <p>instanceinstance-id: Indicates the ID of a specified OSPFv3 process of the interface. The value ranges from 0 to 255.</p>
Command Mode	Interface configuration mode
Usage Guide	You can configure the network type of an interface based on the actual link type and topology.

↘ **Configuring a Neighbor**

Command	ipv6 ospf neighbor ipv6-address{ [costcost] [poll-intervalseconds priorityvalue] }[instanceinstance-id]
Parameter Description	<p><i>ip-address:</i> Indicates the link address of the neighbor interface.</p> <p>costcost: Indicates the cost required from the P2MP network to each neighbor. The cost is not defined by default. The cost configured on the interface is used. The value ranges from 1 to 65,535. Only a P2MP network supports this option.</p> <p>poll-interval seconds: Indicates the neighbor polling interval. The unit is second. The value ranges from 1 to 2,147,483,647. Only the non-broadcast (NBMA) network supports this option.</p> <p>priority value: Indicates the priority value of the non-broadcast network neighbor. The value ranges from 0 to 255. Only the non-broadcast network (NBMA) supports this option.</p> <p>instanceinstance-id: Indicates the ID of a specified OSPFv3 process of the interface. The value ranges from 0 to 255.</p>
Command Mode	Interface configuration mode
Usage Guide	You can configure neighbor parameters based on the actual network type.

↘ **Configuring the Interface Priority**

Command	ipv6 ospf priority number-value[instanceinstance-id]
Parameter Description	<p><i>number-value:</i> Indicates the priority of the interface. The value ranges from 0 to 255.</p> <p>instanceinstance-id: Indicates the ID of a specified OSPFv3 process of the interface. The value ranges from 0 to 255.</p>
Command Mode	Interface configuration mode
Usage Guide	<p>On a broadcast network, a DR or BDR must be elected. During the DR/BDR election, the device with a higher priority will be preferentially elected as a DR or BDR. If the priority is the same, the device with a larger router ID will be preferentially elected as a DR or BDR.</p> <p>A device with the priority 0 does not participate in the DR/BDR election.</p>

Configuration Example

↘ **Configuring the Interface Network Type**

<p>Scenario Figure 5-9</p>	
<p>Configuration Steps</p>	<ul style="list-style-type: none"> ● Enable IPv6 on interfaces of all routers. ● Configure the OSPF basic functions on all routers. ● Set the interface network type to P2MP on all routers.
<p>A</p>	<pre>A#configure terminal A(config)# interface Serial1/0 A(config-Serial1/0)# encapsulation frame-relay A(config-Serial1/0)# ipv6 ospf network point-to-multipoint</pre>
<p>B</p>	<pre>B#configure terminal B(config)# interface Serial1/0 B(config-Serial1/0)# encapsulation frame-relay B(config-Serial1/0)# ipv6 ospf network point-to-multipoint</pre>
<p>C</p>	<pre>C#configure terminal C(config)# interface Serial1/0 C(config-Serial1/0)# encapsulation frame-relay C(config-Serial1/0)# ipv6 ospf network point-to-multipoint</pre>
<p>Verification</p>	<ul style="list-style-type: none"> ● Verify that the interface network type is P2MP.

A	<pre> A#show ipv6 ospf interface Serial1/0 Serial1/0 is up, line protocol is up Interface ID 2 IPv6 Prefixes fe80::2d0:f8ff:fe22:3346/64 (Link-Local Address) OSPFv3 Process (1), Area 0.0.0.1, Instance ID 0 Router ID 192.168.22.30,Network Type POINTOMULTIPOINT, Cost: 1 Transmit Delay is 1 sec, State Point-To-Point, Priority 1 Timer interval configured, Hello 30, Dead 120, Wait 40, Retransmit 10 Hello due in 00:00:06 Neighbor Count is 1, Adjacent neighbor count is 1 Hello received 40 sent 40, DD received 17 sent 9 LS-Req received 1 sent 3, LS-Upd received 6 sent 5 LS-Ack received 3 sent 4, Discarded 1 </pre>
----------	--

Common Errors

- The network types configured on interfaces at two ends are inconsistent, causing abnormal route learning.
- The network type is set to NBMA or P2MP (non-broadcast), but neighbors are not specified.

5.4.3 Configuring Route Redistribution and Default Route

Configuration Effect

- Introduce unicast routes for other AS domains to the OSPF domain to provide the unicast routing service to other AS domains for users in the OSPF domain.
- In the OSPF domain, inject a default route to another AS domain so that the unicast routing service to another AS domain can be provided for users in the OSPF domain.

Notes

- The OSPF basic functions must be configured.

Configuration Steps

↘ Configuring External Route Redistribution

- (Optional) This configuration is mandatory if external routes of the OSPF domain should be introduced to the ASBR.
- Perform this configuration on an ASBR.

↘ Generating a Default Route

- (Optional) Perform this configuration if the default route should be introduced to an ASBR so that other routers in the OSPF domain access other AS domains through this ASBR by default.

- Perform this configuration on an ASBR.

Verification

- On a router inside the OSPF domain, run the **show ipv6 route ospf** command to verify that the unicast routes to other AS domains are loaded.
- On a router inside the OSPF domain, run the **show ipv6 route ospf** command to verify that the default route to the ASBR is loaded.
- Run the **ping** command to verify that the IPv6 unicast service to other AS domains is correct.

Related Commands

↘ **Configuring Route Redistribution**

Command	redistribute { bgp connected [<i>isis</i> [<i>area-tag</i>] <i>ospf</i> <i>process-id</i>] rip static }[level-1 level-1-2 level-2] match { internal external [1 2] nssa-external [1 2]} metric <i>metric-value</i> [metric-type { 1 2 }] route-map <i>route-map-name</i> [tag <i>tag-value</i>]
Parameter Description	<p>bgp: Indicates redistribution from BGP.</p> <p>connected: Indicates redistribution from direct routes.</p> <p>isis [<i>area-tag</i>]: Indicates redistribution from IS-IS.area-tag specifies the IS-IS instance.</p> <p>ospf<i>process-id</i>: Indicates redistribution from OSPF.process-id specifies an OSPF instance. The value ranges from 1 to 65535. 1-65535</p> <p>rip: Indicates redistribution from RIP.</p> <p>static: Indicates redistribution from static routes.</p> <p>level-1 level-1-2 level-2: Used only when IS-IS routes are redistributed. Only the routes of the specified level are redistributed. By default, only level-2 IS-IS routes can be redistributed.</p> <p>match: Used only when OSPF routes are redistributed. Only the routes that match the specified criteria are redistributed. By default, all OSPF routes can be redistributed.</p> <p>metric<i>metric-value</i>: Indicates the metric of the OSPF external LSA. <i>metric-value</i> specifies the size of the metric. The value ranges from 0 to 16,777,214.</p> <p>metric-type {1 2}: Indicates the external route type, which can be E-1 or E-2.</p> <p>route-map<i>route-map-name</i>: Sets the redistribution filtering rules.</p> <p>tag<i>tag-value</i>: Specifies the tag value of the route that is redistributed into the OSPF routing domain. The value ranges from 0 to 4294967295.</p>
Command Mode	OSPF routing process configuration mode
Usage Guide	<p>When the device supports multiple routing protocols, collaboration between protocols is very important. To run multiple routing protocols concurrently, the device must be able to redistribute routing information of a protocol to another protocol. This applies to all routing protocols.</p> <p>During redistribution of IS-IS routes, level-1,level-2, or level-1-2 can be configured to indicate that IS-IS routes of the specified level(s) will be redistributed. By default, IS-IS routes of level 2 are redistributed.</p> <p>During redistribution of OSPFv3 routes, match can be configured to indicate that OSPFv3 routes of the specified sub-type will be redistributed. By default, all types of OSPFv3 routes are redistributed.</p> <p>For the level parameter configured during redistribution of IS-IS routes and the match parameter configured during redistribution of OSPFv3 routes, the routes are matched against the route map only when the sub-type of the routes are correct.</p>

	<p>During configuration of route redistribution, the match rules configured in route map configuration mode are used based on the original information of routes. The priorities of tag, metric and metric-type in the route redistribution configuration are lower than the priority of the set rules configured in route map configuration mode.</p> <p>The set metric value of the associated route map should fall into the range of 0 to 16,777,214. If the value exceeds this range, routes cannot be introduced.</p> <p>The configuration rules for the no form of the redistribute command are as follows:</p> <ol style="list-style-type: none"> 1. If some parameters are specified in the no form of the command, default values of these parameters will be restored. 2. If no parameter is specified in the no form of the command, the entire command will be deleted. <p>For example, if redistribute isis 112 level-2 is configured, the no redistribute isis 112 level-2 command only restores the default value of level-2. As level-2 itself is the default value of the parameter, the configuration saved is still redistribute isis 112 level-2 after the preceding no form of the command is executed. To delete the entire command, you need to run the no redistribute isis 112 command.</p>
--	--

↘ **Introducing a Default Route**

Command	default-information originate [always] [metric <i>metric</i>] [metric-type <i>type</i>] [route-map <i>map</i>]
Parameter Description	<p>always: Enables OSPF to generate a default route regardless of whether the local router has a default route.</p> <p>metric <i>metric</i>: Indicates the initial metric of the default route. The value ranges from 0 to 16,777,214. By default, the metric of the default route is 1.</p> <p>metric-type <i>type</i>: Indicates the type of the default route. OSPF external routes are classified into two types: Type 1: The metric varies with routers; Type 2: The metric is the same for all routers. Type 1 external routes are more trustworthy than Type 2 external routes.</p> <p>route-map <i>map-name</i>: Indicates the associated route-map name. By default, no route-map is associated.</p>
Command Mode	OSPF routing process configuration mode
Usage Guide	<p>When the redistribute or default-information command is executed, the OSPFv3-enabled router automatically becomes an ASBR.</p> <p>The ASBR, however, does not automatically generate or advertise a default route to all routers in the OSPF routing domain. To have the ASBR generate a default route, configure the default-information originate command.</p> <p>If always is specified, the OSPFv3 process advertises an external default route to neighbors no matter whether a default route exists in the core routing table. This default route, however, is not displayed on the local router. To confirm whether the default route is generated, run the show ipv6 ospf database command to display the OSPFv3 link status database. On an OSPFv3 neighbor, you can run the show ipv6 route ospf command to see the default route.</p> <p>The metric of the external default route can only be defined in the default-information originate command, instead of the default-metric command.</p> <p>OSPFv3 has two types of external routes. The metric of the Type 1 external route changes, but the metric of the Type 2 external route is fixed. If two parallel paths to the same destination network have the same route metric, the priority of the Type 1 route is higher than that of the Type 2 route. Therefore, the show ipv6 route ospf command displays only the Type 1 route.</p> <p>A router in a stub area cannot generate an external default route.</p>

Configuration Example

↘ **Configuring Route Redistribution**

<p>Scenario Figure 5-10</p>	
<p>Configuration Steps</p>	<ul style="list-style-type: none"> ● Enable IPv6 on interfaces of all routers. ● Configure the OSPF basic functions on all routers. ● Introduce an external static route to Router D.
<p>D</p>	<pre>D#configure terminal D(config)#ipv6 router ospf 1 D(config-router)# redistribute static</pre>
<p>Verification</p>	<ul style="list-style-type: none"> ● On Router D, run the show ipv6ospf database external brief command to verify that an LSA corresponding to an external route is generated. ● On Router C, run the show ipv6 route ospf command to verify that the external static route has been introduced.
<p>D</p>	<pre>D#show ipv6 ospf database external OSPFv3 Router with ID (4.4.4.4) (Process 1) AS-external-LSA LS age: 7 LS Type: AS-External-LSA Link State ID: 0.0.0.6 Advertising Router: 4.4.4.4 LS Seq Number: 0x80000001 Checksum: 0x9C1F Length: 36 Metric Type: 2 (Larger than any link state path) Metric: 20 Prefix: 2001:10:10::/64 Prefix Options: 0 (- - -)</pre>

C	<pre> C#show ipv6 route ospf IPv6 routing table name - Default - 0 entries Codes: C - Connected, L - Local, S - Static R - RIP, O - OSPF, B - BGP, I - IS-IS, V - Overflow route N1 - OSPF NSSA external type 1, N2 - OSPF NSSA external type 2 E1 - OSPF external type 1, E2 - OSPF external type 2 SU - IS-IS summary, L1 - IS-IS level-1, L2 - IS-IS level-2 IA - Inter area O E2 2001:10:10::/64 [110/20] via FE80::2D0:F8FF:FE22:4547, GigabitEthernet 0/2 </pre>
----------	--

Configuring the Default Route

<p>Scenario Figure 5-11</p>	
<p>Configuration Steps</p>	<ul style="list-style-type: none"> ● Enable IPv6 on interfaces of all routers. ● Configure the OSPF basic functions on all routers. ● Configure the default route on Router D.
D	<pre> D#configure terminal D(config)#ipv6 router ospf 1 D(config-router)#default-information originate always </pre>
Verification	<ul style="list-style-type: none"> ● On Router D, run the show ipv6ospf database external brief command to verify that an LSA corresponding to the default route is generated. ● On Router C, run the show ipv6 route ospf command to verify that the OSPF default route exists.

D	<pre> D#show ipv6 ospf database external OSPFv3 Router with ID (4.4.4.4) (Process 1) AS-external-LSA LS age: 3 LS Type: AS-External-LSA Link State ID: 0.0.0.7 Advertising Router: 4.4.4.4 LS Seq Number: 0x80000001 Checksum: 0x1839 Length: 32 Metric Type: 2 (Larger than any link state path) Metric: 1 Prefix: ::/0 Prefix Options: 0 (- - -) External Route Tag: 1 </pre>
C	<pre> C#show ipv6route ospf IPv6 routing table name - Default - 0 entries Codes: C - Connected, L - Local, S - Static R - RIP, O - OSPF, B - BGP, I - IS-IS, V - Overflow route N1 - OSPF NSSA external type 1, N2 - OSPF NSSA external type 2 E1 - OSPF external type 1, E2 - OSPF external type 2 SU - IS-IS summary, L1 - IS-IS level-1, L2 - IS-IS level-2 IA - Inter area O E2::/0 [110/20] via FE80::2D0:F8FF:FE22:4547, GigabitEthernet 0/2 </pre>

Common Errors

- A route loop is formed because the **default-information originate always** command is configured on multiple routers.
- Routes cannot be introduced because route redistribution is configured on a router in the stub area.

5.4.4 Configuring the Stub Area and NSSA Area

Configuration Effect

- Configure an area located on the stub as a stub area to reduce interaction of routing information and the size of routing table, and enhance stability of routes.

Notes

- The OSPF basic functions must be configured.
- A backbone or transit area cannot be configured as a stub or an NSSA area.
- A router in the stub area cannot introduce external routes, but a router in the NSSA area can introduce external routes.

Configuration Steps

↘ **Configuring a Stub Area**

- (Optional) Perform this configuration if you wish to reduce the size of the routing table on routers in the area.
- Perform this configuration on all routers in the same area.

↘ **Configuring an NSSA Area**

- (Optional) Perform this configuration if you wish to reduce the size of the routing table on routers in the area and introduce OSPF external routes to the area.
- The area must be configured as an NSSA area on all routers in this area.

Verification

↘ **Verifying the Stub Area**

- On a router in the stub area, run the **show ipv6 route** command to verify that the router is not loaded with any external routes.

↘ **Verifying the NSSA Area**

- On a router in the NSSA area, run the **show ipv6 ospf database** command to verify that the introduced external route generates Type 7 LSAs.
- On a router in the backbone area, run the **show ipv6 route** command to verify that the router is loaded with external routes introduced from the NSSA area.

Related Commands

↘ **Configuring a Stub Area**

Command	area area-id stub [no-summary]
Parameter	<i>area-id</i> : Indicates the ID of the stub area. The value can be an integer or an IPv4 prefix.
Description	no-summary : This option is valid only on the ABR in a stub area. If this option is specified, the ABR only advertises one Type 3 LSA indicating the default route to the stub area, and does not advertise other Type 3 LSAs.
Command Mode	OSPF routing process configuration mode
Usage Guide	An area located on the stub of a network can be configured as a stub area. You must run the area stub command on all routers in a stub area. Devices in a stub area cannot learn the external routes (Type 5 LSAs) of the AS. In practice, external routes take up a large proportion of the link status database. Therefore, devices in a stub area can learn only a small amount of routing information, which reduces the amount of system resources required to run the OSPFv3 protocol. By default, an ABR in a stub area will generate a Type 3 LSA indicating the default route, and advertise the LSA to the stub area. In this way, devices in the stub area can access devices outside the AS. To configure a totally stub area, add the no-summary keyword when running the area stub command on the ABR.

➤ **Configuring an NSSA Area**

Command	area <i>area-id</i> nssa [no-redistribution] [default-information-originate [<i>metric</i> <i>value</i>] [metric-type <i>type</i>]] [no-summary] [translator [stability-interval <i>seconds</i> always]] [translate type7 suppress-fa]
Parameter Description	<p>area-id: Indicates the ID of the NSSA area.</p> <p>no-redistribution: Select this option if the router is an NSSA ABR and you want to use only the redistribute command to introduce the routing information into a common area instead of an NSSA area.</p> <p>default-information-originate: Indicates that a default Type 7 LSA is generated and introduced to the NSSA area. This option takes effect only on an NSSA ABR or ASBR.</p> <p>metric<i>value</i>: Specifies the metric of the generated default LSA. The value ranges from 0 to 16,777,214. The default value is 1.</p> <p>metric-type<i>type</i>: Specifies the route type of the generated default LSA. The values include 1 and 2. 1 represents N-1, and 2 represents N-2. The default value is 2.</p> <p>no-summary: Prohibits the ABR in the NSSA area from sending summary LSAs (Type-3 LSA).</p> <p>translator: Indicates that the NSSA ABR is a translator.</p> <p>stability-interval<i>seconds</i>: Indicates the stability interval after the NSSA ABR is changed from a translator to a non-translator. The unit is second. The default value is 40. The value ranges from 0 to 2,147,483,647.</p> <p>always: Indicates that the current NSSA ABR always acts as a translator. The default value is the standby translator.</p> <p>translate type7 suppress-fa: Indicates that the Type 5 LSA does not carry the forwarding address (FA) when the Type 7 LSA is converted to the Type 5 LSA.</p>
Command Mode	OSPF routing process configuration mode
Usage Guide	<p>The default-information-originate parameter is used to generate a default Type 7 LSA. This parameter has different functions on the ABR and the ASBR in the NSSA area. On the ABR, a Type 7 LSA default route is generated regardless of whether the default route exists in the routing table. On the ASBR (not an ABR), a Type 7 LSA default route is generated only when the default route exists in the routing table.</p> <p>If the no-redistribution parameter is configured on the ASBR, other external routes introduced by OSPF through the redistribute command cannot be advertised to the NSSA area. This parameter is generally used when a router in the NSSA area acts both as the ASBR and the ABR. It prevents external routing information from entering the NSSA area.</p> <p>To further reduce the number of LSAs sent to the NSSA area, you can configure the no-summary parameter on the ABR to prevent the ABR from sending the summary LSAs (Type 3 LSA) to the NSSA area.</p> <p>area default-cost is used on an ABR or ASBR connected to the NSSA area. This command configures the cost of the default route sent from the ABR/ASBR to the NSSA area. By default, the cost of the default route sent to the NSSA area is 1.</p> <p>If an NSSA area has two or more ABRs, the ABR with the largest router ID is elected by default as the translator for converting Type 7 LSAs into Type 5 LSAs. If the current device is always the translator ABR for converting Type 7 LSAs into Type 5 LSAs, use the translator always parameter.</p> <p>If the translator role of the current device is replaced by another ABR, the conversion capability is retained during the time specified by stability-interval. If the router does not become a translator again during stability-interval, LSAs that are converted from Type 7 to Type 5 will be deleted from the AS after stability-interval expires.</p> <p>To prevent a routing loop, LSAs that are converted from Type 7 to Type 5 will be deleted from the AS immediately after the current device loses the translator role even if stability-interval does not expire.</p> <p>In the same NSSA area, it is recommended that translator always be configured on only one ABR.</p>

Configuration Example

➤ **Configuring a Stub Area**

<p>Scenario</p>	
<p>Configuration Steps</p>	<ul style="list-style-type: none"> ● Enable IPv6 on interfaces of all routers.(Omitted) ● Configure the OSPF basic functions on all routers. (Omitted) ● Introduce an external static route to Router D. ● Configure area 1 as the stub area on Router A and Router C.
<p>D</p>	<pre>D#configure terminal D(config)#ipv6 router ospf 1 D(config-router)#redistribute static</pre>
<p>A</p>	<pre>A# configure terminal A(config)#ipv6 router ospf 1 A(config-router)#area 1 stub no-summary</pre>
<p>C</p>	<pre>C#configure terminal C(config)#ipv6 router ospf 1 C(config-router)#area 1 stub</pre>
<p>Verification</p>	<ul style="list-style-type: none"> ● On Router C, run the show ipv6 route ospf command to display the routing table. Verify that there is only one default inter-area route, and no external static route is introduced from Router D.
<p>C</p>	<pre>C#show ipv6 route ospf IPv6 routing table name - Default - 0 entries Codes: C - Connected, L - Local, S - Static R - RIP, O - OSPF, B - BGP, I - IS-IS, V - Overflow route N1 - OSPF NSSA external type 1, N2 - OSPF NSSA external type 2 E1 - OSPF external type 1, E2 - OSPF external type 2 SU - IS-IS summary, L1 - IS-IS level-1, L2 - IS-IS level-2 IA - Inter area O IA::0 [110/3] via FE80::2D0:F8FF:FE22:4547, GigabitEthernet 0/2</pre>

➤ **Configuring an NSSA Area**

<p>Scenario</p>	
<p>Configuration Steps</p>	<ul style="list-style-type: none"> ● Enable IPv6 on interfaces of all routers.(Omitted) ● Configure the OSPF basic functions on all routers. (Omitted) ● Introduce an external static route to Router D. ● Configure area 1 as the NSSA area on Router B and Router D.
<p>D</p>	<pre>D#configure terminal D(config)#ipv6 router ospf 1 D(config-router)#area 1 nssa D(config-router)#redistribute static</pre>
<p>B</p>	<pre>B#configure terminal B(config)#ipv6 router ospf 1 B(config-router)#area 1 nssa</pre>
<p>Verification</p>	<ul style="list-style-type: none"> ● On Router D, run the show ipv6 ospf database command to display the database information and verify that Type 7 LSAs are generated. ● On Router A, run the show ipv6 route ospf command to display the routing table and verify that an external static route is introduced by Router D.

D	<pre> D#show ipv6 ospf database nssa-external OSPFv3 Router with ID (1.1.1.1) (Process 1) NSSA-external-LSA (Area 0.0.0.1) LS age: 1196 LS Type: NSSA-external-LSA Link State ID: 0.0.0.3 Advertising Router: 1.1.1.1 LS Seq Number: 0x80000004 Checksum: 0x1F25 Length: 52 Metric Type: 2 (Larger than any link state path) Metric: 20 Prefix: 2001:10::/64 Prefix Options: 8 (P - -) Forwarding Address: 4000::1 </pre>
A	<pre> A#show ipv6 route ospf IPv6 routing table name - Default - 0 entries Codes: C - Connected, L - Local, S - Static R - RIP, O - OSPF, B - BGP, I - IS-IS, V - Overflow route N1 - OSPF NSSA external type 1, N2 - OSPF NSSA external type 2 E1 - OSPF external type 1, E2 - OSPF external type 2 SU - IS-IS summary, L1 - IS-IS level-1, L2 - IS-IS level-2 IA - Inter area O N2 2001:10::/64 [110/20] via FE80::2D0:F8FF:FE22:4547, GigabitEthernet 0/1 </pre>

Common Errors

- Configurations of the area type are inconsistent on routers in the same area.
- External routes cannot be introduced because route redistribution is configured on a router in the stub area.

5.4.5 Configuring Route Summarization

Configuration Effect

- Summarize routes to reduce interaction of routing information and the size of routing table, and enhance stability of routes.

- Shield or filter routes.

Notes

- The OSPF basic functions must be configured.
- The address range of the summarize route may exceed the actual network range in the routing table. If data is sent to a network beyond the summarization range, a routing loop may be formed and the router processing load may increase. To prevent these problems, a discard route must be added to the routing table or shield or filter routes.

Configuration Steps

↘ **Configuring Inter-Area Route Summarization**

- (Optional) Perform this configuration when routes of the OSPF area need to be summarized.
- Unless otherwise required, perform this configuration on an ABR in the area where routes to be summarized are located.

↘ **Configuring External Route Summarization**

- (Optional) Perform this configuration when routes external to the OSPF domain need to be summarized.
- Unless otherwise required, perform this configuration on an ASBR, to which routes that need to be summarized are introduced.

Verification

- Run the **show ipv6 route ospf** command to verify that individual routes do not exist and only the summarized route exists.

Related Commands

↘ **Configuring Inter-Area Route Summarization**

Command	area <i>area-id</i> range <i>ipv6-prefix/prefix-length</i> [advertise not-advertise]
Parameter Description	<i>area-id</i> : Specifies the ID of the OSPF area to which the summarized route should be injected. The value can be an integer or an IPv4 prefix. <i>ipv6-prefix/prefix-length</i> : Indicates the range of IP addresses to be summarized. advertise not-advertise : Specifies whether the summarized route should be advertised.
Command Mode	OSPF routing process configuration mode
Usage Guide	This command takes effect only on an ABR, and is used to summarize multiple routes in an area into a route and advertise this route to other areas. Combination of the routing information occurs only on the boundary of an area. Routers inside the area can learn specific routing information, whereas routers in other areas can learn only one summarized route. In addition, you can set advertise or not-advertise to determine whether to advertise the summarized route to shield and filter routes. By default, the summarized route is advertised. You can use the cost parameter to set the metric of the summarized route. You can configure route summarization commands for multiple areas. This simplifies routes in the entire OSPF routing domain, and improves the network forwarding performance, especially for a large-sized network. When multiple route summarization commands are configured and have the inclusive relationship with each other, the area range to be summarized is determined based on the maximum match principle.

↘ **Configuring External Route Summarization**

Command	summary-prefix <i>ipv6-prefix/prefix-length</i> [not-advertise tag number]
----------------	---

Parameter Description	<p><i>ipv6-prefix/prefix-length</i>: Indicates the range of IP addresses to be summarized.</p> <p>not-advertise: Indicates that the summarized route is not advertised. If this parameter is not specified, the summarized route is advertised.</p> <p>tag number: Specifies the tag value of the route that is redistributed into the OSPFv3 routing domain. The value ranges from 0 to 4,294,967,295.</p>
Command Mode	OSPF routing process configuration mode
Usage Guide	<p>When routes are redistributed from other routing processes and injected to the OSPFv3 routing process, each route is advertised to the OSPFv3 routers using an external LSA. If the injected routes are a continuous address space, the ABR can advertise only one summarized route to significantly reduce the size of the routing table.</p> <p>area range summarizes the routes between OSPFv3 areas, whereas summary-prefix summarizes external routes of the OSPFv3 routing domain.</p> <p>When configured on the NSSA ABR translator, summary-prefix summarizes redistributed routes and routes obtained based on the LSAs that are converted from Type 7 to Type 5. When configured on the ASBR (not an NSSA ABR translator), summary-prefix summarizes only redistributed routes.</p>

Configuration Example

<p>Configuration Steps Figure 5-13</p>			
	<table border="1"> <tr> <td>Remarks</td> <td> <p>The interface IPv6 addresses are as follows:</p> <p>B: GE0/2 2001:16:2::1/64 GE0/3 2001:16:3::1/64</p> <p>C: GE0/2 2001:16:2::2/64 GE0/1 2001:16:4::2/64</p> <p>D: GE0/3 2001:16:3::2/64 GE0/1 2001:16:5::1/64</p> </td> </tr> </table>	Remarks	<p>The interface IPv6 addresses are as follows:</p> <p>B: GE0/2 2001:16:2::1/64 GE0/3 2001:16:3::1/64</p> <p>C: GE0/2 2001:16:2::2/64 GE0/1 2001:16:4::2/64</p> <p>D: GE0/3 2001:16:3::2/64 GE0/1 2001:16:5::1/64</p>
Remarks	<p>The interface IPv6 addresses are as follows:</p> <p>B: GE0/2 2001:16:2::1/64 GE0/3 2001:16:3::1/64</p> <p>C: GE0/2 2001:16:2::2/64 GE0/1 2001:16:4::2/64</p> <p>D: GE0/3 2001:16:3::2/64 GE0/1 2001:16:5::1/64</p>		
Configuration Steps	<ul style="list-style-type: none"> ● Enable IPv6 on interfaces of all routers.(Omitted) ● Configure the OSPF basic functions on all routers. (Omitted) ● Summarize routes of area 2 on Router B. 		
B	<pre>B#configure terminal B(config)#ipv6 router ospf 1 B(config-router)#area 2 range 2001:16::/64</pre>		
Verification	On Router A, check the routing table and verify that the entry 2001:16::/64 is generated and other routes do not exist.		

A	<pre>A#show ipv6 route ospf IPv6 routing table name - Default - 0 entries Codes: C - Connected, L - Local, S - Static R - RIP, O - OSPF, B - BGP, I - IS-IS, V - Overflow route N1 - OSPF NSSA external type 1, N2 - OSPF NSSA external type 2 E1 - OSPF external type 1, E2 - OSPF external type 2 SU - IS-IS summary, L1 - IS-IS level-1, L2 - IS-IS level-2 IA - Inter area O IA 2001:16::/64 [110/2] via FE80::2D0:F8FF:FE22:4547, GigabitEthernet 0/1</pre>
----------	--

Common Errors

- Inter-area route summarization cannot be implemented because the **area range** command is configured on a non-ABR device.

5.4.6 Configuring Route Filtering

Configuration Effect

- Routes that do not meet filtering conditions cannot be loaded to the routing table, or advertised to neighbors. Network users cannot access specified destination network.

Notes

- The OSPF basic functions must be configured.
- Filtering routes by using the **distribute-list in** command affects forwarding of local routes, but does not affect route computation based on LSAs. Therefore, if route filtering is configured on the ABR, Type 3 LSAs will still be generated and advertised to other areas because routes can still be computed based on LSAs. As a result, black-hole routes are generated. In this case, you can run the **area filter-list** or **area range** (containing the **not-advertise** parameter) command on the ABR to prevent generation of black-hole routes.

Configuration Steps

↘ Configuring Inter-Area Route Filtering

- (Optional) This configuration is recommended if users need to be restricted from accessing the network in a certain OSPF area.
- Unless otherwise required, perform this configuration on an ABR in the area where filtered routes are located.

↘ Configuring Redistributed Route Filtering

- (Optional) Perform this configuration if external routes introduced by the ASBR need to be filtered.
- Unless otherwise required, perform this configuration on an ASBR to which filtered routes are introduced.

↘ Configuring Learned Route Filtering

- (Optional) Perform this configuration if users need to be restricted from accessing a specified destination network.
- Unless otherwise required, perform this configuration on a router that requires route filtering.

Verification

- Run the **show ipv6 route** command to verify that the router is not loaded with routes that have been filtered out.
- Run the **ping** command to verify that the specified destination network cannot be accessed.

Related Commands

▾ Configuring a Passive Interface

Command	passive-interface { default <i>interface-type</i> <i>interface-number</i> }
Parameter	<i>interface-type interface-number</i> : Indicates the interface that should be configured as a passive interface.
Description	default : Indicates that all interfaces will be configured as passive interfaces.
Command Mode	OSPF routing process configuration mode
Usage Guide	When an interface is configured as a passive interface, it no longer sends or receives Hello packets. This command takes effect only on an OSPFv3-enabled interface, and not on a virtual link.

▾ Configuring Redistributed Route Filtering

Command	distribute-list { <i>name</i> prefix-list <i>prefix-list-name</i> } out { bgp connected isis [<i>area-tag</i>] ospf <i>process-id</i> rip static }
Parameter	<i>name</i> : Uses the ACL for filtering.
Description	prefix <i>prefix-list-name</i> : Uses the prefix list for filtering. bgp connected isis [<i>area-tag</i>] ospf <i>process-id</i> rip static : Indicates the source of routes to be filtered.
Command Mode	OSPF routing process configuration mode
Usage Guide	distribute-list out is similar to redistribute route-map , and is used to filter routes that are redistributed from other protocols to OSPFv3. The distribute-list out command itself does not redistribute routes, and is generally used together with the redistribute command. The ACL and the prefix list filtering rules are mutually exclusive in the configuration. That is, if the ACL is used for filtering routes coming from a certain source, the prefix list cannot be configured to filter the same routes.

▾ Configuring Learned Route Filtering

Command	distribute-list { <i>name</i> prefix-list <i>prefix-list-name</i> } in [<i>interface-type</i> <i>interface-number</i>]
Parameter	<i>name</i> : Uses the ACL for filtering.
Description	prefix <i>prefix-list-name</i> : Uses the prefix list for filtering. <i>interface-type interface-number</i> : Specifies the interface for which LSA routes are filtered.
Command Mode	OSPF routing process configuration mode
Usage Guide	Filter routes that are computed based on received LSAs. Only routes meeting the filtering conditions can be forwarded. The command does not affect the LSDB or the routing tables of neighbors. The ACL and the prefix list filtering rules are mutually exclusive in the configuration. That is, if the ACL is used for filtering routes on a specified interface, the prefix list cannot be configured to filter routes on the same interface. Filtering routes by using the distribute-list in command affects forwarding of local routes, but does not affect route computation based on LSAs. Therefore, if route filtering is configured on the ABR, Type 3 LSAs will still be generated and

advertised to other areas because routes can still be computed based on LSAs. As a result, black-hole routes are generated. In this case, you can run the **area range** (containing the **not-advertise** parameter) command on the ABR to prevent generation of black-hole routes.

Configuration Example

<p>Scenario Figure 5-14</p>	<div data-bbox="337 817 1466 974" style="border: 1px solid black; padding: 5px;"> <p>Remarks The interface IPv6 addresses are as follows: B: GE0/2 2001:16:2::1/64 GE0/3 2001:16:3::1/64 C: GE0/2 2001:16:2::2/64 GE0/1 2001:16:4::2/64 D: GE0/3 2001:16:3::2/64 GE0/1 2001:16:5::1/64</p> </div>
<p>Configuration Steps</p>	<ul style="list-style-type: none"> ● Enable IPv6 on interfaces of all routers.(Omitted) ● Configure the OSPF basic functions on all routers. (Omitted) ● On Router A, configure route filtering.
<p>A</p>	<pre>A#configure terminal A(config)#ipv6 access-list test A (config-ipv6-acl)#permit ipv6 2001:16:5::/64 any A(config)#ipv6 router ospf 1 A(config-router)#distribute-list test in GigabitEthernet0/1</pre>
<p>Verification</p>	<ul style="list-style-type: none"> ● On Router A, check the routing table. Verify that only the entry 2001:16:5::/64 is loaded.
<p>A</p>	<pre>A#show ipv6 route ospf IPv6 routing table name - Default - 0 entries Codes: C - Connected, L - Local, S - Static R - RIP, O - OSPF, B - BGP, I - IS-IS, V - Overflow route N1 - OSPF NSSA external type 1, N2 - OSPF NSSA external type 2 E1 - OSPF external type 1, E2 - OSPF external type 2 SU - IS-IS summary, L1 - IS-IS level-1, L2 - IS-IS level-2 IA - Inter area O IA 2001:16:5::/64 [110/2] via FE80::2D0:F8FF:FE22:4547, GigabitEthernet 0/1</pre>

Common Errors

- Filtering routes by using the **distribute-list in** command affects forwarding of local routes, but does not affect route computation based on LSAs. Therefore, if route filtering is configured on the ABR, Type 3 LSAs will still be generated and advertised to other areas because routes can still be computed based on LSAs. As a result, black-hole routes are generated.

5.4.7 Modifying the Route Cost and AD

Configuration Effect

- Change the OSPF routes so that the traffic passes through specified nodes or bypasses specified nodes.
- Change the sequence that a router selects routes so as to change the priorities of OSPF routes.

Notes

- The OSPF basic functions must be configured.
- If you run the **ipv6 ospf cost** command to configure the cost of an interface, the configured cost will automatically overwrite the cost that is computed based on the auto cost.

Configuration Steps

↘ Configuring the Reference Bandwidth

- Optional.
- A router is connected with lines with different bandwidths. This configuration is recommended if you wish to preferentially select the line with a larger bandwidth.

↘ Configuring the Cost of an Interface

- Optional.
- A router is connected with multiple lines. This configuration is recommended if you wish to manually specify a preferential line.

↘ Configuring the Default Metric for Redistribution

- Optional.
- This configuration is mandatory if the cost of external routes of the OSPF domain should be specified when external routes are introduced to an ASBR.

↘ Configuring the Maximum Metric

- Optional.
- A router may be unstable during the restart process or a period of time after the router is restarted, and users do not want to forward data through this router. In this case, this configuration is recommended.

↘ Configuring the AD

- Optional.
- Perform this configuration if you wish to change the priorities of OSPF routes on a router that runs multiple unicast routing protocols.

Verification

- Run the **show ipv6 ospf interface** command to verify that the costs of interfaces are correct.
- Run the **show ipv6 route** command to verify that the costs of external routes introduced by the ASBR are correct.
- Restart the router. Within a specified period of time, data is not forwarded through the restarted router.

Related Commands

▾ Configuring the Reference Bandwidth

Command	auto-cost reference-bandwidth <i>ref-bw</i>
Parameter Description	<i>ref-bw</i> : Indicates the reference bandwidth. The unit is Mbps. The value ranges from 1 to 4,294,967.
Command Mode	OSPF routing process configuration mode
Usage Guide	You can run the ipv6 ospf cost command in interface configuration mode to specify the cost of the interface. The priority of this cost is higher than that of the metric computed based on the reference bandwidth.

▾ Configuring the Cost of an Interface

Command	ipv6 ospf cost <i>cost</i> [instance <i>instance-id</i>]
Parameter Description	<i>cost</i> : Indicates the cost of an OSPF interface. The value ranges from 0 to 65,535. instance <i>instance-id</i> : Indicates the ID of a specified OSPFv3 process of the interface. The value ranges from 0 to 255.
Command Mode	Interface configuration mode
Usage Guide	By default, the cost of an OSPFv3 interface is equal to 100 Mbps/Bandwidth, where Bandwidth is the bandwidth of the interface and configured by the bandwidth command in interface configuration mode. The costs of OSPF interfaces on several typical lines are as follows: <ul style="list-style-type: none"> ● 64 Kbps serial line: The cost is 1562. ● E1 line: The cost is 48. ● 10M Ethernet: The cost is 10. ● 100M Ethernet: The cost is 1. If you run the ipv6 ospf cost command to configure the cost of an interface, the configured cost will automatically overwrite the cost that is computed based on the auto cost.

▾ Configuring the Cost of the Default Route in a Stub/NSSA Area

Command	area <i>area-id</i> default-cost <i>cost</i>
Parameter Description	<i>area-id</i> : Indicates the ID of the stub/nssa area. <i>cost</i> : Indicates the cost of the default summarized route injected to the stub/nssa area. The value ranges from 0 to 16,777,215.
Command Mode	OSPF routing process configuration mode
Usage Guide	This command takes effect only on an ABR in a stub/nssa area.

▾ Configuring the Default Metric for Redistribution

Command	default-metric <i>metric</i>
Parameter Description	<i>metric</i> : Indicates the default metric of the OSPF redistributed route. The value ranges from 1 to 16,777,214.

Command Mode	OSPF routing process configuration mode
Usage Guide	The default-metric command must be used together with the redistribute command to modify the initial metrics of all redistributed routes. The default-metric command does not take effect on external routes that are injected to the OSPF routing domain by the default-information originate command. The default metric of a redistributed direct route is always 20.

📌 **Configuring the AD**

Command	distance { <i>distance</i> ospf { [<i>intra-area distance</i>] [<i>inter-area distance</i>] [external distance]} }
Parameter Description	<i>distance</i> : Indicates the AD of a route. The value ranges from 1 to 255. intra-area distance : Indicates the AD of an intra-area route. The value ranges from 1 to 255. inter-area distance : Indicates the AD of an inter-area route. The value ranges from 1 to 255. external distance : Indicates the AD of an external route. The value ranges from 1 to 255.
Command Mode	OSPF routing process configuration mode
Usage Guide	Use this command to specify different ADs for different types of OSPF routes. The AD allows different routing protocols to compare route priorities. A smaller AD indicates a higher route priority. The priorities of routes generated by different OSPFv3 processes must be compared based on ADs. If the AD of a route entry is set to 255, the route entry is not trustworthy and does not participate in packet forwarding.

Configuration Example

Scenario Figure 5-15	
Configuration Steps	<ul style="list-style-type: none"> ● Enable IPv6 on interfaces of all routers.(Omitted) ● Configure the OSPF basic functions on all routers. (Omitted) ● On Router A, configure the cost of each interface.
A	<pre>A#configure terminal A(config)#interface GigabitEthernet 0/1 A(config-if-GigabitEthernet 0/1)#ipv6 ospf cost 10 A(config)#interface GigabitEthernet 0/2 A(config-if-GigabitEthernet 0/2)#ipv6 ospf cost 20</pre>
Verification	<ul style="list-style-type: none"> ● On Router A, check the routing table. The next hop of the optimum path to 2001:16:1::/64 is Router B.

A	<pre>A#show ipv6 route ospf IPv6 routing table name - Default - 0 entries Codes: C - Connected, L - Local, S - Static R - RIP, O - OSPF, B - BGP, I - IS-IS, V - Overflow route N1 - OSPF NSSA external type 1, N2 - OSPF NSSA external type 2 E1 - OSPF external type 1, E2 - OSPF external type 2 SU - IS-IS summary, L1 - IS-IS level-1, L2 - IS-IS level-2 IA - Inter area O E2 2001:16:1::/64 [110/2] via FE80::2D0:F8FF:FE22:4547, GigabitEthernet 0/1</pre>
----------	--

Common Errors

- If the cost of an interface is set to 0 in the **ipv6 ospf cost** command, a route computation error may occur. For example, a routing loop is obtained.

5.4.8 Enabling Authentication

Configuration Effect

- All routers connected to the OSPF network must be authenticated to ensure stability of OSPF and protect OSPF against intrusions.

Notes

- The OSPF basic functions must be configured.
- If authentication is configured for an area, the configuration takes effect on all interfaces that belong to this area.
- If authentication is configured for both an interface and the area to which the interface belongs, the configuration for the interface takes effect preferentially.

Configuration Steps

▾ Configuring Authentication

- Optional.
- Perform this configuration if a router accesses a network that requires authentication.

▾ Configuring Encryption

- Optional.
- Perform this configuration if a router accesses a network that requires encryption.

▾ Configuring Virtual Link Authentication

- Optional.

- Perform this configuration if a router accesses a network that requires authentication.

📌 Configuring Virtual Link Encryption

- Optional.
- Perform this configuration if a router accesses a network that requires encryption.

Verification

- If routers are configured with different authentication keys, run the **show ipv6 ospf neighbor** command to verify that there is no OSPF neighbor.
- If routers are configured with the same authentication key, run the **show ipv6 ospf neighbor** command to verify that there are OSPF neighbors.

Related Commands

📌 Configuring Area-based Authentication

Command	area <i>area-id</i> authentication ipsec spi <i>spi</i> [md5 <i>string-key</i>] <i>sha1</i> [0 7] <i>key</i>
Parameter	<i>area-id</i> : Indicates the area ID.The value can be an integer or an IPv4 prefix.
Description	<i>spi</i> : Indicates the SPI. The value ranges from 256 to 4,294,967,295. md5 : Enables MD5 authentication. string-key : Indicates that MD5 authentication key supports special characters. sha1 : Enables SHA1 authentication. 0 : Indicates that the key is displayed in plain text. 7 : Indicates that the key is displayed in cipher text. <i>key</i> : Indicates the authentication key.
Command	OSPF routing process configuration mode
Mode	
Usage Guide	The FSOS supports three authentication types: <ul style="list-style-type: none"> ● No authentication ● MD5 authentication ● SHA1 authentication Configuration of area-based authentication for OSPFv3 takes effect on all interfaces (except virtual links) in the area, but the interface-based authentication configuration takes precedence over the area-based configuration.

📌 Configuring Area-based Encryption and Authentication

Command	area <i>area-id</i> encryption ipsec spi <i>spi</i> esp [null <i>des</i> <i>3des</i>] [0 7] <i>des-key</i> [md5 <i>sha1</i>] [0 7] <i>key</i>
Parameter	<i>area-id</i> : Indicates the area ID.The value can be an integer or an IPv4 prefix.
Description	<i>spi</i> : Indicates the SPI. The value ranges from 256 to 4,294,967,295. null : Indicates that no encryption mode is used. des : Indicates that the Data Encryption Standard (DES) mode is used. 3des : Indicates that the Triple DES (3DES) mode is used. <i>des-key</i> : Indicates the encryption key. md5 : Enables MD5 authentication. sha1 : Enables SHA1 authentication. 0 : Indicates that the key is displayed in plain text.

	<p>7: Indicates that the key is displayed in cipher text.</p> <p>key: Indicates the authentication key.</p>
Command Mode	OSPF routing process configuration mode
Usage Guide	<p>The FSOS supports two encryption modes and two authentication modes.</p> <p>The two encryption modes are as follows:</p> <ul style="list-style-type: none"> ● DES ● 3DES <p>The two authentication modes are as follows:</p> <ul style="list-style-type: none"> ● MD5 ● SHA1 <p>Configuration of area-based encryption and authentication for OSPFv3 takes effect on all interfaces (except virtual links) in the area, but the interface-based encryption and authentication configuration takes precedence over the area-based configuration.</p>

↘ **Configuring Interface-based Authentication**

Command	ipv6 ospfauthentication [null ipsec spi spi[md5 [string-key][sha1] [0 7]key][instanceinstance-id]
Parameter Description	<p>area-id: Indicates the area ID.The value can be an integer or an IPv4 prefix.</p> <p>spi: Indicates the SPI. The value ranges from 256 to 4,294,967,295.</p> <p>md5: Enables MD5 authentication.</p> <p>string-key: Indicates that MD5 authentication key supports special characters.</p> <p>sha1: Enables SHA1 authentication.</p> <p>0: Indicates that the key is displayed in plain text.</p> <p>7: Indicates that the key is displayed in cipher text.</p> <p>key: Indicates the authentication key.</p> <p>instance instance-id: Indicates the ID of a specified OSPFv3 process of the interface. The value ranges from 0 to 255.</p>
Command Mode	OSPF routing process configuration mode
Usage Guide	<p>The FSOS supports three authentication types:</p> <ul style="list-style-type: none"> ● No authentication ● MD5 authentication ● SHA1 authentication <p>OSPFv3 authentication parameters configured on interconnected interfaces must be consistent.</p>

↘ **Configuring Interface-based Encryption and Authentication**

Command	ipv6 ospfencryption ipsec spi spi esp [null [des 3des][[0 7] des-key][md5 sha1] [0 7] key[instanceinstance-id]
Parameter Description	<p>spi: Indicates the SPI. The value ranges from 256 to 4,294,967,295.</p> <p>null: Indicates that no encryption mode is used.</p> <p>des: Indicates that the DES mode is used.</p> <p>3des: Indicates that the 3DES mode is used.</p> <p>des-key: Indicates the encryption key.</p> <p>md5: Enables MD5 authentication.</p> <p>sha1: Enables SHA1 authentication.</p> <p>0: Indicates that the key is displayed in plain text.</p>

	<p>7: Indicates that the key is displayed in cipher text.</p> <p>key: Indicates the authentication key.</p> <p>instance <i>instance-id</i>: Indicates the ID of a specified OSPFv3 process of the interface. The value ranges from 0 to 255.</p>
Command	OSPF routing process configuration mode
Mode	
Usage Guide	<p>The FSOS supports two encryption modes and two authentication modes.</p> <p>The two encryption modes are as follows:</p> <ul style="list-style-type: none"> ● DES ● 3DES <p>The two authentication modes are as follows:</p> <ul style="list-style-type: none"> ● MD5 ● SHA1 <p>OSPFv3 encryption and authentication parameters configured on the local interface must be consistent with those configured on the interconnected interfaces.</p>

Configuration Example

<p>Scenario</p> <p>Figure 5-16</p>	
<p>Configuration Steps</p>	<ul style="list-style-type: none"> ● Enable IPv6 on interfaces of all routers.(Omitted) ● Configure the OSPF basic functions on all routers. (Omitted) ● Configure MD5 authentication for interfaces of all routers.
<p>A</p>	<pre>A#configure terminal A(config)#interface GigabitEthernet 0/1 A(config-if-GigabitEthernet 0/1)#ipv6 ospf authentication ipsec spi 256 md5 01234567890123456789012345678912</pre>
<p>B</p>	<pre>B# configure terminal B(config)#interface GigabitEthernet 0/3 B(config-if-GigabitEthernet 0/3)#ipv6 ospf authentication ipsec spi 256 md5 01234567890123456789012345678912</pre>
<p>Verification</p>	<ul style="list-style-type: none"> ● On Router A and Router B, verify that the OSPF neighbor status is correct.
<p>A</p>	<pre>A# show ipv6 ospf neighbor OSPFv3 Process (1), 1 Neighbors, 1 is Full: Neighbor ID Pri State Dead Time Instance ID Interface 2.2.2.2 1 Full/DR 00:00:38 0 GigabitEthernet 0/1</pre>

B	<pre> B# show ipv6 ospf neighbor OSPFv3 Process (1), 1 Neighbors, 1 is Full: Neighbor ID Pri State Dead Time Instance ID Interface 1.1.1.1 1 Full/BDR 00:00:38 0 GigabitEthernet 0/1 </pre>
----------	---

Common Errors

- The configured authentication modes are inconsistent.
- The configured authentication keys are inconsistent.

5.4.9 Modifying the Maximum Number of Concurrent Neighbors

Configuration Effect

- Control the maximum number of concurrent neighbors on the OSPF process to ease the pressure on the device.

Notes

- The OSPF basic functions must be configured.

Configuration Steps

➤ **Configuring the Maximum Number of Concurrent Neighbors on the OSPF Process**

- (Optional) This configuration is recommended if you wish to set up the OSPF adjacency more quickly when a router is connected with a lot of other routers.
- Perform this configuration on a core router.

Verification

- Run the **show ipv6 ospf neighbor** command to display the number of neighbors that are concurrently interacting with the OSPF process.

Related Commands

➤ **Configuring the Maximum Number of Concurrent Neighbors on the Current Process**

Command	max-concurrent-dd <i>number</i>
Parameter Description	<i>number</i> : Specifies the maximum number of neighbors that are concurrently interacting with the OSPF process. The value ranges from 1 to 65,535.
Command Mode	OSPF routing process configuration mode
Usage Guide	When the performance of a router is affected because the router exchanges data with multiple neighbors, you can configure this command to restrict the maximum of neighbors with which each OSPF process can concurrently initiate or accept interaction.

➤ **Configuring the Maximum Number of Concurrent Neighbors on All Processes**

Command	ipv6 router ospf max-concurrent-dd <i>number</i>
Parameter	<i>number</i> : Specifies the maximum number of neighbors that are concurrently interacting with the OSPF process. The value

Description	ranges from 1 to 65,535.
Command	Global configuration mode
Mode	
Usage Guide	When the performance of a router is affected because the router exchanges data with multiple neighbors, you can configure this command to restrict the maximum of neighbors with which all OSPF processes can concurrently initiate or accept interaction.

Configuration Example

<p>Scenario Figure 5-17</p>	
<p>Configuration Steps</p>	<ul style="list-style-type: none"> ● Enable IPv6 on interfaces of all routers.(Omitted) ● Configure the OSPF basic functions on all routers. (Omitted) ● On the Router Core, set the maximum number of concurrent neighbors to 4.
<p>Core</p>	<pre>Core# configure terminal Core(config)# ipv6 router ospf max-concurrent-dd 4</pre>
<p>Verification</p>	<ul style="list-style-type: none"> ● On the Router Core, check the neighbor status and verify that at most eight neighbors concurrently interact with the OSPF process.

Common Errors

N/A

5.4.10 Type-9 LSA Carrying IPv6 Prefix

Configuration Effect

- Type-9 LSA generated by the router carries IPv6 prefix not address.

Notes

- The OSPF basic functions must be configured.

Configuration Steps

📌 **Configure Type-9 LSA Carrying IPv6 Prefix**

- (Optional) It is recommended to run this command to connect with quagga or other vendors' products.

- Perform this configuration on all routers.

Verification

- Check whether type-9 LSA carrying IPv6 prefix.

Related Commands

🔽 **Configuring Type-9 LSA Carrying IPv6 Prefix**

Command	ipv6 router ospf compatible lsa type-9
Parameter Description	N/A
Command Mode	Global configuration mode
Usage Guide	By default, type-9 LSA carries IPv6 address. If the device is connected with quagga, an error will occur because the type-9 LSA generated by quagga carries IPv6 prefix. If quagga exists in the topology, this command should be configured.

Configuration Example

Scenario	
Configuration Steps	<ul style="list-style-type: none"> ● Enable IPv6 on interfaces of all routers.(Omitted) ● Configure the OSPF basic functions on all routers. (Omitted) ● Run this command on all routers. (This function is disabled by default.)
A	<pre>A# configure terminal A(config)# ipv6 router ospf compatible lsa type-9</pre>
B	<pre>B# configure terminal B(config)# ipv6 router ospf compatible lsa type-9</pre>
Verification	<ul style="list-style-type: none"> ● Check the OSPF neighbor and the prefix of type-9 LSA on router A.
A	<pre>A# show ipv6 ospf neighbor OSPFv3 Process (1), 1 Neighbors, 1 is Full: Neighbor ID Pri State Dead Time Instance ID Interface 2.2.2.2 1 Full/DR 00:00:38 0 GigabitEthernet 0/1</pre>

Common Errors

N/A

5.4.11 Disabling MTU Verification

Configuration Effect

- The unicast routing service can be provided even if the MTUs of interfaces on neighbor routers are different.

Notes

- The OSPF basic functions must be configured.

Configuration Steps

➤ **Disabling MTU Verification**

- (Optional) MTU verification is disabled by default. You are advised to retain the default configuration.
- Perform this configuration on two routers with different interface MTUs.

Verification

- The adjacency can be set up between routers with different MTUs.

Related Commands

➤ **Disabling MTU Verification**

Command	ipv6 ospf mtu-ignore
Parameter	N/A
Description	
Command Mode	Interface configuration mode
Usage Guide	On receiving the database description packet, OSPF checks whether the MTU of the interface on the neighbor is the same as the MTU of its own interface. If the interface MTU specified in the received database description packet is greater than the MTU of the local interface, the adjacency cannot be set up. To resolve this problem, you can disable MTU verification.

Configuration Example

Scenario Figure 5-18	
Configuration Steps	<ul style="list-style-type: none"> ● Enable IPv6 on interfaces of all routers.(Omitted) ● Configure the OSPF basic functions on all routers. (Omitted) ● Configure different MTUs for interfaces on two routers. ● Disable MTU verification on all routers. (By default, the function of disabling MTU verification is enabled.)
A	<pre>A# configure terminal A(config)# interface GigabitEthernet 0/1 A(config-if-GigabitEthernet 0/1)# ipv6 mtu 1400 A(config-if-GigabitEthernet 0/1)#ipv6 ospf mtu-ignore</pre>

B	<pre>B# configure terminal B(config)# interface GigabitEthernet 0/1 A(config-if-GigabitEthernet 0/1)# ipv6 mtu 1600 B(config-if-GigabitEthernet 0/1)# ipv6 ospf mtu-ignore</pre>
Verification	<ul style="list-style-type: none"> On Router A, verify that the OSPF neighbor information is correct.
A	<pre>A# show ipv6 ospf neighbor OSPFv3 Process (1), 1 Neighbors, 1 is Full: Neighbor ID Pri State Dead Time Instance ID Interface 2.2.2.2 1 Full/DR 00:00:38 0 GigabitEthernet 0/1</pre>

Common Errors

N/A

5.4.12 Enabling Two-Way Maintenance

Configuration Effect

- Non-Hello packets can also be used to maintain the adjacency.

Notes

- The OSPF basic functions must be configured.

Configuration Steps

↳ Enabling Two-Way Maintenance

- (Optional) This function is enabled by default. You are advised to retain the default configuration.
- Perform this configuration on all routers.

Verification

- Non-Hello packets can also be used to maintain the adjacency.

Related Commands

↳ Enabling Two-Way Maintenance

Command	two-way-maintain
Parameter	N/A
Description	
Command Mode	OSPF routing process configuration mode
Usage Guide	On a large network, a lot of packets may be sent or received, occupying too much CPU and memory. As a result, some packets are delayed or discarded. If the processing time of Hello packets exceeds the dead interval, the adjacency will be destroyed due to timeout. If the two-way maintenance function is enabled, in addition to the Hello packets, the DD, LSU, LSR, and LSAck packets can also be used to maintain the bidirectional communication between neighbors when a large

	number of packets exist on the network. This prevents termination of the adjacency caused by delayed or discarded Hello packets.
--	--

Configuration Example

Scenario Figure 5-19	
Configuration Steps	<ul style="list-style-type: none"> ● Enable IPv6 on interfaces of all routers.(Omitted) ● Configure the OSPF basic functions on all routers. (Omitted) ● On Router A, enable the two-way maintenance function. (This function is enabled by default.)
A	<pre>A# configure terminal A(config)# ipv6 routerospf 1 A(config-router)#two-way-maintain</pre>
Verification	<ul style="list-style-type: none"> ● When the adjacency is being set up, Router A checks the neighbor dead interval and updates the dead interval without waiting for Router B to send a Hello packet.
A	<pre>A# show ipv6 ospfneighbor OSPFv3 Process (1), 1 Neighbors, 1 is Full: Neighbor ID Pri State Dead Time Instance ID Interface ----- 2.2.2.2 1 Full/DR 00:00:38 0 GigabitEthernet 0/1</pre>

Common Errors

N/A

5.4.13 Correlating OSPF with BFD

Configuration Effect

- Once a link is faulty, OSPF can quickly detect the failure of the route. This configuration helps shorten the traffic interruption time.

Notes

- The OSPF basic functions must be configured.
- The BFD parameters must be configured for the interface in advance.
- If BFD is configured for both a process and an interface, the interface-based configuration takes effect preferentially.

Configuration Steps

↘ Correlating OSPF with BFD

- (Optional) Perform this configuration if you wish to accelerate OSPF network convergence.
- Perform this configuration on routers at both ends of the link.

Verification

- Run the **show bfd neighbor** command to verify that the BFD neighbors are normal.

Related Commands

📌 **Correlating an OSPF Interface with BFD**

Command	ipv6 ospf bfd [disable]
Parameter Description	disable: Disables BFD for link detection on a specified OSPF-enabled interface.
Command Mode	Interface configuration mode
Usage Guide	The interface-based configuration takes precedence over the bfd all-interfaces command used in process configuration mode. Based on the actual environment, you can run the ipv6 ospf bfd command to enable BFD on a specified interface for link detection, or run the bfd all-interfaces command in OSPF process configuration mode to enable BFD on all interface of the OSPF process, or run the ipv6 ospf bfd disable command to disable BFD on a specified interface.

📌 **Correlating an OSPF Process with BFD**

Command	bfd all-interfaces
Parameter Description	N/A
Command Mode	OSPF process configuration mode
Usage Guide	OSPF dynamically discovers neighbors through the Hello packets. After OSPF enables the BFD function, a BFD session will be set up to achieve the full adjacency, and use the BFD mechanism to detect the neighbor status. Once a neighbor failure is detected through BFD, OSPF performs network convergence immediately. You can also run the ipv6 ospf bfd [disable] command in interface configuration mode to enable or disable the BFD function on a specified interface, and this configuration takes precedence over the bfd all-interfaces command used in OSPF process configuration mode.

Configuration Example

Scenario Figure 5-20	
Configuration Steps	<ul style="list-style-type: none"> ● Enable IPv6 on interfaces of all routers.(Omitted) ● Configure the OSPF basic functions on all routers. (Omitted) ● Configure the BFD parameters for interfaces of all routers. ● Correlate OSPF with BFD on all routers.

<p>A</p>	<pre>A# configure terminal A(config)# interface GigabitEthernet 0/1 A(config-if-GigabitEthernet0/1)#bfd interval 200 min_rx 200 multiplier 5 A(config)# ipv6 router ospf 1 A(config-router)#bfd all-interfaces</pre>
<p>B</p>	<pre>B(config)# interface GigabitEthernet 0/1 B(config-if-GigabitEthernet 2/1)#bfd interval 200 min_rx 200 multiplier 5 B(config)# ipv6 router ospf 1 B(config-router)#bfd all-interfaces</pre>
<p>Verification</p>	<ul style="list-style-type: none"> ● On Router A and Router B, verify that the BFD state is Up. ● Disconnect Router B from the switch. On Router A, verify that a neighbor is found disconnected during BFD, and the corresponding OSPF route is deleted.
<p>A</p>	<pre>A# show ipv6 ospf neighbor OSPFv3 Process (1), 1 Neighbors, 1 is Full: Neighbor ID Pri State BFD State Dead Time Instance ID Interface 2.2.2.2 1 Full/BDR Up 00:00:35 0 GigabitEthernet 0/1</pre>
<p>B</p>	<pre>B# show ipv6 ospf neighbor OSPFv3 Process (1), 1 Neighbors, 1 is Full: Neighbor ID Pri State BFD State Dead Time Instance ID Interface 1.1.1.1 1 Full/DR Up 00:00:35 0 GigabitEthernet 0/1</pre>

Common Errors

N/A

5.4.14 Enabling GR

Configuration Effect

- When a distributed route switches services from the active board to the standby board, traffic forwarding continues and is not interrupted.
- When the OSPF process is being restarted, data forwarding continues and is not interrupted.

Notes

- The OSPF basic functions must be configured.
- The neighbor router must support the GR helper function.
- The grace period cannot be shorter than the neighbor dead time of the neighbor router.

Configuration Steps

➤ **Configuring the OSPF GR Function**

- (Optional) This function is enabled by default. You are advised to retain the default configuration.
- Perform this configuration on routers where hot standby switchover is triggered or the OSPF process is restarted.

➤ **Configuring the OSPF GR Helper Function**

- (Optional) This function is enabled by default. You are advised to retain the default configuration.
- Perform this configuration on a router if hot standby switchover is triggered or the OSPF process is restarted on a neighbor of this router.

Verification

- When a distributed router switches services from the active board to the standby board, data forwarding continues and the traffic is not interrupted.
- When the OSPF process is being restarted, data forwarding continues and the traffic is not interrupted.

Related Commands

➤ **Configuring the OSPF GR Function**

Command	graceful-restart [grace-period<i>grace-period</i> inconsistent-lsa-checking]
Parameter Description	grace-period <i>grace-period</i> : Indicates the grace period, which is the maximum time from occurrence of an OSPF failure to completion of the OSPF GR. The value of the grace period varies from 1s to 1800s. The default value is 120s. inconsistent-lsa-checking : Enables topological change detection. If any topological change is detected, OSPF exits the GR process to complete convergence. After GR is enabled, topological change detection is enabled by default.
Command Mode	OSPF routing process configuration mode
Usage Guide	<p>The GR function is configured based on the OSPF process. You can configure different parameters for different OSPF processes based on the actual conditions. This command is used to configure the GR restarter capability of a device. The grace period is the maximum time of the entire GR process, during which link status is rebuilt so that the original state of the OSPF process is restored. After the grace period expires, OSPF exits the GR state and performs common OSPF operations.</p> <p>Run the graceful-restart command to set the grace period to 120s. The graceful-restart grace-period command allows you to modify the grace period explicitly.</p> <p>The precondition for successful execution of GR and uninterrupted forwarding is that the topology remains stable. If the topology changes, OSPF quickly converges without waiting for further execution of GR, thus avoiding long-time forwarding black-hole.</p> <ul style="list-style-type: none"> ● Disabling topology detection: If OSPF cannot converge in time when the topology changes during the hot standby process, forwarding black-hole may appear in a long time. ● Enabling topology detection: Forwarding may be interrupted when topology detection is enabled, but the interruption time is far shorter than that when topology detection is disabled. <p>In most cases, it is recommended that topology detection be enabled. In special scenarios, topology detection can be disabled if the topology changes after the hot standby process, but it can be ensured that the forwarding black-hole will not appear in a long time. This can minimize the forwarding interruption time during the hot standby process.</p> <p>If the Fast Hello function is enabled, the GR function cannot be enabled.</p>

➤ **Configuring the OSPF GR Helper Function**

Command	graceful-restart helper { disable strict-lsa-checking internal-lsa-checking }
Parameter	disable: Prohibits a device from acting as a GR helper for another device.
Description	<p>strict-lsa-checking: Indicates that changes in Type 1 to Type 5 and Type 7 LSAs will be checked during the period that the device acts as a GR helper to determine whether the network changes. If the network changes, the device will stop acting as the GR helper.</p> <p>internal-lsa-checking: Indicates that changes in Type 1 to Type 3 LSAs will be checked during the period that the device acts as a GR helper to determine whether the network changes. If the network changes, the device will stop acting as the GR helper.</p>
Command Mode	OSPF routing process configuration mode
Usage Guide	<p>This command is used to configure the GR helper capability of a router. When a neighbor router implements GR, it sends a Grace-LSA to notify all neighbor routers. If the GR helper function is enabled on the local router, the local router becomes the GR helper on receiving the Grace-LSA, and helps the neighbor to complete GR. The disable option indicates that GR helper is not provided for any device that implements GR.</p> <p>After a device becomes the GR helper, the network changes are not detected by default. If any change takes place on the network, the network topology converges after GR is completed. If you wish that network changes can be quickly detected during the GR process, you can configure strict-lsa-checking to check Type 1 to 5 and Type 7 LSAs that indicate the network information or internal-lsa-checking to check Type 1 to 3 LSAs that indicate internal routes of the AS domain. When the network scale is large, it is recommended that you disable the LSA checking options (strict-lsa-checking and internal-lsa-checking) because regional network changes may trigger termination of GR and consequently reduce the convergence of the entire network.</p>

Configuration Example

Scenario Figure 5-21	
Configuration Steps	<ul style="list-style-type: none"> ● Enable IPv6 on interfaces of all routers.(Omitted) ● Configure the OSPF basic functions on all routers. (Omitted) ● On Router A, Router C, and Router D, enable the GR helper function. (This function is enabled by default.) ● On Router B, enable the GR function.
B	<pre> B# configure terminal B(config)# ipv6 router ospf1 B(config-router)# graceful-restart </pre>

Verification	<ul style="list-style-type: none"> ● Trigger a hot standby switchover on Router B, and verify that the routing tables of destination Network 1 and Network 2 remain unchanged on Router A during the switchover. ● Trigger a hot standby switchover on Router B, ping destination Network 1 from Router A, and verify that traffic forwarding is not interrupted during the switchover.
---------------------	---

Common Errors

- Traffic forwarding is interrupted during the GR process because the configured grace period is shorter than the neighbor dead time of the neighbor router.

5.4.15 Enabling NSR

Configuration Effect

- During an active/standby switchover of devices in distributed or Virtual Switch Unit (VSU) mode, data forwarding continues and is not interrupted.

Notes

- The OSPF basic functions must be configured.

Configuration Steps

↳ Enabling the OSPF NSR Function

- (Optional) This function is disabled by default. Enable it when required.

Verification

- During a hot-backup switchover of devices in distributed or VSU mode, data forwarding continues and is not interrupted.

Related Commands

↳ Enabling NSR

Command	nsr
Parameter Description	N/A
Command Mode	OSPF routing configuration mode
Usage Guide	<p>This command is used to enable the NSR function. For the same OSPF process, either NSR or GR is enabled because they are mutually exclusive. Nevertheless, when NSR is enabled, the GR helper capability is supported.</p> <p>The switchover of devices in distributed or VSU mode takes a period of time. If the OSPF neighbor keepalive duration is shorter than the switchover duration, the OSPF neighbor relationship with the neighbor device is removed, and services are interrupted during the switchover. Therefore, it is recommended that the OSPF neighbor keepalive duration be no less than the default value when the NSR function is enabled. It is recommended that Fast Hello be disabled because when it is enabled, the OSPF neighbor keepalive duration is less than 1 second.</p>

Configuration Example

- i** The following configuration is performed based on OSPF basic functions. For details about OSPF basic functions, see section 5.4.1 “Configuring OSPF Basic Functions”.

<p>Scenario</p>	
<p>Configuration Steps</p>	<ul style="list-style-type: none"> ● Configure interface IPv6 addresses for all routers. ● Configure OSPF basic functions for all routers. ● Enable the NSR function for router B.
<p>B</p>	<pre>B# configure terminal B(config)# ipv6 router ospf 1 B(config-router)# nsr</pre>
<p>Verification</p>	<ul style="list-style-type: none"> ● A hot-backup switchover is performed for router B. During the switchover, routing tables for target networks 1 and 2 on router A remain unchanged. ● A hot-backup switchover is performed for router B. During the switchover, router A can continuously ping target network 1.

Common Errors

- The neighbor keepalive duration is short. When Fast Hello is enabled, the OSPF neighbor relationship times out during a switchover, causing forwarding interruption.

5.4.16 Configuring Network Management Functions

Configuration Effect

- Use the network management software to manage OSPF parameters and monitor the OSPF running status.

Notes

- The OSPF basic functions must be configured.
- You must enable the MIB function of the SNMP server before enabling the OSPF MIB function.
- You must enable the trap function of the SNMP server before enabling the OSPF trap function.
- You must enable the logging function of the device before outputting the OSPF logs.

Configuration Steps

➤ **Binding the MIB with the OSPF Process**

- (Optional) This configuration is required if you want to use the network management software to manage parameters of a specified OSPF process.
- Perform this configuration on all routers.

➤ **Enabling the Trap Function**

- (Optional) This configuration is required if you want to use the network management software to monitor the OSPF running status.
- Perform this configuration on all routers.

➤ **Configuring the Logging Function**

- (Optional) This function is enabled by default. You are advised to retain the default configuration. If you want to reduce the log output, disable this function.
- Perform this configuration on all routers.

Verification

- Use the network management software to manage the OSPF parameters.
- Use the network management software to monitor the OSPF running status.

Related Commands

➤ **Binding the MIB with the OSPF Process**

Command	enable mib-binding
Parameter	N/A
Description	
Command Mode	OSPF routing process configuration mode
Usage Guide	The OSPFv2 MIB does not have the OSPFv3 process information. Therefore, you can perform operations only on a single OSPFv2 process through SNMP. By default, the OSPFv3 MIB is bound with the OSPFv3 process with the smallest process ID, and all user operations take effect on this process. If you wish to perform operations on a specified OSPFv3 process through SNMP, run this command to bind the MIB with the process.

➤ **Enabling the Trap Function**

Command	enable traps[error [IfConfigError IfRxBadPacket VirtIfConfigError VirtIfRxBadPacket] state-change[IfStateChange NbrStateChange NssaTranslatorStatusChange VirtIfStateChange VirtNbrStateChange RestartStatusChange NbrRestartHelperStatusChange VirtNbrRestartHelperStatusChange]]
Parameter Description	IfConfigError: Indicates that an interface parameter configuration error occurs. IfRxBadPacket: Indicates that the interface receives a bad packet. VirtIfConfigError: Indicates that a virtual interface parameter configuration error occurs.

	<p>VirtIfRxBadPacket: Indicates that the virtual interface receives a bad packet.</p> <p>IfStateChange: Indicates that interface state changes.</p> <p>NbrStateChange: Indicates that the neighbor state changes.</p> <p>NssaTranslatorStatusChange: Indicates that the NSSA state changes.</p> <p>VirtIfStateChange: Indicates that the virtual interface state changes.</p> <p>VirtNbrStateChange: Indicates that the virtual neighbor state changes.</p> <p>RestartStatusChange: Indicates that the GR state of the local device changes.</p> <p>NbrRestartHelperStatusChange: Indicates that the state of the neighbor GR process changes.</p> <p>VirtNbrRestartHelperStatusChange: Indicates that the GR state of the virtual neighbor changes.</p>
Command Mode	OSPF routing process configuration mode
Usage Guide	<p>The function configured by this command is restricted by the snmp-server enable traps ospf and then enable traps command before the corresponding OSPF traps can be correctly sent out.</p> <p>This command is not restricted by the MIB bound with the process. The trap function can be enabled concurrently for different processes.</p>

↘ **Configuring the Logging Function**

Command	log-adj-changes[detail]
Parameter Description	detail: Records all status change information.
Command Mode	OSPF routing process configuration mode
Usage Guide	N/A

Configuration Example

<p>Scenario Figure 5-22</p>	
<p>Configuration Steps</p>	<ul style="list-style-type: none"> ● Enable IPv6 on interfaces of all routers.(Omitted) ● Configure the OSPF basic functions on all routers. (Omitted) ● Bind the MIB with the OSPF process on Router A. ● Enable the trap function on Router A.

A	<pre>A# configure terminal A(config)#snmp-server host 192.168.2.2 traps version 2c public A(config)#snmp-server community public rw A(config)#snmp-server enable traps A(config)# A(config)# ipv6 routerospf 10 A(config-router)# enable mib-binding A(config-router)# enable traps</pre>
Verification	<ul style="list-style-type: none"> ● Use the MIB tool to read and set the OSPF parameters and display the OSPF running status.

Common Errors

N/A

5.4.17 Modifying Protocol Control Parameters

Configuration Effect

- Modify protocol control parameters to change the protocol running status.

Notes

- The OSPF basic functions must be configured.
- The neighbor dead time cannot be shorter than the Hello interval.

Configuration Steps

↘ Configuring the Hello Interval

- (Optional) You are advised to retain the default configuration.
- Perform this configuration on routers at both end of a link.

↘ Configuring the Dead Interval

- (Optional) You are advised to retain the default configuration. This configuration can be adjusted if you wish to accelerate OSPF convergence when a link fails.
- Perform this configuration on routers at both end of a link.

↘ Configuring the LSU Retransmission Interval

- (Optional) You are advised to adjust this configuration if a lot of routes exist in the user environment and network congestion is serious.

↘ Configuring the LSA Generation Time

- (Optional) You are advised to retain the default configuration.

↘ Configuring the LSA Group Refresh Time

- (Optional) You are advised to retain the default configuration. This configuration can be adjusted if a lot of routes exist in the user environment.
- Perform this configuration on an ASBR or ABR.

➤ **Configuring LSA Repeated Receiving Delay**

- (Optional) You are advised to retain the default configuration.

➤ **Configuring the SPF Computation Delay**

- (Optional) This configuration can be adjusted if network flapping frequently occurs.

➤ **Configuring the Inter-Area Route Computation Delay**

- (Optional) You are advised to retain the default configuration.
- Perform this configuration on all routers.

➤ **Configuring the Inter-Area Route Computation Delay**

- (Optional) You are advised to retain the default configuration.
- Perform this configuration on all routers.

Verification

- Run the **show ipv6 ospf** and **show ipv6 ospf neighbor** commands to display the protocol running parameters and status.

Related Commands

➤ **Configuring the Hello Interval**

Command	ipv6ospf hello-interval <i>seconds</i>
Parameter Description	<i>seconds</i> : Indicates the interval at which OSPF sends the Hello packet. The unit is second. The value ranges from 1 to 65,535.
Command Mode	Interface configuration mode
Usage Guide	The Hello interval is contained in the Hello packet. A shorter Hello interval indicates that OSPF can detect topological changes more quickly, but the network traffic increases. The Hello interval must be the same on all routers in the same network segment. If you want to manually modify the neighbor dead interval, ensure that the neighbor dead interval is longer than the Hello interval.

➤ **Configuring the Dead Interval**

Command	ipv6ospf dead-interval <i>seconds</i>
Parameter Description	<i>seconds</i> : Indicates the time that the neighbor is declared lost. The unit is second. The value ranges from 2 to 65535.
Command Mode	Interface configuration mode
Usage Guide	The OSPF dead interval is contained in the Hello packet. If OSPF does not receive a Hello packet from a neighbor within the dead interval, it declares that the neighbor is invalid and deletes this neighbor record from the neighbor list. By default, the dead interval is four times the Hello interval. If the Hello interval is modified, the dead interval is modified

	<p>automatically.</p> <p>When using this command to manually modify the dead interval, pay attention to the following issues:</p> <ol style="list-style-type: none"> 1. The dead interval cannot be shorter than the Hello interval. 2. The dead interval must be the same on all routers in the same network segment.
--	--

📌 **Configuring the LSU Transmission Delay**

Command	ipv6ospf transmit-delay <i>seconds</i>
Parameter Description	<i>seconds</i> : Indicates the LSU transmission delay on the OSPF interface. The unit is second. The value ranges from 0 to 65,535.
Command Mode	Interface configuration mode
Usage Guide	<p>Before an LSU packet is transmitted, the Age fields in all LSAs in this packet will increase based on the amount specified by the ip ospf transmit-delay command. Considering the transmission delay and line propagation delay on the interface, you need to set the LSU transmission delay to a greater value for a low-speed line or interface. The LSU transmission delay of a virtual link is defined by the transmit-delay parameter in the area virtual-link command.</p> <p>If the value of the Age field of an LSA reaches 3600, the packet will be retransmitted or a retransmission will be requested. If the LSA is not updated in time, the expired LSA will be deleted from the LSDB.</p>

📌 **Configuring the LSU Retransmission Interval**

Command	ipv6ospf retransmit-interval <i>seconds</i>
Parameter Description	<i>seconds</i> : Indicates the LSU retransmission interval. The unit is second. The value ranges from 0 to 65,535. This interval must be longer than the round-trip transmission delay of data packets between two neighbors.
Command Mode	Interface configuration mode
Usage Guide	<p>After a router finishes sending an LSU packet, this packet is still kept in the transmit buffer queue. If an acknowledgment from the neighbor is not received within the time defined by the ip ospf retransmit-interval command, the router retransmits the LSU packet.</p> <p>The retransmission delay can be set to a greater value on a serial line or virtual link to prevent unnecessary retransmission. The LSU retransmission delay of a virtual link is defined by the retransmit-interval parameter in the area virtual-link command.</p>

📌 **Configuring the LSA Generation Time**

Command	timers throttle lsa all <i>delay-time hold-time max-wait-time</i>
Parameter Description	<p><i>delay-time</i>: Indicates the minimum delay for LSA generation. The first LSA in the database is always generated instantly. The value ranges from 0 to 600,000. The unit is ms.</p> <p><i>hold-time</i>: Indicates the minimum interval between the first LSA update and the second LSA update. The value ranges from 1 to 600,000. The unit is ms.</p> <p><i>max-wait-time</i>: Indicates the maximum interval between two LSA updates when the LSA is updated continuously. This interval is also used to determine whether the LSA is updated continuously. The value ranges from 1 to 600,000. The unit is ms.</p>
Command Mode	OSPF routing process configuration mode
Usage Guide	If a high convergence requirement is raised when a link changes, you can set delay-time to a smaller value. You can also appropriately increase values of the preceding parameters to reduce the CPU usage.

	When configuring this command, the value of hold-time cannot be smaller than the value of delay-time , and the value of max-wait-time cannot be smaller than the value of hold-time .
--	---

↘ Configuring the LSA Group Refresh Time

Command	timers pacinglsa-group <i>seconds</i>
Parameter Description	<i>seconds</i> : Indicates the LSA group pacing interval. The value ranges from 10 to 1,800. The unit is second.
Command Mode	OSPF routing process configuration mode
Usage Guide	<p>Every LSA has a time to live (LSA age). When the LSA age reaches 1800s, a refreshment is needed to prevent LSAs from being cleared because their ages reaching the maximum. If LSA update and aging computation are performed for every LSA, the device will consume a lot of CPU resources. In order to use CPU resources effectively, you can refresh LSAs by group on the device. The interval of group refreshment is called group pacing interval. The group refreshment operation is to organize the LSAs generated within a group pacing interval into a group and refresh the group as a whole.</p> <p>If the total number of LSAs does not change, a larger group pacing interval indicates that more LSAs need to be processed after timeout. To maintain the CPU stability, the number of LSAs processes upon each timeout cannot be too large. If the number of LSAs is large, you are advised to reduce the group pacing interval. For example, if there are 1000 LSAs in the database, you can reduce the pacing interval; if there are 40 to 100 LSAs, you can set the pacing interval to 10-20 minutes.</p>

↘ Configuring the LSA Group Refresh Interval

Command	timers pacing lsa-transmit <i>transmit-time transmit-count</i>
Parameter Description	<p><i>transmit-time</i>: Indicates the LSA group transmission interval. The value ranges from 10 to 600,000. The unit is ms.</p> <p><i>transmit-count</i>: Indicates the number of LS-UPD packets in a group. The value ranges from 1 to 200.</p>
Command Mode	OSPF routing process configuration mode
Usage Guide	<p>If the number of LSAs is large and the device load is heavy in an environment, properly configuring transmit-time and transmit-count can limit the number of LS-UPD packets flooded on a network.</p> <p>If the CPU usage is not high and the network bandwidth load is not heavy, reducing the value of transmit-time and increasing the value of transmit-count can accelerate the environment convergence.</p>

↘ Configuring LSA Repeated Receiving Delay

Command	timers lsa arrival <i>arrival-time</i>
Parameter Description	<i>arrival-time</i> : Indicates the delay after which the same LSA is received. The value ranges from 0 to 600,000. The unit is ms.
Command Mode	OSPF routing process configuration mode
Usage Guide	No processing is performed if the same LSA is received within the specified time.

↘ Configuring the SPF Computation Delay

Command	timers throttle spf <i>spf-delay spf-holdtime spf-max-waittime</i>
Parameter Description	<p><i>spf-delay</i>: Indicates the SPF computation delay. The unit is ms. The value ranges from 1 to 600,000. When detecting a topological change, the OSPF routing process triggers the SPF computation at least after spf-delay elapses.</p> <p><i>spf-holdtime</i>: Indicates the minimum interval between two SPF computations. The unit is ms. The value ranges from 1 to</p>

	<p>600,000.</p> <p><i>spf-max-waittime</i>: Indicates the maximum interval between two SPF computations. The unit is ms. The value ranges from 1 to 600,000.</p> <p><i>number</i>: Indicates the metric of the summarized route.</p>
Command Mode	OSPF routing process configuration mode
Usage Guide	<p>spf-delay indicates the minimum time between the occurrence of the topological change and the start of SPF computation. spf-holdtime indicates the minimum interval between the first SPF computation and the second SPF computation. After that, the interval between two SPF computations must be at least twice of the previous interval. When the interval reaches spf-max-waittime, the interval cannot increase again. If the interval between two SPF computations already exceeds the required minimum value, the interval is computed by starting from spf-holdtime. You can set spf-delay and spf-holdtime to smaller values to accelerate topology convergence, and set spf-max-waittime to a larger value to reduce SPF computation. Flexible settings can be used based on stability of the network topology.</p> <p>Compared with the timers spf command, this command supports more flexible settings to accelerate the convergence speed of SPF computation and further reduce the system resources consumed by SPF computation when the topology continuously changes. Therefore, you are advised to use the timers throttle spf command for configuration.</p> <ol style="list-style-type: none"> The value of spf-holdtime cannot be smaller than the value of spf-delay; otherwise, spf-holdtime will be automatically set to the value of spf-delay. The value of spf-max-waittime cannot be smaller than the value of spf-holdtime; otherwise, spf-max-waittime will be automatically set to the value of spf-holdtime. The configurations of timers throttle spf and timers spf are mutually overwritten. When both timers throttle spf and timers spf are not configured, the default values of timers throttle spf prevail.

📌 **Configuring the Computation Delays of Inter-Area Routes and External Routes**

Command	timers throttle route {inter-area <i>aia-delay</i> asease-delay}
Parameter Description	<p>inter-area<i>aia-delay</i>: Indicates the inter-area route computation delay. The unit is ms. The value ranges from 0 to 600,000.</p> <p>asease-delay: Indicates the external route computation delay. The unit is ms. The value ranges from 0 to 600,000.</p>
Command Mode	OSPF routing process configuration mode
Usage Guide	<p>If a strict requirement is raised for the network convergence time, use the default value.</p> <p>If a lot of inter-area or external routes exist on the network and the network is not stable, adjust the delays and optimize route computation to reduce the load on the device.</p>

Configuration Example

📌 **Configuring the Hello Interval and Dead Interval**

<p>Scenario</p> <p>Figure 5-23</p>	
---	--

<p>Configuration Steps</p>	<ul style="list-style-type: none"> ● Enable IPv6 on interfaces of all routers.(Omitted) ● Configure the OSPF basic functions on all routers. (Omitted) ● Configure the Hello interval and dead interval on all routers.
<p>A</p>	<pre>A# configure terminal A(config)# interface GigabitEthernet 0/1 A(config-if-GigabitEthernet 0/1)# ipv6 ospf hello-interval 15 A(config-if-GigabitEthernet 0/1)# ipv6 ospf dead-interval 50</pre>
<p>B</p>	<pre>B# configure terminal B(config)# interface GigabitEthernet 0/1 B(config-if-GigabitEthernet 0/1)# ipv6 ospf hello-interval 15 A(config-if-GigabitEthernet 0/1)# ipv6 ospf dead-interval 50</pre>
<p>Verification</p>	<ul style="list-style-type: none"> ● Check the interface parameters on Router A and Router B. Verify that the Hello interval is 10s and the dead interval is 50s. ● On Router A and Router B, verify that the OSPF neighbor information is correct.
<p>A</p>	<pre>A# show ipv6 ospf interface GigabitEthernet 0/1 is up, line protocol is up Interface ID 2 IPv6 Prefixes fe80::2d0:f8ff:fe22:3346/64 (Link-Local Address) OSPFv3 Process (1), Area 0.0.0.0, Instance ID 0 Router ID 1.1.1.1,Network Type BROADCAST, Cost: 1 Transmit Delay is 1 sec, State DR, Priority 1 Timer interval configured, Hello 15, Dead 50, Wait 40, Retransmit 10 Hello due in 00:00:06 Neighbor Count is 1, Adjacent neighbor count is 1 Hello received 40 sent 40, DD received 17 sent 9 LS-Req received 1 sent 3, LS-Upd received 6 sent 5 LS-Ack received 3 sent 4, Discarded 1 A# show ipv6 ospf neighbor OSPFv3 Process (1), 1 Neighbors, 1 is Full: Neighbor ID Pri State Dead Time Instance ID Interface 2.2.2.21 Full/BDR 00:00:30 0 GigabitEthernet 0/1</pre>

```

B
B# show ipv6 ospf interface

GigabitEthernet 0/1 is up, line protocol is up

Interface ID 2

IPv6 Prefixes

    fe80::2d0:f8ff:fe22:3446/64 (Link-Local Address)

OSPFv3 Process (1), Area 0.0.0.0, Instance ID 0

    Router ID 2.2.2.2,Network Type BROADCAST, Cost: 1

    Transmit Delay is 1 sec, State BDR, Priority 1

    Timer interval configured, Hello 15, Dead 50, Wait 40, Retransmit 10

    Hello due in 00:00:06

    Neighbor Count is 1, Adjacent neighbor count is 1

    Hello received 40 sent 40, DD received 17 sent 9

    LS-Req received 1 sent 3, LS-Upd received 6 sent 5

    LS-Ack received 3 sent 4, Discarded 1

B# show ipv6 ospf neighbor

OSPFv3 Process (1), 1 Neighbors, 1 is Full:

Neighbor ID    Pri   State           Dead Time   Instance ID  Interface
1.1.1.11      Full/DR      00:00:38    0           GigabitEthernet 0/1
    
```

Common Errors

- The configured neighbor dead time is shorter than the Hello interval.

5.5 Monitoring

Clearing

Running the **clear** commands may lose vital information and thus interrupt services.

Description	Command
Clears and resets an OSPF process.	clear ipv6 ospf [<i>process-id</i>] process

Displaying

Description	Command
Displays the OSPF process configurations.	show ipv6 ospf [<i>process-id</i>]
Displays information about the OSPF LSDB.	show ipv6 ospf [<i>process-id</i>] database [<i>lsa-type</i> [adv-router <i>router-id</i>]]
Displays OSPF-enabled interfaces.	show ipv6 ospf [<i>process-id</i>] interface [<i>interface-type interface-number</i> brief]

Description	Command
Displays the OSPF neighbor list.	show ipv6 ospf [<i>process-id</i>] neighbor [<i>interface-type interface-number</i> [detail]] <i>neighbor-id</i> [detail]
Displays the OSPF routing table.	show ipv6 ospf [<i>process-id</i>] route [count]
Displays the summarized route of OSPF redistributed routes.	show ipv6 ospf [<i>process-id</i>] summary-prefix
Displays the OSPF network topology information.	show ipv6 ospf [<i>process-id</i>] topology [<i>area-area-id</i>]
Displays OSPF virtual links.	show ipv6 ospf [<i>process-id</i>] virtual-links

Debugging



System resources are occupied when debugging information is output. Therefore, disable debugging immediately after use.

Description	Command
Debugs OSPF events.	debug ipv6 ospf events [<i>abr asbr os router vlink</i>]
Debugs OSPF interfaces.	debug ipv6 ospf ifsm [<i>events status timers</i>]
Debugs OSPF neighbors.	debug ipv6 ospf nfm [<i>events status timers</i>]
Debugs the OSPF NSM.	debug ipv6 ospf nsm [<i>interface redistribute route</i>]
Debugs OSPF LSAs.	debug ipv6 ospf lsa [<i>flooding generate install maxage refresh</i>]
Debugs OSPF packets.	debug ipv6 ospf packet [<i>dd detail hello ls-ack ls-request ls-update rcv send</i>]
Debugs OSPF routes.	debug ipv6 ospf route [<i>ase ia install spf time</i>]

6 Configuring IS-IS

6.1 Overview

Intermediate System to Intermediate System (IS-IS) is an extensible, robust, and easy-to-use Interior Gateway Protocol (IGP) for route selection and applicable to an IP-ISO CLNS dual environment network (ISO CLNS is short for International Organization for Standardization Connectionless Network Service).

IS-IS has the common characteristics of a link state protocol. It sends Hello packets to discover and maintain neighbor relationships, and sends Link State Protocol Data Units (LSPs) to neighbors to advertise its link state. IS-IS supports Level-1 routing and Level-2 routing. All devices at the same Level maintain the same Link State Database (LSDB), which stores the LSPs generated by the devices to notify each other of the Level's network topology. Each device uses the Dijkstra Shortest Path First (SPF) algorithm to perform best-route calculation, path selection, and fast convergence.

Protocols and Standards

- RFC1142: OSI IS-IS Intra-domain Routing Protocol
- RFC1195: Use of OSI IS-IS for routing in TCP/IP and dual environments
- RFC3786: Extending the Number of Intermediate System to Intermediate System (IS-IS) Link State PDU (LSP) Fragments Beyond the 256 Limit
- RFC3373: Three-Way Handshake for Intermediate System to Intermediate System (IS-IS) Point-to-Point Adjacencies
- RFC3358: Optional Checksums in Intermediate System to Intermediate System (IS-IS)

- RFC3784: Intermediate System to Intermediate System (IS-IS) Extensions for Traffic Engineering (TE)
- RFC2763: Dynamic Hostname Exchange Mechanism for IS-IS
- RFC6119(draft-ietf-isis-ipv6-te-00): IPv6 Traffic Engineering in IS-IS
- RFC 2966: Domain-wide Prefix Distribution with Two-Level IS-IS

6.2 Applications

Application	Description
Planar Topology	A planar topology is applicable to a small-scale network. At the initial stage of large-scale network construction, core devices are deployed to form an area based on a planar topology.
Hierarchical Topology	A hierarchical topology is applicable to a large-scale network with frequent link flapping.

6.2.1 Planar Topology

Scenario

A planar topology is formed by devices in the same area. See Figure 6- 1.

Figure 6- 1 Planar Topology

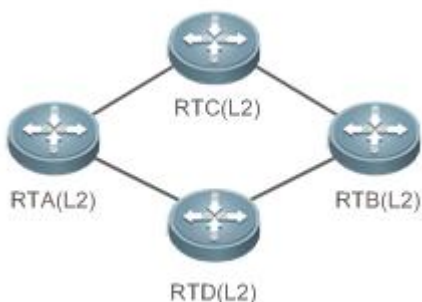

Deployment

- To facilitate future extension and reduce device burden, configure the devices in a planar topology as Level-2 devices.

6.2.2 Hierarchical Topology

Scenario

A hierarchical topology divides the network into the core layer, convergence layer, and access layer. See Figure 6- 2.

- Route summarization at the convergence layer is facilitated by address planning.
- When primary and secondary routes exist, devices at the convergence layer leak Level-2 routes to Level-1 areas.

Figure 6- 2 Hierarchical Topology

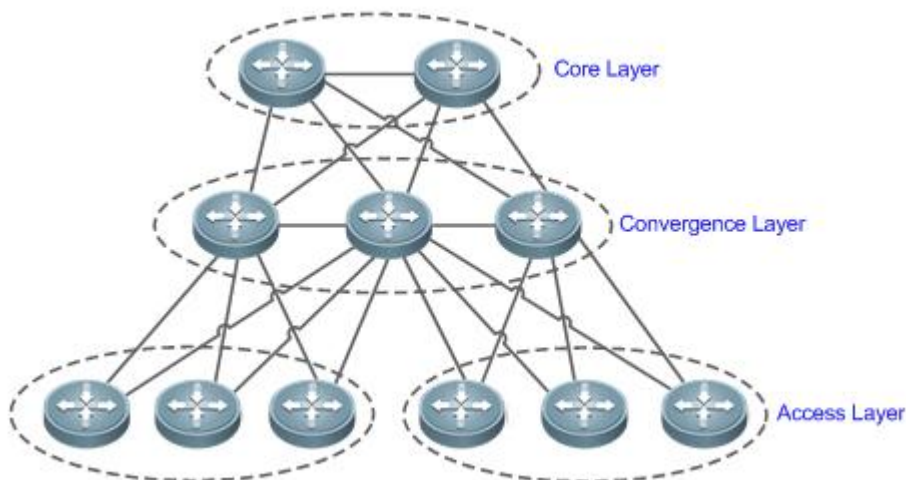

Remarks	Devices at the core layer must be connected consecutively.
----------------	--

Deployment

- Design the network topology starting from the core layer.
- Configure devices at the core layer as Level-2 devices.
- Configure devices at the convergence layer as Level-1/Level-2 devices.
- Configure devices at the access layer as Level-1 devices.

6.3 Features

Basic Concepts

↘ End System (ES)

An ES is a non-router device, for example, a host.

↘ Intermediate System (IS)

An IS is a router, which is the basic unit used to transmit routing information and generate routes in IS-IS.

↘ End System to Intermediate System Routing Exchange Protocol (ES-IS)

ES-IS is the protocol used for communication between ESs and ISs in Open System Interconnection (OSI) to dynamically discover Level-2 neighbor relationships.

↘ Domain

A set of ISs in the same routing domain (RD) use the same routing protocol to exchange routing information.

↘ Area

An RD can be divided into multiple areas.

↘ Complete Serial Number PDU (CSNP)

CSNPs are sent by a Designated Intermediate System (DIS) every 10s to synchronize link states in a broadcast network.

➤ **Partial Sequence Number PDU (PSNP)**

PSNPs are sent by a point-to-point (P2P) link to confirm LSPs, or request LSPs in a broadcast network.

➤ **Connectionless Network Protocol (CLNP)**

CLNP is an OSI protocol used to transmit data and error messages at the network layer. It is similar to the IP protocol.

➤ **Connectionless Network Service (CLNS)**

The CLNS is a type of unreliable connection and requires no circuit setup before data transmission.

➤ **Designated Intermediate System (DIS)**

Similar to a DIS router (DR) in Open Shortest Path First (OSPF), a DIS propagates LSPs to other machines in a Local Area Network (LAN). Neighbor relationships are established not only between DISs and other machines but also between those machines. This characteristic is not possessed by OSPF.

➤ **Hello Packet**

Hello packets are used to establish and maintain neighbor relationships.

➤ **LSP**

LSPs describe link states, similar to link-state advertisement (LSA) in OSPF, but the former do not depend on TCP/IP information. LSPs are classified into Level-1 LSPs and Level-2 LSPs, depending on different route types.

➤ **Network Selector (NSEL)**

An NSEL (sometimes referred to as SEL) specifies the target network-layer protocol service. It is similar to the TCP/UDP port for the Upper Layer Service in the IP protocol. In IS-IS, SEL is typically set to 00 to indicate a device.

➤ **Network Service Access Point (NSAP)**

An NSAP is the CLNS complete address, including the OSI address and high-layer processes. It consists of an area ID, a system ID, and SEL. When SEL is set to 00, the NSAP is a Network Entity Title (NET), similar to an IP address plus a protocol number.

➤ **Sub-Network Point of Attachment (SNPA)**

An SNPA provides physical connections and network-layer services. It is similar to a MAC address used in the IP protocol, a Data Link Connection Identifier (DLCI) used by frame relay (FR), or High-Level Data Link Control (HDLC) in a wide area network (WAN).

➤ **Level-1 Route**

A Level-1 route is an intra-area route that only receives relevant information within the area. To reach other areas, you need to store in Level-1 a default route destined for the closest Level-2.

➤ **Level-2 Route**

A Level-2 route is an inter-area backbone route. Level-1 and Level-2 cannot be connected directly.

➤ **Level-1/Level-2 Route**

A Level-1/Level-2 route is a border route connecting a Level-1 route and a Level-2 route. It maintains two databases for the Level-1 and Level-2 routes respectively. It is similar to an area border router (ABR) in OSPF.

➤ **Pseudonode**

A pseudonode identifies a broadcast subnet (LAN) and allows a broadcast medium to work as a virtual device, which has a route as its interface. The route-pseudonode relationship is managed by a DIS.

Network Entity Title (NET)

A NET is part of an OSI address and describes the area ID and system ID, but it does not define the NSEL, which is contained in the NSAP of the specified system.

Circuit

Circuit is an interface-related term used in IS-IS. Whereas NSAP and NET indicate whole devices, a circuit indicates an interface. The circuit ID of a P2P interface is one byte long. For example, the circuit ID of HDLC is 0x00. In a broadcast network (for example, a LAN), the circuit ID is seven bytes long, including the system ID, for example, 1921.6800.0001.01.

 For details about terms related to IS-IS, see ISO 10589 and RFC1195.

Overview

Feature	Description
IS-IS Network Hierarchy	An IS-IS network is divided into Level-1 and Level-2. The nodes on which devices exchange information in the same area form one Level (Level-1).
IS-IS Address Coding Mode	An IS-IS address is called a NET, which consists of an area ID, a system ID, and an NSAP identifier.
IS-IS Packet Types	There are three types of IS-IS packets: LSP, IS-IS Hello packet (IIH PDU), and serial number packet (SNP) classified into CSNP and PSNP.
DIS Election	A DIS simulates multiple access links as a pseudonode and generates LSPs for the pseudonode. The pseudonode sets up a relationship with each device in the local network and forbids direct communication between the devices.
IS-IS Supported TLV Types	IS-IS supports 21 types of Type-Length-Value (TLV).
LSP Fragment Extension	IS-IS floods LSPs to advertise link states. The size of an LSP is limited by the Maximum Transmission Unit (MTU) size of the link. When the content to be advertised exceeds one LSP, IS-IS will create LSP fragments to carry new link state information.
IS-IS VRF	VPN Routing and Forwarding (VRF) is mainly used for local routing and packet separation. It avoids route conflict caused by use of the same prefix by multiple VPNs.
IS-IS MTR	Multi-Topology Routing (MTR) is mainly used to calculate IPv4 and IPv6 unicast routes in IS-IS based on different topologies.

6.3.1 IS-IS Network Hierarchy

An IS-IS network is divided into Level-1 and Level-2. The nodes on which devices exchange information in the same area form one Level (Level-1).

Working Principle

All devices in an area know the area's network topology and exchange data within the area. A Level-1/Level-2 device is a border device that belongs to different areas and provides inter-area connections. Areas are connected by Level-2 devices. The border devices in various areas form a Level-2 backbone network for inter-area data exchange.

Level-1 devices are only interested in the local area's topology, including all nodes in the local area and the next-hop devices destined for the nodes. Level-1 devices access other areas through Level-2 devices and forward packets from a target network outside of the local area to the closest Level-2 device.

Figure 6- 3 IS-IS Network Topology

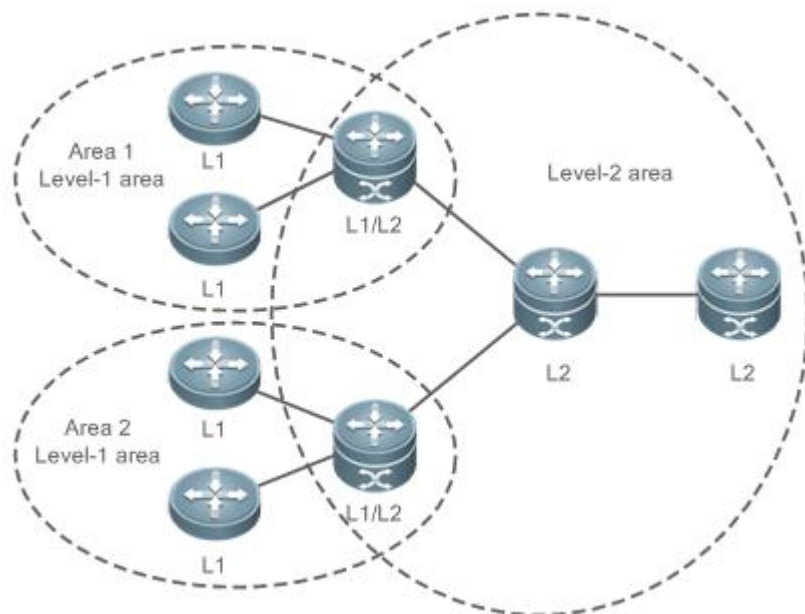

Related Configuration

Setting the Circuit Type of an IS-IS Interface

By default, **circuit-type** is set to Level-1/Level-2.

Run the **isis circuit-type** command to change the Level of an interface.

If **circuit-type** is set to Level-1 or Level-2-only, IS-IS will only send PDUs of the corresponding Level.

Specifying the IS-IS Level

By default, **is-type** is set to Level-1/Level-2 if no IS-IS instance runs at Level-2 (including Level-1/Level-2). **is-type** is set to Level-1 if there are IS-IS instances running at Level-2 (including Level-1/Level-2).

Run the **is-type** command to specify the Level at which IS-IS will run.

Changing the **is-type** value will enable or disable the routes of a certain Level. A device can have only one instance running at Level-2 (including Level-1/Level-2).

6.3.2 IS-IS Address Coding Mode

An IS-IS address is called a NET, which consists of an area ID, a system ID, and an NSAP identifier, ranging from eight to 20 bytes.

Working Principle

Figure 6-4 NET Address Format

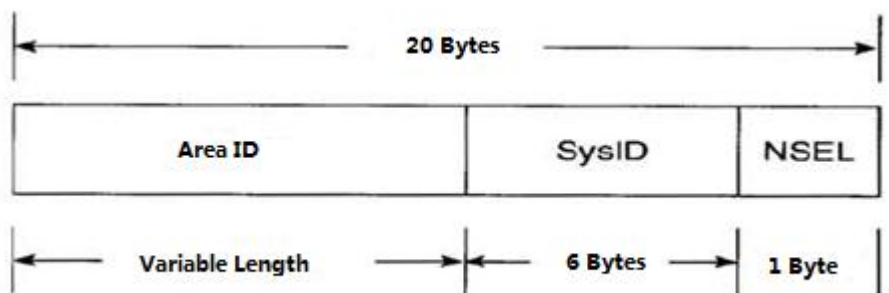

- The area ID identifies the RD length in an area and is fixed relative to the RD. It ranges from one to 13 bytes.
- The system ID is unique in an autonomous system (AS).
- The NSAP is a network selector and sometimes called SEL. In IS-IS, SEL is typically set to 00 to indicate a device.

Related Configuration

📌 **Configuring a NET Address in IS-IS**

By default, no NET address is configured in IS-IS.

Run the **net** command to configure a NET address in IS-IS.

The command configures an area ID and a system ID in IS-IS. Different NET addresses must have the same system ID.

6.3.3 IS-IS Packet Types

There are three types of IS-IS packets:

- LSP
- IIH PDU
- SNP (classified into CSNP and PSNP)

Working Principle

There are three types of IS-IS packets:

- LSP

LSPs are used to transmit link state records within an area and are classified into Level-1 LSPs and Level-2 LSPs. LSPs are only flooded to the corresponding Level.

- IIH PDU

IIH PDUs are used to maintain neighbor relationships. They carry multicast MAC addresses used to determine whether other systems run IS-IS.

- SNP (classified into CSNP and PSNP)

CSNPs are used for LSDB synchronization. By default, a DIS sends a CSNP every 10s in a broadcast network. In a P2P network, a CSNP is sent only after a neighbor relationship is established.

PSNPs are also used for LSDB synchronization.

Related Configuration

✚ Configuring the LSP Interval on an IS-IS Interface

By default, the LSP interval is 33 ms. If no Level is specified, the interval takes effect for Level-1 and Level-2 LSPs.

Run the **isis lsp-interval** command to configure the LSP interval on an IS-IS interface, in the unit of seconds.

The command changes the LSP interval.

✚ Configuring the Maximum Number of LSP PDUs Sent by IS-IS Interface at a Time

The default value is 5. If no particular level is designated, the default level is set to **level-1-2**, that is, the configuration of the maximum number takes effect at Level-1 and Level-2 concurrently.

Run the **isis lsp-flood** command to set the number of LSP PDUs sent by the IS-IS interface at a time.

You can use this command to change the maximum number of LSP PDUs sent by the interface at a time.

✚ Configuring the Interval for Receiving Duplicate LSP Packets

By default, this command is not configured and the function of setting the interval for receiving LSP packets is not supported. If no particular level is designated, the default level is set to **level-1-2**, that is, the interval configuration takes effect at Level-1 and Level-2 concurrently.

Run the **min-lsp-arrival** command to set the interval for receiving duplicate LSP packets.

During network flapping, LSP packets are frequently duplicated and the LSP packet sequence number constantly increases. If the device processes the duplicate LSP packets, more system resources are consumed. Therefore, setting the interval for receiving duplicate LSP packets can relieve device load.

✚ Configuring the Hello Packet Interval on an IS-IS Interface

By default, the Hello packet interval is 10s for Level-1 and Level-2.

Run the **isis hello-interval** command to configure the Hello packet interval on an IS-IS interface, in the unit of seconds.

The command changes the Hello packet interval. A DIS sends Hello packets at a frequency three times that by non-DIS devices in a broadcast network. If an IS is elected as the DIS on the interface, by default, the interface sends a Hello packet every 3.3s.

✚ Configuring the Minimum PSNP Interval

By default, the minimum PSNP interval is not configured, and the default interval 2s takes effect for Level-1 and Level-2 PSNPs.

Run the **isis psnp-interval** command to configure the minimum PSNP interval, in the unit of seconds.

PSNPs are mainly used to request LSPs that are absent locally or respond to received LSPs (in a P2P network). The PSNP interval should be minimized. If many LSPs exist and the device performance is low, you can increase the PSNP interval and LSP retransmission interval to reduce the device burden.

✚ Configuring the CSNP Broadcast Interval on an IS-IS Interface

By default, CSNPs are sent at 10s intervals in a broadcast network. No CSNPs are sent in a P2P network. When you configure a new CSNP interval without Level-1 or Level-2 specified, the interval takes effect for Level-1 and Level-2 CSNPs.

Run the **isis csnp-interval** command to specify the CSNP broadcast interval on an IS-IS interface, in the unit of seconds.

The command changes the CSNP interval. By default, a DIS sends a CSNP every 10s in a broadcast network. In a P2P network, a CSNP is sent only after a neighbor relationship is established. An interface set to **mesh-groups** can be configured to periodically send CSNPs. No CSNPs are sent if the CSNP interval is set to 0.

6.3.4 DIS Election

A DIS is a designated device in a broadcast network and works like a DR in OSPF.

A pseudonode is generated by a DIS and sets up a relationship with each device in the local network.

Working Principle

A DIS simulates multiple access links as a pseudonode and generates LSPs for the pseudonode. The pseudonode sets up a relationship with each device in the local network and forbids direct communication between the devices. A broadcast subnet and a non-broadcast multiple access (NBMA) network are considered as pseudonodes externally. Non-DIS devices report their link states to the DIS in the same network, and the DIS maintains the link states reported by all ISs in the network. Like DR election in OSPF, a DIS is elected to reduce unnecessary neighbor relationships and route information exchanges.

DIS election in IS-IS is preemptive. The election result can be manually controlled through interface priority configuration. The device with a higher interface priority is more likely to be elected as the DIS.

Related Configuration

✚ Configuring the Priority for DIS Election in a LAN

By default, Priority 64 takes effect for Level-1 and Level-2.

Run the **isis priority** command to configure the priority for DIS election in a LAN.

The command changes the priority carried in Hello packets in a LAN. The device with a lower priority is less likely to be elected as the DIS.

The command is invalid on a P2P network interface. The **no isis priority** command, with or without parameters, restores the priority to its default value. To change the configured priority, run the **isis priority** command with the priority specified to overwrite the existing configuration, or you can first restore the priority to its default value and then configure a new priority.

6.3.5 IS-IS Supported TLV Types

IS-IS supports 26 types of TLV.

Working Principle

The following table lists the IS-IS supported TLV types:

TLV Code	Description
Code = 1	Area ID
Code = 2	Priority of an IS neighbor
Code = 3	ES neighbor
Code = 6	MAC address of an IS neighbor
Code = 8	Filling field
Code = 9	LSP entity
Code = 10	Verification field
Code = 14	Size of the source LSP buffer

TLV Code	Description
Code = 22	Extended IS reachability
Code = 128	IP internal reachability information
Code = 129	Supported protocol
Code = 130	IP external reachability information
Code = 131	Inter-domain routing protocol information
Code = 132	IP interface address
Code = 133	Verification information
Code = 135	Extended IP reachability TLV
Code = 137	Dynamic host name
Code = 211	Graceful Restart (GR)
Code = 222	Multi-Topology (MT) IS reachability
Code = 229	MT TLV
Code = 211	GR
Code=232	IPv6 interface
Code = 235	IPv4 MT IP reachability TLV
Code =236	IPv6 IP reachability TLV
Code = 237	IPv6 MT IP reachability TLV
Code = 240	P2P three-way handshake TLV

Related Configuration

📌 Configuring the Neighbor Detection Protocol Carried in Hello Packets

By default, neighbor detection is enabled.

Run the **adjacency-check** command to configure the neighbor detection protocol carried in Hello packets.

6.3.6 LSP Fragment Extension

IS-IS floods LSPs to advertise link states. The size of an LSP is limited by the MTU size of the link. When the content to be advertised exceeds one LSP, IS-IS will create LSP fragments to carry new link state information. According to ISO standards, an LSP fragment is identified by a one-byte LSP number. An IS-IS device can generate up to 256 LSP fragments.

Working Principle

The 256 LSP fragments are insufficient in any of the following situations:

26. New applications (such as traffic engineering [TE]) extend new TLV or Sub-TLV.
27. The network is expanded continuously.
28. Routes with reduced granularity are advertised, or other routes are redistributed to IS-IS.

After LSP fragments are used up, new routing information and neighbor information will be discarded, causing network exceptions such as routing black holes or loops. LSP fragments must be extended to carry more link state information, thus ensuring normal network operation.

You can configure an additional system ID and enable fragment extension to allow IS-IS to advertise more link state information in extended LSP fragments. Each virtual system can be considered as a virtual device that establishes a neighbor relationship (with the

path value being 0) with the originating system. Extended LSPs are published by the neighbor of the originating system, that is, the virtual system.

The following terms are related to fragment extension:

↳ **Normal System ID**

The system ID defined by ISO is used to establish neighbor relationships and learn routes. It is further defined as the normal system ID in order to be distinguished from the additional system ID introduced to fragment extension.

↳ **Additional System ID**

The additional system ID is configured by an administrator to generate extended LSPs. The additional system ID shares the usage rules of the normal system ID (for example, the additional system ID must be unique in the entire area), except that the additional system ID is not carried in Hello packets for neighbor relationship establishment.

↳ **Originating System**

An originating system is an IS-IS-enabled device and maps a virtual system identified by the additional system ID.

↳ **Virtual System (Virtual IS)**

A virtual system is identified by the additional system ID and used to generate extended LSPs. The virtual system concept is proposed by RFC for distinguishing from the originating system concept. Each virtual system can generate up to 256 LSP fragments. The administrator can configure multiple additional system IDs (virtual systems) to generate more LSP fragments.

↳ **Original LSP**

An original LSP is the LSP whose system ID contained in the LSP ID is a normal system ID. Original LSPs are generated by an originating system.

↳ **Extended LSP**

An extended LSP is the LSP whose system ID contained in the LSP ID is an additional system ID. Extended LSPs are generated by a virtual system.

Related Configuration

↳ **Enabling Fragment Extension**

By default, fragment extension is disabled. If you do not specify a Level when enabling fragment extension, it will take effect for Level-1 and Level-2 LSPs.

Run the **lsp-fragments-extend** command to enable fragment extension.

There are up to 256 LSP fragments. When the fragments are used up, subsequent link state information, including neighbor information and IP route information, will be discarded, causing a network exception. To solve this problem, enable fragment extension at the specified Level and configure an additional system ID by using the **virtual-system** command.

6.3.7IS-IS VRF

VRF is mainly used for local routing and packet separation. It avoids route conflict caused by use of the same prefix by multiple VPNs. IPv4 VPN and IPv6 VPN combine Multiprotocol Label Switching (MPLS) advantages in terms of Quality of Service (QoS) and security

assurance, and are the primary solutions for interconnecting the geographically different office branches of an enterprise or industry user.

Working Principle

Figure 6- 5 Separation of Different VPNs by VRF Tables Configured on Provider Edge (PE) Devices

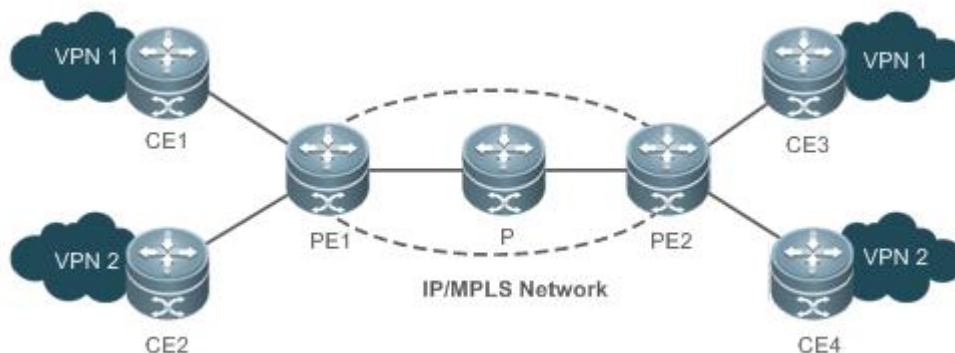

In Figure 6- 5, the following configuration requirements exist: Configure the two sites (CE1 and CE3) in VPN1 to access each other and the two sites (CE2 and CE4) in VPN2 to access each other, and forbid access between the sites in VPN1 and those in VPN2, because VPN1 and VPN2 belong to different customers or departments and may have identical IP addresses.

The customer edge (CE) devices connect the customer network to the PEs to exchange VPN routing information with the PEs, that is, advertise local routes to the PEs and learn remote routes from the PEs.

Each PE learns routes from directly connected CEs and exchanges the learned VPN routes with the other PE through the Border Gateway Protocol (BGP). The PEs provide access to the VPN service.

The Provider (P) device in the Service Provider (SP) network is not directly connected to the CEs. The P device only needs the MPLS forwarding capability and does not maintain VPN information.

The IS-IS protocol running between the PEs and CEs requires the VRF capability to separate routing information between VPN1 and VPN2. That is, IS-IS only learns routes through VRF.

Related Configuration

📌 Binding an IS-IS Instance with a VRF Table

By default, an IS-IS instance is not bound with any VRF table.

Run the **VRF** command to bind an IS-IS instance with a VRF table.

Note the following constraints or conventions for the binding operation:

- The IS-IS instances bound with the same non-default VRF table must be configured with different system IDs. The IS-IS instances bound with different VRF tables can be configured with the same system ID.
- One IS-IS instance can be bound with only one VRF table, but one VRF table can be bound to multiple IS-IS instances.
- When the VRF table bound to an IS-IS instance is changed, all IS-IS interfaces associated with the instance will be deleted. That is, the **ip (or ipv6) router isis [tag]** interface configuration and the redistribution configuration in routing process mode will be deleted.

6.3.8 IS-IS MTR

IS-IS MTR is an extended feature used to separate IPv4 unicast route calculation and IPv6 unicast route calculation based on topologies. It complies with the specification of IS-IS MT extension defined in RFC 5120. New TLV types are introduced to IIH PDUs and LSPs to transmit IPv6 unicast topology information. One physical network can be divided into an IPv4 unicast logical topology and an IPv6 unicast logical topology. The two topologies perform SPF calculation separately and maintain independent IPv4 and IPv6 unicast routing tables respectively. In this way, IPv4 unicast service traffic and IPv6 unicast service traffic are forwarded by different paths. The IS-IS MTR technique helps users deploy IPv6 unicast networks without the constraint on consistency between IPv4 and IPv6 unicast topology information.

IS-IS MTR is derived from IS-IS MT, which is used to separate IPv4 and IPv6 unicast topologies, unicast and multicast topologies, and topologies using different protocol stacks (such as IPv4 and Pv6). IS-IS MTR separates IPv4 and IPv6 unicast topologies based on IS-IS MT.

Working Principle

Figure 6-6 shows a typical networking application. The following implementation requirements exist: Deploy an IPv6 unicast topology in incremental mode, and upgrade some devices to support IPv4 and IPv6 dual protocol stacks while keeping other IPv4-enabled devices unchanged.

Figure 6-6 Physical Topology for IPv4-IPv6 Hybrid Deployment

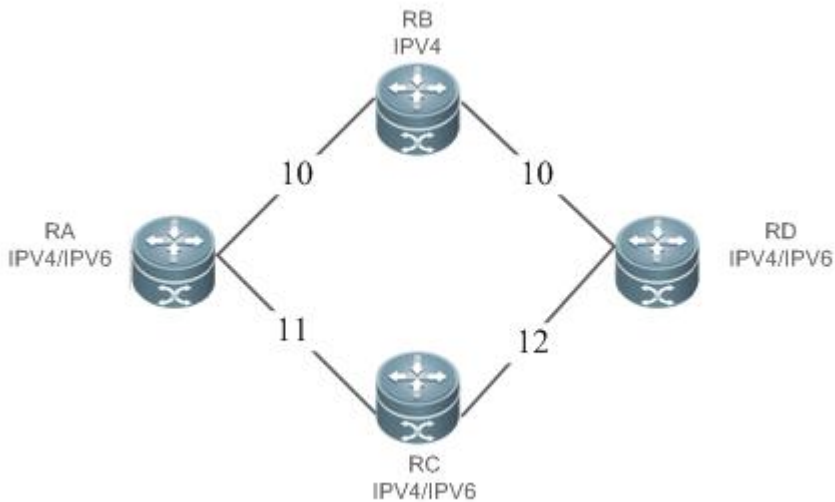

In Figure 6-6, each link is marked by a number indicating its metric. RB only supports the IPv4 protocol stack, whereas other devices support IPv4 and IPv6 dual protocol stacks.

The networking constraint on consistency between IPv4 and IPv6 unicast topologies must be canceled to retain the use of RB; otherwise, RB cannot establish a neighbor relationship with RA or RD, which will cause new problems.

Figure 6-7 IPv4-IPv6 Hybrid Topology

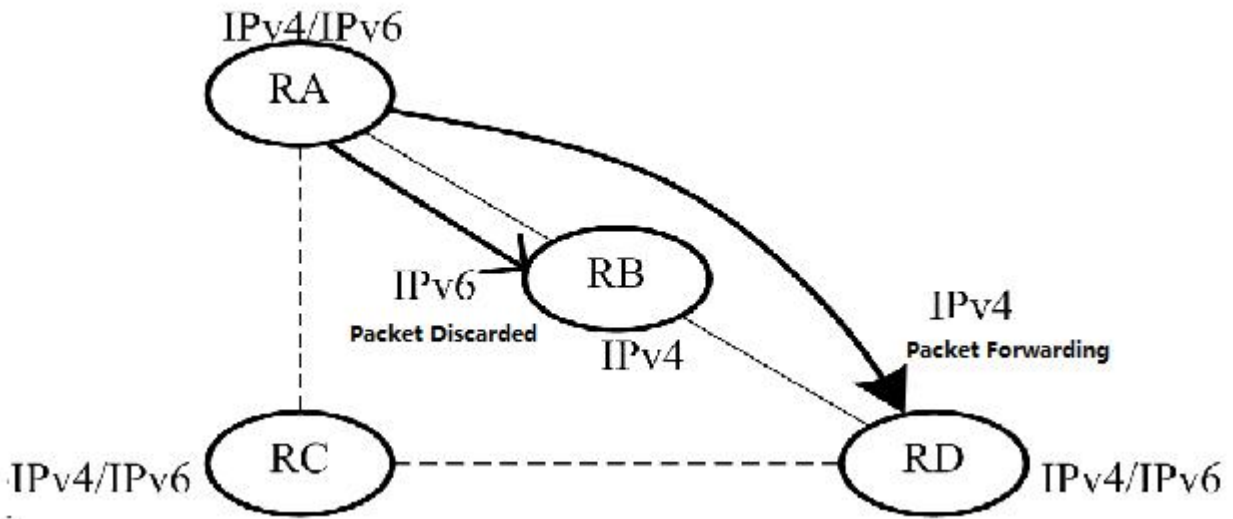

In Figure 6-7, without IS-IS MTR support, the SPF calculations performed by RA, RB, RC, and RD only take into account the single hybrid topology. The calculated shortest path is RA -> RB -> RD, with the overhead being 20. RB will discard IPv6 packets because it does not support IPv6.

Figure 6-8 Separation of IPv4 and IPv6 Topologies

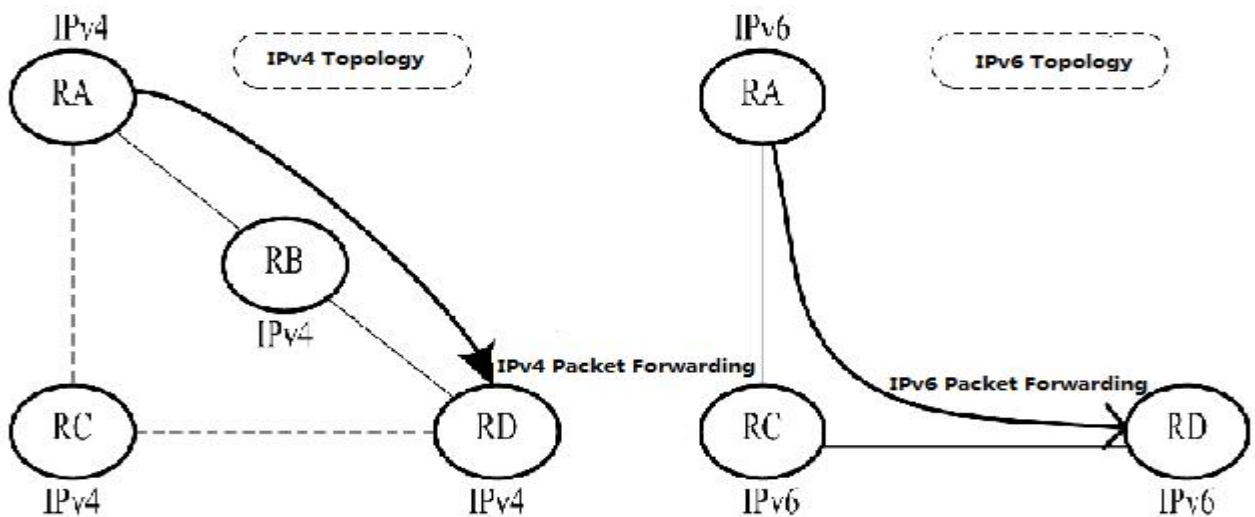

In Figure 6-8, the IS-IS MTR technique is used to separate IPv4 and IPv6 unicast topologies. RA, RB, RC, and RD establish neighbor relationships based on the IPv4 unicast topology and IPv6 unicast topology respectively. The left part shows the IPv4 topology formed by IPv4-enabled routers. The calculated IPv4 shortest path is RA -> RB -> RC, which realizes IPv4 packet forwarding. The right part shows the IPv6 topology formed by IPv6-enabled routers. The calculated IPv6 shortest path is RA -> RC -> RD, which realizes IPv6 packet forwarding.

IS-IS MTR must be deployed to avoid routing black holes when some devices support only one protocol. IS-IS MTR is not required when all devices support IPv4 and IPv6 dual protocol stacks.

- Deployment of a new network: IS-IS MTR is not required when devices only support the IPv4 protocol stack. For devices that only support the IPv6 protocol stack or devices that support IPv4 and IPv6 dual protocol stacks, enable the MT mode of IS-IS MTR. You are advised not to enable Multi-Topology Transition (MTT); otherwise, loops may occur.

- Reconstruction of an existing network with devices supporting only one protocol stack: Enable the MTT mode of IS-IS MTR on devices that support IPv4 and IPv6 dual protocol stacks in sequence (starting from the device closest to a device supporting only one protocol stack in the network topology). After the MTT mode is enabled on all new devices, switch the MTT mode to the MT mode on these devices in sequence (starting from the device farthest from a device supporting only one protocol stack in the network topology).

Related Configuration

📌 Enabling MTR for IS-IS Instances

By default, IS-IS instances are not enabled with MTR.

Run the **multi-topology** command to configure IS-IS to support IPv6 unicast topologies. After that, IPv4 and IPv6 unicast routes in IS-IS will be calculated based on different topologies.

Note the following constraints or conventions when you use the **multi-topology** command:

29. Set **metric-style** to **Wide** or **Transition** before you run the command.
30. The MTR feature will be disabled if **metric-style** is set to **Narrow** or only one Level is configured to support the Wide or Transition mode.

6.3.9 IS-IS Neighbor

The following conditions must be met for two routing devices to establish a neighbor relationship when IS-IS MTR is not configured:

- The interface addresses on both routing devices are in the same network segment.
- The interface Levels on both routing devices match.
- The routing devices are authenticated by each other.
- The routing devices support the same protocol.



The following conditions must be met for routing devices to establish a neighbor relationship when IS-IS MTR is configured:

- The interface addresses on both routing devices are in the same network segments.
- The interface Levels on both routing devices match.
- The routing devices are authenticated by each other.
- The routing devices have at least one consistent MT ID when P2P links are configured.
- There are no constraints on the MT IDs that the routing devices support when LAN links are configured.

6.4 Configuration







Configuration	Description and Command	
Enabling IS-IS	 (Mandatory) It is used to enable IS-IS on specified interfaces. You need to create an IS-IS routing process in advance.	
	router isis [tag]	Starts an IS-IS routing process. <i>tag</i> indicates the process name.
	net <i>areaAddress.SystemId.00</i>	Configures a NET address in IS-IS.
	ip router isis [tag]	Enables IS-IS on an interface. <i>tag</i> indicates the



Configuration	Description and Command	
		name of the IS-IS routing process.
Configuring IS-IS Hello Packets	(Optional) It is used to configure the IS-IS Hello packet holdtime.	
	isis hello-interval { <i>interval</i> minimal } [level-1 level-2]	Configures the Hello packet interval on an interface. The value range is 1 to 65,535, in the unit of seconds.
	isis hello-multiplier <i>multiplier-number</i> [level-1 level-2]	Configures the Hello packet holdtime multiplier on an IS-IS interface. The value range is 2 to 100. The default value is 3.
Configuring IS-IS LSPs	(Optional) It is used to perform time-related LSP configuration, determine whether to ignore LSP checksum errors, and enable/disable LSP fragment extension.	
	isis lsp-interval <i>interval</i> [level-1 level-2]	Configures the minimum LSP interval on an interface. The value range is 1 to 4,294,967,295, in the unit of milliseconds.
	isis lsp-flood <i>lsp-number</i> [level-1 level-2]	Indicates the maximum number of LSP packets sent by the IS-IS interface at a time. The value range is 1 to 1000 . The default value is 5 .
	isis retransmit-interval <i>interval</i> [level-1 level-2]	Configures the LSP retransmission interval by P2P links on an interface. The value range is 0 to 65,535, in the unit of seconds.
	lsp-gen-interval [level-1 level-2] <i>maximum-interval</i> [<i>initial-interval</i> <i>hold-interval</i>]	Configures LSP generation cycle. <i>maximum-interval</i> : Indicates the maximum interval for generating two consecutive LSP packets. The value range is 1 to 65535 (in seconds). The default value is 5 . <i>initial-interval</i> : Indicates the waiting time for generating an LSP packet for the first time. The value range is 0 to 60000 (in milliseconds). The default value is 50 . <i>hold-interval</i> : Indicates the minimum interval for generating an LSP packet for the second time. The value range is 10 to 60000 (in milliseconds). The default value is 200 .
	ignore-lsp-errors	Configures to ignore LSP checksum errors.
	lsp-fragments-extend [level-1 level-2] [compatible rfc3786]	Enables fragment extension.
	virtual-system <i>system-id</i>	Configures an additional system ID.
Configuring IS-IS SNPs	(Optional) It is used to configure the CSNP broadcast interval.	
	isis csnp-interval <i>interval</i> [level-1 level-2]	Configures the CSNP interval on an interface. The value range is 0 to 65,535, in the unit of seconds. The default value is 10s. No CSNPs are sent if the CSNP interval is set to 0.

Configuration	Description and Command	
Configuring the IS-IS Level Type	 (Optional) It is used to configure the system type or interface circuit type in IS-IS.	
	is-type { level-1 level-1-2 level-2-only }	Configures the system type.
	isis circuit-type { level-1 level-1-2 level-2-only } [external]	Configures the interface circuit type.
Configuring IS-IS Authentication	 (Optional) It is used to configure interface authentication, area authentication, and RD authentication.	
	isis password [0 7] <i>password</i> [send-only] [level-1 level-2]	Configures the password for plaintext authentication of Hello packets on an interface. When send-only is included, the authentication password is only used to authenticate sent Hello packets. Received Hello packets are not authenticated. If no Level is specified, the configured authentication and password take effect for all Levels. This command does not take effect if the isis authentication mode command is executed. Both commands are used to configure IS-IS interface authentication, but the isis password command has a lower priority. Before you run the isis password command, delete the isis authentication mode command configuration.
	isis authentication mode { text md5 } [level-1 level-2]	Specifies authentication as plaintext or MD5. If no Level is specified, the authentication mode takes effect for all Levels. If you use this command after the isis password password [level-1 level-2] command is executed, the previous command configuration will be overwritten. Both commands are used to configure IS-IS interface authentication, but the isis authentication mode command has a higher priority.
	isis authentication key-chain <i>name-of-chain</i> [level-1 level-2]	Configures the password for interface authentication. If no Level is specified, the configured key chain takes effect for all Levels. This command must be used with the isis authentication mode command to configure IS-IS interface authentication.
isis authentication send-only [level-1 level-2]	(Optional) Specifies that interface authentication is performed only on sent packets. Received packets are not authenticated.	

Configuration	Description and Command	
		<p>If no Level is specified, the send-only authentication mode takes effect for all Levels. This command is used to avoid network flapping caused by a temporary authentication failure when IS-IS authentication is configured. Before you deploy IS-IS authentication in the entire network, run the isis authentication mode { text md5 } [level-1 level-2] and isis authentication key-chain name-of-chain [level-1 level-2] commands on each device. After that, run the no isis authentication send-only command to restore the authentication of received packets. This realizes smooth authentication deployment and avoids network flapping.</p>
	<p>area-password [0 7] password [send-only]</p>	<p>Configures the password for area (Level-1) plaintext authentication. When send-only is included, the authentication password is only used to authenticate sent packets. Received packets are not authenticated. This command does not take effect if the authentication mode command is executed. Both commands are used to configure IS-IS area authentication, but the area-password command has a lower priority. Before you run the area-password command, delete the authentication mode command configuration.</p>
	<p>authentication mode { text md5 } level-1</p>	<p>Specifies the IS-IS area authentication mode. If you use this command after the area-password password command is executed, the previous command configuration will be overwritten. Both commands are used to configure IS-IS area authentication, but the authentication mode command has a higher priority.</p>
	<p>authentication key-chain name-of-chain level-1</p>	<p>Configures the key chain for IS-IS area authentication. This command must be used with the authentication mode command to configure IS-IS area authentication.</p>
	<p>authentication send-only level-1</p>	<p>(Optional) Specifies that IS-IS area authentication is performed only on sent packets. Received packets are not authenticated. This command is used to avoid network flapping</p>

Configuration	Description and Command
	<p>caused by a temporary authentication failure when IS-IS authentication is configured. Before you deploy IS-IS authentication in the entire area, run the authentication mode { text md5 } level-1 and authentication key-chain name-of-chain level-1 commands on each device. After that, run the no authentication send-only command to restore the authentication of received packets. This realizes smooth authentication deployment and avoids network flapping.</p>
	<p>domain-password [0 7] password [send-only]</p> <p>Configures the password for RD (Level-2) plaintext authentication. When send-only is included, the authentication password is only used to authenticate sent packets. Received packets are not authenticated. This command does not take effect if the authentication mode command is executed. Both commands are used to configure IS-IS RD authentication, but the domain-password command has a lower priority. Before you run the domain-password command, delete the authentication mode command configuration.</p>
	<p>authentication mode { text md5 } level-2</p> <p>Specifies the IS-IS RD authentication mode. If you use this command after the domain-password password command is executed, the previous command configuration will be overwritten. Both commands are used to configure IS-IS RD authentication, but the authentication mode command has a higher priority.</p>
	<p>authentication key-chain name-of-chain level-2</p> <p>Configures the password for IS-IS RD authentication. This command must be used with the authentication mode command to configure IS-IS RD authentication.</p>
	<p>authentication send-only level-2</p> <p>(Optional) Specifies that IS-IS RD authentication is performed only on sent packets. Received packets are not authenticated. This command is used to avoid network flapping caused by a temporary authentication failure when IS-IS authentication is configured. Before you deploy IS-IS authentication in the entire RD,</p>

Configuration	Description and Command	
		run the authentication mode { text md5 } level-2 and authentication key-chain name-of-chain level-2 commands on each device. After that, run the no authentication send-only command to restore the authentication of received packets. This realizes smooth authentication deployment and avoids network flapping.
Configuring IS-IS GR	 (Optional) It is used to enable IS-IS GR.	
	graceful-restart	Enables the GR Restart capability on the device that works as a Restarter. By default, the GR Restart capability is enabled.
	graceful-restart grace-period seconds	(Optional) Configures the IS-IS GR time on the device that works as a Restarter. The default value is 300s.
	no graceful-restart helper disable	Enables the IS-IS GR Help capability on the device that works as a Helper. By default, the GR Help capability is enabled.
Configuring IS-IS NSR	 (Optional) It is used to enable IS-IS NSR.	
	nsr	Enables the IS-IS NSR. By default, it is disabled.
Configuring BFD Support for IS-IS	 (Optional) It is used to enable BFD support for IS-IS.	
	bfd all-interfaces [anti-congestion]	Enables BFD support for IS-IS on all interfaces.
	isis bfd [disable anti-congestion]	Enables or disables BFD support for IS-IS on the current interface.
Setting the IS-IS Overload Bit	 (Optional) It is used to set the overload bit in LSPs.	
	set-overload-bit [on-startup { seconds wait-for-bgp [bgpseconds] }] [suppress { [interlevel] [external] }] [level-1 level-2]	Sets the overload bit.
Configuring IS-IS VRF	 (Optional) It is used to bind an IS-IS instance with a VRF table.	
	vrf vrf-name	Binds an IS-IS instance with a VRF table.
Configuring IS-IS MTR	 (Optional) It is used to calculate IPv4 and IPv6 unicast routes in IS-IS based on different topologies.	
	multi-topology [transition]	Configures IS-IS to support IPv6 unicast topologies.
Configuring Simple Network Management Protocol (SNMP) for IS-IS	 (Optional) It is used to allow the SNMP software to perform Management Information Base (MIB) operations on IS-IS instances.	
	enable mib-binding	Performs MIB operations on the instance bound with Tag 1.
	configure terminal	Enters global configuration mode.

Configuration	Description and Command	
	snmp-server enable traps isis	Enables IS-IS trap globally.
	snmp-server host { <i>host-addr</i> ipv6 <i>ipv6-addr</i> } [vrf <i>vrfname</i>] [traps] [version { 1 2c 3 { auth noauth priv }] <i>community-string</i> [udp-port <i>port-num</i>]	Configures an SNMP host in global configuration mode to receive IS-IS trap messages.
	router isis	Enters IS-IS routing process configuration mode.
	enable traps all	Allows the sending of all IS-IS trap messages to the host with the IP address 10.1.1.1.
Configuring IS-IS Two-way Maintenance	 Optional.	
	two-way-maintain	Enables IS-IS two-way maintenance.
Configuring Other IS-IS Parameters	 Optional.	
	maximum-paths <i>maximum</i>	Configures the maximum number of IS-IS IPv4/IPv6 equal-cost paths.
	max-metric on-neighbor-up <i>seconds</i>	Configures the maximum metric for the connected routes after the first neighbor is up.
	lsp-length <i>receive size</i>	Configures the maximum length allowed for received LSPs.
	lsp-length originate <i>size</i> [level-1 level-2]	Configures the maximum length allowed for sent LSPs.
	passive-interface [default] { <i>interface-type</i> <i>interface-number</i> }	Configures a passive interface.
	bandwidth-reference <i>value</i>	Configures the bandwidth reference for IS-IS to automatically calculate the link metric.
	interfaces-protocol-compatible	Configures the TLV field of the IS-IS protocol to be padded based on protocols supported by an interface.
	is-name <i>name</i>	Configures the instance name.
	isis metric <i>metric</i> [level-1 level-2]	Configures the interface metric, which is valid only when metric-style is set to Narrow .
	isis wide-metric <i>metric</i> [level-1 level-2]	Configures the interface wide-metric value, which is valid only when metric-style is set to Wide .
	isis passive	Configures the passive interface.
	isis priority <i>value</i> [level-1 level-2]	Configures the priority for DIS election on an interface.
	isis suppress on-neighbor-up <i>seconds</i>	Suppresses the routing calculation after the IS-IS neighbor is up.
default-information originate [route-map <i>map-name</i>]	Generates a Level-2 default route, which will be advertised through LSPs. When the command includes the route-map option, a default route is generated only if the criteria in route-map are met.	
summary-address <i>ip-address net-mask</i> [level-1]	Configures an IPv4 summary route.	

Configuration	Description and Command
	level-2 level-1-2] [metric number]
	summary-prefix <i>ipv6-prefix/prefix-length</i> [level-1 level-2 level-1-2]
	ignore-lsp-errors
	log-adjacency-changes
	redistribute

6.4.1 Enabling IS-IS

Configuration Effect

- Before you run IS-IS, create an IS-IS routing process in global configuration mode. You can set the **tag** parameter after the **router isis** command to name the process. You can add different tags to configure different IS-IS routing processes. The setting of the **tag** parameter is optional.
- A system ID uniquely identifies an IS in a routing AS; therefore, the system ID must be unique across the AS. In IS-IS, each area may contain one or multiple area IDs. Normally, you only need to configure one area ID. You can configure multiple area IDs to realize area division. If an IS is configured with multiple area IDs, the system IDs must be the same.
- After an interface is added to the specified IS-IS routing process, the interface will establish a neighbor relationship.

Notes

- The Level-1 IS devices in an area must be configured with the same area ID.
- The core routing table does not distinguish the routing entries generated by different IS-IS routing processes.
- The IP addresses of interfaces connected between neighbors must be in the same network segment.
- If the two IP addresses are in different network segments, a neighbor relationship cannot be established.
- If you need to add an interface to the specified IS-IS routing process, set the **tag** parameter after the **ip router isis** command to indicate the process name.
- If you run the **no ip routing** command in global configuration mode, IS-IS will disable IPv4 routing on all interfaces. That is, the **no ip router isis [tag]** command is automatically executed on all interfaces. Other IS-IS settings remain unchanged.
- By default, CPU protection is enabled on devices. For packets mapped to the destination group addresses (AllISSystems, AllL1ISSystems, and AllL2ISSystems) in IS-IS, there is a default limit (for example, 400 pps) on the number of packets sent to the CPU. If a device has many neighbor relationships or sends Hello packets at short intervals, the IS-IS packets that the device receives may exceed the default limit, causing frequent flapping of neighbor relationships. To solve the problem, you can use the CPU protection command in global configuration mode to increase the limit.

Configuration Steps

➤ Starting an IS-IS Routing Process

- Mandatory.
- Perform this configuration in global configuration mode on each device, unless otherwise specified.

➤ Configuring a NET Address in IS-IS

- Mandatory.
- Perform this configuration in IS-IS routing process configuration mode on each device, unless otherwise specified.

↳ Enabling IS-IS on an Interfaces

- Mandatory.
- Perform this configuration in interface configuration mode on each device, unless otherwise specified.

Verification

- Check whether devices send Hello packets.
- Check whether devices establish neighbor relationships.
- Check whether devices exchange LSPs.

Related Commands

↳ Starting an IS-IS Routing Process

Command	router isis [tag]
Parameter	<i>tag</i> : Indicates the name of an IS-IS instance.
Description	
Command Mode	Global configuration mode
Usage Guide	<p>Use this command to initialize an IS-IS instance and enter IS-IS routing process configuration mode.</p> <p>An IS-IS instance will start running after a NET address is configured.</p> <p>If you set the tag parameter when you start an IS-IS routing process, you need to add the tag parameter when closing the IS-IS routing process.</p> <p>By default, CPU protection is enabled on devices. For packets mapped to the destination group addresses (AllISSystems, AllL1ISSystems, and AllL2ISSystems) in IS-IS, there is a default limit (for example, 400 pps) on the number of packets sent to the CPU. If a device has many neighbor relationships or sends Hello packets at short intervals, the IS-IS packets that the device receives may exceed the default limit, causing frequent flapping of neighbor relationships. To solve the problem, you can use the CPU protection command in global configuration mode to increase the limit.</p>

↳ Configuring a NET Address in IS-IS

Command	net <i>net-address</i>
Parameter	<i>net-address</i> :
Description	The NET address is in the format of XX.XXXX.YYYY.YYYY.YYYY.00. XX.XXXX indicates the area ID, and YYYY.YYYY.YYYY indicates the system ID.
Command Mode	IS-IS routing process configuration mode
Usage Guide	<p>Use this command to configure an area ID and a system ID in IS-IS.</p> <p>Different NET addresses must have the same system ID.</p>

↳ Enabling IS-IS on an Interface

Command	ip router isis [tag]
Parameter	<i>tag</i> : Indicates the name of an IS-IS instance.

Description	
Command Mode	Interface configuration mode
Usage Guide	Use this command to enable an interface to participate in IS-IS IPv4 routing. Use the no form of this command to disable the IS-IS routing process on the interface. If you run the no ip routing command in global configuration mode, IS-IS will disable IPv4 routing on all interfaces. That is, the no ip router isis [tag] command is automatically executed on all interfaces. Other IS-IS settings remain unchanged.

Configuration Example

📌 **Establishing a Neighbor Relationship on an IS-IS P2P Link**

Scenario	Router A and Router B are connected in P2P mode.
Figure 6-9 P2P Link Topology	
Configuration Steps	<ul style="list-style-type: none"> ● Configure IS-IS. ● Configure Wide Area Network (WAN) interfaces.
A	<pre>A(config)# router isis A(config-router)# net 49.0001.0000.0000.0001.00 A(config)# interface Serial 1/0 A(config-if)# ip address 192.168.1.1 255.255.255.252 A(config-if)# ip router isis</pre>
B	<pre>B(config)# router isis B(config-router)# net 49.0001.0000.0000.0002.00 B(config)# interface Serial 1/0 B(config-if)# ip address 192.168.1.2 255.255.255.252 B(config-if)# ip router isis</pre>
Verification	<ul style="list-style-type: none"> ● Enable sending of Hello packets from the interface 192.168.1.1 on Router A to the interface 192.168.1.2 on Router B. ● Establish an IS-IS neighbor relationship between Router A and Router B, with the neighbor state being Up. ● Check the LSPs on Router A and Router B. The system IDs 0000.0000.0001 and 0000.0000.0002 should exist.
A	<pre>A# show isis neighbors</pre>

	A# show isis database detail
B	B# show isis neighbors

➤ **Establishing a Neighbor Relationship on an IS-IS Broadcast Link**

Scenario	Router A, Router B, and Router C are interconnected through the Ethernet.
Figure 6- 10 IS-IS Broadcast Link Topology	
Configuration Steps	<ul style="list-style-type: none"> ● Configure IS-IS. ● Configure Ethernet interfaces.
A	<pre>A(config)# router isis A(config-router)# net 49.0001.0000.0000.0001.00 A(config)# interface GigabitEthernet 0/0 A(config-if)# ip address 10.1.1.1 255.255.255.0 A(config-if)# ip router isis</pre>
B	<pre>B(config)# router isis B(config-router)# net 49.0001.0000.0000.0002.00 B(config)# interface GigabitEthernet 0/0 B(config-if)# ip address 10.1.1.2 255.255.255.0 B(config-if)# ip router isis</pre>
C	<pre>C(config)# router isis C(config-router)# net 49.0001.0000.0000.0003.00 C(config)# interface GigabitEthernet 0/0 C(config-if)# ip address 10.1.1.3 255.255.255.0 C(config-if)# ip router isis</pre>
Verification	Enable sending of Hello packets from the interface 10.1.1.1 on Router A to the interface 10.1.1.2 on Router B and the interface 10.1.1.3 on Router C.

	<ul style="list-style-type: none"> ● Establish IS-IS neighbor relationships between Router A and Router B and between Router A and Router C, with the neighbor state being Up. ● Check the LSPs on Router A, Router B, and Router C. The system IDs 0000.0000.0001, 0000.0000.0002, and 0000.0000.0003 should exist.
A	<pre>A# show isis neighbors A# show isis database detail</pre>
B	<pre>B# show isis neighbors</pre>
C	<pre>C# show isis neighbors</pre>

📌 **Performing Simple IS-ISv6 Configuration**

Scenario	Router A and Router B are connected through the Ethernet.
Figure 6- 11 IS-ISv6 Broadcast Link Topology	
Configuration Steps	<ul style="list-style-type: none"> ● Configure IS-IS. ● Configure Ethernet interfaces.
A	<pre>A(config)# router isis A(config-router)# net 49.0001.0000.0000.0001.00 A(config)# interface GigabitEthernet 0/0 A(config-if)# ipv6 address 1000 ::1/112 A(config-if)# ipv6 router isis</pre>
B	<pre>B(config)# router isis B(config-router)# net 49.0001.0000.0000.0002.00 B(config)# interface GigabitEthernet 0/0 B(config-if)# ipv6 address 1000 ::2/112 B(config-if)# ipv6 router isis</pre>
Verification	<p>Enable sending of Hello packets from the interface 1000 ::1 on Router A to the interface 1000 ::2 on Router B. Establish an IS-IS neighbor relationship between Router A and Router B, with the neighbor state being Up. Check the LSPs on Router A and Router B. The system IDs 0000.0000.0001 and 0000.0000.0002 should exist.</p>
A	<pre>A# show isis neighbors</pre>

	A# show isis database detail
B	B# show isis neighbors

Common Errors

- The IP addresses of the interfaces connected between neighbors are not in the same network segment.
- The **ip router isis** command is not executed on interfaces.
- No NET address is configured, or different NET addresses exist at Level-1.
- **max-area-addresses** is configured differently on both sides.
- **metric-style** is configured differently on both sides.
- The interface Levels on both sides are different. One side is Level-1, whereas the other side is Level-2.
- One side is configured with the P2P mode, whereas the other side is configured with the broadcast mode.
- One side is enabled with authentication, whereas the other side is not.

6.4.2 Configuring IS-IS Hello Packets

Configuration Effect

- Configure the Hello packet interval on an interface. The value range is 1 to 65,535, in the unit of seconds.
- Configure the Hello packet holdtime multiplier on an IS-IS interface.

Notes

- You can change the Hello packet holdtime by using the **isis hello-multiplier** command or **isis hello-interval** command or both.
- By default, CPU protection is enabled on devices. For packets mapped to the destination group addresses (AllISSystems, AllL1ISSystems, and AllL2ISSystems) in IS-IS, there is a default limit (for example, 400 pps) on the number of packets sent to the CPU. If a device has many neighbor relationships or sends Hello packets at short interval, the IS-IS packets that the device receives may exceed the default limit, causing frequent flapping of neighbor relationships. To solve the problem, you can use the CPU protection command in global mode to increase the limit.

Configuration Steps

↘ Configuring the Hello Packet Interval on an Interface

- Perform this configuration based on requirements.
- Run the **isis hello-interval** command in interface configuration mode on the desired device, unless otherwise specified.

↘ Configuring the Hello Packet Holdtime Multiplier on an Interface

- Perform this configuration based on requirements.
- Run the **isis hello-multiplier** command in interface configuration mode on the desired device, unless otherwise specified.

Verification

- Enable Router A to send Hello packets to Router B and Router C, and capture packets to check the packet interval.

- Make Router B or Router C down. After the holdtime has elapsed, check whether the corresponding neighbor relationship on Router A is invalid.

Related Commands

📌 **Configuring the Hello Packet Interval on an Interface**

Command	isis hello-interval { <i>interval</i> minimal } [level-1 level-2]
Parameter Description	<p><i>interval</i>: Indicates the Hello packet interval. The value range is 1 to 65,535, in the unit of seconds. The default value is 10.</p> <p>minimal: Indicates the minimum value of the holdtime, which is 1.</p> <p>level-1: Applies the setting to Level-1 Hello packets.</p> <p>level-2: Applies the setting to Level-2 Hello packets.</p>
Command Mode	Interface configuration mode
Usage Guide	<p>Use this command to change the Hello packet interval. The default interval is 10s. A DIS sends Hello packets at a frequency three times that by non-DIS devices in a broadcast network. If an IS is elected as the DIS on the interface, by default, the interface sends a Hello packet every 3.3s.</p> <p>If the keyword minimal is used, the Hello packet holdtime is set to 1. The Hello packet interval will be calculated based on the holdtime multiplier. If the holdtime multiplier is set to 4 and the isis hello-interval minimal command is executed, the Hello packet interval is equal to 1s divided by 4. The default Hello packet holdtime multiplier on an IS-IS interface is 3. The holdtime is equal to the holdtime multiplier multiplied by the packet interval. If the keyword minimal is used, the holdtime is set to 1. The packet interval is equal to 1 divided by the holdtime multiplier. If the holdtime multiplier is set to 4 and the isis hello-interval minimal command is executed, the packet interval is equal to 1 divided by 4s, which is 250 ms.</p>

📌 **Configuring Hello Packet Holdtime Multiplier on an Interface**

Command	isis hello-multiplier <i>multiplier-number</i> [level-1 level-2]
Parameter Description	<i>multiplier-number</i> : Indicates the Hello packet holdtime multiplier. The value range is 2 to 100. The default value is 3.
Command Mode	Interface configuration mode
Usage Guide	The Hello packet holdtime is equal to the Hello packet interval multiplied by the holdtime multiplier.

Configuration Example

📌 **Configuring the Hello Packet Interval and Holdtime on an IS-IS Interface**

Configuration Steps	<ul style="list-style-type: none"> ● Configure IS-IS neighbors. (Omitted) ● Configure the Hello packet interval on an IS-IS interface. ● Configure the Hello packet holdtime multiplier on an IS-IS interface.
	<pre>A(config)# interface GigabitEthernet 0/0 A(config-if)# isis hello-interval 5 A(config-if)# isis hello-multiplier 5</pre>

Verification	<p>Enable Router A to send Hello packets to Router B and Router C, and capture packets to check the packet interval.</p> <p>Make Router B or Router C down. After the holdtime has elapsed, check whether the corresponding neighbor relationship on Router A is invalid.</p>
	<pre>A# show isis neighbor</pre>

6.4.3 Configuring IS-IS LSPs

Configuration Effect

- **isis lsp-interval:** Configures the LSP interval on an IS-IS interface.
- **isis lsp-flood:** Sets the number of LSP PDUs sent by the IS-IS interface at a time.
- **lsp-gen-interval:** Configures the minimum LSP generational interval. The LSP generational interval is the interval between the new-version LSP generation time and the old-version LSP generation time.
- **isis retransmit-interval:** After a device at one end of a P2P link sends an LSP packet, if the device receives no response within a period of time, it determines that the LSP packet is lost or dropped due to an error. The device will resend the LSP packet.
- **lsp-gen-interval:** Indicates the exponential backoff algorithm of LSP packet generation. Any update to related information forming the LSP packet leads to LSP packet generation. During network flapping, LSP packets are frequently generated, which increases system resource consumption. An appropriate value can be set by running the **lsp-gen-interval** command. In this way, LSP packets are generated and advertised in time when the network is stable. When the network becomes unstable, less LSP packets are generated as the flapping continues, reducing the device consumption.
- **lsp-refresh-interval:** All current LSPs are periodically retransmitted to enable each network node to maintain the latest LSPs. The retransmission period is called the LSP refresh interval, which aims to update and synchronize LSPs in the entire area.
- **max-lsp-lifetime:** An LSP contains a field to indicate its lifetime. When a device generates an LSP, the field is set to the maximum lifetime of the LSP. After the LSP is received by the peer device, its lifetime will decrease with time. The peer device will replace the old LSP with the newly received one. If the device receives no new LSP until the existing LSP's lifetime decreases to 0, the existing LSP is still maintained in the LSDB for another 60s. If the device still receives no new LSP during this period, the existing LSP will be deleted from the LSDB. This mechanism updates and synchronizes LSPs in the entire area.
- **min-lsp-arrival:** During network flapping, LSP packets are frequently duplicated and the LSP packet sequence number constantly increases. As a result, the device keeps receiving duplicate LSP packets with different sequence numbers. If the device processes the duplicate LSP packets, more system resources are consumed. An appropriate value can be set by running the **min-lsp-arrival** command. In this way, LSPs are received and processed in time when the network is stable. When the network becomes unstable, less duplicate LSP packets are received and processed as the flapping continues, reducing the device consumption.
- **ignore-lsp-errors:** After receiving an LSP, the local IS-IS neighbor calculates its checksum and compares it with the checksum contained in the LSP. By default, if the two checksums are inconsistent, the LSP will be discarded. If you run the **ignore-lsp-errors** command to configure to ignore checksum errors, the LSP will be processed normally despite checksum inconsistency.
- **lsp-fragments-extend:** Enables LSP fragment extension, which is used to generate an extended LSP when the 256 fragments of the original LSP are used up.

Notes

- The LSP refresh interval must be smaller than the maximum LSP lifetime.

- The maximum LSP lifetime must be greater than the LSP refresh interval.
- The value of **initial-interval** cannot be greater than that of **maximum-interval**. Otherwise, the value of **initial-interval** will be used as the value of **maximum-interval**.
- The value of **hold-interval** cannot be greater than that of **maximum-interval**. Otherwise, the value of **hold-interval** will be used as the value of **maximum-interval**.
- The value of **initial-interval** cannot be greater than that of **hold-interval**. Otherwise, the value of **initial-interval** will be used as the value of **hold-interval**.

Configuration Steps

↘ **Configuring the Minimum LSP Interval**

- Perform this configuration based on requirements.
- Run the **isis lsp-interval** command in interface configuration mode on the desired device, unless otherwise specified.

↘ **Configuring the Maximum Number of LSP Packets Sent at a Time**

- Perform this configuration based on requirements.
- Run the **isis lsp-flood** command in interface configuration mode on the desired device, unless otherwise specified.

↘ **Configuring the LSP Retransmission Interval**

- Perform this configuration based on requirements.
- Run the **isis retransmit-interval** command in interface configuration mode on the desired device, unless otherwise specified.

↘ **Configuring LSP Packet Generation Cycle**

- Perform this configuration based on requirements.
- Run the **lsp-gen-interval** command in interface configuration mode on the desired device, unless otherwise specified.

↘ **Configuring the LSP Refresh Interval**

- Perform this configuration based on requirements.
- Run the **lsp-refresh-interval** command in IS-IS routing process configuration mode on the desired device, unless otherwise specified.

↘ **Configuring the LSP Lifetime**

- Perform this configuration based on requirements.
- Run the **max-lsp-lifetime** command in IS-IS routing process configuration mode on the desired device, unless otherwise specified.

↘ **Configuring the Interval for Receiving Duplicate LSP Packets**

- Perform this configuration based on requirements.
- Run the **min-lsp-arrival** command in IS-IS routing process configuration mode on the desired device, unless otherwise specified.

↘ **Configuring to Ignore LSP Checksum Errors**

- Perform this configuration based on requirements.

- Run the **ignore-lsp-errors** command in IS-IS routing process configuration mode on the desired device, unless otherwise specified.

➤ **Configuring LSP Fragment Extension**

- Perform this configuration based on requirements.
- Run the **lsp-fragments-extend** and **virtual-system** commands in IS-IS routing process configuration mode on the desired device, unless otherwise specified.

Verification

- Update LSPs continuously and capture LSPs to check the minimum LSP interval.
- Disable neighboring routes and capture LSPs to check the LSP retransmission interval.
- Capture LSPs to check the refresh interval.
- Check the LSP lifetime.
- Send an LSP with an incorrect checksum and check whether the LSP is discarded.
- Reduce the **lsp-length originate** command value, add routing information, and capture LSPs to check whether more than 256 LSP fragments are generated.

Related Commands

➤ **Configuring the Minimum LSP Interval**

Command	isis lsp-interval <i>interval</i> [level-1 level-2]
Parameter Description	<i>milliseconds</i> : Indicates the LSP interval. The value range is 1 to 4,294,967,295, in the unit of milliseconds. level-1 : Applies the setting only to Level-1 LSPs. level-2 : Applies the setting only to Level-2 LSPs.
Command Mode	Interface configuration mode
Usage Guide	N/A

➤ **Configuring the Maximum Number of LSP Packets Sent at a Time**

Command	isis lsp-flood <i>lsp-number</i> [level-1 level-2]
Parameter Description	<i>lsp-number</i> : Indicates the maximum number of LSP packets sent by the IS-IS interface at a time. The value range is 1 to 1000 . The default value is 5 . level-1 : Applies the configuration only to Level-1. level-2 : Applies the configuration only to Level-2.
Command Mode	Interface configuration mode
Usage Guide	N/A

➤ **Configuring LSP Packet Generation Cycle**

Command	lsp-gen-interval [level-1 level-2] <i>maximum-interval</i> [<i>initial-interval hold-interval</i>]
Parameter Description	level-1 : Applies the configuration only to Level-1. level-2 : Applies the configuration only to Level-2. <i>maximum-interval</i> : Indicates the maximum interval for generating two consecutive LSP packets. The value range is 1 to

	<p>65535 (in seconds). The default value is 5.</p> <p><i>initial-interval</i>: Indicates the waiting time for generating an LSP packet for the first time. The value range is 0 to 60000 (in milliseconds). The default value is 50.</p> <p><i>hold-interval</i>: Indicates the minimum interval for generating an LSP packet for the second time. The value range is 10 to 60000 (in milliseconds). The default value is 200.</p>
Configuration Mode	IS-IS routing process configuration mode
Usage Guide	<p>The LSP packet generation interval refers to the interval for generating two different LSP packets. A smaller generation interval indicates faster network convergence, which, however, will be accompanied by frequent flooding on the network.</p> <p>The waiting time for generating an LSP packet for the first time is the initial interval. If the network becomes unstable, the LSP packet regeneration interval is changed to be less than the maximum interval, and the interval for generating an LSP packet for the second time becomes the hold interval. A corresponding penalty will be added to this interval: The next interval for regenerating a LSP packet doubles the previous interval for generating the same LSP packet, until the regeneration interval reaches the maximum interval. Subsequent LSP packets will be generated at the maximum interval. When the network becomes stable, the LSP packet regeneration interval becomes greater than the maximum interval, and the waiting time for LSP packet generation is restored to the initial interval.</p> <p>Link changes have high requirements for convergence. The initial interval can be set to a small value. The preceding parameters can also be adjusted to larger values to reduce CPU consumption.</p> <p>The value of initial-interval cannot be greater than that of maximum-interval. Otherwise, the value of initial-interval will be used as the value of maximum-interval.</p> <p>The value of hold-interval cannot be greater than that of maximum-interval. Otherwise, the value of hold-interval will be used as the value of maximum-interval.</p> <p>The value of initial-interval cannot be greater than that of hold-interval. Otherwise, the value of initial-interval will be used as the value of hold-interval.</p>

📌 **Configuring the LSP Retransmission Interval**

Command	isis retransmit-interval <i>interval</i> [level-1 level-2]
Parameter Description	<p>seconds: Indicates the LSP retransmission interval. The value range is 0 to 65,535, in the unit of seconds.</p> <p>level-1: Applies the setting only to Level-1 LSPs.</p> <p>level-2: Applies the setting only to Level-2 LSPs.</p>
Command Mode	Interface configuration mode
Usage Guide	Use this command to configure the LSP retransmission interval. In a P2P network, after a device sends an LSP, if the device receives no PSNP response within the time specified by this command, it will resend the LSP. If the retransmission interval is set to 0, the LSP will not be resent,

📌 **Configuring the LSP Refresh Interval**

Command	lsp-refresh-interval <i>interval</i>
Parameter Description	<i>interval</i> : Indicates the LSP refresh interval. The value range is 1 to 65,535, in the unit of seconds. The default value is 900.
Command Mode	IS-IS routing process configuration mode
Usage Guide	After an LSP has remained stable for a period specified by this command, it will be refreshed and updated before being

	published. The LSP refresh interval must be smaller than the maximum LSP lifetime.
--	---

➤ **Configuring the LSP Lifetime**

Command	max-lsp-lifetime <i>value</i>
Parameter Description	<i>value</i> : Indicates the maximum time that LSPs keep alive. The value range is 1 to 65,535, in the unit of seconds. The default value is 1,200.
Command Mode	IS-IS routing process configuration mode
Usage Guide	The maximum LSP lifetime must be greater than LSP refresh interval.

➤ **Configuring the Interval for Receiving Duplicate LSP Packets**

Command	min-lsp-arrival [level-1 level-2] <i>maximum-interval initial-interval hold-interval</i>
Parameter Description	<p>level-1: Applies the configuration only to Level-1.</p> <p>level-2: Applies the configuration only to Level-2.</p> <p><i>maximum-interval</i>: Indicates the maximum interval for receiving two duplicate LSP packets. The value range is 1 to 120 (in seconds).</p> <p><i>initial-interval</i>: Indicates the interval for receiving a duplicate LSP packet for the first time. The value range is 0 to 60000 (in milliseconds).</p> <p><i>hold-interval</i>: Indicates the minimum interval for receiving a duplicate LSP packet for the second time. The value range is 10 to 60000 (in milliseconds).</p>
Command Mode	IS-IS routing process configuration mode
Usage Guide	<p>The interval for receiving a duplicate LSP packet for the first time is the initial interval. When the interval for receiving duplicate LSP packets is less than the maximum interval, the interval for receiving a duplicate LSP packet for the second time becomes the hold interval. In addition, a corresponding penalty is added to this interval: The next interval for receiving a duplicate LSP packet doubles the previous interval for receiving the same LSP packet, until this interval reaches the maximum interval. When the network becomes stable, the interval for receiving a duplicate LSP packet becomes greater than the maximum interval, and the interval for receiving a duplicate LSP packet is restored to the initial interval.</p> <p>Link changes have high requirements for convergence. The initial interval can be set to a small value. The preceding parameters can also be adjusted to larger values to reduce CPU consumption.</p> <p>The value of initial-interval cannot be greater than that of maximum-interval. Otherwise, the value of initial-interval will be used as the value of maximum-interval.</p> <p>The value of hold-interval cannot be greater than that of maximum-interval. Otherwise, the value of hold-interval will be used as the value of maximum-interval.</p> <p>The value of initial-interval cannot be greater than that of hold-interval. Otherwise, the value of initial-interval will be used as the value of hold-interval.</p>

➤ **Configuring to Ignore LSP Checksum Errors**

Command	ignore-lsp-errors
Parameter Description	N/A
Command Mode	IS-IS routing process configuration mode

Mode	
Usage Guide	After receiving an LSP, the local IS-IS neighbor calculates its checksum and compares it with the checksum contained in the LSP. By default, if the two checksums are inconsistent, the LSP will be discarded. If you run the ignore-lsp-errors command to configure to ignore checksum errors, the LSP will be processed normally despite checksum inconsistency.

📌 **Configuring LSP Fragment Extension**

Command	lsp-fragments-extend [level-1 level-2] [compatible rfc3786]
Parameter Description	level-1: Applies the setting only to Level-1 LSPs. level-2: Applies the setting only to Level-2 LSPs. compatible: Indicates compatibility with the RFC version of extended LSPs. rfc3786: Extends the LSP old version.
Command Mode	IS-IS routing process configuration mode
Usage Guide	Use this command to enable LSP fragment extension.

📌 **Configuring an Additional System ID**

Command	virtual-system system-id
Parameter Description	system-id: Indicates an additional system ID (6-byte).
Command Mode	IS-IS routing process configuration mode
Usage Guide	Use this command to configure the additional system ID of an IS-IS routing process, which is used by the extended LSP that is generated after the 256 fragments of the original LSP are used up. To enable fragment extension, run the lsp-fragments-extend command.

Configuration Example

📌 **Configuring the Minimum LSP Interval**

Configuration Steps	<ul style="list-style-type: none"> ● Configure IS-IS neighbors. (Omitted) ● Configure the minimum LSP interval.
	<pre>A(config)# interface GigabitEthernet 0/1 A(config-if)# isis lsp-interval 100 level-2</pre>
Verification	Run the clear isis * command to update LSPs continuously and capture LSPs to check the minimum LSP interval.

📌 **Configuring the Maximum Number of LSP Packets Sent at a Time**

Configuration Steps	<ul style="list-style-type: none"> ● Configure IS-IS neighbors. (Omitted) ● Configure the maximum number of LSP packets sent at a time.
	<pre>A(config)# interface GigabitEthernet 0/1 A(config-if)# isis lsp-flood 10 level-2</pre>
Verification	Run show isis interface command to check the maximum number of LSP packets sent at a time.

➤ **Configuring the LSP Retransmission Interval**

Configuration Steps	<ul style="list-style-type: none"> ● Configure IS-IS neighbors in P2P mode. (Omitted) ● Configure the LSP retransmission interval.
	<pre>A(config)# interface serial 0/1 A(config-if)# isis retransmit-interval 10 level-2</pre>
Verification	Disable neighboring routes and capture LSPs to check the LSP retransmission interval.

➤ **Configuring LSP Packet Generation Cycle**

Configuration Steps	<ul style="list-style-type: none"> ● Configure IS-IS neighbors. (Omitted) ● Configure the LSP packet generation cycle.
	<pre>A(config)# router isis A(config-router)# lsp-gen-interval 5 50 100</pre>
Verification	Generate LSP packet frequently to see whether the exponential backoff algorithm is used.

➤ **Configuring the LSP Refresh Interval**

Configuration Steps	<ul style="list-style-type: none"> ● Configure IS-IS neighbors. (Omitted) ● Configure the LSP refresh interval.
	<pre>A(config)# router isis A(config-router)# lsp-refresh-interval 600</pre>
Verification	Capture LSPs to check the refresh interval.

➤ **Configuring the LSP Lifetime**

Configuration Steps	<ul style="list-style-type: none"> ● Configure IS-IS neighbors. (Omitted) ● Configure the LSP lifetime.
	<pre>A(config)# router isis A(config-router)# max-lsp-lifetime 1500</pre>
Verification	Check the LSP lifetime (LSP Holdtime field).
	<pre>A# show isis database</pre>

➤ **Configuring the Interval for Receiving Duplicate LSP Packets**

Configuration Steps	<ul style="list-style-type: none"> ● Configure IS-IS neighbors. (Omitted) ● Configure the interval for receiving duplicate LSP packets.
----------------------------	---

	A(config)# router isis A(config-router)# min-lsp-arrival 10 100 200
Verification	Check LSP Seq Num field, that is, the receiving LSP status.
	A# show isis database

▾ **Configuring to Ignore LSP Checksum Errors**

Configuration Steps	<ul style="list-style-type: none"> ● Configure IS-IS neighbors. (Omitted) ● Configure to ignore LSP checksum errors.
	A(config)# router isis A(config-router)# ignore-lsp-errors
Verification	Send an LSP with an incorrect checksum and check whether the LSP is discarded.

▾ **Configuring LSP Fragment Extension**

Configuration Steps	<ul style="list-style-type: none"> ● Configure IS-IS neighbors. (Omitted) ● Configure LSP fragment extension. ● Configure the additional system ID of the IS-IS routing process.
	A(config)# router isis A(config-router)# lsp-fragments-extend A(config-router)# virtual-system 0000.0000.0034
Verification	Reduce the lsp-length originate command value, add routing information, and capture LSPs to check whether more than 256 LSP fragments are generated.

6.4.4 Configuring IS-IS SNPs

Configuration Effect

- CSNPs are periodically broadcast by the DIS in a broadcast network for LSDB synchronization. In a P2P network, a CSNP is sent only after a neighbor relationship is established. An interface set to **mesh-groups** can be configured to periodically send CSNPs.
- When you need to set **mesh-group** on an IS-IS interface, run the **isis csnp-interval** command to configure the non-0 CSNP interval to ensure complete LSP synchronization between neighbors in the network. After that, CSNPs will be periodically sent to synchronize LSPs.

Configuration Steps

- Perform this configuration based on requirements.
- Run the **isis csnp-interval interval [level-1 | level-2]** command in interface configuration mode on the desired device, unless otherwise specified.

Verification

Capture CSNPs in the broadcast network to check the CSNP interval.

Related Commands

📌 **Configuring Source Registration Filter**

Command	isis csnp-interval <i>interval</i> [level-1 level-2]
Parameter Description	<i>interval</i> : Indicates the CSNP interval. The value range is 0 to 65,535, in the unit of seconds. level-1 : Applies the setting only to Level-1 CSNPs. level-2 : Applies the setting only to Level-2 CSNPs.
Command Mode	Interface configuration mode
Usage Guide	Use this command to change the CSNP interval. By default, a DIS sends a CSNP every 10s in a broadcast network. In a P2P network, a CSNP is sent only after a neighbor relationship is established. An interface set to mesh-groups can be configured to periodically send CSNPs. No CSNPs are sent if the CSNP interval is set to 0.

Configuration Example

📌 **Configuring the CSNP Broadcast Interval**

Configuration Steps	<ul style="list-style-type: none"> ● Configure IS-IS neighbors. (Omitted) ● Configure the CSNP broadcast interval.
	<pre>A(config)# interface GigabitEthernet 0/1 A(config-if)# isis csnp-interval 20</pre>
Verification	Capture packets to check the CSNP interval.

6.4.5 Configuring the IS-IS Level Type

Configuration Effect

- IS-IS supports a two-Level system to realize routing management and extensible route selection in a large network. Each Level is only concerned about maintaining the topology of the corresponding area.
- You can run the **is-type** command in IS-IS routing process configuration mode to configure an IS-IS Level, or run the **isis circuit-type** command in interface configuration mode to configure the IS-IS Level of an interface. The default Levels specified by the **is-type** and **isis circuit-type** commands are Level-1/Level-2. If you run both commands, the interface only sends the PDUs of the same Level specified by the two commands.

Notes

- If Level-1 or Level-2-only is configured using the **circuit-type** command, IS-IS will only send PDUs of the corresponding Level.
- If an interface is set to **external**, the interface will work as an external domain interface and IS-IS will not send PDUs of the corresponding Level.
- A device can have only one instance running at Level-2 (including Level-1/Level-2).

Configuration Steps

➤ **Configuring the System Type**

- Perform this configuration based on requirements.
- Run the **is-type** command in IS-IS routing process configuration mode on the desired device, unless otherwise specified.

➤ **Configuring the Interface Circuit Type**

- Perform this configuration based on requirements.
- Run the **isis circuit-type** command in interface configuration mode on the desired device, unless otherwise specified.

Verification

- Check whether only the instances of the Level specified by the **is-type** command are processed, and neighbors of the corresponding Level are created.
- Check whether the interface only sends the PDUs of the same Level specified by the **is-type** and **circuit-type** commands.

Related Commands

➤ **Configuring the System Type**

Command	is-type { level-1 level-1-2 level-2-only }
Parameter	level-1: Indicates that IS-IS only runs at Level-1.
Description	level-1-2: Indicates that IS-IS runs at Level-1 and Level-2. level-2-only: Indicates that IS-IS only runs at Level-2.
Command	IS-IS routing process configuration mode
Mode	
Usage Guide	Changing the is-type value will enable or disable the routes of the corresponding level.

➤ **Configuring the Interface Circuit Type**

Command	isis circuit-type { level-1 level-1-2 level-2-only [external] }
Parameter	level-1: Establishes a Level-1 neighbor relationship.
Description	level-2-only: Establishes a Level-2 neighbor relationship. level-1-2: Establishes a Level-1/Level-2 neighbor relationship. external: Uses the interface as an external domain interface.
Command	Interface configuration mode
Mode	
Usage Guide	If the circuit type is set to Level-1 or Level-2-only, IS-IS will only send PDUs of the corresponding Level. If the system type is set to Level-1 or Level-2-only, IS-IS only processes the instances of the corresponding Level, and the interface only sends the PDUs of the same Level specified by the is-type and circuit-type commands. If the interface is set to external , the interface will work as an external domain interface and IS-IS will not send PDUs of the corresponding Level.

Configuration Example

➤ **Configuring IS-IS Levels**

Configuration	Router A is connected to Router B and Router C by P2P serial links. Router B and Router C are connected by the
----------------------	--

<p>Requirements</p>	<p>Ethernet, and Router D and Router E are also connected by the Ethernet. On Router A, configure IS-IS area route summarization. Note that area route summarization can be configured only on border devices.</p>
<p>Figure 6- 12 IS-IS Level Configuration</p>	
<p>Configuration Steps</p>	<ul style="list-style-type: none"> ● Configure IS-IS. ● Configure Ethernet interfaces. ● Configure the IS-IS Level structure.
<p>A</p>	<p>Configure IS-IS.</p> <pre>A(config)# router isis A(config-router)# net 50.0001.0000.0000.0001.00 A(config-router)# is-type level-2-only</pre>
	<p>Configure two serial link ports.</p> <pre>A(config)# interface Serial 1/0 A(config-if)# ip address 192.168.1.1 255.255.255.252 A(config-if)# ip router isis A(config)# interface Serial 1/1 A(config-if)# ip address 192.168.2.1 255.255.255.252 A(config-if)# ip router isis</pre>
<p>B</p>	<p>Configure IS-IS.</p>
	<pre>B(config)# router isis B(config-router)# net 49.0001.0000.0000.0002.00</pre>
	<p>Configure an Ethernet interface.</p>

	<pre>B(config)# interface GigabitEthernet 0/0 B(config-if)# ip address 192.168.10.1 255.255.255.0 B(config-if)# ip router isis</pre>
	Configure a serial link port.
	<pre>B(config)# interface Serial 1/0 B(config-if)# ip address 192.168.1.2 255.255.255.252 B(config-if)# ip router isis</pre>
C	Configure IS-IS.
	<pre>C(config)# router isis C(config-router)# net 49.0001.0000.0000.0003.00 C(config-router)# is-type level-1</pre>
	Configure an Ethernet interface.
	<pre>C(config)# interface GigabitEthernet 0/0 C(config-if)# ip address 192.168.10.2 255.255.255.0 C(config-if)# ip router isis</pre>
D	Configure IS-IS.
	<pre>D(config)# router isis D(config-router)# net 49.0002.0000.0000.0004.00</pre>
	Configure an Ethernet interface.
	<pre>D(config)# interface GigabitEthernet 0/0 D(config-if)# ip address 192.168.20.1 255.255.255.0 D(config-if)# ip router isis</pre>
	Configure a serial link port.
	<pre>D(config)# interface Serial 1/0 D(config-if)# ip address 192.168.2.2 255.255.255.252 D(config-if)# ip router isis</pre>
E	Configure IS-IS.
	<pre>E(config)# router isis E(config-router)# net 49.0002.0000.0000.0005.00 E(config-router)# is-type level-1</pre>
	Configure an Ethernet interface.
	<pre>E(config)# interface GigabitEthernet 0/0 E(config-if)# ip address 192.168.20.2 255.255.255.0</pre>

	E(config-if)# ip router isis
Verification	<ul style="list-style-type: none"> ● Check whether neighbor relationships are established normally. ● Capture packets to check whether Router A only sends and receives Level-2 packets. ● Capture packets to check whether Router B and Router D only send and receive Level-1 and Level-2 packets. ● Capture packets to check whether Router C and Router E only send and receive Level-1 packets.
A	<pre>A# show isis neighbors A# show isis database detail</pre>
B	<pre>B# show isis neighbors B# show isis database detail</pre>
C	<pre>C# show isis neighbors C# show isis database detail</pre>
D	<pre>D# show isis neighbors D# show isis database detail</pre>
E	<pre>E# show isis neighbors E# show isis database detail</pre>

6.4.6 Configuring IS-IS Authentication

Configuration Effect

- Interface authentication is intended for establishing and maintaining neighbor relationships. A neighbor relationship cannot be established between two IS-IS devices with different interface authentication passwords. This prevents unauthorized or unauthenticated IS-IS devices from joining an IS-IS network that requires authentication. Interface authentication passwords are encapsulated in Hello packets before being sent.
- Area authentication and RD authentication in IS-IS are performed to verify LSPs, CSNPs, and PSNPs to prevent unauthorized or unauthenticated routing information from being injected into the LSDB. Authentication passwords are encapsulated in LSPs, CSNPs, and PSNPs before being sent.

Notes

- An interface authentication password is encapsulated in a Hello packet before being sent by an interface. When an interface receives a Hello packet, it checks the password in the packet against the existing one.
- Area authentication passwords are encapsulated in Level-1 LSPs, CSNPs, and PSNPs. When an interface receives an LSP, CSNP, or PSNP, it checks the password in the packet against the existing one.
- RD authentication passwords are encapsulated in Level-2 LSPs, CSNPs, and PSNPs. When an interface receives an LSP, CSNP, or PSNP, it checks the password in the packet against the existing one.

Configuration Steps

📌 Configuring Interface Authentication

- Perform this configuration based on requirements.
- Configure **isis password** in interface configuration mode on the desired device, unless otherwise specified.

↘ **Configuring Area Authentication**

- Perform this configuration based on requirements.
- Run the **area-password** command in IS-IS routing process configuration mode on the desired device, unless otherwise specified.

↘ **Configuring RD Authentication**

- Perform this configuration based on requirements.
- Run the **domain-password** command in IS-IS routing process configuration mode on the desired device, unless otherwise specified.

Verification

- IS-IS plaintext authentication provides only limited security because the password transferred through a packet is visible.
- IS-IS MD5 authentication provides higher security because the password transferred through a packet is encrypted using the MD5 algorithm.

Related Commands

↘ **Configuring the Password for Plaintext Authentication of Hello Packets on an Interface**

Command	isis password [0 7] <i>password</i> [send-only] [level-1 level-2]
Parameter Description	<p>0: Indicates that the key is displayed in plaintext.</p> <p>7: Indicates that the key is displayed in ciphertext.</p> <p>password-string: Indicates the password string for plaintext authentication. The string can contain up to 126 characters.</p> <p>send-only: Indicates that the plaintext authentication password is only used to authenticate sent packets. Received packets are not authenticated.</p> <p>level-1: Applies the setting to the Level-1 circuit type.</p> <p>level-2: Applies the setting to the Level-2 circuit type.</p>
Command Mode	Interface configuration mode
Usage Guide	<p>Use this command to configure the password for Hello packet authentication on an interface. Use the no form of this command to clear the password.</p> <p>If no Level is specified, by default, the password takes effect for Level-1 and Level-2 circuit types.</p> <p>This command does not take effect if the isis authentication mode command is executed. You need to first delete the previous command configuration.</p> <p>If you include the send-only parameter when deleting the isis authentication mode command configuration, only the parameter setting is canceled.</p>

↘ **Specifying Interface Authentication as Plaintext or MD5**

Command	isis authentication mode { md5 text } [level-1 level-2]
Parameter Description	<p>md5: Uses MD5 authentication.</p> <p>text: Uses plaintext authentication.</p>

	<p>level-1: Applies the setting to the Level-1 circuit type.</p> <p>level-2: Applies the setting to the Level-2 circuit type.</p>
Command Mode	Interface configuration mode
Usage Guide	<p>Use this command to specify the authentication mode before you can make the key chain configured using the isis authentication key-chain command take effect.</p> <p>If no Level is specified, the authentication mode will take effect for Level-1 and Level-2 circuit types.</p> <p>If you use the isis authentication mode command after the isis password command is executed to configure plaintext authentication, the previous command configuration will be overwritten.</p> <p>The isis password command does not take effect if the isis authentication mode command is executed. To run the isis password command, delete the isis authentication mode command configuration first.</p>

📌 Configuring the Password for Interface Authentication

Command	isis authentication key-chain <i>name-of-chain</i> [level-1 level-2]
Parameter Description	<p><i>name-of-chain</i>: Indicates the name of a key chain. The maximum length is 255.</p> <p>level-1: Indicates that the authentication key chain takes effect for Level-1.</p> <p>level-2: Indicates that the authentication key chain takes effect for Level-2.</p>
Command Mode	Interface configuration mode
Usage Guide	<p>Authentication is not performed if no key chain is configured using the key chain command. In addition to the key chain command, you also need to run the isis authentication mode command to make IS-IS key chain authentication take effect.</p> <p>The key chain is applicable to plaintext authentication and MD5 authentication. Which authentication mode to use can be determined using the isis authentication mode command.</p> <p>For plaintext authentication, the key-string in the key chain cannot exceed 80 characters; otherwise, the key chain will be invalid.</p> <p>Only one key chain can be used at a time. After you configure a new key chain, it will replace the original one.</p> <p>If no Level is specified, the key chain takes effect for Level-1 and Level-2.</p> <p>The key chain is applicable to Hello packets. IS-IS will send or receive passwords that belong to the key chain.</p> <p>A key chain may contain multiple passwords. A password with a smaller SN is preferentially used for sending a packet.</p> <p>When the packet arrives at the peer device, the device will receive the packet if the packet-carried password is consistent with a password in the key chain.</p> <p>The authentication commands (for example, authentication key-chain) executed in IS-IS routing process configuration mode are intended for LSPs and SNPs. They do not take effect for IS-IS interfaces.</p>

📌 (Optional) Applying Interface Authentication Only to Sent Packets (Received Packets Are Not Authenticated)

Command	isis authentication send-only [level-1 level-2]
Parameter Description	<p>level-1: Sets send-only for Level-1 on an interface.</p> <p>level-2: Sets send-only for Level-2 on an interface.</p>
Command Mode	Interface configuration mode
Usage Guide	<p>Use this command to enable IS-IS to set an authentication password in the Hello packet sent by an interface. However, IS-IS does not authenticate the Hello packet received by the interface. You can use this command before you deploy IS-IS interface authentication on all devices in the network or before you change the authentication password or</p>

authentication mode. After you run the **isis authentication send-only** command, the devices will not authenticate received Hello packets to avoid network flapping when IS-IS interface authentication is deployed. After authentication is deployed in the entire network, run the **no isis authentication send-only** command to cancel the **send-only** setting. The **isis authentication send-only** command is applicable to plaintext authentication and MD5 authentication. You can run the **isis authentication mode** command to specify the authentication mode for an IS-IS interface. If no Level is specified, the authentication mode will take effect for Level-1 and Level-2 on the interface.

➤ **Configuring the Password for Area (Level-1) Plaintext Authentication**

Command	area-password [0 7] <i>password</i> [send-only]
Parameter	0 : Indicates that the key is displayed in plaintext.
Description	7 : Indicates that the key is displayed in ciphertext. password-string : Indicates the password string for plaintext authentication. The string can contain up to 126 characters. send-only : Indicates that the plaintext authentication password is only used to authenticate sent Hello packets in Level-1 areas. Received Hello packets are not authenticate.
Command Mode	IS-IS routing process configuration mode
Usage Guide	Run this command to enable authentication of received LSPs, CSNPs, and PSNPs in Level-1 areas and include authentication information in these packets before they are sent. All IS-IS devices in an area must be configured with the same password. This command does not take effect if the authentication mode command is executed. You need to first delete the previous command configuration. To delete the password, run the no area-password command. If you run the no area-password send-only command, only the send-only setting is canceled. If you run the area-password psw send-only and no area-password send-only commands in sequence, the configuration is changed to area-password psw .

➤ **Configuring the Password for RD (Level-2) Plaintext Authentication**

Command	domain-password [0 7] <i>password</i> [send-only]
Parameter	0 : Indicates that the key is displayed in plaintext.
Description	7 : Indicates that the key is displayed in ciphertext. password-string : Indicates the password string for plaintext authentication. The string can contain up to 126 characters. send-only : Indicates that the plaintext authentication password is only used to authenticate sent Hello packets in Level-1 areas. Received Hello packets are not authenticated.
Command Mode	IS-IS routing process configuration mode
Usage Guide	Run this command to enable authentication of received LSPs, CSNPs, and PSNPs in Level-2 domains and include authentication information in these packets before they are sent. All IS-IS devices in a Level-2 domain must be configured with the same password. This command does not take effect if the authentication mode command is executed. You need to first delete the previous command configuration. To delete the password, run the no domain-password command. If you run the no domain-password send-only command, only the send-only setting is canceled. If you run the domain-password psw send-only and no domain-password send-only commands in sequence, the configuration is changed to domain-password psw .

➤ **Specifying the IS-IS RD Authentication Mode**

Command	authentication mode { md5 text } [level-1 level-2]
Parameter	md5 : Uses MD5 authentication.
Description	text : Uses plaintext authentication. level-1 : Indicates that the authentication mode takes effect for Level-1. level-2 : Indicates that the authentication mode takes effect for Level-2.
Command Mode	IS-IS routing process configuration mode
Usage Guide	Use this command to specify the authentication mode before you can make the key chain configured using the authentication key-chain command take effect. If no Level is specified, the authentication mode will take effect for Level-1 and Level-2. If you use the authentication mode command after the area-password or domain-password command is executed to configure plaintext authentication, the previous command configuration will be overwritten. The area-password or domain-password command does not take effect if the authentication mode command is executed. To run the area-password or domain-password command, delete the authentication mode command configuration first.

📌 Specifying the Key Chain for IS-IS Authentication

Command	authentication key-chain <i>name-of-chain</i> [level-1 level-2]
Parameter	<i>name-of-chain</i> : Indicates the name of a key chain. The maximum length is 255.
Description	level-1 : Indicates that the authentication key chain takes effect for Level-1. level-2 : Indicates that the authentication key chain takes effect for Level-2.
Command Mode	IS-IS routing process configuration mode
Usage Guide	Authentication is not performed if no key chain is configured using the key chain command. In addition to the key chain command, you also need to run the authentication mode command to make IS-IS key chain authentication take effect. The key chain is applicable to plaintext authentication and MD5 authentication. Which authentication mode to use can be determined using the authentication mode command. For plaintext authentication, the key-string in the key chain cannot exceed 80 characters; otherwise, the key chain will be invalid. Only one key chain can be used at a time. After you configure a new key chain, it will replace the original one. If no Level is specified, the key chain takes effect for Level-1 and Level-2. The key chain is applicable to LSPs, CSNPs, and PSNPs. IS-IS will send or receive passwords that belong to the key chain. A key chain may contain multiple passwords. A password with a SN is preferentially used for sending a packet. When the packet arrives at the peer device, the device will receive the packet if the packet-carried password is consistent with a password in the key chain.

📌 Applying IS-IS Authentication Only to Sent Packets

Command	authentication send-only [level-1 level-2]
Parameter	level-1 : Applies the send-only setting to Level-1.
Description	level-2 : Applies the send-only setting to Level-2.
Command Mode	IS-IS routing process configuration mode
Usage Guide	Use this command to enable IS-IS to set an authentication password in the Hello packet to be sent. However, IS-IS does not authenticate received Hello packets. You can use this command before you deploy IS-IS authentication on all devices

in the network or before you change the authentication password or authentication mode. After you run the **authentication send-only** command, the devices will not authenticate received packets to avoid network flapping when authentication passwords are deployed. After authentication is deployed in the entire network, run the **no isis authentication send-only** command to cancel the **send-only** setting.

The **authentication send-only** command is applicable to plaintext authentication and MD5 authentication. You can run the **authentication mode** command to specify the authentication mode.

If no Level is specified, the authentication mode will take effect for Level-1 and Level-2.

Configuration Example

📌 **Configuring IS-IS Authentication**

<p>Configuration Requirements</p>	<p>Router A, Router B, and Router C are connected through the Ethernet and run IS-IS. Router A is a Level-1 device, Router B is a Level-1/Level-2 device, and Router C is a Level-2 device. The following configuration requirements exist: Apply plaintext authentication to the Hello packets between Router A and Router B, as well as Level-1 LSPs and SNPs. Apply MD5 authentication to the Hello packets between Router B and Router C, as well as Level-2 LSPs and SNPs.</p>
<p>Figure 6-13 IS-IS Authentication Topology</p>	
<p>Configuration Steps</p>	<ul style="list-style-type: none"> ● Configure IS-IS. ● Configure Ethernet interfaces. ● Configure the password for IS-IS authentication.
<p>A</p>	<p>Configure IS-IS.</p>
	<pre>A(config)# router isis A(config-router)# net 49.0001.0000.0000.0001.00 A(config-router)# is-type level-1 A(config-router)# area-password aa</pre>
	<p>Configure an Ethernet interface.</p> <pre>A(config)# interface GigabitEthernet 0/0 A(config-if)# ip address 192.168.20.1 255.255.255.0 A(config-if)# ip router isis A(config-if)# isis password cc</pre>
<p>B</p>	<p>Configure the password for IS-IS authentication.</p>
	<pre>B(config)# key chain kc1 B(config-keychain)# key 1</pre>

	<pre>B(config-keychain-key)# key-string aa B(config)# key chain kc2 B(config-keychain)# key 1 B(config-keychain-key)# key-string bb B(config)# key chain kc3 B(config-keychain)# key 1 B(config-keychain-key)# key-string cc</pre>
	<p>Configure IS-IS.</p>
	<pre>B(config)# router isis B(config-router)# net 49.0001.0000.0000.0002.00 B(config-router)# authentication mode text level-1 B(config-router)# authentication key-chain kc1 B(config-router)# authentication mode md5 level-2 B(config-router)# authentication key-chain kc2</pre>
	<p>Configure two Ethernet interfaces.</p>
<p>C</p>	<pre>B(config)# interface GigabitEthernet 0/0 B(config-if)# ip address 192.168.20.2 255.255.255.0 B(config-if)# ip router isis B(config-if)# isis authentication mode text B(config-if)# isis authentication key-chain kc3 B(config)# interface GigabitEthernet 0/1 B(config-if)# ip address 192.168.30.2 255.255.255.0 B(config-if)# ip router isis B(config-if)# isis authentication mode md5 B(config-if)# isis authentication key-chain kc3</pre> <p>Configure the password for IS-IS authentication.</p>
	<pre>C(config)# key chain kc2 C(config-keychain)# key 1 C(config-keychain-key)# key-string bb C(config)# key chain kc3 C(config-keychain)# key 1 C(config-keychain-key)# key-string cc</pre>
	<p>Configure IS-IS.</p>
	<pre>C(config)# router isis</pre>

	<pre>C(config-router)# net 49.0002.0000.0000.0002.00 C(config-router)# is-type level-2 C(config-router)# authentication mode md5 level-2 C(config-router)# authentication key-chain kc2</pre> <p>Configure an Ethernet interface.</p>
	<pre>C(config)# interface GigabitEthernet 0/1 C(config-if)# ip address 192.168.30.3 255.255.255.0 C(config-if)# ip router isis C(config-if)# isis authentication mode md5 C(config-if)# isis authentication key-chain kc3</pre>
Verification	Check whether neighbor relationships are established normally.
A	<pre>A# show isis neighbors A# show isis database detail</pre>
B	<pre>B# show isis neighbors</pre>
C	<pre>C# show isis neighbors</pre>

Common Errors

- Different authentication passwords are configured between neighbors.
- Different authentication modes are configured between neighbors.

6.4.7 Configuring IS-IS GR

Configuration Effect

- IS-IS GR helps improve system reliability. On devices that separate the control plane from the forwarding plane, GR ensures that data forwarding is not interrupted during routing protocol restart.

📌 IS-IS GR Working Mechanism

For GR to be successful, the following two conditions must be met: (1) The network topology is stable; (2) The device can ensure uninterrupted forwarding when it restarts IS-IS.

Two roles exist during the GR process: Restarter and Helper. Accordingly, IS-IS GR is divided into the IS-IS GR Restart capability and IS-IS GR Help capability. A device with the GR Restart capability can send a GR request and execute GR. A device with the GR Help capability can receive a GR request and help its neighbor with GR implementation. The GR process starts when the Restarter sends a GR request. After receiving the GR request, the neighboring device enters Help mode to help the Restarter reestablish its LSDB while maintaining the neighbor relationship with the Restarter. The main GR working mechanism is as follows:

When an IS-IS device needs to perform GR, it instructs its neighbor to maintain their neighbor relationship so that other devices in the network cannot sense the change in the topological relationship and the neighbor will not recalculate the route and update its

forwarding table. The IS-IS device synchronizes and restores the LSDB to its pre-GR state with the help of the neighbor to ensure that the route and forwarding table remain unchanged before and after GR implementation and data forwarding is not interrupted.

The Restarter performs the following operations during the GR process:

1. The GR Restarter notifies the GR Helpers that it will be restarted.

Figure 6- 14 Restart Notification by the GR Restarter

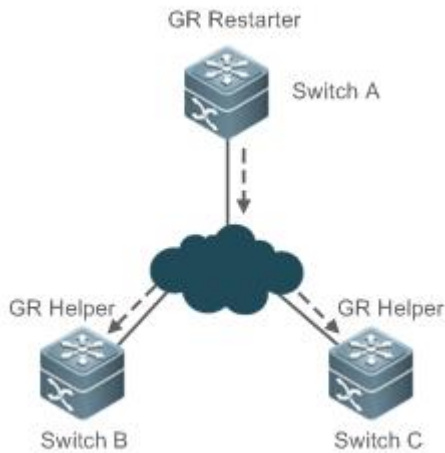

Switch A is a GR Restarter, and Switch B and Switch C are the GR Helpers for Switch A. Switch A sends a GR request instructing all its neighbors not to delete the neighbor relationships with Switch A when it is restarted. After receiving the GR request, the neighbors send GR responses to the GR Restarter, and will maintain their neighbor relationships with the GR Restarter during the GR time (specified by **GR grace-period**) notified by the GR Restarter.

2. The GR Restarter is restarted.

Figure 6- 15 Restart Performed by the GR Restarter

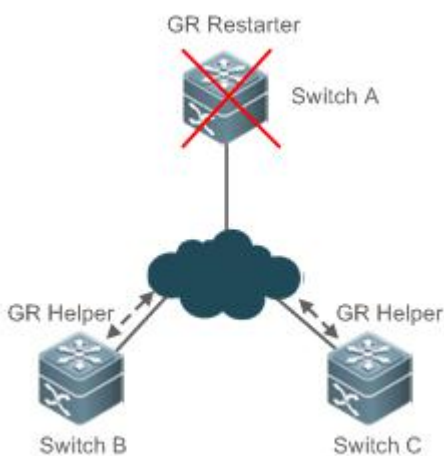

When the GR Restarter is restarted, its IS-IS interface goes from Down to Up. Because the GR Helpers know that the GR Restarter is in IS-IS restart state, they maintain their neighbor relationships with the GR Restarter during the GR time and retain the routes from the GR Restarter.

31. The GR Restarter synchronizes topology and routing information from the GR Helpers.

Figure 6- 16 LSDB Synchronization

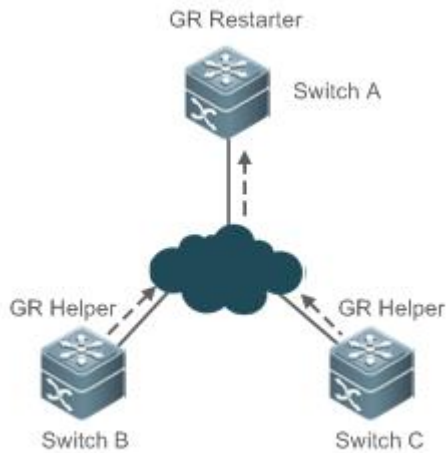

After IS-IS restart, the GR Restarter synchronizes topology or routing information from the GR Helpers and recalculates its routing table. During this process, any change in the routing table is not updated to the forwarding table.

32. GR is completed when the GR Restarter finishes LSDB synchronization. Then all devices enter IS-IS interaction state.

Figure 6- 17 GR Completion

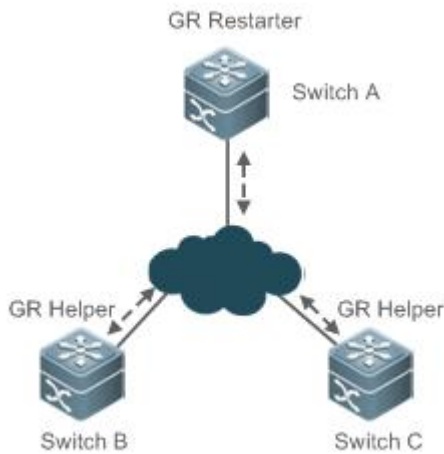

After the GR Restarter synchronizes all required data, all devices enter IS-IS interaction state. The GR Restarter's routing table is updated to the forwarding table and invalid entries are cleared. Because the GR Restarter is completely restored to the pre-restart state under stable network conditions, its routing table and forwarding table remain unchanged before and after GR.

Notes

- IS-IS GR is implemented based on RFC5306: Restart Signaling for IS-IS.

All products support the IS-IS GR Helper capability.

Configuration Steps

➤ **Enabling the IS-IS GR Restart Capability**

- Perform this configuration based on requirements.

- Run the **graceful-restart** command in IS-IS routing process configuration mode on the desired device, unless otherwise specified.

➤ **Configuring the Maximum GR Time**

- Perform this configuration based on requirements.
- Run the **graceful-restart grace-period** command in IS-IS routing process configuration mode on the desired device, unless otherwise specified.

➤ **Enabling the IS-IS GR Help Capability**

- Perform this configuration based on requirements.
- Run the **graceful-restart helper** command in IS-IS routing process configuration mode on the desired device, unless otherwise specified.

Verification

- Check whether the routing table and forwarding table remain unchanged before and after GR.

Related Commands

➤ **Enabling the IS-IS GR Restart Capability**

Command	graceful-restart
Parameter	N/A
Description	
Command Mode	IS-IS routing process configuration mode
Usage Guide	Use this command to enable the IS-IS GR Restart capability. As long as the network conditions remain unchanged, IS-IS can be restarted and restored to the pre-restart state without impact on data forwarding.

➤ **Configuring the Maximum GR Time**

Command	graceful-restart grace-period <i>seconds</i>
Parameter Description	<i>seconds</i> : Indicates the GR time. The value range is 1s to 65,535s. The default value is 300s.
Command Mode	IS-IS routing process configuration mode
Usage Guide	N/A

➤ **Enabling the IS-IS GR Help Capability**

Command	graceful-restart helper disable
Parameter Description	N/A
Command Mode	IS-IS routing process configuration mode
Usage Guide	Use the graceful-restart helper disable command to disable the IS-IS GR Help capability. The command enables IS-IS to ignore the GR request sent by the device to be restarted.

Configuration Example

▾ **Configuring IS-IS GR**

<p>Configuration Requirements</p>	<p>Two S8600 series high-end devices have the IS-IS GR Restart capability and are equipped with master/slave management boards for redundant backup at the control plane. IS-IS neighbor relationships are established between S86-1 and S3750/S3760 and between S86-2 and S3750/S3760. The system software of all devices supports the IS-IS GR Help capability.</p> <p>The following configuration requirements exist: Enable the IS-IS GR Restart capability with proper GRTime setting on S86-1 and S86-2 to realize uninterrupted forwarding and improve core device reliability.</p> <p>Disable the IS-IS GR Help capability on S3750 to exclude it from the Help process. By default, other device supports the IS-IS GR Help capability and require no additional configuration.</p>
<p>Figure 6-18 IS-IS GR Topology</p>	
<p>Configuration Steps</p>	<p>Configure IS-IS. (Omitted)</p> <p>Configure Ethernet interfaces. (Omitted)</p>
<p>S86-1</p>	<p>Configure IS-IS GR.</p>
	<pre>S86-1 (config)# router isis CS86-1(config-router)# graceful-restart CS86-1(config-router)# graceful-restart grace-period 60</pre>
<p>S86-2</p>	<p>Configure IS-IS GR.</p>
	<pre>CS86-2(config)# router isis CS86-2(config-router)# graceful-restart CS86-2(config-router)# graceful-restart grace-period 80</pre>
<p>S3750</p>	<p>Disable the IS-IS Help capability.</p>
	<pre>S3750(config)# router isis S3750(config-router)# graceful-restart helper disable</pre>
<p>Verification</p>	<p>Check whether the routing table and forwarding table remain unchanged before and after GR.</p> <p>Check whether S86-1 and S86-2 synchronize topology and routing information from S3760.</p>
<p>S86-1</p>	<pre>S86-1# show isis neighbors</pre>
	<pre>S86-1# show isis database detail</pre>

S86-2	S86-2# show isis neighbors
S3760	S3760# show isis neighbors

6.4.8 Configuring IS-IS NSR

Configuration Effect

- IS-IS nonstop routing (IS-IS NSR) helps improve system reliability. During the active/standby switchover of devices in distributed mode, user data traffic keeps being forwarded without interruption.

Working Mechanism of IS-IS NSR

NSR backs up relevant IS-IS information from the master Supervisor Engine to the slave Supervisor Engine of the distributed device so that the device can automatically recover the link state and regenerate a route upon active/standby switchovers, without requiring help from neighbor devices during the recovery.

Notes

For the same IS-IS process, either NSP or GR is enabled, because they are exclusive.

The switchover of distributed devices takes a period of time. If the IS-IS neighbor keepalive duration is less than the switchover duration, IS-IS neighbor relationship with the neighbor device is removed, and the services are interrupted during the switchover. Therefore, it is recommended to set the IS-IS neighbor keepalive duration not less than the default value. When Fast Hello is enabled, the IS-IS neighbor keepalive duration is less than 1 second and the IS-IS neighbor relationship times out during the switchover, causing NSR failures. Therefore, it is recommended to disable Fast Hello when NSR is enabled.

Configuration Steps

Configuring IS-IS NSR

- Optional. IS-IS NSR is disabled by default. Perform this configuration as required.
- Configure NSR in IS-IS routing process configuration mode on the required devices unless otherwise specified.

Verification

- Verify that user data traffic keeps being forwarded without interruption during the hot-backup switchover of devices in distributed mode.

Related Commands

Enabling NSR

Command	nsr
Parameter	N/A
Description	
Configuration Mode	IS-IS routing process configuration mode
Usage Guide	NSR backs up relevant IS-IS information from the master Supervisor Engine to the slave Supervisor Engine of the distributed device so that the device can automatically recover the link state and regenerate a route upon active/standby switchovers, without requiring help from neighbor devices during the recovery. Information such as the neighbor relationship and link status needs to be backed up. For the same IS-IS process, either NSP or GR is enabled, because they are exclusive.
	The switchover of distributed devices and VSU devices takes a period of time. If the IS-IS neighbor keepalive duration is less than the switchover duration, IS-IS neighbor relationship with the neighbor device is removed, and the services are interrupted during the switchover. Therefore, it is recommended to set the IS-IS neighbor keepalive duration not less

than the default value. When Fast Hello is enabled, the IS-IS neighbor keepalive duration is less than 1 second and the IS-IS neighbor relationship times out during the switchover, causing NSR failures. Therefore, it is recommended to disable Fast Hello when NSR is enabled.

By default, if the DIS is a FS device, the neighbor relationship between the neighbor device and the FS device is maintained for 10 seconds at most (the DIS interface sends one HELLO packet every 3.3 seconds). However, the active/standby switchover of FS devices takes at least 7 seconds. If the switchover takes place when the interface is to send HELLO packets, the period for the neighbor device to receive HELLO packets again may be greater than 10 seconds, leading to neighbor down. To avoid neighbor down, when NSR is enabled, increase the time for maintaining the neighbor relationship with the neighbor device that is to send HELLO packets by 10 seconds.

Configuration Example

↘ **Configuring IS-IS NSR**

<p>Configuration Requirements</p>	<p>Two high-end RG-S8600 devices are required and both support IS-IS NSR and are equipped with master and slave Super Engines to implement redundancy backup on control plane. IS-IS neighbor relationships are established between S86-1 with S86-2, S3760, and S3750.</p> <p>The S86-1 device supports nonstop forwarding to improve high availability of the core device.</p>
<p>IS-IS NSR Topology</p>	
<p>Configuration Steps</p>	<p>Configure the IS-IS routing protocol.</p> <p>Configure Ethernet ports.</p>
<p>S86-1</p>	<pre>S86-1(config)# router isis S86-1(config-router)# nsr</pre>
<p>Verification</p>	<p>Verify that data traffic keeps being forwarded without interruption during the hot-backup switchover.</p> <p>Verify that S86-2, S3760, and S3750 do not perceive the hot-backup switchover of S86-1.</p>
<p>S86-1</p>	<pre>S86-1# show isis neighbors S86-1# show isis database detail S86-1# show isis nsr</pre>
<p>S86-2</p>	<pre>S86-2# show isis neighbors S86-2# show isis database detail</pre>
<p>S3760</p>	<pre>S3760# show isis neighbors S3760# show isis database detail</pre>
<p>S3750</p>	<pre>S3750# show isis neighbors S3750# show isis database detail</pre>

Common Errors

6.4.9 Configuring BFD Support for IS-IS

Configuration Effect

- IS-IS dynamically discovers neighbors through Hello packets. After IS-IS enables the BFD function, a BFD session will be set up with the neighbor in Up state. The BFD mechanism is used to detect the neighbor state. Once a neighbor failure is detected through BFD, IS-IS performs network convergence immediately. The convergence time can be reduced from 30s to less than 1s. By default, IS-IS Hello packets are sent at an interval of 10s in a P2P network, and the time required to detect a neighbor failure is three times the packet interval, that is 30s.

Notes

- You must set BFD session parameters before you enable BFD support for IS-IS.
- When you run the **bfd up-dampening** command on an interface with BFD support for IS-IS, you need to run the **bfd all-interfaces** command with the *[anti-congestion]* option selected.
- When you run the **bfd all-interfaces** command with the *[anti-congestion]* option selected, run the **bfd up-dampening** command on the interface.
- IP routing may cause a neighbor's interface for BFD session setup to be inconsistent with the interface for outgoing BFD packets. If this happens, the BFD session cannot be set up.
- If a neighbor's interface for BFD session setup is inconsistent with the interface for outgoing BFD packets, the BFD session cannot be set up.

Configuration Steps

▾ Enabling BFD Support for IS-IS on All Interfaces

- Perform this configuration based on requirements.
- Run the **bfd ll-interfaces** command in IS-IS routing process configuration mode on the desired device, unless otherwise specified.

▾ Enabling BFD Support for IS-IS on the Current Interface

- Perform this configuration based on requirements.
- Run the **isis bfd** command in interface configuration mode on the desired device, unless otherwise specified.

Verification

- Build a topology with two parallel lines. Typically, IS-IS selects one line as the master line and the other as the backup line. Enable BFD on the master line.
- Make the master line fail. Check whether IS-IS performs route convergence based on the BFD monitoring state and starts the backup line.

Related Commands

▾ Enabling BFD Support for IS-IS on the Current Interface

Command	bfd all-interfaces <i>[anti-congestion]</i>
---------	--

Parameter Description	<i>anti-congestion</i> : Indicates the IS-IS BFD anti-congestion option.
Command Mode	IS-IS routing process configuration mode
Usage Guide	<p>You can enable or disable BFD on an IS-IS interface by using any of the following two methods:</p> <p>Method 1: Run the bfd all-interfaces command in IS-IS routing process configuration mode to enable BFD on all IS-IS interfaces, and then run the no bfd all-interfaces command to disable BFD on all IS-IS interfaces.</p> <p>Method 2: Run the isis bfd [disable] command in interface configuration mode to enable BFD on the specified IS-IS interface, and then run the isis bfd disable command to disable BFD on the interface.</p>

📌 Enabling BFD Support for IS-IS on the Current Interface

Command	isis bfd [disable anti-congestion]
Parameter Description	<p><i>disable</i>: Disables BFD support for IS-IS on the current interface.</p> <p><i>anti-congestion</i>: Indicates the IS-IS BFD anti-congestion option.</p>
Command Mode	Interface configuration mode
Usage Guide	<p>You can enable or disable BFD on an IS-IS interface by using any of the following two methods:</p> <p>Method 1: Run the [no] bfd all-interfaces [anti-congestion] command in IS-IS routing process configuration mode to enable or disable BFD on all IS-IS interfaces.</p> <p>Method 2: Run the isis bfd [disable anti-congestion] command in interface configuration mode to enable or disable BFD on the specified interface.</p> <p>Normally, BFD sends detection packets at millisecond intervals to detect the link state. When a link exception (such as a disconnected link) occurs, BFD can quickly detect it and instruct IS-IS to delete the neighbor relationship and the neighbor reachability information in LSPs. Then IS-IS recalculates and generates a new route to bypass the abnormal link, thus realizing fast convergence. With the introduction of new techniques such as the Multi-Service Transport Platform (MSTP), link congestion tends to occur during peak hours of data communication. BFD quickly detects the link exception and instructs IS-IS to delete the neighbor relationship and the neighbor reachability information in LSPs. Link switch is performed to bypass the congested link. A Hello packet for IS-IS neighbor detection is sent every 10s and its expiration time is 30s. The Hello packet can still be received normally when BFD detects an exception, and therefore an IS-IS neighbor relationship is reestablished quickly, causing the route to be restored to the congested link. Then BFD detects the abnormal link and link switch is performed again. This process is repeated, which makes the route be switched between the congested link and other links, causing repetitive flapping.</p> <p>The anti-congestion option is used to avoid routing flapping in case of link congestion. After the option is configured, the IS-IS neighbor state is still kept alive when link congestion occurs, but the neighbor reachability information in LSPs is deleted. The route is switched to a normal link. When the congested link is restored, the neighbor reachability information in LSPs is recovered and the route is switched back, which avoids route flapping.</p> <p>When you run the bfd all-interfaces [anti-congestion] command, run the bfd up-dampening command on the interface. The two commands must be used together. If you run only one command, the route flap dampening feature may not take effect or other network exceptions may occur.</p>

Configuration Example

📌 Enabling BFD Support for IS-IS on the Current Interface

Configuration Steps	<ul style="list-style-type: none"> ● Configure IS-IS neighbors. (Omitted) ● Set BFD session parameters. (Omitted) ● Enable BFD support for IS-IS on the current interface.
	<pre>A(config)# interface GigabitEthernet 0/1 A(config-if)# isis bfd</pre>
Verification	<p>Enable S1 (192.168.1.10) and S2 (192.168.2.10) to send packets to G1 (229.1.1.1) and G2 (229.1.2.1). Add User to the G1 and G2 groups.</p> <ul style="list-style-type: none"> ● Check the multicast packet that User receives. User should only receive the (S1, G1) packet. ● Check that the PIM-SM routing table does not have the (S1, G2), (S2, G1), and (S2, G2) entries.
	<pre>A# show bfd neighbors detail</pre>

Common Errors

- BFD support for IS-IS is not enabled on neighbors.

6.4.10 Setting the IS-IS Overload Bit

Configuration Effect

The overload bit is used in the following three situations:

- Device overload

The local IS-IS node has overload issues, such as insufficient memory or full CPU load; as a result, its routing table has incomplete routes or does not have resource forwarding data. You can set the overload bit in an LSP to instruct the neighbor not to use the local node as a forwarding device.

To set the overload bit, run the **set-overload-bit** command without the **on-startup** keyword. The overload bit can be configured or canceled manually. When the local IS-IS node is restored, manually cancel the command configuration; otherwise, the node is always in overload state.

- Instantaneous black hole

In the scenario described by RFC3277, the IS-IS convergence speed is faster than the BGP speed; as a result, after an IS-IS node is restarted, a route may be instantaneously unreachable, which is called an instantaneous black hole. You can set the overload bit in an LSP to instruct the neighbor not to use the local node as a forwarding device until the specified time has elapsed.

To set the overload bit, run the **set-overload-bit** command with the **on-startup** keyword. The overload bit can be configured or canceled automatically by the IS-IS node based on the configuration. If the **on-startup** keyword is selected, the IS-IS node automatically enters instantaneous black hole state after restart. When a neighbor relationship is established, the IS-IS node sends an LSP with the overload bit to notify the neighbor that the local node enters instantaneous black hole (or overload) state and instruct the neighbor not to use the local node as a forwarding device. After the specified time has elapsed, the IS-IS node immediately sends an LSP with the overload bit canceled to notify the neighbor that the local node has exited instantaneous black hole (or overload) state and can work as a forwarding device.

- Disabling real data forwarding on the local IS-IS node

If you only need to connect the local IS-IS node to a production network for testing or to meet other functional requirements, but does not require the node to forward real data in the network, you can set the overload bit in an LSP to instruct the neighbor not to use the local node as a forwarding device.

To set the overload bit, run the **set-overload-bit** command without the **on-startup** keyword. The overload bit can be configured or canceled manually. You can set the **suppress** keyword based on requirements to limit the routing information carried in an LSP in case of overload. For example, internal and external routes can be suppressed, and only the local direct route is advertised.

Notes

- At the same Level, the configuration with the **on-startup** keyword is mutually exclusive with the configuration without the **on-startup** keyword.

Configuration Steps

- Perform this configuration based on requirements.
- Run the **set-overload-bit** command in IS-IS routing process configuration mode on the desired device, unless otherwise specified.

Verification

- Capture packets and check that the neighbor does not forward LSPs from the local node.

Related Commands

Command	set-overload-bit [on-startup { <i>seconds</i> wait-for-bgp [<i>bgpseconds</i>] }] [suppress { [interlevel] [external] }] [level-1 level-2]
Parameter Description	<p>on-startup <i>seconds</i>: Indicates the duration when an IS-IS node remains in overload state after restart. The value range is 5s to 86,400s.</p> <p>wait-for-bgp <i>bgpseconds</i>: Indicates the duration in which an IS-IS node automatically enters and remains in the wait-for-BGP convergence state after restart. The value ranges from 5–86,400 in seconds. The default value is 600.</p> <p>suppress: Indicates not to advertise internal routes (intra-area and inter-area routes) or external routes to neighbors when the IS-IS node is in overload state.</p> <p>interlevel: Indicates not to advertise intra-area and inter-area routes to neighbors when the IS-IS node is in overload state. It is used with the suppress keyword.</p> <p>external: Indicates not to advertise external routes to neighbors when the IS-IS node is in overload state. It is used with the suppress keyword.</p> <p>level-1: Sends LSPs with the overload bit only to Level-1 neighbors.</p> <p>level-2: Sends LSPs with the overload bit only to Level-2 neighbors.</p>
Command Mode	IS-IS routing process configuration mode
Usage Guide	<p>Use this command to force an IS-IS node to set the overload bit in a non-virtual LSP to instruct its IS-IS neighbors not to use the local node as a forwarding device.</p> <p>If you select the on-startup keyword, the IS-IS node automatically enters overload state after restart.</p> <p>If you do not select the on-startup keyword, the IS-IS node enters overload state immediately after restart.</p>

Configuration Example

➤ **Configuring the Overload Bit in Case of an Instantaneous Black Hole**

Configuration Steps	<ul style="list-style-type: none"> ● Configure IS-IS neighbors. (Omitted) ● Verify that the IS-IS node enters instantaneous black hole state immediately after restart and remains in this state until the specified time (300s) has elapsed, and the IS-IS node only advertises local direct links to its neighbors during the specified time.
	<pre>A(config)# router isis A(config-router)#set-overload-bit on-startup 300 suppress interlevel external</pre>
Verification	<p>Capture packets to check LSPs.</p> <ul style="list-style-type: none"> ● Verify that the IS-IS node automatically enters instantaneous black hole state after restart. Once a neighbor relationship is established, the IS-IS node sends an LSP with the overload bit. ● After the specified time has elapsed, the IS-IS node immediately sends an LSP with the overload bit canceled to notify its neighbors that the local node has exited instantaneous black hole (or overload) state.
	<pre>A# show isis neighbors</pre>

➤ **Disabling Real Data Forwarding on the Local IS-IS Node**

Configuration Steps	<ul style="list-style-type: none"> ● Configure IS-IS neighbors. (Omitted) ● Connect the local IS-IS node as a test device to a production network. The node is not required to forward real data in the network to avoid impact on production.
	<pre>A(config)# router isis A(config-router)#set-overload-bit suppress interlevel external</pre>
Verification	<p>Capture packets to check LSPs. Verify that the LSPs carry the overload bit and only advertise local direct routes.</p>
	<pre>A# show isis neighbors</pre>

6.4.11 Configuring IS-IS VRF

Configuration Effect

- Each VRF table can be seen as a virtual device or a dedicated PE device.
- The virtual device contains the following elements: an independent routing table, as well as an independent address space; a set of interfaces that belong to the VRF table; a set of routing protocols applicable only to the VRF table.
- Each device can maintain one or more VRF tables and a public-network routing table (also called a global routing table). Multiple VRF instances are separated from each other.

Notes

- Note the following constraints or conventions when you bind IS-IS instances and VRF tables:

- The IS-IS instances bound with the same VRF table must be configured with different system IDs. The IS-IS instances bound with different VRF tables can be configured with the same system ID.
- One IS-IS instance can be bound with only one VRF table, but one VRF table can be bound to multiple IS-IS instances.
- When the VRF table bound to an IS-IS instance is changed, all IS-IS interfaces associated with the instance will be deleted. That is, the **ip router isis [tag]** interface configuration and the redistribution configuration in routing process configuration mode will be deleted.

Configuration Steps

- Perform this configuration based on requirements.
- Run the **vrf** command in IS-IS routing process configuration mode on the desired device, unless otherwise specified.

Verification

- Check whether the local device establishes neighbor relationships with other devices specified in the VRF table.

Related Commands

⌵ **Configuring IS-IS VRF**

Command	vrf vrf-name
Parameter Description	<i>vrf-name</i> : Indicates the name of an existing VRF table.
Command Mode	IS-IS routing process configuration mode
Usage Guide	<p>Before you bind an IS-IS instance to a VRF table, ensure that the VRF table has been configured. If you need to establish an IS-ISv6 neighbor relationship, enable IPv6 and ensure that the table to be bound is a multiprotocol VRF table.</p> <p>Note the following constraints or conventions when you bind IS-IS instances and VRF tables:</p> <ul style="list-style-type: none"> ● The IS-IS instances bound with the same non-default VRF table must be configured with different system IDs. The IS-IS instances bound with different VRF tables can be configured with the same system ID. ● One IS-IS instance can be bound with only one VRF table, but one VRF table can be bound to multiple IS-IS instances. ● When the VRF table bound to an IS-IS instance is changed, all IS-IS interfaces associated with the instance will be deleted. That is, the ip (or ipv6) router isis [tag] interface configuration and the redistribution configuration in routing process configuration mode will be deleted.

Configuration Example

⌵ **Configuring IS-IS VRF**

Configuration Steps	<ul style="list-style-type: none"> ● Bind an IS-IS instance to a VRF table. ● Add interfaces to the VRF table and IS-IS instance. (Omitted)
----------------------------	---

<pre>A(config)#vrf definition vrf_1 A(config-vrf)#address-family ipv4 A(config-vrf-af)#exit-address-family A(config)# router isis A(config-router)# vrf vrf_1</pre>
<p>Verification</p> <p>Check whether the local device establishes neighbor relationships with other devices specified in the VRF table.</p>
<pre>A# show isis neighbors</pre>

Common Errors

- Interfaces are not added to the VRF table.
- The IP addresses of the interfaces connected between neighbors are not in the same network segment.
- The **ip router isis** command is not executed on interfaces.
- No NET address is configured, or different NET addresses exist at Level-1.
- **max-area-addresses** is configured differently on both sides.
- **metric-style** is configured differently on both sides.
- The interface Levels on both sides are different. One side is Level-1, whereas the other side is Level-2.
- One side is configured with the P2P mode, whereas the other side is configured with the broadcast mode.
- One side is enabled with authentication, whereas the other side is not.

6.4.12 Configuring IS-IS MTR

Configuration Effect

- If the **multi-topology** command is not executed, IPv4 and IPv6 share one IS-IS physical topology, also called the default topology. If the **multi-topology** command is executed without the **transition** parameter, routing devices run in MT mode. IS-ISv4 runs in the default topology, and IS-ISv6 runs in the IPv6 unicast topology. If the **multi-topology** command is executed with the **transition** parameter, routing devices run in MTT mode. IS-ISv6 runs in the default topology and IPv6 unicast topology. The three configurations are mutually exclusive. The routing devices in MTT mode can transfer the MT TLV or the default topology TLV. The MTT mode is applicable to incremental deployment to ensure smooth network migration. The MTT mode can cause route leaking between the default topology and IPv6 unicast topology. If the MTT mode is configured improperly, network failures such as routing black holes and loops may occur.

Notes

Note the following constraints or conventions when you configure the IS-IS MTR feature:

- Set **metric-style** to **Wide** or **Transition** before you run the **multi-topology** command.
- The MTR feature will be disabled if **metric-style** is set to **Narrow** or only one Level is configured to support the Wide or Transition mode.

Configuration Steps

- Perform this configuration based on requirements.
- Configure the MTR feature in IS-IS address-family ipv6 configuration mode on the desired device, unless otherwise specified.

Verification

- Check whether the local device establishes neighbor relationships with other devices.

Related Commands

↘ **Configuring IS-IS MTR**

Command	multi-topology [<i>transition</i>]
Parameter Description	<i>transition</i> : Configures the MTT mode, which supports smooth migration from an IPv4-IPv6 hybrid topology to separate IPv4 and IPv6 topologies.
Command Mode	IS-IS address-family ipv6 configuration mode
Usage Guide	<p>If the multi-topology command is not executed, IPv4 and IPv6 share one IS-IS physical topology, also called the default topology. If the multi-topology command is executed without the transition parameter, routing devices run in MT mode. IS-ISv4 runs in the default topology, and IS-ISv6 runs in the IPv6 unicast topology. If the multi-topology command is executed with the transition parameter, routing devices run in MTT mode. IS-ISv6 runs in the default topology and IPv6 unicast topology. The three configurations are mutually exclusive. The routing devices in MTT mode can transfer the MTTLV or the default topology TLV. The MTT mode is applicable to incremental deployment to ensure smooth network migration. The MTT mode can cause route leaking between the default topology and IPv6 unicast topology. If the MTT mode is configured improperly, network failures such as routing black holes and loops may occur.</p> <p>Set metric-style to Wide or Transition before you run the command. The MTR feature will be disabled if metric-style is set to Narrow or only one Level is configured to support the Wide or Transition mode.</p>

Configuration Example

↘ **Configuring IS-IS MTR**

Configuration Requirements	<p>The typical application scenario of MTR is to retain devices that only support IPv4 services in a network where IPv6 service extension will be performed.</p> <p>In Figure 1-20, Router 2 only supports the IPv4 protocol stack but does not support the MTR feature; therefore, it can only run IPv4 services. The network capacity needs to be scaled to support IPv6 services in order to meet service extension requirements. (Router 1, Router 3, and Router 4 that support the MTR feature will be added.) The device (Router 2) that supports only one protocol stack must be replaced to maintain the stability of the network running IPv4 and IPv6 dual protocol stacks; otherwise, IPv6 routing black holes may occur.</p> <p>If you need to retain Router 2, you can configure the MTR feature on Router 1, Router 3, and Router 4. The MTR feature enables Router 2 to continue to run IPv4 services without interference on the IPv4 and IPv6 services on Router 1, Router 3, and Router 4. The MTR feature improves networking flexibility, indirectly prolongs the service life of old devices, and meets service extension requirements while maximizing the values of old devices.</p> <p>The configuration requirements are as follows:</p> <ul style="list-style-type: none"> ● Retain Router 2, which only supports IPv4 services. ● Add devices that support IPv4 and IPv6 dual topologies, and separate IPv4 route calculation and IPv6 route
-----------------------------------	---

calculation based on different topologies.

Figure 6- 19
IS-IS MTR
Topology

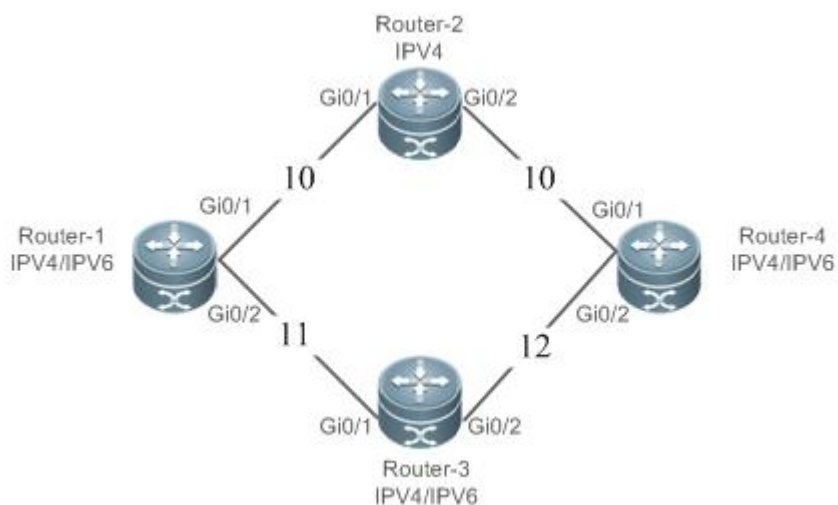

Router 1

Configure IS-IS and Ethernet interfaces.

Configure IS-IS:

```

FS(config)# router isis
FS(config-router)# net 49.0001. 0000.0000.0001.00
FS(config-router)# is-type level-1
FS(config-router)# metric-style wide
FS(config-router)# address-family ipv6
FS(config-router-af)# multi-topology
    
```

Configure Ethernet interfaces:

```

FS(config)# interface gigabitEthernet 0/1
FS(config-if-GigabitEthernet 0/1)# ipv6 enable
FS(config-if-GigabitEthernet 0/1)# ipv6 address 1002:: 1/112
FS(config-if-GigabitEthernet 0/1)# ipv6 router isis
FS(config-if-GigabitEthernet 0/1)# ip address 192.168.1.1 255.255.255.0
FS(config-if-GigabitEthernet 0/1)# ip router isis
FS(config-if-GigabitEthernet 0/1)# interface gigabitEthernet 0/2
FS(config-if-GigabitEthernet 0/2)# ipv6 enable
FS(config-if-GigabitEthernet 0/2)# ipv6 address 1003:: 1/112
FS(config-if-GigabitEthernet 0/2)# ipv6 router isis
FS(config-if-GigabitEthernet 0/2)# ip address 192.168.2.1 255.255.255.0
FS(config-if-GigabitEthernet 0/2)# ip router isis
    
```

	<pre>FS(config-if-GigabitEthernet 0/2)#isis wide-metric 11</pre>
Router 2	<p>Configure IS-IS and Ethernet interfaces.</p> <p>Configure IS-IS:</p> <pre>FS(config)# router isis FS(config-router)# net 49.0001. 0000.0000.0002.00 FS(config-router)# is-type level-1 FS(config-router)# metric-style wide FS(config-router)#address-family ipv6 FS(config-router-af)#no adjacency-check</pre> <p>Configure Ethernet interfaces:</p> <pre>FS(config)# interface gigabitEthernet 0/1 FS(config-if-GigabitEthernet 0/1)# ip address 192.168.1.2 255.255.255.0 FS(config-if-GigabitEthernet 0/1)# ip router isis FS(config-if-GigabitEthernet 0/1)# interface gigabitEthernet 0/2 FS(config-if-GigabitEthernet 0/2)# ip address 192.168.3.2 255.255.255.0 FS(config-if-GigabitEthernet 0/2)# ip router isis</pre>
Router 3	<p>Configure IS-IS and Ethernet interfaces.</p> <p>Configure IS-IS:</p> <pre>FS(config)# router isis FS(config-router)# net 49.0001. 0000.0000.0003.00 FS(config-router)# is-type level-1 FS(config-router)# metric-style wide FS(config-router)# address-family ipv6 FS(config-router-af)# multi-topology</pre> <p>Configure Ethernet interfaces:</p> <pre>FS(config)# interface gigabitEthernet 0/1 FS(config-if-GigabitEthernet 0/1)# ipv6 enable FS(config-if-GigabitEthernet 0/1)# ipv6 address 3001:: 1/112 FS(config-if-GigabitEthernet 0/1)# ipv6 router isis FS(config-if-GigabitEthernet 0/1)# ip address 192.168.2.3 255.255.255.0 FS(config-if-GigabitEthernet 0/1)# ip router isis FS(config-if-GigabitEthernet 0/1)#isis wide-metric 11 FS(config-if-GigabitEthernet 0/1)# interface gigabitEthernet 0/2</pre>

	<pre> FS(config-if-GigabitEthernet 0/2)# ipv6 enable FS(config-if-GigabitEthernet 0/2)# ipv6 address 3004: : 1/112 FS(config-if-GigabitEthernet 0/2)# ipv6 router isis FS(config-if-GigabitEthernet 0/2)# ip address 192.168.4.3 255.255.255.0 FS(config-if-GigabitEthernet 0/2)# ip router isis FS(config-if-GigabitEthernet 0/2)#isis wide-metric 12 </pre>
Router 4	Configure IS-IS and Ethernet interfaces.
	<p>Configure IS-IS:</p> <pre> FS(config)# router isis FS(config-router)# net 49.0001.0000.0000.0004.00 FS(config-router)# is-type level-1 FS(config-router)# metric-style wide FS(config-router)# address-family ipv6 FS(config-router-af)# multi-topology </pre> <p>Configure Ethernet interfaces:</p> <pre> FS(config)# interface gigabitEthernet 0/1 FS(config-if-GigabitEthernet 0/1)# ipv6 enable FS(config-if-GigabitEthernet 0/1)# ipv6 address 4002: : 1/112 FS(config-if-GigabitEthernet 0/1)# ipv6 router isis FS(config-if-GigabitEthernet 0/1)# ip address 192.168.3.4 255.255.255.0 FS(config-if-GigabitEthernet 0/1)# ip router isis FS(config-if-GigabitEthernet 0/1)# interface gigabitEthernet 0/2 FS(config-if-GigabitEthernet 0/2)# ipv6 enable FS(config-if-GigabitEthernet 0/2)# ipv6 address 4003: : 1/112 FS(config-if-GigabitEthernet 0/2)# ipv6 router isis FS(config-if-GigabitEthernet 0/2)# ip address 192.168.4.4 255.255.255.0 FS(config-if-GigabitEthernet 0/2)# ip router isis </pre>
Verification	<ul style="list-style-type: none"> ● Run the show command on Router 1 to check whether the next hop of the IPv4 route destined for Router 4 is Router 2. ● Run the show command on Router 1 to check whether the next hop of the IPv6 route destined for Router 4 is Router 3.
Checking the IPv4 route	<pre> FS#show ip route </pre> <p>Codes: C - connected, S - static, R - RIP, B - BGP</p> <p>O - OSPF, IA - OSPF inter area</p>

	<p>N1 - OSPF NSSA external type 1, N2 - OSPF NSSA external type 2</p> <p>E1 - OSPF external type 1, E2 - OSPF external type 2</p> <p>i - IS-IS, su - IS-IS summary, L1 - IS-IS level-1, L2 - IS-IS level-2</p> <p>ia - IS-IS inter area, * - candidate default</p> <p>Gateway of last resort is no set</p> <p>C 192.168.1.0/24 is directly connected, GigabitEthernet 0/1</p> <p>C 192.168.1.1/32 is local host.</p> <p>C 192.168.2.0/24 is directly connected, GigabitEthernet 0/2</p> <p>C 192.168.2.1/32 is local host.</p> <p>i L1 192.168.3.0/24 [115/20] via 192.168.1.2, 00:13:14, GigabitEthernet 0/1</p> <p>i L1 192.168.4.0/24 [115/23] via 192.168.2.3, 00:02:40, GigabitEthernet 0/2</p>
<p>Checking the IPv6 route</p>	<pre> FS#show ipv6 route IPv6 routing table name is - Default - 16 entries Codes: C - Connected, L - Local, S - Static, R - RIP, B - BGP I1 - ISIS L1, I2 - ISIS L2, IA - ISIS interarea, IS - ISIS summary O - OSPF intra area, OI - OSPF inter area, OE1 - OSPF external type 1, OE2 - OSPF external type 2 ON1 - OSPF NSSA external type 1, ON2 - OSPF NSSA external type 2 L ::1/128 via Loopback, local host C 1002::/112 via GigabitEthernet 0/1, directly connected L 1002::1/128 via GigabitEthernet 0/1, local host C 1003::/112 via GigabitEthernet 0/2, directly connected L 1003::1/128 via GigabitEthernet 0/2, local host I1 3001::/112 [115/21] via FE80::C806:5FF:FEE8:38, GigabitEthernet 0/2 I1 3004::/112 [115/21] via FE80::C806:5FF:FEE8:38, GigabitEthernet 0/2 I1 4002::/112 [115/31] via FE80::C806:5FF:FEE8:38, GigabitEthernet 0/2 I1 4003::/112 [115/31] via FE80::C806:5FF:FEE8:38, GigabitEthernet 0/2 L FE80::/10 via ::1, Null0 C FE80::/64 via GigabitEthernet 0/2, directly connected L FE80::1614:4BFF:FE12:ADFC/128 via GigabitEthernet 0/2, local host C FE80::/64 via GigabitEthernet 0/1, directly connected L FE80::1614:4BFF:FE12:ADFD/128 via GigabitEthernet 0/1, local host C FE80::/64 via Local 0, directly connected L FE80::1614:4BFF:FE12:ADFC/128 via Local 0, local host </pre>

Common Errors

- **metric-style** is not set to **Wide** or **Transition**.
- The protocol types used by two neighbors do not match; therefore, a neighbor relationship cannot be established.
- The IP addresses of the interfaces connected between neighbors are not in the same network segment.
- The **ip router isis** command is not executed on interfaces.
- No NET address is configured, or different NET addresses exist at Level 1.
- **max-area-addresses** is configured differently on both sides.
- **metric-style** is configured differently on both sides.
- The interface Levels on both sides are different. One side is Level-1, whereas the other side is Level-2.
- One side is configured with the P2P mode, whereas the other side is configured with the broadcast mode.
- One side is enabled with authentication, whereas the other side is not.

6.4.13 Configuring SNMP for IS-IS

Configuration Effect

- By default, the SNMP software can perform the MIB operation on the first IS-IS instance. To perform the MIB operation on other instances, you need to manually specify these instances.

Notes

- By default, the SNMP software can perform the MIB operation on the first displayed IS-IS instance.

Configuration Steps

↘ Binding the Instances on Which the IS-IS MIB Operation Will Be Performed

- Perform this configuration based on requirements.
- Run the **enable mib-binding** command in IS-IS routing process configuration mode on the desired device, unless otherwise specified.

↘ Enabling IS-IS Trap Globally

- Perform this configuration based on requirements.
- Run the **snmp-server enable traps isis** command in global configuration mode on the desired device, unless otherwise specified.

↘ Configuring an SNMP Host Globally

- Perform this configuration based on requirements.
- Run the **snmp-server host** command in global configuration mode on the desired device, unless otherwise specified.

↘ Allowing the Sending of all IS-IS Trap Messages to the SNMP Host

- Perform this configuration based on requirements.
- Run the **enable traps all** command in IS-IS routing process configuration mode on the desired device, unless otherwise specified.

Verification

- Use the MIB tool to read and write IS-IS settings.

Related Commands

↘ **Binding the Instances on Which the IS-IS MIB Operation Will Be Performed**

Command	enable mib-binding
Parameter Description	N/A
Command Mode	IS-IS routing process configuration mode
Usage Guide	The latest standards stipulate that the MIB operation can be performed on a single instance. By default, the MIB operation is performed on the first displayed IS-IS instance. Because multiple IS-IS instances can be configured, the administrator can use this command to specify the instances on which the MIB operation will be performed.

↘ **Enabling IS-IS Trap Globally**

Command	snmp-server enable traps [<i>isis</i>]
Parameter Description	<i>isis</i> : Enables IS-IS event trap.
Command Mode	Global configuration mode
Usage Guide	This command must be used with the snmp-server host command in global configuration mode so that trap messages can be sent.

↘ **Configuring an SNMP Host Globally**

Command	snmp-server host { <i>host-addr</i> ipv6 <i>ipv6-addr</i> } [<i>vrf vrfname</i>] [traps] [version { 1 2c 3 { auth noauth priv }] <i>community-string</i> [udp-port <i>port-num</i>] [<i>notification-type</i>]
Parameter Description	<i>host-addr</i> : Indicates the address of the SNMP host. <i>ipv6-addr</i> : Indicates the IPv6 address of the SNMP host. <i>vrfname</i> : Indicates the name of a VRF table. version : Indicates the SNMP version, which can be set to V1 , V2C , or V3 auth noauth priv : Indicates the security level of V3 users. <i>community-string</i> : Indicates the community string or user name (V3 version). <i>port-num</i> : Indicates the port number of the SNMP host. <i>notification-type</i> : Indicates the type of trap messages that are actively sent, for example, snmp.
Command Mode	Global configuration mode
Usage Guide	This command is used with the snmp-server enable traps command to actively send trap messages to a Network Management System (NMS). You can configure different SNMP hosts to receive trap messages. A host supports different trap types, ports, and VRF tables. For the same host (with the same port configuration and VRF configuration), the last configuration is combined with the previous configurations. That is, to send different trap messages to the same host, configure a type of trap messages each time. These configurations are finally combined.

➤ **Allowing the Sending of Trap Messages**

Command	enable traps { all <i>traps set</i> }
Parameter	all : Indicates all trap messages.
Description	<i>traps set</i> : Indicates a trap message type in any set.
Command Mode	IS-IS routing process configuration mode
Usage Guide	IS-IS packets are classified into 18 types of trap messages, which are grouped into several sets, with each set containing several trap message types. To enable the sending of IS-IS trap messages, run the snmp-server enable traps isis command in global configuration mode and specify the recipient host and the type of trap messages that can be sent.

Configuration Example

➤ **Configuring IS-IS SNMP**

Configuration Steps	<ul style="list-style-type: none"> ● Bind the instances on which the IS-IS MIB operation will be performed. ● Complete trap message-related settings.
	<pre>A(config)# router isis A(config-router)# enable mib-binding A# configure terminal A(config)#snmp-server enable traps isis A(config)#snmp-server host 10.1.1.1 traps version 2c public A(config)#router isis A(config-router)# enable traps all</pre>
Verification	Run the MIB tool to read and write IS-IS settings.
	<pre>A# show running-config</pre>

6.4.14 Configuring IS-IS Two-way Maintenance

Configuration Effect

- Enable IS-IS two-way maintenance.

Notes

- The IS-IS basic functions must be configured.
- The neighbor relationship is successfully established.

Configuration Steps

➤ **Configuring IS-IS Two-way Maintenance**

- Configure the two-way maintenance function as required.

- Run the **two-way-maintain** command in IS-IS routing process configuration mode on the required devices unless otherwise specified.

Verification

- Run the **show isis neighbor** command to check the neighbor update time.
- Run the **show isis protocol** command to check whether the two-way maintenance function is enabled.

Related Commands

📌 **Configuring IS-IS Two-way Maintenance**

Command	two-way-maintain
Parameter Description	N/A
Command Mode	IS-IS routing process configuration mode
Usage Guide	In a large-scale network, a large number of packets are sent and received, which occupies lots of CPU and memory resources, causing some IS-IS packets to be delayed or discarded. If the time required for processing HELLO packets exceeds the neighbor relationship maintenance time, the corresponding neighbor relationship times out and is removed. When the two-way maintenance function is enabled, if a large number of packets exist on the network, the LSP packets, CSNP packets, and PSNP packets from a neighbor in addition to HELLO packets can also be used to maintain the two-way relationship with the neighbor, preventing neighbor failure caused by delay or discard of HELLO packets.

Configuration Example

- 📘 The following example is implemented based on IS-IS basic functions. For details about the IS-IS basic functions, see preceding description

📌 **Configuring IS-IS Two-way Maintenance**

Scenario	<p style="text-align: center;">Area 49.0001</p>
Configuration Steps	<ul style="list-style-type: none"> ● Configure the ISIS basic functions on all devices. ● The neighbor relationship is successfully established.
Verification	<p>Verify that an ISIS interface neighbor is established on device A.</p> <p>Check the status of an ISIS instance on device A.</p>

Common Errors

6.4.15 Configuring Other IS-IS Parameters

Configuration Effect

- **maximum-paths:** Configures the maximum number of IS-IS equal-cost paths to be installed to a routing table.
- **max-metric on-neighbor-up :** Configures the maximum metric for the connected routes after the first neighbor is up.
- **lsp-length receive:** Configures the maximum length allowed for received LSPs.
- **lsp-length originate:** Configures the maximum length allowed for sent LSPs.
- **passive-interface:** Prevents passive interfaces from receiving and sending IS-IS packets. That is, IS-IS neighbor relationships will not be established on passive interfaces. The IP addresses of passive interfaces are flooded through other interfaces.
- **bandwidth-reference:** Configures the bandwidth reference for IS-IS to automatically calculate the link metric. If a metric is configured, the metric prevails. If no metric is configured, the metric is automatically calculated based on the configured bandwidth reference.
- **interface-protocol-compatible:** Configures the TLV field of the IS-IS protocol to be padded based on protocols supported by an interface.
- **is-name:** Replaces the system ID of an instance with the configured name.
- **isis metric:** Stores the metric, which is used in SPF calculation, in the IP reachability information TLV. The greater the metric, the greater the routing consumption of the interface and the longer the path obtained by SPF calculation.
- **isis passive:** Prevents the interface from sending or receiving IS-IS packets, but the corresponding IP address will be flooded through other interfaces.
- **isis priority:** In a broadcast network, IS-IS needs to elect a DIS among all devices. The DIS will generate a pseudonode and related LSPs. The device with the highest priority is elected as the DIS. You can configure different priorities for different Levels.
- **isis suppress on-neighbor-up :** Suppresses the routing calculation after the IS-IS neighbor is up.
- **default-information originate:** Generates a Level-2 default route, which will be advertised through LSPs.
- **spf-interval:** Configures the exponential backoff algorithm of SPF.
- **summary-address** and **summary-prefix:** Creates a summary route to represent a group of routes in a routing table. A summary route can include multiple routes of the specified Level. The interface metric of the summary route follows the smallest interface metric among all routes.
- **log-adjacency-changes:** Enables neighbor relationship event output to log IS-IS neighbor relationship changes.
- **redistribute:** Redistributes other routes to IS-IS; redistributes Level-1 routes to Level-2; redistributes Level-2 routes to Level-1.

Configuration Steps

↘ **Configuring the Maximum Number of Equal-Cost Paths**

- Perform this configuration based on requirements.
- Run the **maximum-paths** command in IS-IS routing process configuration mode or IS-IS address-family ipv6 configuration mode on the desired device, unless otherwise specified.

↘ **Configuring the Maximum Metric for the Connected Routes after the First Neighbor Is Up**

- Perform this configuration based on requirements.
- Run the **max-metric on-neighbor-up** command in IS-IS routing process configuration mode on the desired device, unless otherwise specified.

↘ **Configuring the Maximum Length Allowed for Received LSPs**

- Perform this configuration based on requirements.
- Run the **isp-length receive** command in IS-IS routing process configuration mode on the desired device, unless otherwise specified.
- ▼ **Configuring the Maximum Length Allowed for Sent LSPs**
 - Perform this configuration based on requirements.
 - Run the **isp-length originate** command in IS-IS routing process configuration mode on the desired device, unless otherwise specified.
- ▼ **Configuring a Passive Interface**
 - Perform this configuration based on requirements.
 - Run the **passive-interface** command in IS-IS routing process configuration mode on the desired device, unless otherwise specified.
- ▼ **Configuring the IS-IS Interface Bandwidth Reference**
 - Perform this configuration based on requirements.
 - Run the **bandwidth-reference** command in IS-IS routing process configuration mode on the desired device, unless otherwise specified.
- ▼ **Configuring the TLV Field of the IS-IS Protocol to Be Padded Based on Protocols Supported by an Interface**
 - Perform this configuration based on requirements.
 - Run the **interfaces-protocol-compatible** command in IS-IS routing process configuration mode on the desired devices, unless otherwise specified.
- ▼ **Configuring the IS-IS Instance Alias**
 - Perform this configuration based on requirements.
 - Run the **is-name** command in IS-IS routing process configuration mode on the desired device, unless otherwise specified.
- ▼ **Configuring the IS-IS Interface Metric**
 - Perform this configuration based on requirements.
 - Run the **isis metric** command in interface configuration mode on the desired device, unless otherwise specified.
- ▼ **Configuring an Interface as a Passive Interface**
 - Perform this configuration based on requirements.
 - Run the **isis passive** command in interface configuration mode on the desired device, unless otherwise specified.
- ▼ **Configuring the Priority of the DIS**
 - Perform this configuration based on requirements.
 - Run the **isis priority** command in interface configuration mode on the desired device, unless otherwise specified.
- ▼ **Suppressing the Routing Calculation after the IS-IS Neighbor Is Up**
 - Perform this configuration based on requirements.
 - Run the **isis suppress on-neighbor-up** command in interface configuration mode on the desired device, unless otherwise specified.
- ▼ **Generating a Default Route**

- Perform this configuration based on requirements.
- Run the **default-information originate** command in IS-IS routing process configuration mode or IS-IS address-family ipv6 configuration mode on the desired device, unless otherwise specified.
- ▼ **Configuring the SPF Calculation Cycle**
 - Perform this configuration based on requirements.
 - Run the **spf-interval** command in interface configuration mode on the desired device, unless otherwise specified.
- ▼ **Configure a Summary Route**
 - Perform this configuration based on requirements.
 - Run the **summary-address** and **summary-prefix** commands in IS-IS routing process configuration mode or IS-IS address-family ipv6 configuration mode on the desired device, unless otherwise specified.
- ▼ **Enabling Neighbor Relationship Event Output**
 - Perform this configuration based on requirements.
 - Run the **log-adjacency-changes** command in IS-IS routing process configuration mode on the desired device, unless otherwise specified.
- ▼ **Configuring Route Redistribution**
 - Perform this configuration based on requirements.
 - Run the **redistribute** command in IS-IS routing process configuration mode on the desired device, unless otherwise specified.

Verification

- **maximum-paths**: Check whether the maximum number of equal-cost paths displayed by routing entries is the same as the configuration.
- **max-metric on-neighbor-up**: Check the database details of IS-IS.
- **lsp-length receive**: Capture packets to check the length of LSPs.
- **lsp-length originate**: Capture packets to check the length of LSPs.
- **passive-interface**: Capture packets to check whether the interface receives and sends IS-IS packets.
- **bandwidth-reference**: Check the metric of the routing table.
- **interfaces-protocol-compatible**: Check the neighbor relationship establishment status.
- **is-name**: Check the database details of IS-IS
- **isis metric**: Check the database details of IS-IS.
- **isis priority**: Check whether the device with the changed priority setting is elected as the DIS.
- **isis suppress on-neighbor-up**: Check the database details of IS-IS.
- **default-information originate**: Check whether a default route is generated.
- **spf-interval**: Check whether the SPF calculation cycle works.
- **summary-address** and **summary-prefix**: Capture packets to check whether the summary route instead of detailed routes is advertised through LSPs.

- **log-adjacency-changes:** Change the neighbor state and verify that the change is recorded when debugging is disabled.
- **redistribute:** Check IS-IS routing entries.

Related Commands

▾ **Configuring the Maximum Number of Equal-Cost Paths**

Command	maximum-paths <i>maximum</i>
Parameter Description	<i>maximum</i> : Indicates the maximum number of IS-IS equal-cost routes to be installed to a routing table. The value range is 1 to 32.
Command Mode	IS-IS routing process configuration mode and IS-IS address-family ipv6 configuration mode
Usage Guide	This command is used by IS-IS to control the number of IS-IS equal-cost paths to be installed to a routing table. The routing table also has a command used to control the number of equal-cost paths. The number of effective equal-cost paths is determined by either of the two command values, whichever is smaller.

▾ **Configuring the Maximum Metric for the Connected Routes after the First Neighbor Is Up**

Command	max-metric on-neighbor-up <i>seconds</i>
Parameter Description	<i>Seconds</i> : Indicates the delay time, the value range is 5 to 1800..
Command Mode	IS-IS routing process configuration mode
Usage Guide	When the ISIS Overlay scene is applied on the Underlay network, Overlay tunnel may rely on Underlay routing. After ISIS neighbor is up, the Underlay routing is reachable but the Overlay tunnel may not be created, which may lead to traffic interruption. Therefore, this command is run to prevent traffic interruption. According to the metric type, the maximum metric for Narrow is 63 and for Wide is 16777214.

▾ **Configuring the Maximum Length Allowed for Received LSPs**

Command	lsp-length receive <i>size</i>
Parameter Description	<i>size</i> : Indicates the maximum length allowed for received LSPs. According to RFC, the value range is 1,492 to 16,000, in the unit of bytes.
Command Mode	IS-IS routing process configuration mode
Usage Guide	Use this command to control the maximum length allowed for LSPs received by the local device. Intermediate nodes with sufficient memory are required to receive LSPs whose maximum length is equal to the interface MTU in order to avoid a route convergence failure. From this perspective, the command is meaningless. The maximum length allowed for received LSPs cannot be smaller than that allowed for sent LSPs; otherwise, the former will be automatically adjusted to be equal to the latter.

▾ **Configuring the Maximum Length Allowed for Sent LSPs**

Command	lsp-length originate <i>size</i> [level-1 level-2]
Parameter Description	<i>size</i> : Indicates the maximum length allowed for sent LSPs. The value range is 512 to 16,000, in the unit of bytes. level-1 : Applies the setting only to Level-1 LSPs. level-2 : Applies the setting only to Level-2 LSPs.
Command Mode	IS-IS routing process configuration mode

Usage Guide	In principle, the maximum length of LSPs and SNPs cannot be greater than the interface MTU; otherwise, the packets will be discarded when being sent.
--------------------	---

↘ Configuring a Passive Interface

Command	passive-interface [default] { <i>interface-type interface-number</i> }
Parameter Description	default: Configures all IS-IS interfaces that are not enabled as passive interfaces. <i>interface-type:</i> Indicates the interface type. <i>interface-number:</i> Indicates the interface number.
Command Mode	IS-IS routing process configuration mode
Usage Guide	This command prevents the specified interface from receiving and sending IS-IS packets, but the IP address of the interface will be flooded by other interfaces. If the default option is selected and there are more than 255 IS-IS interfaces not enabled, only the first 255 interfaces will be configured as passive interfaces. The remaining interfaces are non-passive interfaces.

↘ Configuring the Bandwidth Reference

Command	bandwidth-reference <i>value</i>
Parameter Description	<i>value:</i> Indicates the bandwidth value. The value ranges from 1 to 4294967 , in the unit of Mbps. The default value is 100 .
Command Mode	IS-IS routing process configuration mode
Usage Guide	Use this command to calculate the interface metric in an instance according to the bandwidth reference configured in the instance. If a metric is configured, the metric prevails.

i Configuring the TLV Field of the IS-IS Protocol to Be Padded Based on Protocols Supported by an Interface

Command	interfaces-protocol-compatible
Parameter Description	N/A
Command Mode	IS-IS routing process configuration mode
Usage Guide	When devices supporting IS-IS for IPv4 or IS-IS for IPv6 and those supporting both IS-IS for IPv4 and IS-IS for IPv6 on a network are configured to establish a neighbor relationship, the calculated routes may be unreachable, resulting in routing black holes. To prevent routing black holes, the TLV (#129) field of FS IS-IS protocol is padded based on protocols supported by an instance, that is, IS-IS instances that establish a neighbor relationship need to support the same protocol. The TLV (#129) field of the IS-IS protocol supported by devices of some vendors is padded based on protocols supported by an interface. In single topology mode, a FS device connects to a device of another vendor, a loopback interface is configured on both devices, both IS-IS for IPv4 and IS-IS for IPv6 are enabled, and only a single protocol stack (IS-IS for IPv4 or IS-IS for IPv6) is configured on the interface for interconnecting the two devices. The device of the other vendor sends TLV#129 (supporting only a single protocol stack) based on interfaces whereas FS device sends TLV#129 (supporting dual protocol stacks) based on instances. As a result, the displayed neighbor status on the device of the other vendor is "Init" but FS device cannot establish a neighbor relationship with the device of the other vendor. For this, the interfaces-protocol-compatible command can be configured to enable FS devices to establish a neighbor

	relationship with devices of other vendors.
--	---

↘ Configuring an IS Name

Command	is-name name
Parameter	<i>name</i> : Indicates the name for replacing the system ID. The name contains a maximum of 64 characters.
Description	
Command Mode	IS-IS routing process configuration mode
Usage Guide	Use this command to replace the system ID of an instance with the configured name. All system IDs displayed in the command output of show isis database and show isis neighbors are replaced with the configured name.

↘ Configuring the IS-IS Interface Metric

Command	isis metric metric [level-1 level-2]
Parameter	<i>metric</i> : Indicates the metric value. The value range is 1 to 63. The default value is 10.
Description	level-1 : Applies the setting to Level-1 circuits. level-2 : Applies the setting to Level-2 circuits.
Command Mode	Interface configuration mode
Usage Guide	The metric, which is used in SPF calculation, is stored in the IP reachability information TLV. The greater the metric, the greater the routing consumption of the interface and the longer the path obtained by SPF calculation. The metric belongs to the narrow type and is valid only when metric-style is set to Narrow .

↘ Configuring the Wide Metric of an Interface

Command	isis wide-metric metric [level-1 level-2]
Parameter	<i>metric</i> : Indicates the metric value. The value range is 1 to 16,777,214. The default value is 10.
Description	level-1 : Applies the setting to Level-1 circuits. level-2 : Applies the setting to Level-2 circuits.
Command Mode	Interface configuration mode
Usage Guide	The metric, which is used in SPF calculation, is stored in the IP reachability information TLV. The greater the metric, the greater the routing consumption of the interface and the longer the path obtained by SPF calculation. The metric is valid only when metric-style is set to Wide .

↘ Configuring the Interface as an Passive Interface

Command	isis passive
Parameter	
Description	
Command Mode	Interface configuration mode
Usage Guide	The command prevents the interface from receiving or sending IS-IS packets, but the IP address is flooded through other interfaces. The command is valid only for the generated IS-IS interface.

↘ Configuring the Priority of the DIS

Command	isis priority value [level-1 level-2]
----------------	--

Parameter	<i>value</i> : Indicates the priority. The value range is 0 to 127. The default value is 64.
Description	level-1 : Applies the setting to Level-1 circuits. level-2 : Applies the setting to Level-2 circuits.
Command	Interface configuration mode
Mode	
Usage Guide	Use this command to change the priority carried in Hello packets in a LAN. The device with a lower priority is less likely to be elected as the DIS. The command is invalid on a P2P network interface. The no isis priority command, with or without parameters, restores the priority to its default value. To change the configured priority, run the isis priority command with the priority specified to overwrite the existing configuration, or you can first restore the priority to its default value and then configure a new priority.

✚ Suppressing the Routing Calculation after the IS-IS Neighbor Is Up

Command	isis suppress on-neighbor-up <i>seconds</i>
Parameter	<i>seconds</i> : Indicates the delay time, the value range is 1 to 60.
Description	
Command	Interface configuration mode
Mode	
Usage Guide	After the interface neighbor is up, this command prevents the neighbor reachability from being added to LSP so as to delay the routing calculation. When the timer expires, the neighbor reachability is added to LSP to start the routing calculation. This function prevents the routing calculation from using the old LSP, which may lead to routing flapping.

✚ Generating a Default Route

Command	default-information originate [route-map <i>map-name</i>]
Parameter	route-map <i>map-name</i> : Associates with a route map.
Description	
Command	IS-IS routing process configuration mode and IS-IS address-family ipv6 configuration mode
Mode	
Usage Guide	Because Level-2 domains do not generate any default route, use this command to allow a default route to enter a Level-2 domain.

✚ Configuring SPF Calculation Cycle

Command	spf-interval [level-1 level-2] <i>maximum-interval</i> [<i>initial-interval</i> <i>hold-interval</i>]
Parameter	level-1 : Applies the configuration only to Level-1.
Description	level-2 : Applies the configuration only to Level-2. <i>maximum-interval</i> : Indicates the maximum interval for performing two consecutive SPF calculations. The value range is 1 to 120 (in seconds). The default value is 10. <i>initial-interval</i> : Indicates the waiting time for performing the SPF calculation for the first time. The value range is 0 to 60000 (in milliseconds). The default value is 50. <i>hold-interval</i> : Indicates the minimum interval for performing the SPF calculation for the second time. The value range is 10 to 60000 (in milliseconds). The default value is 200.
Command	IS-IS routing process configuration mode
Mode	
Usage Guide	Increasing the maximum interval for performing SPF calculations can avoid frequent SPF calculations and waste of CPU resources. However, a larger minimum interval also leads to slower responses to route changes.

	<p>The waiting time for performing the SPF calculation for the first time is the initial interval. If the network becomes unstable, the SPF calculation interval is less than the maximum interval, and the interval for performing the SPF calculation for the second time becomes the hold interval. A corresponding penalty is added to this interval: The next interval for the SPF calculation doubles the previous interval for the same SPF calculation, until the SPF calculation interval reaches the maximum interval. Subsequent SPF calculations are performed at the maximum interval. When the network becomes stable, the interval for performing the SPF calculation becomes greater than the maximum interval, and the waiting time for performing the SPF calculation is restored to the initial interval.</p> <p>Link changes have high requirements for convergence. The initial interval can be set to a small value. The preceding parameters can also be adjusted to larger values to reduce CPU consumption.</p> <p>The value of initial-interval cannot be greater than that of maximum-interval. Otherwise, the value of initial-interval will be used as the value of maximum-interval.</p> <p>The value of hold-interval cannot be greater than that of maximum-interval. Otherwise, the value of hold-interval will be used as the value of maximum-interval.</p> <p>The value of initial-interval cannot be greater than that of hold-interval. Otherwise, the value of initial-interval will be used as the value of hold-interval.</p>
--	--

↘ **Configuring an IPv4 Summary Route**

Command	summary-address <i>ip-address net-mask</i> [level-1 level-2 level-1-2] [<i>metric number</i>]
Parameter Description	<p><i>ip-address</i>: Indicates the IP address of the summary route.</p> <p><i>net-mask</i>: Indicates the subnet mask of the summary route.</p> <p>level-1: Applies the setting only to Level-1.</p> <p>level-2: Applies the setting only to Level-2. By default, the setting takes effect for Level-2.</p> <p>level-1-2: Applies the setting to Level-1 and Level-2.</p> <p><i>number</i>: Indicates the metric of the summary route.</p>
Command Mode	IS-IS routing process configuration mode
Usage Guide	If the configured summary route contains routing information about a reachable address or network segment, the summary route, instead of detailed routes, is advertised externally.

↘ **Configuring an IPv6 Summary Route**

Command	summary-prefix <i>ipv6-prefix/prefix-length</i> [level-1 level-2 level-1-2]
Parameter Description	<p><i>ipv6-prefix/prefix-length</i>: Indicates the network address of the summary route and its IPv6 prefix length. The address format is X:X:X:X::X/<0-128>.</p> <p>level-1: Applies the setting only to Level-1.</p> <p>level-2: Applies the setting only to Level-2. By default, the setting takes effect for Level-2.</p> <p>level-1-2: Applies the setting to Level-1 and Level-2.</p>
Command Mode	IS-IS address-family ipv6 configuration mode
Usage Guide	If the configured summary route contains routing information about a reachable address or network segment, the summary route, instead of detailed routes, is advertised externally.

↘ **Enabling Neighbor Relationship Event Output**

Command	log-adjacency-changes
Parameter	N/A

Description	
Command	IS-IS routing process configuration mode
Mode	
Usage Guide	You can also use the debug command to record IS neighbor state changes, but the command consumes many system resources.

↘ **Redistributing Other Routes to IS-IS**

Command	redistribute { bgp ospf <i>process-id</i> [match { internal [external [1 2]] [nssa-external [1 2]] external [1 2] [internal] [nssa-external [1 2]] nssa-external [1 2] [internal] [external [1 2]] } rip connected static } [metric <i>metric-value</i>] [metric-type <i>type-value</i>] [route-map <i>map-tag</i>] [level-1 level-1-2 level-2]
Parameter Description	<p><i>process-id</i>: Indicates the OSPF process ID. The range is 1 to 65,535.</p> <p>match { internal external [1 2] nssa-external [1 2] }: When OSPF routes are redistributed, the routes are filtered by subtype. If the match option is not selected, routes of all OSPF types will be received. If match external is not followed by the number 1 or 2, OSPF routes specified by external 1 and external 2 will be redistributed. If match nssa-external is not followed by the number 1 or 2, OSPF routes specified by nssa-external 1 and nssa-external 2 will be redistributed.</p> <p>metric <i>metric-value</i>: Indicates the metric of redistributed routes. The value range is 0 to 4,261,412,864. The metric of external routes is used when the metric option is not specified.</p> <p>metric-type { internal external }: Indicates the metric type of redistributed routes. internal: Indicates that the metric belongs to the internal type. external: Indicates that the metric belongs to the external type. If metric-type is not specified, the metric belongs to the internal type.</p> <p>route-map <i>map-tag</i>: Indicates the route map used for external route redistribution. It is used to filter redistributed routes or configure the attributes of redistributed routes. The value of <i>map-tag</i> cannot exceed 32 characters. By default, route-map is not configured.</p> <p>level-1 level-1-2 level-2: Indicates the Level of redistributed routes received by IS-IS. If no Level is specified, routes are redistributed to Level-2. level-1: Redistributes routes to Level-1. level-1-2: Redistributes routes to Level-1 and Level-2. level-2: Redistributes routes to Level-2.</p>
Command Mode	IS-IS routing process configuration mode and IS-IS address-family ipv6 configuration mode
Usage Guide	<p>The no redistribute { bgp ospf <i>process-id</i> rip connected static } command is used to cancel the redistribution of routes mapped to the specified protocol. If no redistribute is followed by other parameters, the command will restore the default parameter settings, rather than cancel route redistribution. For example, no redistribute bgp cancels BGP route redistribution, whereas no redistribute bgp route-map aa cancels the route map named aa used for BGP route redistribution.</p> <p>When external routes are redistributed in IPv4 mode, the routing information is stored in LSPs' IP External Reachability Information TLV.</p> <p>When external routes are redistributed in IPv6 mode, the routing information is stored in LSPs' IPv6 Reachable TLV.</p> <p>In the old versions of some vendors, if metric-type is set to external, the metric of redistributed routes is added by 64 during route calculation and used to determine routing. This practice does not comply with the related protocol. In the actual application, external routes may be preferred over internal routes. If this happens during interworking with old versions of some vendors, you can modify the related setting (such as metric or metric-type) of each device to ensure that internal routes are preferred over external routes.</p>

↘ **Redistributing the Level-1 Reachable Routing Information of the Specified IS-IS Instance to Level-2 of the Current Instance**

Command	redistribute isis [<i>tag</i>] level-1 into level-2 [route-map <i>route-map-name</i> distribute-list <i>access-list-name</i>]
Parameter Description	<p><i>tag</i>: Indicates the name of the IS-IS instance whose routing information will be redistributed.</p> <p>route-map <i>route-map-name</i>: Indicates the route map used for rout redistribution. It is used to filter redistributed routes or configure the attributes of redistributed routes. The value of <i>route-map-name</i> cannot exceed 32 characters. By default, route-map is not configured.</p> <p>distribute-list <i>access-list-name</i>: Filters redistributed routes by using distribute-list. <i>access-list-name</i> indicates the associated prefix list, which can be a standard prefix list, an extended prefix list, or a name prefix list. It is in the format of {<1-99> <100-199> <1300-1999> <2000-2699> <i>acl-name</i> }. When the IS-IS address-family ipv6 configuration mode is applied, only the name prefix list can be used, in the format of <i>acl-name</i>.</p>
Command Mode	IS-IS routing process configuration mode and IS-IS address-family ipv6 configuration mode
Usage Guide	<p>You can use the route-map or distribute-list parameter to filter the specified instance's Level-1 routes to be redistributed. Only the routes that meet specific criteria can be redistributed to Level-2 of the current instance. The route-map and distribute-list parameters cannot be used at the same time.</p> <p>The no redistribute isis [<i>tag</i>] level-2 into level-1 command is used to cancel the redistribution of the specified instance's routes. If no redistribute is followed by other parameters, the command will restore the default parameter settings, rather than cancel route redistribution.</p> <p>For example, no redistribute isis <i>tag1</i> level-1 into level-2 cancels the redistribution of the routes of the IS-IS instance name tag1. no redistribute isis <i>tag1</i> level-1 into level-2 route-map <i>aa</i> cancels the use of the route map named aa to filter redistributed routes.</p>

↘ **Redistributing the Level-2 Reachable Routing Information of the Specified IS-IS Instance to Level-1 of the Current Instance**

Command	redistribute isis [<i>tag</i>] level-2 into level-1 [route-map <i>route-map-name</i> distribute-list <i>access-list-name</i> (prefix <i>ip-address net-mask</i> ipv6-prefix <i>ipv6-address/length</i>)]
Parameter Description	<p><i>tag</i>: Indicates the name of the IS-IS instance whose routing information will be redistributed.</p> <p>route-map <i>route-map-name</i>: Indicates the route map used for route redistribution. It is used to filter redistributed routes or configure the attributes of redistributed routes. The value of <i>route-map-name</i> cannot exceed 32 characters. By default, route-map is not configured.</p> <p>Distribute-list <i>access-list-name</i>: Filters redistributed routes by using distribute-list. <i>access-list-name</i> indicates the associated prefix list, which can be a standard prefix list, an extended prefix list, or a name prefix list. It is in the format of {<1-99> <100-199> <1300-1999> <2000-2699> <i>acl-name</i> }. When the IS-IS address-family ipv6 configuration mode is applied, only the name prefix list can be used, in the format of <i>acl-name</i>.</p> <p>prefix <i>ip-address net-mask</i>: Determines the routes to be redistributed by address and prefix length.</p> <p>ipv6-prefix <i>ipv6-address/length</i>: Determines the IPv6 routes to be redistributed by address and prefix length.</p>
Command Mode	IS-IS routing process configuration mode and IS-IS address-family ipv6 configuration mode
Usage Guide	<p>You can use the route-map, distribute-list, or prefix parameter to filter the specified instance's Level-2 routes to be redistributed. Only the routes that meet specific criteria can be redistributed to Level-1 of the current instance.</p> <p>The no redistribute isis [tag] level-2 into level-1 command is used to cancel the redistribution of the specified instance's routes. If no redistribute is followed by other parameters, the command will restore the default parameter settings, rather than cancel route redistribution.</p> <p>For example:</p> <p>no redistribute isis <i>tag1</i> level-2 into level-1 cancels the redistribution of the routes of the IS-IS instance name tag1. no</p>

	redistribue isis tag1 level-2 into level-1 route-map aa cancels the use of the route map named aa to filter redistributed routes.
--	---

Configuration Example

↘ **Configuring the Maximum Number of Equal-Cost Paths**

Configuration Steps	<ul style="list-style-type: none"> ● Configure IS-IS neighbors. (Omitted) ● Configure the maximum number of equal-cost paths.
	<pre>A(config)# router isis A(config-router)# maximum-paths 5</pre>
Verification	<ul style="list-style-type: none"> ● Check whether the maximum number of equal-cost paths displayed by routing entries is the same as the configuration.
	<pre>A# show ip route isis</pre>

↘ **Configuring the Maximum Metric for the Connected Routes after the First Neighbor Is Up**

Configuration	<p>Configure IS-IS neighbors. (Omitted)</p> <p>Configure the maximum metric after the first neighbor is up.</p>
	<pre>A(config)# router isis A(config-router)# max-metric on-neighbor-up 10</pre>
Verification	<p>Checks the database details of IS-IS.</p> <pre>A# show isis database detail</pre>

↘ **Configuring the Maximum Length Allowed for Received LSPs**

Configuration	<ul style="list-style-type: none"> ● Configure IS-IS neighbors. (Omitted) ● Configure the maximum length allowed for received LSPs.
	<pre>A(config)# router isis A(config-router)# lsp-length receive 512</pre>
Verification	<p>Capture packets to check the length of received LSPs.</p>

↘ **Configuring the Maximum Length Allowed for Sent LSPs**

Configurations	<ul style="list-style-type: none"> ● Configure IS-IS neighbors. (Omitted) ● Configure the maximum length allowed for sent LSPs.
-----------------------	---

	<pre>A# configure terminal A(config)# router isis 1 A(config-router)# lsp-length originate 512 level-2</pre>
Verification	Capture packets to check the length of sent LSPs.

📌 **Configuring a Passive Interface**

Configuration Steps	<ul style="list-style-type: none"> ● Configure IS-IS neighbors. (Omitted) ● Configure a passive interface.
	<pre>A# configure terminal A(config)# router isis 1 A(config-router)# passive-interface GigabitEthernet 0/0</pre>
Verification	Capture packets to check whether the interface receives and sends IS-IS packets.

📌 **Configuring the Metric of an IS-IS Interface**

Configuration Steps	<ul style="list-style-type: none"> ● Configure IS-IS neighbors. (Omitted) ● Configure metric of the IS-IS interface.
	<pre>A(config)# interface GigabitEthernet 0/1 A(config-if)# isis metric 1</pre>
Verification	Check the database details of IS-IS.
	<pre>A# show isis database detail</pre>

📌 **Configuring the Interface as an Passive Interface**

Configuration Steps	<p>Configure IS-IS neighbors. (Omitted)</p> <p>Configure a passive interface.</p>
	<pre>A(config)# interface GigabitEthernet 0/1 A(config-if)# isis passive</pre>
Verification	Capture packets to check whether the interface receives and sends IS-IS packets.

📌 **Configuring the Priority of the DIS**

Configuration Steps	<ul style="list-style-type: none"> ● Configure IS-IS neighbors. (Omitted) ● Configure the priority of the DIS.
----------------------------	--

	<pre>A(config)# interface GigabitEthernet 0/1 A(config-if)# isis priority 127 level-1</pre>
Verification	Check whether the device with the changed priority setting is elected as the DIS.
	<pre>A# show isis database detail</pre>

↘ Suppressing the Routing Calculation after the IS-IS Neighbor Is Up

Configuration Steps	<p>Configure IS-IS neighbors. (Omitted)</p> <p>Suppress the routing calculation after the is-is neighbor is up.</p>
	<pre>A(config)# interface GigabitEthernet 0/1 A(config-if)# isis suppress on-neighbor-up 10</pre>
Verification	Run the command show ip route

↘ Generating a Default Route

Configuration Steps	<ul style="list-style-type: none"> ● Configure IS-IS neighbors. (Omitted) ● Generate a default route.
	<pre>A(config)# router isis A(config-router)# default-information originate</pre>
Verification	Capture packets to check whether the sent LSP contains a default route.

↘ Configuring SPF Calculation Cycle

Configuration Steps	<ul style="list-style-type: none"> ● Configure IS-IS neighbors. (Omitted) ● Configuring SPF calculation cycle.
	<pre>A(config)# router isis A(config-router)# spf-interval 5 100 200</pre>
Verification	Check whether the SPF calculation cycle works.

↘ Configuring an IS-IS Summary Route

Configuration Requirements	Router A and Router B are connected through the Ethernet and run IS-IS. Configure Router A to advertise only the 172.16.0.0/22 route instead of the 172.16.1.0/24 and 172.16.2.0/24 routes.
-----------------------------------	---

<p>Figure 6-20 IS-IS Route Summary Topology</p>	
<p>Configuration Steps</p>	<ul style="list-style-type: none"> ● Configure IS-IS. ● Configure Ethernet interfaces. ● Configure the password for IS-IS authentication.
<p>A</p>	<p>Configure IS-IS.</p>
	<pre>A(config)# router isis A(config-router)# net 49.0001.0000.0000.0001.00 A(config-router)# summary-address 172.16.0.0/16 level-1-2</pre>
	<p>Configure Ethernet interfaces.</p> <pre>A(config)# interface GigabitEthernet 0/0 A(config-if)# ip address 192.168.20.1 255.255.255.0 A(config-if)# ip router isis A(config)# interface GigabitEthernet 1/0 A(config-if)# ip address 172.16.1.1 255.255.255.0 A(config-if)# ip router isis A(config)# interface GigabitEthernet 1/1 A(config-if)# ip address 172.16.2.1 255.255.255.0 A(config-if)# ip router isis</pre>
<p>B</p>	<p>Configure IS-IS.</p>
	<pre>B(config)# router isis B(config-router)# net 49.0001.0000.0000.0002.00</pre>
	<p>Configure an Ethernet interface.</p>
	<pre>B(config)# interface GigabitEthernet 0/0 B(config-if)# ip address 192.168.20.2 255.255.255.0 B(config-if)# ip router isis</pre>
	<pre></pre>
<p>Verification</p>	<p>Run the show ip route command on Router B to check whether only one summary route exists.</p>
<p>B</p>	<pre>B(config)# show ip route</pre>

i L1 172.16.0.0/16 [115/20] via 192.168.20.1, FastEthernet0/0

▾ **Configuring an IS-ISv6 Summary Route**

Router A and Router B are connected through the Ethernet and run IS-ISv6. Configure Router A to advertise only the 2000::/96 route instead of the 2000::1111:0/112 and 2000::2222::0/112 routes.

Figure 6-21
IS-ISv6 Route
Summary
Topology

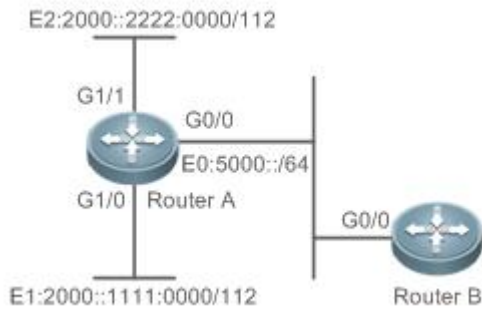

- Configuration Steps**
- Configure IS-IS.
 - Configure Ethernet interfaces.
 - Configure the password for IS-IS authentication.

A Configure IS-IS.

```
A(config)# ipv6 unicast-routing
A(config)# router isis
A(config-router)# net 49.0001.0000.0000.0001.00
A(config-router)# address-family ipv6 unicast
A (config-router-af)# summary-prefix 2000::/96 level-1-2
A (config-router-af)# exit-address-family
```

```
Configure Ethernet interfaces.
A(config)# interface GigabitEthernet 0/0
A(config-if)# ipv6 address 5000::1/64
A(config-if)# ipv6 router isis
A(config)# interface GigabitEthernet 1/0
A(config-if)# ipv6 address 2000::1111:0001/112
A(config-if)# ipv6 router isis
A(config)# interface GigabitEthernet 1/1
A(config-if)# ipv6 address 2000::2222:0001/112
A(config-if)# ipv6 router isis
```

B Configure IS-IS.

```
B(config)# ipv6 unicast-routing
B(config)# router isis
```

	<pre>B(config-router)# net 49.0001.0000.0000.0002.00</pre>
	Configure an Ethernet interface.
	<pre>B(config)# interface GigabitEthernet 0/0 B(config-if)# ipv6 address 5000::2/64 B(config-if)# ipv6 router isis</pre>
Verification	Run the show ipv6 route command on Router B to check whether only one summary route exists.
B	<pre>B(config)# show ipv6 route I1 2000::/96 [115/20] via FE80::C800:1BFF:FEF8:1C, FastEthernet1/0</pre>

➤ **Enabling Neighbor Relationship Event Output**

Configuration Steps	<ul style="list-style-type: none"> ● Configure IS-IS neighbors. (Omitted) ● Enable neighbor relationship event output.
	<pre>A(config-router)# log-adjacency-changes</pre>
Verification	Change the neighbor state and verify that the change is recorded when debugging is disabled.

➤ **Configuring Route Redistribution**

Configuration Steps	<ul style="list-style-type: none"> ● Configure IS-IS neighbors. (Omitted) ● Configure OSPF routes. (Omitted) ● Configure route redistribution
	<pre>A(config)# router isis A(config-router)# redistribute ospf 1 metric 10 level-1</pre>
Verification	Check whether routing entries with redistributed routes exist.
	<pre>A# show ip route isis</pre>

6.5 Monitoring

Clearing

Running the **clear** commands may lose vital information and thus interrupt services.

Description	Command
Clears all IS-IS neighbor relationship tables.	clear clns neighbors

Clears all IS-IS data structures.	clear isis *
Clears all IS-IS counters.	clear isis [tag] counter

Displaying

Description	Command
Displays all IS neighbors and inter-device neighbor relationships.	show clns [tag] is-neighbors [interface-type interface-number] [detail]
Displays all IS neighbors and provides device information and information about the neighbor relationship with ESs.	show clns [tag] neighbors [interface-type interface-number] [detail]
Displays all IS-IS counters.	show isis [tag] counter
Displays the LSDB information.	show isis [tag] database [FLAGS] [LEVEL] [LSPID]
Displays the state information related to IS-IS GR.	show isis [tag] graceful-restart
Displays the relationship between the device name and system ID.	show isis [tag] hostname
Displays the details of an IS-IS interface.	show isis [tag] interface [interface-type interface-number] [counter]
Displays the mesh group configuration of all interfaces.	show isis [tag] mesh-groups
Displays IS-IS neighbor information.	show isis [tag] neighbors [detail]
Displays IS-IS NSR information.	show isis [tag] nsr
Displays the neighbor information of virtual systems in IS-IS.	show isis [tag] virtual-neighbors
Displays IS-IS information.	show isis [tag] protocol
Displays the topology of IS-IS device connection.	show isis [tag] topology [frr { self-originate WORD all }] [l1 l2 level-1 level-2]
Displays information of an IS-IS IPv6 unicast topology.	show isis [tag] ipv6 topology [l1 l2 level-1 level-2]

Debugging



System resources are occupied when debugging information is output. Therefore, disable debugging immediately after use.

Description	Command
Enables IS-IS debugging.	debug isis { all auth events frr gr ifsm lsp mtr n fsm nsm nsr pdu spf warn }

7 Configuring BGP

7.1 Overview

The Border Gateway Protocol (BGP) is an Exterior Gateway Protocol (EGP) used for communication between routers in different autonomous systems (ASs). BGP is used to exchange network accessibility information between different ASs and eliminate routing loops by using its own mechanism.

BGP uses TCP as the transmission protocol. The reliable transmission mechanism of TCP is used to ensure the transmission reliability of BGP.

Routers running BGP are called BGP speakers. BGP speakers between which a BGP session is established are called BGP peers.

Two modes can be used to establish peers between BGP speakers: Internal BGP (IBGP) and External BGP (EBGP).

- IBGP refers to a BGP connection established within an AS and completes transition of routing information within the AS.
- EBGP refers to a BGP connection established between different ASs and completes exchange of routing information between different ASs.

Rules for BGP to select an optimum route:

33. Invalid routing table entries are not involved in optimum route selection.

 Invalid entries include entries of inaccessible next hops and flapping entries.

34. Otherwise, select a route with a large value of **LOCAL_PREF**.

35. Otherwise, select a route generated by a BGP speaker.

 Routes generated by a BGP speaker include routes generated by the **network**, **redistribute** and **aggregate** commands.

36. Otherwise, select a route with the shortest AS length.

37. Otherwise, select a route with a smaller value of **ORIGIN**.

38. Otherwise, select a route with the smallest value of **MED**.

39. Otherwise, EBGP routes have higher priorities than IBGP routes and routes in the AS alliance, and the IBGP routes have the same priorities as the routes in the AS alliance.

40. Otherwise, select a route with the smallest IGP metric value to the next hop.

41. Otherwise, select an EBGP route that is received first.

42. Otherwise, select a route advertised by a BGP speaker with a smaller router ID.

43. Otherwise, select a route with a smaller cluster length.

44. Otherwise, select a route with a smaller neighbor address.

 The preceding shows the route selection process under the default configurations. By using CLI commands, you can change the route selection process. For example, you can run the **bgp bestpath as-path ignore** command to make step 4 of the route selection process lose effect or run the **bgp bestpath compare-routerid** command to make step 9 lose effect.

Protocols and Standards

- RFC4271: A Border Gateway Protocol 4 (BGP-4)
- RFC4273: Definitions of Managed Objects for BGP-4
- RFC4360: Proposed Standard: BGP Extended Communities Attribute
- RFC4364: Proposed Standard: BGP/MPLS IP Virtual Private Networks (VPNs)
- RFC4486: Proposed Standard: Subcodes for BGP Cease Notification Message
- RFC4724: Proposed Standard: Graceful Restart Mechanism for BGP
- RFC4760: Draft Standard: Multiprotocol Extensions for BGP-4
- RFC5492: Draft Standard: Capabilities Advertisement with BGP-4
- RFC7313: Enhanced Route Refresh Capability for BGP-4
- RFC7432: Proposed Standard: BGP MPLS-based Ethernet VPN

7.2 Applications

Application	Description
Inter-AS Route Advertisement	Implement inter-AS route advertisement by using BGP.
Intra-AS Route Reflection	Set up a route reflection topology within an AS to reduce BGP connections.

7.2.1 Inter-AS Route Advertisement

Scenario

BGP implements route advertisement and maintenance across different ASs.

As shown in Figure 7- 1, BGP transfers the route of AS 65536 to AS 65538 through AS 65537.

Figure 7- 1



Remarks	
	R1 is a device at the network edge of AS 65536.
	R2 and R3 are devices at the network edge of AS 65537.
	R4 is a device at the network edge of AS 65538.

Deployment

- Establish the EBGP neighborship between R1 and R2 to implement inter-AS route advertisement.
- Establish the IBGP neighborship between R2 and R3 to implement intra-AS route advertisement.
- The Internet runs OSPF to ensure network accessibility between R2 and R3.
- Establish the EBGP neighborship between R3 and R4 to implement inter-AS route advertisement.

7.2.2 Intra-AS Route Reflection

Scenario

According to the BGP route advertisement principles, routes learned by an IBGP neighbor will not be advertised to the next IBGP neighbor by default. Therefore within an AS, a device running BGP must implement full-mesh. When there are many BGP devices within the AS, implementing full-mesh may cause large difficulties for network deployment. In this case, route reflection can be used to solve this problem.

As shown in Figure 7- 2, route reflection is deployed to implement BGP full-mesh among R1 to R4 and RR.

Figure 7- 2

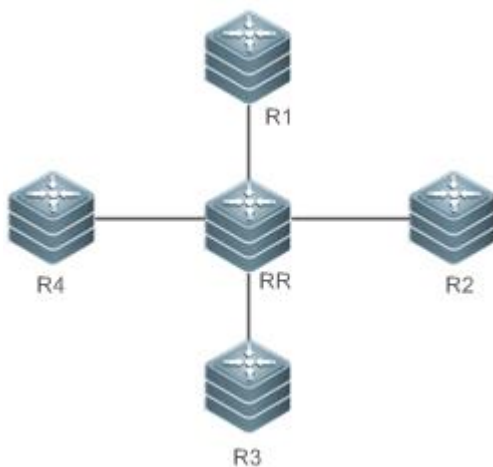

Remarks	RR is a route reflector. R1 to R4 are route reflection clients.
----------------	--

Deployment

- Establish IBGP neighborships between R1 to R4 and RR respectively.
- Configure R1 to R4 as the route reflection clients of RR.

7.3 Features

Basic Concept

📌 **BGP Speaker and AS Number**

A router enabled with BGP is called a BGP speaker.

After a route is enabled with BGP, a local AS number must be specified for the router. An AS number is a globally unique number allocated by IANA, ranging from 1 to 4294967295.

📌 **BGP Neighbor and Peer**

Before a route is advertised between BGP speakers, a neighborhood must be established in advance. You need to manually configure BGP neighbors on both BGP speakers. That is, configure the peer as a neighbor on the two BGP speakers respectively. Therefore, BGP neighbors are also called BGP peers.

📌 **Neighbor Type and Route Type**

BGP neighborships are classified into the following types:

- **IBGP neighborhood:** The neighborhood between BGP speakers within an AS is called IBGP neighborhood. Routes learned from IBGP neighbors are called IBGP routes.
- **EBGP neighborhood:** The neighborhood between BGP speakers in different ASs is called EBGP neighborhood. Routes learned from EBGP neighbors are called EBGP routes.

📌 **BGP route attribute**

When a BGP speaker advertises routes to its neighbors, the BGP speaker also advertises the attributes carried by the routes. Common BGP attributes are as follows:

- **ORIGIN:** Specifies the origin of a BGP route and can be set to **IGP**, **EGP**, or **INCOMPLETE**.
- **AS-PATH:** Lists the ASs passed by a route in a reverse order. The last AS is placed at the beginning of the list.
- **NEXT-HOP:** Specifies the IP address of the next hop to be reached by a BGP route.
- **MULTI-EXIT-DISC:** Distinguishes multiple output/input interfaces for reaching the same neighbor AS. A smaller value means a higher priority.
- **LOCAL-PREF:** Distinguishes the priorities of IBGP routes in an AS. A larger value means a higher priority.

Overview

Feature	Description
Creating a BGP Neighbor	Create a BGP neighbor.
Configuring a BGP Route Reflector	Set up a BGP route reflection topology to simplify network deployment for BGP neighbor full-mesh.
Configuring a BGP Alliance	Configure a BGP alliance to simplify network deployment for BGP neighbor full-mesh.
Re-distributing Local AS Network Information to BGP	Re-distribute routing information to BGP and advertise local routes through BGP.
Controlling Route Exchange Between BGP Peers	Configure the route exchange policy for a BGP peer and control routes to be received by and to be advertised to this peer.
Obtaining Accessible Networks of Other ASs from BGP	Re-distribute routing information in BGP into a core routing table or IGP.
Configuring Synchronization Between BGP and IGP	Configure BGP to check whether BGP routes are synchronized with IGP routes.
Configuring BGP Soft Reset	After a routing policy changes, use soft reset to apply a new policy.
Configuring the Route Attributes of BGP	Configure the route selection algorithms and routing policy control of BGP.
Configuring BGP Route Aggregation	Reduce routes by means of route aggregation.
Configuring BGP Route Dampening	Reduce the impacts of route flapping on a network topology.
Configuring the Management Distance of BGP	Change the priorities of BGP routes.
Configuring Multi-path Load Balancing of BGP	Configure multi-path load balancing for BGP to enhance the network reliability and increase the network bandwidth.
Configuring BGP FRR	Configure fast rerouting for BGP to enhance the network reliability.
Configuring BGP Timers	Modify the internal timer time of BGP.
Configuring BGP Route Update Mechanisms	Disable/Enable regular scanning for BGP routes and configure the route scanning interval.
Configuring the Next-Hop Triggering Update	Configure the next hop triggering update function of BGP.

Feature	Description
Function of BGP	
Configuring BGP LOCAL AS	Configure the LOCAL AS for a BGP neighbor.
Configuring BGP Capacity Protection	Avoid non-predictable running status caused by consumption of device capacity.
Configuring BGP GR	Configure the BGP GR function to enhance the network reliability.
Configuring 4-Byte AS Numbers of BGP	Configure the display mode of a 4-byte AS number.
Configuring a Regular Expression	Use a regular expression to filter routing information.
Configuring BGP Session Retention	Configure BGP to ensure that after an address family with incorrect routing attributes is detected for a neighbor, other address family routes advertised by the neighbor will not be affected.
Configuring BGP Delayed Advertisement upon System Restart	Configure BGP to delay route advertisement to a neighbor within a period after the system is restarted.
Configuring BGP Tracking	Configure BGP tracking function.
Configuring BGP NSR	Enable the NSR function for BGP neighbor.
Configuring BGP Routes to Be Recursive Only to Host Routes	Enable IBGP or EBGp routes to be recursive only to host routes.
Configuring Outbound Loop Detection for a BGP Neighbor	Enable outbound loop detection for a BGP neighbor.
Shutting Down BGP Connection Gracefully	Shut down BGP connection gracefully. Make sure that the service traffic is not interrupted or is interrupted for a very short period of time.
Configuring Enhanced VPN Route Import	Configure the enhanced VPN route import function.
Configuring Enhanced Route-Refresh	Indicate the BGP route update group, which is used to improve the handling performance for route advertisement to neighbors.
Configuring BGP EVPN	Configure the BGP EVPN function.
Other Related Configurations	Configure extended BGP functions.

7.3.1 Creating a BGP Neighbor

A BGP neighbor is manually configured by a user. Two connection modes are supported: IBGP and EBGp. You can identify the connection mode between BGP speakers based on the AS where the BGP peer resides and the AS where the BGP speaker resides.

-  Generally, BGP speakers between which an EBGp connection is established are directly connected whereas BGP speakers between which an IBGP connection is established can be at any location within an AS.

Working Principle

A BGP speaker can initiate a TCP connection request to a BGP peer specified by a user. After the TCP connection is successfully created, the peers will exchange BGP packets to negotiate about connection parameters. The BGP neighborhood is successfully established after the negotiation succeeds.

↘ Creating a TCP Connection

A BGP speaker initiates a TCP connection request to a neighbor. The destination IP address is the peer IP address specified by the user and the port number is fixed to 179.

The BGP speaker also listens on the port number 179 of the local TCP connection to receive connection requests from its peer.

↘ Negotiating about Protocol Parameters

After the TCP connection is successfully created, the BGP speakers exchange OPEN packets to negotiate about BGP connection parameters. The parameters for negotiation include:

- Version: Indicates the BGP version number. At present, only version 4 is supported.
- Neighbor AS number: Determines whether the AS number of the neighbor is consistent with the local AS number. If not, the connection request will be denied.
- Hold Time: Negotiates about the timeout duration for the BGP connection. The default value is 180 seconds.
- Neighbor capability: Negotiates about various extended capabilities supported by the neighbor, including the address family, dynamic route update, and GR functions.

↘ Maintaining Neighborhood

The Keepalive message is periodically sent between BGP speakers. If a new Keepalive packet is not received from the BGP neighbor after the Hold Time expires, the BGP speaker considers that the neighbor is not accessible, disconnects the TCP connection from the neighbor, and attempts to reconnect to it. The interval for a BGP speaker to send the Keepalive message is one third of the Hold Time determined through negotiation and is 60 seconds by default.

Related Configuration

↘ Creating a BGP Neighbor

By default, a BGP speaker does not specify any neighbor. You can manually configure a BGP neighbor.

You can run the **neighbor** { *peer-address* | *peer-group-name* } **remote-as** *as-number* command to manually create a BGP neighbor and specify the AS number of the neighbor.

↘ Setting the Neighbor TTL

By default, The TTL field in a TCP packet sent by an IBGP neighbor is set to the maximum value (255). It is set to 1 by an EBGP neighbor.

You can run the **neighbor** { *peer-address* | *peer-group-name* } **ebgp-multihop** [*tvl*] command to set the TTL field of a TCP packet sent by a BGP neighbor.

A larger value of TTL means a longer distance between BGP neighbors. When TTL is 1, the BGP neighbor devices must be directly connected.

↘ Setting the Source Address of TCP

By default, BGP automatically selects the source IP address of a TCP connection based on the IP address of the neighbor. Generally, the IP address of a local packet output interface is used.

You can run the **neighbor** { *peer-address* | *peer-group-name* } **update-source** { *interface-type interface-number* | *address* } command to adjust the source IP address of the neighbor's TCP connection.

↘ Disabling Private PIC Process

By default, BGP neighbors support private PIC process.

Run `neighbor { neighbor-address | peer-group-name } pic-disable` command to disable the private PIC process to a BGP neighbor.

📌 Setting MD5 Encryption

By default, a BGP connection is not encrypted through MD5.

You can run the `neighbor { peer-address | peer-group-name } password [0 | 7] string` command to set encryption for a BGP neighbor's TCP connection.

📌 Activating the Address Family Capability of a Neighbor

By default, a neighbor created in the BGP configuration mode activates only the IPv4 Unicast address family capability.

You can run the `address-family` command to enter a corresponding address family mode, and then run the `neighbor { neighbor-address | peer-group-name } activate { ipv4 | ipv6 }` command to activate the address family capability for the BGP neighbor.

7.3.2 Configuring a BGP Route Reflector

According to the principle of BGP route advertisement, full mesh must be established for all BGP speakers within an AS (neighborships need to be established between each two BGP speakers). Too many BGP speakers within an AS will increase the resource overhead of the BGP speakers, increase the network administrator's workload and complexity of configuration and decrease the network expansion capability.

Using a route reflector is a method for reducing IBGP peer connections within an AS.

 The methods for reducing the IBGP peer connections within an AS include using a route reflector and using an AS alliance.

Working Principle



Configure a BGP speaker as a route reflector which classifies IBGP peers in an AS into two types: clients and non-clients.

The rules for implementing a route reflector within an AS are as follows:

- Configure a route reflector and specify clients for the route reflector. The route reflector and its clients form a cluster. The route reflector will connect to its clients.
- The clients of a route reflector in a cluster cannot connect to other BGP speakers out of the cluster.
- Within an AS, full mesh is established among IBGP peers of non-clients. The IBGP peers of non-clients include the following situations: Multiple route reflectors in a cluster; a route reflector in a cluster and BGP speakers (generally not supporting the route reflector function) not involved in the route reflector function out of the cluster; a route reflector in a cluster and route reflectors in other clusters.

The rules for processing a route received by a route reflector are as follows:

- A route update message received by an EBGP speaker will be sent to all clients and non-clients.
 - A route update message received by a client will be sent to other clients and all non-clients.
 - A route update message received by an IBGP speaker will be sent to all the other clients.
-  Generally, only one route reflector is configured in a cluster. In this case, the Router ID of the route reflector can be used to identify this cluster. To increase the redundancy, you can set multiple route reflectors in a cluster. In this case, you must configure the cluster ID so that a route reflector can identify the route update messages from other route reflectors in the cluster.

-  If multiple route reflectors are configured for a cluster, you must configure a cluster ID for the cluster.
-  Generally, it is unnecessary to create connections between the clients of a route reflector in a cluster because the route reflector will reflect the routes between the clients. However, if full mesh has been established among all clients, you can cancel the client route reflection function of the route reflector.

Related Configuration

↘ **Configuring a BGP Route Reflector and Reflected Clients**

By default, BGP is not configured with route reflection.

You can run the **neighbor { peer-address } route-reflector-client** command to configure a device as a route reflector and its neighbor devices as reflected clients.

↘ **Configuring BGP Client-Client Reflection**

By default, BGP client-client route reflection is enabled, which means that routes received from a reflected client can be advertised to other clients.

You can run the **bgp client-to-client reflection** command to enable or disable (using the **no** form of this command) client-client reflection.

↘ **Configuring a BGP Reflection Cluster ID**

By default, a BGP reflection cluster ID is the Router-ID of BGP. If multiple reflection clusters are deployed within an AS, different reflection cluster IDs must be configured for these reflection clusters.

You can run the **bgp cluster-id cluster-id** command to manually configure the cluster ID of a route reflector.

7.3.3 Configuring a BGP Alliance

An alliance is another method for reducing the IBGP peer connections within an AS.

Working Principle

Divide an AS into multiple sub ASs and configure a unified alliance ID (namely, the alliance AS NUMBER) for these sub ASs to form an alliance. Outside the alliance, the entire alliance is still considered as an AS and only the AS number of the alliance is visible. Inside the alliance, full mesh of IBGP peers can be established for BGP speakers within a sub AS, and EBGP connections can be established for BGP speakers in different sub ASs. Though EBGP connections are established between BGP speakers within a sub AS, when information is exchanged, NEXT_HOP, MED, LOCAL_PREF and other path attributes keep unchanged.

Related Configuration

↘ **Configuring a BGP Alliance ID**

By default, no alliance ID is configured for a BGP speaker.

You can run the **bgp confederation identifier as-number** command to configure a BGP alliance ID. After the configuration is successful, the local AS (specified by the **router bgp as-number [instance instance-name]** command) of BGP becomes the private AS inside the alliance and is invisible to other ASs.

↘ **Configuring a BGP Alliance Neighbor**

By default, no alliance neighbor is configured for BGP.

You can run the **bgp confederation peers** *as-number* [...] *as-number* command to configure a BGP alliance neighbor. After the configuration succeeds, the AS specified by this command and the local AS belong to the same alliance.

7.3.4 Re-distributing Local AS Network Information to BGP

BGP cannot automatically discover or learn accessible networks. The accessible network information of a local AS must be re-distributed to BGP. Then, BGP can advertise the information to neighbors.

Working Principle

Two methods can be used to re-distribute local AS network information to BGP:

- Manual static configuration: re-distribute the accessible network information within a specified range to BGP.
 - Configuring route re-distribution: re-distribute accessible IGP network information to BGP.
-  In addition, you can also re-distribute local AS network information to BGP routes by configuring route aggregation.

Related Configuration

↘ Configuring a BGP Network

By default, no network is configured for BGP.

You can run the **network** *network-number* [**mask** *mask*] [**route-map** *map-tag*] [**backdoor**] command to configure a BGP network to re-distribute specified accessible network information to BGP. The prerequisite for successfully re-distributing routing information to BGP is that a route is available in the core routing table and this route can be an IGP, directly-connected or static route.

↘ Configuring BGP Route Re-distribution

By default, BGP is not configured with route re-distribution.

Run the **redistribute** *protocol-type* command to import routes of other protocols to BGP, including OSPF, RIP, ISIS, static, and direct routes, host routes converted by ARP, routes converted by ND and aggregation route.

↘ Importing Routes with Multiple Paths or Next Hops to BGP

By default, routes imported to BGP have only one next hop.

Run the **bgp sourced-paths** *protocol-type* **all** command to import routes with multiple next hops of other protocols to BGP.

7.3.5 Controlling Route Exchange Between BGP Peers

BGP provides powerful route management functions. You can actively control the route exchange between BGP peers.

Working Principle

Configure the route exchange policy for a BGP peer and control routes to be received by and to be advertised to this peer.

Related Configuration

↘ Configuring the Default Route to Be Advertised to a Peer

By default, BGP does not advertise the default route.

You can run the **neighbor** { *address* | *peer-group-name* } **default-originate** [**route-map** *map-tag*] command to advertise the default route to a peer (or a peer group).

✚ **Configuring Next-Hop-Self for a Peer**

By default, BGP does not change the next hop of a route when it advertises the route to an IBGP neighbor and sets the next hop to the local BGP speaker when it advertises the route to an EBGp neighbor.

You can run the **neighbor** { *address* | *peer-group-name* } **next-hop-self** command to configure the next hop of a route to the local BGP speaker when distributing the route to a specified BGP peer (group).

✚ **Configuring Remove-Private-AS for a Peer**

By default, BGP does not delete the private AS in the AS-PATH attribute when it advertises routing information to a peer.

You can run the **neighbor** { *address* | *peer-group-name* } **remove-private-as** command to require that the private AS number recorded in the AS path attribute should be deleted when routing information is distributed to an EBGp peer (group). This command does not apply to an IBGP neighbor.

✚ **Configuring Send-Community for a Peer**

By default, BGP does not send the community attribute when it advertises routing information to a peer.

You can run the **neighbor** { *address* | *peer-group-name* } **send-community** command to specify that the community attribute can be sent to a specified BGP peer (group).

✚ **Configuring Maximum-Prefix for a Peer**

By default, BGP does not restrict the records of routing information that can be received by a peer.

You can run the **neighbor** { *neighbor-address* | *peer-group-name* } **maximum-prefix** *maximum* [*threshold*] { [**restart-time** *time*] | [**warning-only** [**suppress**]] } command to specify the records of routing information received from a specified peer (group).

✚ **Configuring Route Filtering for a BGP Neighbor**

By default, a BGP neighbor is not enabled with any filtering policy and receives all legal routing information advertised by a neighbor.

BGP supports multiple methods of configuring the route filtering policies for a neighbor, including:

- **neighbor** { *peer-address* | *peer-group-name* } **distribute-list** { *access-list-number* | *access-list-name* } { **in** | **out** }
Use an ACL to filter routes in the input and output directions of the neighbor.
- **neighbor** { *peer-address* | *peer-group-name* } **filter-list** *access-list-number* { **in** | **out** }
Use an AS-PATH list to filter routes in the input and output directions of the neighbor.
- **neighbor** { *peer-address* | *peer-group-name* } **prefix-list** *prefix-list-name* { **in** | **out** }
Use a prefix-list to filter routes in the input and output directions of the neighbor.
- **neighbor** { *peer-address* | *peer-group-name* } **route-map** *map-tag* { **in** | **out** }
Use a route map to filter routes in the input and output directions of the neighbor.
- **neighbor** { *peer-address* | *peer-group-name* } **unsuppress-map** *map-tag*
Allow for advertising certain routing information previously suppressed by the **aggregate-address** command when distributing routing information to a specified peer.
- **bgp advertise-map** *map-tag*
Use command **bgp advertise-map** *map-tag* to advertise route policy to all neighbors

7.3.6 Obtaining Accessible Networks of Other ASs from BGP

Send routing information of other ASs exchanged by BGP to the routing table of a device so that the device can forward packets to other ASs.

Send routing information of other ASs exchanged by BGP to the routing table of a device so that the device can forward packets to other ASs.

Working Principle

📌 BGP Sends Routing Information to a Core Routing Table

BGP controls routing information sent to the core routing table by using **table-map**. **table-map** can modify the attributes of routing information sent to the core routing table. If the route is matched, BGP modifies the attribute of the routing information and sends the route. If the route is not matched or route matching is denied, BGP does not modify the attribute of the routing information but sends the route.

Changes of **table-map** are not reflected in the core routing table immediately, but reflected a moment later. To update the application of **table-map** immediately, you can run the **clear ip bgp[instance as-number] [vrf vrf-name] table-map** command to update the routing information in the core routing table immediately. This command does not clear the existing routes in the core routing table, but directly applies **table-map** to send the updated routing information, thereby not causing forwarding flapping.

📌 Re-distributing BGP Routes to IGP

Re-distribute BGP routes on a BGP speaker to IGP to ensure that routers within an AS can obtain routes to other ASs.

Related Configuration

📌 Configuring table-map

By default, BGP is not configured with a table-map and allows for sending all routes without modifying the attributes of the routes.

You can run the **table-map route-map-name** command to set a table-map and control the routing information to be sent to the core routing table. *route-map-name* specifies a route-map to be associated.

- 📘 Run the **table-map** command in the BGP configuration mode or in the IPv4 address family mode.
The Match and Set statements supported in the table-map are as follows:
Match statements: as-path, community, ip address, ip next-hop, metric, origin and route-type
Set statements: metric, tag and next-hop

- 📘 You can run the **no table-map** command to delete the table-map configurations.

📌 Configuring BGP Route Re-distribution by IGP

By default, IGP does not re-distribute BGP routes.

You can run the **redistribute bgp [route-map map-tag] [metric metric-value]** command to re-distribute BGP routes to IGP (RIP\OSPF\ISIS).

The **bgp redistribute-internal** command controls only whether to re-distribute routes learned from IBGP to IGP. By default, routes learned from IBGP can be re-distributed to IGP.

- 📘 You can run the **bgp redistribute-internal** command in the BGP configuration mode, IPv4/IPv6 address family mode or the IPv4 VRF address family mode.
- 📘 You can run the **no bgp redistribute-internal** command to delete the configuration.

7.3.7 Configuring Synchronization Between BGP and IGP

Generally, BGP speakers working as mutual IBGP neighbors are not directly connected. IGP devices between the BGP speakers may fail to learn routing information same as that learned by the BGP speakers. When a BGP speaker at the border of an AS forwards packets received from other domains to the next-hop IBGP neighbor, the packets pass an IGP device in the middle. In this case, the packets may be lost due to no routing information on the IGP device.

Working Principle

To keep synchronization between BGP and IGP, you must ensure that all routers within an AS can learn routing information to be sent to another AS before the routing information is advertised to this AS.

Synchronization between BGP and IGP is not required only in the following cases:

- Routing information passing through an AS is not available. For example, the AS is an end AS.
- All routers within an AS run BGP. Full mesh is established among all BGP speakers (neighborship is established between each two BGP speakers).

Related Configuration

▾ Configuring BGP Route Synchronization

By default, synchronization between BGP and IBGP routes is disabled.

You can run the **synchronization** command to enable synchronization between BGP and IGP.



Note

You can run the **no synchronization** command to disable synchronization between BGP and IGP.

7.3.8 Configuring BGP Soft Reset

If routing policies (including **neighbor distribute-list**, **neighbor route-map**, **neighbor prefix-list** and **neighbor filter-list**) change, an effective method must be provided to implement new routing policies. A traditional method is to terminate a BGP connection and then create a new BGP connection. By configuring BGP Soft Reset, you can execute a new routing policy without terminating a BGP session connection.

Working Principle

- i** Routing policies that affect inbound routing information are called inbound routing policies (such as In-route-map and In-dist-list) and routing policies that affect outbound routing information are called outbound routing policies (such as Out-route-map and Out-dist-list).

When outbound routing policies change, BGP soft reset will re-advertise all routing information of a BGP speaker to its neighbors.

If inbound routing policies change, the operation is more complex than that when outbound routing policies change. This is because outbound routing policies are executed in the routing table of the local BGP speaker whereas inbound routing policies are executed for routing information received from the BGP peer. To reduce cost, the local BGP speaker does not store the original routing information received from the BGP peer.

If inbound routing policies change and a neighbor device supports route update, you can configure soft reset to send a route update request to the neighbor device. After receiving the request, the neighbor device re-advertises all routing information. You can also

perform configuration to ensure that each BGP peer stores original routing information on the local BGP speaker and provides original routing information basis for modifying inbound routing policies subsequently.

- i** The "route update capability" allows for modifying and executing routing policies without storing original routing information. This product supports the route update capability. You can run the **show ip bgp [instance as-number] neighbors** command to check whether a BGP peer supports route update. If yes, you do not need to run the **neighbor soft-reconfiguration inbound** command when inbound routing policies change.

Related Configuration

↘ Configuring BGP Soft Reset

Run the **clear ip bgp [instance as-number] { * | neighbor-address | peer-group peer-group-name | external } soft out** command to soft reset a BGP connection. You can activate execution of a routing policy without restarting the BGP session.

↘ Saving Original Routing Information of Neighbors

By default, BGP does not save original routing information of neighbors.

Run the **neighbor { peer-address | peer-group-name } soft-reconfiguration inbound** command to save unmodified routing information sent by a BGP peer (group).

7.3.9 Configuring the Route Attributes of BGP

BGP provides various control policies for route attributes. You can apply the policies based on actual conditions.

Working Principle

↘ AS_PATH Attribute

BGP can control distribution of routing information in three modes:

- IP address. You can run the **neighbor distribute-list** and **neighbor prefix-list** commands for implementation.
- AS_PATH attribute. See the description in this section.
- COMMUNITY attribute. See the related configuration of the COMMUNITY attribute.

You can use an AS path-based access control list (ACL) to control the distribution of routing information. Where, the AS path-based ACL uses a regular expression to parse the AS path.

Based on the standard (RFC1771), BGP does not consider the AS path length when selecting the optimum path. Generally, a shorter AS path length means a higher path priority; therefore, FS considers the AS path length when selecting the optimum path. You can determine whether to consider the AS path length when selecting the optimum path based on the actual conditions.

- i** Within an AS, whether to consider the AS path should be consistent for all BGP speakers when the optimum path is selected; otherwise, the optimum paths selected by the BGP speakers may be different.

↘ MULTI_EXIT_DISC Attribute

BGP uses the MED value as the basis for comparing priorities of paths learned from EBGp peers. A smaller MED value means a higher path priority.

- By default, the MED value is compared only for paths of peers from the same AS when the optimum path is selected.
- By default, the MED value is not compared for paths of peers from other sub ASs within an AS alliance.

- By default, if a path not configured with the MED attribute is received, it is considered that the MED value of this path is 0. Since a smaller MED value means a higher path priority, this path has the highest priority.
- By default, the MED value is not compared with paths from different ASs; instead, the sequence of receiving the paths is compared.

▾ LOCAL_PREF Attribute

When sending routes received from EBGp peers to IBGP peers, a BGP speaker adds the LOCAL_PREF attribute. BGP uses the LOCAL_PREF attribute as the basis for comparing priorities of paths learned from IBGP peers. A larger value of LOCAL_PREF means a higher path priority.

You can also run the **set local-preference** command of a route map to modify the LOCAL_PREF attribute of the specified path.

▾ COMMUNITY Attribute

The COMMUNITY attribute is another mode for controlling distribution of routing information.

A community is a set of destination addresses. The COMMUNITY attribute is intended to facilitate execution of a routing policy based on a community and thereby simplify the configuration of routing information distribution control on BGP speakers. Each destination address may belong to multiple communities. An AS administrator can define the communities to which a destination address belongs.

By default, all destination addresses belong to the Internet community and are carried in the community attribute of the path.

At present, four common community attribute values are pre-defined:

- Internet: Indicates the Internet community. All paths belong to this community.
- no-export: Indicates that the path is not advertised to EBGp peers.
- no-advertise: Indicates that the path is not advertised to any BGP peer.
- local-as: Indicates that a path is not advertised to other ASs. When an AS alliance is configured, the path is not advertised to other ASs or sub ASs.

By using the community attribute, you can control the receiving, prioritization and distribution of routing information. BGP speakers can set, add or modify the community attribute when learning, advertising or re-distributing routes. An aggregation path will contain the community attribute values of all aggregated paths.

- **i** BGP supports up to 32 COMMUNITY attributes for each route and allows for up to 32 COMMUNITY attributes when match and set COMMUNITY of a route map are configured.

▾ Others

During selection of the optimum path, if two paths with the same path attributes are received from different EBGp peers, the optimum path is selected based on the receiving sequence by default. You can disable comparison of the receiving sequence but use the path with a smaller router ID as the optimum path.

Related Configuration

▾ Configuring AS_PATH Attribute

- **ip as-path access-list** *path-list-name* { **permit** | **deny** } *as-regular-expression*
Defines an AS path list.
- **neighbor** { *peer-address* | *peer-group-name* } **filter-list** *path-list-name* { **in** | **out** }

By default, no filtering policy is configured for BGP peers.

The configuration is the same as that for routing information receiving and sending for a specified BGP peer (group). Routing policies are executed based on the AS path list to advertise or receive only routes that match the policies.

- **neighbor** { *peer-address* | *peer-group-name* } **route-map** *map-tag* { **in** | **out** }

By default, no filtering policy is configured for BGP peers.

The configuration is the same as when receiving and sending routing information for a specified BGP peer (group). Routing policies are executed based on a route map or the set rules in the route map are used to modify routing attributes.

- **i** In the route-map configuration mode, you can run the **match as-path** command to modify AS path attributes by using an AS path list or directly run the **set as-path** command to modify AS attribute values.

- **bgp bestpath as-path ignore**

Allows BGP not to consider the AS path length when selecting the optimum path. The AS path length is compared by default.

By default, a smaller AS path length means a higher path priority.

↘ **Configuring MULTI_EXIT_DISC Attribute**

- **bgp always-compare-med**

Allows for comparing the MED values of paths from different ASs, which is disabled by default.

- **bgp bestpath med confed**

Allows for comparing the MED values of paths of peers from other sub ASs in the same AS alliance, which is disabled by default.

- **bgp bestpath med missing-as-worst**

Sets a path not configured with the MED attribute to the lowest priority, which is disabled by default.

- **bgp deterministic-med**

Allows for comparing the paths of peers within the same AS, which is disabled by default.

↘ **Configuring LOCAL_PREF Attribute**

- **bgp default local-preference** *value*

Changes the default local preference value, ranging from 0 to 4,294,967,295. A larger value means a higher priority. The default value is 100.

↘ **Configuring COMMUNITY Attribute**

- **ip community-list standard** *community-list-name* { **permit** | **deny** } *community-number*

Creates a community list. **community-list-name** indicates the name of the community list.

- **i** *community-number*: Indicates a value (0 to 4,294,967,295) specified by a user or a known community attribute (internet, local-AS, no-advertise or no-export).

- **neighbor** { *peer-address* | *peer-group-name* } **send-community**

Allows for sending the community attribute to a specified BGP peer (group), which is not configured by default.

- **neighbor** { *peer-address* | *peer-group-name* } **route-map** *map-tag* { **in** | **out** }

The configuration is the same as that for routing information receiving and sending for a specified BGP peer (group). Routing policies are executed based on a route map. No filtering policy is configured for peers by default.

- i** In the route-map configuration mode, you can run the **match community-list [exact]** and **set community-list delete** commands to modify the community attribute by using a community list or directly run the **set community** command to modify the community value.

↳ Others

- **bgp bestpath compare-routerid**

Allows BGP to compare the router ID when selecting the optimum path, which is disabled by default.

7.3.10 Configuring BGP Route Aggregation

BGP-4 supports CIDR and therefore allows for creating aggregation entries to reduce the size of a BGP routing table. BGP aggregation entries can be added to a BGP routing table only when valid paths are available within the aggregation range.

Working Principle

Aggregate one or more detailed BGP routes into a BGP route with a shorter network mask.

- i** By default, BGP advertises all path information before and after aggregation. If you hope that only aggregated path information is advertised, you can run the **aggregate-address summary-only** command.
- i** When the **aggregate-address** command is used to configure an aggregated route, the aggregated route takes effect immediately as long as there are routes in the configured address range.

Related Configuration

↳ Configuring BGP Route Aggregation

Run the **aggregate-address address mask** command to configure BGP route aggregation.

Run the **aggregate-address address mask as-set** command to configure aggregation address and reserves AS paths in the aggregation address. By default, BGP does not reserve AS paths.

Run the **aggregate-address address mask summary-only** command to configure and only advertise aggregation address. By default, all paths in the aggregation address will be advertised.

Run the **aggregate-address address mask as-set summary-only** command to configure aggregation address and reserves AS paths in the aggregation address. Only aggregation address will be advertised.

7.3.11 Configuring BGP Route Dampening

If a route changes between being valid and invalid, route flapping occurs.

Route flapping often causes transmission of unstable routes in a network, and thereby causes network instability. BGP route dampening is a method for reducing route flapping. It reduces possible route flapping by monitoring routing information from EBGp peers.

Working Principle

Terms used in BGP route dampening are as follows:

- **Route Flap:** A route changes between being valid and invalid.
- **Penalty:** Once route flapping occurs, a BGP speaker enabled with route dampening adds a value to the penalty for this route. The penalty is accumulated until the Suppress Limit is reached.

- **Suppress Limit:** When the penalty of a route is greater than this value, the route will be suppressed.
- **Half-life-time:** The time used for the penalty to be halved.
- **Reuse Limit:** When the penalty value of a route is smaller than this value, route suppression will be canceled.
- **Max-suppress-time:** The longest time that a route can be suppressed.

A brief description of route dampening processing: BGP speaker punishes a route once (adds to the penalty) route flapping occurs. When the penalty reaches the Suppress Limit, the route will be suppressed. When the Half-life-time reaches, the penalty is halved. When the penalty is reduced to the Reuse Limit, the route is activated again. The Max-suppress-time indicates the longest time that the route can be suppressed.

Related Configuration

📌 Configuring BGP Route Dampening

By default, BGP route dampening is not enabled.

Run the **bgp dampening half-life-time reuse suppress max-suppress-time** command to configure parameters of BGP route dampening.

half-life-time (1~45minutes): The default value is 15 minutes. A larger value means a longer flapping suppression and dampening period.

reuse (1~20000): The default value is 750. A smaller value means longer time for continuous stabilization before a flapping route is enabled again.

suppress (1~20000): The default value is 2,000. A smaller value means more flapping times allowed before suppression.

max-suppress-time (1~255minutes): The default value is 4*half-life-time. A larger value means longer maximum suppression time.

📌 Displaying BGP Route Dampening

- **show ip bgp [instance as-number] dampening flap-statistics**

Displays the flapping statistics about all routes.

- **show ip bgp [instance as-number] dampening dampened-paths**

Displays the statistics about suppressed routes.

📌 Resetting BGP Route Dampening

- **clear ip bgp [instance as-number] flap-statistics**

Clears the flapping statistics about all routes that are not suppressed.

- **clear ip bgp [instance as-number] flap-statistics address mask**

Clears the flapping statistics about specified routes (excluding suppressed routes).

- **clear ip bgp [instance as-number] dampening [address [mask]]**

Clears the flapping statistics about all routes, including routes whose suppression is cancelled.

7.3.12 Configuring the Management Distance of BGP

The management distance is used to evaluate the reliability of various route sources. A smaller management distance means a better route.

Working Principle

Management Distance of BGP

The management distance indicates the reliability of a route source, ranging from 1 to 255. A larger value means lower reliability. BGP sets different management distances for routing information learned from different sources, including External-distance, Internal-distance and Local-distance.

- External-distance: Indicates the management distance of routes learned from EBGP peers.
- Internal-distance: Indicates the management distance of routes learned from IBGP peers.
- Local-distance: Indicates the management distance for routes learned from peers but it is considered that better routes can be learned from IGP. Generally, these routes can be indicated by the **Network Backdoor** command.

 You are not advised to change the management distance of BGP. If you really need to change the management distance of BGP, please remember:

The external-distance should be shorter than the management distances of other IGP routing protocols (OSPF and RIP).

The internal-distance and local-distance should be longer than the management distances of other IGP routing protocols.

Backdoor Route

If you prefer an IGP route but do not use an EBGP route, you can set the EBGP route as the backdoor route. By default, the management distance for routes learned from a BGP speaker for which an EBGP connection is established is 20. You can run the **network backdoor** command to set the management distance of the network information to 200 so that the same network information learned from IGP has the highest priority. The networks learned from IGP are considered backdoor networks and are not advertised.

Related Configuration

Configuring the Management Distance of BGP

You can run the **distance bgp** *external-distance internal-distance local-distance* command to configure the management distance of BGP. The value ranges from 1 to 255.

The default value of *external-distance* is 20; the default value of *internal-distance* is 200; the default value of *local-distance* is 200.

A longer management distance means a lower route priority.



Configuring a Backdoor Route

Run the **network** *network-number mask network-mask backdoor* command to configure a backdoor route. By default, no backdoor route is configured.

7.3.13 Configuring Multi-path Load Balancing of BGP

Multi-path load balancing means that there are multiple paths to the same network and data packets are evenly forwarded by these paths. In a routing table, one route has multiple next hops.

According to the types of equivalent routes, multi-path load balancing of BGP is classified into the following types:

- EBGP load balancing: implement load balancing for routes learned from EBGP neighbors.
- IBGP load balancing: implement load balancing for routes learned from IBGP neighbors.
-  Both the IPv4 and IPv6 protocol stacks support multi-path load balancing.
-  Load balancing cannot be implemented between IBGP and EBGP routes (including EBGP routes in an alliance).

Working Principle

If a BGP routing table has multiple paths to the same network, BGP calculates the route with the highest priority by default. If there are optimum multiple routes with the same priorities, BGP still selects a unique route by using comparison rules, notifies the route to the forwarding plane and controls the forwarding of data streams. After multi-path load balancing is enabled, BGP calculates a unique optimum route and also lists paths with the same priorities as equivalent routes. Then, BGP notifies the optimum route and the equivalent routes to the forwarding plane to implement load balancing.

Equivalent routes have the same basic attributes and priorities. That is, according to the optimum path selection rules of BGP, the paths have the same priorities before router-IDs are compared.

AS_PATH Loose Comparison

By default, equivalent routes must have the same AS-PATH attributes. Under such strict conditions, load balancing cannot be implemented in certain environments. In this case, you are advertised to enable the AS-PATH loose comparison mode. In the AS-PATH loose comparison mode, when other conditions for equivalent routes are met, as long as the AS-PATH lengths of routes and the AS-PATH lengths of routes from an alliance are the same respectively, it is considered that the conditions for equivalent routes are met.

 When the next hops of multiple BGP equivalent paths recur to the same IGP output interface, load balancing cannot be implemented.

Related Configuration

Configuring Multi-path Load Balancing of BGP

- **maximum-paths { ebgp | ibgp } number**

Enables the multi-path load balancing function of BGP.

number indicates the number of equivalent next hops, ranging from 1 to device capacity. The default value is 1. A larger value means more equivalent next hops allowed.

Configuring AS_PATH Loose Comparison

- **bgp bestpath as-path multipath-relax**

Enables the BGP AS-PATH loose comparison mode.





7.3.14 Configuring BGP FRR

With high-speed development of IP technologies and application of various complex services, the requirements for network security and stability become increasingly higher. Especially, certain real-time services (audios and videos) are sensitive to network running status and may be largely affected by unstable networks. Therefore, more and more focus and importance are attached to network reliability. With these requirements, the IP FRR function comes into being. It is intended to use a backup link to maintain data forwarding during route platform convergence after a faulty link is detected, in order to achieve the ideal targets of "zero delay" and "zero loss" in packet forwarding.

BGP FRR is shorted for Fast Reroute.

Working Principle

If a BGP routing table has multiple paths to the same network, BGP calculates the route with the highest priority by default. After the BGP FRR function is used, BGP selects a backup route for each optimum route. After BFD FRR detects that the master link is faulty, it switches the data to the originally calculated backup link for forwarding. After route convergence is completed, data is switched to the optimum route re-calculated for forwarding. In this way, BGP FRR can avoid route disconnection due to a link fault before BGP route convergence is completed.

-  Only supported in IPv4 Unicast/VRF configuration mode.
-  Only one backup route can be generated and the next hop of the backup route cannot be the same as that of the preferred route.
-  A backup next hop cannot be generated for an Equal-Cost Multi-Path Routing (ECMP) route.
-  In IPv4 VRF configuration mode, BGP FRR has a lower priority than VPN FRR. That is, if VPN FRR is enabled in the VRF mode, BGP FRR takes effect only when VPN FRR fails to calculate a backup route.

Related Configuration

↘ **Configuring BGP FRR**

Run the **bgp fast-reroute** command to enable the BGP FRR function, which is disabled by default.

↘ **Configuring a BFD Session to a BGP Neighbor**

Run the **neighbor { peer-address } fall-over bfd** command to configure a BFD session to a BGP neighbor, which is not configured by default.

↘ **Manually Configuring a BGP BFD Session**



If the BFD session to a BGP neighbor cannot be used to fast detect the failure of the master link, you can run the **bfd bind bgp peer-ip ip-address interface interface-type interface-index source-ip ip-address** command to configure a BGP BFD session, which is not configured by default.

7.3.15 Configuring Fast Withdrawal of Specified BGP Routes

With the rapid development of IP technologies and the application of various complex services, increasingly higher requirements are imposed on the network. Customers may need to implement fast convergence on specific routes. Fast route withdrawal can meet customers' requirements for preferentially withdrawal of specific routes.

Working Principle

By default, routes are withdrawn based on preferential calculation according to the sequence in the routing table. Fast route withdrawal adds the routes meeting conditions to a high-priority queue to implement preferential processing of specified routes, so that the specified routes can be withdrawn quickly.

-  The L2VPN address family supports the route map mode only.
-  Only one of the access list and prefix list takes effect.

Related Configuration

↘ **Activating the Address Family Capability**

By default, only the IPv4 unicast address family capability is activated for the neighbors created in BGP configuration mode.

Run the **address-family** command to enter the corresponding address family mode.

✚ **Configuring Fast Withdrawal of Specified BGP Routes**



Run the **bgp fast-withdraw** { **access-list** { *access-list-number* | *access-list-name* } | **prefix-list** *prefix-list-name* | **route-map** *map-tag* } command to enable fast withdrawal of specified BGP routes in the address family. This function is disabled by default.

7.3.16 Configuring BGP Multi-path Bypass Protection

The original BGP FRR supports only 1:1 protection. After the ECMP function is enabled, the FRR becomes unavailable. The multi-path bypass protection enables BGP to support 1:N protection. Users can configure BGP multi-path bypass protection to enable the system to select a backup bypass path even if ECMP is configured. When all ECMP routes fail, the bypass route becomes the primary route for forwarding.

Working Principle

By default, when there are multiple paths reachable to the same network in the BGP routing table, BGP calculates one route with the highest priority. After the BGP multi-path bypass protection function is enabled, BGP preferentially selects a backup route when ECMP routes exist. When BFD detects a fault occurring on the master path, the system switches to the selected backup path for data forwarding. After route convergence is completed, the system switches to the optimum path that is re-calculated based on routes to forward data.

-  Only supported in IPv4 Unicast/VRF configuration mode.
-  Only one bypass route is generated and the next hop of the bypass route cannot be the same as next hops of ECMP routes.
-  The BGP FRR function conflicts with the BGP multi-path bypass protection function. If either of them is configured when the other function is already available, a conflict prompt will be displayed.

Related Configuration

✚ **Configuring BGP Multi-path Bypass Protection**

Run the **bgp install standby-path** command to enable BGP multi-path bypass protection, which is disabled by default.

✚ **Configuring a BFD Session to a BGP Neighbor**

Run the **neighbor** *peer-address* } **fall-over bfd** command to configure a BFD session to a BGP neighbor, which is not configured by default.

7.3.17 Allowing the BGP Route Reflector to Modify Route Attributes

According to RFC4456, the BGP route reflector cannot modify route attributes when reflecting routes (the purpose is to prevent route loops). However, relevant route attributes need to be modified when network traffic paths need to be re-planned. This command is configured to allow the route reflector to modify route attributes (including **Route-map** or **nexthop-self**).

Working Principle

The route reflector is not allowed to modify route attributes by default. After this command is configured, the route reflector is allowed to modify route attributes.

Related Configuration

✚ **Configuring a BGP Route Reflector and Reflection Client**

No BGP route reflector is configured by default.

Run the **neighbor peer-address route-reflector-client** command to configure the local device as the route reflector and the neighbor as the route reflection client.

↘ **Configuring BGP Client-Client Reflection**

By default, client-client route reflection is automatically enabled on the BGP route reflector, and routes received from the reflection client are allowed to be advertised to other clients.

Run the **bgp client-to-client reflection** command to enable client-client reflection. Run the **no** form of this command to disable client-client reflection.

↘ **Configuring a BGP Reflection Cluster Identifier**

By default, the BGP reflection cluster identifier directly uses the BGP Route-ID. When multiple reflection clusters are deployed in one AS domain, different reflection cluster identifiers need to be configured for them.

Run the **bgp cluster-id cluster-id** command to manually configure a cluster identifier for the route reflector.

↘ **Allowing the BGP Route Reflector to Modify Route Attributes**

By default, BGP does not allow the route reflector to modify route attributes.

Run the **bgp route-reflector attribute-change** command to allow the route reflector to modify route attributes.

7.3.18 Configuring the BGP Device to Advertise Routes with the Lowest Priority upon Restart

By default, after the device is restarted and a neighborhood is established, a BGP peer can advertise routes to its neighbors. However, in some cases, for example, there are a large number of neighbors or routes when the device is started but is slow in writing entries to hardware. The neighbors have learnt routes and start forwarding traffic, but the local device has not completed entry writing to the hardware, resulting in a traffic forwarding failure. Therefore, BGP needs to advertise routes with the lowest priority after device restart. In this way, other available routes instead of routes that pass through the local device are preferentially selected.

Working Principle

Configure the BGP device to advertise routes with the lowest priority upon restart. In this way, after the BGP device is restarted and neighborhoods are established, the BGP device advertises routes with the lowest priority to its neighbors. Adjust the **MED** value of routes to **4,294,967,295** for EBGP neighbors and adjust the value of **local-pref** to **0** for IBGP neighbors. After all ARP entries are delivered and all forwarding entries are written into hardware, run the **clear bgp [instance as-number] advertise lowest-priority on-startup** command to restore the priority of advertised routes. If a user does not configure to restore the priority of advertised routes, the device automatically restores the priority of advertised routes after a period of time.

Related Configuration

↘ **Configuring the BGP Device to Advertise Routes with the Lowest Priority upon Restart**

● **bgp advertise lowest-priority on-startup [recover-time]**

Configure BGP to adjust the priority of advertised routes to the lowest upon device restart. The priority is not adjusted by default. **recover-time** indicates the time (in seconds) of the timer for restoring the priority of advertised routes. The value range is from **1** to **65,535** and the default value is **600**.

7.3.19 Configuring BGP Timers

You can manually configure various timers within BGP to meet the neighbor keepalive and route management requirements in different network environments.

Working Principle

↘ BGP Neighbor Keepalive Timer

BGP uses the Keepalive timer to maintain a valid connection with a peer and uses the Holdtime timer to identify whether a peer is valid. By default, the value of the Keepalive timer is 60 seconds and the value of the Holdtime timer is 180 seconds. When a BGP connection is established between two BGP speakers, the two BGP speakers negotiate about the Holdtime timer value and select a smaller value. 1/3 of the negotiated Holdtime timer value and the configured Keepalive timer value are compared and the smaller value is used as the Keepalive timer value.

↘ Neighbor Reconnection Timer

To reduce the impacts of frequent BGP reconnection to a neighbor on the network bandwidth, after a BGP speaker detects failure of a neighbor connection, the BGP speaker attempts to reconnect the neighbor after the connect-retry timer expires. By default, the value of the connect-retry timer is 15s.

↘ Route Advertisement Timer

To reduce the impacts of route update packets on the network bandwidth, after a BGP speaker detects a network topology change, the BGP speaker does not advertise the route update to its neighbors immediately. Instead, the BGP speaker uses a regular update mechanism to advertise all changed routing information to its neighbors.

Related Configuration

↘ Configuring the BGP Neighbor Keepalive Timer

- **timers bgp** *keepalive holdtime*

Adjusts the BGP *keepalive* and *holdtime* values for all peers.

The *keepalive* value ranges from 0 to 65,535. The default value is 60 seconds.

The *holdtime* value ranges from 0 to 65,535. The default value is 180 seconds.

- **neighbor** { *neighbor-address* | *peer-group-name* } **timers** *keepalive holdtime*

Configures the *keepalive* and *holdtime* values used for connecting to a specified BGP peer (group).

The *keepalive* value ranges from 0 to 65,535. The default value is 60 seconds.

The *holdtime* value ranges from 0 to 65,535. The default value is 180 seconds.

↘ Configuring the Neighbor Re-connection Timer

- **neighbor** { *address* | *peer-group-name* } **timers connect** *connect-retry*

Configures the *connect-retry* value used for reconnecting to a specified BGP peer (group).

The value of *connect-retry* ranges from 1 to 65,535. The default value is 15 seconds.

↘ Configuring the Route Advertisement Timer

- **neighbor** { *address* | *peer-group-name* } **advertisemet-interval** *seconds*

Configures the minimum interval for sending route updates to a specified BGP peer (group). The value of `advertisement-interval` ranges from 0 to 600 seconds. The default value for IBGP peers is 0 seconds and the default value for EBGP peers is 30 seconds.

- **neighbor** { *address* | *peer-group-name* } **as-origination-interval** *seconds*

Configures the minimum interval for sending local initial route updates to a specified BGP peer (group). The value of `As-origination-interval` ranges from 1 to 65,535. The default value is 1 second.

7.3.20 Configuring BGP Route Update Mechanisms

Working Principle

BGP provides two route update mechanisms: regular-scanning update and event-triggering update. Regular-scanning update indicates that BGP uses an internal timer to start scanning regularly and update the routing table. Event-triggering update indicates that BGP starts scanning and updates the routing table when the BGP configuration commands are changed due to user configuration or the next hop of a BGP route changes.

- i** This function is configured based on address families and can be configured in the IPv4, IPv6, VPNv4, VPNv6, IPv4 vrf and IPv6 VRF address family modes.
- i** If you set the BGP route update mechanism to event-triggering update (by running the **bgp scan-rib disable** command), you must disable synchronization (by running the **no synchronization** command) and enable the BGP next-hop triggering update function (by running the **bgp nexthop trigger enable** command). On the other hand, if you enable synchronization or disable the BGP next-hop triggering update function, the BGP routing table must be updated in the regular scanning mode.

Related Configuration

↳ Configuring Route Update Mechanisms

- **bgp scan-rib disable**

Sets the BGP route update mechanism to event-triggering update. Regular-scanning update is used by default.

- **bgp scan-time** *scan-time*

Configures the regular update interval of BGP. The value of *scan-time* ranges from 5 to 60 seconds. The default value is 60 seconds.

7.3.21 Configuring the Next-Hop Triggering Update Function of BGP

The next-hop triggering update function of BGP is a method for reducing the BGP convergence time. This function is used to optimize the method for monitoring the next hop of a route to ensure that BGP can increase the BGP route convergence speed when the network topology is stable.

Working Principle

When BGP connects to a neighbor, BGP automatically monitors the next hop of the BGP route learned from the neighbor. When the next hop changes in the core routing table, BGP receives an advertisement about the next hop change and updates the BGP routing table. This optimization measure improves the BGP route convergence performance by reducing the time for detecting next-hop changes.

If this function is disabled, BGP next hop update will be discovered through regular scanning specified by scan-timer.

- i** This function is configured based on address families and can be configured in the IPv4, IPv6, VPNv4 and IPv4 vrf address family modes.

i **bgp nexthop trigger delay** and **bgp scan-time** control the same timer. When bgp scan is enabled (it is enabled by default and can be disabled by the **bgp scan-rib disable** command), if the value of **bgp nexthop trigger delay** is larger than 60s, bgp scan does not take effect because the scan timer is always triggered before the delay.

! If the network environment is unstable (with frequent next-hop changes), especially with many routes, this function performs unnecessary route calculations, which consumes more CPU resources. Therefore, you are advised to disable this function in this environment.

Related Configuration

↳ Configuring the Next-Hop Triggering Update Function of BGP

- **bgp nexthop trigger enable**

Enables the BGP next-hop triggering function, which is enabled by default.

- **bgp nexthop trigger delay delay-time**

Configures the delay of BGP next-hop triggering update. The value of *delay-time* ranges from 0 to 100 seconds. The default value is 5 seconds.

7.3.22 Configuring BGP LOCAL AS

The Local AS function of BGP is used to configure a local AS different from a router BGP AS for a specific peer. This is similar to deploying a new virtual AS between the peer devices. When the local router BGP AS changes, you can establish a BGP connection without changing the BGP configurations on the peer device. This function is mainly used for AS migration and merging of large networks and ensures that the device configurations in other interconnected ASs are not affected.

Working Principle

In BGP, when a local device connects to a peer, the local device advertises the local AS number to the peer by using an Open message. The peer checks whether the BGP AS number advertised is the same as the local AS number. If the AS numbers are different, the peer will deny the BGP connection. By default, the local AS in the BGP connection is a route BGP AS. However, if a local AS is configured for the peer, the configured local AS will replace the route BGP AS when a BGP connection is established between the local device and the peer.

i The **neighbor peer-address local-as as-num** command for configuring the BGP Local AS function can be followed by more options. For details, see the Command Reference.

i The BGP Local AS function is applied only to EBGP peers, but is not applied to IBGP peers and alliance EBGP peers. In addition, the BGP Local AS function has the following restrictions:

- 1) The configured local AS cannot be the same as the remote AS of a peer.
- 2) The local AS cannot be configured independently for a member of a peer group.
- 3) The configured local AS cannot be the same as the route BGP AS.
- 4) If a device is a member of an AS alliance, the local AS cannot be the same as the AS alliance number.

Related Configuration

↳ Configuring BGP LOCAL AS

- **neighbor { address | peer-group-name } local-as as-number**

Configures a local AS for a peer. By default, no local AS is configured for any peer. The local AS of a peer is the route BGP AS.

7.3.23 Configuring BGP Capacity Protection

There are often a large number of BGP routes, which may cause overload of a device, especially for a device with small memory. Protecting BGP capacity helps avoid non-predictable running status caused by consumption of device capacity.

Working Principle

↘ Restricting the Number of BGP Routes

Restrict the number of BGP routes by setting the maximum number of routes in a BGP address family and the maximum number of routes that can be learned by a BGP neighbor.

↘ Configuring the Number of BGP Neighbors to Send Warnings

Set the maximum number of BGP neighbors. When the neighbor number exceeds the limit, LOG prompt will be displayed.

↘ Entering the OVERFLOW State in case of Insufficient Memory

If the memory is insufficient, BGP can enter the OVERFLOW state. In the OVERFLOW state, BGP generates a default route pointing to a NULL interface. If a newly learned route is not a refined route other than the default route in the current routing table, the route is discarded. In other words, general newly learned routes are discarded to ensure that the system memory is stable. The purpose of not discarding all routes is to avoid route loops in the entire network. Therefore, it is safe for BGP to enter the OVERFLOW state. BGP is allowed to enter the OVERFLOW state by default.

- i By default, BGP enters the OVERFLOW state in case of insufficient memory. If you do not want to BGP to enter the OVERFLOW state, you can run the **no overflow memory-lack** command to disable this function.
- i In the OVERFLOW state, BGP supports only the **clear bgp [instance as-number] { addressfamily | all } *** command at present. You can also exit from the OVERFLOW state by disabling and enabling BGP again. When the memory becomes sufficient again, BGP can also automatically exit from the OVERFLOW state.

Related Configuration

↘ Restricting the Number of BGP Routes

- **neighbor** { neighbor-address | peer-group-name } **maximum-prefix** maximum [threshold] { [restart-time time] | [warning-only [suppress]] }

Restricts the maximum number of routes that can be learned from a BGP neighbor, which is not restricted by default.

- **maximum-prefix** maximum

Restricts the maximum number of routes in a BGP address family, which is not restricted by default..

- Run the **bgp maximum-prefix** maximum [vrf vrf-name] command to restrict the maximum number of routes in the BGP global or specified VRF. When a route advertisement in an address family causes the current number of BGP routes to exceed the maximum number, a prompt indicating route overflow in the global or specified VRF is displayed, and the BGP global or specified VRF is set to the overflow state. This function is disabled by default.

↘ Configuring the Number of BGP Neighbors

Run the **bgp maximum-neighbor** numbers **warning-only** command to send the LOG warning when neighbors exceed the limit.

↘ Configuring BGP Overflow

- **overflow memory-lack**

Enable BGP to enter the OVERFLOW state in case of insufficient memory, which is enabled by default.

7.3.24 Configuring BGP GR

Graceful Restart (GR) is intended to implement uninterrupted data forwarding during restart of BGP. During active/standby switching of the management boards, the GR function keeps the network topology stable, maintains the forwarding table and ensures that key services are not interrupted.

Working Principle

 Comply with RFC4724: Graceful Restart Mechanism for BGP. [BGP GR] is used in the following description to indicate the RFC.

BGP GR is not an independent process, but is jointly completed by the Restarter and Helper.

- The Restarter performs restart and maintains the working capability of the route forwarding plane when the route control plane is faulty.
- The Helper is the BGP neighbor of the Restarter and helps the Restarter to complete GR.

A capability indicating GR is added to the OPEN message of BGP, which is called "Graceful Restart Capability". This capability is used by BGP to tell its neighbor it supports the graceful restart capability. During initialization of a BGP connection, two neighbors negotiate about the GR capability.

The route update end flag (End-of-RIB, shorted as EOR) is added to the Update packet of BGP, which indicates that the routing information update to the neighbor is completed.

Figure 7- 3 BGP GR Interaction Process

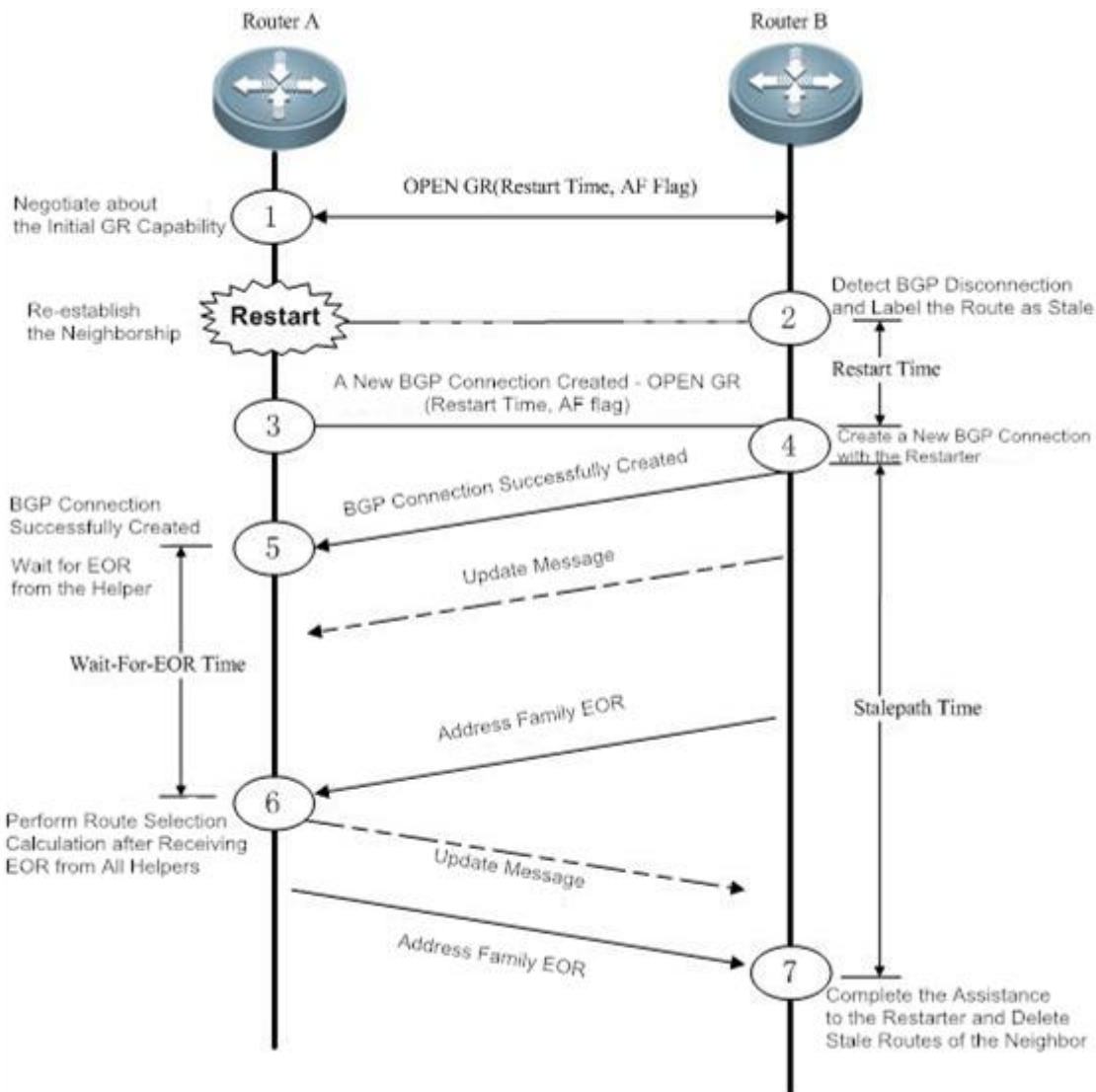

5. ① When BGP establishes neighborhood at the beginning, BGP uses the GR capability field in the OPEN message to negotiate about the GR capabilities of the two neighbors.
6. ② At a moment, the Restarter starts restart, and the BGP session is disconnected. The Helper detects the disconnection, keeps the route of the Restarter valid but adds the "Stale (aged but not updated)" flag to the route.
7. ③ and ④ The Restarter completes restart and connects to the Helper again.
8. ⑤ The Restarter waits for the route update message and EOR flag from the Helper.
9. ⑥ After receiving the EOR flag from all neighbors, the Restarter performs route calculation, update routing entries and then sends updated routes to the Helper.
10. ⑦ After receiving the updated routes, the Helper cancels the "Stale" flag of the routes. After receiving the EOR flag from the Restarter, the Helper deletes routes with the "Stale" flag (these routes are not updated), performs route calculation, and updates the routing entries. The entire GR process is completed.

BGP GR defines several extended and important timers:

- **Restart-Timer:** The GR Restarter advertises the time value to the GR Helper, which indicates the maximum waiting time that the GR Restarter hopes the Helper to wait before a new connection is established between them. You can run the **bgp graceful-restart restart-time** command to modify the time value.

- **Wait-For-EOR Timer:** Indicates the maximum time that the GR Restarter waits for the EOR flag from all GR Helpers. After receiving the EOR flag from all GR Helpers or after the Wait-For-EOR timer expires, the GR Restarter calculates the preferred route and updates the routing entries. You can run the **bgp update-delay** command to modify the time value.
- **StalePath Timer:** Indicates the maximum time that the GR-Helper waits for the EOR flag from the GR Restarter after a new connection is established between them. Within this period, the Helper keeps the original route of the Restarter valid. After receiving the EOR flag or after the StalePath timer expires, the Helper clears the routing entries still with the "Stale" tag. You can run the **bgp graceful-restart stalepath-time** command to modify the time value.

Related Configuration

📄 Configuring BGP GR

- **bgp graceful-restart**

Enables the Restarter capability, which is enabled by default.

- **bgp graceful-restart restart-time** *time*

Sets the Restart Timer. The default value is 120 seconds.

- **bgp update-delay** *delay*

Sets the Wait-For-EOR Timer. The default value is 120 seconds.

- **bgp graceful-restart stalepath-time** *time*

Sets the StalePath Timer. The default value is 360 seconds.

- **bgp graceful-restart disable**

Disables the address family GR capability. The address family GR capability is enabled by default. After the global BGP GR is enabled, the GR capability is automatically enabled for all address families.

- **i** When BGP GR is implemented, all BGP peers must enable the BGP GR capability. If certain peers do not support or enable GR, BGP GR may fail to be implemented. GR failure may cause a short route black-hole or route loop, which may affect the network. Therefore, you are advised to verify that all neighbors are enabled with the BGP GR capability. You can run the **show ip bgp [instance as-number] neighbors** command to display the capabilities successfully negotiated between BGP peers and verify that the GR capability negotiation is successful. In the BGP route configuration mode, run the **bgp graceful-restart** command to enable the BGP GR capability.

- **i** The **bgp graceful-restart** command will not be applied to a successfully established BGP connection immediately. That is, when the BGP connection is in the Established state, the BGP peers will not re-negotiate about the GR capability immediately. To enable the BGP peers of the BGP connection to negotiate about the GR capability immediately, you need to forcibly restart the BGP peers to re-negotiate about the GR capability by running the **clear ip bgp 192.168.195.64** command (for example). To make GR enabling or disabling take effect immediately, you must restart the neighborhood for capability negotiation, which may cause network flapping and affect normal use of users. Therefore, you can explicitly control whether to restart the neighborhood.

- **i** Supporting BGP GR does not mean that a device can be used as the Restarter to implement BGP GR. Whether to implement BGP GR also depends on the hardware capabilities of the device. FS devices must support the dual-engine hot backup when being used as the GR Restarter.

- **i** The restart period configured by the **bgp graceful-restart restart-time** command should not be longer than the Hold Time of the BGP peers; otherwise, the Hold Time will be used as the restart time to be advertised to the BGP peers during GR capability negotiation.

- i** The **bgp graceful-restart disable** command is used to disable the GR capability in an address family in the address family configuration mode, which is not configured by default.

7.3.25 Configuring 4-Byte AS Numbers of BGP

A traditional AS number consists of 2 bytes, ranging from 1 to 65,535. A newly defined AS number consists of 4 bytes, ranging from 1 to 4,294,967,295. Newly defined AS numbers are used to cope with exhaustion of AS number resources.

Working Principle

4-byte AS numbers support two expression modes: the decimal mode and dot mode. The decimal mode is the same as the original expression mode, that is, expressing the 4 bytes of an AS number as decimal digits. The dot mode is expressed as ([higher 2 bytes].[lower 2 bytes]). If the higher 2 bytes are 0, they will not be displayed.

For example, an AS number is 65534 in the decimal mode and is 65,534 in the dot mode (the 0 at the beginning is not displayed).

For example, an AS number is 65,536 in the decimal mode, and is 1.0 in the dot mode.

For example, an AS number is 65,538 in the decimal mode, and is 1.2 in the dot mode.

- i** Related protocols are as follows: RFC 4893 and RFC 5396.

⌵ Configuring the Display Mode of a 4-Byte AS Number

A 4-byte AS number is displayed in the decimal mode by default. You can manually set the display mode to the dot mode. After the setting, a regular expression will use the dot mode for matching 4-byte AS numbers.

⌵ Compatibility with Devices Supporting Only 2-Byte AS Numbers

With introduction of 4-byte AS numbers, BGP connections may be established between old BGP speakers supporting only 2-byte AS numbers and new BGP speakers supporting 4-byte AS numbers. If the AS where a new BGP speaker resides has a 4-byte AS number, when an old BGP speaker creates neighborhood with the new BGP speaker, the old BGP speaker uses the reserved AS number 23,456 to replace the 4-byte AS number of the new BGP speaker. In the OPEN packets sent by the new BGP speaker to the old BGP speaker, the 4-byte AS number in the **My Autonomous System** field will be replaced by 23,456. In addition, in UPDATE packets sent to the old BGP speaker, the 4-byte AS number in the AS-PATH and AGGREGATOR attributes will also be replaced by 23,456. In addition, new optional transfer attributes AS4-PATH and AS4- AGGREGATOR will be used to record the real 4-byte AS number so that the real AS-PATH and AGGREGATOR attributes can be restored when the route reaches a next new BGP speaker.

In other cases, the real AS number of the remote end is used to create neighborhood.

Related Configuration

⌵ Configuring the Display Mode of a 4-Byte AS Number

- **bgp asnotation dot**

Displays a 4-byte AS number in the dot mode. The decimal mode is used by default.

7.3.26 Configuring a Regular Expression

A regular expression is a formula that matches strings based on a template.

The formula is used to assess text data and return True or False to indicate whether the expression can correctly describe the data.

Working Principle

Regular expressions are used in BGP path attributes. The following table describes the usages of special characters in a regular expression.

Character	Symbol	Special Meaning
Period	.	Matches any single character.
Asterisk	*	Matches zero or any sequence in a string.
Plus sign	+	Matches one or any sequence in a string.
Question mark	?	Matches zero or one symbol in a string.
Caret	^	Matches the start of a string.
Dollar sign	\$	Matches the end of a string.
Underline	_	Matches the start, end and space of commas, brackets and strings.
Square brackets	[]	Matches a single character within a range.

Related Configuration

✚ Using a Regular Expression in a show Command

- **show ip bgp [instance *as-number*] regexp *regexp***
Displays the BGP routing information in a specified regular expression matched by the AS-PATH attribute.
- **show ip bgp [instance *as-number*] quote-regexp *regexp***
Displays the BGP routing information in a regular expression within the specified double quotation marks matched by the AS-PATH attribute.

7.3.27 Configuring BGP Session Retention

By default, when an UPDATE packet is received from a neighbor, a BGP session will be disconnected if an error is detected on the multi-protocol routing attribute. This will cause flapping of the routes in all address families of this neighbor. That is, the routing error in an address family will affect the route stability in other address families.

Working Principle

After the BGP session retention function is enabled, if an error occurs in the routing attribute of an address family, only the routing information in this address family related to the neighbor is deleted. In addition, the BGP session and other address families are not affected, which enhances the stability of BGP.

recovery-time is used to configure the time for waiting for automatic route recovery, which requires that a neighbor should support the route-refresh capability. After the recovery-time, BGP sends the route-refresh message of the address family to the neighbor and re-advertises all routing information in the address family to this neighbor.

-  In the session retention state, you can manually reset the neighbor to exit from the session retention state.

Related Configuration

✚ Configuring BGP Session Retention

- **bgp mp-error-handle session-retain [recovery-time *time*]**
Enables the BGP session retention function, which is disabled by default.

recovery-time *time* configures the time for waiting for automatic route recovery, ranging from 10 to 65535 seconds. The default value is 120.

7.3.28 Configuring BGP Delayed Advertisement upon System Restart

By default, after the neighborhood is established after system restart, a BGP peer can advertise route information to its neighbors. This is normal in most cases. However, in certain cases, for example, there are many neighbors or routes during startup but writing entries into the hardware is slow. In this case, the neighbors have learned the routes and started forwarding traffic, but the hardware has not completed writing of entries at the local end, which causes failure of traffic forwarding.

Working Principle

The BGP delayed advertisement upon system restart ensures that routes are not advertised to neighbors immediately after the neighborhood is established upon system restart and that the routes are advertised after a period. This function has no effect on other behaviors such as route receiving performed by the neighbors. If part of the routes is not affected by the delay, configure prefix-list policy to match this part of routes so that route advertisement can be more flexible.

delay-time is used to configure the waiting time before routes are advertised to the neighbors. **startup-time** is used to configure the startup time. Within the startup-time, BGP sends routing information to the neighbors at the interval specified by **delay-time**.

-  After the startup-time ends, the default route advertisement behavior recovers.

Related Configuration

Configuring BGP Delayed Advertisement upon System Restart

bgp initial-advertise-delay delay-time [startup-time] [wait-for-controller]

Enables BGP delayed advertisement upon system restart, which is disabled by default.

delay-time configures the delay time for advertising routes after the BGP neighborhood is established upon system restart, ranging from 1 to 600 seconds. The default value is 1s.



startup-time configures the time range for system restart, ranging from 5 to 58,400 seconds. The delayed route advertisement mechanism is used within this range. The default value is 600s.

7.3.29 Configuring BGP Delayed Advertisement for First Routes

By default, after the neighborhood is established, a BGP peer can advertise route information to its neighbors. However, neighbors with the neighborhood newly established will send out the route information after a delayed period of time.

Working Principle

After BGP starts, BGP peers negotiate to establish the neighborhood before sending route information (update packets).

-  If update delay is configured on the local end, the route received from the specified neighbor will be sent to other neighbors after the delay time. If BGP delayed advertisement upon system restart and BGP delayed advertisement for first routes are enabled at the same time, BGP delayed advertisement upon system restart takes precedence over BGP delayed advertisement for first routes.
-  BGP GR is not affected by either BGP delayed advertisement upon system restart or BGP delayed advertisement for first routes, that is, the BGP GR route advertisement is not affected by the delay time.

Related Configuration

↳ Creating a BGP Neighbor

By default, no neighbor is specified on a BGP speaker. You need to manually configure a BGP neighbor.

Run the **neighbor** { *peer-address* | *peer-group-name* } **remote-as** *as-number* command to manually create a BGP neighbor and specify the AS number of the neighbor.

↳ Configuring BGP Delayed Advertisement for First Routes

By default, BGP delayed advertisement for first routes is disabled for neighbors.

Run the **neighbor** { *peer-address* | *peer-group-name* } **update-delay** *delay-time* command to enable BGP delayed advertisement for first routes.

7.3.30 Configuring BGP Tracking

The BGP tracking function provides fast link fault detection for BGP speakers, accelerating route convergence.

Working Principle

When the BGP tracking function is enabled for a BGP speaker, the BGP speaker is associated with the corresponding track session of the track module to monitor status change. In normal cases, the BGP speaker associates with the track module to perceive link changes. When a link is faulty, the track module notifies the BGP speaker rapidly, implementing fast route convergence. BGP tracking configuration is simpler than BFD configuration because only local configuration is required.

 For details about the track session configuration and related commands, see *TRACK-RNS-SCG.doc*.

Related Configuration

↳ Configuring Association Between the BGP Neighbor and Track Instance

Run the **neighbor** *neighbor-address* **track** *track-obj-number* command to configure association between a BGP neighbor and a track instance, which is not configured by default.

7.3.31 Configuring BGP NSR

None-Stop-Routing (NSR) is used to ensure uninterrupted routes during protocol restart upon a switchover between the active and standby management boards. During a switchover between the active and standby management boards, the NSR function ensures stable network topology, maintains neighbor status and forwarding tables, and guarantees uninterrupted key services.

Working Principle

Different from BGP GR, BGP NSR is a function implemented individually by a BGP speaker and does not rely on neighbors.

- During a switchover between the active and standby management boards, connections between BGP neighbors are not interrupted.
- Neighbors do not perceive the restart behavior on the local end. The GR technology is used for restart restoration.

Neighbors with the BGP NSR function enabled do not need to negotiate the GR capability. In addition, neighbor assistance is not required and interworking problems do not exist as NSR is a reliability technology not perceived by neighbors.

Related Configuration

↘ Creating a BGP Neighbor

By default, no neighbor is specified on a BGP speaker. You need to manually configure a BGP neighbor.

Run the **neighbor** { *peer-address* | *peer-group-name* } **remote-as** *as-number* command to manually create a BGP neighbor and specify the AS number of the neighbor.

↘ Enabling the NSR Function for BGP Neighbors





By default, the NSR function is disabled for BGP neighbors.

Run the **neighbor** { *peer-address* | *peer-group-name* } **ha-mode nsr** command to enable the NSR function for BGP neighbors.

↘ Enabling the NSR Function for BGP Neighbors Globally

By default, the NSR function is disabled.

Run the **bgp nsr** command to enable the NSR function for BGP neighbors globally.

-  When the BGP NSR function is enabled for a neighbor, the connection to the neighbor will be reset, the tcp nss (none-stop-service) of the neighbor will be enabled, and the related neighbor and route information are backed up to the standby management board. In this case, if the NSR function is enabled after the neighborship is established, the neighborship will be re-established, causing neighbor down. It is recommended that the NSR function be enabled before the neighborship is established.
-  The NSR function does not take effect on a neighbor that fails to establish the BGP connection, that is, if the BGP connection is not in the **Established** state, the neighbor will not execute NSR related backup operations. Only if the BGP connection is in the **Established** state, the neighbor performs NSR related backup operations.
-  Not all devices that support the BGP NSR function can perform switchovers between the active and standby management boards. To perform switchovers between the active and standby management boards, the device hardware must meet specific requirements. NSR devices on FS networks must support the dual engine redundancy hot backup function.
-  Currently, only the IPv4/IPv6 unicast address family and EVPN address family support the NSR function. If a neighbor activates other address families except the unicast address family, NSR switchovers cannot be performed.
-  If the BGP or TCP backup is not complete, the BGP NSR switchover may fail. When this status occurs, the BGP GR will reconnect the route. It is recommended to enable the BGP NSR and BGP GR at the same time.

7.3.32 Configuring BGP Routes to Be Recursive Only to Host Routes

BGP routes use optimal matching for route recursion by default. Therefore, BGP routes may be recursive to default routes or incorrect network segment routes, resulting in an egress or next hop error. After the function of making BGP routes recursive only to host routes is enabled, BGP routes are recursive only to 32-bit IPv4 host routes or 128-bit IPv6 host routes. This function is applied to routes learnt by neighbors of IBGP or multi-hop EBGP neighborships established using the Loopback interface.

Working Principle

After the function of making BGP routes recursive only to host routes is enabled, the function checks the validity of the next-hop addresses of IBGP or multi-hop EBGP routes via exact matching, and conducts route recursion on the IBGP or multi-hop EBGP routes via exact matching after they are written into the FIB. For example, the next-hop address of the IBGP route 192.168.2.0/24 is 1.1.1.1. The next-hop address of the IBGP route 192.168.2.0/24 is valid only when the route 1.1.1.1/32 exists, and the egress of the route written into the FIB is the egress of the route 1.1.1.1/32.

Related Configuration

↘ Creating a BGP Neighbor

By default, no neighbor is specified for a BGP speaker. You need to manually configure a BGP neighbor.

Run the **neighbor** { *peer-address* | *peer-group-name* } **remote-as** *as-number* command to manually create a BGP neighbor and specify an AS number for the neighbor.

↘ Enabling BGP Routes to Be Recursive Only to Host Routes

By default, recursion is performed on BGP routes via exact matching.

Run the **bgp recursion host** command to enable BGP routes to be recursive only to host routes.

7.3.33 Configuring Outbound Loop Detection for a BGP Neighbor

By default, BGP conducts loop detection on BGP routes when receiving the BGP routes from a neighbor. When the **AS Path** attribute carried in a BGP route contains the local AS number, BGP filters out the BGP route. The outbound loop detection function of a neighbor is to conduct loop detection on routes in advance when the routes are transmitted to a neighbor, so as to filter out loop routes.

Working Principle

When sending a route to an EBGP neighbor, the device judges whether the **AS Path** attribute carried in the BGP route contains the AS number of the neighbor. If yes, the route is looped and the device does not send the route to the EBGP neighbor.

Related Configuration

↘ Creating a BGP Neighbor

By default, no neighbor is specified for a BGP speaker. You need to manually configure a BGP neighbor.

Run the **neighbor** { *peer-address* | *peer-group-name* } **remote-as** *as-number* command to manually create a BGP neighbor and specify an AS number for the neighbor.

↘ Enabling Outbound Loop Detection for a Neighbor

The outbound loop detection is disabled for a neighbor by default.

Run the **neighbor** { *peer-address* | *peer-group-name* } **as-loop-check out** command to enable the outbound loop detection for the BGP neighbor.

7.3.34 Shutting Down BGP Connections Gracefully

The RFC 6198 *Requirements for the Graceful Shutdown of BGP Sessions* defines a requirement for shutting down BGP connections gracefully, and requests that a BGP neighbor shut down connections under the precondition that service traffic is not interrupted or is interrupted for a very short period of time.

Working Principle

This feature adopts the "Make-Before-Break" mode to shut down BGP connections, to ensure that service traffic is not interrupted or is interrupted for a very short period of time in the process from the feature configuration to actual BGP connection shutdown. The steps are as follows:

- The feature enables the device to advertise a route with the lowest priority (the value of **local-preference** is **0** or the value of **med** is 4,294,967,295) to a neighbor and carry the **gshut community** attribute in the route so that the neighbor updates routes and switch traffic to a backup link or other equivalent links in advance.
- The device shuts down the BGP connection with the neighbor after a period of time.

The delay period of time for BGP connection shutdown can be manually specified or automatically calculated. The automatically calculated delay time is 1 second for 500 routes.

- i** If the **local-preference** or **med** attribute of the route with the lowest priority cannot enable the neighbor to switch traffic to backup links or other equivalent links in advance, configure an inbound policy on the neighbor to change the priority of routes carrying the **gshut community** or specified **community** attribute or to filter such routes.

Related Configuration

✚ Shutting Down All Connections of a BGP Instance Gracefully

By default, all connections of BGP instances are not shut down.

Run the **bgp shutdown graceful [community value] [delay time]** command to shut down all connections of a BGP instance.

✚ Shutting Down Connections of the BGP Neighbor Gracefully

By default, the connections of BGP neighbors are not shut down.

Run the **neighbor { peer-address | peer-group-name } shutdown graceful [community value] [delay time]** command to disable connections of a BGP neighbor.

7.3.35 Configuring Enhanced VPN Route Import

Working Principle

During inter-VRF route import, import of L3VPN remote routes to VRF, or import of EVPN routes to the IP route table, only routes with preferred next hops are imported by default.

The enhanced VPN route import function is an extension of the inter-import of the preceding routes. It enables all routes with next hops or equivalent next hops to be imported.

Related Configuration

✚ Configuring the Route Import Policy

By default, only routes with preferred next hops are imported.

Run the **import path selection { all | bestpath | multipath }** command to import all routes with next hops, routes with preferred next hops, or routes with equivalent next hops.

7.3.36 BGP Route Update Group

The BGP route update group function is used to enhance the performance for advertising routes to neighbors.

Working Principle

The BGP route update group function automatically classifies neighbors with the same outbound policy to the same update group. When routes are sent to neighbors, the update packet is encapsulated based on the update group and sent to all neighbors in the

update group. In this case, the update packet is encapsulated for once and sent multiple times, improving the performance of route advertisement to neighbors.

7.3.37 Configuring BGP EVPN

As a layer-2 VPN technology, the Ethernet Virtual Private Network (EVPN) uses the MB-BGP on the control plane to distribute layer-2 and layer-3 routing information and uses the Virtual eXtensible Local Area Network (VXLAN) on the data plane to encapsulate service traffic..

Working Principle

The EVPN is a layer-2 VPN technology extended based on the MP-BGP. The MP-BGP expands the EVPN address family to transfer the required layer-2 and layer-3 routing information, and support multiple types of data planes. At present, only the VXLAN can serve as the data plane of the EVPN.

The MP-BGP adds not only the EVPN address family, but also the EVPN network layer reachability information, which includes the following:

1. Ethernet Auto-discovery Route: Automatically discovers Ethernet Segment (ES) information in a multi-homed network.
2. MAC/IP Advertisement Route: Advertises the MAC address and host ARP information.
3. Inclusive Multicast Ethernet Tag (IMET) Route: Automatically discovers VXLAN tunnel end points (VTEPs) and creates VXLAN tunnels.
4. Ethernet Segment Route: Advertises ES information and information about connected VTEPs.
5. IP Prefix Route: Advertises routing information of IP network segments.

At present, Ethernet Auto-discovery Route and Ethernet Segment Route are not supported.

The preceding EVPN routing information includes the RD (for EVPN routes of different VNIs) and route target (for importing EVPN routes between different devices).

Related Configuration

↘ Configuring EVPN

By default, the EVPN mode is not activated.

Run the **evpn** command to enter the EVPN mode.

↘ Creating an EVI Instance

By default, no EVI instance is configured.

Run the **vni vni-id** command to create an EVI instance and enter the EVI instance configuration mode.

Run the **vni range vni-id-list** command to create EVI instances in batches and enter the EVI instance batch configuration mode.

↘ Configuring RD

By default, no RD is configured in evpn-vni mode.

Run the **rd { auto | rd_value }** command to add RD.

↘ Configuring Route Target

By default, no route target is configured in evpn-vni mode.

Run the **route-target** { **import** | **export** | **both** } command to configure route target.

↘ **Configuring a Route Map for EVI Instances**

By default, no route map is configured for EVI instances.

Run the **export map** *routemap-name* command to configure the route map for exporting the extended community attribute of EVPN routes from the local device to the remote device.

Run **import map** *routemap-name* command to configure the route map for importing the remote EVPN routes to the local VNI instance.

↘ **Configuring an EVPN Address Family**

By default, no EVPN address family is activated.

Run the **address-family l2vpn evpn** command to activate an EVPN address family.

↘ **Configuring MAC Mobility Parameters**

By default, if five MAC address moves are detected within 180s, it is considered that a MAC address conflict occurs.

Run the **bgp mac-mobility timer count** [*delay-timer*] command to adjust the MAC mobility detection parameters.

↘ **Modifying the Router MAC Attribute to Router MAC Address or Anycast MAC Address of Local Device**

By default, the router MAC attribute is not modified for EVPN routes.

Run the **neighbor** { *neighbor-address* | *peer-group-name* } **router-mac-self** command to set the router MAC attribute of EVPN routing information to the router MAC address or anycast MAC address of the local device.

7.3.38 Configuring BMP

BGP Monitor Protocol (BMP) monitors BGP running on a device, focusing on the status, entry sending and receiving, and all kinds of statistics of BGP peers.

Working Principle

A BGP speaker proactively sends a TCP connection request carrying a destination IP address and a port number (the destination IP address is the BMP server address, and both of the address and port number are specified by the client) to the specified BMP server. After the TCP connection is successfully established, the BGP speaker advertises BMP packets to the BMP server.

Related Configuration

↘ **Creating a BMP Server Instance**

By default, no BMP server instance is configured.

Run the **bmp server** *server-number* command to create a BMP server instance and enter the BMP instance configuration mode.

↘ **Configuring the Address and Port Number of the BMP Server**

By default, the BMP server address and port number are not configured in BMP configuration mode.

Run the **address** *bmp-server-address* **port** *port-number* command to configure the address and port number of the BMP server.

↘ **Configuring the update-source**

By default, the outbound interface of a TCP connection is automatically selected based on the IP address of the BMP server. In normal cases, the outbound interface of the local packet is used.

Run the **update-source** *interface-type interface-number* command to set the outbound interface of the TCP connection to the BMP server.

↘ **Configuring VRF**

By default, a TCP connection is established to the BMP server under the default VRF instance.

Run the **vrf** *vrf-name* command to establish a TCP connection to the BMP server under a specific VRF instance.

↘ **Configuring failure-retry-delay**

By default, the interval to reconnect to the BMP server increases from 30s.

Run the **failure-retry-delay** *second* command to set the interval to establish a TCP connection to the BMP server.

↘ **Configuring description**

By default, no description is configured.

Run the **description** *text* command to add the description to BMP instance.

↘ **Configuring buffer-size**

By default, no limit is set for the max bytes of packet in buffer.

Run the **buffer-size** *maximum* command to limit the max bytes of packet in buffer for BMP instance.

↘ **Configuring the BMP Server to Monitor BGP Peers**

By default, BGP peers are not monitored by the BMP server.

Run the **neighbor** { *neighbor-address* | *peer-group-name* } **bmp-active** { **all** | **server** *server-number* [*server-number* [*server-number*]] } command to enable the BMP server to monitor BGP peers.

↘ **Configuring All BMP Servers to Monitor BGP Peers**

By default, BGP peers are not monitored by all BMP servers.

Run the **bgp bmp-active** command to enable all BMP servers to monitor BGP peers.

↘ **Configuring the BMP Server to Monitor BGP Peer Packets**

By default, the BMP server does not enable route mirroring packet sending.

Run the **route mirroring** command to enable route mirroring packet sending to send real-time mirroring BGP packets to the BMP server.

↘ **Configuring the Interval for Sending Status Statistics to the BMP Server**

By default, when status statistics of a monitored peer are changed, the BMP module sends the status statistics to the BMP server.

Run the **stats-reporting-period** *time* command to specify the interval for sending status statistics to the BMP server.

↘ **Configuring the BMP Server to Monitor Unchanged Routing Information Received from a BGP Peer**

By default, the BMP server does not monitor unchanged routing information received from a BGP peer.

Run the **adj-rib-in pre-policy** command to enable the BMP server to monitor unchanged routing information received from a BGP peer.

↘ **Configuring the BMP Server to Monitor Routing Information Received from a BGP Peer After the Routing Policy Is Applied**

By default, the BMP server does not monitor routing information received from a BGP peer after the routing policy is applied.

Run the **adj-rib-in post-policy** command to enable the BMP server to monitor routing information received from a BGP peer after the routing policy is applied.

↘ **Configuring the BMP Server to Monitor Routing Information Sent to a BGP Peer After the Routing Policy Is Applied**

By default, the BMP server does not monitor routing information sent to a BGP peer after the routing policy is applied.

Run the **adj-rib-out post-policy** command to enable the BMP server to monitor routing information sent to a BGP peer after the routing policy is applied.

7.3.39 Configuring Domain

Assign neighbors to a specified domain group, and process neighbors in the same domain group.

Working Principle

Run the command to specify the domain for neighbors, and do not suppress detailed routings of neighbors in the domain group.

Related Configuration

↘ **Specifying a Domain Group for Neighbor**

By default, no domain is specified.

Run the **neighbor { neighbor-address | peer-group-name } domain domain-name** command to specify the domain group for peer.

↘ **Configuring not to Suppress Detailed Routing in Domain Group of Neighbor**

By default, the function is disabled in domain group of neighbor.

Run the **neighbor { neighbor-address | peer-group-name } domain-unsuppress** command to not suppress detailed routing in the domain group of neighbor.

7.3.40 Configuring Link State Tracking Group

Associate the neighbor with link state tracking group, so that neighbor status will affect the statue of downlink port of the link state tracking group.

Working Principle

Associate the neighbor with a specified link state tracking group. When the neighbor is down, the downlink port of the group is down; when the neighbor is up, the downlink port of the group is up.

Related Configuration

↘ **Configuring Link State Tracking Group for Neighbor**

By default, neighbor is not associated with any link state tracking group.

Run the **neighbor** { *neighbor-address* | *peer-group-name* } **link state group** *num* command to specify the link state tracking group.

➤ **Configuring the Delay Time to Enable Downlink Port of Link State Tracking Group after Neighbor is Up**

By default, the delay time is 5 s.

Run the **bgp link-state-group up-delay** *delay-time* command to configure the delay time to enable the downlink port of link state tracking group after neighbor is up.

➤ **Adding the Port to Specified Link State Tracking Group**

By default, a port is not added to any tracking group.

Run the **link state group** *num* { **upstream** | **downstream** } command to add a port to the specified link state tracking group.

7.3.41 Configuring BGP Additional Paths

In BGP, the routes with the same prefix from a neighbor are regarded as one entry. Configure BGP add-path to receive multiple routes with the same prefix.

Working Principle

By default, when BGP receive a route with the same prefix from a peer, it will replace the previous route with the new one, namely, it regards the route with the same prefix as one entry. After configuring the add-path function, BGP will add a path-id field to the route advertised by the peer that can therefore judge whether the route is the same according to prefix, peer and path-id. When the received route is different, the peer will add it as a new entry so as to obtain multiple routes with the same prefix from a peer.

BGP add-path is only available for the IBGP peer.

Related Configuration

➤ **Configuring add-path Route Preference**

By default, add-path route preference is disabled.

Run the **bgp additional-paths select** { **all** | **best** *number* | **ecmp** } command to select the add-path route of the specified type.

➤ **Enabling add-path Capability on Specified Peer**

By default, the add-path capability is disabled.

Run the **neighbor** { *peer-address* | *peer-group-name* } **additional-paths** { **send** [**receive**] | **receive** } command to enable the device to advertise/receive the add-path route.

➤ **Advertising add-path Route to Peer**

By default, BGP does not advertise the add-path route to its peers.

Run the **neighbor** { *peer-address* | *peer-group-name* } **advertise additional-paths** { **all** | **best** *number* | **ecmp** } command to advertise the add-path route of the specified type to peers when the add-path negotiation succeeds.

-  Run the **bgp additional-paths select** command to select the add-path routes of the specific type. If the type of selected add-path routes is different from that of advertised ones, then the add-path route is not advertised but only the optimal route is advertised.

- i** Only when the local device is enabled to send the add-path route and the peer is enabled to receive the add-path route, the local device is allowed to advertise the add-path route.

7.3.42 Other Related Configurations

- i** For configuration and application of BGP MCE, see section "VRF Configuration Guide".
- i** For configuration and application of BGP L2VPN, see section "L2VPN Configuration Guide".
- i** For configuration and application of BGP/MPLS VPN, see section "BGP/MPLS VPN Configuration Guide".
- i** For configuration and application of the BGP MDT address family, see section "Multicast VPN (MD Configuration Guide)".

7.4 Configuration

Configuration	Description and Command	
Configuring a BGP Peer (Group)	(Mandatory) It is used to create a BGP neighbor.	
	router bgp	Enables BGP.
	neighbor { <i>peer-address</i> <i>peer-group-name</i> } remote-as <i>as-number</i>	Creates a BGP neighbor.
Configuring MD5 Authentication	(Optional) It is used to perform encrypted authentication for the BGP neighbor.	
	neighbor { <i>peer-address</i> <i>peer-group-name</i> } password [0 7] <i>string</i>	Configures the password for encryption.
Configuring a Route Reflector	(Optional) It is used to reduce the number of BGP neighbor connections.	
	neighbor { <i>peer-address</i> <i>peer-group-name</i> } route-reflector-client	Specifies a peer (group) as a reflector client.
Configuring an AS Alliance	(Optional) It is used to reduce the number of BGP neighbor connections.	
	bgp confederation identifier <i>as-number</i>	Configures the BGP alliance ID.
	bgp confederation peers <i>as-number</i> [... <i>as-number</i>]	Configures a BGP alliance neighbor.
Configuring Multi-path Load Balancing of BGP	(Optional) It is used to implement multi-path load balancing.	
	maximum-paths ibgp <i>number</i>	Configures IBGP load balancing.
	maximum-paths ebgp <i>number</i>	Configures EBGP load balancing.
	bgp bestpath as-path multipath-relax	Enables the BGP AS-PATH loose comparison mode.
Configuring EBGP FRR	(Optional) It is used to increase the convergence speed when a network fault occurs.	
	bgp fast-reroute	Configures BGP FRR.
	neighbor { <i>neighbor-address</i> <i>peer-group-name</i> } fall-over bfd	Configures a BFD session to a BGP neighbor.
Configuring Fast Withdrawal of Specified BGP Routes	(Optional) It is used to fast withdraw the specified BGP routes.	
	bgp fast-withdraw { access-list { <i>access-list-number</i> <i>access-list-name</i> } prefix-list <i>prefix-list-name</i> route-map <i>map-tag</i> }	Configures fast withdrawal of specified BGP routes.
Configuring FRR in an IBGP	(Optional) It is used to increase the convergence speed when a network fault occurs.	

Configuration	Description and Command	
Route Reflection Environment	bgp fast-reroute	Configures BGP FRR.
Configuring Local ASs	(Optional) It is used for transitional deployment during network migration.	
	neighbor { peer-address peer-group-name } local-as as-number [no-prepend [replace-as [dual-as]]]	Configures the local AS for a BGP neighbor.
Configuring BGP GR	(Recommended) It is used to improve the network reliability.	
	bgp graceful-restart	Enables the BGP GR capability.
	bgp graceful-restart restart-time restart-time	Configures the maximum time for BGP GR.
	bgp graceful-restart stalepath-time time	Configures the maximum retention time for BGP stable route.
Configuring a BGP IPv6 Address Family	(Optional) It is used to deploy an IPv6 network by using BGP.	
	address-family ipv6 unicast	Enters the BGP IPv6 unicast configuration mode.
	neighbor { neighbor-address peer-group-name } activate { ipv4 ipv6 }	Activates the address family capability of a BGP neighbor in the current configuration mode.
Configuring BGP EVPN	Optional. It is used to configure the EVPN VXLAN network.	
	address-family l2vpn evpn	address-family l2vpn evpn
	vni vni-id	Creates EVI instance
	rd { auto rd_value }	Configures RD
	route-target { import export both } { auto rt_value }	
	export map routemap-name	Configures the extended group attribute policy of the local end to EVPN route
	import map routemap-name	Configures the policy of the EVPN route to the local VNI instance
	bgp mac-mobility timer count	Configures MAC mobility parameter
	neighbor { peer-address peer-group-name } router-mac-self	Changes router MAC to the local address.
	bgp bestpath evpn-seq-relax	Configure BGP not to compare the serial number of EVPN router from the same VTEP when selecting the optimal route
Configuring Domain Group	Optional. It is used to configure domain group.	
	neighbor { neighbor-address peer-group-name } domain domain-name	Configures the domain group of neighbor
	neighbor { neighbor-address peer-group-name } domain-unsuppress	Configures not to suppress detailed routings in the same domain group.
Configuring BGP Associated Link State Tracking Group	Optional. It is used to configure the link state tracking group associated with BGP neighbor.	
	neighbor { neighbor-address peer-group-name } link state group num	Configures the link state tracking group associated with BGP neighbor.
	bgp link-state-group up-delay delay-time	Configures the delay time to enable the downlink port of link state tracking group after the

Configuration	Description and Command
	neighbor is up.
<u>Disabling Private PIC Process</u>	<p> Optional. It is used to disable the private PIC process for BGP neighbor</p> <p>neighbor { <i>neighbor-address</i> <i>peer-group-name</i> } pic-disable</p> <p>Disables private PIC process</p>
<u>Configuring add-path</u>	<p> Optional. It is used to enable the BGP neighbor to advertise the routes with the same prefix.</p> <p>bgp additional-paths select { all best <i>number</i> ecmp }</p> <p>Selects all valid routes as the add-path routes.</p> <p>neighbor { <i>peer-address</i> <i>peer-group-name</i> } advertise additional-paths { all best <i>number</i> ecmp }</p> <p>Advertises the add-path route to the peer.</p> <p>neighbor { <i>peer-address</i> <i>peer-group-name</i> } additional-paths { send [receive] receive }</p> <p>Configures the add-path capability of the peer.</p>
<u>Configuring Interconnection with Devices Supporting Only 2-Byte AS Numbers</u>	<p> Optional. It is used for interconnecting with an old device that supports only 2-byte AS numbers.</p> <p>neighbor { <i>neighbor-address</i> <i>peer-group-name</i> } remote-as <i>as-number</i></p> <p>Creates a BGP neighbor.</p>

7.4.1 Configuring a BGP Peer (Group)

Configuration Effect

- Configure BGP and create IBGP and EBGP neighbors.

Notes

- If an IBGP neighbor is not directly connected, you need to configure IGP or a static routing protocol to implement interconnection.
- If an EBGP neighbor is not directly connected, you need to configure the **ebgp-multihop** parameter for the neighbor.

Configuration Steps

↘ Enabling BGP

- (Mandatory) Perform this configuration in the global configuration mode.

↘ Creating a BGP Neighbor

- (Mandatory) Perform this configuration in the BGP configuration mode.

↘ Configuring a Source Interface for a BGP Neighbor

- (Optional) Perform this configuration in the BGP configuration mode. By default, BGP automatically selects a local interface that reaches the destination IP address of a peer as the source interface.

For an IBGP neighbor, you are advised to use a Loopback interface as the source interface.

Verification

- Run the **show** command to display the neighbor status.

Related Commands

↘ Enabling BGP

Command	router bgp <i>as-number</i> [instance <i>instance-name</i>]
Parameter Description	<i>as-number</i> : Indicates an AS number, ranging from 1 to 4,294,967,295, which is 1 to 65535.65535 in the dot mode. instance : The instance should be specified for the non-default instance, and the instance name is required. <i>instance-name</i> : Instance name of 1 to 32 characters.
Command Mode	Global configuration mode
Usage Guide	-

↘ Creating a BGP Neighbor

Command	neighbor { <i>neighbor-address</i> <i>peer-group-name</i> } remote-as <i>as-number</i>
Parameter Description	<i>neighbor-address</i> : Specifies the address of a peer. This address may be an IPv4 address or an IPv6 address. <i>peer-group-name</i> : Specifies the name of a peer group. <i>as-number</i> : Indicates the AS number of a BGP peer (group).
Command Mode	BGP configuration mode
Usage Guide	The AS specified for a peer (group) must be the same as the BGP AS number of a BGP speaker at the peer end.

↘ Creating a Source Interface for a BGP Neighbor

Command	neighbor { <i>neighbor-address</i> <i>peer-group-name</i> } update-source { <i>interface-type interface-number</i> <i>address</i> }
Parameter Description	<i>neighbor-address</i> : Specifies the address of a peer. This address may be an IPv4 address or an IPv6 address. <i>peer-group-name</i> : Specifies the name of a peer group. <i>interface-type interface-number</i> : Indicates an interface name. <i>address</i> : Directly specifies the network interface address used for creating a BGP connection.
Command Mode	BGP configuration mode
Usage Guide	The source interface of a neighbor must be a local valid interface or address.

↘ Disabling Private PIC process to BGP Neighbor

Command	neighbor { <i>neighbor-address</i> <i>peer-group-name</i> } pic-disable
Parameter Description	<i>neighbor-address</i> : Specifies the IPv4 or IPv6 address of a peer. <i>peer-group-name</i> : Specifies a peer group name.
Command Mode	BGP configuration mode
Usage Guide	When the neighbor uses other vendors' device and it sends extended community attributes whose type is CF and sub type is E1, it is recommended to run this command.

Configuration Example

↘ Configuring a BGP Peer (Group)

<p>Scenario Figure 1-4</p>	
<p>Configuration Steps</p>	<ul style="list-style-type: none"> ● Enable BGP on all devices and set the AS numbers as shown in Figure 1-4. ● Configure a loopback interface on A, B, and C and create an IBGP neighbor based on the loopback interface. ● Create an EBGP neighborhood by using the directly connected interfaces on C and D. ● Create an IBGP peer group on C.
<p>A</p>	<pre>A# configure terminal A(config)# interface loopback 0 A(config-if-Loopback 0)# ip address 10.1.1.1 255.255.255.255 A(config-if-Loopback 0)# exit A(config)# interface GigabitEthernet 0/1 A(config-if-GigabitEthernet 0/1)# ip address 192.168.1.1 255.255.255.0 A(config-if-GigabitEthernet 0/1)# exit A(config)# router bgp 65536 A(config-router)# neighbor 10.1.1.3 remote-as 65536 A(config-router)# neighbor 10.1.1.3 update-source loopback 0</pre>
<p>B</p>	<pre>B# configure terminal B(config)# interface loopback 0 B(config-if-Loopback 0)# ip address 10.1.1.2 255.255.255.255 B(config-if-Loopback 0)# exit B(config)# interface GigabitEthernet 0/1 B(config-if-GigabitEthernet 0/1)# ip address 192.168.2.2 255.255.255.0 B(config-if-GigabitEthernet 0/1)# exit B(config)# router bgp 65536 B(config-router)# neighbor 10.1.1.3 remote-as 65536 B(config-router)# neighbor 10.1.1.3 update-source loopback 0</pre>
<p>C</p>	<pre>C# configure terminal</pre>

	<pre> C(config)# interface loopback 0 C(config-if-Loopback 0)# ip address 10.1.1.3 255.255.255.255 C(config-if-Loopback 0)# exit C(config)# interface GigabitEthernet 0/1 C(config-if-GigabitEthernet 0/1)# ip address 192.168.1.3 255.255.255.0 C(config-if-GigabitEthernet 0/1)# exit C(config)# interface GigabitEthernet 0/2 C(config-if-GigabitEthernet 0/2)# ip address 192.168.2.3 255.255.255.0 C(config-if-GigabitEthernet 0/2)# exit C(config)# interface GigabitEthernet 0/3 C(config-if-GigabitEthernet 0/3)# ip address 192.168.3.3 255.255.255.0 C(config-if-GigabitEthernet 0/3)# exit C(config)# router bgp 65536 C(config-router)# neighbor ibgp-group peer-group C(config-router)# neighbor ibgp-group remote-as 65536 C(config-router)# neighbor ibgp-group update-source loopback 0 C(config-router)# neighbor 10.1.1.1 peer-group ibgp-group C(config-router)# neighbor 10.1.1.2 peer-group ibgp-group C(config-router)# neighbor 192.168.3.4 remote-as 65537 </pre>
<p>D</p>	<pre> D# configure terminal D(config)# interface GigabitEthernet 0/1 D(config-if-GigabitEthernet 0/1)# ip address 192.168.3.4 255.255.255.0 D(config-if-GigabitEthernet 0/1)# exit D(config)# router bgp 65537 D(config-router)# neighbor 192.168.3.3 remote-as 65536 </pre>
<p>Verification</p>	<p>Run the show command to display the BGP neighbor status.</p>
<p>A</p>	<pre> A# show ip bgp neighbor BGP neighbor is 10.1.1.3, remote AS 65536, local AS 65536, internal link BGP version 4, remote router ID 10.1.1.3 BGP state = Established, up for 00:00:05 Last read , hold time is 180, keepalive interval is 60 seconds Neighbor capabilities: Route refresh: advertised and received (old and new) </pre>

	<pre> Four-octets ASN Capability: advertised and received Address family IPv4 Unicast: advertised and received Received 2 messages, 0 notifications, 0 in queue open message:1 update message:0 keepalive message:1 refresh message:0 dynamic cap:0 notifications:0 Sent 2 messages, 0 notifications, 0 in queue open message:1 update message:0 keepalive message:1 refresh message:0 dynamic cap:0 notifications:0 Route refresh request: received 0, sent 0 Minimum time between advertisement runs is 0 seconds Update source is Loopback 0 For address family: IPv4 Unicast BGP table version 1, neighbor version 1 Index 0, Offset 0, Mask 0x1 0 accepted prefixes 0 announced prefixes Connections established 1; dropped 0 Local host: 10.1.1.1, Local port: 1039 Foreign host: 10.1.1.3, Foreign port: 179 Nexthop: 10.1.1.1 Nexthop global: :: Nexthop local: :: BGP connection: non shared network Last Reset: , due to BGP Notification received Notification Error Message: (Cease/Other Configuration Change.) </pre>
<p>B</p>	<pre> B# show ip bgp neighbor BGP neighbor is 10.1.1.3, remote AS 65536, local AS 65536, internal link BGP version 4, remote router ID 10.1.1.3 BGP state = Established, up for 00:00:07 Last read , hold time is 180, keepalive interval is 60 seconds Neighbor capabilities: Route refresh: advertised and received (old and new) </pre>

	<pre> Four-octets ASN Capability: advertised and received Address family IPv4 Unicast: advertised and received Received 2 messages, 0 notifications, 0 in queue open message:1 update message:0 keepalive message:1 refresh message:0 dynamic cap:0 notifications:0 Sent 2 messages, 0 notifications, 0 in queue open message:1 update message:0 keepalive message:1 refresh message:0 dynamic cap:0 notifications:0 Route refresh request: received 0, sent 0 Minimum time between advertisement runs is 0 seconds Update source is Loopback 0 For address family: IPv4 Unicast BGP table version 1, neighbor version 1 Index 0, Offset 0, Mask 0x1 0 accepted prefixes 0 announced prefixes Connections established 1; dropped 0 Local host: 10.1.1.2, Local port: 1041 Foreign host: 10.1.1.3, Foreign port: 179 Nexthop: 10.1.1.2 Nexthop global: :: Nexthop local: :: BGP connection: non shared network Last Reset: , due to BGP Notification received Notification Error Message: (Cease/Other Configuration Change.) </pre>
<p>C</p>	<pre> C# show ip bgp neighbor BGP neighbor is 10.1.1.1, remote AS 65536, local AS 65536, internal link Member of peer-group ibgp-group for session parameters BGP version 4, remote router ID 10.1.1.1 BGP state = Established, up for 00:01:13 Last read , hold time is 180, keepalive interval is 60 seconds Neighbor capabilities: </pre>

```
Route refresh: advertised and received (old and new)
Four-octets ASN Capability: advertised and received
Address family IPv4 Unicast: advertised and received
Received 3 messages, 0 notifications, 0 in queue
  open message:1 update message:0 keepalive message:2
  refresh message:0 dynamic cap:0 notifications:0
Sent 3 messages, 0 notifications, 0 in queue
  open message:1 update message:0 keepalive message:2
  refresh message:0 dynamic cap:0 notifications:0
Route refresh request: received 0, sent 0
Minimum time between advertisement runs is 0 seconds
Update source is Loopback 0

For address family: IPv4 Unicast
  BGP table version 1, neighbor version 1
  Index 1, Offset 0, Mask 0x2
  ibgp-group peer-group member
  0 accepted prefixes
  0 announced prefixes

Connections established 1; dropped 0
Local host: 10.1.1.3, Local port: 179
Foreign host: 10.1.1.1, Foreign port: 1039
Nexthop: 10.1.1.3
Nexthop global: ::
Nexthop local: ::
BGP connection: non shared network

BGP neighbor is 10.1.1.2, remote AS 65536, local AS 65536, internal link
Member of peer-group ibgp-group for session parameters
  BGP version 4, remote router ID 10.1.1.2
  BGP state = Established, up for 00:01:17
  Last read          , hold time is 180, keepalive interval is 60 seconds
Neighbor capabilities:
```

Route refresh: advertised and received (old and new)
Four-octets ASN Capability: advertised and received
Address family IPv4 Unicast: advertised and received
Received 3 messages, 0 notifications, 0 in queue
open message:1 update message:0 keepalive message:2
refresh message:0 dynamic cap:0 notifications:0
Sent 3 messages, 0 notifications, 0 in queue
open message:1 update message:0 keepalive message:2
refresh message:0 dynamic cap:0 notifications:0
Route refresh request: received 0, sent 0
Minimum time between advertisement runs is 0 seconds
Update source is Loopback 0

For address family: IPv4 Unicast

BGP table version 1, neighbor version 1
Index 1, Offset 0, Mask 0x2
ibgp-group peer-group member
0 accepted prefixes
0 announced prefixes

Connections established 1; dropped 0

Local host: 10.1.1.3, Local port: 179

Foreign host: 10.1.1.2, Foreign port: 1041

Nexthop: 10.1.1.3

Nexthop global: ::

Nexthop local: ::

BGP connection: non shared network

BGP neighbor is 192.168.3.4, remote AS 65536, local AS 65536, internal link

Member of peer-group ibgp-group for session parameters

BGP version 4, remote router ID 192.168.3.4

BGP state = Established, up for 00:01:01

Last read , hold time is 180, keepalive interval is 60 seconds

Neighbor capabilities:

	<pre> Route refresh: advertised and received (old and new) Four-octets ASN Capability: advertised and received Address family IPv4 Unicast: advertised and received Received 3 messages, 0 notifications, 0 in queue open message:1 update message:0 keepalive message:2 refresh message:0 dynamic cap:0 notifications:0 Sent 3 messages, 0 notifications, 0 in queue open message:1 update message:0 keepalive message:2 refresh message:0 dynamic cap:0 notifications:0 Route refresh request: received 0, sent 0 Minimum time between advertisement runs is 0 seconds Update source is Loopback 0 For address family: IPv4 Unicast BGP table version 1, neighbor version 1 Index 1, Offset 0, Mask 0x2 ibgp-group peer-group member 0 accepted prefixes 0 announced prefixes Connections established 1; dropped 0 Local host: 192.168.3.3, Local port: 179 Foreign host: 192.168.3.4, Foreign port: 1018 Nexthop: 192.168.3.3 Nexthop global: :: Nexthop local: :: BGP connection: non shared network </pre>
<p>D</p>	<pre> D# show ip bgp neighbor BGP neighbor is 192.168.3.3, remote AS 65536, local AS 65536, internal link Member of peer-group ibgp-group for session parameters BGP version 4, remote router ID 10.1.1.3 BGP state = Established, up for 00:01:01 Last read , hold time is 180, keepalive interval is 60 seconds Neighbor capabilities: </pre>

<pre>Route refresh: advertised and received (old and new) Four-octets ASN Capability: advertised and received Address family IPv4 Unicast: advertised and received Received 3 messages, 0 notifications, 0 in queue open message:1 update message:0 keepalive message:2 refresh message:0 dynamic cap:0 notifications:0 Sent 3 messages, 0 notifications, 0 in queue open message:1 update message:0 keepalive message:2 refresh message:0 dynamic cap:0 notifications:0 Route refresh request: received 0, sent 0 Minimum time between advertisement runs is 0 seconds Update source is Loopback 0 For address family: IPv4 Unicast BGP table version 1, neighbor version 1 Index 1, Offset 0, Mask 0x2 ibgp-group peer-group member 0 accepted prefixes 0 announced prefixes Connections established 1; dropped 0 Local host: 192.168.3.4, Local port: 1018 Foreign host: 192.168.3.3, Foreign port: 179 Nexthop: 192.168.3.4 Nexthop global: :: Nexthop local: :: BGP connection: non shared network</pre>
--

Common Errors

- IGP is not enabled and the interconnection between the local loopback address and the loopback address on the IBGP neighbor fails, which causes that the neighbor fails to be created.
- ebgp-multihop is not configured when an EBGp is not directly connected, which causes that a TCP connection fails to be created.

7.4.2 Configuring MD5 Authentication

Configuration Effect

- Configure MD5 for encrypted authentication between EBGP and IBGP neighbors.

Notes

- If an IBGP neighbor is not directly connected, you need to configure IGP or a static routing protocol to implement interconnection.
- If an EBGP neighbor is not directly connected, you need to configure the **ebgp-multihop** parameter for the neighbor.

Configuration Steps

↘ Enabling BGP

- (Mandatory) Perform this configuration in the global configuration mode.

↘ Creating a BGP Neighbor

- (Mandatory) Perform this configuration in the BGP configuration mode.

Verification

- Run the **show** command to display the neighbor status.

Related Commands

↘ Enabling BGP

Command	router bgp <i>as-number</i> [instance <i>instance-name</i>]
Parameter Description	<i>as-number</i> : Indicates an AS number, ranging from 1 to 4,294,967,295, which is 1 to 65535.65535 in the dot mode. instance : The instance should be specified for the non-default instance, and the instance name is required. <i>instance-name</i> : Instance name of 1 to 32 characters.
Command Mode	Global configuration mode
Usage Guide	-

↘ Creating a BGP Neighbor

Command	neighbor { <i>neighbor-address</i> <i>peer-group-name</i> } remote-as <i>as-number</i>
Parameter Description	<i>neighbor-address</i> : Specifies the address of a peer. This address may be an IPv4 address or an IPv6 address. <i>peer-group-name</i> : Specifies the name of a peer group. <i>as-number</i> : Indicates the AS number of a BGP peer (group).
Command Mode	BGP configuration mode
Usage Guide	The AS specified for a peer (group) must be the same as the BGP AS number of a BGP speaker at the peer end.

↘ Configuring an MD5 Password for a BGP Neighbor

Command	neighbor { <i>neighbor-address</i> <i>peer-group-name</i> } password [0 7] <i>string</i>
----------------	--

Parameter Description	<p><i>neighbor-address</i>: Specifies the address of a peer. This address may be an IPv4 address or an IPv6 address.</p> <p><i>peer-group-name</i>: Specifies the name of a peer group.</p> <p>0: Displays a password not encrypted.</p> <p>7: Displays a password encrypted.</p> <p><i>string</i>: Indicates a password for TCP MD5 authentication, consisting of a maximum of 80 characters.</p>
Command Mode	BGP configuration mode
Usage Guide	The same passwords must be configured on the two ends of a BGP neighborhood.

Configuration Example

↘ **Configuring BGP MD5 Authentication**

<p>Scenario Figure 1-5</p>	
<p>Configuration Steps</p>	<ul style="list-style-type: none"> ● Enable BGP on all devices and set the AS numbers as shown in Figure 1-5. ● Configure a loopback interface on B and C and create an IBGP neighbor based on the loopback interface. ● Create an EBGP neighborhood by using the directly connected interfaces on A and B. ● Configure the passwords on A, B and C for their neighbors.
<p>A</p>	<pre>A# configure terminal A(config)# interface GigabitEthernet 0/1 A(config-if-GigabitEthernet 0/1)# ip address 192.168.1.1 255.255.255.0 A(config-if-GigabitEthernet 0/1)# exit A(config)# router bgp 65537 A(config-router)# neighbor 192.168.1.2 remote-as 65536 A(config-router)# neighbor 192.168.1.2 password 7 ebgpneighbor</pre>
<p>B</p>	<pre>B# configure terminal B(config)# interface loopback 0 B(config-if-Loopback 0)# ip address 10.1.1.1 255.255.255.255 B(config-if-Loopback 0)# exit B(config)# interface GigabitEthernet 0/1 B(config-if-GigabitEthernet 0/1)# ip address 192.168.1.2 255.255.255.0 B(config-if-GigabitEthernet 0/1)# exit</pre>

	<pre> B(config)# interface GigabitEthernet 0/2 B(config-if-GigabitEthernet 0/2)# ip address 192.168.2.2 255.255.255.0 B(config-if-GigabitEthernet 0/2)# exit B(config)# router bgp 65536 B(config-router)# neighbor 10.1.1.2 remote-as 65536 B(config-router)# neighbor 10.1.1.2 update-source loopback 0 B(config-router)# neighbor 10.1.1.2 password ibgpneighbor B(config-router)# neighbor 192.168.1.1 remote-as 65537 B(config-router)# neighbor 192.168.1.1 password 7 ebgpneighbor </pre>
<p>C</p>	<pre> C# configure terminal C(config)# interface loopback 0 C(config-if-Loopback 0)# ip address 10.1.1.2 255.255.255.255 C(config-if-Loopback 0)# exit C(config)# interface GigabitEthernet 0/1 C(config-if-GigabitEthernet 0/1)# ip address 192.168.2.3 255.255.255.0 C(config-if-GigabitEthernet 0/1)# exit C(config)# router bgp 65536 C(config-router)# neighbor 10.1.1.1 remote-as 65536 C(config-router)# neighbor 10.1.1.1 update-source loopback 0 C(config-router)# neighbor 10.1.1.1 password ibgpneighbor </pre>
<p>Verification</p>	<p>Run the show command to display the BGP neighbor status.</p>
<p>A</p>	<pre> A#show ip bgp neighbors BGP neighbor is 192.168.1.2, remote AS 65536, local AS 65537, external link BGP version 4, remote router ID 10.1.1.1 BGP state = Established, up for 00:04:54 Last read , hold time is 180, keepalive interval is 60 seconds Neighbor capabilities: Route refresh: advertised and received (old and new) Four-octets ASN Capability: advertised and received Address family IPv4 Unicast: advertised and received Received 7 messages, 0 notifications, 0 in queue open message:1 update message:0 keepalive message:6 refresh message:0 dynamic cap:0 notifications:0 </pre>

	<p>Sent 7 messages, 0 notifications, 0 in queue</p> <p>open message:1 update message:0 keepalive message:6</p> <p>refresh message:0 dynamic cap:0 notifications:0</p> <p>Route refresh request: received 0, sent 0</p> <p>Minimum time between advertisement runs is 30 seconds</p> <p>For address family: IPv4 Unicast</p> <p>BGP table version 1, neighbor version 0</p> <p>Index 1, Offset 0, Mask 0x2</p> <p>0 accepted prefixes</p> <p>0 announced prefixes</p> <p>Connections established 2; dropped 1</p> <p>Local host: 192.168.1.1, Local port: 1026</p> <p>Foreign host: 192.168.1.2, Foreign port: 179</p> <p>Nexthop: 192.168.1.1</p> <p>Nexthop global: ::</p> <p>Nexthop local: ::</p> <p>BGP connection: non shared network</p> <p>Last Reset: 00:04:54, due to BGP Notification sent</p> <p>Notification Error Message: (Cease/Administratively Reset.)</p>
<p>B</p>	<p>B# show ip bgp neighbors</p> <p>BGP neighbor is 10.1.1.2, remote AS 65536, local AS 65536, internal link</p> <p>BGP version 4, remote router ID 10.1.1.2</p> <p>BGP state = Established, up for 00:04:01</p> <p>Last read , hold time is 180, keepalive interval is 60 seconds</p> <p>Neighbor capabilities:</p> <p>Route refresh: advertised and received (old and new)</p> <p>Four-octets ASN Capability: advertised and received</p> <p>Address family IPv4 Unicast: advertised and received</p> <p>Received 8 messages, 0 notifications, 0 in queue</p> <p>open message:1 update message:0 keepalive message:7</p> <p>refresh message:0 dynamic cap:0 notifications:0</p> <p>Sent 8 messages, 0 notifications, 0 in queue</p>

```
open message:1 update message:0 keepalive message:7
refresh message:0 dynamic cap:0 notifications:0
Route refresh request: received 0, sent 0
Minimum time between advertisement runs is 30 seconds

For address family: IPv4 Unicast
BGP table version 1, neighbor version 0
Index 1, Offset 0, Mask 0x2
0 accepted prefixes
0 announced prefixes

Connections established 2; dropped 1
Local host: 10.1.1.1, Local port: 179
Foreign host: 10.1.1.2, Foreign port: 1038
Nexthop: 10.1.1.1
Nexthop global: ::
Nexthop local: ::
BGP connection: non shared network
Last Reset: 00:05:27, due to BGP Notification received
Notification Error Message: (Cease/Administratively Reset.)

BGP neighbor is 192.168.1.1, remote AS 65537, local AS 65536, external link
BGP version 4, remote router ID 192.168.1.1
BGP state = Established, up for 00:05:27
Last read          , hold time is 180, keepalive interval is 60 seconds
Neighbor capabilities:
Route refresh: advertised and received (old and new)
Four-octets ASN Capability: advertised and received
Address family IPv4 Unicast: advertised and received
Received 8 messages, 0 notifications, 0 in queue
open message:1 update message:0 keepalive message:7
refresh message:0 dynamic cap:0 notifications:0
Sent 8 messages, 0 notifications, 0 in queue
open message:1 update message:0 keepalive message:7
```

	<pre> refresh message:0 dynamic cap:0 notifications:0 Route refresh request: received 0, sent 0 Minimum time between advertisement runs is 30 seconds For address family: IPv4 Unicast BGP table version 1, neighbor version 0 Index 1, Offset 0, Mask 0x2 0 accepted prefixes 0 announced prefixes Connections established 2; dropped 1 Local host: 192.168.1.2, Local port: 179 Foreign host: 192.168.1.1, Foreign port: 1026 Nexthop: 192.168.1.2 Nexthop global: :: Nexthop local: :: BGP connection: non shared network Last Reset: 00:05:27, due to BGP Notification received Notification Error Message: (Cease/Administratively Reset.) </pre>
<p>C</p>	<pre> C# show ip bgp neighbors BGP neighbor is 10.1.1.1, remote AS 65536, local AS 65536, internal link BGP version 4, remote router ID 10.1.1.1 BGP state = Established, up for 00:04:01 Last read , hold time is 180, keepalive interval is 60 seconds Neighbor capabilities: Route refresh: advertised and received (old and new) Four-octets ASN Capability: advertised and received Address family IPv4 Unicast: advertised and received Received 8 messages, 0 notifications, 0 in queue open message:1 update message:0 keepalive message:7 refresh message:0 dynamic cap:0 notifications:0 Sent 8 messages, 0 notifications, 0 in queue open message:1 update message:0 keepalive message:7 refresh message:0 dynamic cap:0 notifications:0 </pre>

<p>Route refresh request: received 0, sent 0</p> <p>Minimum time between advertisement runs is 30 seconds</p> <p>For address family: IPv4 Unicast</p> <p>BGP table version 1, neighbor version 0</p> <p>Index 1, Offset 0, Mask 0x2</p> <p>0 accepted prefixes</p> <p>0 announced prefixes</p> <p>Connections established 2; dropped 1</p> <p>Local host: 10.1.1.2, Local port: 1038</p> <p>Foreign host: 10.1.1.1, Foreign port: 179</p> <p>Next hop: 10.1.1.2</p> <p>Next hop global: ::</p> <p>Next hop local: ::</p> <p>BGP connection: non shared network</p> <p>Last Reset: 00:05:27, due to BGP Notification received</p> <p>Notification Error Message: (Cease/Administratively Reset.)</p>

Common Errors

- The passwords for MD5 encrypted authentication at the two ends of a BGP neighborhood are different.

7.4.3 Configuring a Route Reflector

Configuration Effect

- Configure a route reflector in the IBGP environment to reduce the number of BGP neighbor connections.

Notes

- If an IBGP neighbor is not directly connected, you need to configure IGP or a static routing protocol to implement interconnection.

Configuration Steps

↘ Enabling BGP

- (Mandatory) Perform this configuration in the global configuration mode.

↘ Creating a BGP Neighbor

- (Mandatory) Perform this configuration in the BGP configuration mode.

↘ Creating a BGP Reflector

- (Mandatory) Perform this configuration in the BGP configuration mode.

Verification

- Run the **show** command to display the neighbor status.

Related Commands

↘ Enabling BGP

Command	router bgp <i>as-number</i> [instance <i>instance-name</i>]
Parameter Description	<i>as-number</i> : Indicates an AS number, ranging from 1 to 4,294,967,295, which is 1 to 65535.65535 in the dot mode. instance : The instance should be specified for the non-default instance, and the instance name is required. <i>instance-name</i> : Instance name of 1 to 32 characters.
Command Mode	Global configuration mode
Usage Guide	-

↘ Creating a BGP Neighbor

Command	neighbor { <i>neighbor-address</i> <i>peer-group-name</i> } remote-as <i>as-number</i>
Parameter Description	<i>neighbor-address</i> : Specifies the address of a peer. This address may be an IPv4 address or an IPv6 address. <i>peer-group-name</i> : Specifies the name of a peer group. <i>as-number</i> : Indicates the AS number of a BGP peer (group).
Command Mode	BGP configuration mode
Usage Guide	The AS specified for a peer (group) must be the same as the BGP AS number of a BGP speaker at the peer end.

↘ Creating a BGP Reflector

Command	neighbor { <i>neighbor-address</i> <i>peer-group-name</i> } route-reflector-client
Parameter Description	<i>neighbor-address</i> : Specifies the address of a peer. This address may be an IPv4 address or an IPv6 address. <i>peer-group-name</i> : Specifies the name of a peer group.
Command Mode	BGP configuration mode
Usage Guide	-

Configuration Example

↘ Configuring a BGP Route Reflector

<p>Scenario Figure 1-6</p>	
<p>Configuration Steps</p>	<ul style="list-style-type: none"> ● Enable BGP on all devices and set the AS numbers as shown in Figure 1-6. ● Configure a loopback interface on all devices and create an IBGP neighborhood by using the loopback interface according to the connection lines as shown in Figure 1-6. ● Configure route reflection on the device RR and specify A, B, C and D as reflector clients.
<p>A</p>	<pre> A# configure terminal A(config)# interface loopback 0 A(config-if-Loopback 0)# ip address 10.1.1.1 255.255.255.255 A(config-if-Loopback 0)# exit A(config)# interface GigabitEthernet 0/1 A(config-if-GigabitEthernet 0/1)# ip address 192.168.1.1 255.255.255.0 A(config-if-GigabitEthernet 0/1)# exit A(config)# router bgp 65536 A(config-router)# neighbor 10.1.1.5 remote-as 65536 A(config-router)# neighbor 10.1.1.5 update-source loopback 0 A(config-router)# network 192.168.1.0 mask 255.255.255.0 </pre>
<p>B</p>	<pre> B# configure terminal B(config)# interface loopback 0 B(config-if-Loopback 0)# ip address 10.1.1.2 255.255.255.255 B(config-if-Loopback 0)# exit B(config)# interface GigabitEthernet 0/1 B(config-if-GigabitEthernet 0/1)# ip address 192.168.2.2 255.255.255.0 B(config-if-GigabitEthernet 0/1)# exit B(config)# router bgp 65536 B(config-router)# neighbor 10.1.1.5 remote-as 65536 B(config-router)# neighbor 10.1.1.5 update-source loopback 0 </pre>

C	<pre>C# configure terminal C(config)# interface loopback 0 C(config-if-Loopback 0)# ip address 10.1.1.3 255.255.255.255 C(config-if-Loopback 0)# exit C(config)# interface GigabitEthernet 0/1 C(config-if-GigabitEthernet 0/1)# ip address 192.168.3.3 255.255.255.0 C(config-if-GigabitEthernet 0/1)# exit C(config)# router bgp 65536 C(config-router)# neighbor 10.1.1.5 remote-as 65536 C(config-router)# neighbor 10.1.1.5 update-source loopback 0</pre>
D	<pre>C# configure terminal C(config)# interface loopback 0 C(config-if-Loopback 0)# ip address 10.1.1.4 255.255.255.255 C(config-if-Loopback 0)# exit C(config)# interface GigabitEthernet 0/1 C(config-if-GigabitEthernet 0/1)# ip address 192.168.4.4 255.255.255.0 C(config-if-GigabitEthernet 0/1)# exit C(config)# router bgp 65536 C(config-router)# neighbor 10.1.1.5 remote-as 65536 C(config-router)# neighbor 10.1.1.5 update-source loopback 0</pre>
RR	<pre>RR# configure terminal RR(config)# interface loopback 0 RR(config-if-Loopback 0)# ip address 10.1.1.5 255.255.255.255 RR(config-if-Loopback 0)# exit RR(config)# interface GigabitEthernet 0/1 RR(config-if-GigabitEthernet 0/1)# ip address 192.168.1.5 255.255.255.0 RR(config-if-GigabitEthernet 0/1)# exit RR(config)# interface GigabitEthernet 0/2 RR(config-if-GigabitEthernet 0/2)# ip address 192.168.2.5 255.255.255.0 RR(config-if-GigabitEthernet 0/2)# exit RR(config)# interface GigabitEthernet 0/3 RR(config-if-GigabitEthernet 0/3)# ip address 192.168.3.5 255.255.255.0 RR(config-if-GigabitEthernet 0/3)# exit</pre>

	<pre>RR(config)# interface GigabitEthernet 0/4 RR(config-if-GigabitEthernet 0/4)# ip address 192.168.4.5 255.255.255.0 RR(config-if-GigabitEthernet 0/4)# exit RR(config)# router bgp 65536 RR(config-router)# neighbor 10.1.1.1 remote-as 65536 RR(config-router)# neighbor 10.1.1.1 update-source loopback 0 RR(config-router)# neighbor 10.1.1.1 route-reflector-client RR(config-router)# neighbor 10.1.1.2 remote-as 65536 RR(config-router)# neighbor 10.1.1.2 update-source loopback 0 RR(config-router)# neighbor 10.1.1.2 route-reflector-client RR(config-router)# neighbor 10.1.1.3 remote-as 65536 RR(config-router)# neighbor 10.1.1.3 update-source loopback 0 RR(config-router)# neighbor 10.1.1.3 route-reflector-client RR(config-router)# neighbor 10.1.1.4 remote-as 65536 RR(config-router)# neighbor 10.1.1.4 update-source loopback 0 RR(config-router)# neighbor 10.1.1.4 route-reflector-client</pre>
<p>Verification</p>	<p>Run the show command to display the BGP neighbor status.</p>
<p>RR</p>	<pre>RR# show ip bgp summary BGP router identifier 10.1.1.5, local AS number 65536 BGP table version is 1 0 BGP AS-PATH entries 0 BGP Community entries 1 BGP Prefix entries (Maximum-prefix:4294967295) Neighbor V AS MsgRcvd MsgSent TblVer InQ OutQ Up/Down State/PfxRcd 10.1.1.1 4 65536 8 9 1 0 0 00:05:11 1 10.1.1.2 4 65536 9 9 1 0 0 00:05:24 0 10.1.1.3 4 65536 8 7 1 0 0 00:05:10 0 10.1.1.4 4 65536 9 8 1 0 0 00:05:14 0 RR# show ip bgp BGP table version is 1, local router ID is 10.1.1.5 Status codes: s suppressed, d damped, h history, * valid, > best, i - internal,</pre>

	<p style="text-align: center;">S Stale, b - backup entry</p> <p>Origin codes: i - IGP, e - EGP, ? - incomplete</p> <table border="1"> <thead> <tr> <th>Network</th> <th>Next Hop</th> <th>Metric</th> <th>LocPrf</th> <th>Weight Path</th> </tr> </thead> <tbody> <tr> <td>*>i192.168.1.0</td> <td>10.1.1.1</td> <td>0</td> <td>100</td> <td>0 i</td> </tr> </tbody> </table> <p>Total number of prefixes 1</p>	Network	Next Hop	Metric	LocPrf	Weight Path	*>i192.168.1.0	10.1.1.1	0	100	0 i																		
Network	Next Hop	Metric	LocPrf	Weight Path																									
*>i192.168.1.0	10.1.1.1	0	100	0 i																									
<p>D</p>	<p>D# show ip bgp summary</p> <p>BGP router identifier 10.1.1.4, local AS number 65536</p> <p>BGP table version is 1</p> <p>0 BGP AS-PATH entries</p> <p>0 BGP Community entries</p> <p>1 BGP Prefix entries (Maximum-prefix:4294967295)</p> <table border="1"> <thead> <tr> <th>Neighbor</th> <th>V</th> <th>AS MsgRcvd</th> <th>MsgSent</th> <th>TblVer</th> <th>InQ</th> <th>OutQ</th> <th>Up/Down</th> <th>State/PfxRcd</th> </tr> </thead> <tbody> <tr> <td>10.1.1.5</td> <td>4</td> <td>65536</td> <td>8</td> <td>9</td> <td>1</td> <td>0</td> <td>00:05:20</td> <td>1</td> </tr> </tbody> </table> <p>D# show ip bgp</p> <p>BGP table version is 1, local router ID is 10.1.1.4</p> <p>Status codes: s suppressed, d damped, h history, * valid, > best, i - internal,</p> <p style="text-align: center;">S Stale, b - backup entry</p> <p>Origin codes: i - IGP, e - EGP, ? - incomplete</p> <table border="1"> <thead> <tr> <th>Network</th> <th>Next Hop</th> <th>Metric</th> <th>LocPrf</th> <th>Weight Path</th> </tr> </thead> <tbody> <tr> <td>* i192.168.1.0</td> <td>10.1.1.1</td> <td>0</td> <td>100</td> <td>0 i</td> </tr> </tbody> </table> <p>Total number of prefixes 1</p>	Neighbor	V	AS MsgRcvd	MsgSent	TblVer	InQ	OutQ	Up/Down	State/PfxRcd	10.1.1.5	4	65536	8	9	1	0	00:05:20	1	Network	Next Hop	Metric	LocPrf	Weight Path	* i192.168.1.0	10.1.1.1	0	100	0 i
Neighbor	V	AS MsgRcvd	MsgSent	TblVer	InQ	OutQ	Up/Down	State/PfxRcd																					
10.1.1.5	4	65536	8	9	1	0	00:05:20	1																					
Network	Next Hop	Metric	LocPrf	Weight Path																									
* i192.168.1.0	10.1.1.1	0	100	0 i																									

7.4.4 Configuring an AS Alliance

Configuration Effect

- Configure a BGP alliance to reduce the number of BGP neighbor connections.

Notes

- It is advised to use private AS numbers for sub ASs (also called member ASs) within an alliance. Private AS numbers range from 64,512 to 65,535.

- Within a sub AS of an alliance, full mesh must be established for all BGP speakers (route reflectors can be further configured within the sub AS).
- An EBGP neighborhood must be established between sub ASs of an alliance.
- All BGP speakers within an alliance must belong to a sub AS within the alliance.

Configuration Steps

↘ **Enabling BGP**

- (Mandatory) Perform this configuration in the global configuration mode.

↘ **Configuring a BGP Alliance ID**

- (Mandatory) Perform this configuration in the BGP configuration mode.

↘ **Configuring a BGP Alliance Member**

- (Mandatory) Perform this configuration in the BGP configuration mode.

↘ **Creating a BGP Neighbor**

- (Mandatory) Perform this configuration in the BGP configuration mode.

↘ **Configuring Multiple Hops for an EBGP Neighbor**

- Perform this configuration in the BGP configuration mode. It is mandatory when an EBGP neighbor is not directly connected.

↘ **Configuring BGP Route Re-distribution to a Network**

- (Optional) Perform this configuration in the BGP configuration mode. Perform this configuration when a local route needs to be advertised. You can also configure an alternative network by means of re-distribution.

Verification

- Run the **show** command to display the BGP neighbor status.
- Run the **show** command to display the BGP routing table information.

Related Commands

↘ **Enabling BGP**

Command	router bgp <i>as-number</i> [instance <i>instance-name</i>]
Parameter Description	<i>as-number</i> : Indicates an AS number, ranging from 1 to 4,294,967,295, which is 1 to 65535.65535 in the dot mode. instance : The instance should be specified for the non-default instance, and the instance name is required. <i>instance-name</i> : Instance name of 1 to 32 characters.
Command Mode	Global configuration mode
Usage Guide	-

↘ **Enabling a BGP Alliance ID**

Command	bgp confederation identifier <i>as-number</i>
Parameter	<i>as-number</i> : Indicates an AS number, ranging from 1 to 4,294,967,295, which is 1 to 65535.65535 in the dot mode.

Description	
Command	BGP configuration mode
Mode	
Usage Guide	-

↘ Configuring a BGP Alliance Member

Command	bgp confederation peers <i>as-number</i> [... <i>as-number</i>]
Parameter	<i>as-number</i> : Indicates an AS number, ranging from 1 to 4,294,967,295, which is 1 to 65535.65535 in the dot mode.
Description	
Command	BGP configuration mode
Mode	
Usage Guide	All member ASs of a local EBGp alliance must be identified.

↘ Creating a BGP Neighbor

Command	neighbor { <i>neighbor-address</i> <i>peer-group-name</i> } remote-as <i>as-number</i>
Parameter	<i>neighbor-address</i> : Specifies the address of a peer. This address may be an IPv4 address or an IPv6 address.
Description	<i>peer-group-name</i> : Specifies the name of a peer group. <i>as-number</i> : Indicates the AS number of a BGP peer (group).
Command	BGP configuration mode
Mode	
Usage Guide	The AS specified for a peer (group) must be the same as the BGP AS number of a BGP speaker at the peer end.

↘ Configuring Multiple Hops for an EBGp Neighbor

Command	neighbor { <i>neighbor-address</i> <i>peer-group-name</i> } ebgp-multihop [<i>tth</i>]
Parameter	<i>neighbor-address</i> : Specifies the address of a peer. This address may be an IPv4 address or an IPv6 address.
Description	<i>peer-group-name</i> : Specifies the name of a peer group. <i>tth</i> : Indicates the maximum number of hops that are allowed, ranging from 1 to 255.
Command	BGP configuration mode
Mode	
Usage Guide	The AS specified for a peer (group) must be the same as the BGP AS number of a BGP speaker at the peer end.

↘ Configuring BGP Route Re-distribution to a Network

Command	network <i>network-number</i> [<i>mask mask</i>] [route-map <i>map-tag</i>] [backdoor]
Parameter	<i>network-number</i> : Indicates the network address.
Description	<i>mask</i> : Indicates the subnet mask. <i>map-tag</i> : Indicates the name of a route map, consisting of no more than 32 characters. backdoor : Indicates that the route is a backdoor route.
Command	BGP configuration mode
Mode	
Usage Guide	The core routing table must contain same IGP (or static and directly connected) routes.

Configuration Example

↘ Configuring a BGP Alliance

<p>Scenario Figure 1-7</p>	
<p>Configuration Steps</p>	<ul style="list-style-type: none"> ● Configure BGP on A and B, set the AS number to 65,536 and configure an IBGP neighborship. ● Configure BGP on C and D, set the AS number to 65,537 and configure an IBGP neighborship. ● Configure BGP on ASBR1 and E, set the AS number to 65,538 and configure an IBGP neighborship. ● Configure an alliance ID 100 on A, B, C, D, E and ASBR1. ● Configure the alliance member 65,537 on A, configure C as an EBGP neighbor, and set the peer AS number to 65,537. ● Configure the alliance members 65,536 and 65,538 on C, configure A as an EBGP neighbor and set the peer AS number to 65,536, configure ASBR1 as an EBGP neighbor and set the peer AS number to 65,538. ● Configure the alliance members 65,537 on ASBR1, configure C as an EBGP neighbor and set the peer AS number to 65,537, configure ASBR2 as an EBGP neighbor and set the peer AS number to 200. ● Configure BGP on ASBR2 and set the AS number to 200; configure ASBR1 as an EBGP neighbor and set the peer AS number to 100.
<p>A</p>	<pre> A# configure terminal A(config)# interface loopback 0 A(config-if-Loopback 0)# ip address 10.1.1.1 255.255.255.255 A(config-if-Loopback 0)# exit A(config)# interface GigabitEthernet 0/1 A(config-if-GigabitEthernet 0/1)# ip address 192.168.1.1 255.255.255.0 A(config-if-GigabitEthernet 0/1)# exit A(config)# interface GigabitEthernet 0/2 A(config-if-GigabitEthernet 0/2)# ip address 192.168.2.1 255.255.255.0 A(config-if-GigabitEthernet 0/2)# exit A(config)# router bgp 65536 A(config-router)# bgp confederation identifier 100 A(config-router)# bgp confederation peers 65537 A(config-router)# neighbor 10.1.1.2 remote-as 65536 A(config-router)# neighbor 10.1.1.2 update-source loopback 0 A(config-router)# neighbor 10.1.1.3 remote-as 65537 </pre>

	<pre>A(config-router)# neighbor 10.1.1.3 ebgp-multihop 2 A(config-router)# neighbor 10.1.1.3 update-source loopback 0 A(config-router)# network 192.168.1.0 mask 255.255.255.0</pre>
B	<pre>B# configure terminal B(config)# interface loopback 0 B(config-if-Loopback 0)# ip address 10.1.1.2 255.255.255.255 B(config-if-Loopback 0)# exit B(config)# interface GigabitEthernet 0/1 B(config-if-GigabitEthernet 0/1)# ip address 192.168.1.2 255.255.255.0 B(config-if-GigabitEthernet 0/1)# exit B(config)# router bgp 65536 B(config-router)# neighbor 10.1.1.1 remote-as 65536 B(config-router)# neighbor 10.1.1.1 update-source loopback 0</pre>
C	<pre>C# configure terminal C(config)# interface loopback 0 C(config-if-Loopback 0)# ip address 10.1.1.3 255.255.255.255 C(config-if-Loopback 0)# exit C(config)# interface GigabitEthernet 0/1 C(config-if-GigabitEthernet 0/1)# ip address 192.168.3.3 255.255.255.0 C(config-if-GigabitEthernet 0/1)# exit C(config)# interface GigabitEthernet 0/2 C(config-if-GigabitEthernet 0/2)# ip address 192.168.2.3 255.255.255.0 C(config-if-GigabitEthernet 0/2)# exit C(config)# interface GigabitEthernet 0/3 C(config-if-GigabitEthernet 0/3)# ip address 192.168.4.3 255.255.255.0 C(config-if-GigabitEthernet 0/3)# exit C(config)# router bgp 65537 C(config-router)# bgp confederation identifier 100 C(config-router)# bgp confederation peers 65536 65538 C(config-router)# neighbor 10.1.1.1 remote-as 65536 C(config-router)# neighbor 10.1.1.1 update-source loopback 0 C(config-router)# neighbor 10.1.1.1 ebgp-multihop 2 C(config-router)# neighbor 10.1.1.4 remote-as 65537</pre>

	<pre>C(config-router)# neighbor 10.1.1.4 update-source loopback 0 C(config-router)# neighbor 10.1.1.5 remote-as 65538 C(config-router)# neighbor 10.1.1.5 update-source loopback 0 C(config-router)# neighbor 10.1.1.5 ebgp-multihop 2</pre>
D	<pre>D# configure terminal D(config)# interface loopback 0 D(config-if-Loopback 0)# ip address 10.1.1.4 255.255.255.255 D(config-if-Loopback 0)# exit D(config)# interface GigabitEthernet 0/1 D(config-if-GigabitEthernet 0/1)# ip address 192.168.3.4 255.255.255.0 D(config-if-GigabitEthernet 0/1)# exit D(config)# router bgp 65537 D(config-router)# neighbor 10.1.1.3 remote-as 65537 D(config-router)# neighbor 10.1.1.3 update-source loopback 0</pre>
E	<pre>E# configure terminal E(config)# interface loopback 0 E(config-if-Loopback 0)# ip address 10.1.1.6 255.255.255.255 E(config-if-Loopback 0)# exit E(config)# interface GigabitEthernet 0/1 E(config-if-GigabitEthernet 0/1)# ip address 192.168.5.6 255.255.255.0 E(config-if-GigabitEthernet 0/1)# exit E(config)# router bgp 65538 E(config-router)# neighbor 10.1.1.5 remote-as 65538 E(config-router)# neighbor 10.1.1.5 update-source loopback 0</pre>
ASBR1	<pre>ASBR1# configure terminal ASBR1(config)# interface loopback 0 ASBR1(config-if-Loopback 0)# ip address 10.1.1.5 255.255.255.255 ASBR1(config-if-Loopback 0)# exit ASBR1(config)# interface GigabitEthernet 0/1 ASBR1(config-if-GigabitEthernet 0/1)# ip address 192.168.5.5 255.255.255.0 ASBR1(config-if-GigabitEthernet 0/1)# exit ASBR1(config)# interface GigabitEthernet 0/2 ASBR1(config-if-GigabitEthernet 0/2)# ip address 192.168.6.5 255.255.255.0</pre>

	<pre>ASBR1(config-if-GigabitEthernet 0/2)# exit ASBR1(config)# interface GigabitEthernet 0/3 ASBR1(config-if-GigabitEthernet 0/3)# ip address 192.168.4.5 255.255.255.0 ASBR1(config-if-GigabitEthernet 0/3)# exit ASBR1(config)# router bgp 65538 ASBR1(config-router)# bgp confederation identifier 100 ASBR1(config-router)# bgp confederation peers 65537 ASBR1(config-router)# neighbor 10.1.1.3 remote-as 65537 ASBR1(config-router)# neighbor 10.1.1.3 update-source loopback 0 ASBR1(config-router)# neighbor 10.1.1.3 ebgp-multihop 2 ASBR1(config-router)# neighbor 10.1.1.6 remote-65538 ASBR1(config-router)# neighbor 10.1.1.6 update-source loopback 0 ASBR1(config-router)# neighbor 192.168.6.7 remote-as 200</pre>
<p>ASBR2</p>	<pre>ASBR2# configure terminal ASBR2(config)# interface GigabitEthernet 0/1 ASBR2(config-if-GigabitEthernet 0/1)# ip address 192.168.6.7 255.255.255.0 ASBR2(config-if-GigabitEthernet 0/1)# exit ASBR2(config)# router bgp 200 ASBR2(config-router)# neighbor 192.168.6.5 remote-as 100 ASBR2(config-router)# network 192.168.6.0 mask 255.255.255.0</pre>
<p>Verification</p>	<p>Run the show command to display the information.</p>
<p>A</p>	<pre>A# show ip bgp summary BGP router identifier 10.1.1.1, local AS number 65536 BGP table version is 1 1 BGP AS-PATH entries 0 BGP Community entries 1 BGP Prefix entries (Maximum-prefix:4294967295) Neighbor V AS MsgRcvd MsgSent TblVer InQ OutQ Up/Down State/PfxRcd 10.1.1.2 4 65536 3 3 1 0 00:00:05 0 10.1.1.3 4 65537 3 3 1 0 00:00:06 1 Total number of neighbors 1</pre>

	<pre> A# show ip bgp BGP table version is 1, local router ID is 10.1.1.1 Status codes: s suppressed, d damped, h history, * valid, > best, i - internal, S Stale, b - backup entry Origin codes: i - IGP, e - EGP, ? - incomplete Network Next Hop Metric LocPrf Weight Path * 192.168.6.0 192.168.6.7 0 100 0 (65537 65538) 200 i Total number of prefixes 1 </pre>
<p>ASBR1</p>	<pre> A# show ip bgp summary BGP router identifier 10.1.1.5, local AS number 200 BGP table version is 2 2 BGP AS-PATH entries 0 BGP Community entries 2 BGP Prefix entries (Maximum-prefix:4294967295) Neighbor V AS MsgRcvd MsgSent TblVer InQ OutQ Up/Down State/PfxRcd 10.1.1.3 4 65537 3 3 2 0 0 00:00:10 1 10.1.1.6 4 65538 3 3 2 0 0 00:00:08 0 192.168.6.7 4 200 3 3 2 0 0 00:00:05 1 Total number of neighbors 1 A# show ip bgp BGP table version is 1, local router ID is 10.1.1.1 Status codes: s suppressed, d damped, h history, * valid, > best, i - internal, S Stale, b - backup entry Origin codes: i - IGP, e - EGP, ? - incomplete Network Next Hop Metric LocPrf Weight Path * 192.168.1.0 10.1.1.1 0 100 0 (65537 65536) i *> 192.168.6.0 192.168.6.7 0 100 0 200 i </pre>

	<p>Total number of prefixes 1</p>
<p>ASBR2</p>	<pre> A# show ip bgp summary BGP router identifier 192.168.6.7, local AS number 200 BGP table version is 1 1 BGP AS-PATH entries 0 BGP Community entries 1 BGP Prefix entries (Maximum-prefix:4294967295) Neighbor V AS MsgRcvd MsgSent TblVer InQ OutQ Up/Down State/PfxRcd 192.168.6.5 4 100 3 3 1 0 0 00:00:05 1 Total number of neighbors 1 A# show ip bgp BGP table version is 1, local router ID is 10.1.1.1 Status codes: s suppressed, d damped, h history, * valid, > best, i - internal, S Stale, b - backup entry Origin codes: i - IGP, e - EGP, ? - incomplete Network Next Hop Metric LocPrf Weight Path *> 192.168.1.0 192.168.6.5 0 100 0 (65537 65538) 200 i Total number of prefixes 1 </pre>

Common Errors

- No BGP alliance neighbor is configured.
- Full mesh is not established within sub ASs of an alliance.

7.4.5 Configuring Multi-path Load Balancing of BGP

Configuration Effect

- Implement multi-path load balancing for IBGP routes.
- Support AS-PATH loose comparison.

Notes

- Routes learned from an IBGP neighbor must have the same priority (the router-ID does not need to be compared).

Configuration Steps

↘ **Enabling BGP**

- (Mandatory) Perform this configuration in the global configuration mode.

↘ **Creating a BGP Neighbor**

- (Mandatory) Perform this configuration in the BGP configuration mode.

↘ **Configuring BGP Load Balancing**

- (Mandatory) Perform this configuration in the BGP configuration mode.

↘ **Configuring AS-PATH Loose Comparison**

- (Optional) Perform this configuration in the BGP configuration mode. Perform this configuration when load balancing needs to be implemented for routes learned from different ASs.

Verification

- Run the **show** command to display BGP routing information.
- Run the **show** command to display the core routing table information.

Related Commands

↘ **Enabling BGP**

Command	router bgp <i>as-number</i> [instance <i>instance-name</i>]
Parameter Description	<i>as-number</i> : Indicates an AS number, ranging from 1 to 4,294,967,295, which is 1 to 65535.65535 in the dot mode. instance : The instance should be specified for the non-default instance, and the instance name is required. <i>instance-name</i> : Instance name of 1 to 32 characters.
Command Mode	Global configuration mode
Usage Guide	-

↘ **Creating a BGP Neighbor**

Command	neighbor { <i>neighbor-address</i> <i>peer-group-name</i> } remote-as <i>as-number</i>
Parameter Description	<i>neighbor-address</i> : Specifies the address of a peer. This address may be an IPv4 address or an IPv6 address. <i>peer-group-name</i> : Specifies the name of a peer group. <i>as-number</i> : Indicates the AS number of a BGP peer (group).
Command Mode	BGP configuration mode
Usage Guide	The AS specified for a peer (group) must be the same as the BGP AS number of a BGP speaker at the peer end.

↘ **Configuring BGP Load Balancing**

Command	maximum-paths { ebgp ibgp } <i>number</i>
----------------	--

Parameter Description	<i>number</i> : Indicates the maximum number of equivalent paths, ranging from 1 to device capacity. If the value is 1, multi-path load balancing of IBGP will be disabled.
Command Mode	BGP configuration mode
Usage Guide	-

↘ **Configuring AS-PATH Loose Comparison**

Command	bgp bestpath as-path multipath-relax
Parameter Description	-
Command Mode	BGP configuration mode
Usage Guide	-

Configuration Example

↘ **Configuring Multi-path Load Balancing of IBGP**

<p>Scenario Figure 1- 8</p>	
<p>Configuration Steps</p>	<ul style="list-style-type: none"> ● Enable BGP on all devices and set the AS numbers as shown in Figure 1- 8. ● Establish IBGP neighborships between A and B and between A and C by using directly connected interfaces. ● Establish EBGP neighborships between B and D and between C and E by using directly connected interfaces. ● Re-distribute the same routes to D and E. ● Configure IBGP load balancing on A and enable the AS-PATH loose comparison mode.
<p>A</p>	<pre>A# conf terminal A(config)# interface fastEthernet 0/0 A(config-if-FastEthernet 0/0)# ip address 10.1.1.1 255.255.0.0</pre>

	<pre> A(config-if-FastEthernet 0/0)# exit A(config)# interface fastEthernet 0/1 A(config-if-FastEthernet 0/1)# ip address 10.2.1.1 255.255.0.0 A(config-if-FastEthernet 0/1)# exit A(config)# ip route 10.3.0.0 255.255.0.0 10.1.1.2 A(config)# ip route 10.4.0.0 255.255.0.0 10.2.1.2 A(config)# router bgp 65530 A(config-router)# neighbor 10.1.1.2 remote-as 65530 A(config-router)# neighbor 10.2.1.2 remote-as 65530 A(config-router)# bgp maximum-paths ibgp 2 A(config-router)# bgp bestpath as-path multipath-relax </pre>
B	<pre> B# conf terminal B(config)# interface fastEthernet 0/0 B(config-if-FastEthernet 0/0)# ip address 10.1.1.2 255.255.0.0 B(config-if-FastEthernet 0/0)# exit B(config)# interface fastEthernet 0/1 B(config-if-FastEthernet 0/1)# ip address 10.3.1.2 255.255.0.0 B(config-if-FastEthernet 0/1)# exit B(config)# router bgp 65530 B(config-router)# neighbor 10.1.1.1 remote-as 65530 B(config-router)# neighbor 10.3.1.1 remote-as 65531 </pre>
C	<pre> C# conf terminal C(config)# interface fastEthernet 0/0 C(config-if-FastEthernet 0/0)# ip address 10.2.1.2 255.255.0.0 C(config-if-FastEthernet 0/0)# exit C(config)# interface fastEthernet 0/1 C(config-if-FastEthernet 0/1)# ip address 10.4.1.2 255.255.0.0 C(config-if-FastEthernet 0/1)# exit C(config)# router bgp 65530 C(config-router)# neighbor 10.2.1.1 remote-as 65530 C(config-router)# neighbor 10.4.1.1 remote-as 65532 </pre>
D	<pre> D# conf terminal D(config)# interface fastEthernet 0/0 </pre>

	<pre>D(config-if-FastEthernet 0/0)# ip address 10.3.1.1 255.255.0.0 D(config-if-FastEthernet 0/0)# exit D(config)# interface loopback 1 D(config-if)#ip address 10.5.1.1 255.255.0.0 D(config-if-FastEthernet 0/1)# exit D(config)# router bgp 65531 D(config-router)# neighbor 10.3.1.2 remote-as 65530 D(config-router)# redistribute connected</pre>
<p>E</p>	<pre>E# conf terminal E(config)# interface fastEthernet 0/0 E(config-if-FastEthernet 0/0)# ip address 10.4.1.1 255.255.0.0 E(config-if-FastEthernet 0/0)# exit E(config)# interface loopback 1 E(config-if)#ip address 10.5.1.2 255.255.0.0 E(config-if-FastEthernet 0/1)# exit E(config)# router bgp 65532 E(config-router)# neighbor 10.4.1.2 remote-as 65530 E(config-router)# redistribute connected</pre>
<p>Verification</p>	<p>Run the show command to display the information.</p>
<p>A</p>	<pre>A# show ip bgp summary BGP router identifier 10.2.1.1, local AS number 65530 BGP table version is 9 2 BGP AS-PATH entries 0 BGP Community entries 3 BGP Prefix entries (Maximum-prefix:4294967295) Neighbor V AS MsgRcvd MsgSent TblVer InQ OutQ Up/Down State/PfxRcd 172.16.23.140 4 65530 29 25 8 0 0 00:18:48 2 172.16.23.141 4 65530 24 21 8 0 0 00:17:58 2 A# show ip bgp BGP table version is 9, local router ID is 10.2.1.1 Status codes: s suppressed, d damped, h history, * valid, > best, i - internal,</pre>

```

S Stale
Origin codes: i - IGP, e - EGP, ? - incomplete

Network          Next Hop          Metric    LocPrf    Weight Path
*>i10.3.0.0/16    10.3.1.1          0         100       0 65531 ?
*>i10.4.0.0/16    10.4.1.1          0         100       0 65532 ?
* i10.5.0.0/16    10.3.1.1          0         100       0 65531 ?
*>i               10.4.1.1          0         100       0 65532 ?

Total number of prefixes 3
A# show ip bgp 10.5.0.0
BGP routing table entry for 10.5.0.0/16
Paths: (2 available, best #1, table Default-IP-Routing-Table)

    Not advertised to any peer

    65532
        10.4.1.1 from 10.2.1.2 (172.16.24.1)
            Origin incomplete, metric 0, localpref 100, valid, internal, multipath, best
            Last update: Mon Mar 21 03:45:14 2011

    65531
        10.3.1.1 from 10.1.1.2 (172.16.25.1)
            Origin incomplete, metric 0, localpref 100, valid, internal, multipath
            Last update: Mon Mar 21 03:45:14 2011

A# show ip route

Codes:  C - connected, S - static, R - RIP, B - BGP
        O - OSPF, IA - OSPF inter area
        N1 - OSPF NSSA external type 1, N2 - OSPF NSSA external type 2
        E1 - OSPF external type 1, E2 - OSPF external type 2
        i - IS-IS, su - IS-IS summary, L1 - IS-IS level-1, L2 - IS-IS level-2
        ia - IS-IS inter area, * - candidate default

Gateway of last resort is no set
    
```

	C 10.1.0.0/16 is directly connected, FastEthernet 0/0
	C 10.1.1.1/32 is local host.
	C 10.2.0.0/16 is directly connected, FastEthernet 0/1
	C 10.2.1.1/32 is local host.
	S 10.3.0.0/16 [1/0] via 10.1.1.2
	S 10.4.0.0/16 [1/0] via 10.2.1.2
	B 10.5.0.0/16 [200/0] via 10.3.1.1, 00:27:56 [200/0] via 10.4.1.1, 00:27:56

Common Errors

- The priorities of multi-hop BGP routes are different, which causes load balancing failure.

7.4.6 Configuring EBGPFRR

Configuration Effect

- Implement EBGPFRR.

Notes

- (Optional) Configure a neighbor BFD session to implement fast link fault detection.

Configuration Steps

↘ **Enabling BGP**

- (Mandatory) Perform this configuration in the global configuration mode.

↘ **Creating a BGP Neighbor**

- (Mandatory) Perform this configuration in the BGP configuration mode.

↘ **Configuring BGP FRR**

- (Mandatory) Perform this configuration in the BGP configuration mode.

↘ **Configuring a Neighbor BFD Session**

- (Optional) Perform this configuration in the BGP configuration mode.

Verification

- Run the **show** command to display routing information.

Related Commands

↘ **Enabling BGP**

Command	router bgp <i>as-number</i> [instance <i>instance-name</i>]
Parameter	<i>as-number</i> : Indicates an AS number, ranging from 1 to 4,294,967,295, which is 1 to 65535.65535 in the dot mode.
Description	instance : The instance should be specified for the non-default instance, and the instance name is required.

	<i>instance-name</i> : Instance name of 1 to 32 characters.
Command	Global configuration mode
Mode	
Usage Guide	-

↘ **Configuring BGP FRR**

Command	bgp fast-reroute
Parameter	-
Description	
Command	BGP configuration mode
Mode	
Usage Guide	-

↘ **Creating a BGP Neighbor**

Command	neighbor { <i>neighbor-address</i> <i>peer-group-name</i> } remote-as <i>as-number</i>
Parameter	<i>neighbor-address</i> : Specifies the address of a peer. This address may be an IPv4 address or an IPv6 address.
Description	<i>peer-group-name</i> : Specifies the name of a peer group. <i>as-number</i> : Indicates the AS number of a BGP peer (group).
Command	BGP configuration mode
Mode	
Usage Guide	The AS specified for a peer (group) must be the same as the BGP AS number of a BGP speaker at the peer end.

↘ **Creating a BFD Session to a BGP Neighbor**

Command	neighbor { <i>neighbor-address</i> <i>peer-group-name</i> } fall-over bfd
Parameter	<i>neighbor-address</i> : Specifies the address of a peer. This address may be an IPv4 address or an IPv6 address.
Description	<i>peer-group-name</i> : Specifies the name of a peer group.
Command	BGP configuration mode
Mode	
Usage Guide	-

Configuration Example

↘ **Configuring EBGPFRR**

Scenario Figure 1-9	
Configuration	<ul style="list-style-type: none"> ● Enable BGP on all devices.

Steps	<ul style="list-style-type: none"> ● Configure the addresses of the directly connected interfaces on A, B and C to establish EBGp neighborships. ● Configure a BFD session for the EBGp neighborship between B and C. ● Configure FRR on C.
A	<pre> A# conf terminal A(config)# interface GigabitEthernet 0/1 A(config-if-GigabitEthernet 0/1)# ip address 192.168.1.1 255.255.255.0 A(config-if-GigabitEthernet 0/1)# exit A(config)# interface GigabitEthernet 0/2 A(config-if-GigabitEthernet 0/2)# ip address 192.168.2.1 255.255.255.0 A(config-if-GigabitEthernet 0/2)# exit A(config)# router bgp 100 A(config-router)# neighbor 192.168.1.2 remote-as 300 A(config-router)# neighbor 192.168.2.2 remote-as 200 A(config-router)# redistribute connect </pre>
B	<pre> B# configure terminal B(config)# interface GigabitEthernet 0/1 B(config-if-GigabitEthernet 0/1)# ip address 192.168.3.1 255.255.255.0 B(config-if-GigabitEthernet 0/1)# bfd interval 200 min_rx 200 multiplier 5 B(config-if-GigabitEthernet 0/1)# exit B(config)# interface GigabitEthernet 0/2 B(config-if-GigabitEthernet 0/2)# ip address 192.168.2.2 255.255.255.0 B(config-if-GigabitEthernet 0/2)# exit B(config)# router bgp 200 B(config-router)# neighbor 192.168.3.2 remote-as 300 B(config-router)# neighbor 192.168.3.2 fall-over bfd B(config-router)# neighbor 192.168.2.1 remote-as 100 B(config-router)# redistribute connect </pre>
C	<pre> C# configure terminal C(config)# interface GigabitEthernet 0/1 C(config-if-GigabitEthernet 0/1)# ip address 192.168.1.2 255.255.255.0 C(config-if-GigabitEthernet 0/1)# exit C(config)# interface fastEthernet 0/2 C(config-if-GigabitEthernet 0/2)# ip address 192.168.3.2 255.255.0.0 C(config-if-GigabitEthernet 0/2)# bfd interval 200 min_rx 200 multiplier 5 </pre>

```
C(config-if-GigabitEthernet 0/2)# exit
C(config)# router bgp 300
C(config-router)# neighbor 192.168.1.1 remote-as 100
C(config-router)# neighbor 192.168.3.1 remote-as 200
C(config-router)# neighbor 192.168.3.1 fall-over bfd
C(config-router)# address-family ipv4 unicast
C(config-router-af)# bgp fast-reroute
C(config-router-af)# redistribute connect
```

Verification Run the **show** command to display the information.

```
C
C# show ip bgp summary
BGP router identifier 10.10.10.10, local AS number 300
BGP table version is 12
4 BGP AS-PATH entries
0 BGP Community entries
3 BGP Prefix entries (Maximum-prefix:4294967295)

Neighbor      V      AS MsgRcvd MsgSent  TblVer  InQ OutQ Up/Down  State/PfxRcd
192.168.1.1   4      100    76    77     12    12   0 00:59:27    3
192.168.3.1   4      200    30    30     12    12   0 00:19:03    3

Total number of neighbors 2

C# show ip bgp
BGP table version is 12, local router ID is 10.10.10.10
Status codes: s suppressed, d damped, h history, * valid, > best, i - internal,
               S Stale, b - backup entry
Origin codes: i - IGP, e - EGP, ? - incomplete

Network      Next Hop      Metric    LocPrf    Weight Path
* 192.168.1.0 192.168.3.1    0         0 200 ?
*              192.168.1.1    0         0 100 ?
*>            0.0.0.0        0         32768 ?
*> 192.168.2.0 192.168.3.1    0         0 200 ?
```



```

*b          192.168.1.1          0          0 100 ?
* 192.168.3.0 192.168.3.1          0          0 200 ?
*          192.168.1.1          0          0 100 200 ?
*>         0.0.0.0              0          32768   ?

Total number of prefixes 3
C# show ip bgp 192.168.2.0
BGP routing table entry for 192.168.2.0/24
Paths: (2 available, best #1, table Default-IP-Routing-Table)
  Advertised to non peer-group peers:
    192.168.1.1
    200
    192.168.3.1 from 192.168.3.1 (3.3.3.3)
      Origin incomplete, metric 0, localpref 100, valid, external, best
      Last update: Tue Oct  5 00:26:52 1971

    100
    192.168.1.1 from 192.168.1.1 (44.44.44.44)
      Origin incomplete, metric 0, localpref 100, valid, external, backup
      Last update: Mon Oct  4 23:46:28 1971
C# show ip route

Codes: C - connected, S - static, R - RIP, B - BGP
        O - OSPF, IA - OSPF inter area
        N1 - OSPF NSSA external type 1, N2 - OSPF NSSA external type 2
        E1 - OSPF external type 1, E2 - OSPF external type 2
        i - IS-IS, su - IS-IS summary, L1 - IS-IS level-1, L2 - IS-IS level-2
        ia - IS-IS inter area, * - candidate default

Gateway of last resort is no set

C   192.168.1.0/24 is directly connected, GigabitEthernet 1/9
C   192.168.1.2/32 is local host.
B   192.168.2.0/24 [20/0] via 192.168.3.1, 00:21:39
C   192.168.3.0/24 is directly connected, GigabitEthernet 1/11
    
```

```
C 192.168.3.2/32 is local host.
```

Common Errors

- No BFD session is configured for BGP neighbors.

7.4.7 Configuring Fast Withdrawal of Specified BGP Routes

Configuration Effect

- Implement fast withdrawal of specified BGP routes.

Notes

- Configure fast withdrawal of specified routes to preferentially advertise the withdrawal of specified routes.

Configuration Steps

↘ **Enabling BGP**

- (Mandatory) Perform this configuration in global configuration mode.

↘ **Creating a BGP Neighbor**

- (Mandatory) Perform this configuration in BGP configuration mode.

↘ **Configuring Fast Withdrawal of Specified BGP Routes**

- (Mandatory) Perform this configuration in BGP configuration mode.

Verification

- Run the **show** command to display the configurations.

Related Commands

↘ **Enabling BGP**

Command	router bgp <i>as-number</i> [instance <i>instance-name</i>]
Parameter Description	<i>as-number</i> : Indicates an AS number. The value ranges from 1 to 4,294,967,295, which is 1 to 65535.65535 in dot mode. instance : The instance should be specified for the non-default instance, and the instance name is required. <i>instance-name</i> : Instance name of 1 to 32 characters.
Command Mode	Global configuration mode
Usage Guide	N/A

↘ **Configuring Fast Withdrawal of Specified BGP Routes**

Command	bgp fast-withdraw { access-list { <i>access-list-number</i> <i>access-list-name</i> } prefix-list <i>prefix-list-name</i> route-map <i>map-tag</i> }
Parameter Description	<i>access-list-number</i> : Indicates the ACL number. The value ranges from 1 to 199 and 1300 to 2699. <i>access-list-name</i> : Indicates an ACL name. <i>prefix-list-name</i> : Indicates the name of a prefix list. <i>map-tag</i> : Indicates the name of a route map.

Command Mode	BGP configuration mode
Usage Guide	N/A

↘ **Creating a BGP Neighbor**

Command	neighbor { <i>neighbor-address</i> <i>peer-group-name</i> } remote-as <i>as-number</i>
Parameter Description	<i>neighbor-address</i> : Specifies the address of a peer. This address may be an IPv4 address or an IPv6 address. <i>peer-group-name</i> : Specifies the name of a peer group. <i>as-number</i> : Indicates the AS number of a BGP peer (group). The value ranges from 1 to 4,294,967,295 .
Command Mode	BGP configuration mode
Usage Guide	The AS number specified for a peer (group) must be the same as the BGP AS number of a BGP speaker at the peer end.

Configuration Example

↘ **Configuring Fast Withdrawal of Specified BGP Routes**

Scenario Figure 1- 10	<p>The diagram shows two routers, Router A and Router B, connected by a line. Router A is on the left and is associated with AS 65530. Router B is on the right and is associated with AS 65531. Each router is represented by a blue cube with a white cross on its top face, and a cloud-like shape behind it.</p>
Configuration Steps	<ul style="list-style-type: none"> ● Enable BGP on all devices. ● Establish a BGP neighbor relationship between Routers A and B. ● Configure ACLs on Router A. ● Configure fast withdrawal of specified routes on Router A.
A	A# conf terminal
Verification	Run the show command to display the configurations.
A	A#show run router bgp

7.4.8Configuring Local ASs

Configuration Effect

- Smoothly migrate the network configurations of router A from AS 23 to AS 3600.

Notes

N/A

Configuration Steps

↘ **Enabling BGP**

- (Mandatory) Perform this configuration in the global configuration mode.

↘ Creating a BGP Neighbor

- (Mandatory) Perform this configuration in the BGP configuration mode.

↘ Configuring the Local AS for a BGP Neighbor

- (Mandatory) Perform this configuration in the BGP configuration mode.

Verification

- Run the **show** command to display the information.

Related Commands

↘ Enabling BGP

Command	router bgp <i>as-number</i> [instance <i>instance-name</i>]
Parameter	<i>as-number</i> : Indicates an AS number, ranging from 1 to 4,294,967,295, which is 1 to 65535.65535 in the dot mode.
Description	instance : The instance should be specified for the non-default instance, and the instance name is required. <i>instance-name</i> : Instance name of 1 to 32 characters.
Command Mode	Global configuration mode
Usage Guide	-

↘ Creating a BGP Neighbor

Command	neighbor { <i>neighbor-address</i> <i>peer-group-name</i> } remote-as <i>as-number</i>
Parameter	<i>neighbor-address</i> : Specifies the address of a peer. This address may be an IPv4 address or an IPv6 address.
Description	<i>peer-group-name</i> : Specifies the name of a peer group. <i>as-number</i> : Indicates the AS number of a BGP peer (group).
Command Mode	BGP configuration mode
Usage Guide	The AS specified for a peer (group) must be the same as the BGP AS number of a BGP speaker at the peer end.

↘ Configuring the Local AS for a BGP Neighbor

Command	neighbor { <i>neighbor-address</i> <i>peer-group-name</i> } local-as <i>as-number</i> [no-prepend [replace-as [dual-as]]]
Parameter	<i>neighbor-address</i> : Specifies the address of a peer. This address may be an IPv4 address or an IPv6 address.
Description	<i>peer-group-name</i> : Specifies the name of a peer group. <i>as-number</i> : Indicates a local AS number, ranging from 1 to 4,294,967,295, which is 1 to 65535.65535 in the dot mode. no-prepend : Does not add the local AS to the AS-PATH in the routing information received by a peer. This option is not available by default. replace-as : For the AS-PATH in the routing information sent by a peer, the local AS is used to replace the BGP AS. This option is not available by default. dual-as : Enables a peer to use the BGP AS or Local AS to establish a BGP connection with a device. This option is not available by default.
Command Mode	BGP configuration mode
Usage Guide	-

Configuration Example

▾ **Configuring BGP Local-AS**

<p>Scenario Figure 1- 12</p>	
<p>Configuration Steps</p>	<ul style="list-style-type: none"> ● Create an EBGP neighborhood with B on A and specify the Local-AS for the EBGP neighborhood. ● Create an EBGP neighborhood for connecting to A on B.
<p>A</p>	<pre>A# configure terminal A(config)# router bgp 3600 A(config-router)# neighbor 57.50.1.1 remote-as 5750 A(config-router)# neighbor 57.50.1.1 update-source loopback 0 A(config-router)# neighbor 57.50.1.1 ebgp-multihop 255 A(config-router)# neighbor 57.50.1.1 local-as 23 no-prepend replace-as dual-as</pre>
<p>B</p>	<pre>B# configure terminal B(config)# router bgp 5750 B(config-router)# neighbor 36.0.1.1 remote-as 23 B(config-router)# neighbor 36.0.1.1 update-source loopback 0 B(config-router)# neighbor 36.0.1.1 ebgp-multihop 255</pre>
<p>Verification</p>	<p>Run the show command to display the BGP neighbor status.</p>
<p>A</p>	<pre>A# show ip bgp neighbors 57.50.1.1 BGP neighbor is 57.50.1.1, remote AS 5750, local AS 23(using Peer's Local AS, no-prepend, replace-as, dual-as), external link BGP version 4, remote router ID 0.0.0.0 BGP state = Idle</pre>

```

Last read, hold time is 180, keepalive interval is 60 seconds

Received 0 messages, 0 notifications, 0 in queue
    open message:0 update message:0 keepalive message:0
    refresh message:0 dynamic cap:0 notifications:0

Sent 0 messages, 0 notifications, 0 in queue
    
```

7.4.9Configuring BGP GR

Configuration Effect

- Configure BGP GR to implement network deployment with high reliability.

Notes

- To successfully deploy the BGP GR function, you need to use a neighbor device as the GR Helper.
- In an BGP environment, you also need to configure IGP GR.
- After BGP GR is enabled, you need to reset a BGP neighbor connection to make it take effect.

Configuration Steps

↘ Enabling BGP

- (Mandatory) Perform this configuration in the global configuration mode.

↘ Configuring BGP GR

- Perform this configuration in the BGP configuration mode, which is configured by default.

↘ Configuring a BGP GR Timer

- (Optional) Perform this configuration in the BGP configuration mode.

↘ Creating a BGP Neighbor

- (Mandatory) Perform this configuration in the BGP configuration mode.

Verification

- Run the **show** command to display the neighbor status.

Related Commands

↘ Enabling BGP

Command	router bgp <i>as-number</i> [instance <i>instance-name</i>]
Parameter Description	<i>as-number</i> : Indicates an AS number, ranging from 1 to 4,294,967,295, which is 1 to 65535.65535 in the dot mode. instance : The instance should be specified for the non-default instance, and the instance name is required. <i>instance-name</i> : Instance name of 1 to 32 characters.
Command Mode	Global configuration mode
Usage Guide	-

↘ **Configuring BGP GR**

Command	bgp graceful-restart
Parameter	-
Description	
Command Mode	BGP configuration mode
Usage Guide	-

↘ **Configuring the BGP GR Restart Timer**

Command	bgp graceful-restart restart-time <i>restart-time</i>
Parameter Description	<i>restart-time</i> : Indicates the maximum waiting time that the GR Restarter hopes the GR Helper to wait before a new connection is created, ranging from 1 to 3600 seconds.
Command Mode	BGP configuration mode
Usage Guide	-

↘ **Configuring the BGP GR Route Stale Timer**

Command	bgp graceful-restart stalepath-time <i>time</i>
Parameter Description	<i>time</i> : Indicates the maximum time that a stale route keeps valid after the connection with a neighbor GR device is recovered, ranging from 1 to 3600 seconds.
Command Mode	BGP configuration mode
Usage Guide	-

↘ **Creating a BGP Neighbor**

Command	neighbor { <i>neighbor-address</i> <i>peer-group-name</i> } remote-as <i>as-number</i>
Parameter Description	<i>neighbor-address</i> : Specifies the address of a peer. This address may be an IPv4 address or an IPv6 address. <i>peer-group-name</i> : Specifies the name of a peer group. <i>as-number</i> : Indicates the AS number of a BGP peer (group).
Command Mode	BGP configuration mode
Usage Guide	The AS specified for a peer (group) must be the same as the BGP AS number of a BGP speaker at the peer end.

Configuration Example

↘ **Configuring BGP GR**

<p>Scenario Figure 1- 13</p>	
<p>Configuration Steps</p>	<ul style="list-style-type: none"> ● Enable BGP on all devices and set the AS numbers as shown in Figure 1- 13. ● Configure a loopback interface on R2, R3, and R4 and create an IBGP neighborship based on the loopback interface. ● Create an EBGP neighborship by using the directly connected interfaces on R1 and R2. ● Enable BGP GR on R1, R2, R3, and R4.
<p>R1</p>	<pre>R1# configure terminal R1(config-router)# exit R1(config)# router bgp 100 R1(config-router)# bgp graceful-restart</pre>
<p>R2</p>	<pre>R2# configure terminal R2(config)# router ospf 1 R2(config-router)# graceful-restart R2(config-router)# exit R2(config)# router bgp 100 R2(config-router)# bgp graceful-restart</pre>
<p>R3</p>	<pre>R3# configure terminal R3(config)# router ospf 1 R3(config-router)# graceful-restart R3(config-router)# exit R3(config)# router bgp 100 R3(config-router)# bgp graceful-restart</pre>
<p>R4</p>	<pre>R4# configure terminal</pre>

	<pre>R4(config)# router ospf 1 R4(config-router)# graceful-restart R4(config-router)# exit R4(config)# router bgp 100 R4(config-router)# bgp graceful-restart</pre>
Verification	Run the show command to display the BGP neighbor status.
R2	<pre>R2# show ip ospf Routing Process "ospf 1" with ID 10.0.0.2 Process uptime is 4 minutes Process bound to VRF default Conforms to RFC2328, and RFC1583Compatibility flag is enabled Supports only single TOS(TOS0) routes Supports opaque LSA This router is an ASBR (injecting external routing information) SPF schedule delay 5 secs, Hold time between two SPFs 10 secs LsaGroupPacing: 240 secs Number of incoming current DD exchange neighbors 0/5 Number of outgoing current DD exchange neighbors 0/5 Number of external LSA 4. Checksum 0x0278E0 Number of opaque AS LSA 0. Checksum 0x000000 Number of non-default external LSA 4 External LSA database is unlimited. Number of LSA originated 6 Number of LSA received 2 Log Neighbor Adjacency Changes : Enabled Graceful-restart enabled Graceful-restart helper support enabled Number of areas attached to this router: 1 Area 0 (BACKBONE) R2# show ip bgp neighbors BGP neighbor is 192.168.195.183, remote AS 200, local AS 100, external link</pre>

```

Using BFD to detect fast fallover - BFD session state up

  BGP version 4, remote router ID 10.0.0.1

  BGP state = Established, up for 00:06:37

  Last read 00:06:37, hold time is 180, keepalive interval is 60 seconds

  Neighbor capabilities:

    Route refresh: advertised and received (old and new)

  Address family IPv4 Unicast: advertised and received

  Graceful restart: advertised and received

  Remote Restart timer is 120 seconds

  Address families preserved by peer:

    None

.....

```

Common Errors

- GR is not enabled for IGP.
- GR is not enabled for a BGP neighbor device.

7.4.10 Configuring a BGP IPv6 Address Family

Configuration Effect

- Configure BGP IPv6 routes to implement IPv6 network access in different ASs.

Notes

- Generally, BGP uses IPv6 addresses to create neighborships and implement exchange of IPv6 routes.
- In special scenarios (such as the 6PE function, see the MPLS-L3VPN-SCG.doc), BGP supports exchange of IPv6 routes on the neighbors with IPv4 addresses.
- Configurations related to BGP IPv6 services must be configured in the BGP IPv6 address family mode.

Configuration Steps

↘ Enabling BGP

- (Mandatory) Perform this configuration in the global configuration mode.

↘ Creating a BGP Neighbor

- (Mandatory) Perform this configuration in the BGP configuration mode.

↘ Configuring the BGP IPv4 Address Family Mode

- (Optional) Perform this configuration in the BGP configuration mode.

↘ Disabling the IPv4 Address Family Capability for a BGP Neighbor

- (Optional) Perform this configuration in the BGP IPv6 configuration mode.

↘ **Configuring the BGP IPv6 Address Family Mode**

- (Mandatory) Perform this configuration in the BGP configuration mode.

↘ **Configuring the IPv6 Address Family Capability for a BGP Neighbor**

- (Mandatory) Perform this configuration in the BGP IPv6 configuration mode.

↘ **Configuring IPv6 Route Advertisement in BGP**

- (Optional) Perform this configuration in the BGP IPv6 configuration mode.

Verification

- Run the **show** command to display the neighbor status.
- Run the **show** command to display the routing status.

Related Commands

↘ **Enabling BGP**

Command	router bgp <i>as-number</i> [instance <i>instance-name</i>]
Parameter	<i>as-number</i> : Indicates an AS number, ranging from 1 to 4,294,967,295, which is 1 to 65535.65535 in the dot mode.
Description	instance : The instance should be specified for the non-default instance, and the instance name is required. <i>instance-name</i> : Instance name of 1 to 32 characters.
Command	Global configuration mode
Mode	
Usage Guide	-

↘ **Creating a BGP Neighbor**

Command	neighbor { <i>neighbor-address</i> <i>peer-group-name</i> } remote-as <i>as-number</i>
Parameter	<i>neighbor-address</i> : Indicates the address of a peer, which is usually an IPv6 address.
Description	<i>peer-group-name</i> : Specifies the name of a peer group. <i>as-number</i> : Indicates the AS number of a BGP peer (group).
Command	BGP configuration mode
Mode	
Usage Guide	The AS specified for a peer (group) must be the same as the BGP AS number of a BGP speaker at the peer end.

↘ **Configuring the BGP IPv4 Address Family Mode**

Command	address-family ipv4 unicast
Parameter	-
Description	
Command	BGP configuration mode
Mode	
Usage Guide	-

↘ **Disabling the IPv4 Address Family Capability for a BGP Neighbor**

Command	no neighbor { <i>neighbor-address</i> <i>peer-group-name</i> } activate { ipv4 ipv6 }
Parameter	<i>neighbor-address</i> : Indicates the address of a peer, which is usually an IPv6 address.
Description	<i>peer-group-name</i> : Specifies the name of a peer group. ipv4: Activate only IPv4 neighbors in the peer group ipv6: Activate only IPv6 neighbors in the peer group
Command Mode	BGP IPv4 address family mode
Usage Guide	Neighbors with IPv6 addresses are used to exchange IPv6 routes. However, when a neighbor is configured in the BGP mode, BGP automatically activates the IPv4 unicast address family capability for the neighbor. Therefore, you are advised to manually disable the IPv4 unicast address family capability.

↘ Configuring the BGP IPv6 Address Family Mode

Command	address-family ipv6 unicast
Parameter	-
Description	
Command Mode	BGP configuration mode
Usage Guide	-

↘ Configuring the IPv6 Address Family Capability for a BGP Neighbor

Command	neighbor { <i>neighbor-address</i> <i>peer-group-name</i> } activate { ipv4 ipv6 }
Parameter	<i>neighbor-address</i> : Indicates the address of a peer, which is usually an IPv6 address.
Description	<i>peer-group-name</i> : Specifies the name of a peer group. ipv4: Activate only IPv4 neighbors in the peer group ipv6: Activate only IPv6 neighbors in the peer group
Command Mode	BGP IPv6 address family mode
Usage Guide	-

↘ Configuring IPv6 Route Advertisement in BGP

Command	network <i>network-number</i> [mask <i>mask</i>] [route-map <i>map-tag</i>] [backdoor]
Parameter	<i>network-number</i> : Indicates the network number.
Description	<i>mask</i> : Indicates the subnet mask. <i>map-tag</i> : Indicates the name of a route map, consisting of no more than 32 characters. backdoor : Indicates that the route is a backdoor route.
Command Mode	BGP IPv6 address family mode
Usage Guide	-

Configuration Example

↘ Configuring BGP to Implement IPv6 Route Exchange in Different ASs

<p>Scenario Figure 1- 14</p>	
<p>Configuration Steps</p>	<ul style="list-style-type: none"> ● Enable BGP on all devices and set the AS numbers as shown in Figure 1- 14. ● Configure a BGP neighbor, disable the IPv4 address family capability for the neighbor and activate the IPv6 address family capability. ● Configure IPv6 route advertisement in BGP.
<p>A</p>	<pre>A# configure terminal A(config)# int loopback 0 A(config-if-Loopback)# ipv6 address 30::1/128 A(config-if-Loopback)# exit A(config)# router bgp 65530 A(config-router)# neighbor 100::1 remote-as 65531 A(config-router)# address-family ipv4 A(config-router-af)# no neighbor 100::1 activate A(config-router-af)# exit-address-family A(config-router)# address-family ipv6 A(config-router-af)# neighbor 100::1 activate A(config-router-af)# network 30::1/128</pre>
<p>B</p>	<pre>B# configure terminal B(config)# router bgp 65531 B(config-router)# neighbor 100::2 remote-as 65530 B(config-router)# address-family ipv4 B(config-router-af)# no neighbor 100::2 activate B(config-router-af)# exit-address-family B(config-router)# address-family ipv6 B(config-router-af)# neighbor 100::2 activate</pre>
<p>Verification</p>	<p>Run the show command to display the BGP neighbor status.</p>
<p>A</p>	<pre>A# show bgp ipv6 unicast summary BGP router identifier 1.1.1.1, local AS number 65530 BGP table version is 1 1 BGP AS-PATH entries</pre>

	<p>0 BGP Community entries</p> <p>1 BGP Prefix entries (Maximum-prefix:4294967295)</p> <pre> Neighbor V AS MsgRcvd MsgSent TblVer InQ OutQ Up/Down State/PfxRcd 100::1 4 65531 4 6 1 0 0 00:01:49 0 </pre> <p>Total number of neighbors 1</p>
B	<p>Run the show command to display BGP routing information.</p> <pre> B# show bgp ipv6 unicast BGP table version is 4, local router ID is 2.2.2.2 Status codes: s suppressed, d damped, h history, * valid, > best, i - internal, S Stale, b - backup entry Origin codes: i - IGP, e - EGP, ? - incomplete Network Next Hop Metric LocPrf Weight Path *> 30::1/128 100::2 0 0 65530 i </pre> <p>Total number of prefixes 1</p>

Common Errors

- The IPv6 address family capability is not activated for BGP neighbors.
- In non-6PE scenarios, IPv4 addresses are used to establish IPv6 routes for exchange between neighbors.

7.4.11 Configuring a BGP EVPN

Configuration Effect

- Configure BGP protocol to use RR in the VXLAN scenario for L2VPN EVPN deployment.

Notes

- By default, the BGP routing mode is located in the IPv4 unicast address family and a BGP EVPN must be configured in L2VPN EVPN address family mode.

Configuration Steps

➤ **Enabling BGP**

- (Mandatory) Perform this configuration in global configuration mode.

➤ **Creating a BGP Neighbor**

- (Mandatory) Perform this configuration in BGP configuration mode.

➤ **Activating the EVPN Capability for a BGP Neighbor**

- (Mandatory) Perform this configuration in BGP L2VPN EVPN address family mode.

➤ **Creating an EVI Instance**

- (Mandatory) Perform this configuration in EVPN configuration mode.

➤ **Creating EVI Instances in Batch**

- (Optional) Perform this configuration in EVPN configuration mode.

➤ **Creating RD**

- (Mandatory) Perform this configuration in EVPN-VNI configuration mode.

➤ **Creating Route Target**

- (Mandatory) Perform this configuration in EVPN-VNI configuration mode.

➤ **Configuring Route Map for EVI Instance**

- (Optional) Perform this configuration in EVPN-VNI address family mode.

➤ **Configuring MAC Mobility Parameters**

- (Optional) Perform this configuration in BGP L2VPN EVPN configuration mode.

Verification

- Run the **show** command to display the information.

Related Commands

➤ **Enabling BGP**

Command	router bgp <i>as-number</i> [instance <i>instance-name</i>]
Parameter Description	<i>as-number</i> : Indicates an AS number, ranging from 1 to 4,294,967,295, which is 1 to 65535.65535 in dot mode. instance : The instance should be specified for the non-default instance, and the instance name is required. <i>instance-name</i> : Instance name of 1 to 32 characters.
Command Mode	Global configuration mode
Usage Guide	-

➤ **Creating a BGP Neighbor**

Command	neighbor { <i>neighbor-address</i> <i>peer-group-name</i> } remote-as <i>as-number</i>
Parameter Description	<i>neighbor-address</i> : Specifies the address of a peer. This address may be an IPv4 address or an IPv6 address. <i>peer-group-name</i> : Specifies the name of a peer group, consisting of no more than 32 characters. <i>as-number</i> : Indicates the AS number of a BGP peer (group).

Command Mode	BGP configuration mode
Usage Guide	The AS specified for a peer (group) must be the same as the BGP AS number of a BGP speaker at the peer end.

↘ Entering the L2VPN EVPN Address Family

Command	address-family l2vpn evpn
Parameter Description	-
Command Mode	BGP configuration mode
Usage Guide	-

↘ Activating the EVPN Capability for a BGP Neighbor

Command	neighbor { neighbor-address peer-group-name } activate { ipv4 ipv6 }
Parameter Description	<p><i>neighbor-address</i>: Specifies the address of a peer. This address must be an IPv4 address.</p> <p><i>peer-group-name</i>: Specifies the name of a peer group, consisting of no more than 32 characters.</p> <p>ipv4: Activate only IPv4 neighbors in the peer group</p> <p>ipv6: Activate only IPv6 neighbors in the peer group</p>
Command Mode	BGP L2VPN EVPN address family mode
Usage Guide	-

↘ Creating an EVI Instance

Command	vni vni-id
Parameter Description	<i>vni-id</i> : indicates the VNI ID. Ranges from 1 to 16777215.
Command Mode	EVPN configuration mode
Usage Guide	After VNI configuration is completed, related RD/RT needs to be configured.

↘ Creating EVI Instances in Batches



Command	vni range vni-id-list
Parameter Description	<i>vni-id-list</i> : Specifies the name of a VNI ID list.
Command Mode	EVPN configuration mode
Usage Guide	<p>The configuration fails if the number of configured VNI instances exceeds the capacity or a VNI instance is being deleted.</p> <p>The RD values of different VNI instances must be different. Therefore, only the automatic RD configuration mode is available for configuring VNI instances in batches, and VNI instances cannot be configured manually.</p>

↘ **Configuring an RD**

Command	<code>rd { auto rd_value }</code>
Parameter	auto: Generates an RD value automatically.
Description	<p>rd_value: Specifies the value of an RD.</p> <p>The parameter <i>rd_value</i> has three forms:</p> <p>(1) <code>rd_value = as_num:nn</code> as_num indicates the 2-byte public AS number. nn is user-defined and ranges from 0 to 4294967295.</p> <p>(2) <code>rd_value = ip_addr:nn</code> ip_add refers to the global IP address. nn is user-defined and ranges from 0 to 65535.</p> <p>(3) <code>rd_value = as4_num:nn</code> as4_num indicates the 4-byte public AS number. nn is user-defined and ranges from 1 to 65535. The 4-byte AS number ranges from 1 to 4294967295, which is 1 to 65535.65535 in dot mode.</p>
Command Mode	EVPN VNI configuration mode
Usage Guide	<p>If an EVI is defined and has an RD value configured, the RD value cannot be modified. To modify it, you need to delete the EVI first, and then define the EVI again and configure a new RD value for it.</p> <p>One EVI has only one RD value.</p> <ul style="list-style-type: none"> The RD value of the 4-byte AS is in the format of AS4:NN. AS4 can be expressed in decimal or dot mode. AS4 ranges from 1 to 4294967295, which is 1 to 65535.65535 in dot mode. NN ranges from 1 to 65535. The AS number in the range of 1 to 65535 is displayed the same in both decimal mode and dot mode. Therefore, save the AS number in the range of 1 to 65535 as a 2-byte AS number.

↘ **Configuring a Route Target**

Command	<code>route-target { import export both } { auto rt_value }</code>
Parameter	import: Specifies the import RT value.
Description	<p>export: Specifies the export RT value.</p> <p>both: Specifies the import and export RT values.</p> <p>auto: Generates an RT value automatically.</p> <p>rt_value: Specifies the value of an RT.</p> <p>The parameter <i>rt_value</i> has three forms:</p> <p>(1) <code>rt_value = as_num:nn</code> as_num indicates the 2-byte public AS number. nn is user-defined and ranges from 0 to 4294967295.</p> <p>(2) <code>rt_value = ip_addr:nn</code> ip_add refers to the global IP address. nn is user-defined and ranges from 0 to 65535.</p> <p>(3) <code>rt_value = as4_num:nn</code> as4_num indicates the 4-byte public AS number. nn is user-defined and ranges from 1 to 65535. The 4-byte AS number ranges from 1 to 4294967295, which is 1 to 65535.65535 in dot mode.</p>
Command Mode	EVPN VNI configuration mode
Usage Guide	<p>One EVI supports multiple import and export RT values.</p> <ul style="list-style-type: none"> The automatically generated RT value is in the format of AS2:nn. AS2 indicates the 2-byte AS number. If a 4-byte AS number is used, it is split, and a two 2-byte part is filled in the position for nn while the other 2-byte part is filled in

	<p>the position for the RT value. nn indicates the VNI ID. There are four bytes of space provided for accommodating the 3-byte VNI ID.</p> <ul style="list-style-type: none">  If the BGP AS number changes, the automatically-generated RT value will also be changed.  If the manually configured RT value is consistent with the automatically generated one, both of them are displayed. If the automatically generated RT value is 100:1, it is directly deleted. Deleting this value does not cancel the auto configuration mode. To cancel the auto configuration mode, run the no form of the route-target auto command.
--	---

↘ Configuring a Route Map for EVI Instances

Command	export map <i>routemap-name</i>
Parameter Description	<i>routemap-name</i> : Specifies the name of a route map.
Command Mode	EVPN VNI configuration mode
Usage Guide	<p>This command is used to modify the extended community attribute advertised by a type 5 route converted from a local EVPN route or IP route.</p> <p>This command supports only one route map, and the old configuration is overwritten by the new configuration.</p>

Command	import map <i>routemap-name</i>
Parameter Description	<i>routemap-name</i> : Specifies the name of a route map.
Command Mode	EVPN VNI configuration mode
Usage Guide	<p>This command is used to filter the remote EVPN routes to be imported to the local VNI instance, or modify the attribute of the remote EVPN routes imported to the local VNI instance.</p> <p>This command supports only one route map, and the old configuration is overwritten by the new configuration.</p>

↘ Configuring MAC Mobility Parameters

Command	bgp mac-mobility <i>timer count</i>
Parameter Description	<p><i>timer</i>: Specifies the timer duration (in seconds) for MAC mobility detection. If a number of <i>count</i> MAC address moves are detected within the duration, it is considered that a MAC conflict occurs and syslogs are displayed to warn users. The value is 180 by default and ranges from 1 to 3600.</p> <p><i>count</i>: Specifies the detection times. The value is 5 by default and ranges from 1 to 360.</p>
Command Mode	BGP L2VPN EVPN address family mode
Usage Guide	One MAC address may move for many times. When a MAC address move is detected by a PE through local learning, a timer of <i>timer</i> seconds (default value = 180s) will be enabled. If a number of <i>count</i> (default value = 5) MAC address moves are detected before the timer times out, it is considered that a MAC conflict occurs.

Configuration Example

↘ Configuring a BGP EVPN Address Family

<p>Scenario Figure 7-14</p>	
<p>Configuration Steps</p>	<ul style="list-style-type: none"> ● Enable BGP on all devices and set the AS numbers as shown in Figure 1-14. ● Configure BGP neighborships as shown in Figure 1-14. ● Activate the L2VPN EVPN address family capability for BGP neighbors.
<p>A</p>	<pre> A# config terminal A(config)# interface gigabitEthernet 0/1 A(config-GigabitEthernet 0/1)# no shutdown A(config-GigabitEthernet 0/1)# ip address 172.18.2.1 255.255.255.0 A(config-GigabitEthernet 0/1)# exit A(config)# interface gigabitEthernet 0/2 A(config-GigabitEthernet 0/1)# no shutdown A(config-GigabitEthernet 0/1)# ip address 172.18.1.1 255.255.255.0 A(config-GigabitEthernet 0/1)# exit A(config)# router bgp 100 A(config-router)# neighbor 172.18.2.3 remote-as 100 A(config-router)# neighbor 172.18.1.2 remote-as 100 A(config-router)# address-family l2vpn evpn A(config-router-af)# neighbor 172.18.2.3 activate A(config-router-af)# neighbor 172.18.1.2 activate A(config-router-af)# neighbor 172.18.2.3 route-reflector-client A(config-router-af)# neighbor 172.18.1.2 route-reflector-client A(config-router-af)# exit-address-family </pre>

<p>B</p>	<pre> B# config terminal B(config)# evpn B(config-evpn)# vni 100 B(config-evpn-vni)# rd auto B(config-evpn-vni)# route-target both auto B(config-evpn-vni)# exit B(config-evpn)# exit B(config)# interface gigabitEthernet 0/1 B(config-GigabitEthernet 0/1)# no shutdown B(config-GigabitEthernet 0/1)# ip address 172.18.2.3 255.255.255.0 B(config-GigabitEthernet 0/1)# exit B(config)# router bgp 100 B(config-router)# neighbor 172.18.2.1 remote-as 100 B(config-router)# address-family l2vpn evpn B(config-router-af)# neighbor 172.18.2.1 activate B(config-router-af)# exit-address-family </pre>
<p>C</p>	<p>The same as that for B.</p>
<p>Verification</p>	<p>Run the show command to display the information.</p>
<p>A</p>	<pre> A#sh bgp l2vpn evpn all summary For address family: L2VPN EVPN BGP router identifier 3.3.3.3, local AS number 100 BGP table version is 51 1 BGP AS-PATH entries 0 BGP Community entries 6 BGP Prefix entries (Maximum-prefix:4294967295) Neighbor V AS MsgRcvd MsgSent TblVer InQ OutQ Up/Down State/PfxRcd 172.18.2.3 4 100 1993 2033 49 0 0 1d04h40m 3 172.18.1.2 4 100 619 623 51 0 0 08:47:26 3 Total number of neighbors 2 A#sh bgp l2vpn evpn all BGP table version is 51, local router ID is 3.3.3.3 Status codes: s suppressed, d damped, h history, * valid, > best, i - internal, S Stale, b - backup entry </pre>

	<p>Origin codes: i - IGP, e - EGP, ? - incomplete</p> <table border="1"> <thead> <tr> <th>Network</th> <th>Next Hop</th> <th>Metric</th> <th>LocPrf</th> <th>Weight</th> <th>Path</th> </tr> </thead> <tbody> <tr> <td colspan="6">Route Distinguisher: 1.1.1.1:100</td> </tr> <tr> <td colspan="6">*>i2:0:48:0011.2233.2016:0:0.0.0/128</td> </tr> <tr> <td></td> <td>1.1.1.1</td> <td>0</td> <td>100</td> <td>0</td> <td>i</td> </tr> <tr> <td colspan="6">*>i2:0:48:0011.2233.2016:32:100.1.1.2/128</td> </tr> <tr> <td></td> <td>1.1.1.1</td> <td>0</td> <td>100</td> <td>0</td> <td>i</td> </tr> <tr> <td colspan="6">*>i3:0:32:1.1.1.1/72</td> </tr> <tr> <td>1.1.1.1</td> <td>1.1.1.1</td> <td>0</td> <td>100</td> <td>0</td> <td>i</td> </tr> <tr> <td colspan="6">Total number of prefixes 3</td> </tr> <tr> <td colspan="6">Route Distinguisher: 2.2.2.2:100</td> </tr> <tr> <td colspan="6">*>i2:0:48:00d0.f822.33df:0:0.0.0.0/128</td> </tr> <tr> <td></td> <td>2.2.2.2</td> <td>0</td> <td>100</td> <td>0</td> <td>i</td> </tr> <tr> <td colspan="6">*>i2:0:48:00d0.f822.33df:32:100.1.1.1/128</td> </tr> <tr> <td></td> <td>2.2.2.2</td> <td>0</td> <td>100</td> <td>0</td> <td>i</td> </tr> <tr> <td colspan="6">*>i3:0:32:2.2.2.2/72</td> </tr> <tr> <td>2.2.2.2</td> <td>2.2.2.2</td> <td>0</td> <td>100</td> <td>0</td> <td>i</td> </tr> <tr> <td colspan="6">Total number of prefixes 3</td> </tr> </tbody> </table>	Network	Next Hop	Metric	LocPrf	Weight	Path	Route Distinguisher: 1.1.1.1:100						*>i2:0:48:0011.2233.2016:0:0.0.0/128							1.1.1.1	0	100	0	i	*>i2:0:48:0011.2233.2016:32:100.1.1.2/128							1.1.1.1	0	100	0	i	*>i3:0:32:1.1.1.1/72						1.1.1.1	1.1.1.1	0	100	0	i	Total number of prefixes 3						Route Distinguisher: 2.2.2.2:100						*>i2:0:48:00d0.f822.33df:0:0.0.0.0/128							2.2.2.2	0	100	0	i	*>i2:0:48:00d0.f822.33df:32:100.1.1.1/128							2.2.2.2	0	100	0	i	*>i3:0:32:2.2.2.2/72						2.2.2.2	2.2.2.2	0	100	0	i	Total number of prefixes 3					
Network	Next Hop	Metric	LocPrf	Weight	Path																																																																																																		
Route Distinguisher: 1.1.1.1:100																																																																																																							
*>i2:0:48:0011.2233.2016:0:0.0.0/128																																																																																																							
	1.1.1.1	0	100	0	i																																																																																																		
*>i2:0:48:0011.2233.2016:32:100.1.1.2/128																																																																																																							
	1.1.1.1	0	100	0	i																																																																																																		
*>i3:0:32:1.1.1.1/72																																																																																																							
1.1.1.1	1.1.1.1	0	100	0	i																																																																																																		
Total number of prefixes 3																																																																																																							
Route Distinguisher: 2.2.2.2:100																																																																																																							
*>i2:0:48:00d0.f822.33df:0:0.0.0.0/128																																																																																																							
	2.2.2.2	0	100	0	i																																																																																																		
*>i2:0:48:00d0.f822.33df:32:100.1.1.1/128																																																																																																							
	2.2.2.2	0	100	0	i																																																																																																		
*>i3:0:32:2.2.2.2/72																																																																																																							
2.2.2.2	2.2.2.2	0	100	0	i																																																																																																		
Total number of prefixes 3																																																																																																							
<p>B</p>	<p>B#sh bgp l2vpn evpn all summary</p> <p>For address family: L2VPN EVPN</p> <p>BGP router identifier 1.1.1.1, local AS number 100</p> <p>BGP table version is 16</p> <p>1 BGP AS-PATH entries</p> <p>0 BGP Community entries</p> <p>6 BGP Prefix entries (Maximum-prefix:4294967295)</p> <table border="1"> <thead> <tr> <th>Neighbor</th> <th>V</th> <th>AS</th> <th>MsgRcvd</th> <th>MsgSent</th> <th>TblVer</th> <th>InQ</th> <th>OutQ</th> <th>Up/Down</th> <th>State/PfxRcd</th> </tr> </thead> <tbody> <tr> <td>172.18.2.1</td> <td>4</td> <td>100</td> <td>639</td> <td>625</td> <td>16</td> <td>0</td> <td>0</td> <td>08:55:10</td> <td>3</td> </tr> </tbody> </table> <p>Total number of neighbors 1</p> <p>B#sh bgp l2vpn evpn all</p> <p>BGP table version is 16, local router ID is 1.1.1.1</p> <p>Status codes: s suppressed, d damped, h history, * valid, > best, i - internal, S Stale, b - backup entry</p> <p>Origin codes: i - IGP, e - EGP, ? - incomplete</p> <table border="1"> <thead> <tr> <th>Network</th> <th>Next Hop</th> <th>Metric</th> <th>LocPrf</th> <th>Weight</th> <th>Path</th> </tr> </thead> <tbody> <tr> <td colspan="6">Route Distinguisher: 1.1.1.1:100 (Default for EVI 100)</td> </tr> <tr> <td colspan="6">*> 2:0:48:0011.2233.2016:0:0.0.0/128</td> </tr> <tr> <td></td> <td>0.0.0.0</td> <td></td> <td></td> <td>32768</td> <td>i</td> </tr> <tr> <td colspan="6">*>i2:0:48:00d0.f822.33df:0:0.0.0.0/128</td> </tr> <tr> <td></td> <td>2.2.2.2</td> <td>0</td> <td>100</td> <td>0</td> <td>i</td> </tr> </tbody> </table>	Neighbor	V	AS	MsgRcvd	MsgSent	TblVer	InQ	OutQ	Up/Down	State/PfxRcd	172.18.2.1	4	100	639	625	16	0	0	08:55:10	3	Network	Next Hop	Metric	LocPrf	Weight	Path	Route Distinguisher: 1.1.1.1:100 (Default for EVI 100)						*> 2:0:48:0011.2233.2016:0:0.0.0/128							0.0.0.0			32768	i	*>i2:0:48:00d0.f822.33df:0:0.0.0.0/128							2.2.2.2	0	100	0	i																																														
Neighbor	V	AS	MsgRcvd	MsgSent	TblVer	InQ	OutQ	Up/Down	State/PfxRcd																																																																																														
172.18.2.1	4	100	639	625	16	0	0	08:55:10	3																																																																																														
Network	Next Hop	Metric	LocPrf	Weight	Path																																																																																																		
Route Distinguisher: 1.1.1.1:100 (Default for EVI 100)																																																																																																							
*> 2:0:48:0011.2233.2016:0:0.0.0/128																																																																																																							
	0.0.0.0			32768	i																																																																																																		
*>i2:0:48:00d0.f822.33df:0:0.0.0.0/128																																																																																																							
	2.2.2.2	0	100	0	i																																																																																																		

<pre>*> 2:0:48:0011.2233.2016:32:100.1.1.2/128 0.0.0.0 32768 i *>i2:0:48:00d0.f822.33df:32:100.1.1.1/128 2.2.2.2 0 100 0 i *> 3:0:32:1.1.1.1/72 0.0.0.0 32768 i *>i3:0:32:2.2.2.2/72 2.2.2.2 0 100 0 i Total number of prefixes 6</pre>
<pre></pre>

Common Errors

- No L2VPN EVPN address family neighbor is configured.
- No VXLAN network is configured.
- The EVPN address family capability is not activated for BGP neighbors.

7.4.12 Configuring Interconnection with Devices Supporting Only 2-Byte AS Numbers

Configuration Effect

- Successfully interconnect devices supporting 4-byte AS numbers with devices supporting only 2-byte AS numbers.

Configuration Steps

⤵ **Enabling BGP**

- (Mandatory) Perform this configuration in the global configuration mode.

⤵ **Creating a BGP Neighbor**

- (Mandatory) Perform this configuration in the BGP configuration mode.

⤵ **Configuring the Display Mode of a 4-Byte AS Number**

- (Optional) Perform this configuration in the BGP configuration mode. By default, a 4-byte AS number is displayed as decimal digits.

Verification

- Run the **show** command to display the neighbor status.

Related Commands

⤵ **Enabling BGP**

Command	router bgp <i>as-number</i> [instance <i>instance-name</i>]
Parameter	<i>as-number</i> : Indicates an AS number, ranging from 1 to 4,294,967,295, which is 1 to 65535.65535 in the dot mode.
Description	instance : The instance should be specified for the non-default instance, and the instance name is required. <i>instance-name</i> : Instance name of 1 to 32 characters.
Command	Global configuration mode

Mode	
Usage Guide	-

↘ **Creating a BGP Neighbor**

Command	neighbor { <i>neighbor-address</i> <i>peer-group-name</i> } remote-as <i>as-number</i>
Parameter Description	<i>neighbor-address</i> : Specifies the address of a peer. This address may be an IPv4 address or an IPv6 address. <i>peer-group-name</i> : Specifies the name of a peer group. <i>as-number</i> : Indicates the AS number of a BGP peer (group).
Command Mode	BGP configuration mode
Usage Guide	The AS specified for a peer (group) must be the same as the BGP AS number of a BGP speaker at the peer end.

↘ **Configuring the Display Mode of a BGP 4-Byte AS Number**

Command	bgp asnotation dot
Parameter Description	-
Command Mode	BGP configuration mode
Usage Guide	-

Configuration Example

↘ **Configuring Compatibility Between BGP Devices Supporting 4-Byte AS Numbers and 2-Byte AS Numbers**

<p>Scenario Figure 1- 18</p>	
<p>Configuration Steps</p>	<ul style="list-style-type: none"> ● Enable BGP on all devices and set the AS numbers as shown in Figure 1- 18. ● Configure BGP neighborships.
<p>A</p>	<pre>A# configure terminal A(config)# router bgp 64496 A(config-router)# neighbor 172.18.1.2 remote-as 64497 A(config-router)# neighbor 172.18.2.3 remote-as 23456</pre>

<p>B</p>	<pre>B# configure terminal B(config)# router bgp 64497 B(config-router)# neighbor 172.18.1.1 remote-as 64496 B(config-router)# neighbor 172.18.3.3 remote-as 1.2 B(config-router)# bgp asnotation dot B(config-router)# end</pre>
<p>C</p>	<pre>C# configure terminal C(config)# router bgp 1.2 C(config-router)# neighbor 172.18.2.1 remote-as 64496 C(config-router)# neighbor 172.18.3.2 remote-as 64497</pre>
<p>Verification</p>	<p>Run the show command to display the BGP neighbor status.</p>
<p>A</p>	<pre>A# show ip bgp summary BGP router identifier 172.18.1.1, local AS number 64496 BGP table version is 1, main routing table version 1 Neighbor V AS MsgRcvd MsgSent TblVer InQ OutQ Up/Down Statd 172.18.1.2 4 64497 7 7 1 0 0 00:03:04 0 172.18.2.3 4 23456 4 4 1 0 0 00:00:15 0</pre>
<p>B</p>	<pre>B# show ip bgp summary BGP router identifier 172.18.3.2, local AS number 64497 BGP table version is 1, main routing table version 1 Neighbor V AS MsgRcvd MsgSent TblVer InQ OutQ Up/Down Statd 172.18.1.1 4 64496 7 7 1 0 0 00:00:04 0 172.18.3.2 4 1.2 4 4 1 0 0 00:00:16 0</pre>

Common Errors

N/A

7.4.13 Using Local IPv6 Link Addresses to Establish BGP Neighborships

Configuration Effect

- Use local IPv6 link addresses to establish BGP neighborships.

Notes

- Local IPv6 link addresses can be used for establishing only single-hop BGP neighborships.
- When local IPv6 link addresses are used for establishing neighborships, local IPv6 link addresses must be configured in address%interface name format, for example, neighbor fe80::1%Te0/1 remote-as 100.
- When local IPv6 link addresses are used for establishing neighborships, using local IPv6 link addresses as information sources must be specified on the peer end.
- When local IPv6 link addresses are used for establishing neighborships, local IPv6 link addresses must be configured on both ends.

Configuration Steps

↘ **Enabling BGP**

- (Mandatory) Perform this configuration in the global configuration mode.

↘ **Creating a BGP Neighbor**

- (Mandatory) Perform this configuration in the BGP configuration mode.

↘ **Configuring the BGP IPv4 Address Family Mode**

- (Optional) Perform this configuration in the BGP configuration mode.

↘ **Disabling the IPv4 Address Family Capability for a BGP Neighbor**

- (Optional) Perform this configuration in the BGP IPv6 configuration mode.

↘ **Configuring the BGP IPv6 Address Family Mode**

- (Mandatory) Perform this configuration in the BGP configuration mode.

↘ **Configuring the IPv6 Address Family Capability for a BGP Neighbor**

- (Mandatory) Perform this configuration in the BGP IPv6 configuration mode.

↘ **Configuring IPv6 Route Advertisement in BGP**

- (Optional) Perform this configuration in the BGP IPv6 configuration mode.

Verification

- Run the **show** command to display the neighbor status.
- Run the **show** command to display the routing status.

Related Commands

↘ **Enabling BGP**

Command	<code>router bgp <i>as-number</i> [instance <i>instance-name</i>]</code>
Parameter	<i>as-number</i> : Indicates an AS number, ranging from 1 to 4,294,967,295, which is 1 to 65535.65535 in the dot mode.

Description	instance: The instance should be specified for the non-default instance, and the instance name is required. <i>instance-name:</i> Instance name of 1 to 32 characters.
Command Mode	Global configuration mode
Usage Guide	-

↘ Creating a BGP Neighbor

Command	neighbor <i>neighbor-address</i> remote-as <i>as-number</i>
Parameter Description	<i>neighbor-address:</i> Indicates the peer address, which must be in Linklocal address%interface name format. <i>as-number:</i> Indicates the AS number of a BGP peer (group).
Command Mode	BGP configuration mode
Usage Guide	The AS specified for a peer must be the same as the BGP AS number of a BGP speaker at the peer end.

↘ Configuring the BGP IPv4 Address Family Mode

Command	address-family ipv4 unicast
Parameter Description	-
Command Mode	BGP configuration mode
Usage Guide	-

↘ Disabling the IPv4 Address Family Capability for a BGP Neighbor

Command	no neighbor <i>neighbor-address</i> activate
Parameter Description	<i>neighbor-address:</i> Indicates the address of a peer, which is usually an IPv6 address.
Command Mode	BGP IPv4 address family mode
Usage Guide	Neighbors with IPv6 addresses are used to exchange IPv6 routes. However, when a neighbor is configured in the BGP mode, BGP automatically activates the IPv4 unicast address family capability for the neighbor. Therefore, you are advised to manually disable the IPv4 unicast address family capability.

↘ Configuring the BGP IPv6 Address Family Mode

Command	address-family ipv6 unicast
Parameter Description	-
Command Mode	BGP configuration mode
Usage Guide	-

↘ **Configuring the IPv6 Address Family Capability for a BGP Neighbor**

Command	neighbor neighbor-address activate
Parameter Description	<i>neighbor-address</i> : Indicates the address of a peer, which is usually an IPv6 address.
Command Mode	BGP IPv6 address family mode
Usage Guide	-

↘ **Configuring IPv6 Route Advertisement in BGP**

Command	network network-number [mask mask] [route-map map-tag] [backdoor]
Parameter Description	<i>network-number</i> : Indicates the network number. <i>mask</i> : Indicates the subnet mask. <i>map-tag</i> : Indicates the name of a route map, consisting of no more than 32 characters. backdoor : Indicates that the route is a backdoor route.
Command Mode	BGP IPv6 address family mode
Usage Guide	-

Configuration Example

↘ **Using a Local IPv6 Link Address for Configuring a BGP Neighborhood to Implement IPv6 Route Exchange in Different ASs**



<p>Configuration Steps</p>	<ul style="list-style-type: none"> ● Enable BGP on all devices and set the AS numbers as shown in Figure 1- 19. ● Configure a BGP neighbor, specify the update-source, disable the IPv4 address family capability for the neighbor and activate the IPv6 address family capability. ● Configure IPv6 route advertisement in BGP.
<p>A</p>	<pre>A# configure terminal A(config)# int loopback 0 A(config-if-Loopback)# ipv6 address 30::1/128 A(config-if-Loopback)# exit A(config)# int GigabitEthernet 0/1 A(config-if-Loopback)# ipv6 address fe80:100::2/64 A(config-if-Loopback)# exit A(config)# router bgp 65530 A(config-router)# neighbor fe80:100::1%Gi0/1 remote-as 65531 A(config-router)# address-family ipv4 A(config-router-af)# no neighbor fe80:100::1%Gi0/1 activate A(config-router-af)# exit-address-family A(config-router)# address-family ipv6 A(config-router-af)# neighbor fe80:100::1%Gi0/1 activate A(config-router-af)# network 30::1/128</pre>
<p>B</p>	<pre>B# configure terminal B(config)# int GigabitEthernet 0/1 B(config-if-Loopback)# ipv6 address fe80:100::1/64 B(config-if-Loopback)# exit B(config)# router bgp 65531 B(config-router)# neighbor fe80:100::2%Gi0/1 remote-as 65530 B(config-router)# address-family ipv4 B(config-router-af)# no neighbor fe80:100::2%Gi0/1 activate B(config-router-af)# exit-address-family B(config-router)# address-family ipv6 B(config-router-af)# neighbor fe80:100::2%Gi0/1 activate</pre>
<p>Verification</p>	<p>Run the show command to display the BGP neighbor status.</p>
<p>A</p>	<pre>A# show bgp ipv6 unicast summary BGP router identifier 1.1.1.1, local AS number 65530 BGP table version is 1 1 BGP AS-PATH entries 0 BGP Community entries 1 BGP Prefix entries (Maximum-prefix:4294967295) Neighbor V AS MsgRcvd MsgSent TblVer InQ OutQ Up/Down State/PfxRcd</pre>

	fe80:100::1%Gi0/1 4 65531 4 6 1 0 00:01:49 0
	Total number of neighbors 1
B	<p>Run the show command to display BGP routing information.</p> <pre> B# show bgp ipv6 unicast BGP table version is 4, local router ID is 2.2.2.2 Status codes: s suppressed, d damped, h history, * valid, > best, i - internal, S Stale, b - backup entry Origin codes: i - IGP, e - EGP, ? - incomplete Network Next Hop Metric LocPrf Weight Path *> 30::1/128 fe80:100::2 0 0 65530 i Total number of prefixes 1 </pre>

Common Errors

- When a neighborhood is configured, a local IPv6 link address is used to specify the neighborhood; however, no update source is specified as the interface for this local IPv6 link address during local configuration.
- Only one end uses a local IPv6 link address for establishing a neighborhood.

7.4.14 Configuring BGP Tracking

Configuration Effect

- Configure the BGP tracking function to ensure fast route convergence.

Notes

N/A

Configuration Steps

↘ **Enabling BGP**

- (Mandatory) Perform this configuration in global configuration mode.

↘ **Creating a BGP Neighbor**

- (Mandatory) Perform this configuration in BGP configuration mode.

↘ **Configuring the Tracking Function for BGP Neighbors**

- (Mandatory) Perform this configuration in BGP configuration mode.

Verification

- Run the **show** command to display the information.

Related Commands

↘ **Enabling BGP**

Command	<code>router bgp as-number [instance instance-name]</code>
Parameter Description	<i>as-number</i> : Indicates an AS number, ranging from 1 to 4,294,967,295, which is 1 to 65535.65535 in dot mode. <i>instance</i> : The instance should be specified for the non-default instance, and the instance name is required. <i>instance-name</i> : Instance name of 1 to 32 characters.
Command Mode	Global configuration mode
Usage Guide	-

↘ **Creating a BGP Neighbor**

Command	<code>neighbor { neighbor-address peer-group-name } remote-as as-number</code>
Parameter Description	<i>neighbor-address</i> : Specifies the address of a peer. This address may be an IPv4 address or an IPv6 address. <i>peer-group-name</i> : Specifies the name of a peer group. <i>as-number</i> : Indicates the AS number of a BGP peer (group).
Command Mode	BGP configuration mode
Usage Guide	The AS specified for a peer (group) must be the same as the BGP AS number of a BGP speaker at the peer end.

↘ **Configuring the Tracking Function for BGP Neighbors**

Command	<code>neighbor { neighbor-address peer-group-name } track track-obj-number</code>
Parameter Description	<i>neighbor-address</i> : Specifies the address of a peer. This address may be an IPv4 address or an IPv6 address. <i>peer-group-name</i> : Specifies the name of a peer group. <i>track-obj-number</i> : Specifies the number of the tracked object.
Command Mode	BGP configuration mode
Usage Guide	-

Configuration Example

↘ **Configuring BGP Tracking**

Scenario Figure 1-20	
Configuration	<ul style="list-style-type: none"> ● Establish an EBGP neighborhood between routers A and B. ● Configure the loopback interface (2.2.2.2/32) on A for tracking B.

Steps	
A	<pre> A# configure terminal A(config)# ip rns 1 A(config-ip-rns)#icmp-echo 2.2.2.2 A(config-ip-rns-icmp-echo)#timeout 6000 A(config-ip-rns-icmp-echo)#frequency 10000 A(config-ip-rns-icmp-echo)#exit A(config)# ip rns schedule 1 start-time now life forever A(config)# track 3 rns 1 A(config)# router bgp 3600 A(config-router)# neighbor 192.168.182.34 remote-as 65531 A(config-router)# neighbor 192.168.182.34 track 3 </pre>
Verification	Run the show command to query the BGP neighbor status.
A	<pre> A# BGP neighbor is 192.168.182.34, remote AS 65531, local AS 65530, external link Using TRACK to detect state BGP version 4, remote router ID 88.5.5.5 BGP state = Established, up for 00:00:16 Last read , hold time is 180, keepalive interval is 60 seconds Neighbor capabilities: Route refresh: advertised and received (old and new) Four-octets ASN Capability: advertised and received Address family IPv4 Unicast: advertised and received Address family L2VPN VPLS: advertised and received Address family L2VPN EVPN: advertised and received Graceful Restart Capability: advertised and received Remote Restart timer is 120 seconds Address families preserved by peer: IPv4 Unicast (was not preserved) IPv4 Labeled (was not preserved) VPNv4 Unicast (was not preserved) IPv6 Unicast (was not preserved) IPv6 Labeled (was not preserved) L2VPN VPLS (was not preserved) L2VPN EVPN (was not preserved) </pre>

	L2VPN VPWS (was not preserved)
--	---

Common Errors

N/A

7.4.15 Configuring BGP NSR

Configuration Effect

- Configure the BGP NSR function to ensure highly reliable network deployment.

Notes

- To deploy the BGP NSR function successfully, the device must support the dual engine redundancy hot backup function.
- After the BGP NSR function is enabled, connections to the BGP neighbors will be reset for the function to take effect.

Configuration Steps

↘ **Enabling BGP**

- (Mandatory) Perform this configuration in global configuration mode.

↘ **Creating a BGP Neighbor**

- (Mandatory) Perform this configuration in BGP configuration mode.

↘ **Configuring the NSR Function for BGP Neighbors**

- (Mandatory) Perform this configuration in BGP configuration mode.

Verification

- Run the **show** command to query the BGP neighbor status.

Related Commands

↘ **Enabling BGP**

Command	router bgp <i>as-number</i> [instance <i>instance-name</i>]
Parameter Description	<i>as-number</i> : Indicates an AS number, ranging from 1 to 4,294,967,295, which is 1 to 65535.65535 in dot mode. instance : The instance should be specified for the non-default instance, and the instance name is required. <i>instance-name</i> : Instance name of 1 to 32 characters.
Command Mode	Global configuration mode
Usage Guide	-

↘ **Creating a BGP Neighbor**

Command	neighbor { <i>neighbor-address</i> <i>peer-group-name</i> } remote-as <i>as-number</i>
----------------	--

Parameter Description	<i>neighbor-address</i> : Specifies the address of a peer. This address may be an IPv4 address or an IPv6 address. <i>peer-group-name</i> : Specifies the name of a peer group. <i>as-number</i> : Indicates the AS number of a BGP peer (group).
Command Mode	BGP configuration mode
Usage Guide	The AS specified for a peer (group) must be the same as the BGP AS number of a BGP speaker at the peer end.

↘ **Configuring the NSR Function for BGP Neighbors**

Command	neighbor { <i>neighbor-address</i> <i>peer-group-name</i> } ha-mode nsr
Parameter Description	<i>neighbor-address</i> : Specifies the address of a peer. This address may be an IPv4 address or an IPv6 address. <i>peer-group-name</i> : Specifies the name of a peer group.
Command Mode	BGP configuration mode
Usage Guide	-

Configuration Example

↘ **Configuring BGP NSR**

Scenario Figure 1- 21	
Configuration Steps	<ul style="list-style-type: none"> ● Enable BGP on all devices and set the AS numbers as shown in Figure 1-21. ● Establish the EBGP neighborhood between routers A and B via the directly connected port. ● Enable the BGP NSR function on A.
A	<pre>A# configure terminal A(config-router)# exit A(config)# router bgp 65530 A(config-router)# neighbor 192.168.195.182 ha-mode nsr</pre>
Verification	Run the show command to query the BGP neighbor status.
A	<pre>A# show ip bgp neighbors BGP neighbor is 192.168.195.183, remote AS 65530, local AS 65531, external link Using BFD to detect fast fallover - BFD session state up BGP version 4, remote router ID 10.0.0.1 BGP state = Established, up for 00:06:37</pre>

	<pre> Last read 00:06:37, hold time is 180, keepalive interval is 60 seconds Neighbor capabilities: Route refresh: advertised and received (old and new) Address family IPv4 Unicast: advertised and received Graceful restart: advertised and received Remote Restart timer is 120 seconds Address families preserved by peer: None </pre>
<p>B</p>	<pre> B# show ip bgp neighbors BGP neighbor is 192.168.195.183, remote AS 65530, local AS 65531, external link Using BFD to detect fast fallover - BFD session state up BGP version 4, remote router ID 10.0.0.1 BGP state = Established, up for 00:06:37 Last read 00:06:37, hold time is 180, keepalive interval is 60 seconds Neighbor capabilities: Route refresh: advertised and received (old and new) Address family IPv4 Unicast: advertised and received Graceful restart: advertised and received Remote Restart timer is 120 seconds Address families preserved by peer: None </pre>

Common Errors

- IGP is not configured.
- The NSR function is not enabled for BGP neighbors.

7.4.16 Configuring BGP Routes to Be Recursive Only to Host Routes

Configuration Effect

- Configure BGP routes to be recursive only to host routes, to enable IBGP or multi-EBGP routes to be recursive only to host routes.

Notes

- This feature is effective only to IBGP or multi-hop EBGP routes. It is unavailable to direct EBGP routes or routes whose next-hop addresses are direct connection addresses.

- IBGP or multi-hop EBGP neighborships of the device need to be established using the address of the Loopback interface. Otherwise, this feature is unavailable.

Configuration Steps

↘ **Enabling BGP**

- (Mandatory) Perform this configuration in global configuration mode.

↘ **Configuring BGP Routes to Be Recursive Only to Host Routes**

- (Mandatory) Perform this configuration in BGP address family mode.

Verification

- Run the **show running-config** command to display the configuration.

Related Commands

↘ **Enabling BGP**

Command	router bgp <i>as-number</i> [instance <i>instance-name</i>]
Parameter Description	<i>as-number</i> : Indicates an AS number. The value range is from 1 to 4,294,967,295, which is 1 to 65535.65535 in dot mode. instance : The instance should be specified for the non-default instance, and the instance name is required. <i>instance-name</i> : Instance name of 1 to 32 characters.
Command Mode	Global configuration mode
Usage Guide	N/A

↘ **Configuring BGP Routes to Be Recursive Only to Host Routes**

Command	Bgp recursion host
Parameter Description	N/A
Command Mode	BGP address family mode
Usage Guide	N/A

Configuration Example

↘ **Configuring BGP Routes to Be Recursive Only to Host Routes**

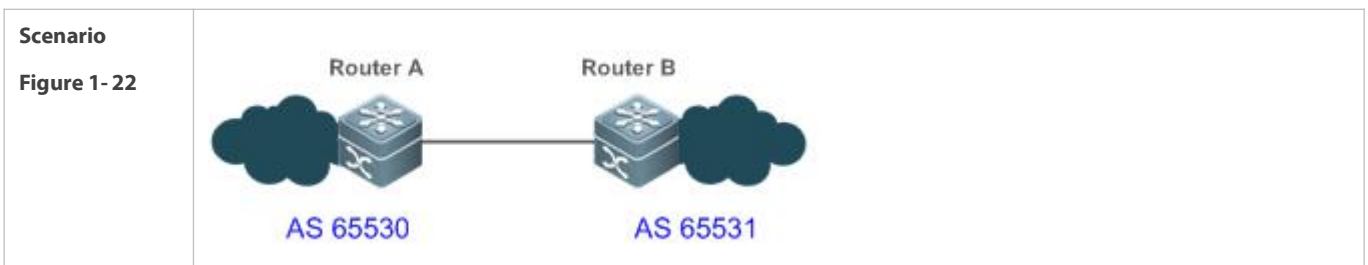

Configuration Steps	<ul style="list-style-type: none"> ● Enable BGP on all devices and set the AS numbers as shown in the preceding figure. ● Establish the multi-hop EBGP neighborships on Router A and Router B through the Loopback interface. ● Enable the function of making BGP routes recursive only to host routes on Router A and Router B.
Verification	Run the show command to display the BGP neighbor status.

Common Errors

- If the feature is enabled on a device but IBGP or multi-hop EBGP neighborships are not established using the address of the Loopback interface, the device cannot find a host route that matches the next-hop address of a BGP route. As a result, the next hop of the BGP route is invalid and routes cannot be preferentially selected.

7.4.17 Configuring Outbound Loop Detection for a BGP Neighbor

Configuration Effect

- Configure outbound loop detection for a BGP neighbor

Notes

- This feature is available only to EBGP neighbors.

Configuration Steps

↳ **Enabling BGP**

- (Mandatory) Perform this configuration in global configuration mode.

↳ **Creating a BGP Neighbor**

- (Mandatory) Perform this configuration in BGP configuration mode.

↳ **Configuring Outbound Loop Detection for a BGP Neighbor**

- (Mandatory) Perform this configuration in BGP configuration mode.

Verification

- Run the **show** command to display the neighbor status.

Related Commands

↳ **Enabling BGP**

Command	router bgp <i>as-number</i> [instance <i>instance-name</i>]
Parameter Description	<p><i>as-number</i>: Indicates an AS number. The value range is from 1 to 4,294,967,295, which is 1 to 65535.65535 in dot mode.</p> <p>instance: The instance should be specified for the non-default instance, and the instance name is required.</p> <p><i>instance-name</i>: Instance name of 1 to 32 characters.</p>
Command Mode	Global configuration mode
Usage Guide	N/A

↘ **Creating a BGP Neighbor**

Command	neighbor { <i>neighbor-address</i> <i>peer-group-name</i> } remote-as <i>as-number</i>
Parameter Description	<i>neighbor-address</i> : Specifies the address of a peer. This address may be an IPv4 address or an IPv6 address. <i>peer-group-name</i> : Specifies the name of a peer group. <i>as-number</i> : Indicates the AS number of a BGP peer (group).
Command Mode	BGP configuration mode
Usage Guide	The AS number specified for a peer (group) must be the same as the BGP AS number of a BGP speaker at the peer end.

↘ **Configuring Outbound Loop Detection for a BGP Neighbor**

Command	neighbor { <i>neighbor-address</i> <i>peer-group-name</i> } as-loop-check out
Parameter Description	<i>neighbor-address</i> : Specifies the address of a peer. This address may be an IPv4 address or an IPv6 address. <i>peer-group-name</i> : Specifies the name of a peer group.
Command Mode	BGP configuration mode
Usage Guide	N/A

Configuration Example

↘ **Configuring Outbound Loop Detection for a BGP Neighbor**

Scenario Figure 1-23	
Configuration Steps	<ul style="list-style-type: none"> ● Enable BGP on all devices and set the AS numbers as shown in the preceding figure. ● Establish the EBGP neighborhood between Device A and Device C, and between Device B and Device C. ● On Device C, enable outbound loop detection for its neighbors: Device A and Device B.
A	<pre>A# configure terminal A(config)# router bgp 65536 A(config-router)# neighbor 10.1.1.1 remote-as 65537</pre>

B	<pre>B# configure terminal B(config)# router bgp 65536 B(config-router)# neighbor 20.1.1.1 remote-as 65537</pre>
C	<pre>C# configure terminal C(config)# router bgp 65537 C(config-router)# neighbor 10.1.1.2 remote-as 65536 C(config-router)# neighbor 10.1.1.2 as-loop-check out C(config-router)# neighbor 20.1.1.2 remote-as 65536 C(config-router)# neighbor 20.1.1.2 as-loop-check out</pre>
Verification	Run the show command to display the BGP neighbor status.
C	<pre>C# show ip bgp neighbors 10.1.1.2 BGP neighbor is 10.1.1.2, remote AS 65536, local AS 65537, external link Using as path loop detection in announcing route BGP version 4, remote router ID 10.0.0.1 BGP state = Established, up for 00:06:37 Last read 00:06:37, hold time is 180, keepalive interval is 60 seconds Neighbor capabilities: Route refresh: advertised and received (old and new) Address family IPv4 Unicast: advertised and received Graceful restart: advertised and received Remote Restart timer is 120 seconds Address families preserved by peer: None ...</pre>

7.4.18 Shutting Down BGP Connections Gracefully

Configuration Effect

- Shut down BGP connections gracefully. Service traffic is not interrupted or is interrupted for a very short period of time in the process from feature configuration to actual BGP connection shutdown.

Notes

N/A

Configuration Steps

↳ Enabling BGP

- (Mandatory) Perform this configuration in global configuration mode.

↘ **Creating a BGP Neighbor**

- (Mandatory) Perform this configuration in BGP configuration mode.

↘ **Shutting Down Connections of the BGP Neighbor Gracefully**

- (Optional) Perform this configuration in BGP configuration mode.

↘ **Shutting Down All Connections of a BGP Instance Gracefully**

- (Optional) Perform this configuration in BGP configuration mode.

Verification

- Run the **show** command to display the neighbor status.

Related Commands

↘ **Enabling BGP**

Command	router bgp <i>as-number</i> [instance <i>instance-name</i>]
Parameter Description	<i>as-number</i> : Indicates an AS number. The value range is from 1 to 4,294,967,295, which is 1 to 65535.65535 in dot mode. instance : The instance should be specified for the non-default instance, and the instance name is required. <i>instance-name</i> : Instance name of 1 to 32 characters.
Command Mode	Global configuration mode
Usage Guide	N/A

↘ **Creating a BGP Neighbor**

Command	neighbor { <i>neighbor-address</i> <i>peer-group-name</i> } remote-as <i>as-number</i>
Parameter Description	<i>neighbor-address</i> : Specifies the address of a peer. This address may be an IPv4 address or an IPv6 address. <i>peer-group-name</i> : Specifies the name of a peer group. <i>as-number</i> : Indicates the AS number of a BGP peer (group).
Command Mode	BGP configuration mode
Usage Guide	The AS number specified for a peer (group) must be the same as the BGP AS number of a BGP speaker at the peer end.

↘ **Shutting Down Connections of the BGP Neighbor Gracefully**

Command	neighbor { <i>neighbor-address</i> <i>peer-group-name</i> } shutdown graceful [community <i>value</i>] [delay <i>time</i>]
Parameter Description	<i>neighbor-address</i> : Specifies the address of a peer. This address may be an IPv4 address or an IPv6 address. <i>peer-group-name</i> : Specifies the name of a peer group. community <i>value</i> : Indicates the community value carried in the route sent to the neighbor. delay <i>time</i> : Indicates the delay time (in seconds) for shutting down BGP connections. The value range is from 1 to 65,535.
Command	BGP configuration mode

Mode	
Usage Guide	N/A

↘ **Shutting Down All Connections of a BGP Instance Gracefully**

Command	bgp shutdown graceful [community value] [delay time]
Parameter Description	community value: Indicates the community value carried in the route sent to the neighbor. delay time: Indicates the delay time (in seconds) for shutting down BGP connections. The value range is from 1 to 65,535.
Command Mode	BGP configuration mode
Usage Guide	N/A

Configuration Example

↘ **Shutting Down BGP Connections Gracefully**

<p>Scenario Figure 1- 24</p>	
<p>Configuration Steps</p>	<ul style="list-style-type: none"> ● Enable BGP on all devices and set the AS numbers as shown in the preceding figure. ● Establish the EBGP neighborhood between Device A and Device C and between Device B and Device C. ● On Device A, shut down all connections of a BGP instance gracefully.
<p>A</p>	<pre>A# configure terminal A(config)# router bgp 65536 A(config-router)# neighbor 10.1.1.1 remote-as 65537 A(config-router)# bgp shutdown graceful med 4294967295</pre>
<p>B</p>	<pre>B# configure terminal B(config)# router bgp 65536 B(config-router)# neighbor 20.1.1.1 remote-as 65537</pre>
<p>C</p>	<pre>C# configure terminal C(config)# router bgp 65537</pre>

	<pre>C(config-router)# neighbor 10.1.1.2 remote-as 65536 C(config-router)# neighbor 10.1.1.2 as-loop-check out C(config-router)# neighbor 20.1.1.2 remote-as 65536 C(config-router)# neighbor 20.1.1.2 as-loop-check out</pre>
<p>Verification</p>	<p>Run the show command to display the BGP neighbor status.</p>
<p>A</p>	<pre>A(config)#show ip bgp neighbor 10.1.1.2 For address family: IPv4 Unicast BGP neighbor is 10.10.10.2, remote AS 65537, local AS 65536, external link Administratively graceful shut down BGP version 4, remote router ID 0.0.0.0 BGP state = Idle Last read , hold time is 30, keepalive interval is 1 seconds Configured hold time is 30, keepalive interval is 1 seconds Received 0 messages, 0 notifications, 0 in queue open message:0 update message:0 keepalive message:0 refresh message:0 dynamic cap:0 notifications:0 Sent 0 messages, 0 notifications, 0 in queue open message:0 update message:0 keepalive message:0 refresh message:0 dynamic cap:0 notifications:0 Route refresh request: received 0, sent 0 Minimum time between advertisement runs is 30 seconds Update source is Loopback 0 For address family: IPv4 Unicast BGP table version 1, neighbor version 0 Index 1, Offset 0, Mask 0x2 0 accepted prefixes 0 announced prefixes Connections established 0; dropped 0 BGP neighbor may be up to 255 hops away. Sock_fd: -1 Last Reset: , due to BGP Notification received Notification Error Message: (Cease/Other Configuration Change.)</pre>

7.4.19 Configuring EBGP Multi-path Bypass Protection

Configuration Effect

- Implement EBGP multi-path bypass protection.

Notes

- BFD sessions can be configured for neighbors to implement fast link fault detection.

Configuration Steps

↘ Enabling BGP

- (Mandatory) Perform this configuration in global configuration mode.

↘ Creating a BGP Neighbor

- (Mandatory) Perform this configuration in BGP configuration mode.

↘ Configuring BGP ECMP

- (Mandatory) Perform this configuration in BGP configuration mode.

↘ Configuring BGP Multi-path Bypass Protection

- (Mandatory) Perform this configuration in BGP configuration mode.

↘ Configuring a BFD Session to a BGP Neighbor

- (Optional) Perform this configuration in BGP configuration mode.

Verification

- Run the **show** command to display route information.

Related Commands

↘ Enabling BGP

Command	router bgp <i>as-number</i> [instance <i>instance-name</i>]
Parameter Description	<i>as-number</i> : Indicates an AS number. The value range is from 1 to 4,294,967,295, which is 1 to 65535.65535 in dot mode. instance : The instance should be specified for the non-default instance, and the instance name is required. <i>instance-name</i> : Instance name of 1 to 32 characters.
Command Mode	Global configuration mode
Usage Guide	N/A

↘ Configuring BGP Multi-path Bypass Protection

Command	bgp install standby-path
Parameter Description	N/A

Command Mode	BGP configuration mode
Usage Guide	N/A

↘ Creating a BGP Neighbor

Command	neighbor { <i>neighbor-address</i> <i>peer-group-name</i> } remote-as <i>as-number</i>
Parameter Description	<i>neighbor-address</i> : Specifies the address of a peer. This address may be an IPv4 address or an IPv6 address. <i>peer-group-name</i> : Specifies the name of a peer group. <i>as-number</i> : Indicates the AS number of a BGP peer (group).
Command Mode	BGP configuration mode
Usage Guide	The AS number specified for a peer (group) must be the same as the BGP AS number of a BGP speaker at the peer end.

↘ Creating a BFD Session to a BGP Neighbor

Command	neighbor { <i>neighbor-address</i> <i>peer-group-name</i> } fall-over bfd
Parameter Description	<i>neighbor-address</i> : Specifies the address of a peer. This address may be an IPv4 address or an IPv6 address. <i>peer-group-name</i> : Specifies the name of a peer group.
Command Mode	BGP configuration mode
Usage Guide	N/A

Configuration Example

 The following configuration example describes only the configuration relevant to BGP multi-path bypass protection.

↘ Configuring BGP Multi-path Bypass Protection

<p>Scenario</p> <p>Figure 1- 25</p>	
<p>Configuration Steps</p>	<ul style="list-style-type: none"> ● Enable BGP on all devices. ● Configure addresses for directly-connected ports on Device A, Device B, and Device C, and mutually establish the EBGP neighborhood between every two of them. ● Configure a BFD session for the EBGP neighborhood between Device A and Device C. ● Configure BGP multi-path bypass protection on Device C. ● Configure ECMP on Device C.
<p>A</p>	<pre> A# conf terminal A(config)# interface GigabitEthernet 0/1 A(config-if-GigabitEthernet 0/1)# ip address 192.168.1.1 255.255.255.0 A(config-if-GigabitEthernet 0/1)# exit A(config)# interface GigabitEthernet 0/2 A(config-if-GigabitEthernet 0/2)# ip address 192.168.2.1 255.255.255.0 A(config-if-GigabitEthernet 0/2)# exit A(config)# interface GigabitEthernet 0/3 A(config-if-GigabitEthernet 0/3)# ip address 192.168.4.1 255.255.255.0 A(config-if-GigabitEthernet 0/3)# exit A(config)# router bgp 100 A(config-router)# neighbor 192.168.1.2 remote-as 300 A(config-router)# neighbor 192.168.4.2 remote-as 300 </pre>

	<pre>A(config-router)# neighbor 192.168.2.2 remote-as 200 A(config-router)# maximum-paths ebgp 2 A(config-router)# redistribute connect</pre>
B	<pre>B# configure terminal B(config)# interface GigabitEthernet 0/1 B(config-if-GigabitEthernet 0/1)# ip address 192.168.3.1 255.255.255.0 B(config-if-GigabitEthernet 0/1)# bfd interval 200 min_rx 200 multiplier 5 B(config-if-GigabitEthernet 0/1)# exit B(config)# interface GigabitEthernet 0/2 B(config-if-GigabitEthernet 0/2)# ip address 192.168.2.2 255.255.255.0 B(config-if-GigabitEthernet 0/2)# exit B(config)# router bgp 200 B(config-router)# neighbor 192.168.3.2 remote-as 300 B(config-router)# neighbor 192.168.3.2 fall-over bfd B(config-router)# neighbor 192.168.2.1 remote-as 100 B(config-router)# redistribute connect</pre>
C	<pre>C# configure terminal C(config)# interface GigabitEthernet 0/1 C(config-if-GigabitEthernet 0/1)# ip address 192.168.1.2 255.255.255.0 C(config-if-GigabitEthernet 0/1)# bfd interval 200 min_rx 200 multiplier 5 C(config-if-GigabitEthernet 0/1)# exit C(config)# interface fastEthernet 0/2 C(config-if-GigabitEthernet 0/2)# ip address 192.168.3.2 255.255.0.0 C(config-if-GigabitEthernet 0/2)# bfd interval 200 min_rx 200 multiplier 5 C(config-if-GigabitEthernet 0/2)# exit C(config)# interface fastEthernet 0/3 C(config-if-GigabitEthernet 0/3)# ip address 192.168.4.2 255.255.0.0 C(config-if-GigabitEthernet 0/3)# bfd interval 200 min_rx 200 multiplier 5 C(config-if-GigabitEthernet 0/3)# exit C(config)# router bgp 300 C(config-router)# neighbor 192.168.1.1 remote-as 100 C(config-router)# neighbor 192.168.4.1 remote-as 100 C(config-router)# neighbor 192.168.3.1 remote-as 200 C(config-router)# neighbor 192.168.1.1 fall-over bfd</pre>

	<pre>C(config-router)# neighbor 192.168.4.1 fall-over bfd C(config-router)# maximum-paths ebgp 2 C(config-router)# address-family ipv4 unicast C(config-router-af)# bgp install standby-path C(config-router-af)# redistribute connect</pre>																																																																																								
Verification	Run the show command to display the configuration.																																																																																								
C	<pre>C# show ip bgp summary BGP router identifier 10.10.10.10, local AS number 300 BGP table version is 12 4 BGP AS-PATH entries 0 BGP Community entries 4 BGP Prefix entries (Maximum-prefix:4294967295)</pre> <table border="1" data-bbox="337 907 1285 1108"> <thead> <tr> <th>Neighbor</th> <th>V</th> <th>AS</th> <th>MsgRcvd</th> <th>MsgSent</th> <th>TblVer</th> <th>InQ</th> <th>OutQ</th> <th>Up/Down</th> <th>State/PfxRcd</th> </tr> </thead> <tbody> <tr> <td>192.168.1.1</td> <td>4</td> <td>100</td> <td>76</td> <td>77</td> <td>12</td> <td>12</td> <td>0</td> <td>00:59:27</td> <td>3</td> </tr> <tr> <td>192.168.3.1</td> <td>4</td> <td>200</td> <td>30</td> <td>30</td> <td>12</td> <td>12</td> <td>0</td> <td>00:19:03</td> <td>3</td> </tr> <tr> <td>192.168.4.1</td> <td>4</td> <td>100</td> <td>76</td> <td>77</td> <td>12</td> <td>12</td> <td>0</td> <td>00:59:01</td> <td>3</td> </tr> </tbody> </table> <pre>Total number of neighbors 3 C# show ip bgp BGP table version is 12, local router ID is 10.10.10.10 Status codes: s suppressed, d damped, h history, * valid, > best, i - internal, S Stale, b - backup entry, m - multipath Origin codes: i - IGP, e - EGP, ? - incomplete</pre> <table border="1" data-bbox="337 1612 1176 2016"> <thead> <tr> <th>Network</th> <th>Next Hop</th> <th>Metric</th> <th>LocPrf</th> <th>Weight</th> <th>Path</th> </tr> </thead> <tbody> <tr> <td>* 192.168.1.0</td> <td>192.168.3.1</td> <td>0</td> <td></td> <td>0</td> <td>200 ?</td> </tr> <tr> <td>*</td> <td>192.168.4.1</td> <td>0</td> <td></td> <td>0</td> <td>100 ?</td> </tr> <tr> <td>*</td> <td>192.168.1.1</td> <td>0</td> <td></td> <td>0</td> <td>100 ?</td> </tr> <tr> <td>*></td> <td>0.0.0.0</td> <td>0</td> <td></td> <td>32768</td> <td>?</td> </tr> <tr> <td>*> 192.168.2.0</td> <td>192.168.4.1</td> <td>0</td> <td></td> <td>0</td> <td>200 ?</td> </tr> <tr> <td>*m</td> <td>192.168.1.1</td> <td>0</td> <td></td> <td>0</td> <td>200 ?</td> </tr> <tr> <td>*b</td> <td>192.168.3.1</td> <td>0</td> <td></td> <td>0</td> <td>100 ?</td> </tr> </tbody> </table>	Neighbor	V	AS	MsgRcvd	MsgSent	TblVer	InQ	OutQ	Up/Down	State/PfxRcd	192.168.1.1	4	100	76	77	12	12	0	00:59:27	3	192.168.3.1	4	200	30	30	12	12	0	00:19:03	3	192.168.4.1	4	100	76	77	12	12	0	00:59:01	3	Network	Next Hop	Metric	LocPrf	Weight	Path	* 192.168.1.0	192.168.3.1	0		0	200 ?	*	192.168.4.1	0		0	100 ?	*	192.168.1.1	0		0	100 ?	*>	0.0.0.0	0		32768	?	*> 192.168.2.0	192.168.4.1	0		0	200 ?	*m	192.168.1.1	0		0	200 ?	*b	192.168.3.1	0		0	100 ?
Neighbor	V	AS	MsgRcvd	MsgSent	TblVer	InQ	OutQ	Up/Down	State/PfxRcd																																																																																
192.168.1.1	4	100	76	77	12	12	0	00:59:27	3																																																																																
192.168.3.1	4	200	30	30	12	12	0	00:19:03	3																																																																																
192.168.4.1	4	100	76	77	12	12	0	00:59:01	3																																																																																
Network	Next Hop	Metric	LocPrf	Weight	Path																																																																																				
* 192.168.1.0	192.168.3.1	0		0	200 ?																																																																																				
*	192.168.4.1	0		0	100 ?																																																																																				
*	192.168.1.1	0		0	100 ?																																																																																				
*>	0.0.0.0	0		32768	?																																																																																				
*> 192.168.2.0	192.168.4.1	0		0	200 ?																																																																																				
*m	192.168.1.1	0		0	200 ?																																																																																				
*b	192.168.3.1	0		0	100 ?																																																																																				

```

* 192.168.3.0    192.168.3.1    0    0 200 ?
*                192.168.4.1    0    0 100 200 ?
*                192.168.1.1    0    0 100 200 ?
*>                0.0.0.0    0    32768 ?
* 192.168.4.0    192.168.3.1    0    0 200 ?
*                192.168.4.1    0    0 100 ?
*                192.168.1.1    0    0 100 ?
*>                0.0.0.0    0    32768 ?

Total number of prefixes 4
C# show ip bgp 192.168.2.0
BGP routing table entry for 192.168.2.0/24
Paths: (3 available, best #3, table Default-IP-Routing-Table)
  Advertised to non peer-group peers:
    192.168.1.1
    200
    192.168.3.1 from 192.168.3.1 (3.3.3.3)
      Origin incomplete, metric 0, localpref 100, valid, external, backup
      Last update: Tue Oct 5 00:26:52 1971

    100
    192.168.1.1 from 192.168.1.1 (44.44.44.44)
      Origin incomplete, metric 0, localpref 100, valid, external, multipath
      Last update: Mon Oct 4 23:46:28 1971

    100
    192.168.4.1 from 192.168.4.1 (44.44.44.44)
      Origin incomplete, metric 0, localpref 100, valid, external, multipath, best
      Last update: Mon Oct 4 23:46:28 1971
C# show ip route

Codes: C - connected, S - static, R - RIP, B - BGP
       O - OSPF, IA - OSPF inter area
       N1 - OSPF NSSA external type 1, N2 - OSPF NSSA external type 2
    
```

<p>E1 - OSPF external type 1, E2 - OSPF external type 2</p> <p>i - IS-IS, su - IS-IS summary, L1 - IS-IS level-1, L2 - IS-IS level-2</p> <p>ia - IS-IS inter area, * - candidate default</p> <p>Gateway of last resort is no set</p> <p>C 192.168.1.0/24 is directly connected, GigabitEthernet 0/1</p> <p>C 192.168.1.2/32 is local host.</p> <p>B 192.168.2.0/24 [20/0] via 192.168.1.1, 00:21:39</p> <p style="padding-left: 40px;">[20/0] via 192.168.4.1, 00:21:39</p> <p>C 192.168.3.0/24 is directly connected, GigabitEthernet 0/2</p> <p>C 192.168.3.2/32 is local host.</p> <p>C 192.168.4.0/24 is directly connected, GigabitEthernet 0/3</p> <p>C 192.168.4.2/32 is local host.</p>

7.5 Configuring Inter-VRF Multi-Path Route Import

Configuration Effect

- Ensure inter-VRF route import and ECMP multi-path for inter-imported routes.

Notes

- N/A

Configuration Steps

↘ Configuring a BGP VRF Address Family

- (Mandatory) Perform this configuration in BGP configuration mode.

↘ Importing Static Routes to BGP

- (Mandatory) Perform this configuration in BGP address family mode.

↘ Importing Multi-Path Static Routes to BGP

- (Mandatory) Perform this configuration in BGP address family mode.

↘ Configuring BGP ECMP

- (Mandatory) Perform this configuration in BGP address family mode.

↘ Configuring Inter-VRF Import for All Path Routes

- (Mandatory) Perform this configuration in BGP address family mode.

Verification

- Run the **show** command to display route information.

Related Commands

↘ Configuring a BGP VRF Address Family

Command	router bgp <i>as-number</i> [instance <i>instance-name</i>]
Parameter Description	<i>as-number</i> : Indicates an AS number. The value range is from 1 to 4,294,967,295, which is 1 to 65535.65535 in dot mode. instance : The instance should be specified for the non-default instance, and the instance name is required. <i>instance-name</i> : Instance name of 1 to 32 characters.
Command Mode	BGP configuration mode
Usage Guide	N/A

↘ Importing Static Routes to BGP

Command	redistribute <i>protocol-type</i> [route-map <i>map-tag</i>] [metric <i>metric-value</i>]
Parameter Description	<i>protocol-type</i> : Indicates the source protocol type of a redistributed route. route-map <i>map-tag</i> : Indicates the name of an associated route map. metric <i>metric-value</i> : Indicates the default metric value of a redistributed route. The value range is from 0 to 4,294,967,295 .
Command Mode	BGP address family mode
Usage Guide	N/A

↘ Importing Multi-Path Static Routes to BGP

Command	bgp sourced-paths <i>protocol-type</i> all
Parameter Description	<i>protocol-type</i> : Indicates the source protocol type of a redistributed route.
Command Mode	BGP address family mode
Usage Guide	This command needs to be used together with the redistribution command to import routes with multiple next hops from other protocols to BGP.

↘ Configuring BGP ECMP

Command	maximum-paths { ebgp ibgp } <i>number</i>
Parameter Description	ebgp : Specifies the number of equivalent paths of the EBGp multipath load balancing function. ibgp : Specifies the number of equivalent paths of the IBGP multipath load balancing function. <i>number</i> : Indicates the maximum number of equivalent paths. The minimum value is 1 , and the maximum value depends on the device capability. If the value is 1 , the EBGp multipath load balancing function is disabled.
Command Mode	BGP address family mode
Usage Guide	The maximum-paths ebgp command is also used to configure equivalence of confederation EBGp multiple paths and local inter-VRF import routes. IBGP and EBGp routes cannot form equivalent routes.

↘ Configuring Inter-VRF Import for All Path Routes

Command	import path selection { all bestpath multipath }
Parameter	all: Imports all routes with next hops.
Description	bestpath: Imports routes with preferred next hops. By default, only routes with preferred next hops are imported. multipath: Imports routes with preferred and equivalent next hops.
Command Mode	BGP address family mode
Usage Guide	This command can be used to control inter-VRF route import, L3VPN remote routes import to VRF, and EVPN routes import to the IP route table.

Configuration Example

↘ **Configuring BGP Multi-Path Bypass Protection**

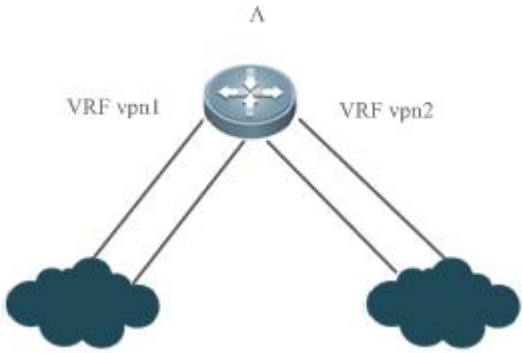
<p>Scenario Figure 1-26</p>	 <p>Device A connects to two networks through VRF vpn1 and vpn2, and cross-VRF access is implemented through device A.</p>
<p>Configuration Steps</p>	<p>Configure VRF. Configure VRF static routes. Configure a VRF address family. Import VRF static routes to BGP. Enable multi-path static route import to BGP. Configure BGP ECMP. Configure inter-VRF import for all path routes.</p>
<p>A</p>	<pre>A# conf terminal A(config)# ip vrf vpn1 A(config-vrf)# rd 200:1 A(config-vrf)# route-target both 100:100 A(config-vrf)# exit A(config)# ip vrf vpn2 A(config-vrf)# rd 300:1 A(config-vrf)# route-target both 100:100 A(config-vrf)# exit A(config)# interface GigabitEthernet 0/1</pre>

```
A(config-if-GigabitEthernet 0/1)#
A(config-if-GigabitEthernet 0/1)# ip vrf forwarding vpn1
A(config-if-GigabitEthernet 0/1)# ip address 44.1.1.2 255.255.255.0
A(config-if-GigabitEthernet 0/1)# exit
A(config)# interface GigabitEthernet 0/2
A(config-if-GigabitEthernet 0/2)# ip vrf forwarding vpn1
A(config-if-GigabitEthernet 0/2)# ip address 45.1.1.2 255.255.255.0
A(config-if-GigabitEthernet 0/2)# exit
A(config)# interface GigabitEthernet 0/3
A(config-if-GigabitEthernet 0/3)# ip vrf forwarding vpn2
A(config-if-GigabitEthernet 0/3)# ip address 46.1.1.2 255.255.255.0
A(config-if-GigabitEthernet 0/3)# exit
A(config)# interface GigabitEthernet 0/4
A(config-if-GigabitEthernet 0/4)# ip vrf forwarding vpn2
A(config-if-GigabitEthernet 0/4)# ip address 47.1.1.2 255.255.255.0
A(config-if-GigabitEthernet 0/4)# exit
A(config)# ip route vrf vpn1 100.1.1.1 255.255.255.255 44.1.1.1
A(config)# ip route vrf vpn1 100.1.1.1 255.255.255.255 45.1.1.1
A(config)# ip route vrf vpn2 200.1.1.1 255.255.255.255 46.1.1.1
A(config)# ip route vrf vpn2 200.1.1.1 255.255.255.255 47.1.1.1
A(config)# router bgp 100
A(config-router)# address-family ipv4 vrf vpn1
A(config-router-af)# redistribute static
A(config-router-af)# maximum-paths ebgp 32
A(config-router-af)# bgp sourced-paths static all
A(config-router-af)# import path selection all
A(config-router-af)# exit-address-family
A(config-router)# address-family ipv4 vrf vpn2
A(config-router-af)# redistribute static
A(config-router-af)# maximum-paths ebgp 32
A(config-router-af)# bgp sourced-paths static all
A(config-router-af)# import path selection all
A(config-router-af)# exit-address-family
```

Verification	Run the show command to display the configurations.
<p>A</p>	<pre> A#show ip route vrf vpn1 Routing Table: vpn1 Codes: C - Connected, L - Local, S - Static R - RIP, O - OSPF, B - BGP, I - IS-IS, V - Overflow route N1 - OSPF NSSA external type 1, N2 - OSPF NSSA external type 2 E1 - OSPF external type 1, E2 - OSPF external type 2 SU - IS-IS summary, L1 - IS-IS level-1, L2 - IS-IS level-2 IA - Inter area, EV - BGP EVPN, A - Arp to host * - candidate default Gateway of last resort is no set C 44.1.1.0/24 is directly connected, GigabitEthernet 0/1 C 44.1.1.2/32 is local host. C 45.1.1.0/24 is directly connected, GigabitEthernet 0/2 C 45.1.1.2/32 is local host. S 100.1.1.1/32 [1/0] via 44.1.1.1 [1/0] via 45.1.1.1 B 200.1.1.1/32 [20/0] via 47.1.1.1, 02:32:01 [20/0] via 46.1.1.1, 02:32:01 A#show ip route vrf vpn2 Routing Table: vpn2 Codes: C - Connected, L - Local, S - Static R - RIP, O - OSPF, B - BGP, I - IS-IS, V - Overflow route N1 - OSPF NSSA external type 1, N2 - OSPF NSSA external type 2 E1 - OSPF external type 1, E2 - OSPF external type 2 SU - IS-IS summary, L1 - IS-IS level-1, L2 - IS-IS level-2 IA - Inter area, EV - BGP EVPN, A - Arp to host * - candidate default Gateway of last resort is no set </pre>

C	46.1.1.0/24 is directly connected, GigabitEthernet 0/3
C	46.1.1.2/32 is local host.
C	47.1.1.0/24 is directly connected, GigabitEthernet 0/4
C	47.1.1.2/32 is local host.
B	100.1.1.1/32 [20/0] via 45.1.1.1, 03:27:07
	[20/0] via 44.1.1.1, 03:27:07
S	200.1.1.1/32 [1/0] via 46.1.1.1
	[1/0] via 47.1.1.1

7.5.1 Configuring BMP Monitoring

Configuration Effect

- Enable BGP to be monitored by the BMP server.

Notes

None

Configuration Steps

↘ Creating a BMP Server Instance

- (Mandatory) Perform this configuration in global configuration mode.

↘ Configuring the Address and Port Number of the BMP Server

- (Mandatory) Perform this configuration in BMP configuration mode.

↘ Configuring the Source Address of a TCP Connection to the BMP Server

- (Optional) Perform this configuration in BMP configuration mode.

↘ Configuring the VRF Instance to Which a TCP Connection to the BMP Server Belongs

- (Optional) Perform this configuration in BMP configuration mode.

↘ Configuring the Interval to Establish a TCP Connection to the BMP Server

- (Optional) Perform this configuration in BMP configuration mode.

↘ Configuring the Description for BMP Instance

- (Optional) Perform this configuration in BMP configuration mode.

↘ Configuring the Max Bytes of Packet in Buffer for BMP Instance

- (Optional) Perform this configuration in BMP configuration mode.

↘ Configuring the BMP Server to Monitor Routing Information Received from a BGP Peer After the Routing Policy Is Applied

- (Optional) Perform this configuration in BMP configuration mode.
 - ↳ **Configuring the BMP Server to Monitor Unchanged Routing Information Received from a BGP Peer**
- (Optional) Perform this configuration in BMP configuration mode.
 - ↳ **Configuring the BMP Server to Monitor Routing Information Sent to a BGP Peer After the Routing Policy Is Applied**
- (Optional) Perform this configuration in BMP configuration mode.
 - ↳ **Configuring the BMP Server to Monitor BGP Peers**
- (Mandatory) Perform this configuration in BGP configuration mode.
 - ↳ **Configuring All BMP Servers to Monitor BGP Peers**
- (Optional) Perform this configuration in BGP configuration mode.
 - ↳ **Configuring the BMP Server to Monitor BGP Packets**
- (Optional) Perform this configuration in BGP configuration mode.
 - ↳ **Configuring the Interval for Sending Status Statistics to the BMP Server**
- (Optional) Perform this configuration in BGP configuration mode.

Verification

- Run the **show running-config** command to display the configurations.

Related Commands

↳ **Creating a BMP Server Instance**

Command	bmp server <i>server-number</i>
Parameter Description	<i>server-number</i> : Specifies the ID of a BMP server instance.
Command Mode	Global configuration mode
Usage Guide	N/A

↳ **Configuring the Address and Port Number of the BMP Server**

Command	address <i>bmp-server-address</i> port <i>port-number</i>
Parameter Description	<i>bmp-server-address</i> : Specifies the address of the BMP server. <i>port-number</i> : Specifies the port number of the BMP server.
Command Mode	BMP configuration mode
Usage Guide	N/A

↳ **Configuring the Source Address of a TCP Connection to the BMP Server**

Command	update-source <i>interface-type interface-number</i>
Parameter	<i>interface-type interface-number</i> : Indicates an interface name.

Description	
Command	BMP configuration mode
Mode	
Usage Guide	N/A

↘ **Configuring the VRF Instance to Which a TCP Connection to the BMP Server Belongs**

Command	vrf <i>vrf-name</i>
Parameter	<i>vrf-name</i> : Specifies the VRF instance name.
Description	
Command	BMP configuration mode
Mode	
Usage Guide	N/A

↘ **Configuring the Interval to Establish a TCP Connection to the BMP Server**

Command	failure-retry-delay <i>time</i>
Parameter	<i>Time</i> : Specifies the interval
Description	
Command	BMP configuration mode
Mode	
Usage Guide	N/A

↘ **Configuring the Description for BMP instance**

Command	description <i>text</i>
Parameter	<i>text</i> : Specifies the description for BMP instance.
Description	
Command	BMP configuration mode
Mode	
Usage Guide	N/A

↘ **Configuring the Max Bytes of Packet in Buffer for BMP Instance**

Command	buffer-size <i>maximum</i>
Parameter	<i>Maximum</i> : Configure the max bytes of packet in buffer for BMP instance.
Description	
Command	BMP configuration mode
Mode	
Usage Guide	Use this command to configure the max bytes of packet in buffer for BMP instance. When the device can not forward monitor packets due to insufficient server memory or other reasons, these packets will continually occupy the memory space, so there should be a limit of the max bytes of packet in buffer. When bytes reach the limit, the session with BMP server will be reset to release the space.

↘ **Configuring the BMP Server to Monitor Routing Information Received from a BGP Peer After the Routing Policy Is Applied**

Command	adj-rib-in post-policy
----------------	-------------------------------

Parameter Description	N/A
Command Mode	BMP configuration mode
Usage Guide	N/A

↘ Configuring the BMP Server to Monitor Unchanged Routing Information Received from a BGP Peer

Command	adj-rib-in pre-policy
Parameter Description	N/A
Command Mode	BMP configuration mode
Usage Guide	N/A

↘ Configuring the BMP Server to Monitor Routing Information Sent to a BGP Peer After the Routing Policy Is Applied

Command	adj-rib-out post-policy
Parameter Description	N/A
Command Mode	BMP configuration mode
Usage Guide	N/A

↘ Configuring the BMP Server to Monitor BGP Peers

Command	neighbor { neighbor-address peer-group-name } bmp-active { all server server-number [server-number [server-number]] }
Parameter Description	<i>neighbor-address</i> : Specifies the IPv4 or IPv6 address of a peer. <i>peer-group-name</i> : Specifies a peer group name. <i>server-number</i> : Specifies the ID of a BMP server instance.
Command Mode	BGP configuration mode
Usage Guide	N/A

↘ Configuring All BMP Servers to Monitor BGP Peers

Command	bgp bmp-active
Parameter Description	N/A
Command Mode	BGP configuration mode
Usage Guide	N/A

↘ Configuring the BMP Server to Monitor BGP Packets

Command	route mirroring
Parameter	N/A

Description	
Command	BMP configuration mode
Mode	
Usage Guide	N/A

↘ **Configuring the Interval for Sending Status Statistics to the BMP Server**

Command	stats-reporting-period <i>time</i>
Parameter	<i>time</i> : Specifies the interval.
Description	
Command	BMP configuration mode
Mode	
Usage Guide	N/A

Configuration Example

↘ **Configuring BMP Monitoring**

<p>Scenario Figure 1-26</p>	<p>The BGP peers established by devices A and B are monitored by the BMP server.</p>
<p>Configuration Steps</p>	<ul style="list-style-type: none"> ● Configure the BGP peers. ● Create a BMP server instance. ● Configure the address and port number of the BMP server. ● Configure the types of routes to be monitored by the BMP server. ● Configure the BMP server to monitor BGP peers.
<p>A</p>	<pre>A#configure A(config)#interface tenGigabitEthernet 0/1 A(config-if-TenGigabitEthernet 0/1)#ip address 11.1.1.1 24 A(config-if-TenGigabitEthernet 0/1)#end A(config)#bmp server 1 A(config-bmpsrvr)#address 11.1.1.2 port 12345 A(config-bmpsrvr)#update-source tenGigabitEthernet 0/1 A(config-bmpsrvr)#adj-rib-in post-policy A(config)#interface tenGigabitEthernet 0/2 A(config-if-TenGigabitEthernet 0/2)#ip address 10.1.1.1 24 A(config)#router bgp 100 A(config-router)#neighbor 10.1.1.2 remote-as 100 A(config-router)#neighbor 10.1.1.2 bmp-active server 1</pre>
<p>B</p>	<pre>B#configure</pre>

	<pre> B(config)#interface tenGigabitEthernet 0/2 B(config-if-TenGigabitEthernet 0/2)#ip address 10.1.1.2 24 B(config)#router bgp 100 B(config-router)#neighbor 10.1.1.1 remote-as 100 </pre>
Verification	Run the show command to display the configurations.
A	<pre> A# #show bgp all summary For address family: IPv4 Unicast BGP router identifier 7.7.7.7, local AS number 100 BGP table version is 1 1 BGP AS-PATH entries 0 BGP Community entries 25 BGP Prefix entries (Maximum-prefix:262144) Neighbor V AS MsgRcvd MsgSent TblVer InQ OutQ Up/Down State/PfxRcd 10.1.1.2 4 100 0 0 0 0 0 05:36:32 23 A#show bgp bmp neighbor Neighbor CfgSvr# ActSvr# 10.1.1.2 1 1 A#show bgp bmp summary ID Host Port State Time NBRs 1 11.1.1.2 12345 Established 05:36:12 1 </pre>

7.5.2 Configuring Domain of Neighbor

Configuration Effect

- Configure to not suppress detailed routings in the domain group of neighbor.

Notes

None

Configuration Steps

↘ Configuring Domain Group of Neighbor

- (Mandatory) Perform this configuration in global configuration mode.

↘ Configuring to not Suppress Detailed Routings in Domain Group of Neighbor

- (Mandatory) Perform this configuration in global configuration mode.

Verification

- Run the **show running-config** command to display the configurations.

Related Commands

▾ **Configuring Domain Group of Neighbor**

Command	neighbor { <i>neighbor-address</i> <i>peer-group-name</i> } domain <i>domain-name</i>
Parameter	<i>neighbor-address</i> : IP address of the peer
Description	<i>peer-group-name</i> : Name of the peer group <i>domain-name</i> : Domain name
Command Mode	Global configuration mode
Usage Guide	N/A

▾ **Configuring to not Suppress Detailed Routing in Domain Group of Neighbor**

Command	neighbor { <i>neighbor-address</i> <i>peer-group-name</i> } domain-unsuppress
Parameter	<i>neighbor-address</i> : IP address of the peer
Description	<i>peer-group-name</i> : Name of the peer group
Command Mode	Global configuration mode
Usage Guide	N/A

Configuration Example

▾ **Configuring Domain Group of Neighbor**

<p>Scenario Figure 1-27</p>	
<p>Configuration Steps</p>	<ul style="list-style-type: none"> ● Run BGP protocol on all devices, set AS numbers as the figure shows ● Configure Loopback on A, B and C to establish IBGP neighbor ● Establish EBGP neighbor between C and D ● Create IBGP peer group on C ● Configure host route 11.1.1.1 on D ● Configure domain test on C to neighbors of A and D, and configure domain-suppress to neighbors of A
<p>A</p>	<pre>A# configure terminal A(config)# interface loopback 0 A(config-if-Loopback 0)# ip address 10.1.1.1 255.255.255.255</pre>

	<pre>A(config-if-Loopback 0)# exit A(config)# interface GigabitEthernet 0/1 A(config-if-GigabitEthernet 0/1)# ip address 192.168.1.1 255.255.255.0 A(config-if-GigabitEthernet 0/1)# exit A(config)# router bgp 65536 A(config-router)# neighbor 10.1.1.3 remote-as 65536 A(config-router)# neighbor 10.1.1.3 update-source loopback 0</pre>
B	<pre>B# configure terminal B(config)# interface loopback 0 B(config-if-Loopback 0)# ip address 10.1.1.2 255.255.255.255 B(config-if-Loopback 0)# exit B(config)# interface GigabitEthernet 0/1 B(config-if-GigabitEthernet 0/1)# ip address 192.168.2.2 255.255.255.0 B(config-if-GigabitEthernet 0/1)# exit B(config)# router bgp 65536 B(config-router)# neighbor 10.1.1.3 remote-as 65536 B(config-router)# neighbor 10.1.1.3 update-source loopback 0</pre>
C	<pre>C# configure terminal C(config)# interface loopback 0 C(config-if-Loopback 0)# ip address 10.1.1.3 255.255.255.255 C(config-if-Loopback 0)# exit C(config)# interface GigabitEthernet 0/1 C(config-if-GigabitEthernet 0/1)# ip address 192.168.1.3 255.255.255.0 C(config-if-GigabitEthernet 0/1)# exit C(config)# interface GigabitEthernet 0/2 C(config-if-GigabitEthernet 0/2)# ip address 192.168.2.3 255.255.255.0 C(config-if-GigabitEthernet 0/2)# exit C(config)# interface GigabitEthernet 0/3 C(config-if-GigabitEthernet 0/3)# ip address 192.168.3.3 255.255.255.0 C(config-if-GigabitEthernet 0/3)# exit C(config)# router bgp 65536 C(config-router)# neighbor 10.1.1.1 remote-as 65536 C(config-router)# neighbor 10.1.1.1 update-source loopback 0 C(config-router)# neighbor 10.1.1.1 domain test C(config-router)# neighbor 10.1.1.1 domain-suppress C(config-router)# neighbor 10.1.1.2 remote-as 65536 C(config-router)# neighbor 10.1.1.2 update-source loopback 0 C(config-router)# neighbor 192.168.3.4 remote-as 65537 C(config-router)# neighbor 192.168.3.4 domain test C(config-router)# aggregate-address 11.0.0.0 255.0.0.0 summary-only</pre>
D	<pre>D# configure terminal D(config)# interface loopback 0 D(config-if-Loopback 0)# ip address 11.1.1.1 255.255.255.255 D(config)# interface GigabitEthernet 0/1</pre>

	<pre>D(config-if-GigabitEthernet 0/1)# ip address 192.168.3.4 255.255.255.0 D(config-if-GigabitEthernet 0/1)# exit D(config)# router bgp 65537 D(config-router)# neighbor 192.168.3.3 remote-as 65536 D(config-router)# network 11.1.1.1 mask 255.255.255.255</pre>
Verification	Run the show command to display the configurations.
A	<pre>A# show ip bgp neighbor BGP neighbor is 10.1.1.3, remote AS 65536, local AS 65536, internal link BGP version 4, remote router ID 10.1.1.3 BGP state = Established, up for 00:00:05 Last read , hold time is 180, keepalive interval is 60 seconds Neighbor capabilities: Route refresh: advertised and received (old and new) Four-octets ASN Capability: advertised and received Address family IPv4 Unicast: advertised and received Received 2 messages, 0 notifications, 0 in queue open message:1 update message:0 keepalive message:1 refresh message:0 dynamic cap:0 notifications:0 Sent 2 messages, 0 notifications, 0 in queue open message:1 update message:0 keepalive message:1 refresh message:0 dynamic cap:0 notifications:0 Route refresh request: received 0, sent 0 Minimum time between advertisement runs is 0 seconds Update source is Loopback 0 For address family: IPv4 Unicast BGP table version 1, neighbor version 1 Index 0, Offset 0, Mask 0x1 0 accepted prefixes 0 announced prefixes Connections established 1; dropped 0 Local host: 10.1.1.1, Local port: 1039 Foreign host: 10.1.1.3, Foreign port: 179 Nexthop: 10.1.1.1 Nexthop global: :: Nexthop local: :: BGP connection: non shared network Last Reset: , due to BGP Notification received Notification Error Message: (Cease/Other Configuration Change.) A#show ip bgp BGP table version is 3, local router ID is 10.1.1.3 Status codes: s suppressed, d damped, h history, * valid, > best, i - internal, S Stale, b - backup entry, m - multipath, f Filter</pre>

	<p>Origin codes: i - IGP, e - EGP, ? - incomplete</p> <table border="1"> <thead> <tr> <th>Network</th> <th>Next Hop</th> <th>Metric</th> <th>LocPrf</th> <th>Weight</th> <th>Path</th> </tr> </thead> <tbody> <tr> <td>*> 11.0.0.0</td> <td>10.1.1.3</td> <td>0</td> <td></td> <td>0</td> <td>i</td> </tr> <tr> <td>*> 11.1.1.1</td> <td>192.168.3.4</td> <td>0</td> <td></td> <td>0</td> <td>65537 i</td> </tr> </tbody> </table>	Network	Next Hop	Metric	LocPrf	Weight	Path	*> 11.0.0.0	10.1.1.3	0		0	i	*> 11.1.1.1	192.168.3.4	0		0	65537 i
Network	Next Hop	Metric	LocPrf	Weight	Path														
*> 11.0.0.0	10.1.1.3	0		0	i														
*> 11.1.1.1	192.168.3.4	0		0	65537 i														
<p>B</p>	<pre> B# show ip bgp neighbor BGP neighbor is 10.1.1.3, remote AS 65536, local AS 65536, internal link BGP version 4, remote router ID 10.1.1.3 BGP state = Established, up for 00:00:07 Last read , hold time is 180, keepalive interval is 60 seconds Neighbor capabilities: Route refresh: advertised and received (old and new) Four-octets ASN Capability: advertised and received Address family IPv4 Unicast: advertised and received Received 2 messages, 0 notifications, 0 in queue open message:1 update message:0 keepalive message:1 refresh message:0 dynamic cap:0 notifications:0 Sent 2 messages, 0 notifications, 0 in queue open message:1 update message:0 keepalive message:1 refresh message:0 dynamic cap:0 notifications:0 Route refresh request: received 0, sent 0 Minimum time between advertisement runs is 0 seconds Update source is Loopback 0 For address family: IPv4 Unicast BGP table version 1, neighbor version 1 Index 0, Offset 0, Mask 0x1 0 accepted prefixes 0 announced prefixes Connections established 1; dropped 0 Local host: 10.1.1.2, Local port: 1041 Foreign host: 10.1.1.3, Foreign port: 179 Nexthop: 10.1.1.2 Nexthop global: :: Nexthop local: :: BGP connection: non shared network Last Reset: , due to BGP Notification received Notification Error Message: (Cease/Other Configuration Change.) B#show ip bgp BGP table version is 3, local router ID is 10.1.1.3 Status codes: s suppressed, d damped, h history, * valid, > best, i - internal, S Stale, b - backup entry, m - multipath, f Filter Origin codes: i - IGP, e - EGP, ? - incomplete </pre>																		

	Network	Next Hop	Metric	LocPrf	Weight Path
	*> 11.0.0.0	10.1.1.3	0		0 i
C	<pre> C# show ip bgp neighbor BGP neighbor is 10.1.1.1, remote AS 65536, local AS 65536, internal link Member of peer-group ibgp-group for session parameters BGP version 4, remote router ID 10.1.1.1 BGP state = Established, up for 00:01:13 Last read , hold time is 180, keepalive interval is 60 seconds Neighbor capabilities: Route refresh: advertised and received (old and new) Four-octets ASN Capability: advertised and received Address family IPv4 Unicast: advertised and received Received 3 messages, 0 notifications, 0 in queue open message:1 update message:0 keepalive message:2 refresh message:0 dynamic cap:0 notifications:0 Sent 3 messages, 0 notifications, 0 in queue open message:1 update message:0 keepalive message:2 refresh message:0 dynamic cap:0 notifications:0 Route refresh request: received 0, sent 0 Minimum time between advertisement runs is 0 seconds Update source is Loopback 0 peer belong to domain test peer domain unsuppress For address family: IPv4 Unicast BGP table version 1, neighbor version 1 Index 1, Offset 0, Mask 0x2 ibgp-group peer-group member 0 accepted prefixes 0 announced prefixes Connections established 1; dropped 0 Local host: 10.1.1.3, Local port: 179 Foreign host: 10.1.1.1, Foreign port: 1039 Nexthop: 10.1.1.3 Nexthop global: :: Nexthop local: :: BGP connection: non shared network BGP neighbor is 10.1.1.2, remote AS 65536, local AS 65536, internal link Member of peer-group ibgp-group for session parameters BGP version 4, remote router ID 10.1.1.2 BGP state = Established, up for 00:01:17 </pre>				

<pre>Last read , hold time is 180, keepalive interval is 60 seconds Neighbor capabilities: Route refresh: advertised and received (old and new) Four-octets ASN Capability: advertised and received Address family IPv4 Unicast: advertised and received Received 3 messages, 0 notifications, 0 in queue open message:1 update message:0 keepalive message:2 refresh message:0 dynamic cap:0 notifications:0 Sent 3 messages, 0 notifications, 0 in queue open message:1 update message:0 keepalive message:2 refresh message:0 dynamic cap:0 notifications:0 Route refresh request: received 0, sent 0 Minimum time between advertisement runs is 0 seconds Update source is Loopback 0 For address family: IPv4 Unicast BGP table version 1, neighbor version 1 Index 1, Offset 0, Mask 0x2 ibgp-group peer-group member 0 accepted prefixes 0 announced prefixes Connections established 1; dropped 0 Local host: 10.1.1.3, Local port: 179 Foreign host: 10.1.1.2, Foreign port: 1041 Nexthop: 10.1.1.3 Nexthop global: :: Nexthop local: :: BGP connection: non shared network BGP neighbor is 192.168.3.4, remote AS 65536, local AS 65536, internal link Member of peer-group ibgp-group for session parameters BGP version 4, remote router ID 192.168.3.4 BGP state = Established, up for 00:01:01 Last read , hold time is 180, keepalive interval is 60 seconds Neighbor capabilities: Route refresh: advertised and received (old and new) Four-octets ASN Capability: advertised and received Address family IPv4 Unicast: advertised and received Received 3 messages, 0 notifications, 0 in queue open message:1 update message:0 keepalive message:2 refresh message:0 dynamic cap:0 notifications:0 Sent 3 messages, 0 notifications, 0 in queue open message:1 update message:0 keepalive message:2</pre>

	<pre> refresh message:0 dynamic cap:0 notifications:0 Route refresh request: received 0, sent 0 Minimum time between advertisement runs is 0 seconds Update source is Loopback 0 peer belong to domain test For address family: IPv4 Unicast BGP table version 1, neighbor version 1 Index 1, Offset 0, Mask 0x2 ibgp-group peer-group member 0 accepted prefixes 0 announced prefixes Connections established 1; dropped 0 Local host: 192.168.3.3, Local port: 179 Foreign host: 192.168.3.4, Foreign port: 1018 Nexthop: 192.168.3.3 Nexthop global: :: Nexthop local: :: BGP connection: non shared network </pre>
<p>D</p>	<pre> D# show ip bgp neighbor BGP neighbor is 192.168.3.3, remote AS 65536, local AS 65536, internal link Member of peer-group ibgp-group for session parameters BGP version 4, remote router ID 10.1.1.3 BGP state = Established, up for 00:01:01 Last read , hold time is 180, keepalive interval is 60 seconds Neighbor capabilities: Route refresh: advertised and received (old and new) Four-octets ASN Capability: advertised and received Address family IPv4 Unicast: advertised and received Received 3 messages, 0 notifications, 0 in queue open message:1 update message:0 keepalive message:2 refresh message:0 dynamic cap:0 notifications:0 Sent 3 messages, 0 notifications, 0 in queue open message:1 update message:0 keepalive message:2 refresh message:0 dynamic cap:0 notifications:0 Route refresh request: received 0, sent 0 Minimum time between advertisement runs is 0 seconds Update source is Loopback 0 For address family: IPv4 Unicast BGP table version 1, neighbor version 1 Index 1, Offset 0, Mask 0x2 ibgp-group peer-group member </pre>

	0 accepted prefixes 0 announced prefixes Connections established 1; dropped 0 Local host: 192.168.3.4, Local port: 1018 Foreign host: 192.168.3.3, Foreign port: 179 Nexthop: 192.168.3.4 Nexthop global: :: Nexthop local: :: BGP connection: non shared network
--	---

7.5.3 Configuring Link State Tracking Group of Neighbor

Configuration Effect

- Associate the link state tracking group for the BGP neighbor.

Notes

None

Configuration Steps

↘ Enabling BGP Protocol

- (Mandatory) Perform this configuration in global configuration mode.

↘ Creating BGP Neighbor

- (Mandatory) Perform this configuration in BGP configuration mode.

↘ Creating Link State Tracking Group Associated with BGP Neighbor

- (Mandatory) Perform this configuration in BGP configuration mode.

↘ Configuring Delay Time to Enable Downlink Port of Link State Tracking Group after BGP Neighbor is up

- (Mandatory) Perform this configuration in BGP configuration mode.

↘ Configuring Link State Tracking Group Associated with Port

- (Mandatory) Perform this configuration in interface configuration mode.

Verification

- Run the **show running-config** command to display the configurations.

Related Commands

↘ Enabling BGP Protocol

Command	router bgp <i>as-number</i> [instance <i>instance-name</i>]
Parameter	<i>as-number</i> : AS number. Range: 1..4294967295

Description	instance: The instance should be specified for the non-default instance, and the instance name is required. <i>instance-name:</i> Instance name of 1 to 32 characters.
Command Mode	Global configuration mode
Usage Guide	N/A

↘ Creating BGP Neighbor

Command	neighbor { <i>neighbor-address</i> <i>peer-group-name</i> } remote-as <i>as-number</i>
Parameter Description	<i>neighbor-address:</i> IP address of the peer <i>peer-group-name:</i> Name of the peer group <i>as-number:</i> AS number of peer (group)
Command Mode	BGP configuration mode
Usage Guide	AS number specified for peer (group) should be consistent with the AS number of peer BGP Speaker

↘ Creating Link State Tracking Group Associated with BGP Neighbor

Command	neighbor { <i>neighbor-address</i> <i>peer-group-name</i> } link state group <i>num</i>
Parameter Description	<i>neighbor-address:</i> IP address of the peer <i>peer-group-name:</i> Name of the peer group <i>num:</i> Link state tracking group ID
Command Mode	BGP configuration mode
Usage Guide	N/A

↘ Configuring Delay Time to Enable Downlink Port of Link State Tracking Group after BGP Neighbor is up

Command	bgp link-state-group up-delay <i>delay-time</i>
Parameter Description	<i>delay-time:</i> Delay time
Command Mode	BGP configuration mode
Usage Guide	

↘ Adding Port to Specified Link State Tracking Group

Command	link state group <i>num</i> { upstream downstream }
Parameter Description	<i>num:</i> Link state tracking group ID upstream: Configure the port as the uplink port of link state tracking group downstream: Configure the port as the downlink port of link state tracking group
Command Mode	Interface configuration mode
Usage Guide	N/A

Configuration Example

↘ Configuring BGP MD5 Verification

<p>Scenario Figure 1-28</p>	
<p>Configuration Steps</p>	<ul style="list-style-type: none"> ● Run BGP protocol on all devices, set AS numbers as the figure shows ● Configure Loopback on B and C to establish IBGP neighbor ● Establish EBGP neighbor between A and B ● Configure link state tracking group 1 on GE 0/2 on B ● On B, associate link state tracking group 1 with A's neighbor
<p>A</p>	<pre>A# configure terminal A(config)# interface GigabitEthernet 0/1 A(config-if-GigabitEthernet 0/1)# ip address 192.168.1.1 255.255.255.0 A(config-if-GigabitEthernet 0/1)# exit A(config)# router bgp 65537 A(config-router)# neighbor 192.168.1.2 remote-as 65536 A(config-router)# neighbor 192.168.1.2 password 7 ebgpneighbor</pre>
<p>B</p>	<pre>B# configure terminal B(config)# interface loopback 0 B(config-if-Loopback 0)# ip address 10.1.1.1 255.255.255.255 B(config-if-Loopback 0)# exit B(config)# interface GigabitEthernet 0/1 B(config-if-GigabitEthernet 0/1)# ip address 192.168.1.2 255.255.255.0 B(config-if-GigabitEthernet 0/1)# exit B(config)# interface GigabitEthernet 0/2 B(config-if-GigabitEthernet 0/2)# ip address 192.168.2.2 255.255.255.0 B(config-if-GigabitEthernet 0/2)# link state group 1 downstream B(config-if-GigabitEthernet 0/2)# exit B(config)# router bgp 65536 B(config-router)# neighbor 10.1.1.2 remote-as 65536 B(config-router)# neighbor 10.1.1.2 update-source loopback 0 B(config-router)# neighbor 10.1.1.2 password ibgpneighbor B(config-router)# neighbor 192.168.1.1 remote-as 65537 B(config-router)# neighbor 192.168.1.1 link state group 1</pre>
<p>C</p>	<pre>C# configure terminal C(config)# interface loopback 0 C(config-if-Loopback 0)# ip address 10.1.1.2 255.255.255.255 C(config-if-Loopback 0)# exit C(config)# interface GigabitEthernet 0/1 C(config-if-GigabitEthernet 0/1)# ip address 192.168.2.3 255.255.255.0</pre>

	<pre>C(config-if-GigabitEthernet 0/1)# exit C(config)# router bgp 65536 C(config-router)# neighbor 10.1.1.1 remote-as 65536 C(config-router)# neighbor 10.1.1.1 update-source loopback 0 C(config-router)# neighbor 10.1.1.1 password ibgpneighbor</pre>
Verification	Run the show command to display the configurations.
A	<pre>A#show ip bgp neighbors BGP neighbor is 192.168.1.2, remote AS 65536, local AS 65537, external link BGP version 4, remote router ID 10.1.1.1 BGP state = Established, up for 00:04:54 Last read , hold time is 180, keepalive interval is 60 seconds Neighbor capabilities: Route refresh: advertised and received (old and new) Four-octets ASN Capability: advertised and received Address family IPv4 Unicast: advertised and received Received 7 messages, 0 notifications, 0 in queue open message:1 update message:0 keepalive message:6 refresh message:0 dynamic cap:0 notifications:0 Sent 7 messages, 0 notifications, 0 in queue open message:1 update message:0 keepalive message:6 refresh message:0 dynamic cap:0 notifications:0 Route refresh request: received 0, sent 0 Minimum time between advertisement runs is 30 seconds For address family: IPv4 Unicast BGP table version 1, neighbor version 0 Index 1, Offset 0, Mask 0x2 0 accepted prefixes 0 announced prefixes Connections established 2; dropped 1 Local host: 192.168.1.1, Local port: 1026 Foreign host: 192.168.1.2, Foreign port: 179 Nexthop: 192.168.1.1 Nexthop global: :: Nexthop local: :: BGP connection: non shared network Last Reset: 00:04:54, due to BGP Notification sent Notification Error Message: (Cease/Administratively Reset.)</pre>
B	<pre>B# show ip bgp neighbors BGP neighbor is 10.1.1.2, remote AS 65536, local AS 65536, internal link BGP version 4, remote router ID 10.1.1.2 BGP state = Established, up for 00:04:01 Last read , hold time is 180, keepalive interval is 60 seconds</pre>

```

Neighbor capabilities:
  Route refresh: advertised and received (old and new)
  Four-octets ASN Capability: advertised and received
  Address family IPv4 Unicast: advertised and received
Received 8 messages, 0 notifications, 0 in queue
  open message:1 update message:0 keepalive message:7
  refresh message:0 dynamic cap:0 notifications:0
Sent 8 messages, 0 notifications, 0 in queue
  open message:1 update message:0 keepalive message:7
  refresh message:0 dynamic cap:0 notifications:0
Route refresh request: received 0, sent 0
Minimum time between advertisement runs is 30 seconds

For address family: IPv4 Unicast
  BGP table version 1, neighbor version 0
  Index 1, Offset 0, Mask 0x2
  0 accepted prefixes
  0 announced prefixes

Connections established 2; dropped 1
Local host: 10.1.1.1, Local port: 179
Foreign host: 10.1.1.2, Foreign port: 1038
Nexthop: 10.1.1.1
Nexthop global: ::
Nexthop local: ::
BGP connection: non shared network
Last Reset: 00:05:27, due to BGP Notification received
Notification Error Message: (Cease/Administratively Reset.)

BGP neighbor is 192.168.1.1, remote AS 65537, local AS 65536, external link
  BGP version 4, remote router ID 192.168.1.1
  BGP state = Established, up for 00:05:27
  Last read          , hold time is 180, keepalive interval is 60 seconds
Neighbor capabilities:
  Route refresh: advertised and received (old and new)
  Four-octets ASN Capability: advertised and received
  Address family IPv4 Unicast: advertised and received
Received 8 messages, 0 notifications, 0 in queue
  open message:1 update message:0 keepalive message:7
  refresh message:0 dynamic cap:0 notifications:0
Sent 8 messages, 0 notifications, 0 in queue
  open message:1 update message:0 keepalive message:7
  refresh message:0 dynamic cap:0 notifications:0
Route refresh request: received 0, sent 0
    
```

	<p>Minimum time between advertisement runs is 30 seconds</p> <p>Link state group 1</p> <p>For address family: IPv4 Unicast</p> <p>BGP table version 1, neighbor version 0</p> <p>Index 1, Offset 0, Mask 0x2</p> <p>0 accepted prefixes</p> <p>0 announced prefixes</p> <p>Connections established 2; dropped 1</p> <p>Local host: 192.168.1.2, Local port: 179</p> <p>Foreign host: 192.168.1.1, Foreign port: 1026</p> <p>Nexthop: 192.168.1.2</p> <p>Nexthop global: ::</p> <p>Nexthop local: ::</p> <p>BGP connection: non shared network</p> <p>Last Reset: 00:05:27, due to BGP Notification received</p> <p>Notification Error Message: (Cease/Administratively Reset.)</p>
<p>C</p>	<p>C# show ip bgp neighbors</p> <p>BGP neighbor is 10.1.1.1, remote AS 65536, local AS 65536, internal link</p> <p>BGP version 4, remote router ID 10.1.1.1</p> <p>BGP state = Established, up for 00:04:01</p> <p>Last read , hold time is 180, keepalive interval is 60 seconds</p> <p>Neighbor capabilities:</p> <ul style="list-style-type: none"> Route refresh: advertised and received (old and new) Four-octets ASN Capability: advertised and received Address family IPv4 Unicast: advertised and received <p>Received 8 messages, 0 notifications, 0 in queue</p> <ul style="list-style-type: none"> open message:1 update message:0 keepalive message:7 refresh message:0 dynamic cap:0 notifications:0 <p>Sent 8 messages, 0 notifications, 0 in queue</p> <ul style="list-style-type: none"> open message:1 update message:0 keepalive message:7 refresh message:0 dynamic cap:0 notifications:0 <p>Route refresh request: received 0, sent 0</p> <p>Minimum time between advertisement runs is 30 seconds</p> <p>For address family: IPv4 Unicast</p> <p>BGP table version 1, neighbor version 0</p> <p>Index 1, Offset 0, Mask 0x2</p> <p>0 accepted prefixes</p> <p>0 announced prefixes</p> <p>Connections established 2; dropped 1</p> <p>Local host: 10.1.1.2, Local port: 1038</p>

Foreign host: 10.1.1.1, Foreign port: 179 Nexthop: 10.1.1.2 Nexthop global: :: Nexthop local: :: BGP connection: non shared network Last Reset: 00:05:27, due to BGP Notification received Notification Error Message: (Cease/Administratively Reset.)
--

7.5.4 Configuring BGP Additional Paths

Configuration Effect

- Configure the BGP add-path to receive multiple routes with the same prefix from an IBGP neighbor.

Notes

None

Configuration Steps

↘ Enabling BGP Protocol

- (Mandatory) Perform this configuration in global configuration mode.

↘ Creating BGP Neighbor

- (Mandatory) Perform this configuration in BGP configuration mode.

↘ Enabling add-path Route Preference

- (Mandatory) Perform this configuration in BGP configuration mode.

↘ Advertising add-path Routes to Peer

- (Mandatory) Perform this configuration in BGP configuration mode.

↘ Enabling add-path Capability on Specified Peer

- (Mandatory) Perform this configuration in interface configuration mode.

Verification

- Run the **show running-config** command to display the configurations.

Related Commands

↘ Enabling BGP Protocol

Command	router bgp <i>as-number</i> [instance <i>instance-name</i>]
Parameter	<i>as-number</i> : AS number. Range: 1..4294967295
Description	instance : The instance should be specified for the non-default instance, and the instance name is required. <i>instance-name</i> : Instance name of 1 to 32 characters.
Command	Global configuration mode

Mode	
Usage Guide	N/A

↘ Creating BGP Neighbor

Command	neighbor { <i>peer-address</i> <i>peer-group-name</i> } remote-as <i>as-number</i>
Parameter	<i>peer-address</i> : IP address of the peer
Description	<i>peer-group-name</i> : Name of the peer group <i>as-number</i> : AS number of peer (group)
Command Mode	BGP configuration mode
Usage Guide	AS number specified for peer (group) should be consistent with the AS number of peer BGP Speaker

↘ Enabling add-path Route Preference

Command	bgp additional-paths select { all best <i>number</i> ecmp }
Parameter	all : Select all valid routes as the add-path routes in the type of "all".
Description	best <i>number</i> : Select the next-best routes as the add-path routes in the type of "best number". Range of number: 2-3. ecmp : Select the ecmp routes as the add-path routes in the type of "ecmp". Additional configuration is needed to select the ecmp routes.
Command Mode	BGP configuration mode
Usage Guide	N/A

↘ Advertising add-path Routes to Peer

Command	neighbor { <i>peer-address</i> <i>peer-group-name</i> } advertise additional-paths { all best <i>number</i> ecmp }
Parameter	<i>peer-address</i> : IP address of the peer
Description	<i>peer-group-name</i> : Name of the peer group all : Select all valid routes as the add-path alternative routes in the type of "all" best <i>number</i> : Select the next-best routes as the add-path alternative routes in the type of "best number". Range of number: 2-3. ecmp : Select the ecmp routes as the add-path alternative routes in the type of "ecmp". Additional configuration is needed to select the ecmp routes.
Command Mode	BGP configuration mode
Usage Guide	

↘ Enabling add-path Capability on Specified Peer

Command	neighbor { <i>peer-address</i> <i>peer-group-name</i> } additional-paths { send [receive] receive }
Parameter	<i>peer-address</i> : IP address of the peer
Description	<i>peer-group-name</i> : Name of the peer group send : Enable the device to send the add-path route. Only when the peer enables the receive capability, the device can advertise the add-path route. receive : Enable the device to receive the add-path route. Only when the peer enables the send capability, the device can receive the add-path route.
Command Mode	BGP configuration mode

Mode	
Usage Guide	N/A

Configuration Example

↘ **Configuring BGP add-path**

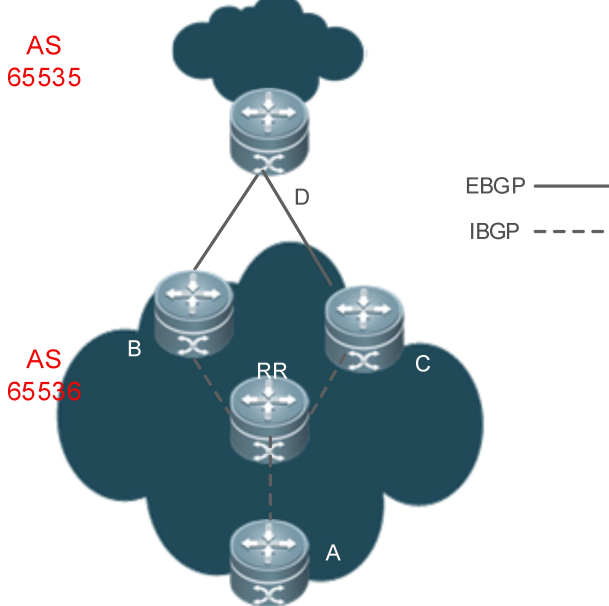
<p>Scenario Figure 1-28</p>	
<p>Configuration Steps</p>	<ul style="list-style-type: none"> ● Configure the interconnection addresses among A, B, C, D and RR, configure the IBGP peer among A, B, C and RR which is the BGP RR, and configure the EBGP peer between B and D/C and D. ● Configure the loopback address on D and advertise it to BGP. ● Enable RR to advertise the add-path route, and enable A to receive the add-path route.
<p>A</p>	<pre>A# configure terminal A(config)# interface GigabitEthernet 0/1 A(config-if-GigabitEthernet 0/1)# ip address 192.168.1.1 255.255.255.0 A(config-if-GigabitEthernet 0/1)# exit A(config)# router bgp 65536 A(config-router)# neighbor 192.168.1.5 remote-as 65536 A(config-router)# neighbor 192.168.1.5 additional-paths receive</pre>
<p>B</p>	<pre>B# configure terminal B(config)# interface GigabitEthernet 0/1 B(config-if-GigabitEthernet 0/1)# ip address 192.168.2.2 255.255.255.0 B(config-if-GigabitEthernet 0/1)# exit B(config)# interface GigabitEthernet 0/2 B(config-if-GigabitEthernet 0/2)# ip address 192.168.4.2 255.255.255.0 B(config-if-GigabitEthernet 0/2)# exit B(config)# router bgp 65536 B(config-router)# neighbor 192.168.2.5 remote-as 65536 B(config-router)# neighbor 192.168.4.4 remote-as 65535</pre>
<p>C</p>	<pre>C# configure terminal</pre>

	<pre> C(config)# interface GigabitEthernet 0/1 C(config-if-GigabitEthernet 0/1)# ip address 192.168.3.3 255.255.255.0 C(config-if-GigabitEthernet 0/1)# exit C(config)# interface GigabitEthernet 0/2 C(config-if-GigabitEthernet 0/2)# ip address 192.168.5.3 255.255.255.0 C(config-if-GigabitEthernet 0/2)# exit C(config)# router bgp 65536 C(config-router)# neighbor 192.168.3.5 remote-as 65536 C(config-router)# neighbor 192.168.5.4 remote-as 65535 </pre>
D	<pre> C# configure terminal C(config)# interface loopback 0 C(config-if-Loopback 0)# ip address 10.1.1.4 255.255.255.255 C(config-if-Loopback 0)# exit C(config)# interface GigabitEthernet 0/1 C(config-if-GigabitEthernet 0/1)# ip address 192.168.4.4 255.255.255.0 C(config-if-GigabitEthernet 0/1)# exit C(config)# interface GigabitEthernet 0/1 C(config-if-GigabitEthernet 0/1)# ip address 192.168.5.4 255.255.255.0 C(config-if-GigabitEthernet 0/1)# exit C(config)# router bgp 65535 C(config-router)# neighbor 192.168.4.2 remote-as 65536 C(config-router)# neighbor 192.168.5.3 remote-as 65536 C(config-router)# network 10.1.1.4 mask 255.255.255.255 </pre>
RR	<pre> RR# configure terminal C(config)# interface loopback 0 C(config-if-Loopback 0)# ip address 10.1.1.5 255.255.255.255 C(config-if-Loopback 0)# exit RR(config)# interface GigabitEthernet 0/1 RR(config-if-GigabitEthernet 0/1)# ip address 192.168.1.5 255.255.255.0 RR(config-if-GigabitEthernet 0/1)# exit RR(config)# interface GigabitEthernet 0/2 RR(config-if-GigabitEthernet 0/2)# ip address 192.168.2.5 255.255.255.0 RR(config-if-GigabitEthernet 0/2)# exit RR(config)# interface GigabitEthernet 0/3 RR(config-if-GigabitEthernet 0/3)# ip address 192.168.3.5 255.255.255.0 RR(config-if-GigabitEthernet 0/3)# exit R4(config)#ip route 192.168.4.0 255.255.255.0 192.168.2.2 R4(config)#ip route 192.168.5.0 255.255.255.0 192.168.3.3 RR(config)# router bgp 65536 RR(config-router)# bgp additional-paths select best 2 RR(config-router)# neighbor 192.168.1.1 remote-as 65536 RR(config-router)# neighbor 192.168.1.1 route-reflector-client RR(config-router)# neighbor 192.168.2.2 remote-as 65536 RR(config-router)# neighbor 192.168.2.2 route-reflector-client </pre>

	<pre>RR(config-router)# neighbor 192.168.3.3 remote-as 65536 RR(config-router)# neighbor 192.168.3.3 route-reflector-client RR(config-router)# neighbor 192.168.1.1 advertise additional-paths best 2 RR(config-router)# neighbor 192.168.1.1 additional-paths send</pre>
Verification	Run the show command to display the configurations.
RR	<pre>RR# show ip bgp BGP table version is 3, local router ID is 10.1.1.5 Status codes: s suppressed, d damped, h history, * valid, > best, i - internal, S Stale, b - backup entry, a additional-path Origin codes: i - IGP, e - EGP, ? - incomplete Network Next Hop Metric LocPrf Weight Path * ia10.1.1.4/32 192.168.4.4 0 100 0 65535 i *>i 192.168.5.4 0 100 0 65535 i Total number of prefixes 2</pre>
A	<pre>A# show ip bgp BGP table version is 2, local router ID is 192.168.1.1 Status codes: s suppressed, d damped, h history, * valid, > best, i - internal, S Stale, b - backup entry, a additional-path Origin codes: i - IGP, e - EGP, ? - incomplete Network Next Hop Metric LocPrf Weight Path * i 10.1.1.4/32 192.168.5.4 0 100 0 65535 i * i 192.168.4.4 0 100 0 65535 i Total number of prefixes 2</pre>

7.6 Monitoring

Clearing



Running the **clear** commands may lose vital information and thus interrupt services.

Description	Command
Clears BGP IPv4 unicast routes.	<pre>clear ip bgp [instance as-number] [vrf vrf-name] { * as-number neighbor-address } [soft] [in out] clear bgp [instance as-number] ipv4 unicast [vrf vrf-name] { * as-number neighbor-address } [soft] [in out] clear ip bgp [instance as-number] [vrf vrf-name] update-group [update-group-index neighbor-address] [soft] [in out] clear bgp [instance as-number] ipv4 unicast [vrf vrf-name] update-group [update-group-index neighbor-address] [soft] [in out]</pre>
Clears BGP IPv6 unicast routes.	<pre>clear bgp [instance as-number] ipv6 unicast [vrf vrf-name] { * as-number</pre>

	<i>neighbor-address</i> } [soft] [in out] clear bgp [instance <i>as-number</i>] ipv6 unicast [vrf <i>vrf-name</i>] update-group [<i>update-group-index</i> <i>neighbor-address</i>] [soft] [in out]
Clears BGP L2VPN EVPN routes.	clear bgp [instance <i>as-number</i>] l2vpn evpn { * <i>as-number</i> <i>neighbor-address</i> } [soft] [in out] clear bgp [instance <i>as-number</i>] l2vpn evpn update-group [<i>update-group-index</i> <i>neighbor-address</i>] [soft] [in out]
Clears EVPN conflict MAC	clear evpn conflict mac [<i>vni-id</i>]

Displaying

Description	Command
Displays the BGP IPv4 unicast routes.	show ip bgp show bgp ipv4 unicast
Displays the update-group information of BGP IPv4 unicast address family.	show ip bgp [instance <i>as-number</i>] [vrf <i>vrf-name</i>] update-group [<i>neighbor-address</i> <i>update-group-index</i>] [summary] show bgp [instance <i>as-number</i>] ipv4 unicast [vrf <i>vrf-name</i>] update-group [<i>neighbor-address</i> <i>update-group-index</i>] [summary]
Displays BGP IPv6 unicast routes.	show bgp [instance <i>as-number</i>] ipv6 unicast
Displays the update-group information of BGP IPv6 unicast address family.	show bgp [instance <i>as-number</i>] ipv6 unicast [vrf <i>vrf-name</i>] update-group [<i>neighbor-address</i> <i>update-group-index</i>] [summary]
Displays BGP L2VPN EVPN routes.	show bgp [instance <i>as-number</i>] l2vpn evpn all
Displays the update-group information of BGP L2VPN EVPN address family.	show bgp [instance <i>as-number</i>] l2vpn evpn all update-group [<i>neighbor-address</i> <i>update-group-index</i>] [summary]
Displays the MAC mobility or conflict.	show evpn mac { conflict mobility } [<i>vni-id</i>]
Displays BGP statistics.	show bgp [instance <i>as-number</i>] statistics [vrf <i>vrf-name</i>]

Debugging



System resources are occupied when debugging information is output. Therefore, disable debugging immediately after use.

Description	Command
Enables all BGP debugging.	debug ip bgp all
Debugs BGP route flapping.	debug ip bgp dampening
Debugs BGP event processing.	debug ip bgp event
Debugs BGP route filtering.	debug ip bgp filter
Debugs BGP status machine.	debug ip bgp fsm
Debugs BGP neighbor keepalive.	debug ip bgp keepalives
Debugs BGP core route processing.	debug ip bgp nsm
Debugs BGP UPDATE packets.	debug ip bgp update
Debugs BGP EVPN.	debug ip bgp evpn
Debugs BGP VXLAN exchanging.	debug ip bgp vxlan
Debugs BGP TRACK exchanging.	debug ip bgp track
Debugs BGP UPDATE-GROUP.	debug ip bgp update-group

8 Configuring RIPng

8.1 Overview

RIP next generation (RIPng) is a unicast routing protocol that applies to IPv6 networks. RIPng-enabled routers exchange routing information to obtain routes to remote networks.

As an Interior Gateway Protocol (IGP), RIPng can run only within the autonomous system (AS) and is applicable to small-sized networks with routes no more than 16 hops.

Protocols and Standards

- RFC2080: Defines the RIPng.

8.2 Application

RIPng is generally used on some small-sized networks, such as office networks of small companies.

As shown in the following figure, the company builds an IPv6 network, on which all routers support IPv6. The network is small in size, but the workload is still heavy if the network is maintained manually. In this case, RIPng can be configured to adapt to topological changes of the small-sized network, which reduces the workload.

Figure 8-1

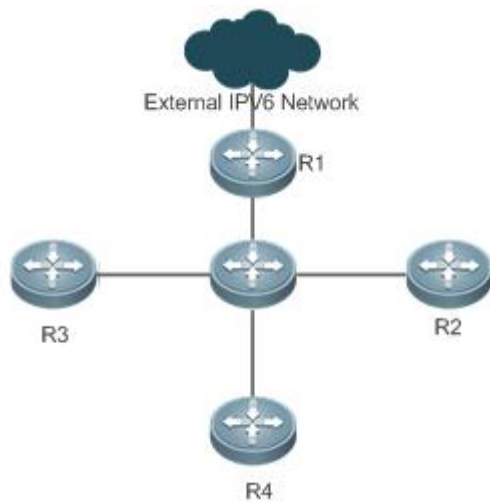

8.3 Features

Basic Concepts

↳ IGP and EGP

IGP runs within an AS. For example, RIPng is a type of IGP.

Exterior Gateway Protocol (EGP) runs between ASs. For example, BGP is a type of EGP.

Feature

Feature	Description
RIPng and RIP	RIPng is an extension of RIPv2 on the basis of IPv6. Both are similar in functions and configurations.
Exchanging Routing	By exchanging routing information, RIPng-enabled devices can automatically obtain routes to a remote

Information	network and update routes in real time.
Routing Algorithm	RIPng is a protocol based on the distance-vector algorithm. It uses the vector addition method to compute the routing information.
Avoiding Route Loops	RIPng uses functions, such as split horizon and poison reverse, to avoid route loops.

8.3.1 RIPng and RIP

RIP applies to IPv4 networks. Two RIP versions are available, including RIPv1 and RIPv2.

RIPng is an extension of RIPv2 on the basis of IPv6. Both are similar in functions and configurations.

Working Principle

↳ RIPv2

RIPv2 packets are multicast. The multicast address is 224.0.0.9, and the UDP port ID is 520. RIPv2 can identify the subnet mask.

↳ RIPng

RIPng packets are multicast. The multicast address is FF02::9, the source address is FE80::/10, and the UDP port ID is 521. RIPng can identify the subnet mask.

 This chapter describes functions and configurations of RIPng. For details about RIPv2, see "Configuring RIP".

Related Configuration

↳ Enabling the RIPng Process

By default, the RIPng process is disabled.

Run the **ipv6 router rip** command to enable the RIPng process.

You must enable the RIPng process on a device; otherwise, all functions related to RIPng cannot take effect.

↳ Running RIPng on an Interface

By default, RIPng does not run on an interface.

Run the **ipv6 rip enable** command to run RIPng on an interface.

After RIPng runs on an interface, RIPng packets can be exchanged on the interface and RIPng can learn routes to the network segments directly connected to the device.

↳ Prohibiting an Interface from Sending or Receiving Packets

By default, a RIPng-enabled interface is allowed to send and receive RIPng packets.

Run the **passive-interface** command to prohibit an interface from sending RIPng packets.

8.3.2 Exchanging Routing Information

Compared with static routing, the dynamic routing protocol has a significant advantage, that is, by exchanging routing information, devices can automatically obtain routes to a remote network and update the routes in real time.

Working Principle

↳ Initialization

After RIPng is enabled on a router, the router sends a request packet to its neighbor router, requesting for all routing information, that is, the routing table. After receiving the request message, the neighbor router returns a response packet containing the local routing

table. After receiving the response packet, the router updates the local routing table, and sends an update packet to the neighbor router, informing the neighbor router of the route update information. After receiving the update packet, the neighbor router updates the local routing table, and sends the update packet to other adjacent routers. After a series of updates, all routers can obtain and retain the latest routing information.

↘ Periodical Update

By default, periodical update is enabled for RIPng. Adjacent routers exchange complete routing information with each other every 30s (update timer), that is, the entire routing table is sent to neighbor routers.

-  For every non-local route, if the route is not updated within 180s (invalid timer), the metric of the route is changed to 16 (unreachable). If the route is still not updated in the next 120s (flush timer), the route is deleted from the routing table.

↘ Default Route

In the routing table, a route to the destination network `::/0` is called default route.

The default route can be learned from a neighbor router, or sent to a neighbor router.

↘ Route Redistribution

For RIPng, other types of routes (such as direct routes, static routes, and routes of other routing protocols) are called external routes. External routes (excluding the default route) can be redistributed to RIPng and advertised to neighbors.

↘ Route Filtering

Filtering conditions can be configured to limit the routing information exchanged between adjacent routers. Only the routing information that meets filtering conditions can be sent or received.

Related Configuration

↘ RIPng Timers

By default, the update timer is 30s, the invalid timer is 180s, and the flush timer is 120s.

Run the **timers basic** command to modify durations of RIPng timers.

Increasing the duration of the flush timer can reduce the route flapping. Decreasing the duration of the flush timer helps accelerate route convergence.

The durations of RIPng timers must be consistent on adjacent routers. Unless otherwise required, you are advised not to modify the RIPng timers.

↘ Default Route

Run the **ipv6 rip default-information** command to advertise the default route to neighbors on an interface.

↘ Route Redistribution

Run the **redistribute** command to redistribute external routes (excluding the default route) to RIPng and advertise them to neighbors.

↘ Route Filtering

Run the **distribute-list out** command to set filtering rules to limit the routing information sent by the device.

Run the **distribute-list in** command to set filtering rules to limit the routing information received by the device.

8.3.3 Routing Algorithm

RIPng is a protocol based on the distance-vector algorithm. It uses the vector addition method to compute the routing information.

Working Principle

Distance-Vector Algorithm

RIPng is a protocol based on the distance-vector algorithm. The distance-vector algorithm treats a route as a vector that consists of the destination network and distance (metric). The router obtains a route from its neighbor and adds the distance vector from itself to the neighbor to the route to form its own route.

RIPng uses the hop count to evaluate the distance (metric) to the destination network. By default, the hop count from a router to its directly connected network is 0, the hop count from a router to a network that can be reached through a router is 1, and so on. That is, the metric is equal to the number of routers from the local network to the destination network. To restrict the convergence time, RIPng stipulates that the metric must be an integer between 0 and 15. If the metric is equal to or greater than 16, the destination network or host is unreachable. For this reason, RIPng cannot be applied to a large-scale network.

As shown in the following figure 8-2, Router A is connected to the network 2::/64. Router B obtains the route (2::/64, 0) from Router A and adds the metric 1 to the route to obtain its own route (2::/64, 1), and the next hop points to Router A.

Figure 8-2

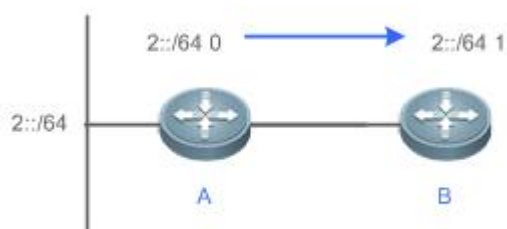

Selecting the Optimum Route

RIPng selects an optimum route based on the following principle: If multiple routes to the same destination network is available, a router preferentially selects the route with the smallest metric.

As shown in the following figure 8-3, Router A is connected to the network 2::/64. Router C obtains the route (2::/64, 0) from Router A and the route (2::/64, 1) from Router B. Router C will select the route that is obtained from Router A and add metric 1 to this route to form its own route (2::/64, 1), and the next hop points to Router A.

Figure 8-3

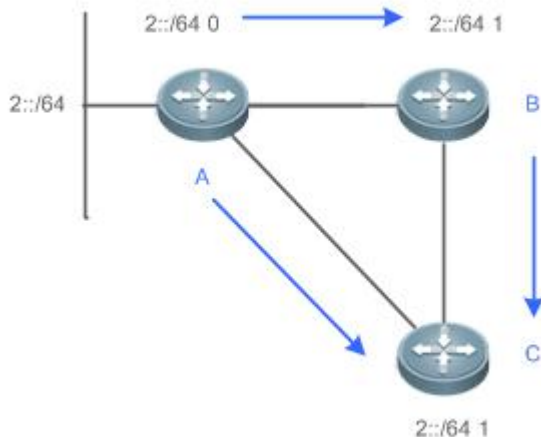

i When routes coming from different sources exist on a router, the route with the smaller distance is preferentially selected.

Route Source	Default Distance
Directly-connected network	0
Static route	1
OSPF route	110
IS-IS route	115
RIPng route	120
Unreachable route	255

Related Configuration

↳ Modifying the Distance

By default, the distance of a RIPng route is 120.

Run the **distance** command to modify the distance of a RIPng route.

↳ Modifying the Metric

For a RIPng route that is proactively discovered by a device, the default metric is equal to the number of hops from the local network to the destination network. The metric offset of the interface is 1.

For a RIPng router that is manually configured (default route or redistributed route), the default metric is 1.

Run the **ipv6 rip metric-offset** command to modify the metric offset of the interface.

Run the **default-metric** command to modify the default metric of an external route (redistributed route).

Run the **redistribute** command to modify the metric of an external route (redistributed route) when advertising this route.

Run the **ipv6 rip default-information** command to modify the metric of a default route when advertising the default route.

8.3.4 Avoiding Route Loops

RIPng uses functions, such as split horizon and poison reverse, to avoid route loops.

Working Principle

↳ Route Loop

A RIPng route loop occurs due to inherent defects of the distance-vector algorithm.

As shown in the following figure 8-4, Router A is connected to the network 2::/64, and sends an update packet every 30s. Router B receives the route to 2::/64 from Router A every 30s. If Router A is disconnected from 2::/64, the route to 2::/64 will be deleted from the routing table on Router A. Next time, the update packet sent by Router A no longer contains this route. As Router B does not receive an update packet related to 2::/64, Router B determines that the route to 2::/64 is valid within 180s and uses the update packet to send this route to Router A. As the route to 2::/64 does not exist on Router A, the route learned from Router B is added to the routing table. Router B determines that data can reach 2::/64 through Router A, and Router A determines that data can reach 2::/64 through Router B. In this way, a route loop is formed.

Figure 8-4

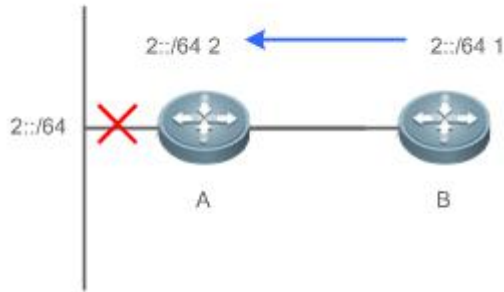

↘ **Split Horizon**

Split horizon can prevent route loops. After split horizon is enabled, a route received on this interface will not be sent out from this interface.

As shown in the following figure 8-5, after split horizon is enabled on Router B, Router B will not send the route to 2::/64 back to Router A. Router B will learn 180s later that 2::/64 is not reachable.

Figure 8-5

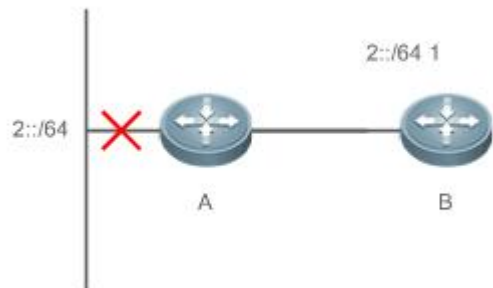

↘ **Poison Reverse**

Poison reverse can also prevent route loops. Compared with split horizon, poison reverse is more reliable, but brings more protocol packets, which makes network congestion more severe.

After poison reverse is enabled on an interface, a route received from this interface will be sent out from this interface again, but the metric of this router will be changed to 16 (unreachable).

As shown in the following figure, after poison reverse is enabled on Router A, if Router A detects a disconnection from 2::/64, Router A will not delete the route to 2::/64. Instead, Router A changes the number of hops to 16, and advertises the route through the update packet. On receiving the update packet, Router B learns that 2::/64 is not reachable.

Figure 8-6

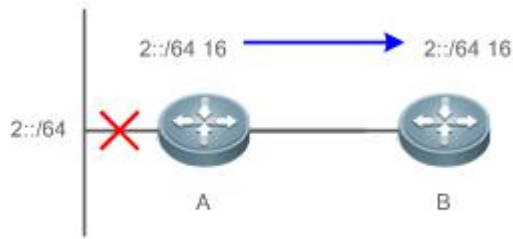

Related Configuration

➤ **Split Horizon**

By default, split horizon is enabled.

Run the **no split-horizon** command to disable split horizon.

➤ **Poison Reverse**

By default, poison reverse is disabled.

Run the **split-horizon poisoned-reverse** command to enable poison reverse. (After poison reverse is enabled, split horizon is automatically disabled.)

8.4 Configuration

Configuration	Related Commands
Configuring RIPng Basic Functions	⚠ (Mandatory) It is used to build a RIPng routing domain.
	ipv6 router rip Enables a RIPng routing process and enters routing process configuration mode.
	ipv6 rip enable Runs RIPng on an interface.
	split-horizon Enables split horizon or poison reverse.
Advertising the Default Route or External Routes	⚠ Optional.
	ipv6 rip default-information Advertise the default route to neighbors on an interface.
Setting Route Filtering Rules	⚠ Optional.
	redistribute Redistributes routes and advertising external routes to neighbors.
Modifying Route Selection Parameters	⚠ Optional.
	distribute-list in Filters the received RIPng routing information.
	distribute-list out Filters the sent RIPng routing information.
Modifying Timers	⚠ Optional.
	distance Modifies the administrative distance of a RIPng route.
	ipv6 rip metric-offset Modifies the metric offset on an interface.
	default-metric Configure the default metric for route redistribution.

Configuration	Related Commands
	timers Modifies the update timer, invalid timer, and flush timer of RIPng.

8.4.1 Configuring RIPng Basic Functions

Configuration Effect

- Build a RIPng routing domain on the network.
- Routers in the domain obtain routes to a remote network through RIPng.

Notes

- IPv6 addresses must be configured.
- IPv6 unicast routes must be enabled.

Configuration Steps

↘ Enabling a RIPng Routing Process

- Mandatory.
- Unless otherwise required, perform this configuration on every router in the RIPng routing domain.

↘ Running RIPng on an Interface

- Mandatory.
- Unless otherwise required, perform this configuration on every interconnected interface of routers in the RIPng routing domain.

↘ Enabling Split Horizon or Poison Reverse

- By default, split horizon is enabled and poison reverse is disabled.
- Unless otherwise required, enable split horizon on every interface connected to the broadcast network, such as the Ethernet. (Retain the default setting.)
- Unless otherwise required, enable split horizon on every interface connected to the point-to-point (P2P) network, such as the PPP and HDLC. (Retain the default setting.)
- It is recommended that split horizon and poison reverse be disabled on an interface connected to a non-broadcast multi-access network, such as FR and X.25; otherwise, some devices cannot learn the complete routing information.
- If the secondary IP address is configured for an interface connected to a non-broadcast, it is recommended that split horizon and poison reverse be disabled.

↘ Configuring a Passive Interface

- This configuration is recommended.
- Use the passive interface to set the boundary of the RIPng routing domain. The network segment of the passive interface belongs to the RIPng routing domain, but RIPng packets cannot be sent over the passive interface.
- If RIPng routes need to be exchanged on an interface (such as the router interconnect interface) in the RIPng routing domain, this interface cannot be configured as a passive interface.

Verification

- Check the routing table on a router to verify that the route to a remote network can be obtained through RIPng.

Related Commands

↳ Enabling a RIPng Routing Process

Command	ipv6 router rip
Parameter	N/A
Description	
Command Mode	Global configuration mode
Usage Guide	This command is used to create a RIPng routing process and enter routing process configuration mode.

↳ Running RIPng on an Interface

Command	ipv6 rip enable
Parameter	N/A
Description	
Command Mode	Interface configuration mode
Usage Guide	The configuration for running the RIPng on an interface is different from that of RIPv2. In RIPv2, the network command is configured in routing process configuration mode to define an IP address range. If the IP address of an interface belongs to this IP address range, RIP automatically runs on this interface.

↳ Enabling Split Horizon

Command	split-horizon [poisoned-reverse]
Parameter	poisoned-reverse: Indicates that the split horizon function contains the poison reverse function.
Description	
Command Mode	Routing process configuration mode
Usage Guide	Run the show ipv6 rip command to check whether split horizon is enabled. The configuration is different from that of RIPv2. In RIPv2, the split horizon function is configured in interface configuration mode.

↳ Configuring a Passive Interface

Command	passive-interface { default interface-type interface-num }
Parameter	default: Indicates all interfaces.
Description	interface-type interface-num: Specifies an interface.
Command Mode	Routing process configuration mode
Usage Guide	First, run the passive-interface default command to configure all interfaces as passive interfaces. Then, run the no passive-interface interface-type interface-num command so that the interfaces used for interconnection between routers in the domain are not passive interface.

↳ Displaying the IP Routing Table

Command	show ipv6 route
Parameter	N/A
Description	

Command	Privileged EXEC mode or global configuration mode
Mode	
Usage Guide	Check whether the routing table contains any route to a remote network that is learned through RIPng.

Configuration Example

🔽 **Building a RIPng Routing Domain**

<p>Scenario Figure 8-7</p>	
<p>Configuration Steps</p>	<ul style="list-style-type: none"> ● Configure IPv6 addresses on all routers. ● Enable RIPng on all routers.
<p>A</p>	<pre>A# configure terminal Enter configuration commands, one per line. End with CNTL/Z. A(config)# ipv6 router rip A(config-router)# exit A(config)# interface GigabitEthernet 0/0 A(config-if-GigabitEthernet 0/0)# ipv6 address 2001:db8::1/32 A(config-if-GigabitEthernet 0/0)# ipv6 rip enable</pre>
<p>B</p>	<pre>B# configure terminal Enter configuration commands, one per line. End with CNTL/Z. B(config)# ipv6 router rip B(config-router)# exit B(config)# interface GigabitEthernet 0/0 B(config-if-GigabitEthernet 0/0)# ipv6 address 2001:db8::2/32 B(config-if-GigabitEthernet 0/0)# ipv6 rip enable</pre>
<p>C</p>	<pre>C# configure terminal Enter configuration commands, one per line. End with CNTL/Z. C(config)# ipv6 router rip</pre>

	<pre> C(config-router)# exit C(config)# interface GigabitEthernet 0/0 C(config-if-GigabitEthernet 0/0)# C(config-if-GigabitEthernet 0/0)# ipv6 address 2001:db8::3/32 C(config-if-GigabitEthernet 0/0)# ipv6 rip enable C(config)# interface GigabitEthernet 0/1 C(config-if-GigabitEthernet 0/1)# ipv6 address 2::1/64 C(config-if-GigabitEthernet 0/1)# ipv6 rip enable </pre>
<p>Verification</p>	<p>Check the routing tables on Router A, Router B, and Router C. The routing tables should contain routes to a remote network that are learned through RIPv6.</p>
<p>A</p>	<pre> A# show ipv6 route IPv6 routing table name - Default - 6 entries Codes: C - Connected, L - Local, S - Static R - RIP, O - OSPF, B - BGP, I - IS-IS, V - Overflow route N1 - OSPF NSSA external type 1, N2 - OSPF NSSA external type 2 E1 - OSPF external type 1, E2 - OSPF external type 2 SU - IS-IS summary, L1 - IS-IS level-1, L2 - IS-IS level-2 IA - Inter area R 2::/64 [120/2] via FE80::2D0:F8FF:FEFB:D521, GigabitEthernet 0/0 C 2001:DB8::/32 via GigabitEthernet 0/0, directly connected L 2001:DB8::1/128 via GigabitEthernet 0/0, local host C FE80::/10 via ::1, Null0 C FE80::/64 via GigabitEthernet 0/0, directly connected L FE80::2D0:F8FF:FEFB:E7CE/128 via GigabitEthernet 0/0, local host </pre>
<p>B</p>	<pre> B# show ipv6 route IPv6 routing table name - Default - 6 entries Codes: C - Connected, L - Local, S - Static R - RIP, O - OSPF, B - BGP, I - IS-IS, V - Overflow route N1 - OSPF NSSA external type 1, N2 - OSPF NSSA external type 2 E1 - OSPF external type 1, E2 - OSPF external type 2 </pre>

	<pre> SU - IS-IS summary, L1 - IS-IS level-1, L2 - IS-IS level-2 IA - Inter area R 2::/64 [120/2] via FE80::2D0:F8FF:FEFB:D521, GigabitEthernet 0/0 C 2001:DB8::/32 via GigabitEthernet 0/0, directly connected L 2001:DB8::2/128 via GigabitEthernet 0/0, local host C FE80::/64 via GigabitEthernet 0/0, directly connected L FE80::2D0:F8FF:FEFB:C9BA/128 via GigabitEthernet 0/0, local host </pre>
<p>C</p>	<pre> FS# show ipv6 route IPv6 routing table name - Default - 9 entries Codes: C - Connected, L - Local, S - Static R - RIP, O - OSPF, B - BGP, I - IS-IS, V - Overflow route N1 - OSPF NSSA external type 1, N2 - OSPF NSSA external type 2 E1 - OSPF external type 1, E2 - OSPF external type 2 SU - IS-IS summary, L1 - IS-IS level-1, L2 - IS-IS level-2 IA - Inter area C 2::/64 via GigabitEthernet 0/1, directly connected L 2::2/128 via GigabitEthernet 0/1, local host C 2001:DB8::/32 via GigabitEthernet 0/0, directly connected L 2001:DB8::3/128 via GigabitEthernet 0/0, local host C FE80::/10 via ::1, Null0 C FE80::/64 via GigabitEthernet 0/0, directly connected L FE80::2D0:F8FF:FEFB:D521/128 via GigabitEthernet 0/0, local host C FE80::/64 via GigabitEthernet 0/1, directly connected L FE80::2D0:F8FF:FEFB:D521/128 via GigabitEthernet 0/1, local host </pre>

Common Errors

- The IPv6 address is not configured on an interface.
- The interface used for interconnection between devices is configured as a passive interface.

8.4.2 Advertising the Default Route or External Routes

Configuration Effect

- In the RIPng domain, introduce a unicast route of another AS so that the unicast routing service to this AS can be provided for users in the RIPng domain.
- In the RIPng domain, inject a default route to another AS so that the unicast routing service to this AS can be provided for users in the RIPng domain.

Notes

- The RIPng basic functions must be configured.

Configuration Steps

↘ **Configuring External Route Redistribution**

- Optional.
- Perform this configuration if external routes of the RIPng domain should be introduced to the AS border router (ASBR).

↘ **Generating a Default Route**

- Optional.
- Perform this configuration if the default route should be introduced to an ASBR so that other routers in the RIPng domain access other AS domains through this ASBR by default.

Verification

- Run the **show ipv6 route rip** command on a non-ASBR to check whether the external routes of the domain and default route have been loaded.

Related Commands

↘ **Advertising the Default Route to Neighbors on an Interface**

Command	ipv6 rip default-information { only originate } [metric <i>metric-value</i>]
Parameter	only : Advertises only IPv6 default route.
Description	originate : Advertises the IPv6 default route and other routes. metric <i>metric-value</i> : Indicates the metric of the default route. The value ranges from 1 to 15. The default value is 1.
Command Mode	Interface configuration mode
Usage Guide	After this command is configured on the interface, an IPv6 default route is advertised to the external devices through this interface, but the route itself is not added to the route forwarding table or the device and the RIPng route database. To prevent occurrence of a route loop, once this command is configured on an interface, RIPng refuses to receive the default route updates advertised by neighbors.

↘ **Redistributing Routes and Advertising External Routes to Neighbors**

Command	redistribute { bgp connected isis [<i>area-tag</i>] ospf <i>process-id</i> static } [metric <i>metric-value</i> route-map <i>route-map-name</i>]
Parameter	bgp : Indicates redistribution from BGP.
Description	Connected : Indicates redistribution from direct routes. isis [<i>area-tag</i>]: Indicates redistribution from IS-IS. <i>area-tag</i> indicates the IS-IS process ID.

	<p>ospf process-id: Indicates redistribution from OSPF. <i>process-id</i> indicates the OSPF process ID. The value ranges from 1 to 65535.</p> <p>static: Indicates redistribution from static routes.</p> <p>metric metric-value: Sets the metric of the route redistributed to the RIPng domain.</p> <p>route-map route-map-name: Sets the redistribution filtering rules.</p>
Command Mode	Routing process configuration mode
Usage Guide	During route redistribution, it is not necessary to convert the metric of one routing protocol to the metric of another routing protocol because different routing protocols use completely different metric measurement methods. RIP measures the metric based on the hop count, and OSPF measures the metric based on the bandwidth. Therefore, the computed metrics cannot be compared with each other.

Configuration Example

<p>Scenario Figure 8-8</p>	
Configuration Steps	<ul style="list-style-type: none"> Configure the interface IPv6 addresses on all routers. (Omitted) Configure the RIPng basic functions on all routers. (Omitted) On Router B, configure redistribution of static routes. On the GE0/1 interface of Router A, configure advertisement of the default route.
A	<pre>A# configure terminal A(config)# interface GigabitEthernet 0/1 A(config-if-GigabitEthernet 0/1)# ipv6 rip default-information originate</pre>
B	<pre>B# configure terminal B(config)# ipv6 router rip B(config-router)# redistribute static</pre>
Verification	<ul style="list-style-type: none"> Check the routing tables on Router A and Router B, and confirm that Router A can learn the route 3001:10:10::/64, and Router B can learn the default route ::/0.

A	<pre>A# show ipv6 route rip IPv6 routing table name - Default - 17 entries Codes: C - Connected, L - Local, S - Static R - RIP, O - OSPF, B - BGP, I - IS-IS N1 - OSPF NSSA external type 1, N2 - OSPF NSSA external type 2 E1 - OSPF external type 1, E2 - OSPF external type 2 SU - IS-IS summary, L1 - IS-IS level-1, L2 - IS-IS level-2 IA - Inter area R 3001:10:10::/64 [120/2] via FE80::2D0:F8FF:FE22:334A, GigabitEthernet 0/1</pre>
B	<pre>B# show ipv6 route rip IPv6 routing table name - Default - 17 entries Codes: C - Connected, L - Local, S - Static R - RIP, O - OSPF, B - BGP, I - IS-IS N1 - OSPF NSSA external type 1, N2 - OSPF NSSA external type 2 E1 - OSPF external type 1, E2 - OSPF external type 2 SU - IS-IS summary, L1 - IS-IS level-1, L2 - IS-IS level-2 IA - Inter area R ::/0 [120/2] via FE80::21A:A9FF:FE41:5B06, GigabitEthernet 0/1</pre>

8.4.3 Setting Route Filtering Rules

Configuration Effect

- Routes that do not meet filtering criteria cannot be loaded to the routing table, or advertised to neighbors. In this way, users within the network can be prevented from accessing specified destination networks.

Notes

- The RIPng basic functions must be configured.

Configuration Steps

📌 Filtering the Received RIP Routing Information

- To refuse receiving some specified routes, you can configure the route distribution control list to process all the received route update packets. If no interface is specified, route update packets received on all interfaces will be processed.

📌 Filtering the Sent RIP Routing Information

- If this command does not contain any optional parameter, route update advertisement control takes effect on all interfaces. If the command contains the interface parameter, route update advertisement control takes effect only on the specified interface. If the command contains other routing process parameters, route update advertisement control takes effect only on the specified routing process.

Verification

- Run the **show ipv6 route rip** command to check that the routes that have been filtered out are not loaded to the routing table.

Related Commands

Command	distribute-list prefix-list <i>prefix-list-name</i> { in out } [<i>interface-type interface-name</i>]
Parameter	prefix-list <i>prefix-list-name</i> : Indicates the name of the prefix list, which is used to filter routes.
Description	in out : Specifies update routes (received or sent routes) that are filtered. <i>interface-type interface-name</i> : Indicates that the distribution list is applied to the specified interface.
Command Mode	Routing process configuration mode
Usage Guide	N/A

Configuration Example

Scenario Figure 8-9	
Configuration Steps	<ul style="list-style-type: none"> ● Configure the interface IPv6 addresses on all routers. (Omitted) ● Configure the RIPng basic functions on all routers. (Omitted) ● On router A, configure route filtering.
A	<pre>A# configure terminal A(config)# ipv6 prefix-list hello permit 4001::/64 A(config)# ipv6 router rip A(config-router)# distribute-list prefix-list hello in</pre>
Verification	<ul style="list-style-type: none"> ● Check that Router A can learn only the route to 4001::/64.

A	<pre> A# show ipv6 route rip IPv6 routing table name - Default - 17 entries Codes: C - Connected, L - Local, S - Static R - RIP, O - OSPF, B - BGP, I - IS-IS N1 - OSPF NSSA external type 1, N2 - OSPF NSSA external type 2 E1 - OSPF external type 1, E2 - OSPF external type 2 SU - IS-IS summary, L1 - IS-IS level-1, L2 - IS-IS level-2 IA - Inter area R 4001::/64 [120/2] via FE80::2D0:F8FF:FE22:334A, GigabitEthernet 0/1 </pre>
----------	---

8.4.4 Modifying Route Selection Parameters

Configuration Effect

- Change the RIPng routes to enable the traffic pass through specified nodes or avoid passing through specified nodes.
- Change the sequence that a router selects various types of routes so as to change the priorities of RIPng routes.

Notes

- The RIPng basic functions must be configured.

Configuration Steps

✚ Modifying the Administrative Distance of a RIPng Route

- Optional.
- Perform this configuration if you wish to change the priorities of RIPng routes on a router that runs multiple unicast routing protocols.

✚ Modifying the Metric Offset on an Interface

- Optional.
- Unless otherwise required, perform this configuration on a router where the metrics of routes need to be adjusted.

✚ Configuring the Default Metric of an External Route Redistributed to RIPng

- Optional.
- Unless otherwise required, perform this configuration on an ASBR to which external routes are introduced.

Verification

- Run the **show ipv6 rip** command to display the administrative distance of RIPng routes.
- Run the **show ipv6 rip data** command to display the metrics of external routes redistributed to RIPng.

Related Commands

✚ Modifying the Administrative Distance of a RIPng Route

Command	distance <i>distance</i>
Parameter	<i>distance</i> : Sets the administrative distance of a RIPng route. The value is an integer ranging from 1 to 254.
Description	
Command Mode	Routing process configuration mode
Usage Guide	Run this command to set the administrative distance of a RIPng route.

✚ **Modifying the Metric Offset on an Interface**

Command	ipv6 rip metric-offset <i>value</i>
Parameter	<i>value</i> : Indicates the interface metric offset. The value ranges from 1 to 16.
Description	
Command Mode	Routing process configuration mode
Usage Guide	Before a route is added to the routing table, the metric of the route must be added with the metric offset set on the interface. You can control the use of a route by setting the interface metric offset.

✚ **Configuring the Default Metric of an External Route Redistributed to RIPng**

Command	default-metric <i>metric</i>
Parameter	<i>metric</i> : Indicates the default metric. The valid value ranges from 1 to 16. If the value is equal to or greater than 16, the FSOS determines that this route is unreachable.
Description	
Command Mode	Global configuration mode
Usage Guide	If the metric is not specified during redistribution of a routing protocol process, RIPng uses the metric defined by the default-metric command. If the metric is specified, the metric defined by the default-metric command is overwritten by the specified metric. If this command is not configured, the value of default-metric is 1.

Configuration Example

✚ **Modifying the Administrative Distance of a RIPng Route**

Scenario Figure 8-10	
Configuration Steps	<ul style="list-style-type: none"> ● Configure the interface IPv6 addresses on all routers. (Omitted) ● Configure the RIPng basic functions on all routers. (Omitted) ● On Router A, set the administrative distance of a RIPng route to 160.
	<pre>A# configure terminal A(config)# ipv6 router rip A(config-router)# distance 160</pre>

Verification	<ul style="list-style-type: none"> ● On Router A, check whether the administrative distance of a RIPng route is 160.
	<pre>A# show ipv6 route rip in 3001::/64 R 3001::/64 [160/2] via FE80::2D0:F8FF:FE22:334A, GigabitEthernet 0/1</pre>

8.4.5 Modifying Timers

Configuration Effect

- Change the duration of RIPng timers to accelerate or slow down the change of the protocol state or occurrence of an event.

Notes

- The RIPng basic functions must be configured.
- Modifying the protocol control parameters may result in protocol running failures. Therefore, you are advised not to modify the timers.

Configuration Steps

✚ Modifying the Update Timer, Invalid Timer, and Flush Timer

- Mandatory.
- Unless otherwise required, perform this configuration on a router where RIPng timers need to be modified.

Verification

- Run the **show ipv6 rip** command to display settings of timers.

Related Commands

Command	timers update invalid flush
Parameter Description	<p><i>Update</i>: Indicates the route update time in second. It defines the interval at which the device sends the route update packet. Each time an update packet is received, the invalid timer and flush timer are reset. By default, a route update packet is sent every 30s.</p> <p><i>Invalid</i>: Indicates the route invalid time in second, counted from the last time when a valid update packet is received. It defines the time after which the route in the routing list becomes invalid because the route is not updated. The duration of the invalid timer must be at least three times the duration of the update timer. If no update packet is received before the invalid timer expires, the corresponding route enters the invalid state. If the update packet is received before the invalid timer expires, the timer is reset. The default duration of the invalid timer is 180s.</p> <p><i>Flush</i>: Indicates the route flushing time in second, counted from the time when the RIPng route enters the invalid state. When the flush timer expires, the route in the invalid state will be deleted from the routing table. The default duration of the flush timer is 120s.</p>
Command Mode	Routing process configuration mode
Usage Guide	By default, the update timer is 30s, the invalid timer is 180s, and the flush timer is 120s.

Configuration Example

<p>Scenario Figure 8- 11</p>	
<p>Configuration Steps</p>	<ul style="list-style-type: none"> ● Configure the interface IPv6 addresses on all routers. (Omitted) ● Configure the RIPng basic functions on all routers. (Omitted) ● On Router A, configure the update timer, invalid timer, and flush timer.
<p>B</p>	<pre>B# configure terminal B(config)# ipv6 router rip B(config-router)# timers 10 30 90</pre>
<p>Verification</p>	<ul style="list-style-type: none"> ● On Router B, check the settings of RIPng timers.
<p>B</p>	<pre>B# show ipv6 rip Routing Protocol is "RIPng" Sending updates every 10 seconds with +/-50%, next due in 12 seconds Timeout after 30 seconds, garbage collect after 90 seconds Outgoing update filter list for all interface is: not set Incoming update filter list for all interface is: not set Default redistribution metric is 1 Default distance is 120 Redistribution: Redistributing protocol connected Default version control: send version 1, receive version 1 Interface Send Recv GigabitEthernet 0/1 1 1 Routing Information Sources: Gateway: fe80::2d0:f8ff:fe22:334a Distance: 120 Last Update: 00:00:02 Bad Packets: 0 Bad Routes: 0</pre>

Common Errors

- Settings of RIPng timers on devices connected to the same network are inconsistent. Consequently, routes cannot be learned properly.

8.5 Monitoring

Displaying

Description	Command
Displays information about the RIPng process.	show ipv6 rip
Displays the RIPng routing table.	show ipv6 rip database

Debugging



System resources are occupied when debugging information is output. Therefore, disable debugging immediately after use.

Description	Command
Debugs RIPng.	debug ipv6 rip [interface <i>interface-type interface-num</i> nsm restart]

9 Configuring PBR

9.1 Overview

Policy-based routing (PBR) is implemented by applying a route map including policies to interfaces and devices.

Similar to static routing, PBR is also manually configured and cannot automatically update with network changes. In addition, PBR is effective only for packets sent from local interfaces and devices. As compared with static and dynamic routing, PBR is more flexible. Static and dynamic routing can forward packets only based on destination addresses. PBR can forward packets based on source and destination addresses, packet length and input interface.

9.2 Applications

Application	Description
Selecting an ISP by Using PBR	Specify preferential output interfaces for packets from different subnets.
Implementing Traffic Classification by Using PBR	Specify QoS values for packets from different subnets.

9.2.1 Selecting an ISP by Using PBR

An existing user network often uses resources of multiple internet server providers (ISPs). PBR needs to be used since different bandwidths may be requested from different ISPs or the network resources for key users need to be protected. By controlling forwarding of certain data packets, you can make full use ISP resources as well as meet the requirements of flexible and diversified applications.

Scenario

Figure 9- 1

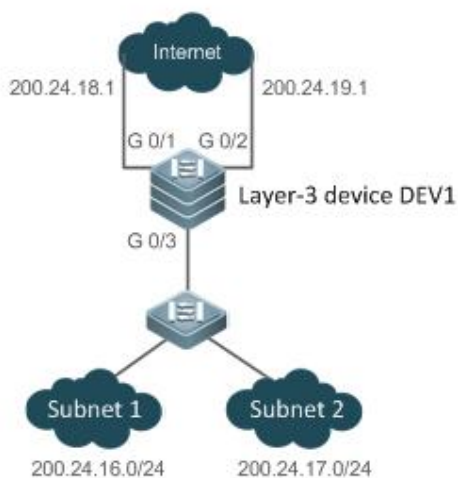

A LAN has two output interfaces for connecting the Internet. PBR is configured on the layer-3 device DEV1 to enable the two output interfaces to implement load sharing and mutual backup.

The specific requirements are as follows:

- Data streams from subnet 1 are sent from GE 0/1.
- Data streams from subnet 2 are sent from GE 0/2.
- If the GE 0/1 link is disconnected, the data streams on GE 0/1 are switched to GE 0/2. Vice versa.

Deployment

- Configure two different ACLs on the layer-3 device DEV1:
ACL1: source addresses belong to subnet 1.
ACL2: source addresses belong to subnet 2.
- Configure two policies in the route map on the layer-3 device DEV1:
Policy 1: sets the next hops for packets matching ACL1 to GE0/1 and GE0/2 (Based on the configuration sequence, GE0/1 takes effect first and GE0/2 works in the backup mode).
Policy 2: sets the next hops for packets matching ACL2 to GE0/2 and GE0/1 (Based on the configuration sequence, GE0/2 takes effect first and GE0/1 works in the backup mode).
- Configure PBR on GE0/3 (by using a route map). Then, packets received on this interface are forwarded based on the policies.

9.2.2 Implementing Traffic Classification by Using PBR

Scenario

Networks of medium- and small-sized enterprises have simple structures. Different branch nodes are interconnected to the central nodes through carrier dedicated lines or the Internet VPN mode. Enterprise networks often need to implement three-in-one integration (of audio, video and data) to maximize the utilization of existing IP networks and save costs. Since all traffic is output from a single output interface, it is necessary to adjust the QoS policies for the output interface, in order to provide preferential communication quality for bandwidth- and delay-sensitive applications.

Figure 9- 2

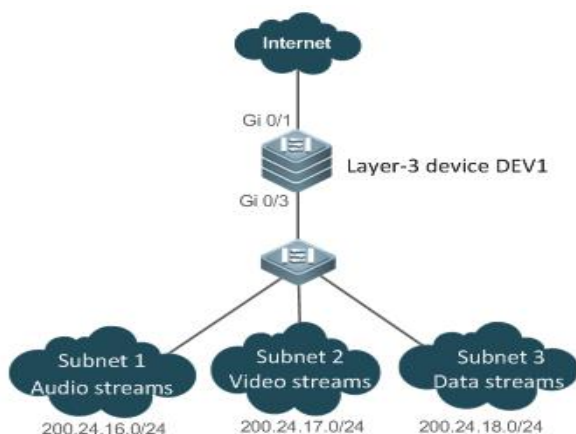

A LAN has an output interface for connecting the Internet. PBR is configured on the layer-3 device DEV1 to change the QoS values for packets from different networks.

The specific requirements are as follows:

- For data streams from subnet 1, representing audio streams, set the DSCP value to 56.
- For data streams from subnet 2, representing video streams, set the DSCP value to 40.
- For data streams from subnet 3, representing data streams, set the DSCP value to 24.

Deployment

- Configure three different ACLs on the layer-3 device DEV1:
 - ACL1: source addresses belong to subnet 1.
 - ACL2: source addresses belong to subnet 2.
 - ACL3: source addresses belong to subnet 3.
- Configure three policies in the route map on the layer-3 device DEV1:
 - Policy 1: sets the DSCP value for packets matching ACL1 to 56.
 - Policy 2: sets the DSCP value for packets matching ACL2 to 40.
 - Policy 3: sets the DSCP value for packets matching ACL3 to 24.
- Configure PBR on GE0/3 (by using a route map). Then, the DSCP values for packets received on this interface are changed based on the policies.

9.3Features

Feature	Description
Configuring a Policy	Before configuring PBR, configure policies in a route map.
Configuring PBR	Apply a route map including policies to interfaces and devices to implement PBR.

9.3.1Configuring a Policy

A policy is a "match ..., set..." statement, which indicates that "if certain conditions are matched, perform certain processing actions".

- For detailed introduction to the policies, see the section "Route Map".

Executing Policies

In the global configuration mode, you can run the **route-map** *route-map-name* [**permit** | **deny**] [*sequence-number*] command to create a policy in a route map.

A route map may contain multiple policies. Each policy has a corresponding sequence number. A smaller sequence number means a higher priority. Policies are executed based on their sequence numbers. Once the matching condition of a policy is met, the processing action for this policy needs to be executed and the route map exits. If no matching condition of any policy is met, no processing action will be performed.

Policies have two working modes:

- **permit**: When the matching condition of a policy is met, perform the processing action for this policy and exit the route map.
- **deny**: When the matching condition of a policy is met, do not perform the processing action for this policy and exit the route map.



Matching conditions of policies





The matching conditions of a policy may contain 0, 1 or more matching rules.

- If 0 matching rule is contained, no packet will be matched.
- If one or more match rules are contained, all match rules must be matched at the same time to meet the matching conditions of the policy.

In the route map mode, run the **match** command to configure match rules. One **match** command is mapped to one match rule.

PBR supports the following **match** commands:

	Command	Description
	match ip address	The source IPv4 address (and the destination IPv4 address) is used as the matching condition.  Multiple match ip address commands can be configured in a policy.
IPv6 PBR	match ipv6 address	The source IPv6 address (and the destination IPv6 address) is used as the matching condition.  Only one match ipv6 policy command can be configured in a policy.

-  IPv4 PBR defines the source IP address (and destination IP address) ranges of packets by using the IP standard or extended ACLs. IPv6 PBR defines the source IPv6 address (and destination IPv6 address) ranges of packets by using the IPv6 extended ACLs.
-  Packet forwarding based on policies of IPv4 PBR interfaces supports expert-level and MAC name ACLs. Packet forwarding based on local policies does not support expert-level and MAC name ACLs.
-  When PBR uses an ACL that is unavailable, the route sub-map will not be matched and the next route sub-map will be matched instead. If no route sub-map is matched, a common route will be selected for forwarding. If only ACLs are configured but no ACE is configured, the PBR forwarding behavior is the same as that in a scenario where an ACL is unavailable
-  On a switch, if a route sub-map uses multiple ACLs in PBR, only the first ACL is matched.

Processing action for a policy

The processing action of a policy may contain 0, 1 or more set rules.







- If 0 set rule is contained, no processing action will be performed and the route map will directly exit.

- If one or more set rules are contained, all processing actions will be performed and the route map will exit.

 If set rules have different priorities, the set rule with the highest priority will take effect.

In the route map mode, run the **set** command to configure set rules. One **set** command is mapped to one set rule.

PBR supports the following **set** commands:

	Command	Description
IPv4 PBR	set ip tos	<p>Modifies the tos field of an IPv4 packet.</p> <p> Command set ip and dscp cannot work with each other.</p>
	set ip precedence	<p>Modifies the precedence field of an IPv4 packet.</p> <p> Command set ip and dscp cannot work with each other.</p>
	set ip dscp	<p>Modifies the dscp field of an IPv4 packet.</p> <p> Command set ip tos and precedence cannot work with each other.</p>
	set ip next-hop	<p>Configures the next hop of IPv4 packet forwarding. The next hop must be directly connected; otherwise, this command is invalid.</p> <p>A packet matching the match rules will be forwarded to the next hop specified by set ip next-hop first, no matter whether the route selected for the packet in the routing table is consistent with the next hop specified by PBR.</p> <p> On a switch, the output interfaces for next hops supported by PBR include the SVI, routing and layer-3 AP interfaces.</p>
	set ip next-hop recursive	<p>Configures the recursive next hop of IPv4 packet forwarding. The next hop can be directly connected or not directly connected. A non-directly-connected next hop will recur to a static or dynamic route in the routing table.</p> <p>This command supports recursion to multiple ECMP next hops of a static or dynamic route. A maximum of 32 next hops are supported. If a recursive route is a static route, only one next hop is supported for the static recursive route.</p> <p>The redundant backup or load balancing mode of multiple recursive next hops is also determined by the ip policy { redundancy load-balance } command.</p> <p>A packet matching the match rules will be forwarded to the recursive next hop specified by set ip next-hop recursive first, no matter whether the route selected for the packet in the routing table is consistent with the next hop specified by PBR.</p> <p> Only when a static or dynamic route has an output interface and a next-hop IP address, the policy-based recursive next hop can take effect.</p>
	set ip default next-hop	<p>Configures the default next hop of IPv4 packet forwarding.</p> <p>A packet matching the match rules will be forwarded to the default next hop specified by this command if a route fails to be selected or the default route is selected for this packet in the routing table.</p>
IPv6 PBR	set ipv6 precedence	<p>Modifies the precedence field of an IPv6 packet.</p> <p> IPv6 PBR does not support set ipv6 tos or set ipv6 dscp.</p>
	set ipv6 next-hop	<p>Configures the next hop of IPv6 packet forwarding.</p> <p>An IPv6 packet matching the match rules will be forwarded to the next hop</p>

	Command	Description
		specified by set ipv6 next-hop first, no matter whether the route selected for the IPv6 packet in the routing table is consistent with the next hop specified by PBR. The next hop must be directly connected; otherwise, this command is invalid.
	set ipv6 next-hop recursive	Configures the recursive next hop for IPv6 packet forwarding. The next hop can be directly or indirectly connected. An indirectly connected next hop will be recursed to a static or dynamic route in the routing table. This command supports recursion to multiple ECMP next hops of a static or dynamic route, and a maximum of 32 next hops are supported. The redundancy or load balancing mode of multiple recursive next hops is determined by the ipv6 policy { redundancy load-balance } command. A packet matching the match rules will be first forwarded to the next hop specified by the set ipv6 next-hop recursive command, regardless of whether the route selected for the packet in the routing table is consistent with the next hop specified by PBR. The recursive next hop takes effect only upon recursion to a static or dynamic route that has an egress and next-hop IPv6 address.
	set ipv6 default next-hop	Configures the default next hop of IPv6 packet forwarding. An IPv6 packet matching the match rules will be forwarded to the default next hop specified by this command if a route fails to be selected or the default route is selected for this packet in the routing table. The next hop must be directly connected; otherwise, this command is invalid.

- i** The priority sequence is as follows: **set vrf > set ip next-hop > set ip next-hop > set ip next-hop recursive > common route > set ip default next-hop > default route**. The preceding **set** commands can be configured at the same time but only the command with the highest priority takes effect.
- i** The priority sequence is as follows: **set ipv6 next-hop > set ipv6 next-hop recursive > common route > set ipv6 default next-hop > default route**. The preceding **set** commands can be configured at the same time but only the command with the highest priority takes effect.

For switches, the **set ipv6 default next-hop** command does not take effect for IPv6 addresses whose mask length exceeds 64.

9.3.2Configuring PBR

PBR

Apply a route map including policies to interfaces or devices to implement PBR.

- Apply a route map to an interface so that packets received by the interface are routed based on the policy.
The PBR is often used to control user packets received by a device. This command is effective only for forwarded packets, but not for locally initiated packets.
- Apply a route map to a device so that packets locally initiated are routed based on the policy.
The PBR is often used to control protocol packets exchanged between devices (such as ping packets sent locally). This command is effective only for locally initiated packets, but not for forwarded packets.
- i** By default, PBR is not unavailable on a device and packets are forwarded based on a routing table.
- i** On a switch, the interfaces which support PBR are L3 Ethernet interface, SVI interface and L3 AP interface.

Redundant backup or load balancing

You can set multiple next hops in a policy. Either redundant backup or load balancing can be implemented among multiple next hops. Redundant backup is implemented by default.

- i Redundant backup or load balancing is only effective for next hops configured in the **set ip next-hop**, **set ip next-hop recursive**, **set ip default next-hop**, **set ipv6 next-hop**, **set ipv6 next-hop recursive** and **set ipv6 default next-hop** commands, and only effective among multiple next hops in the same set rule.
- Redundant backup
Based on the configuration sequence, the first accessible next hop takes effect. When the currently effective next hop (R1) is faulty, the traffic automatically switches to the next accessible next hop (R2). When R1 becomes accessible again, the traffic automatically switches back to R1.
A newly added next hop is arranged at the last of the sequence. Assume that the original sequence of multiple next hops is R1 > R2 > R3. After R1 is deleted and added again, the sequence changes to R2 > R3 > R1.
If no next hop is accessible, packets will be discarded.

Correlation with BFD

Correlation between PBR and BFD is effective only for next hops configured by the **set ip next-hop** or **set ipv6 next-hop** command.

The **set ip next-hop** and **set ipv6 next-hop** commands carry the **verify-availability** and **bfd [vrf vrf-name] interface-type interface-number gateway** parameters, which can establish correlation between PBR and a BFD session and monitor the accessibility of next hops.

Correlation between PBR and BFD helps enhance the PBR's perception about network environment changes. When BFD detects that the current next hop is not accessible, the BFD will immediately notify the PBR to switch the traffic to another accessible next hop (to implement redundant backup) or all the other accessible next hops (to implement load balancing).

- i For the configuration and related commands for correlation between PBR and BFD, see the "BFD" section.

Correlation with Track

Correlation between PBR and Track is effective only for next hops configured by the **set ip next-hop** command.

The **set ip next-hop** command carries the **verify-availability** and **track track-obj-number** parameters, which can establish correlation between PBR and a Track session and monitor the accessibility of next hops.

Correlation between PBR and Track helps enhance the PBR's perception about network environment changes. When Track detects that the current next hop is not accessible, the Track will immediately notify the PBR to switch the traffic to another accessible next hop (to implement redundant backup) or all the other accessible next hops (to implement load balancing).

- i Only IPv4 PBR supports correlation with Track.
- i For the configuration and related commands for correlation between PBR and Track, see the "RNS" section.

Source-addressed-based PBR

Run the global configuration commands **ip policy-source in-interface** and **ipv6 policy-source in-interface** to directly generate source-address-based PBR. You do not need to configure a route map.

- If only source IPv4 or Ipv6 addresses need to be matched for packets forwarded by an interface, you can apply the command for source-address-based PBR. The procedure for configuring this command is simpler than that for interface-based PBR.

- If source-address-based PBR is applied to a specified interface, packets received on this interface will be routed based on policies according to the source addresses.
The PBR is often used to control user packets received by a device. This command is effective only for forwarded packets, but not for locally initiated packets.

i Source-address-based PBR has a higher priority than interface-based PBR. If source-address-based PBR and interface-based PBR are applied to the same interface, only interface-based PBR takes effect.

i By default, source-address-based routing is not available on devices and packets are forwarded based on the routing table.

9.4 Limitations



- If PBR refers ACL which does not exist, the route submap is not matched but match the next route submap. When all route submaps do not match, it is forwarded through common route. It is the same if only ACL is configured but the ACE is not.
- On a switch, if a route submap of PBR refers to multiple ACLs, it matches only the first ACL and does not match the subsequent ACL.

9.5 Configuration

Configuration	Description and Command	
Configuring Basic Functions of PBR	(Mandatory) It is used to apply PBR to forward packets.	
	ip policy route-map	Applies PBR for IPv4 packets received by an interface.
	ipv6 policy route-map	Applies PBR for IPv6 packets received by an interface.
	ip local policy route-map	Applies PBR for IPv4 packets locally initiated.
	ipv6 local policy route-map	Applies PBR for IPv6 packets locally initiated.
Setting Redundant Backup or Load Balancing	(Optional) It is used to set whether PBR implements redundant backup or load balancing among multiple next hops.	
	ip policy { redundancy load-balance }	Sets whether IPv4 PBR implements redundant backup or load balancing among multiple next hops. The default setting is redundant backup.
	ipv6 policy { redundancy load-balance }	Sets whether IPv6 PBR implements redundant backup or load balancing among multiple next hops. The default setting is redundant backup.
Configuring Source-Address-Based PBR	(Optional) It is used to apply source-address-based PBR to forward packets.	
	ip policy-source in-interface	Applies source-address-based PBR for IPv4 packets received by an interface.
	ipv6 policy-source in-interface	Applies source-address-based PBR for IPv6 packets received by an interface.

9.5.1 Configuring Basic Functions of PBR

Configuration Effect

Perform personalized routing management for user data streams by preparing flexible policies.

Perform personalized management for protocol interaction and network topologies by preparing flexible policies.

Notes

- A route map must be used when PBR is configured; therefore, you must configure a route map on a device.
- If an ACL is used when the route map is configured, you must configure the ACL on the device.

Configuration Steps

📌 Applying PBR for IPv4 packets received by an interface

- To perform personalized routing management for IPv4 user data streams passing a device, you should perform this configuration.
- Perform this configuration on the input interface for user data streams.
- Run the **ip policy route-map** command to apply a route map to an interface. Then, PBR is executed for IPv4 packets received on this interface.

Command	ip policy route-map <i>route-map-name</i>
Parameter Description	<i>route-map-name</i> : Indicates the name of a route map.
Defaults	By default, PBR is unavailable on a device and packets are forwarded based on a routing table.
Command Mode	Interface configuration mode
Usage Guide	Only one ip policy route-map command can be configured for an interface. If multiple ip policy route-map commands are configured for an interface, only the last configuration takes effect. If the route map used in PBR is unavailable, the PBR does not take effect. It will not take effect, if the PBR is configured on DAILER, loopback or tunnel interface.

📌 Applying PBR for IPv6 packets received by an interface

- To perform personalized routing management for IPv6 user data streams passing a device, you should perform this configuration.
- Perform this configuration on the input interface for user data streams.
- Run the **ipv6 policy route-map** command to apply a route map to an interface. Then, PBR is executed for IPv6 packets received on this interface.

Command	ipv6 policy route-map <i>route-map-name</i>
Parameter Description	<i>route-map-name</i> : Indicates the name of a route map.
Defaults	By default, PBR is unavailable on a device and packets are forwarded based on a routing table.
Command Mode	Interface configuration mode
Usage Guide	Only one ipv6 policy route-map command can be configured for an interface. If multiple ipv6 policy route-map

	<p>commands are configured for an interface, only the last configuration takes effect.</p> <p>If the route map used in PBR is unavailable, the PBR does not take effect.</p> <p>It will not take effect, if the PBR is configured on DAILER, loopback or tunnel interface.</p>
--	--

➤ **Applying PBR for IPv4 packets locally initiated**

- To perform personalized management for IPv4 protocol interaction and IPv4 network topologies, you should perform this configuration.
- Run the **ip local policy route-map** command to apply a route map to a device. Then, PBR is executed for IPv4 packets locally initiated.

Command	ip local policy route-map <i>route-map-name</i>
Parameter	<i>route-map-name</i> : Indicates the name of a route map.
Description	
Defaults	By default, PBR is unavailable on a device and packets are forwarded based on a routing table.
Command Mode	Global configuration mode
Usage Guide	Only one ip local policy route-map command can be configured for a device. If the route map used in PBR is unavailable, the PBR does not take effect.

➤ **Applying PBR for IPv6 packets locally initiated**

- To perform personalized management for IPv6 protocol interaction and IPv6 network topologies, you should perform this configuration.
- Run the **ipv6 local policy route-map** command to apply a route map to a device. Then, PBR is executed for IPv6 packets locally initiated.

Command	ipv6 local policy route-map <i>route-map-name</i>
Parameter	<i>route-map-name</i> : Indicates the name of a route map.
Description	
Defaults	By default, PBR is unavailable on a device and packets are forwarded based on a routing table.
Command Mode	Global configuration mode
Usage Guide	Only one ipv6 local policy route-map command can be configured for a device. If the route map used in PBR is unavailable, the PBR does not take effect.

Verification

- Check the configurations of PBR.
- Check the configurations of the route map used by PBR.
- If an ACL is used when the route map is configured, you should check the configurations of the ACL.

➤ **Checking the configurations of IPv4 PBR**

Command	show ip policy [<i>route-map-name</i>]
Parameter	<i>route-map-name</i> : Indicates the name of a route map.
Description	
Command	Privilege, global and interface configuration modes

Mode	
Usage Guide	<p>Check the interfaces configured with IPv4 PBR according to the output information and the name of the used route map.</p> <pre>FS# show ip policy Banalance mode: redundance Interface Route map local RM_for_PBR_1 GigabitEthernet 0/1 RM_for_PBR_2</pre> <p>Local indicates applying policy-based routing for IPv4 packets locally initiated.</p>

↘ **Checking the configurations of IPv6 PBR**

Command	show ipv6 policy [<i>route-map-name</i>]
Parameter Description	<i>route-map-name</i> : Indicates the name of a route map.
Command Mode	Privilege, global and interface configuration modes
Usage Guide	<p>Check the interfaces configured with IPv6 PBR according to the output information and the name of the used route map.</p> <pre>FS#show ipv6 policy Banalance mode: redundance Interface Route map local RM_for_PBR_1 VLAN 1 RM_for_PBR_2</pre> <p>Local indicates applying policy-based routing for IPv6 packets locally initiated.</p>

↘ **Checking the configurations of a route map**

Command	show route-map [<i>route-map-name</i>]
Parameter Description	<i>route-map-name</i> : Indicates the name of a route map.
Command Mode	Privilege, global and interface configuration modes
Usage Guide	<p>Multiple route maps may be available on a device. Focus on the route map used in PBR and check its policy settings.</p> <pre>FS# show route-map route-map RM_FOR_PBR, permit, sequence 10 Match clauses: ip address acl1 Set clauses: ip next-hop 200.24.18.1</pre>

```
route-map RM_FOR_PBR, permit, sequence 20

  Match clauses:

    ip address acl2

  Set clauses:

    ip next-hop 200.24.19.1
```

📌 **Checking the configurations of an ACL**

Command	show access-lists [<i>acl-id</i> <i>acl-name</i>]
Parameter	<i>acl-id</i> : Indicates the ACL ID.
Description	<i>acl-name</i> : Indicates the ACL name.
Command Mode	Privilege, global and interface configuration modes
Usage Guide	Multiple ACLs may be available on a device. Focus on the ACL used by a route map and check its configurations. <pre>FS# show access-lists 1 ip access-list standard 1 10 permit 200.24.16.0 0.0.0.255 ip access-list standard 2 10 permit 200.24.17.0 0.0.0.255</pre>

📌 **Checking the routing information of IPv4 PBR**

Command	show ip pbr route [interface <i>if-name</i> local]
Parameter	<i>if-name</i> : Indicates an interface name.
Description	local : Indicates local.
Command Mode	Privilege, global and interface configuration modes
Usage Guide	Specify a local interface or device and check the routing information of IPv4 PBR. <pre>FS# show ip pbr route PBR IPv4 Route Summay : 1 Interface : GigabitEthernet 0/1 Sequence : 10 Min Length : None Max Length : None VRF ID : 0 Route Flags : Route Type : PBR Direct : Permit Priority : High</pre>

	<pre> Tos_Dscp : None Precedence : None Tos_Dscp : 0 Precedence : 0 Mode : redundance Nexthop Count : 1 Nexthop[0] : 192.168.8.100 Weight[0] : 1 Ifindex[0] : 2 </pre>
--	--

➤ **Checking the routing information of IPv6 PBR**

Command	show ipv6 pbr route [interface <i>if-name</i> local]
Parameter	<i>if-name</i> : Indicates an interface name.
Description	local : Indicates local.
Command Mode	Privilege, global and interface configuration modes
Usage Guide	<p>Specify a local interface or device and check the routing information of IPv6 PBR.</p> <pre> FS# show ipv6 pbr route PBR IPv6 Route Summary : 1 Interface : GigabitEthernet 0/1 Sequence : 10 ACL[0] : 2900 ACL_CLS[0] : 5 Min Length : None Max Length : None VRF ID : 0 Route Flags : Route Type : PBR Direct : Permit Priority : High Tos_Dscp : None Precedence : None Tos_Dscp : 0 Precedence : 0 Mode : redundance </pre>

	<pre> NextHop Count : 1 NextHop[0] : 10::2 Weight[0] : 1 Ifindex[0] : 2 </pre>
--	---

↘ **Checking a route map used by IPv4 PBR**

Command	show ip pbr route-map <i>rmap-name</i>
Parameter	<i>rmap-name</i> : Indicates the route map name.
Description	
Command Mode	Privilege, global and interface configuration modes
Usage Guide	<p>Specify a route map and check the route map used by IPv4 PBR.</p> <pre> FS# show ip pbr route-map rm PBR VRF: GLOBAL, ID: 0 Forward Mode: redundance Forwarding: On Route-map rm Route-map index: Sequence 10, permit Match rule: ACL ID : 2900, CLS: 1, Name: acl1 Set rule: IPv4 nexthop: 192.168.8.100, (VRF name: , ID: 0), Weight: 0 PBR state info ifx: 2, Connected: True, Track state: Up </pre>

↘ **Checking a route map used by IPv6 PBR**

Command	show ipv6 pbr route-map <i>rmap-name</i>
Parameter	<i>rmap-name</i> : Indicates the route map name.
Description	
Command Mode	Privilege, global and interface configuration modes
Usage Guide	<p>Specify a route map and check the route map used by IPv6 PBR.</p> <pre> FS# show ipv6 pbr route-map rm6 PBR VRF: GLOBAL, ID: 0 Forward Mode: redundance Forwarding: On </pre>

```
Route-map rm6
  Route-map index: Sequence 10, permit
  Match rule:
    ACL ID : 2901, CLS: 5, Name: acl6
  Set rule:
    IPv6 nexthop: 10::2, (VRF name: , ID: 0), Weight: 0
    PBR state info ifx: 2, Connected: True, Track state: Up
```

📌 **Checking the statistics about packets forwarded by IPv4 PBR**

Command	<code>show ip pbr statistics [interface <i>if-name</i> local]</code>
Parameter	<i>if-name</i> : Indicates an interface name.
Description	local : Indicates local.
Command Mode	Privilege, global and interface configuration modes
Usage Guide	<pre>FS# show ip pbr statistics IPv4 Policy-based route statistic gigabitEthernet 0/1 statistics : 10</pre>

📌 **Checking the statistics about packets forwarded by IPv6 PBR**

Command	<code>show ipv6 pbr statistics [interface <i>if-name</i> local]</code>
Parameter	<i>if-name</i> : Indicates an interface name.
Description	local : Indicates local.
Command Mode	Privilege, global and interface configuration modes
Usage Guide	<pre>FS# show ipv6 pbr statistics IPv6 Policy-based route statistic gigabitEthernet 0/1 statistics : 20</pre>

Configuration Example

➤ **Configuring IPv4 PBR and selecting an output link based on source addresses of packets**

<p>Scenario Figure 9-3</p>	
	<p>The layer-3 device DEV 1 is connected to subnet 1 and subnet 2 through GE0/3. The network segment where subnet 1 resides is 200.24.16.0/24 whereas the network segment where subnet 2 resides is 200.24.17.0/24. DEV 1 is connected to the Internet through GE0/1 and GE0/2 and their next hops are 200.24.18.1 and 200.24.19.1.</p>
	<p>This LAN has two output interfaces for connecting the Internet. The requirements are as follows:</p> <ul style="list-style-type: none"> ● Data streams from subnet 1 for accessing the Internet should pass GE 0/1. ● Data streams from subnet 2 for accessing the Internet should pass GE 0/2. ● If the GE 0/1 link is disconnected, the data streams on the GE 0/1 interface are switched to the GE 0/2 interface. Vice versa.
<p>Configuration Steps</p>	<ul style="list-style-type: none"> ● Configure two ACLs to match packets from subnets 1 and 2 respectively. ● Set a policy to set the next hops for packets from subnet 1 to GE0/1 and GE0/2. (Pay attention to the configuration sequence.) ● Set a policy to set the next hops for packets from subnet 2 to GE0/2 and GE0/1. (Pay attention to the configuration sequence.) ● Apply the policy to GE 0/3. ● Set PBR to implement redundant backup among multiple next hops. (The default setting is redundant backup.) <p> During redundant backup, based on the configuration sequence, the first next hop takes effect first.</p>
	<pre>DEV1(config)# access-list 1 permit 200.24.16.0 0.0.0.255 DEV1(config)# access-list 2 permit 200.24.17.0 0.0.0.255 DEV1(config)# route-map RM_FOR_PBR 10 DEV1(config-route-map)# match ip address 1 DEV1(config-route-map)# set ip next-hop 200.24.18.1 DEV1(config-route-map)# set ip next-hop 200.24.19.1</pre>

	<pre> DEV1(config-route-map)# exit DEV1(config)# route-map RM_FOR_PBR 20 DEV1(config-route-map)# match ip address 2 DEV1(config-route-map)# set ip next-hop 200.24.19.1 DEV1(config-route-map)# set ip next-hop 200.24.18.1 DEV1(config-route-map)# exit DEV1(config)# interface GigabitEthernet 0/3 DEV1(config-if-GigabitEthernet 0/3)# ip policy route-map RM_FOR_PBR DEV1(config-if-GigabitEthernet 0/3)# exit DEV1(config)# ip policy redundance </pre>
<p>Verification</p>	<ul style="list-style-type: none"> ● Check the configurations of IPv4 PBR. ● Check the configurations of the route map. ● Check the configurations of an ACL.
	<pre> DEV1# show ip policy Interface Route map GigabitEthernet 0/3 RM_FOR_PBR </pre>
	<pre> DEV1# show route-map route-map RM_FOR_PBR, permit, sequence 10 Match clauses: ip address 1 Set clauses: ip next-hop 200.24.18.1 200.24.19.1 route-map RM_FOR_PBR, permit, sequence 20 Match clauses: ip address 2 Set clauses: ip next-hop 200.24.19.1 200.24.18.1 </pre>
	<pre> DEV1# show access-lists ip access-list standard 1 10 permit 200.24.16.0 0.0.0.255 ip access-list standard 2 10 permit 200.24.17.0 0.0.0.255 </pre>

➤ **Configuring IPv6 PBR and selecting an output link based on source addresses of packets**

<p>Scenario Figure 9-4</p>	<p>The diagram shows a central Layer-3 device DEV1. It has two interfaces connected to the Internet: Gi 0/1 (with next hop 2001::1) and Gi 0/2 (with next hop 2002::1). It also has one interface, Gi 0/3, which is connected to two subnets: Subnet 1 (2003::/64) and Subnet 2 (2004::/64).</p>
	<p>DEV 1 is connected to subnet 1 and subnet 2 through GE0/3. The network segment where subnet 1 resides is 2003::/64 whereas the network segment where subnet 2 resides is 2004::/64. DEV1 is connected to the Internet through GE0/1 and GE0/2 and their next hops are 2001::1/64 and 2002::1/64.</p>
	<p>This LAN has two output interfaces for connecting the Internet. The requirements are as follows:</p> <ul style="list-style-type: none"> • Data streams from subnet 1 for accessing the Internet should pass GE 0/1. • Data streams from subnet 2 for accessing the Internet should pass GE 0/2. • If the GE 0/1 link is disconnected, the data streams on the GE 0/1 interface are switched to the GE 0/2 interface. Vice versa.
<p>Configuration Steps</p>	<ul style="list-style-type: none"> • Configure two ACLs to match packets from subnets 1 and 2 respectively. • Set a policy to set the next hops for packets from subnet 1 to GE0/1 and GE0/2. (Pay attention to the configuration sequence.) • Set a policy to set the next hops for packets from subnet 2 to GE0/2 and GE0/1. (Pay attention to the configuration sequence.) • Apply the policy to GE 0/3. • Set PBR to implement redundant backup among multiple next hops. <p>i During redundant backup, based on the configuration sequence, the first next hop takes effect first.</p>
	<pre>DEV1(config)# ipv6 access-list net1 DEV1(config-ipv6-acl)# permit ipv6 2003::/64 any DEV1(config-ipv6-acl)# exit DEV1(config)# ipv6 access-list net2 DEV1(config-ipv6-acl)# permit ipv6 2004::/64 any DEV1(config-ipv6-acl)# exit DEV1(config)# route-map RM_FOR_PBR 30</pre>

	<pre> DEV1(config-route-map)# match ipv6 address net1 DEV1(config-route-map)# set ipv6 next-hop 2001::1 DEV1(config-route-map)# set ipv6 next-hop 2002::1 DEV1(config-route-map)# exit DEV1(config)# route-map RM_FOR_PBR 40 DEV1(config-route-map)# match ipv6 address net2 DEV1(config-route-map)# set ipv6 next-hop 2002::1 DEV1(config-route-map)# set ipv6 next-hop 2001::1 DEV1(config-route-map)# exit DEV1(config)# interface GigabitEthernet 0/3 DEV1(config-if-GigabitEthernet 0/3)# ipv6 policy route-map RM_FOR_PBR DEV1(config-if-GigabitEthernet 0/3)# exit DEV1(config)# ipv6 policy redundancy </pre>
<p>Verification</p>	<ul style="list-style-type: none"> ● Check the configurations of IPv6 PBR. ● Check the configurations of the route map. ● Check the configurations of an ACL.
	<pre> DEV1# show ipv6 policy Interface Route map GigabitEthernet 0/3 RM_FOR_PBR </pre>
	<pre> DEV1# show route-map route-map RM_FOR_PBR, permit, sequence 11 Match clauses: ipv6 address net1 Set clauses: ipv6 next-hop 2001::1 2002::1 route-map RM_FOR_PBR, permit, sequence 21 Match clauses: ipv6 address net2 Set clauses: ipv6 next-hop 2002::1 2001::1 </pre>
	<pre> DEV1# show access-lists ipv6 access-list net1 10 permit ipv6 2003::/64 any </pre>

```
(0 packets matched)
ipv6 access-list net2
10 permit ipv6 2004::/64 any
(0 packets matched)
```

➤ **Configuring correlation between IPv4 PBR and Track**

<p>Scenario Figure 9-5</p>	
	<p>The layer-3 device DEV 1 is connected to subnet 1 and subnet 2 through GE0/3. The network segment where subnet 1 resides is 200.24.16.0/24 whereas the network segment where subnet 2 resides is 200.24.17.0/24. DEV 1 is connected to the Internet through GE0/1 and GE0/2 and their next hops are 200.24.18.1 and 200.24.19.1.</p>
	<ul style="list-style-type: none"> ● DEV1 can fast detect a faulty output link and switch to a backup link.
<p>Configuration Steps</p>	<p>When configuring IPv4 PBR and selecting an output link based on source addresses of the packets, add or modify the following configurations (red fields):</p> <ul style="list-style-type: none"> ● Set two Track objects and track the accessibility of the next hops of the two output interfaces. ● When configuring a policy, set the correlation between the next hops and the Track objects.
<p>DEV1</p>	<pre>DEV1(config)# ip access-list extended 101 DEV1(config-ip-acl)# permit ip 200.24.16.0 0.0.0.255 any DEV1(config-ip-acl)# exit DEV1(config)# ip access-list extended 102 DEV1(config-ip-acl)# permit ip 200.24.17.0 0.0.0.255 any DEV1(config-ip-acl)# exit DEV1(config)#ip rns 1 DEV1(config-ip-rns)#icmp-echo 200.24.18.1 DEV1(config)#ip rns schedule 1 start-time now life forever DEV1(config)#track 1 rns 1</pre>

	<pre> DEV1(config)#ip rns 2 DEV1(config-ip-rns)#icmp-echo 200.24.19.1 DEV1(config)#ip rns schedule 2 start-time now life forever DEV1(config)#track 2 rns 2 DEV1(config)# route-map RM_FOR_PBR 10 DEV1(config-route-map)# match ip address 101 DEV1(config-route-map)# set ip next-hop verify-availability 200.24.18.1 track 1 DEV1(config-route-map)# set ip next-hop verify-availability 200.24.19.1 track 2 DEV1(config-route-map)# exit DEV1(config)# route-map RM_FOR_PBR 20 DEV1(config-route-map)# match ip address 102 DEV1(config-route-map)# set ip next-hop verify-availability 200.24.19.1 track 2 DEV1(config-route-map)# set ip next-hop verify-availability 200.24.18.1 track 1 DEV1(config-route-map)# exit DEV1(config)# interface GigabitEthernet 0/3 DEV1(config-if-GigabitEthernet 0/3)# ip policy route-map RM_FOR_PBR DEV1(config-if-GigabitEthernet 0/3)# exit DEV1(config)# ip policy redundancy </pre>
Verification	<ul style="list-style-type: none"> ● Check whether the Track objects are up.
DEV1	<pre> FS#show track Track 1 Reliable Network Service 1 The state is Up 1 change, current state last: 120 secs Delay up 30 secs, down 50 secs Track 2 Reliable Network Service 2 The state is Up 1 change, current state last: 130 secs Delay up 30 secs, down 50 secs </pre>

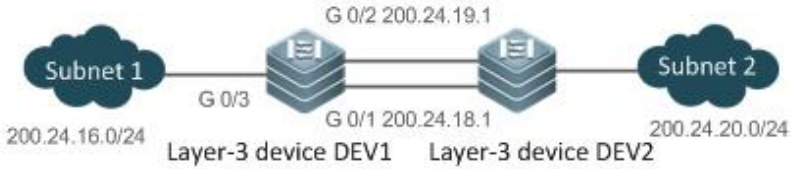

➤ **Configuring IPv4 recursive PBR, selecting an output link based on source addresses of the packets, and recurring to the output link of a dynamic route**

<p>Scenario Figure 9-6</p>	
	<p>The layer-3 device DEV 1 is connected to subnet 1 through GE0/3. The network segment where subnet 1 resides is 200.24.16.0/24. DEV 1 is connected to subnet 2 through GE0/1 and GE0/2 and their next hops are 200.24.18.1 and 200.24.19.1.</p>
	<p>Subnet 1 is connected to subnet 2 through two output interfaces of DEV1. The requirements are as follows:</p> <ul style="list-style-type: none"> ● Configure static or dynamic routes in advance to ensure that static or dynamic routes in the network segment 200.24.20.0 are available in the routing table of DEV1. ● Data streams from subnet 1 for accessing the Internet can recur to a dynamic route whose IP address is 200.24.20.1. ● If the GE 0/1 link is disconnected, the data streams on GE 0/1 are switched to GE 0/2. Vice versa.
<p>Configuration Steps</p>	<ul style="list-style-type: none"> ● Configure an ACL to match packets from subnet 1. ● Set a policy to set the recursive next hop for packets from subnet 1 to 200.24.20.1. ● Apply the policy to GE 0/3. ● Set PBR to implement redundant backup among multiple next hops. (The default setting is redundant backup.) <p>i During redundant backup, the sequence for the next hops to take effect is related to the sequence for the static or dynamic routes to take effect.</p>
	<pre>DEV1(config)# access-list 1 permit 200.24.16.0 0.0.0.255 DEV1(config)# route-map RM_FOR_PBR 10 DEV1(config-route-map)# match ip address 1 DEV1(config-route-map)# set ip next-hop recursive 200.24.20.1 DEV1(config-route-map)# exit DEV1(config)# interface GigabitEthernet 0/3 DEV1(config-if-GigabitEthernet 0/3)# ip policy route-map RM_FOR_PBR DEV1(config-if-GigabitEthernet 0/3)# exit DEV1(config)# ip policy redundancy</pre>
<p>Verification</p>	<ul style="list-style-type: none"> ● Check the configurations of IPv4 PBR.

	<ul style="list-style-type: none"> ● Check the configurations of the route map. ● Check the configurations of the ACLs.
	<pre>DEV1# show ip policy Interface Route map GigabitEthernet 0/3 RM_FOR_PBR</pre>
	<pre>DEV1# show route-map route-map RM_FOR_PBR, permit, sequence 10 Match clauses: ip address 1 Set clauses: ip next-hop recursive 200.24.20.1</pre>
	<pre>DEV1# show access-lists ip access-list standard 1 10 permit 200.24.16.0 0.0.0.255</pre>

Common Errors

- A route map is used when PBR is configured but the route map does not exist.
- An ACL is used when a route map is configured but the ACL does not exist.

9.5.2 Setting Redundant Backup or Load Balancing

Configuration Effect

- Using multiple next hops in the mutual backup mode can enhance the network reliability.
- Implementing load balancing among multiple next hops can expand the network bandwidth.

Notes

- The basic functions of PBR must be configured.
- Redundant backup and load balancing are effective only for the next hops set by the following **set** commands.

Command	Description
set ip next-hop	Configures the next hop of IPv4 packets. This command carries the <i>weight</i> parameter, which is used to set the weight of the WCMP. The default value is 1.
set ip default next-hop	Configures the default next hop of IPv4 packets. This command carries the <i>weight</i> parameter, which is used to set the weight of the WCMP. The default value is 1.
set ipv6 next-hop	Configures the next hop of IPv6 packets. This command carries the <i>weight</i> parameter, which is used to set the weight of the WCMP. The default value is 1.
set ipv6 default next-hop	Configures the default next hop of IPv6 packets. This command carries the <i>weight</i> parameter, which is used to set the weight of the WCMP. The default value is 1.
set ip next-hop recursive	Configures the recursive next hop of IPv4 packets. Only one command can be configured for a route

	map and packets can recur to multiple next hops (up to 32 next hops) of a static or dynamic ECMP route. The redundant backup or load balancing mode for recurring to multiple next hops is also determined by the ip policy { redundancy load-balance } command.
set ip next-hop recursive	Configures the recursive next hop of IPv4 packets. Only one command can be configured for a route map and packets can recur to multiple next hops (up to 32 next hops) of a static or dynamic ECMP route. The redundant backup or load balancing mode for recurring to multiple next hops is also determined by the ip policy { redundancy load-balance } command.

 Up to eight next hops can be set for WCMP whereas up to 32 next hops can be set for ECMP.

Configuration Steps

Setting whether IPv4 PBR implements redundant backup or load balancing among multiple next hops

- If load balancing needs to be implemented among multiple next hops, this configuration needs to be performed.
- If load balancing is configured at present, you also need to perform this configuration to reset redundant backup.
- This configuration is effective for all PBRs configured on a device.

Command	ip policy { redundancy load-balance }
Parameter	redundance: Indicates redundant backup.
Description	load-balance: Indicates load balancing.
Defaults	Redundant backup is configured by default.
Command Mode	Global configuration mode
Usage Guide	If redundant backup is selected, the first next hop takes effect based on the configuration sequence. If load balancing is selected, all next hops take effect at the same time and share traffic by weight.

Setting whether Ipv6 PBR implements redundant backup or load balancing among multiple next hops

- If load balancing needs to be implemented among multiple next hops, this configuration needs to be performed.
- If load balancing is configured at present, you also need to perform this configuration to reset redundant backup.
- This configuration is effective for all PBRs configured on a device.

Command	ipv6 policy { redundancy load-balance }
Parameter	redundance: Indicates redundant backup.
Description	load-balance: Indicates load balancing.
Defaults	Redundant backup is configured by default.
Command Mode	Global configuration mode
Usage Guide	If redundant backup is selected, the first next hop takes effect based on the configuration sequence. If load balancing is selected, all next hops take effect at the same time and share traffic by weight.

Verification

- Check whether redundant backup or load balancing is implemented among multiple next hops.

Checking whether IPv4 PBR implements redundant backup or load balancing among multiple next hops

Command	show ip policy [route-map-name]
----------------	--

Parameter Description	route-map-name: Specifies a route map.
Command Mode	Privilege, global and interface configuration modes
Usage Guide	<p>See the following example and focus on the red field.</p> <pre> FS# show ip policy Banalance mode: redundance Interface Route map local test GigabitEthernet 0/3 test </pre>

📌 **Checking whether IPv6 PBR implements redundant backup or load balancing among multiple next hops**

Command	show ipv6 policy [route-map-name]
Parameter Description	route-map-name: Specifies a route map.
Command Mode	Privilege, global and interface configuration modes
Usage Guide	<p>See the following example and focus on the red field.</p> <pre> PE#show ipv6 policy Banalance mode: redundance Interface Route map VLAN 1 RM_for_Vlan_1 VLAN 2 RM_for_Vlan_2 </pre>

Configuration Example

📌 **Configuring IPv4 PBR to implement redundant backup among multiple next hops**

See the preceding example: Configuring IPv4 PBR and selecting an output link based on source addresses of packets

📌 **Configuring IPv6 PBR to implement redundant backup among multiple next hops**

See the preceding example: Configuring IPv6 PBR and selecting an output link based on source addresses of packets

📌 **Configuring IPv4 PBR to implement load balancing among multiple next hops**

<p>Scenario Figure 9-7</p>	
	<p>The layer-3 device DEV 1 is connected to subnet 1 and subnet 2 through GE0/3. The network segment where subnet 1 resides is 200.24.16.0/24 whereas the network segment where subnet 2 resides is 200.24.17.0/24. DEV 1 is connected to the Internet through GE0/1 and GE0/2 and their next hops are 200.24.18.1 and 200.24.19.1.</p>
	<p>This LAN has two output interfaces for connecting the Internet. The requirements are as follows: The traffic is equally shared by GE0/1 and GE0/2.</p>
<p>Configuration Steps</p>	<ul style="list-style-type: none"> ● Configure basic functions of PBR. Specify multiple next hops. ● Set the load balancing mode.
	<pre>DEV1(config)# route-map RM_LOAD_PBR 10 DEV1(config-route-map)# set ip next-hop 200.24.18.1 DEV1(config-route-map)# set ip next-hop 200.24.19.1 DEV1(config-route-map)# exit DEV1(config)# interface GigabitEthernet 0/3 DEV1(config-if-GigabitEthernet 0/3)# ip policy route-map RM_LOAD_PBR DEV1(config-if-GigabitEthernet 0/3)# exit DEV1(config)# ip policy load-balance</pre>
<p>Verification</p>	<ul style="list-style-type: none"> ● Check the configurations of IPv4 PBR. ● Check the configurations of the route map.
	<pre>DEV1# show ip policy Balance mode: load-balance Interface Route map GigabitEthernet 0/3 RM_LOAD_PBR</pre>
	<pre>DEV1# show route-map</pre>

```

route-map PBR-VRF-Selection, permit, sequence 10

Match clauses:

Set clauses:

ip next-hop 200.24.18.1 8
ip next-hop 200.24.19.1 8
    
```

➤ **Configuring IPv6 PBR to implement load balancing among multiple next hops**

<p>Scenario Figure 9- 8</p>	<p>The diagram illustrates a network topology. At the top, a cloud labeled 'Internet' is connected to a 'Layer-3 device DEV1' through two interfaces: Gi 0/1 and Gi 0/2. The Internet cloud is associated with the IPv6 address 2002::1. Below DEV1, another Layer-3 device is connected via interface Gi 0/3. This second device is connected to two subnets: 'Subnet 1' (2003::/64) and 'Subnet 2' (2004::/64).</p>
	<p>DEV 1 is connected to subnet 1 and subnet 2 through GE0/3. The network segment where subnet 1 resides is 2003::/64 whereas the network segment where subnet 2 resides is 2004::/64. DEV1 is connected to the Internet through GE0/1 and GE0/2 and their next hops are 2001::1/64 and 2002::1/64.</p>
	<p>This LAN has two output interfaces for connecting the Internet. The requirements are as follows: The traffic is equally shared by GE0/1 and GE0/2.</p>
<p>Configuration Steps</p>	<ul style="list-style-type: none"> ● Configure basic functions of PBR. Specify multiple next hops. ● Set the load balancing mode.
	<pre> DEV1(config)# route-map RM_LOAD_PBR 20 DEV1(config-route-map)# set ipv6 next-hop 2001::1 DEV1(config-route-map)# set ipv6 next-hop 2002::1 DEV1(config-route-map)# exit DEV1(config)# interface GigabitEthernet 0/3 DEV1(config-if-GigabitEthernet 0/3)# ipv6 policy route-map RM_LOAD_PBR DEV1(config-if-GigabitEthernet 0/3)# exit DEV1(config)# ipv6 policy load-balance </pre>
<p>Verification</p>	<ul style="list-style-type: none"> ● Check the configurations of IPv6 PBR.

	<ul style="list-style-type: none"> ● Check the configurations of the route map.
	<pre> DEV1# show ipv6 policy Balance mode: load-balance Interface Route map GigabitEthernet 0/3 RM_LOAD_PBR DEV1# show route-map route-map PBR-VRF-Selection, permit, sequence 10 Match clauses: Set clauses: ipv6 next-hop 2001::1 ipv6 next-hop 2002::1 </pre>

9.5.3 Configuring Source-Address-Based PBR

Configuration Effect

Perform personalized routing management for IPv4 or IPv6 addresses of user data streams by preparing flexible policies.

Notes

- Source-address-based PBR has a higher priority than interface-based PBR. When they are applied to an interface at the same time, interface-based PBR takes effect whereas source-address-based PBR does not take effect.

Configuration Steps

🔻 Applying source-address-based PBR for IPv4 packets received by an interface

- To perform personalized routing management based on source IPv4 addresses for IPv4 user data streams passing a device, you should perform this configuration.
- The global configuration takes effect on the input interface of specified user data streams.
- Run the **ip policy-source in-interface** command to perform source-address-based PBR for IPv4 packets received by a specified interface.

Command	ip policy-source in-interface <i>interface-type</i> <i>sequence</i> { <i>source-address mask</i> <i>source-address/mask</i> } [default] next-hop <i>ip-address</i> [<i>weight</i>] [default] interface <i>out-interface-type</i> vrf <i>vrf-name</i> }
Parameter Description	<i>interface-type</i> : Specifies the type of an interface to which source-address PBR is applied. <i>sequence</i> : Indicates the sequence number of a policy. A smaller sequence number means a higher priority. <i>source-address</i> : Indicates the source IPv4 address. <i>mask</i> : Indicates the mask of the source IPv4 address. <i>ip-address</i> : Indicates the next-hop IPv4 address. <i>weight</i> : Indicates the weight of a next hop. <i>out-interface-type</i> : Indicates the type of the next hop output interface. <i>vrf-name</i> : Indicates the name of a VRF instance.
Defaults	By default, source-address-based PBR is unavailable on a device and packets are forwarded based on a routing table.

Command Mode	Global configuration mode
Usage Guide	<p>Configure multiple ip policy-source in-interface commands for the same interface. The sequence numbers of different source addresses are different. A smaller sequence number means a higher priority of the source-address-based PBR.</p> <p>When the sequence number is the same, the priorities of next hops are as follows: vrf vrf-name > next-hop ip-address > interface out-interface-type > default next-hop ip-address > default interface out-interface-type.</p> <p>Source-address-based PBR has a higher priority than interface-based PBR. When they are applied to an interface at the same time, interface-based PBR takes effect whereas source-address-based PBR does not take effect.</p>

➤ **Applying source-address-based PBR for IPv6 packets received by an interface**

- To perform personalized routing management based on source IPv6 addresses for IPv6 user data streams passing a device, you should perform this configuration.
- The global configuration takes effect on the input interface of specified user data streams.
- Run the **ipv6 policy-source in-interface** command to perform source-address-based PBR for IPv6 packets received by a specified interface.

Command	ipv6 policy-source in-interface <i>interface-type</i> <i>sequence</i> { <i>source-address/prefix-length</i> } {[default] next-hop <i>ipv6-address</i> [<i>weight</i>] [default] interface <i>out-interface-type</i> vrf <i>vrf-name</i> }
Parameter Description	<p><i>interface-type</i>: Specifies the type of an interface to which source-address PBR is applied.</p> <p><i>sequence</i>: Indicates the sequence number of a policy. A smaller sequence number means a higher priority.</p> <p><i>source-address</i>: Indicates the source IPv6 address.</p> <p><i>prefix-length</i>: Indicates the prefix length of a source IPv6 address.</p> <p><i>ipv6-address</i>: Indicates the next-hop IPv6 address.</p> <p><i>weight</i>: Indicates the weight of a next hop.</p> <p><i>out-interface-type</i>: Indicates the type of the next hop output interface.</p> <p><i>vrf-name</i>: Indicates the name of a VRF instance.</p>
Defaults	By default, source-address-based PBR is unavailable on a device and packets are forwarded based on a routing table.
Command Mode	Global configuration mode
Usage Guide	<p>Configure multiple ipv6 policy-source in-interface commands for the same interface. The sequence numbers of different source addresses are different. A smaller sequence number means a higher priority of the source-address-based PBR.</p> <p>When the sequence number is the same, the priorities of next hops are as follows: vrf vrf-name > next-hop ipv6-address > interface out-interface-type > default next-hop ipv6-address > default interface out-interface-type.</p> <p>Source-address-based PBR has a higher priority than interface-based PBR. When they are applied to an interface at the same time, interface-based PBR takes effect whereas source-address-based PBR does not take effect.</p>

Verification

➤ **Checking the routing information of source-address-based IPv4 PBR**

Command	show ip pbr source-route [interface <i>if-name</i>]
Parameter Description	<i>if-name</i> : Indicates an interface name.
Command	Privilege, global and interface configuration modes

Mode	
Usage Guide	<p>Specify an interface and check the routing information of IPv4 source-address-based PBR.</p> <pre> FS# show ip pbr source-route PBR IPv4 Source Route Interface : GigabitEthernet 0/1 Sequence : 10 Source address : 10.1.1.1/24 VRF ID : 0 Route Flags : Route Type : PBR Direct : Permit Priority : High Match_ipaddr : Exist Mode : redundance Nexthop Count : 1 Nexthop[0] : 192.168.8.100 Weight[0] : 1 Ifindex[0] : 2 </pre>

📌 Checking the routing information of IPv6 PBR

Command	show ipv6 pbr source-route [interface <i>if-name</i>]
Parameter	<i>if-name</i> : Indicates an interface name.
Description	
Command Mode	Privilege, global and interface configuration modes
Usage Guide	<p>Specify an interface and check the routing information of IPv6 PBR.</p> <pre> FS# show ipv6 pbr source-route PBR IPv6 Source Route Interface : GigabitEthernet 0/1 Sequence : 10 Source address : 1000::1/64 VRF ID : 0 Route Flags : Route Type : PBR Direct : Permit Priority : High </pre>

Match_ipaddr	: Exist
Mode	: redundance
Nexthop Count	: 1
Nexthop[0]	: 1001::2
Weight[0]	: 1
Ifindex[0]	: 3

Configuration Example

➤ **Configuring IPv4 source-address-based PBR and selecting an output link based on source addresses of packets**

<p>Scenario Figure 9-9</p>	
	<p>The layer-3 device DEV 1 is connected to subnet 1 and subnet 2 through GE0/3. The network segment where subnet 1 resides is 200.24.16.0/24 whereas the network segment where subnet 2 resides is 200.24.17.0/24. DEV 1 is connected to the Internet through GE0/1 and GE0/2 and their next hops are 200.24.18.1 and 200.24.19.1.</p>
	<p>This LAN has two output interfaces for connecting the Internet. The requirements are as follows:</p> <ul style="list-style-type: none"> ● Data streams from subnet 1 for accessing the Internet should pass GE 0/1. ● Data streams from subnet 2 for accessing the Internet should pass GE 0/2. ● If the GE 0/1 link is disconnected, the data streams on GE 0/1 are switched to GE 0/2. Vice versa.
<p>Configuration Steps</p>	<ul style="list-style-type: none"> ● Set source-address-based PBR and set the next hops for packets from the GE0/3 subnet 1 to GE0/1 and GE0/2. (Pay attention to the configuration sequence.) ● Set source-address-based PBR and set the next hops for packets from the GE0/3 subnet 2 to GE0/2 and GE0/1. (Pay attention to the configuration sequence.) ● Set PBR to implement redundant backup among multiple next hops. (The default setting is redundant backup.) <p> During redundant backup, based on the configuration sequence, the first next hop takes effect first.</p>
	<pre>DEV1(config)# ip policy-source in-interface gigabitEthernet 0/3 1 200.24.16.0/24 next-hop 200.24.18.1 200.24.19.1 DEV1(config)# ip policy-source in-interface gigabitEthernet 0/3 2 200.24.17.0/24 next-hop 200.24.19.1 200.24.18.1</pre>

	DEV1(config)# ip policy redundancy
Verification	<ul style="list-style-type: none"> ● Check the routing information of source-address-based IPv4 PBR.
	<pre> DEV1# show ip pbr source-route PBR IPv4 Source Route Interface : GigabitEthernet 0/3 Sequence : 1 Source address : 200.24.16.0/24 VRF ID : 0 Route Flags : Route Type : PBR Direct : Permit Priority : High Match_ipaddr : Exist Mode : redundancy Nexthop Count : 2 Nexthop[0] : 200.24.18.1 Weight[0] : 1 Ifindex[0] : 1 Nexthop[1] : 200.24.19.1 Weight[1] : 1 Ifindex[1] : 2 Interface : GigabitEthernet 0/3 Sequence : 2 Source address : 200.24.17.0/24 VRF ID : 0 Route Flags : Route Type : PBR Direct : Permit Priority : High Match_ipaddr : Exist Mode : redundancy Nexthop Count : 2 </pre>

```

NextHop[0] : 200.24.19.1
Weight[0] : 1
Ifindex[0] : 2
NextHop[1] : 200.24.18.1
Weight[1] : 1
Ifindex[1] : 1
    
```

➤ **Configuring IPv6 source-address-based PBR and selecting an output link based on source addresses of packets**

<p>Scenario Figure 9- 10</p>	
	<p>DEV 1 is connected to subnet 1 and subnet 2 through GE0/3. The network segment where subnet 1 resides is 2003::/64 whereas the network segment where subnet 2 resides is 2004::/64. DEV1 is connected to the Internet through GE0/1 and GE0/2 and their next hops are 2001::1/64 and 2002::1/64.</p>
	<p>This LAN has two output interfaces for connecting the Internet. The requirements are as follows:</p> <ul style="list-style-type: none"> ● Data streams from subnet 1 for accessing the Internet should pass GE 0/1. ● Data streams from subnet 2 for accessing the Internet should pass GE 0/2. ● If the GE 0/1 link is faulty, the data streams on GE 0/1 are switched to GE 0/2. Vice versa.
<p>Configuration Steps</p>	<ul style="list-style-type: none"> ● Set source-address-based PBR and set the next hops for packets from the GE0/3 subnet 1 to GE0/1 and GE0/2. (Pay attention to the configuration sequence.) ● Set source-address-based PBR and set the next hops for packets from the GE0/3 subnet 2 to GE0/2 and GE0/1. (Pay attention to the configuration sequence.) ● Set PBR to implement redundant backup among multiple next hops. <p> During redundant backup, based on the configuration sequence, the first next hop takes effect first.</p>
	<pre> DEV1(config)# ipv6 policy-source in-interface gigabitEthernet 0/3 1 2003::/64 next-hop 2001::1 2002::1 DEV1(config)# ip policy-source in-interface gigabitEthernet 0/3 2 2004::/64 next-hop 2002::1 2001::1 DEV1(config)# ipv6 policy redundancy </pre>

Verification	<ul style="list-style-type: none"> ● Check the configuration of IPv6 source-address-based PBR.
	<pre> DEV1# show ipv6 pbr source-route PBR IPv6 Source Route Interface : GigabitEthernet 0/3 Sequence : 1 Source address : 2003::/64 VRF ID : 0 Route Flags : Route Type : PBR Direct : Permit Priority : High Match_ipaddr : Exist Mode : redundance Nexthop Count : 2 Nexthop[0] : 2001::1 Weight[0] : 1 Ifindex[0] : 1 Nexthop[1] : 2002::1 Weight[1] : 1 Ifindex[1] : 2 Interface : GigabitEthernet 0/3 Sequence : 2 Source address : 2004::/64 VRF ID : 0 Route Flags : Route Type : PBR Direct : Permit Priority : High Match_ipaddr : Exist Mode : redundance Nexthop Count : 2 Nexthop[0] : 2002::1 </pre>

Weight[0]	: 1
Iindex[0]	: 2
Nexthop[1]	: 2001::1
Weight[1]	: 1
Iindex[1]	: 1

9.6 Monitoring

Clearing



Running the **clear** commands may lose vital information and thus interrupt services.

Description	Command
Clears the statistics about packets forwarded by IPv4 PBR.	clear ip pbr statistics [interface <i>if-name</i> local]
Clears the statistics about packets forwarded by IPv6 PBR.	clear ipv6 pbr statistics [interface <i>if-name</i> local]

Displaying

Description	Command
Displays the configurations of IPv4 PBR.	show ip policy
Displays the configurations of IPv6 PBR.	show ipv6 policy
Displays the configurations of a route map.	show route-map [<i>name</i>]
Displays the configurations of an ACL.	show access-list
Displays the correlation between IPv4 PBR and BFD.	show ip pbr bfd
Displays the correlation between IPv6 PBR and BFD.	show ipv6 pbr bfd
Displays the routing information of IPv4 PBR.	show ip pbr route [interface <i>if-name</i> local]
Displays the routing information of IPv6 PBR.	show ipv6 pbr route [interface <i>if-name</i> local]
Displays a route map used by IPv4 PBR.	show ip pbr route-map <i>rmap-name</i>
Displays a route map used by IPv6 PBR.	show ipv6 pbr route-map <i>rmap-name</i>
Displays the routing information of IPv4 source-address-based PBR.	show ip pbr source-route [interface <i>if-name</i>]
Displays the routing information of IPv6 source-address-based PBR.	show ipv6 pbr source-route [interface <i>if-name</i>]
Displays the statistics about IPv4 PBR.	show ip pbr statistics [interface <i>if-name</i> local]
Displays the statistics about IPv6 PBR.	show ipv6 pbr statistics [interface <i>if-name</i> local]

Debugging



System resources are occupied when debugging information is output. Therefore, disable debugging immediately after use.

Description	Command
Debugs PBR errors.	debug pbr error

Description	Command
Debugs PBR events.	debug pbr events
Debugs multiple service cards supported by PBR.	debug pbr ms
Debugs PBR message communication.	debug pbr msg
Debugs interaction between PBR and NSM.	debug pbr nsm
Debugs packet forwarding of PBR.	debug pbr packet
Debugs PBR GR.	debug pbr restart

10 Managing Routes

10.1 Overview

The network service module (NSM) manages the routing table, consolidates routes sent by various routing protocols, and selects and sends preferred routes to the routing table. Routes discovered by various routing protocols are stored in the routing table. These routes are generally classified by source into three types:

- Direct route: It is the route discovered by a link-layer protocol and is also called interface route.
- Static route: It is manually configured by the network administrator. A static route is easy to configure and less demanding on the system, and therefore applicable to a small-sized network that is stable and has a simple topology. However, when the network topology changes, the static route must be manually reconfigured and cannot automatically adapt to the topological changes.
- Dynamic route: It is the route discovered by a dynamic routing protocol.

10.2 Applications

Application	Description
Basic Functions of the Static Route	Manually configure a route.
Floating Static Route	Configure a standby route in the multipath scenario.
Load Balancing Static Route	Configure load balancing static routes in the multipath scenario.
Correlation of Static Routes with BFD	Use the Bidirectional Forwarding Detection (BFD) function to test whether the next hop of a static route is reachable.
Fast Reroute of Static Routes	Use the fast reroute function to improve the switching performance in the multipath scenario.
ARP-to-host Conversion	Use the ARP-to-host conversion to not transmit ARP packets sent by hosts across the whole network.
ND-to-route Conversion	Use the ND-to-route conversion to not transmit ND across the whole network
ND-to-route Delayed Release	Specify the time of delayed release to not immediately release the ND-to-route route

10.2.1 Basic Functions of the Static Route

Scenario

On a network with a simple topology, you can configure only static routes to implement network interworking. Appropriate configuration and use of static routes can improve the network performance and guarantee the bandwidth for important network applications.

As shown in Figure 10- 1, to implement interworking between PC 1, PC 2, and PC 3, you can configure static routes on R 1, R 2, and R 3.

- On R 1, configure a route to the network segment of PC 2 through R 2, and a route to the network segment of PC 3 through R 3.
- On R 2, configure a route to the network segment of PC 1 through R 1, and a route to the network segment of PC 3 through R 3.
- On R 3, configure a route to the network segment of PC 1 through R 1, and a route to the network segment of PC 2 through R 2.

Figure 10- 1

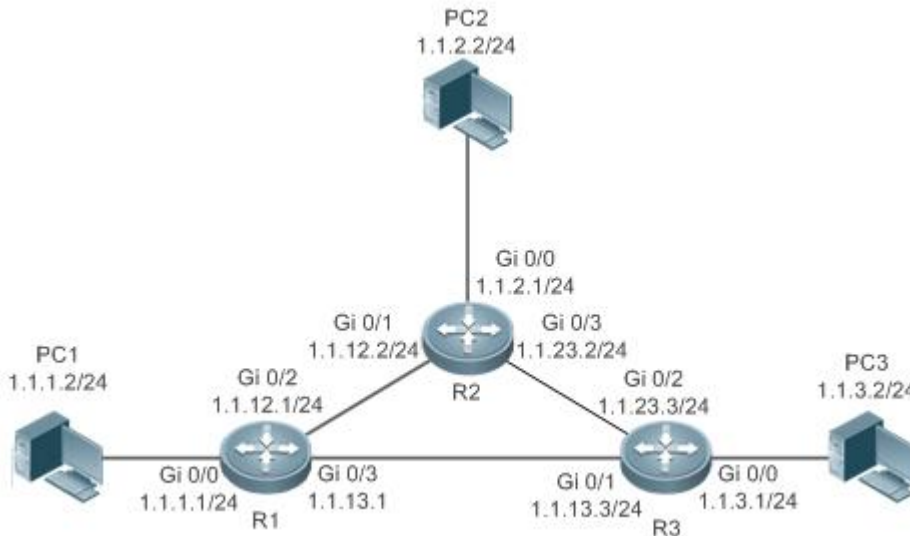

Deployment

- Configure the address and subnet mask of each interface.
- Configure static routes on R 1, R 2, and R 3.

10.2.2 Floating Static Route

Scenario

If no dynamic routing protocol is configured, you can configure floating static routes to implement dynamic switching of routes to prevent communication interruption caused by the network connection failures.

As shown in Figure 10- 2, to prevent communication interruption caused by a line failure between R 1 and R 3, you can configure a floating static route respectively on R 1 and R 3. Normally, packets are forwarded on a path with a small administrative distance. If a link on this path is down, the route is automatically switched to the path with a large administrative distance.

- On R1, configure two routes to the network segment of PC 3, including a route through R 3 (default distance = 1) and a route through R 2 (default distance = 2).
- On R 3, configure two routes to the network segment of PC 1, including a route through R 1 (default distance = 1) and a route through R 2 (default distance = 2).

Figure 10-2

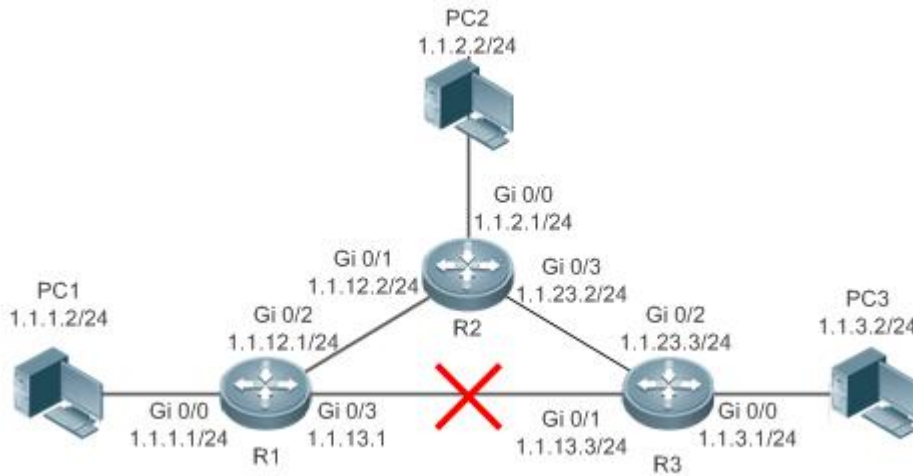

Deployment

- Configure the address and subnet mask of each interface.
- Configure static routes on R 1, R 2, and R 3.

10.2.3 Load Balancing Static Route

Scenario

If there are multiple paths to the same destination, you can configure load balancing routes. Unlike floating routes, the administrative distances of load balancing routes are the same. Packets are distributed among these routes based on the balanced forwarding policy.

As shown in Figure 10- 3, load balancing routes are configured respectively on R 1 and R 3 so that packets sent to the network segment of PC 3 or PC 1 are balanced between two routes, including a route through R 2 and a route through R 4.

- On R 1, configure two routes to the network segment of PC 3, including a route through R 2 and a route through R 4.
- On R 3, configure two routes to the network segment of PC 1, including a route through R 2 and a route through R 4.

Figure 10-3

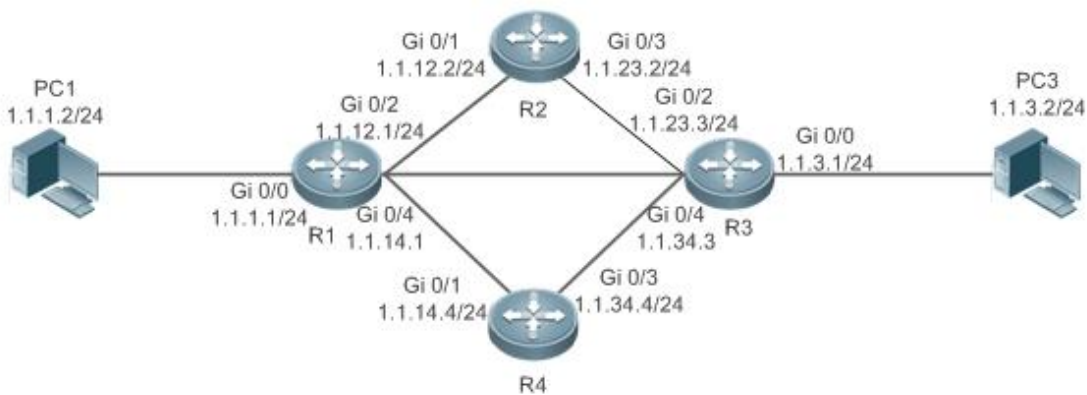

Remarks	On the switch, the load is balanced based on the destination IP address by default.
----------------	---

Deployment

- Configure the address and subnet mask of each interface.
- Configure static routes on R 1, R 2, R 3, and R 4.
- Configure the load balancing policy on R 1 and R 3.

10.2.4 Correlation of Static Routes with Track, BFD or ARP

Scenario

When the floating static routes or load balancing static routes are configured, the static routes may fail to sense the route failures if the line is faulty but the interface status is normal. To resolve this problem, the device needs to check whether the next hop of a static route is reachable. If the next hop is not reachable, the device can switch the traffic to the standby route.

You can use the Track, BFD or ARP function to check whether the next hop of a static route is reachable. The following scenario takes BFD as an example.

-  Three modes can all check whether the next hop of a static route is reachable. If more than one mode is configured, when one mode checks the next hop of a static route is unreachable, then the static route is invalid. Therefore, it is recommend to take only one mode.

As shown in Figure 10-4, to prevent communication interruption caused by a line failure between R 1 and R 3, you can configure a floating static route respectively on R 1 and R 3, and correlate static routes with BFD.

- On R 1, configure two routes to the network segment of PC 3, including a route through R 3 (default distance = 1) and a route through R 2 (default distance = 2). BFD is enabled on the first route to check whether the next hop 1.1.13.3 is reachable, and on the second route to check whether the next hop 1.1.12.2 is reachable.
- On R 3, configure two routes to the network segment of PC 1, including a route through R 1 (default distance = 1) and a route through R 2 (default distance = 2). BFD is enabled on the first route to check whether the next hop 1.1.13.1 is reachable, and on the second route to check whether the next hop 1.1.23.2 is reachable.

Figure 100- 4

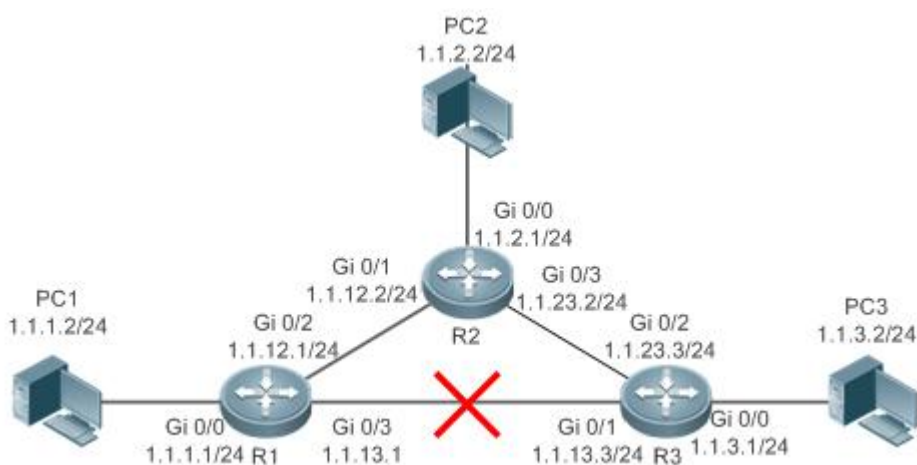

Deployment

- Configure the address and subnet mask of each interface.
- Configure the BFD parameters on each interface.

- Configure static routes and correlate these static routes with BFD on R 1, R 2, and R 3.

10.2.5 Fast Reroute of Static Routes

Scenario

To accelerate route switching and shorten the communication interruption time when no dynamic routing protocol is configured, you can either correlate static routes with Track, BFD or ARP to check whether the next hop is reachable. In addition, you can configure fast reroute to further improve the convergence performance.

As shown in Figure 10-5, to prevent communication interruption caused by a line failure between R 1 and R 3, you can configure static fast reroute respectively on R 1 and R 3. Normally, packets are forwarded on the path between R 1 and R 3. When the link on this route is down, packets are automatically rerouted to R 2.

- On R 1, configure a route with the exit interface set to Gi0/3 and the next hop set to 1.1.13.3, and a standby route with the exit interface set to Gi0/2 and the next hop set to 1.1.12.2.
- On R 3, configure a route with the exit interface set to Gi0/1 and the next hop set to 1.1.13.1, and a standby route with the exit interface set to Gi0/2 and the next hop set to 1.1.23.3.

Figure 10-5

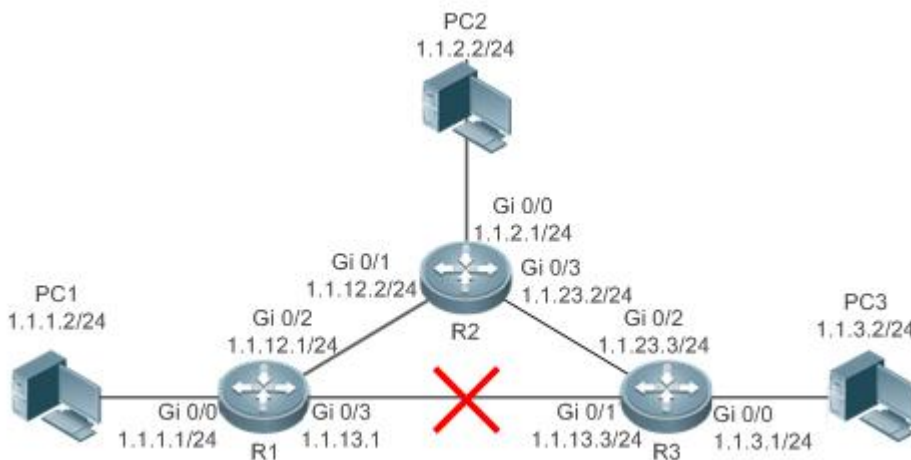

Deployment

- Configure the address and subnet mask of each interface.
- Configure static routes on R 1, R 2, and R 3.
- Configure static fast reroute on R 1, R 2, and R 3.

10.2.6 ARP-to-host Conversion

Scenario

In special requirement scenarios, communication is required between hosts, but ARP packets sent by hosts are not desired to transmit across the whole network. In this case, you can run the arp-to-host command on the devices connected to hosts to convert ARP entries to host routes, so that the remote devices learn the host routes through BGP redistribution to meet the scenario requirement.

As shown in the following figure, PC1 and PC2 are two hosts in the same network segment. PC1 and PC2 are required to communicate with each other, but ARP packets are not desired to transmit across the whole network. Run the arp-to-host command on R1 and R2 to

generate ARP host routes, establish a BGP neighbor relationship between R1 and R2, and enable ARP host route redistribution. In this case, both R1 and R2 can obtain routes to PC1 and PC2 to implement network interconnection.

Figure 10-6

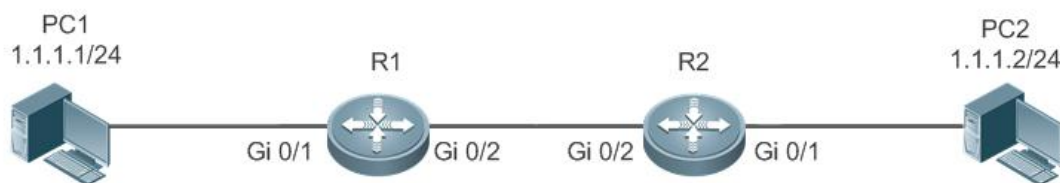

Deployment

- Configure IP addresses and masks for interfaces.
- Enable ARP-to-host conversion on interfaces of R1 and R2.
- Establish a BGP neighbor relationship between R1 and R2, and redistribute ARP host routes.

10.2.7nd-to-route Conversion

Scenario

In special requirement scenarios, interconnection is required among hosts, but ND packets sent by hosts are not desired to transmit across the whole network. In this case, you can run the `nd-to-route` command on the devices connected to hosts to convert ND entries to routes, so that the remote devices learn the nd-route route through BGP redistribution to meet the scenario requirement.

As shown in the following figure, PC1 and PC2 are two hosts in the same network segment. PC1 and PC2 are required to communicate with each other, but ND packets are not desired to transmit across the whole network. Run the `nd-to-route` command on R1 and R2 to generate nd-route routes, establish a BGP neighbor relationship between R1 and R2, and enable nd-route route redistribution. In this case, both R1 and R2 can obtain routes to PC1 and PC2 to implement network interconnection.

The hardware delivery performance of remote route is better than that of local device, so the time to release nd-route route should be controlled to avoid premature traffic diversion to the local device. By configuring the `nd-route delayed redistribution` function, you can configure the time to redistribute the nd-route route based on the actual scenario.

By default, the route converted by ND is a static route with a mask of 128 bits. If there are too many ND entries, a large number of nd-route routes are generated, which greatly increases the memory overhead and reduces the computational performance of the route, so you need to aggregate nd-route on the same network segment. You can convert nd-route routes to routes with fixed-length masks to aggregate nd-route routes on the same network segment.

Figure 100-7



Deployment

- Configure IP addresses and masks for interfaces.

- Enable nd-to-route conversion on interfaces of R1 and R2.
- Establish a BGP neighbor relationship between R1 and R2, and redistribute nd-route routes.

10.3 Features

Feature	Description
Route Computation	Generate a valid route on a device.
Optimal Route Selection	Select an optimal route to forward packets.
Default Route	Forward all packets and help reduce the size of a routing table.
Route Reliability	Quickly detect a route failure and recover communication.

10.3.1 Route Computation

Routing Function

Routing functions are classified into IPv4 and IPv6 routing functions. If the routing functions are disabled, a device is equivalent to a host and cannot forward routes.

Dynamic Route

A dynamic routing protocol learns remote routes and dynamically updates routes by exchanging routes with neighbors. If a neighbor is the next hop of a route and this neighbor fails, the route fails as well.

Static Route

On a network with a simple topology, you can configure only static routes to implement network interworking. Appropriate configuration and use of static routes can improve the network performance and guarantee the bandwidth for important network applications.

Whether a static route is active is computed based on the status of the local interface. When the exit interface of a static route is located at layer 3 (L3) and is in Up status (the link status is Up and the IP address is configured), this route is active and can be used for packet forwarding.

A static route can go across VPN routing & forwarding (VRF) instances. The next hop or exit interface of a static route of VRF 1 can be configured on VRF 2.

ARP-to-host Conversion

Enable ARP-to-host conversion on a specified interface. If the interface is a Layer-3 interface in up status, ARP entries will be converted into 32-bit host routes on the interface.

ND-to-route Conversion

Enable nd-to-route conversion on a specified interface. If the interface is a Layer-3 interface in up status, ND entries will be converted into routes with fixed-length masks on the interface. By configuring the delayed redistribution of nd-to-route, the nd-to-route is redistributed according to the configured time.

10.3.2 Optimal Route Selection

Administrative Distance

When multiple routing protocols generate routes to the same destination, the priorities of these routes can be determined based on the administrative distance. A smaller administrative distance indicates a higher priority.

Equal-Cost Route

If multiple routes to the same destination have different next hops but the same administrative distance, these routes are mutually equal-cost routes. Packets are distributed among these routes to implement load balancing based on the balanced forwarding policy.

On a specific device, the total number of equal-cost routes is limited. Routes beyond the limit do not participate in packet forwarding.

Floating Route

If multiple routes to the same destination have different next hops and different administrative distances, these routes are mutually floating routes. The route with the smallest administrative distance will be first selected for packet forwarding. If this route fails, a route with a larger administrative distance is further selected for forwarding, thus preventing communication interruption caused by a network line failure.

10.3.3 Default Route

In the forwarding routing table, the route with the destination network segment 0.0.0.0 and the subnet mask 0.0.0.0 is the default route. Packets that cannot be forwarded by other routes will be forwarded by the default route. The default route can be statically configured or generated by a dynamic routing protocol.

Static Default Route

On a L3 switch, a static route with the network segment 0.0.0.0 and the subnet mask 0.0.0.0 is configured to generate the default route.

Default Network

The default network is configured to generate a default route. If the **ip default-network** command is configured to specify a network (a classful network, such as a Class A, B, or C network), and this network exists in the routing table, the router will use this network as the default network and the next hop of this network is the default gateway. As the network specified by the **ip default-network** command is a classful one, if this command is used to identify a subnet in a classful network, the router automatically generates a static route of the classful network instead of any default route.

10.3.4 Route Reliability

When a device on a network is faulty, some routes become unreachable, resulting in traffic interruption. If connectivity of the next hop can be detected in real time, the route can be re-computed when a fault occurs, or traffic can be switched over to the standby route.

Correlation with Track

A track object is an abstract concept. It can be used to trace whether an IP address is reachable or whether an interface is up. If a dynamic routing protocol or a static route is correlated with the Track function, the dynamic routing protocol or the static route can quickly learn whether the next hop is reachable so as to respond quickly.

Correlation with BFD

The BFD protocol provides a light-load and fast method for detecting the connectivity of the forwarding path between two adjacent routers. If a dynamic routing protocol or a static route is correlated with the BFD function, the dynamic routing protocol or the static route can quickly learn whether the next hop is reachable so as to respond quickly.

The detection performance of BFD is better than that of Track.

Correlation with ARP

If a static route is correlated with the ARP function, when the ARP does not exist, the static route can quickly learn that the next hop is unreachable so as to respond quickly.

Fast Reroute

Fast reroute provides a standby route. When a dynamic routing protocol or a static route detects that the next hop is unreachable, it immediately switches traffic over to the standby route to recovery communication.



10.4 Limitations



Support 64 groups of ECMP, and each group supports a maximum of 32 entries. A group refers to multiple equivalent next hops of a prefix.

10.5 Configuration

Configuration Item	Description and Command	
Configuring a Static Route	(Mandatory) It is used to configure a static route entry.	
	ip route	Configures an IPv4 static route.
	ipv6 route	Configures an IPv6 static route.
Configuring a Default Route	(Optional) It is used to configure the default gateway.	
	ip route 0.0.0.0 0.0.0.0 gateway	Configures an IPv4 default gateway on a L3 device.
	ipv6 route ::/0 ipv6-gateway	Configures an IPv6 default gateway on a L3 device.
	ip default network	Configures an IPv4 default network on a L3 device.
Configuring Route Limitations	(Optional) It is used to limit the number of equal-cost routes and number of static routes, or disable routing.	
	maximum-paths	Configures the maximum number of equal-cost routes.
	ip static route-limit	Configures the maximum number of IPv4 static routes.
	ipv6 static route-limit	Configures the maximum number of IPv6 static routes.
	no ip routing	Disables IPv4 routing.
	no ipv6 unicast-routing	Disables IPv6 routing.

Configuration Item	Description and Command	
	no ip route static inter-vrf	Prohibits static routing across VRFs.
Correlating a Static Route with BFD	 (Optional) It is used to correlate a static route with BFD.	
	ip route static bfd	Correlates an IPv4 static route with BFD.
	ipv6 route static bfd	Correlates an IPv6 static route with BFD.
Configure Static Fast Reroute	 (Optional) It is used to configure static fast reroute.	
	route-map	Configures a route map.
	set fast-reroute backup-nexthop	Configures the standby interface and standby next hop for fast reroute.
	ip fast-reroute	Configures static fast reroute.
Configure ARP-to-host Conversion	ip route arp-to-host interface <i>interface-name</i>	Configures ARP-to-host conversion on a specified interface.
	ip route arp-to-host tag <i>tag-number</i>	Configures the tag of ARP-to-host
	ip route arp-to-host delay-time <i>time-number</i>	Configures the delayed redistribution of ARP-to-host route
	redistribute arp-host [route-map <i>map-tag</i>] [metric <i>metric-value</i>]	Configures BGP redistribution of ARP host route.
Configure nd-to-route Conversion	ipv6 route nd-to-route delay-time <i>time-number</i>	Configures the delayed redistribution of nd-to-route
	ipv6 route nd-to-route interface <i>interface-name</i> [ipv6-prefix <i>X:X:X::X/<0-128></i>] [prefix-len <i>masklen</i>]	Enables nd-to-route on a specific interface
	ipv6 route nd-to-route tag <i>tag-number</i>	Configures the tag of nd-to-route
	ipv6 route nd-to-route warning-ignore	Ignores the alarm log of nd-to-route conversion
	redistribute nd-route [route-map <i>map-tag</i>] [metric <i>metric-value</i>]	Configures BGP redistribution of nd-route route

10.5.1 Configuring a Static Route

Configuration Effect

- Generate a static route in the routing table. Use the static route to forward packets to a remote network.

Notes

- If the **no ip routing** command is configured on a L3 switch, you cannot configure IPv4 static routes on this switch, and existing IPv4 static routes will also be deleted. Before the device is restarted, reconfiguring the **ip routing** command can recover the deleted IPv4 static routes. After the device is restarted, deleted IPv4 static routes cannot be recovered.

- If the **no ipv6 unicast- routing** command is configured on a L3 switch, you cannot configure IPv6 static routes on this switch, and existing IPv6 static routes will also be deleted. Before the device is restarted, reconfiguring the **ipv6 unicast- routing** command can recover the deleted IPv6 static routes. After the device is restarted, deleted IPv6 static routes cannot be recovered.
- To correlate a static route with the Track function, you must run the **track** command to configure a track object.

Configuration Steps

➤ **Configuring a Static IPv4 Route**

Configure the following command on an IPv4-enabled router.

Command	ip route [vrf <i>vrf_name</i>] <i>network</i> net-mask { <i>ip-address</i> <i>interface</i> [<i>ip-address</i>]} [<i>distance</i>] [tag <i>tag</i>] [permanent track <i>object-number</i> arp] [weight <i>number</i>] [description <i>description-text</i>] [disabled enabled] [global]	
Parameter Description	vrf <i>vrf_name</i>	(Optional) Indicates the routing VRF, which can be a single-protocol IPv4 VRF or a multi-protocol VRF of a configured IPv4 address family. The VRF is a global VRF by default.
	<i>network</i>	Indicates the address of the destination network.
	<i>net-mask</i>	Indicates the mask of the destination network.
	<i>ip-address</i>	(Optional) Indicates the next-hop address of the static route. You must specify at least one of <i>ip-address</i> and <i>interface</i> , or both of them. If <i>ip-address</i> is not specified, a static direct route is configured.
	<i>interface</i>	(Optional) Indicates the next-hop exit interface of the static route. You must specify at least one of <i>ip-address</i> and <i>interface</i> , or both of them. If <i>interface</i> is not specified, a recursive static direct route is configured. The exit interface is obtained by the next hop in the routing table.
	<i>distance</i>	(Optional) Indicates the administrative distance of the static route. The administrative distance is 1 by default.
	<i>tag</i>	(Optional) Indicates the tag of the static route. The tag is 0 by default.
	permanent	(Optional) Indicates the flag of the permanent route. The static route is not a permanent route by default.
	track <i>object-number</i>	(Optional) Indicates correlation with Track. <i>object-number</i> indicates the ID of the track object. By default, the static route is not correlated with the Track function.
	weight <i>number</i>	(Optional) Indicates the weight of the static route. The weight is 1 by default.
	description <i>descripti on-text</i>	(Optional) Indicates the description of the static route. By default, no description is configured. <i>description-text</i> is a string of one to 60 characters.
	disabled/enabled	(Optional) Indicates the enable flag of the static route. The flag is enabled by default.
	global	(Optional) Indicates that the next hop belongs to a global VRF. By default, the VRF of the next hop is the same as the VRF specified by <i>vrf name</i> .
	arp	(Optional) Correlate the static route with ARP function. By default, it is not correlated.
Defaults	By default, no static route is configured.	
Command Mode	Global configuration mode	
Usage Guide	<p>The simplest configuration of this command is ip route <i>network</i>net-mask<i>ip-address</i>.</p> <p>If the static route is correlated with Track and the down status of the trace object is detected, the static route is not active and does not participate in packet forwarding.</p> <p>If the static route is correlated with ARP, but no ARP information is detected, the static route is not active and does not participate in packet forwarding.</p>	

➤ Configuring an IPv6 Static Route

Configure the following command on an IPv6-enabled router.

Command	ipv6 route [vrf vrf-name] ipv6-prefix/prefix-length { ipv6-address [nexthop-vrf {vrf-name1 default }] interface [ipv6-address [nexthop-vrf {vrf-name1 default }]] } [distance] [weight number] [description description-text]	
Parameter Description	vrf vrf-name	(Optional) Indicates the routing VRF, which must be a multi-protocol VRF of a configured IPv6 address family. The VRF is a global VRF by default.
	ipv6-prefix	Indicates the IPv6 prefix, which must comply with the address expression specified in RFC4291.
	prefix-length	Indicates the length of the IPv6 prefix. Note that a slash (/) must be added in front of the length.
	ipv6-address	(Optional) Indicates the next-hop address of the static route. You must specify at least one of ipv6-address and interface, or both of them. If ipv6-address is not specified, a static direct route is configured.
	interface	(Optional) Indicates the next-hop exit interface of the static route. You must specify at least one of ipv6-address and interface, or both of them. If interface is not specified, a recursive static direct route is configured. The exit interface is obtained by the next hop in the routing table.
	nexthop-vrf vrf-name1	(Optional) Indicates the routing VRF of the next hop, which must be a multi-protocol VRF of a configured IPv6 address family. By default, the VRF of the next hop is the same as the VRF specified by the VRF name. nexthop-vrf default indicates that the VRF of the next shop is a global VRF.
	distance	(Optional) Indicates the administrative distance of the static route. The administrative distance is 1 by default.
	weight number	(Optional) Indicates the weight of the static route, which must be specified when you configure equal-cost routes. The weight ranges from 1 to 8. When the weights of all equal-costroutes of a route are summed up, the sum cannot exceed the maximum number of equal-cost routes that can be configured for the route. Weighting of equal-cost routes of a route indicates the traffic ratio of these routes. The weight is 1 by default.
description descripti on-text	(Optional) Indicates the description of the static route. By default, no description is configured. description-text is a string of one to 60 characters.	
Defaults	By default, no static route is configured.	
Command Mode	Global configuration mode	
Usage Guide	The simplest configuration of this command is ipv6 route ipv6-prefix / prefix-lengthipv6-address.	

Verification

- Run the **show ip route** command to display the IPv4 routing table and check whether the configured IPv4 static route takes effect.
- Run the **show ipv6 route** command to display the IPv6 routing table and check whether the configured IPv6 static route takes effect.

Configuration Example

➤ Configuring Static Routes to Implement Interworking of the IPv4 Network

<p>Scenario Figure 10-7</p>	
<p>Configuration Steps</p>	<ul style="list-style-type: none"> ● Configure interface addresses on each device.
<p>R1</p>	<pre>R1#configure terminal R1(config)#interface gigabitEthernet 0/0 R1(config-if-GigabitEthernet 0/0)# ip address 1.1.1.1 255.255.255.0 R1(config-if-GigabitEthernet 0/0)# exit R1(config)#interface gigabitEthernet 0/2 R1(config-if-GigabitEthernet 0/2)# ip address 1.1.12.1 255.255.255.0 R1(config-if-GigabitEthernet 0/0)# exit R1(config)#interface gigabitEthernet 0/3 R1(config-if-GigabitEthernet 0/3)# ip address 1.1.13.1 255.255.255.0</pre>
<p>R2</p>	<pre>R2#configure terminal R2(config)#interface gigabitEthernet 0/0 R2(config-if-GigabitEthernet 0/0)# ip address 1.1.2.1 255.255.255.0 R2(config-if-GigabitEthernet 0/0)# exit R2(config)#interface gigabitEthernet 0/1 R2(config-if-GigabitEthernet 0/1)# ip address 1.1.12.2 255.255.255.0 R2(config-if-GigabitEthernet 0/0)# exit R2(config)#interface gigabitEthernet 0/3 R2(config-if-GigabitEthernet 0/3)# ip address 1.1.23.2 255.255.255.0</pre>
<p>R3</p>	<pre>R3#configure terminal R3(config)#interface gigabitEthernet 0/0 R3(config-if-GigabitEthernet 0/0)# ip address 1.1.3.1 255.255.255.0 R3(config-if-GigabitEthernet 0/0)# exit</pre>

	<pre>R3(config)#interface gigabitEthernet 0/1 R3(config-if-GigabitEthernet 0/1)# ip address 1.1.13.3 255.255.255.0 R3(config-if-GigabitEthernet 0/0)# exit R3(config)#interface gigabitEthernet 0/2 R3(config-if-GigabitEthernet 0/2)# ip address 1.1.23.3 255.255.255.0</pre>
	<ul style="list-style-type: none"> ● Configure static routes on each device.
R1	<pre>R1#configure terminal R1(config)#ip route 1.1.2.0 255.255.255.0 GigabitEthernet 0/2 1.1.12.2 R1(config)# ip route 1.1.3.0 255.255.255.0 GigabitEthernet 0/3 1.1.13.3</pre>
R2	<pre>R2#configure terminal R2(config)#ip route 1.1.1.0 255.255.255.0 GigabitEthernet 0/1 1.1.12.1 R2(config)# ip route 1.1.3.0 255.255.255.0 GigabitEthernet 0/3 1.1.23.3</pre>
R3	<pre>R3#configure terminal R3(config)#ip route 1.1.2.0 255.255.255.0 GigabitEthernet 0/2 1.1.23.2 R3(config)# ip route 1.1.1.0 255.255.255.0 GigabitEthernet 0/1 1.1.13.1</pre>
Verification	<ul style="list-style-type: none"> ● Display the routing table.
R1	<pre>R1# show ip route Codes: C - Connected, L - Local, S - Static R - RIP, O - OSPF, B - BGP, I - IS-IS N1 - OSPF NSSA external type 1, N2 - OSPF NSSA external type 2 E1 - OSPF external type 1, E2 - OSPF external type 2 SU - IS-IS summary, L1 - IS-IS level-1, L2 - IS-IS level-2 IA - Inter area, * - candidate default Gateway of last resort is no set C 1.1.1.0/24 is directly connected, GigabitEthernet 0/0 C 1.1.1.1/32 is local host. S 1.1.2.0/24 [1/0] via 1.1.12.2, GigabitEthernet 0/2 S 1.1.3.0/24 [1/0] via 1.1.13.3, GigabitEthernet 0/2 C 1.1.12.0/24 is directly connected, GigabitEthernet 0/2 C 1.1.12.1/32 is local host. C 1.1.13.0/24 is directly connected, GigabitEthernet 0/3</pre>

	<p>C 1.1.13.1/32 is local host.</p>
<p>R2</p>	<pre> R2# show ip route Codes: C - Connected, L - Local, S - Static R - RIP, O - OSPF, B - BGP, I - IS-IS N1 - OSPF NSSA external type 1, N2 - OSPF NSSA external type 2 E1 - OSPF external type 1, E2 - OSPF external type 2 SU - IS-IS summary, L1 - IS-IS level-1, L2 - IS-IS level-2 IA - Inter area, * - candidate default Gateway of last resort is no set S 1.1.1.0/24 [1/0] via 1.1.12.1, GigabitEthernet 0/0 C 1.1.2.0/24 is directly connected, GigabitEthernet 0/0 C 1.1.2.1/32 is local host. S 1.1.3.0/24 [1/0] via 1.1.23.3, GigabitEthernet 0/3 C 1.1.12.0/24 is directly connected, GigabitEthernet 0/1 C 1.1.12.2/32 is local host. C 1.1.23.0/24 is directly connected, GigabitEthernet 0/3 C 1.1.23.2/32 is local host. </pre>
<p>R3</p>	<pre> R3# show ip route Codes: C - Connected, L - Local, S - Static R - RIP, O - OSPF, B - BGP, I - IS-IS N1 - OSPF NSSA external type 1, N2 - OSPF NSSA external type 2 E1 - OSPF external type 1, E2 - OSPF external type 2 SU - IS-IS summary, L1 - IS-IS level-1, L2 - IS-IS level-2 IA - Inter area, * - candidate default Gateway of last resort is no set S 1.1.1.0/24 [1/0] via 1.1.13.1, GigabitEthernet 0/2 S 1.1.2.0/24 [1/0] via 1.1.23.2, GigabitEthernet 0/2 C 1.1.3.0/24 is directly connected, GigabitEthernet 0/0 C 1.1.3.1/32 is local host. C 1.1.13.0/24 is directly connected, GigabitEthernet 0/1 C 1.1.13.3/32 is local host. </pre>

- C 1.1.23.0/24 is directly connected, GigabitEthernet 0/2
- C 1.1.23.3/32 is local host.

📌 **Correlating IPv4 Static Routes with Track**

<p>Scenario Figure 10-8</p>	
<p>Configuration Steps</p>	<ul style="list-style-type: none"> ● Configure static routes on R 1 and R 2, and specify the exit interface or next hop as the interworking interface. ● Correlate static routes with Track on R 1 and R 2, and check the connectivity of the next hops of static routes. ●
<p>R1</p>	<pre>R1#configure terminal R1(config)#interface gigabitEthernet 0/1 R1(config-if-GigabitEthernet 0/1)# ip address 1.1.12.1 255.255.255.0 R1(config-if-GigabitEthernet 0/1)# exit R1(config)#track 2 interface gigabitEthernet 0/1 line-protocol R1(config)# ip route 1.1.2.0 255.0.0.0 gigabitEthernet 0/1 1.1.12.2 track 2</pre>
<p>R2</p>	<pre>R2#configure terminal R1(config)#interface gigabitEthernet 0/1 R1(config-if-GigabitEthernet 0/1)# ip address 1.1.12.2 255.255.255.0 R1(config-if-GigabitEthernet 0/1)# exit R1(config)#track 2 interface gigabitEthernet 0/1 line-protocol R1(config)# ip route 1.1.1.0 255.0.0.0 gigabitEthernet 0/1 1.1.12.1 track 2</pre>
<p>Verification</p>	<ul style="list-style-type: none"> ● Display the Track status. ● Display the static routes correlated with Track. <pre>R1# show track 2 Track 2 Interface gigabitEthernet 0/1 The state is Up, delayed Down (5 secs remaining) 1 change, current state last: 300 secs Delay up 0 secs, down 0 secs R1#show ip route track-table ip route 1.1.2.0 255.0.0.0 GigabitEthernet 0/1 1.1.12.2 track 2 up</pre>

📌 **Configuring Static Routes to Implement Interworking of the IPv6 Network**

<p>Scenario Figure 10-9</p>	
<p>Configuration Steps</p>	<ul style="list-style-type: none"> Configure interface addresses on each device.
<p>R1</p>	<pre>R1#configure terminal R1(config)#interface gigabitEthernet 0/0 R1(config-if-GigabitEthernet 0/0)# ipv6 address 1111:1111::1/64 R1(config-if-GigabitEthernet 0/0)# exit R1(config)#interface gigabitEthernet 0/1 R1(config-if-GigabitEthernet 0/1)# ipv6 address 1111:1212::1/64</pre>
<p>R2</p>	<pre>R2#configure terminal R2(config)#interface gigabitEthernet 0/0 R2(config-if-GigabitEthernet 0/0)#ipv6 address 1111:2323::1/64 R2(config-if-GigabitEthernet 0/0)# exit R2(config)#interface gigabitEthernet 0/1 R2(config-if-GigabitEthernet 0/1)# ipv6 address 1111:1212::2/64</pre>
	<ul style="list-style-type: none"> Configure static routes on each device.
<p>R1</p>	<pre>R1#configure terminal R1(config)# ipv6 route 1111:2323::0/64 gigabitEthernet 0/1</pre>
<p>R2</p>	<pre>R2#configure terminal R2(config)#ipv6 route 1111:1111::0/64 gigabitEthernet 0/1</pre>
<p>Verification</p>	<ul style="list-style-type: none"> Display the routing table.
<p>R1</p>	<pre>R1# show ipv6 route</pre> <p>IPv6 routing table name - Default - 10 entries</p> <p>Codes: C - Connected, L - Local, S - Static</p> <p>R - RIP, O - OSPF, B - BGP, I - IS-IS</p> <p>N1 - OSPF NSSA external type 1, N2 - OSPF NSSA external type 2</p> <p>E1 - OSPF external type 1, E2 - OSPF external type 2</p>

	<p>SU - IS-IS summary, L1 - IS-IS level-1, L2 - IS-IS level-2</p> <p>IA - Inter area</p> <p>C 1111:1111::/64 via GigabitEthernet 0/0, directly connected</p> <p>L 1111:1111::1/128 via GigabitEthernet 0/0, local host</p> <p>C 1111:1212::/64 via GigabitEthernet 0/1, directly connected</p> <p>L 1111:1212::1/128 via GigabitEthernet 0/1, local host</p> <p>S 1111:2323::/64 [1/0] via GigabitEthernet 0/1, directly connected</p> <p>C FE80::/10 via ::1, Null0</p> <p>C FE80::/64 via GigabitEthernet 0/0, directly connected</p> <p>L FE80::2D0:F8FF:FEFB:C092/128 via GigabitEthernet 0/0, local host</p> <p>C FE80::/64 via GigabitEthernet 0/1, directly connected</p> <p>L FE80::2D0:F8FF:FEFB:C092/128 via GigabitEthernet 0/1, local host</p>
<p>R2</p>	<p>R2# show ipv6 route</p> <p>IPv6 routing table name - Default - 10 entries</p> <p>Codes: C - Connected, L - Local, S - Static</p> <p>R - RIP, O - OSPF, B - BGP, I - IS-IS</p> <p>N1 - OSPF NSSA external type 1, N2 - OSPF NSSA external type 2</p> <p>E1 - OSPF external type 1, E2 - OSPF external type 2</p> <p>SU - IS-IS summary, L1 - IS-IS level-1, L2 - IS-IS level-2</p> <p>IA - Inter area</p> <p>C 1111:2323::/64 via GigabitEthernet 0/0, directly connected</p> <p>L 1111:2323::1/128 via GigabitEthernet 0/0, local host</p> <p>C 1111:1212::/64 via GigabitEthernet 0/1, directly connected</p> <p>L 1111:1212::1/128 via GigabitEthernet 0/1, local host</p> <p>S 1111:1111::/64 [1/0] via GigabitEthernet 0/1, directly connected</p> <p>C FE80::/10 via ::1, Null0</p> <p>C FE80::/64 via GigabitEthernet 0/0, directly connected</p> <p>L FE80::2D0:F8FF:FEFB:C092/128 via GigabitEthernet 0/0, local host</p> <p>C FE80::/64 via GigabitEthernet 0/1, directly connected</p> <p>L FE80::2D0:F8FF:FEFB:C092/128 via GigabitEthernet 0/1, local host</p>

Common Errors

- The link on the interface is not up.
- No IP address is configured for the interface.
- The static route is correlated with Track, but the track object is not configured.

10.5.2 Configuring a Default Route

Configuration Effect

- Generate a default route in the routing table. The default route is used to forward packets that cannot be forwarded by other routes.

Notes

- On a L3 switch, run the **ip route** 0.0.0.0 0.0.0.0 *gateway* or **ipv6 route** ::/0 *ipv6-gateway* command to configure the default gateway.
- If the **no ip routing** or **no ipv6 unicast-routing** command is configured on a L3 switch, you can run the **ip default gateway** or **ipv6 default gateway** command to configure the default gateway.

Configuration Steps

↘ Configuring the IPv4 Gateway on a L2 Switch

Command	ip default-gateway <i>gateway</i>	
Parameter	<i>gateway</i>	indicates the IPv4 gateway address.
Description		
Defaults	By default, no static default route is configured.	
Command Mode	Global configuration mode	
Usage Guide	N/A	

↘ Configuring the IPv6 Gateway on a L2 Switch

Command	ipv6 default-gateway <i>gateway</i>	
Parameter	<i>gateway</i>	indicates the IPv6 gateway address.
Description		
Defaults	By default, no static default route is configured.	
Command Mode	Global configuration mode	
Usage Guide	N/A	

↘ Configuring the IPv4 Default Gateway on a L3 Switch

Command	ip route [vrf <i>vrf_name</i>] 0.0.0.00.0.0.0 { <i>ip-address</i> <i>interface</i> [<i>ip-address</i>]} [<i>distance</i>] [tag <i>tag</i>] [permanent] [weight <i>number</i>] [description <i>description-text</i>] [disabled enabled] [global]	
Parameter Description	vrf <i>vrf_name</i>	(Optional) Indicates the routing VRF, which can be a single-protocol IPv4 VRF or a multi-protocol VRF of a configured IPv4 address family. The VRF is a global VRF by default.
	0.0.0.0	Indicates the address of the destination network.
	0.0.0.0	Indicates the mask of the destination network.

	<i>ip-address</i>	(Optional) Indicates the next-hop address of the static route. You must specify at least one of <i>ip-address</i> and <i>interface</i> , or both of them. If <i>ip-address</i> is not specified, a static direct route is configured.
	<i>interface</i>	(Optional) Indicates the next-hop exit interface of the static route. You must specify at least one of <i>ip-address</i> and <i>interface</i> , or both of them. If <i>interface</i> is not specified, a recursive static direct route is configured. The exit interface is obtained by the next hop in the routing table.
	<i>distance</i>	(Optional) Indicates the administrative distance of the static route. The administrative distance is 1 by default.
	<i>tag</i>	(Optional) Indicates the tag of the static route. The tag is 0 by default.
	permanent	(Optional) Indicates the flag of the permanent route. The static route is not a permanent route by default.
	weight number	(Optional) Indicates the weight of the static route. The weight is 1 by default.
	description <i>description-text</i>	(Optional) Indicates the description of the static route. By default, no description is configured. <i>description-text</i> is a string of one to 60 characters.
	disabled /enabled	(Optional) Indicates the enable flag of the static route. The flag is enabled by default.
	global	(Optional) Indicates that the next hop belongs to a global VRF. By default, the VRF of the next hop is the same as the VRF specified by <i>vrf name</i> .
Defaults	By default, no static default route is configured.	
Command Mode	Global configuration mode	
Usage Guide	The simplest configuration of this command is ip route0.0.0.0 0.0.0.0 ip-address .	

📌 **Configuring the IPv6 Default Gateway on a L3 Switch**

Command	ipv6 route [vrfvrf-name] ::0 { ipv6-address [nexthop-vrf {vrf-name1 default}] interface [ipv6-address [nexthop-vrf {vrf-name1 default}]] } [distance] [weightnumber] [descriptiondescription-text]	
Parameter Description	vrfvrf-name	(Optional) Indicates the routing VRF, which must be a multi-protocol VRF of a configured IPv6 address family. The VRF is a global VRF by default.
	::	Indicates the IPv6 prefix, which must comply with the address expression specified in RFC4291.
	0	Indicates the length of the IPv6 prefix. Note that a slash (/) must be added in front of the length.
	<i>ipv6-address</i>	(Optional) Indicates the next-hop address of the static route. You must specify at least one of <i>ipv6-address</i> and <i>interface</i> , or both of them. If <i>ipv6-address</i> is not specified, a static direct route is configured.
	<i>interface</i>	(Optional) Indicates the next-hop exit interface of the static route. You must specify at least one of <i>ipv6-address</i> and <i>interface</i> , or both of them. If <i>interface</i> is not specified, a recursive static direct route is configured. The exit interface is obtained by the next hop in the routing table.
	nexthop-vrf vrf-name1	(Optional) Indicates the routing VRF of the next hop, which must be a multi-protocol VRF of a configured IPv6 address family. By default, the VRF of the next hop is the same as the VRF specified by <i>vrf name</i> . nexthop-vrf default indicates that the VRF of the next shop is a global VRF.
	<i>distance</i>	(Optional) Indicates the administrative distance of the static route. The administrative distance is 1 by default.
	weight number	(Optional) Indicates the weight of the static route, which must be specified when you configure equal-cost routes. The weight ranges from 1 to 8. When the weights of all equal-cost routes of a route are summed up, the sum cannot exceed the maximum number of equal-cost routes that

		can be configured for the route. Weighting of equal-cost routes of a route indicates the traffic ratio of these routes. The weight is 1 by default.
	description <i>description</i> -text	(Optional) Indicates the description of the static route. By default, no description is configured. <i>description-text</i> is a string of one to 60 characters.
Defaults	By default, no static default route is configured.	
Command Mode	Global configuration mode	
Usage Guide	The simplest configuration of this command is ipv6 route ::/0 ipv6-gateway .	

➤ **Configuring the IPv4 Default Network on a L3 Switch**

Command	ip default-network <i>network</i>	
Parameter Description	<i>network</i>	Indicates the address of the network. (The network must be a Class A, B, or C network.)
Defaults	By default, no default network is configured.	
Command Mode	Global configuration mode	
Usage Guide	If the network specified by the ip default-network command exists, a default route is generated and the next hop to this network is the default gateway. If the network specified by the ip default-network command does not exist, the default route is not generated.	

Verification

- On a L2 switch (or a L3 switch where routing is disabled), run the **show ip redirects** or **show ipv6 redirects** command to display the default gateway.
- On a L3 switch where routing is enabled, run the **show ip route** or **show ipv6 route** command to display the default route.

Configuration Example

➤ **Configuring IPv4 Default Routes on L3 Switches to Implement Network Interworking**

Scenario Figure 10- 10	
Configuration Steps	<ul style="list-style-type: none"> ● Configure IP addresses on L3 devices.
R1	<pre> R1#configure terminal R1(config)#interface gigabitEthernet 0/0 R1(config-if-GigabitEthernet 0/0)# ip address 1.1.1.1 255.255.255.0 R1(config-if-GigabitEthernet 0/0)# exit R1(config)#interface gigabitEthernet 0/1 </pre>

	<pre>R1(config-if-GigabitEthernet 0/1)# ip address 1.1.12.1 255.255.255.0 R1(config-if-GigabitEthernet 0/0)# exit</pre>
R2	<pre>R2#configure terminal R2(config)#interface gigabitEthernet 0/0 R2(config-if-GigabitEthernet 0/0)# ip address 1.1.2.1 255.255.255.0 R2(config-if-GigabitEthernet 0/0)# exit R2(config)#interface gigabitEthernet 0/1 R2(config-if-GigabitEthernet 0/1)# ip address 1.1.12.2 255.255.255.0 R2(config-if-GigabitEthernet 0/0)# exit</pre>
R1	<ul style="list-style-type: none"> ● Configure an IPv6 default gateway on R 1. <pre>R1#configure terminal R1(config)#ip route 0.0.0.0 0.0.0.0 GigabitEthernet 0/1 1.1.12.2</pre>
R2	<pre>R2#configure terminal R2(config)#ip route 0.0.0.0 0.0.0.0 GigabitEthernet 0/1 1.1.12.1</pre>
Verification	<ul style="list-style-type: none"> ● Display the routing table.
R1	<pre>R1# show ip route Codes: C - Connected, L - Local, S - Static R - RIP, O - OSPF, B - BGP, I - IS-IS N1 - OSPF NSSA external type 1, N2 - OSPF NSSA external type 2 E1 - OSPF external type 1, E2 - OSPF external type 2 SU - IS-IS summary, L1 - IS-IS level-1, L2 - IS-IS level-2 IA - Inter area, * - candidate default Gateway of last resort is 1.1.12.2 S* 0.0.0.0/0 [1/0] via 1.1.12.2, GigabitEthernet 0/1 C 1.1.1.0/24 is directly connected, GigabitEthernet 0/0 C 1.1.1.1/32 is local host. C 1.1.12.0/24 is directly connected, GigabitEthernet 0/1 C 1.1.12.1/32 is local host.</pre>

10.5.3Configuring Route Limitations

Configuration Effect

- Limit the number of equal-cost routes and number of static routes, or disable routing.

Notes

Route limitations cannot be configured on a L2 switch.

Configuration Steps

↘ Configuring the Maximum Number of Equal-Cost Routes

Command	maximum-paths <i>number</i>	
Parameter Description	<i>number</i>	Indicates the maximum number of equal-cost routes. The value ranges from 1 to 64.
Defaults	The default value varies from products.	
Command Mode	Global configuration mode	
Usage Guide	Run this command to configure the maximum number of next hops in the equal-cost route. In load balancing mode, the number of routes on which traffic is balanced does not exceed the configured number of equal-cost routes.	

↘ Configuring the Maximum Number of IPv4 Static Routes

Command	ip static route-limit <i>number</i>	
Parameter Description	<i>number</i>	Indicates the upper limit of routes. The value ranges from 1 to 10,000.
Defaults	By default, a maximum of 1,024 IP static routes can be configured.	
Command Mode	Global configuration mode	
Usage Guide	Run this command to configure the maximum number of IPv4 static routes. If the maximum number of IPv4 static routes is reached, no more IPv4 static route can be configured.	

↘ Configuring the Maximum Number of IPv6 Static Routes

Command	ipv6 static route-limit <i>number</i>	
Parameter Description	<i>number</i>	Indicates the upper limit of routes. The value ranges from 1 to 10,000.
Defaults	By default, a maximum of 1,000 IPv6 static routes can be configured.	
Command Mode	Global configuration mode	
Usage Guide	Run this command to configure the maximum number of IPv6 static routes. If the maximum number of IPv6 static routes is reached, no more IPv6 static route can be configured.	

↘ Disabling IPv4 Routing

Command	no ip routing	
Parameter Description	N/A	
Defaults	By default, IPv4 routing is enabled.	
Command Mode	Global configuration mode	

Usage Guide	Run this command to disable IPv4 routing. If the device functions only as a bridge or a voice over IP (VoIP) gateway, the device does not need to use the IPv4 routing function of the FSOS software. In this case, you can disable the IPv4 routing function of the FSOS software.
--------------------	---

📌 **Disabling IPv6 Routing**

Command	no ipv6 unicast-routing
Parameter	N/A
Description	
Defaults	By default, IPv6 routing is enabled.
Command Mode	Global configuration mode
Usage Guide	Run this command to disable IPv6 routing. If the device functions only as a bridge or a VoIP gateway, the device does not need to use the IPv6 routing function of the FSOS software. In this case, you can disable the IPv6 routing function of the FSOS software.

📌 **Prohibiting Static Routing Across VRFs**

Command	no ip route static inter-vrf
Parameter	N/A
Description	
Defaults	By default, static IP or IPv6 routing across VRFs is allowed.
Command Mode	Global configuration mode
Usage Guide	Run this command to prohibit static IP routing across VRFs. After this command is configured, the static IP route across VRFs is not active and cannot be participate in packet forwarding.

Verification

Run the **show run** command to display the configuration file and verify that the preceding configuration commands exist.

Configuration Example

📌 **Configuring at Most Two Static Routing Limitations**

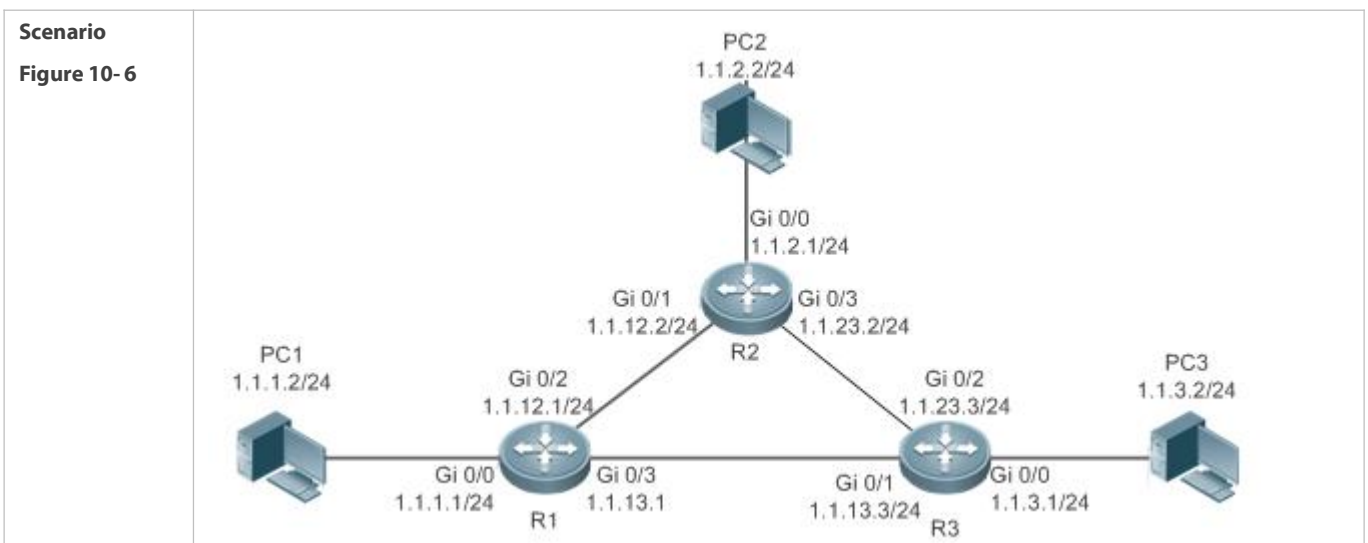

<p>Configuration Steps</p>	<p>On R 1, configure the IP addresses, static routes, and maximum number of static routes.</p>
	<pre> R1#configure terminal R1(config)#interface gigabitEthernet 0/0 R1(config-if-GigabitEthernet 0/0)# ip address 1.1.1.1 255.255.255.0 R1(config-if-GigabitEthernet 0/0)# exit R1(config)#interface gigabitEthernet 0/2 R1(config-if-GigabitEthernet 0/2)# ip address 1.1.12.1 255.255.255.0 R1(config-if-GigabitEthernet 0/0)# exit R1(config)#interface gigabitEthernet 0/3 R1(config-if-GigabitEthernet 0/3)# ip address 1.1.13.1 255.255.255.0 R1(config-if-GigabitEthernet 0/3)# exit R1(config)#ip route 1.1.3.0 255.255.255.0 1.1.13.3 R1(config)#ip route 1.1.4.0 255.255.255.0 1.1.12.2 R1(config)#ip route 1.1.5.0 255.255.255.0 1.1.12.2 R1(config)#ip static route-limit 2 % Exceeding maximum static routes limit. </pre>
<p>Verification</p>	<ul style="list-style-type: none"> ● Check the static routes that really take effect in the routing table.
	<pre> R1(config)# show ip route Codes: C - Connected, L - Local, S - Static R - RIP, O - OSPF, B - BGP, I - IS-IS N1 - OSPF NSSA external type 1, N2 - OSPF NSSA external type 2 E1 - OSPF external type 1, E2 - OSPF external type 2 SU - IS-IS summary, L1 - IS-IS level-1, L2 - IS-IS level-2 IA - Inter area, * - candidate default Gateway of last resort is no set C 1.1.1.0/24 is directly connected, GigabitEthernet 0/0 C 1.1.1.1/32 is local host. S 1.1.3.0/24 [1/0] via 1.1.13.3 S 1.1.4.0/24 [1/0] via 1.1.12.2 </pre>

C	1.1.12.0/24 is directly connected, GigabitEthernet 0/2
C	1.1.12.1/32 is local host.
C	1.1.13.0/24 is directly connected, GigabitEthernet 0/3
C	1.1.13.1/32 is local host.

10.5.4 Correlating a Static Route with BFD

Configuration Effect

- A static route can quickly detect a route failure with the help of BFD.

Notes

- BFD correlation cannot be configured on a L2 switch.
- You must configure a static route.
- You must configure the BFD session parameters by running the **bfd interval x min_rx x multiplier x** command.

Configuration Steps

↘ Correlating an IPv4 Static Route with BFD

Command	ip route static bfd [vrf vrf-name] <i>interface-type interface-number gateway</i> [source ip-address]	
Parameter Description	vrf vrf-name	(Optional) Indicates the name of the VRF to which the static route belongs. The VRF is a global VRF by default.
	<i>interface-type</i>	Indicates the interface type.
	<i>interface-number</i>	Indicates the interface number.
	<i>gateway</i>	Indicates the IP address of the gateway, that is, the neighbor IP address of BFD. If the next hop of the static route is this neighbor, BFD is used to check the connectivity of the forwarding path.
	source ip-address	(Optional) Indicates the source IP address used for the BFD session. This parameter must be configured if the neighbor IP address involves multiple hops. By default, the source IP address is not specified.
Defaults	By default, a static route is not correlated with BFD.	
Command Mode	Global configuration mode	
Usage Guide	Run this command to correlate an IPv4 static route with BFD. If the down status of the BFD session is detected, the IPv4 static route is not active and does not participate in packet forwarding.	

↘ Correlating an IPv6 Static Route with BFD

Command	ipv6 route static bfd [vrf vrf-name] <i>interface-type interface-number gateway</i> [source ipv6-address]	
Parameter Description	vrf vrf-name	(Optional) Indicates the name of the VRF to which the static route belongs. The VRF is a global VRF by default.
	<i>interface-type</i>	Indicates the interface type.
	<i>interface-number</i>	Indicates the interface number.
	<i>gateway</i>	Indicates the IP address of the gateway, that is, the neighbor IP address of BFD. If the next hop of the static route is this neighbor, BFD is used to check the connectivity of the forwarding path.

	sourceip-address	(Optional) Indicates the source IP address used for the BFD session. This parameter must be configured if the neighbor IP address involves multiple hops. By default, the neighbor IP address of the BFD session is a single hop, and the source IP address is not used.
Defaults	By default, a static route is not correlated with BFD.	
Command	Global configuration mode	
Mode		
Usage Guide	Run this command to correlate an IPv6 static route with BFD. If the down status of the BFD session is detected, the IPv6 static route is not active and does not participate in packet forwarding.	

Verification

- Run the **show bfd neighbors** command to display information about BFD neighbors.
- Run the **show ip route static bfd** or **show ipv6 route static bfd** command to display information about correlation of static routes with BFD.

Configuration Example

📌 **Correlating an IPv4 Static Route with BFD**

<p>Scenario Figure 10- 7</p>	
<p>Configuration Steps</p>	<ul style="list-style-type: none"> ● Configure a BFD session on the interconnect interface between R 1 and R 2. ● Configure static routes on R 1 and R 2, and specify the exit interface or next hop as the interworking interface. ● Correlate static routes with BFD on R 1 and R 2, and check the connectivity of the next hops of static routes.
<p>R1</p>	<pre>R1#configure terminal R1(config)#interface gigabitEthernet 0/1 R1(config-if-GigabitEthernet 0/1)# no switchport R1(config-if-GigabitEthernet 0/1)# ip address 1.1.12.1 255.255.255.0 R1(config-if-GigabitEthernet 0/1)#bfd interval 50 min_rx 50 multiplier 3 R1(config-if-GigabitEthernet 0/1)# exit R1(config)# ip route 1.1.2.0 255.0.0.0 FastEthernet 0/1 1.1.12.2 R1(config)#ip route static bfd gigabitEthernet 0/1 1.1.12.2</pre>
<p>R2</p>	<pre>R2#configure terminal R1(config)#interface gigabitEthernet 0/1 R1(config-if-GigabitEthernet 0/1)# no switchport R1(config-if-GigabitEthernet 0/1)# ip address 1.1.12.2 255.255.255.0 R1(config-if-GigabitEthernet 0/1)#bfd interval 50 min_rx 50 multiplier 3</pre>

	<pre>R1(config-if-GigabitEthernet 0/1)# exit R1(config)# ip route 1.1.1.0 255.0.0.0 FastEthernet 0/1 1.1.12.1 R1(config)#ip route static bfd gigabitEthernet 0/1 1.1.12.1</pre>
Verification	<ul style="list-style-type: none"> ● Display the status of BFD neighbors. ● Display the static routes correlated with BFD.
R1	<pre>R1#show bfd neighbors OurAddr NeighAddr LD/RD RH/RS Holdown(mult) State Int 1.1.12.1 1.1.12.2 8192/0 Up 0(3) Up GigabitEthernet 0/1 R1#show ip route static bfd S 1.1.2.0/24 via 1.1.12.2, GigabitEthernet 0/1, BFD state is Up</pre>

Common Errors

- The link on the interface is not up.
- No IP address is configured for the interface.
- No BFD session parameters are configured.
- No static route is configured.

10.5.5 Configure Static Fast Reroute

Configuration Effect

- Configure and enable static fast reroute.

Notes

- Static fast reroute cannot be configured on a L2 switch.
- You must configure a static route.
- You must configure a route map.

Configuration Steps

Defining a Standby Route in the Route Map

Command	set fast-reroute backup-nexthop <i>interface ip-address</i>	
Parameter	<i>interface</i>	Indicates the standby exit interface.
Description	<i>ip-address</i>	Indicates the standby next hop.
Defaults	N/A	
Command Mode	Global configuration mode	
Usage Guide	Run the route-map <i>name</i> [permit deny] <i>sequence</i> command to create a road map.	

	<p>Run the match command to define matching conditions.</p> <p>Run the set fast-reroute backup-nexthop interface ip-address command to define the standby exit interface and standby next hop.</p> <p>If a route meets matching conditions, a standby route is generated for this route. If the match command is not configured, standby routes are generated for any static route with the exit interface and next hop.</p>
--	---

➤ **Enabling Fast Reroute and Referencing the Route Map**

Command	ip fast-reroute [vrf vrf-name] static route-map route-map-name	
Parameter	<i>vrf-name</i>	(Optional) Specifies a VRF. If the VRF is not specified, the command is executed on all VRFs.
Description	<i>route-map-name</i>	Indicates the name of the road map for the standby route.
Defaults	By default, static fast reroute is not configured.	
Command Mode	Global configuration mode	
Usage Guide	Run this command to enable fast reroute and reference the route map.	

Verification

Run the **show ip route fast-reroute** command to display the active and standby routes that take effect.

Configuration Example

➤ **Configuring Fast Re-Routing**

<p>Scenario Figure 10- 8</p>	
<p>Configuration Steps</p>	<p>On R 1, configure a static route to the network segment of PC 3, and the next hop of the exit interface is R 3.</p> <p>On R 1, configure static fast reroute. The next hop of the exit interface of the standby route is R2.</p> <pre style="background-color: #f0f0f0; padding: 5px;"> R1#configure terminal R1(config)#interface gigabitEthernet 0/0 R1(config-if-GigabitEthernet 0/0)# ip address 1.1.1.1 255.255.255.0 R1(config-if-GigabitEthernet 0/0)# exit </pre>

	<pre> R1(config)#interface gigabitEthernet 0/2 R1(config-if-GigabitEthernet 0/2)# ip address 1.1.12.1 255.255.255.0 R1(config-if-GigabitEthernet 0/0)# exit R1(config)#interface gigabitEthernet 0/3 R1(config-if-GigabitEthernet 0/3)# ip address 1.1.13.1 255.255.255.0 R1(config-if-GigabitEthernet 0/3)# exit R1(config)# ip route 1.1.3.0 255.255.255.0 GigabitEthernet 0/3 1.1.13.3 R1(config)#route-map fast-reroute R1(config-route-map)# set fast-reroute backup-interface GigabitEthernet 0/2 backup-nexthop 1.1.12.2 R1(config-route-map)# exit R1(config)#ip fast-reroute static route-map fast-reroute </pre>
<p>Verification</p>	<p>Display the active and standby routes on R 1.</p> <pre> R1#show ip route fast-reroute Codes: C - connected, S - static, R - RIP, B - BGP O - OSPF, IA - OSPF inter area N1 - OSPF NSSA external type 1, N2 - OSPF NSSA external type 2 E1 - OSPF external type 1, E2 - OSPF external type 2 i - IS-IS, su - IS-IS summary, L1 - IS-IS level-1, L2 - IS-IS level-2 ia - IS-IS inter area, * - candidate default Status codes: m - main entry, b - backup entry, a - active entry Gateway of last resort is no set S 1.1.3.0 /24 [ma] via 1.1.13.3, GigabitEthernet 0/3 [b] via 1.1.12.2, GigabitEthernet 0/2 </pre>

Common Errors

- The link on the interface is not up.
- No static route is configured.
- The matching conditions are not configured or are not properly configured in the road map.

10.5.6Configuring ARP-to-host Conversion

Configuration Effect

- Enable ARP-to-host conversion on a specified interface.

Notes

- This configuration cannot be performed on a Layer-2 switch.
- The interface must be a Layer-3 interface in up status.

Configuration Steps

↘ **Enabling ARP-to-host Conversion on a Specified Interface**

Command	ip route arp-to-host interface <i>interface-name</i>
Parameter	<i>interface-name</i> : Indicates an interface name.
Description	
Defaults	N/A
Command Mode	Global configuration mode
Usage Guide	This command is used to convert ARP entries into 32-bit host routes on a specified interface.

↘ **Enabling ARP Proxy**

Command	local-proxy-arp
Parameter	N/A
Description	
Defaults	N/A
Command Mode	Interface configuration mode
Usage Guide	After receiving an ARP request, the device uses a proxy to send an ARP response with its own Ethernet MAC address. In this case, hosts communicate with each other through Layer-3 routes.

↘ **Configuring BGP Redistribution of ARP Host Routes**

Command	redistribute arp-host [route-map <i>map-tag</i>] [metric <i>metric-value</i>]
Parameter	route-map <i>map-tag</i> : Indicates the name of an associated route map. No route map is associated by default.
Description	metric <i>metric-value</i> : Indicates the default metric value for redistributing routes, in the range from 0 to 4,294,967,295 . The value is not set by default.
Defaults	N/A
Command Mode	BGP configuration mode
Usage Guide	This command is used to configure BGP redistribution of ARP host routes.

Verification

Run the **show ip route arphost** command to display the generated host routes.

Configuration

Example

↘ **Configuring ARP-to-host Conversion**

Scenario Figure 10-9	
Configuration Steps	Configure interface addresses on R1 and R2. Enable ARP-to-host conversion on specified interfaces of R1 and R2, configure a BGP neighbor relationship, and redistribute ARP host routes.
R1	<pre> R1#configure terminal R1(config)#interface vlan 40 R1(config-if-VLAN 40)#ip address 1.1.1.3 24 R1(config-if-VLAN 40)#local-proxy-arp R1(config-if-VLAN 40)#exit R1(config)#interface gigabitEthernet 0/1 R1(config-if-GigabitEthernet 0/1)#switchport R1(config-if-GigabitEthernet 0/1)#switchport mode trunk R1(config-if-GigabitEthernet 0/1)#switchport trunk allowed vlan only 40 R1(config-if-GigabitEthernet 0/1)#exit R1(config)#interface gigabitEthernet 0/2 R1(config-if-GigabitEthernet 0/2)# ip address 10.10.10.1 255.255.255.0 R1(config-if-GigabitEthernet 0/2)# exit R1(config)#router bgp 1 R1(config-router)#neighbor 10.10.10.2 remote-as 1 R1(config-router)#redistribute arp-host R1(config-router)#address-family ipv4 R1(onfig-router-af)#neighbor 10.10.10.2 next-hop-self R1(onfig-router-af)#exit R1(config-router)#exit R1(config)#ip route arp-to-host vlan 40 R1(config)#ip route arp-to-host delay-time 1 </pre>
R2	<pre> R2#configure terminal R2(config)#interface vlan 40 R2(config-if-VLAN 40)#ip address 1.1.1.4 24 R2(config-if-VLAN 40)#local-proxy-arp R2(config-if-VLAN 40)#exit R2(config)#interface gigabitEthernet 0/1 R2(config-if-GigabitEthernet 0/1)# switchport R2(config-if-GigabitEthernet 0/1)#switchport mode trunk R2(config-if-GigabitEthernet 0/1)# switchport trunk allowed vlan only 40 R2(config-if-GigabitEthernet 0/1)#exit R2(config)#interface gigabitEthernet 0/2 R2(config-if-GigabitEthernet 0/2)# ip address 10.10.10.2 255.255.255.0 </pre>

	<pre>R2(config-if-GigabitEthernet 0/2)# exit R2(config)#router bgp 1 R2(config-router)#neighbor 10.10.10.1 remote-as 1 R2(config-router)#redistribute arp-host R2(config-router)#address-family ipv4 R2(onfig-router-af)#neighbor 10.10.10.1 next-hop-self R2(onfig-router-af)#exit R2(config-router)#exit R2(config)#ip route arp-to-host vlan 40 R2(config)#ip route arp-to-host delay-time 1</pre>
<p>Verification</p>	<p>Display the ARP host routes of R1 to check that PC1 can ping PC2.</p> <pre>R1(config)#show ip route arphost A 1.1.1.1/32 [1/0] via 1.1.1.1, gigabitEthernet 0/1 R1#show ip route Codes: C - Connected, L - Local, S - Static R - RIP, O - OSPF, B - BGP, I - IS-IS, V - Overflow route N1 - OSPF NSSA external type 1, N2 - OSPF NSSA external type 2 E1 - OSPF external type 1, E2 - OSPF external type 2 SU - IS-IS summary, L1 - IS-IS level-1, L2 - IS-IS level-2 IA - Inter area, EV - BGP EVPN, A - Arp to host * - candidate default Gateway of last resort is 0.0.0.0 to network 0.0.0.0 S* 0.0.0.0/0 is directly connected, Null 0 C 10.10.10.0/24 is directly connected, GigabitEthernet 0/2 C 10.10.10.1/32 is local host. C 1.1.1.0/24 is directly connected, VLAN 40 A 1.1.1.1/32 [1/0] via 1.1.1.1, VLAN 40 C 1.1.1.3/32 is local host. B 1.1.1.2/32 [200/0] via 10.10.10.2, 00:57:12</pre>

Common Errors

- The ARP proxy function is not enabled on specified interfaces.

10.5.7Configuring nd-to-route Conversion

Configuration Effect

- Enable nd-to-route on a specified interface

Notes

- This configuration cannot be performed on a Layer-2 switch.
- The interface must be a Layer-3 interface in up status.

Configuration Steps

▾ Enabling nd-to-route on a Specified Interface

Command `ipv6 route nd-to-route interface interface-name [ipv6-prefix X:X:X::X/<0-128>] [prefix-len masklen]`

Parameter *interface-name*: the interface name.

Description *X:X:X::X/<0-128>*: IPv6 network segment. If the nd entries match this network segment, the route is converted according to the mask specified by this network segment. If the network segment does not specify a mask, the default mask is 128.

masklen: the mask length of the nd-to-route. The range is 0 to 128, and the default value is 128. If an IPv6 network segment is specified, it is longer than the mask length of configured network segment. If no IPv6 network segment is specified, it is longer than the mask length of IPv6 address on the interface. Otherwise, the configuration fails.

Defaults N/A

Command Mode Global configuration mode

Usage Guide If the IPv6 network segment and prefix-len are not specified, the ND learned on the default interface generates a 128-bit route. If no IPv6 network segment is specified but prefix-len is specified, ND on the interface generate the specified prefix-len. If IPv6 network segment is specified but prefix-len is not specified, the network segment generates a 128-bit route by default. If the network segment and the prefix-len are specified, the network segment is verified to match with the prefix when the ND is learned, and then the prefix-len is generated. If the network segment and prefix-len are specified, and the prefix-len of an unspecified network segment is configured, the specified interface generates the route according to its prefix-len, while the unspecified interface generates the route according to the unspecified prefix-len.

If you configure the IPv6 address of an interface before configuring the prefix-len of the interface address to generate a route with fixed-length mask, a configuration error occurs when the prefix-len is shorter than or equal to the mask of the IPv6 address. The prefix-len command fails. For example, first configure IPv6 address 10::1/64 on the interface of vlan 40, and then configure `ipv6 route nd-to-route interface vlan 40 ipv6-prefix 10::1/58 prefix-len 60` in the global configuration mode, the configuration fails.

If you configure the IPv6 address of an interface before configuring the prefix-len of an unspecified network segment, a configuration error occurs when the prefix-len is shorter than or equal to the mask of any of the IPv6 addresses on the interface. The prefix-len configuration command for the unspecified network segment fails. For example, first configure IPv6 address 10::1/64 on the interface of vlan 40, and then configure `ipv6 route nd-to-route interface vlan 40 prefix-len 60` in the global configuration mode, the configuration fails.

If you configure the prefix-len of an unspecified network segment before configuring the IPv6 address of this interface, syslog is displayed and the prefix-len configuration of unspecified network segment is canceled when one of the IPv6 addresses is longer than or equal to the prefix-len of the unspecified network segment. For example, first configure `ipv6 route nd-to-route interface vlan 40 prefix-len 60` in the global configuration mode, and then configure address 10::1/64 on the interface of vlan 40, syslog alarm is displayed and the configuration `ipv6 route nd-to-route interface vlan 40 prefix-len 60` is deleted.

If you configure the prefix-len of the specified network segment and then configure the IPv6 address of the corresponding network segment, syslog is displayed and the prefix-len configuration of the specified network segment is canceled when the IPv6 address mask of the corresponding network segment is longer than or equal to the prefix-len of the specified network segment. For example, first configure `ipv6 route nd-to-route interface vlan 40 ipv6-prefix 10::1/58 prefix-len 60` in the global configuration mode, and then configure the address 10::1/64 on the interface of vlan 40, the

syslog alarm is displayed and the configuration ipv6 route nd-to-route interface vlan 40 ipv6-prefix 10::1/58 prefix-len 60 is deleted.

If you configure the prefix-len of unspecified network segment and the prefix-len of the specified network segment, and then configure the IPv6 address of the interface, please check whether the mask of each IPv6 address is longer than or equal to the prefix-len of the specified/unspecified network segment. Syslog is displayed and the prefix-len configuration of specified network segment is canceled when the mask of each IPv6 address is longer than or equal to the prefix-len of the corresponding network segment. Syslog is displayed and the prefix-len configuration of unspecified network segment is canceled when the mask of each IPv6 address is longer than or equal to the prefix-len of unspecified network segment. For example, first configure ipv6 route nd-to-route interface vlan 40 prefix-len 62 and ipv6 route nd-to-route interface vlan 40 ipv6-prefix 10::1/58 prefix-len 60, and then configure address 10::1/64 on the interface of vlan 40, the syslog alarm is displayed and two configurations are deleted.

📌 Configuring Delayed Redistribution of nd-to-route

Command `ipv6 route nd-to-route delay-time time-number`

Parameter *time-number*: time of the delayed redistribution of nd-to-route. The unit is second, the range is 1-1000, and the default value is 0

Defaults N/A

Command Mode Global configuration mode

Usage Guide This command is used to delay the redistribution of nd-to-route

📌 Configuring Tag of nd-to-route

Command `ipv6 route nd-to-route tag tag-number`

Parameter *time-number*: tag attribute value of nd-to-route. The range is 1-4294967295, and the default value is 0.

Defaults N/A

Command Mode Global configuration mode

Usage Guide

📌 Ignoring Warning Log of nd-to-route

Command `ipv6 route nd-to-route warning-ignore`

Parameter -

Description

Defaults N/A

Command Global configuration mode
Mode

Usage Guide After you configure to ignore the warning of nd-to-route, the alarm that the same PORT ND generates the same network segment route is ignored. If this command is not configured, the warning log that the same PORT ND generates the same network segment route is printed (only once). The alarm that different ports generate the same network segment route is not controlled by this command.

▾ Enabling nd Proxy

Command **local-proxy-nd enable**

Parameter -

Description

Defaults N/A

Command SVI interface mode
Mode

Usage Guide When the device receives an ND request, it will send an ND response. The MAC address of the response is the local Ethernet MAC address, so that the interconnection among different hosts is implemented by Layer 3 routing.

▾ Configuring BGP Redistributed nd-route Route

Command **redistribute nd-route [route-map *map-tag*] [metric *metric-value*]**

Parameter **route-map *map-tag***: name of the associated route-map. There is no associated route-map by default. **metric *metric-value***: configured the metric value of redistributed route by default, the range is 0-4294967295. There is no default value.

Defaults N/A

Command BGP mode
Mode

Usage Guide Configure BGP to redistribute nd-route route

Verification

Run the **show ipv6 route ndroute** command to display the generated host routes.

Configuration Example

▾ Configuring nd-to-route

Scenario

Figure 10-16



Configuration Configure interface addresses on R1 and R2.

Steps

Enable nd-to-route conversion on the specified interface of R1 and R2, configure BGP and redistribute nd-route routes.

R1

```
R1#configure terminal
R1(config)#interface vlan 40
R1(config-if-VLAN 40)#ipv6 address 10::1/64
R1(config-if-VLAN 40)# local-proxy-nd enable
R1(config-if-VLAN 40)#exit
R1(config)#interface gigabitEthernet 0/1
R1(config-if-GigabitEthernet 0/1)#switchport
R1(config-if-GigabitEthernet 0/1)#switchport mode trunk
R1(config-if-GigabitEthernet 0/1)#switchport trunk allowed vlan only 40
R1(config-if-GigabitEthernet 0/1)#exit
R1(config)#interface gigabitEthernet 0/2
R1(config-if-GigabitEthernet 0/2)# ipv6 address 11::1/64
R1(config-if-GigabitEthernet 0/2)# exit
R1(config)#router bgp 1
R1(config-router)#neighbor 11::2 remote-as 1
R1(config-router)#address-family ipv6
R1(onfig-router-af)#neighbor11::2 next-hop-self
R1(config-router-af)#redistribute nd-route
R1(config-router-af)#exit
R1(config-router)#exit
R1(config)#ipv6 route nd-to-route vlan 40
R1(config)#ipv6 route nd-to-route delay-time 1
```

R2

```
R2#configure terminal
R2(config)#interface vlan 40
R2(config-if-VLAN 40)# ipv6 address 10::2/64
R2(config-if-VLAN 40)# local-proxy-nd enable
R2(config-if-VLAN 40)#exit
R2(config)#interface gigabitEthernet 0/1
R2(config-if-GigabitEthernet 0/1)# switchport
R2(config-if-GigabitEthernet 0/1)#switchport mode trunk
R2(config-if-GigabitEthernet 0/1)# switchport trunk allowed vlan only 40
R2(config-if-GigabitEthernet 0/1)#exit
R2(config)#interface gigabitEthernet 0/2
R2(config-if-GigabitEthernet 0/2)# ipv6 address 11::2/64
R2(config-if-GigabitEthernet 0/2)# exit
R2(config)#router bgp 1
R2(config-router)#neighbor 11::1 remote-as 1
R2(config-router)#address-family ipv6
R2(config-router-af)#neighbor 11::1 next-hop-self
R2(onfig-router-a)#redistributend-route
R2(onfig-router-af)#exit
R2(config-router)#exit
R2(config)# ipv6 route nd-to-route vlan 40
R2(config)# ipv6 route nd-to-route delay-time 1
```

Verification

Display the nd-route routes of R1 to check that PC1 can ping PC2.

```
R1(config)#show ipv6 route ndroute
N      1111::1/128 [1/0] via 1111::1, VLAN 40
R1#show ipv6 route
IPv6 routing table name - Default - 18 entries
Codes: C - Connected, L - Local, S - Static
        R - RIP, O - OSPF, B - BGP, I - IS-IS, V - Overflow route
```

```

N1 - OSPF NSSA external type 1, N2 - OSPF NSSA external type 2

E1 - OSPF external type 1, E2 - OSPF external type 2

SU - IS-IS summary, L1 - IS-IS level-1, L2 - IS-IS level-2

IA - Inter area, N - Nd to host

C    10::/64 via VLAN 1, directly connected
L    10::1/128 via VLAN 1, local host

C    101::/64 via VLAN 101, directly connected
L    101::2/128 via VLAN 101, local host

C    102::/64 via VLAN 102, directly connected
L    102::2/128 via VLAN 102, local host

C    103::/64 via VLAN 103, directly connected
L    103::2/128 via VLAN 103, local host

N    1111::1/128 [1/0] via 1111::1, VLAN 40

B    1111::2/128 [200/0] via 11::2, 00:57:12
    
```

Common Error

- The nd proxy function is not enabled on the specified interface.

10.5.8Configuring an Aggregate Route

Configuration Effect

- Generate an aggregate route in the routing table.

Notes

- Cannot be configured on a L2 switch.

Configuration Steps

📄 Configuring an Aggregate Route

Command	ip route aggregate [vrf vrf_name] network netmask Null 0 [tag tag]	
Parameter Description	vrf vrf_name	(Optional) Route VRF which can be the single protocol IPv4 VRF or configured IPv4 address family multi-protocol VRF. Global VRF by default.
	network	Indicates the address of the destination network.
	netmask	Indicates the mask of the destination network.

	Null 0	Not configure the next hop IP address and egress of the aggregate route
	<i>tag</i>	(Optional) The tag of the aggregate route, 0 by default
Defaults	By default, no aggregate route is configured.	
Command Mode	Global configuration mode	
Usage Guide	The command takes effect in OPENCONF YANG to record the configuration of aggregate routes. The actual effect is like black hole route.	

Verification

- Run the **show ip route** command to display the host route.

Configuration Example

📌 **Configuring an Aggregate Route**

Configuration Steps	Add an aggregate route to the destination network of 1.1.1.0/24 whose TAG is 32.
	<pre>FS(config)#ip route aggregate 1.1.1.0 255.255.255.0 Null 0 tag 32</pre>
Verification	Run the show ip route command to display the aggregate route.
R1	<pre>FS(config)# show ip route</pre> <p>Codes: C - Connected, L - Local, S - Static</p> <p>R - RIP, O - OSPF, B - BGP, I - IS-IS, V - Overflow route</p> <p>N1 - OSPF NSSA external type 1, N2 - OSPF NSSA external type 2</p> <p>E1 - OSPF external type 1, E2 - OSPF external type 2</p> <p>SU - IS-IS summary, L1 - IS-IS level-1, L2 - IS-IS level-2</p> <p>IA - Inter area, EV - BGP EVPN, A - Arp to host</p> <p>LA - Local aggregate route</p> <p>* - candidate default</p> <p>Gateway of last resort is no set</p> <pre>LA 1.1.1.0/24 [1/0] via 0.0.0.0, Null 0</pre>

--	--

10.5.9 Configuring Real-time Statistic of Active Routes

Configuration Effect

- Enable the real-time statistic of active routes

Notes

- Cannot be configured on a L2 switch.

Configuration Steps

⤵ Configuring an Aggregate Route

Command	ip active-route real-time summary
Parameter Description	N/A
Defaults	By default, the function is disabled.
Command Mode	Global configuration mode
Usage Guide	<p>The real-time statistic of active routes mainly applies to the scenario when GRPC periodic samples or gets active routes, or run the show ip route summary command frequently, so as to reduce the statistic time of displaying active routes in large volume.</p> <p>It is not recommended to enable the function in normal scenario, especially with high demand of routing convergence.</p>

Verification

- Run the **show run** command to display the host route.

Configuration Example

⤵ Configuring Real-time Statistic of Active Routes

Configuration Steps	Enable the real-time statistic of active routes
	FS(config)#ip active-route real-time summary
Verification	Run the show run command to display the aggregate route.
R1	<pre>FS(config)# sh run in active-route ip active-route real-time summary</pre>

10.6 Monitoring

Displaying

Description	Command
Displays the IPv4 routing table.	show ip route
Displays the IPv6 routing table.	show ipv6route

Debugging

System resources are occupied when debugging information is output. Therefore, disable debugging immediately after use.

Description	Command
Debugs IPv4 route management.	debug nsm kernel ucast- v4
Debugs IPv6 route management.	debug nsm kernel ucast-v6
Debugs fast reroute management.	debug nsm kernel frr
Debugs default network management.	debug nsm kernel default-network
Debugs internal events of route management.	debug nsm events
Debugs sending of route management and routing protocol messages.	debug nsm packet send
Debugs receiving of route management and routing protocol messages.	debug nsm packet recv

11 Configuring VRF

11.1 Overview

A Virtual Private Network (VPN) Routing and Forwarding (VRF) table is used for the forwarding of VPN packets. Each VPN corresponds to a VRF table.

A device that provides the VPN service has multiple routing tables, including a public network routing table and one or multiple VRF tables. The public-network routing table is used for the forwarding of public network packets, and the VRF tables are used for the forwarding of VPN packets. These routing tables are created to separate routes in the public network from those in VPNs and separate routes in different VPNs.

A VPN is a private dedicated network built in the public network. "Virtual" means that the VPN is logically exclusive, instead of physically exclusive.

11.2 Applications

Application	Description
Local Inter-VPN Access	Provide the VPN service on a routing device and enable VPNs to access each other.
VRF only on Provider Edges (PEs)	Provide the VPN service in an IP network and connect one Customer Edge (CE) to one VPN.
VRF on CEs and PEs	Provide the VPN service in an IP network and connect one CE to multiple VPNs.

CE: An edge device in a customer network

PE: An edge device in a Service Provider (SP) network

11.2.1 Local Inter-VPN Access

Scenario

Provide the VPN service on a routing device and enable VPNs to access each other.

In Figure 11-1, Sub a runs the Routing Information Protocol (RIP), Sub b runs the Open Shortest Path First (OSPF) protocol, and Servers is a network segment directly connected to C. Provide the VPN service on C to Sub a, Sub b, and Servers, and enable Sub a and Sub b to access Servers.

Figure 11-1

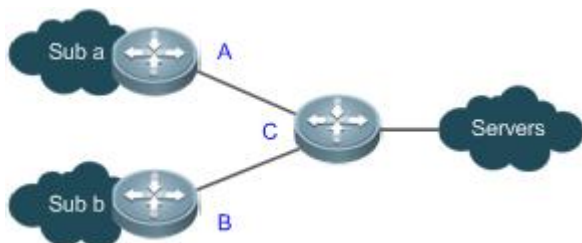

Related Configuration

- On C, create a VRF table for Sub a, bind the interface directly connected to A, and associate the VRF table with A by using RIP.
- On C, create a VRF table for Sub b, bind the interface directly connected to B, and associate the VRF table with B by using OSPF.
- On C, create a VRF table for Servers and bind the interface directly connected to Servers.
- On C, configure the route targets (RTs) of the VRF tables for Suba, Subb, and Servers. Import the routes in the VRF tables for Sub a and Sub b to the VRF table for Servers, and import the routes in the VRF table for Servers to the VRF tables for Sub a and Sub b.
- Configure the Border Gateway Protocol (BGP) on C. Introduce the RIP routes to the VRF table for Sub a, introduce the OSPF routes to the VRF table for Sub b, and introduce the direct routes to the VRF table for Servers.

11.2.2 VRF only on PEs

Scenario

An Internet Service Provider (ISP) provides the VPN service in an IP backbone network.

In Figure 11-2, VPN1 runs RIP, and VPN2 runs OSPF.

- One CE is connected to one VPN, and all routes on the CE are exclusively used by the connected VPN. Therefore, no VRF table needs to be created to separate the routes.
- On each PE, VRF tables must be created to separate the routes in VPN1, those in VPN2, and those in the public network from each other.

Figure 11-2

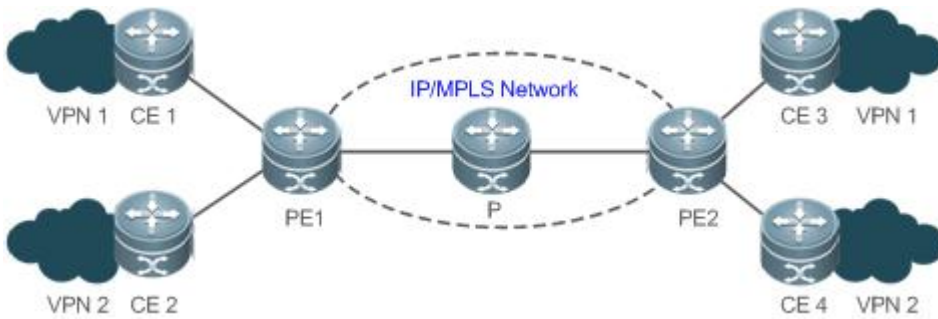

Deployment

- On PE1, create a VRF table for VPN1 and bind the interface directly connected to CE1. On PE2, create a VRF table for VPN1 and bind the interface directly connected to CE3.
- On PE1, create a VRF table for VPN2 and bind the interface directly connected to CE2. On PE2, create a VRF table for VPN2 and bind the interface directly connected to CE4.
- On PE1, associate the VRF table for VPN1 with CE1 by using RIP. On PE2, associate the VRF table for VPN1 with CE3 by using RIP.
- On PE1, associate the VRF table for VPN2 with CE2 by using OSPF. On PE2, associate the VRF table for VPN2 with CE4 by using OSPF.
- In the VRF instance for VPN1 on PE1, redistribute RIP routes to BGP, and redistribute BGP routes to RIP. The configuration on PE2 is similar.
- In the VRF instance for VPN2 on PE1, redistribute OSPF routes to BGP, and redistribute BGP routes to OSPF. The configuration on PE2 is similar.

11.2.3 VRF on CEs and PEs (MCE Application)

Scenario

An ISP provides the VPN service in an IP backbone network.

In Figure 11-3, VPN a runs RIP, VPN b runs OSPF, and PE1 and PE2 are connected to BGP.

- One Multi-VPN-Instance CE (MCE) is connected to multiple VPNs. VRF tables must be created to separate the routes in VPN a from those in VPN b.
- On each PE, VRF tables must be created to separate the routes in VPN a, those in VPN b, and those in the public network from each other.

Figure 11-3



Deployment

- One MCE1, create VRF tables for VPN a and VPN b respectively, bind the interfaces directly connected to VPN a and VPN b, and bind the VLAN interface connected to PE1. The configuration on MCE2 is similar.
- On PE1, create VRF tables for VPN a and VPN b respectively, and bind the VLAN interface connected to MCE1. The configuration on PE2 is similar.
- On MCE1, associate the VRF table for VPN a with VPN a by using RIP. The configuration on MCE2 is similar.
- On MCE1, associate the VRF table for VPN b with VPN b by using OSPF. The configuration on MCE2 is similar.
- In the VRF instance for VPN a on MCE1, redistribute RIP routes to BGP, and redistribute BGP routes to RIP. The configuration on MCE2 is similar.
- In the VRF instance for VPN b on MCE1, redistribute OSPF routes to BGP, and redistribute BGP routes to OSPF. The configuration on MCE2 is similar.

11.3 Features

Overview

Feature	Description
VPN Instance	A VPN instance is used to provide the VPN service. It is typically represented by a VRF table.
VPN Route	A VPN route is used to forward VPN packets.
VPN Route Attribute	Route distinguisher (RD): Identifies the VPN to which a route belongs. RT: Indicates the route trade-off mode of VRF.
Global VRF	Global default VPN instance

11.3.1 VPN Instance

A VPN instance is used to provide the VPN service. On a device that provides the VPN service, a VPN instance consists of the VRF table, interfaces, routing protocol processes, and configuration that belong to the same VPN. A VPN instance is typically represented by a VRF table.

Working Principle

A PE exchanges routes with a CE by using the related routing protocol in the corresponding VPN instance. A VRF table is bound to a specific interface to generate its interface set. Packets received on these interfaces will be associated with the VRF table and forwarded along corresponding routes.

Related Configuration

 Single-protocol VRF tables and multiprotocol VRF tables cannot be created at the same time. Single-protocol VRF tables only support IPv4, whereas multiprotocol VRF tables support IPv4 and IPv6.

Configuring a Single-Protocol VRF Table

By default, a device has no VRF table.

Run the **ip vrf** command to create a single-protocol VRF table.

Run the **ip vrf forwarding** command to bind an interface.

Currently, single-protocol VRF tables only support IPv4.

↘ **Configuring a Multiprotocol VRF Table**

By default, a device has no VRF table.

Run the **vrf definition** command to create a multiprotocol VRF table.

Run the **address-family ipv4** command to enable the IPv4 address family.







Run the **address-family ipv6** command to enable the IPv6 address family.

Run the **vrf forwarding** command to bind an interface.

Multiprotocol VRF tables support IPv4 and IPv6.

11.3.2VPN Route

A VPN route is only used to forward VPN packets. It comes from:

- Direct route and host route on the bound interface
- Direct route and host route on the configured import interface (not bound)
- Static and dynamic routes (RIP, RIPng, OSPFv2, OSPFv3, ISIS, and BGP) in the configured VPN instance
-  For details about the static routes in a VPN instance, see "Configuration Guide > IP Route".
-  For details about RIP in a VPN instance, see "Configuration Guide > IP Route > RIP".
-  For details about RIPng in a VPN instance, see "Configuration Guide > IP Route > RIPng".
-  For details about OSPFv2 in a VPN instance, see "Configuration Guide > IP Route > OSPFv2".
-  For details about OSPFv3 in a VPN instance, see "Configuration Guide > IP Route > OSPFv3".
-  For details about ISIS in a VPN instance, see "Configuration Guide > IP Route > ISIS".
-  For details about BGP in a VPN instance, see "Configuration Guide > IP Route > BGP".

11.3.3VPN Route Attribute

The BGP extended attributes include two attributes specific to VPN routes: RD and RT.

Working Principle

↘ **RD**

Two routes with the same address but different RDs in two VRF tables can be advertised separately between PEs, because the routes are sent together with their RDs through multiprotocol BGP (MP-BGP).

↘ **RT**

RT in essence indicates each VRF table's route trade-off and preferences. It is mainly used to control the advertising and installation policies for VPN routes. RT is divided into the import attribute and export attribute. The import attribute indicates the route of interest, and the export attribute indicates the advertised route. A PE advertises a route to other PEs based on the RT export rule in the corresponding VRF table. The peer PE checks all received routes against the RT import rule in each VRF table. If a route matches an RT export rule (the export rule contains the import rule), it will be added to the corresponding VRF table.

Related Configuration

↘ **RD**

By default, no RD is configured in VRF mode.

Run the **rd** command to configure an RD.

↘ **RT**

By default, no RT is configured in VRF mode or address family mode.

Run the **route-target { import | export | both }** command to configure an RT.

11.3.4Global VRF

Default VPN instance.

Working Principle

↘ **Global VRF**

Configure VPN routing and attributes in the default VPN configuration mode,

Related Configuration

↘ **Enter Global VRF Mode**

By default, global VRF exists.

Run the **vrf global-vrf** command to enter the global VRF mode.

11.4Configuration

Configuration	Description and Command
Configuring a Single-Protocol VRF Table	Single-protocol VRF tables and multiprotocol VRF tables cannot be created at the same time. If IPv6 is supported, configure a multiprotocol VRF table; otherwise, you can configure a single-protocol VRF table or a multiprotocol VRF table. This configuration item creates a VRF table in an IPv4 network. IPv6 is not supported.
	ip vrf <i>vrf-name</i> Creates a VRF table.
	rd <i>rd_value</i> Configures an RD.
	route-target { import export both } <i>rt_value</i> Configures an RT.
	ip vrf forwarding <i>vrf-name</i> Binds an interface and adds the direct route and host route on the interface to a VRF table.
	ip vrf receive <i>vrf_name</i> Adds the direct route and host route on an interface to a VRF table without binding the interface.
Configuring a Multiprotocol VRF Table	Single-protocol VRF tables and multiprotocol VRF tables cannot be created at the same time. If IPv6 is supported, configure a multiprotocol VRF table. otherwise, you can configure a single-protocol VRF table or a multiprotocol VRF table. This configuration item creates a VRF table in an IPv4 or IPv6 network.
	vrf definition <i>vrf-name</i> Creates a VRF table.
	description <i>string</i> Configures a VRF descriptor.

Configuration	Description and Command	
	rd <i>rd_value</i>	Configures an RD.
	route-target { import export both } <i>rt_value</i>	Configures an RT.
	address-family ipv4	Enables the IPv4 address family.
	address-family ipv6	Enables the IPv6 address family.
	vrf forwarding <i>vrf-name</i>	Binds an interface and adds the direct route and host route on the interface to a VRF table.
	vrf receive <i>vrf-name</i>	Adds the direct route and host route on an interface to a VRF table without binding the interface.

11.4.1 Configuring a Single-Protocol VRF Table

Configuration Effect

- Provide the VPN service on a device.
- With BGP assistance, flexibly control the separation and access between VPNs.
- With BGP assistance, provide the VPN service in an IP backbone network.
- Only IPv4 is supported.

Notes

- No VRF table needs to be created if the device only forwards packets from one VPN or from the public network.
- If the device needs to forward public network packets and VPN packets or forward packets from multiple VPNs, VRF tables must be created to separate routes.
- In many cases, static or dynamic routes (RIP, OSPF, ISIS, and BGP) need to be added to VRF tables.

Configuration Steps

↘ Creating a VRF Table

- Mandatory.
- Create a VRF table for each VPN.

↘ Configuring an RD

- Optional.
- When routing information needs to be advertised through BGP in the backbone network, BGP may select the best route for advertising if overlapping network addresses exist in different VPNs, which will make some VPNs fail to obtain corresponding routing information. To solve this problem, you can configure RDs for routes to enable BGP to make routing decisions based on these RDs, thus ensuring that each VPN can obtain corresponding routing information.
- Run the **rd** command in single-protocol VRF mode.

↘ Configuring an RT

- Optional.

- You can run the **route-target export** command to specify the attributes of the route to be advertised, and run the **route-target import** command to specify the attributes of the route to be received. You can also run the **route-target both** command to specify the export and import attributes.
- Run the **route-target** command in single-protocol VRF mode.

↘ **Binding an Interface and Adding the Direct Route and Host Route on the Interface to a VRF Table**

- Mandatory.
- If the physical link for transmitting VPN packets is exclusively occupied by a VPN, bind the physical interface to the corresponding VRF table.
- If the physical link for transmitting VPN packets is shared by multiple VPNs, you need to create an independent logical link for each VPN, and bind the logical interface to the corresponding VRF table. A logical interface can be a subinterface or a VLAN interface.
- You must bind an interface to the corresponding single-protocol VRF table before you configure the IPv4 address of the interface. If you bind the interface after its IPv4 address is configured, the IPv4 address will be invalid (the IPv6 address of the interface is retained).
- If you bind an interface to the corresponding single-protocol VRF table and enable IPv6 on the interface, the device cannot forward the IPv6 packets received on the interface.

↘ **Adding the Direct Route and Host Route on an Interface to a VRF Table Without Binding the Interface**

- Optional.
- If policy-based routing (PBR) is required for VRF table selection, run the **ip vrf receive** command on the interface to which PBR is applied, and import the direct route and host route on the interface to each VRF table available for choice.

Verification

- Check whether VRF tables are created correctly on the router.

Related Commands

↘ **Creating a VRF Table**

Command	ip vrf vrf-name
Parameter	<i>vrf-name</i> : Indicates the name of the VRF table to be created. It cannot exceed 31 characters.
Description	
Command Mode	Global configuration mode
Usage Guide	After you run the command, the system will enter VRF mode.

↘ **Configuring an RD**

Command	rd rd_value
Parameter	<i>rd_value</i> has the following three different parameter forms:
Description	(1) <i>rd_value</i> = as_num: nn as_num indicates the 2-byte number that identifies a public autonomous system (AS). nn is configurable in the range 0..4294967295. (2) <i>rd_value</i> = ip_addr: nn

	<p>ip_addr must be a global IP address. nn is configurable in the range 0..65535.</p> <p>(3) <i>rd_value</i> = as4_num: nn</p> <p>as4_num indicates the 4-byte number that identifies a public AS. nn is configurable in the range 1..65535.</p>
Command Mode	VRF configuration mode
Usage Guide	<p>You cannot directly change the RD of an existing VRF table. You need to delete the VRF table first and then configure a new RD.</p> <p>A VRF table has only one RD. You cannot configure multiple RDs for one VRF table.</p>

📌 **Configuring an RT**

Command	route-target { import export both } <i>rt_value</i>
Parameter Description	<p><i>rt_value</i> has the following three different parameter forms:</p> <p>(1) <i>rt_value</i> = as_num: nn</p> <p>as_num indicates the 2-byte number that identifies a public AS. nn is configurable in the range 0..4294967295.</p> <p>(2) <i>rt_value</i> = ip_addr: nn</p> <p>ip_addr must be a global IP address. nn is configurable in the range 0..65535.</p> <p>(3) <i>rt_value</i> = as4_num: nn</p> <p>as4_num indicates the 4-byte number that identifies a public AS. nn is configurable in the range 1..65535.</p>
Command Mode	VRF configuration mode
Usage Guide	A VRF table can be configured with multiple import and export RT attributes.

📌 **Binding an Interface**

Command	ip vrf forwarding <i>vrf-name</i>
Parameter Description	<i>vrf-name</i> : Indicates the name of a VRF table.
Command Mode	Interface configuration mode
Usage Guide	<p>By default, an interface does not belong to any VRF table.</p> <p>After an interface is bound to the corresponding VRF table, the direct route and host route on the interface will be automatically added to the VRF table.</p> <p>You must bind an interface to the corresponding single-protocol VRF table before you configure the IPv4 address of the interface. If you bind the interface after its IPv4 address is configured, the IPv4 address will be invalid (the IPv6 address of the interface is retained).</p>

📌 **Adding the Direct Route and Host Route on an Interface to a VRF Table Without Binding the Interface**

Command	ip vrf receive <i>vrf-name</i>
Parameter Description	<i>vrf-name</i> : Indicates the name of a VRF table.
Command Mode	Interface configuration mode
Usage Guide	<p>This command is used to add the host route and direct route on an interface to a VRF table. If you need to add the host route and direct route on an interface to multiple VRF tables, run the command multiple times.</p> <p>Different from the ip vrf forwarding command, the ip vrf receive command does not bind an interface to the</p>

	<p>corresponding VRF table. The interface is still a global interface and does not belong to any VRF table.</p> <p>The ip vrf forwarding and ip vrf receive commands are mutually exclusive on the same interface.</p>
--	--

↘ **Displaying the VRF Information on a Device**

Command	show ip vrf [brief detail interfaces] [vrf-name]
Parameter	brief: Displays brief information.
Description	<p>detail: Displays detailed information.</p> <p>interfaces: Displays the interface binding information.</p> <p><i>vrf-name:</i> Indicates the name of a VRF table.</p>
Command Mode	Privilege, global and interface configuration modes
Usage Guide	This command is used to display the information of a specified VRF table to check whether the VRF table is bound with the correct interface.

↘ **Displaying the Routes in a VRF Table**

Command	show ip route vrf vrf-name
Parameter	<i>vrf-name:</i> Indicates the name of a VRF table.
Description	
Command Mode	Privilege, global and interface configuration modes
Usage Guide	This command is used to check whether a specified VRF table contains corresponding routes.

Configuration Example

↘ **Local Inter-VPN Access**

<p>Scenario</p> <p>Figure 11-4</p>	
	<p>Sub a, Sub b, and Servers are three VPNs that have separate address spaces.</p> <p>Sub a runs RIP, Sub b runs OSPF, and Servers is a network segment directly connected to C.</p>
Configuration Requirements	Routes in Sub a are separated from those in Sub b, but both Sub a and Sub b can access Servers.
Configuration Steps	<ul style="list-style-type: none"> ● On C, create a VRF table for Sub a, bind the interface directly connected to A, and associate the VRF table with A by using RIP. ● On C, create a VRF table for Sub b, bind the interface directly connected to B, and associate the VRF table with B by using OSPF. ● On C, create a VRF table for Servers and bind the interface directly connected to Servers. ● On C, configure the RTs of the VRF tables for Sub a, Sub b, and Servers. Import the routes in the VRF tables for Sub a and Sub b to the VRF table for Servers, and import the routes in the VRF table for Servers to the VRF tables for Sub a

and Sub b.

- Configure the Border Gateway Protocol (BGP) on C. Introduce the RIP routes to the VRF table for Sub a, introduce the OSPF routes to the VRF table for Sub b (enabled with an address family), and introduce the direct routes to the VRF table for Servers (enabled with an address family).

Planning of interfaces and addresses:

Interface Description	Interface Name	IP Address/Mask	VRF Table
Interface on C connected to A	GE0/1	10.10.1.1/24	VRF table for Sub a
Interface on C connected to B	GE0/2	10.10.2.1/24	VRF table for Sub b
Interface on C connected to Servers	GE0/3	10.10.3.1/24	VRF table for Servers
Interface on A connected to C	GE0/1	10.10.1.2/24	-
Interface on B connected to C	GE0/2	10.10.2.2/24	-

A

```
A(config)#interface GigabitEthernet 0/1
A(config-if-GigabitEthernet 0/1)#no switchport port
A(config-if-GigabitEthernet 0/1)#ip address 10.10.1.2 255.255.255.0
A(config-if-GigabitEthernet 0/1)#exit
A(config)#router rip
A(config-router)#version 2
A(config-router)#no auto-summary
A(config-router)#network 10.10.1.0 0.0.0.255
```

B

```
B(config)#interface GigabitEthernet 0/2
B(config-if-GigabitEthernet 0/2)#no switchport port
B(config-if-GigabitEthernet 0/2)#ip address 10.10.2.2 255.255.255.0
B(config-if-GigabitEthernet 0/2)#exit
B(config)#router ospf 1
B(config-router)#network 10.10.2.0 0.0.0.255 area 0
```

C

```
C(config)# ip vrf Suba
C(config-vrf)# rd 100:1
C(config-vrf)# route-target import 100:3
C(config-vrf)# route-target export 100:1
C(config-vrf)# exit
C(config)#interface GigabitEthernet 0/1
C(config-GigabitEthernet 0/1)#ip vrf forwarding Suba
C(config-GigabitEthernet 0/1)#ip address 10.10.1.1 255.255.255.0
C(config-GigabitEthernet 0/1)# exit
C(config)#router rip
```

<pre> C(config-router)#address-family ipv4 vrf Suba C(config-router-af)# version 2 C(config-router-af)# no auto-summary C(config-router-af)#network 10.10.1.0 0.0.0.255 C(config-router-af)#exit </pre>
<pre> C(config)# ip vrf Subb C(config-vrf)# rd 100:2 C(config-vrf)# route-target import 100:3 C(config-vrf)# route-target export 100:2 C(config-vrf)# exit C(config)#interface gigabitEthernet 0/2 C(config-GigabitEthernet 0/2)#ip vrf forwarding Subb C(config-GigabitEthernet 0/2)# ip address 10.10.2.1 255.255.255.0 C(config-GigabitEthernet 0/2)# exit C(config)# router ospf 2 vrf Subb C(config-router)# network 10.10.2.0 0.0.0.255 area 0 C(config-router)# exit </pre>
<pre> C(config)# ip vrf Servers C(config-vrf)# rd 100:3 C(config-vrf)# route-target import 100:1 C(config-vrf)# route-target import 100:2 C(config-vrf)# route-target export 100:3 C(config-vrf)# exit C(config)# interface gigabitEthernet 0/3 C(config-GigabitEthernet 0/3)# ip vrf forwarding Servers C(config-GigabitEthernet 0/3)# ip address 10.10.3.1 255.255.255.0 C(config-GigabitEthernet 0/3)# exit </pre>
<pre> C(config)# router bgp 200 C(config-router)# address-family ipv4 vrf vpna C(config-router-af)# redistribute rip C(config-router-af)# exit C(config-router)# address-family ipv4 vrf vpnb C(config-router-af)# redistribute ospf 1 </pre>

	<pre>C(config-router-af)# exit C(config-router)# address-family ipv4 vrf Servers C(config-router-af)# redistribute connected subnets C(config-router-af)# exit</pre>
<p>Verification</p>	<ul style="list-style-type: none"> ● Run the show ip vrf interface command on C to check the interface binding information. ● Run the show ip route vrf command on C to check whether two VRF tables are created to separate the routes in Sub a from those in Sub b and whether both VRF tables contain the routes in Servers.
<p>C</p>	<pre>C# show ip vrf interfaces Interface IP-Address VRF Protocol GigabitEthernet 0/1 10.10.1.1 Suba up GigabitEthernet 0/2 10.10.2.1 Subb up GigabitEthernet 0/3 10.10.3.1 Servers up</pre>
	<pre>C# show ip route vrf Subb Routing Table: Subb Codes: C - connected, S - static, R - RIP, B - BGP O - OSPF, IA - OSPF inter area N1 - OSPF NSSA external type 1, N2 - OSPF NSSA external type 2 E1 - OSPF external type 1, E2 - OSPF external type 2 i - IS-IS, su - IS-IS summary, L1 - IS-IS level-1, L2 - IS-IS level-2 ia - IS-IS inter area, * - candidate default Gateway of last resort is no set O 10.2.0.0/16 [20/0] via 0.0.0.0, 00:10:46, GigabitEthernet 0/2 O 10.10.2.0/24 [20/0] via 0.0.0.0, 00:10:46, GigabitEthernet 0/2 C 10.10.2.1/32 is local host. C 10.10.3.0/24 is directly connected, GigabitEthernet 0/3 C 10.10.3.1/32 is local host.</pre>

Common Errors

- An interface is bound to a VRF table after the IP interface of the interface is configured.
- When a physical link is used to forward packets from multiple VPNs, the corresponding physical interface is bound to a VRF table.
- VPN routes are not introduced to BGP.

11.4.2 Configuring a Multiprotocol VRF Table

Configuration Effect

- Provide the VPN service on a device.
- With BGP assistance, flexibly control the separation and access between VPNs.
- With BGP assistance, provide the VPN service in an IP backbone network.
- Support IPv4 and IPv6 through address family configuration.

Notes

- No VRF table needs to be created if the device only forwards packets from one VPN or from the public network.
- If the device needs to forward public network packets and VPN packets or forward packets from multiple VPNs, VRF tables must be created to separate routes.
- In many cases, static or dynamic routes (RIP, OSPF, ISIS, and BGP) need to be added to VRF tables.

Configuration Steps

↘ Creating a VRF Table

- Mandatory.
- Create a VRF table for each VPN.

↘ Configuring an Address Family

- Mandatory.
- Enable the corresponding address family for each created VRF table.

↘ Configuring an RD

- Optional.
- When routing information needs to be advertised through BGP in the backbone network, BGP may select the best route for advertising if overlapping network addresses exist in different VPNs, which will make some VPNs fail to obtain corresponding routing information. To solve this problem, you can configure RDs for routes to enable BGP to make routing decisions based on these RDs, thus ensuring that each VPN can obtain corresponding routing information.

↘ Configuring an RT

- Optional.
- You can run the **route-target export** command to specify the attributes of the route to be advertised, and run the **route-target import** command to specify the attributes of the route to be received. You can also run the **route-target both** command to specify the export and import attributes.
- Run the **route-target** command in multiprotocol VRF mode or multiprotocol VRF address family mode.

↘ Binding an Interface and Adding the Direct Route and Host Route on the Interface to a VRF Table

- Mandatory.
- If the physical link for transmitting VPN packets is exclusively occupied by a VPN, bind the physical interface to the corresponding VRF table.

- If the physical link for transmitting VPN packets is shared by multiple VPNs, you need to create an independent logical link for each VPN, and bind the logical interface to the corresponding VRF table. A logical interface can be a subinterface or a VLAN interface.
- Before you bind an interface to a multiprotocol VRF table, enable an address family for the table. If you do not enable the IPv4 address family in advance, you cannot configure the IPv4 address and VRRP IPv4 address of the bound interface. If you do not enable the IPv6 address family in advance, you cannot configure the IPv6 address and VRRP IPv6 address of the bound interface.
- You must bind an interface to the corresponding multiprotocol VRF table before you configure the IPv4 or IPv6 address of the interface. If you bind the interface after its IPv4 or IPv6 address is configured, the address will be invalid.

➤ **Adding the Direct Route and Host Route on an Interface to a VRF Table Without Binding the Interface**

- Optional.
- If PBR is required for VRF table selection, run the **ip vrf receive** command on the interface to which PBR is applied, and import the direct route and host route on the interface to each VRF table available for choice.

Verification

- Check whether multiprotocol VRF tables are created correctly on the router and corresponding address families are enabled.

Related Commands

➤ **Creating a VRF Table**

Command	vrf definition <i>vrf-name</i>
Parameter	<i>vrf-name</i> : Indicates the name of the VRF table to be created. It cannot exceed 31 characters.
Description	
Command Mode	Global configuration mode
Usage Guide	After you run the command, the system will enter VRF mode.

➤ **Enabling the IPv4 Address Family**

Command	address-family ipv4
Parameter	N/A
Description	
Command Mode	VRF mode
Usage Guide	After you run the command, the system will enter VRF IPv4 address family submode.

➤ **Enabling the IPv6 Address Family**

Command	address-family ipv6
Parameter	N/A
Description	
Command Mode	VRF mode
Usage Guide	After you run the command, the system will enter VRF IPv6 address family submode.

➤ **Configuring an RD**

Command	<code>rd rd_value</code>
Parameter Description	<p><code>rd_value</code> has the following three different parameter forms:</p> <p>(1) <code>rd_value = as_num: nn</code> as_num indicates the 2-byte number that identifies a public AS. nn is configurable in the range 0..4294967295.</p> <p>(2) <code>rd_value = ip_addr: nn</code> ip_addr must be a global IP address. nn is configurable in the range 0..65535.</p> <p>(3) <code>rd_value = as4_num: nn</code> as4_num indicates the 4-byte number that identifies a public AS. nn is configurable in the range 1..65535.</p>
Command Mode	VRF configuration mode
Usage Guide	<p>You cannot directly change the RD of an existing VRF table. You need to delete the VRF table first and then configure a new RD.</p> <p>A VRF table has only one RD. You cannot configure multiple RDs for one VRF table.</p>

↘ Configuring an RT

Command	<code>route-target { import export both } rt_value</code>
Parameter Description	<p><code>rt_value</code> has the following three different parameter forms:</p> <p>(1) <code>rt_value = as_num: nn</code> as_num indicates the 2-byte number that identifies a public AS. nn is configurable in the range 0..4294967295.</p> <p>(2) <code>rt_value = ip_addr: nn</code> ip_addr must be a global IP address. nn is configurable in the range 0..65535.</p> <p>(3) <code>rt_value = as4_num: nn</code> as4_num indicates the 4-byte number that identifies a public AS. nn is configurable in the range 1..65535.</p>
Command Mode	VRF configuration mode or VRF address family submode
Usage Guide	One VRF table can be configured with multiple import and export RT attributes.

↘ Binding an Interface

Command	<code>vrf forwarding vrf-name</code>
Parameter Description	<code>vrf-name</code> : Indicates the name of a VRF table.
Command Mode	Interface configuration mode
Usage Guide	<p>By default, an interface does not belong to any VRF table.</p> <p>After an interface is bound to the corresponding VRF table, the direct route and host route on the interface will be automatically added to the VRF table.</p> <p>Before you bind an interface to a multiprotocol VRF table, enable an address family for the table. If you do not enable the IPv4 address family in advance, you cannot configure the IPv4 address and VRRP IPv4 address of the bound interface. If you do not enable the IPv6 address family in advance, you cannot configure the IPv6 address and VRRP IPv6 address of the bound interface.</p> <p>You must bind an interface to a multiprotocol VRF table before you configure the IPv4, IPv6, VRRP IPv4, and VRRP IPv6 addresses of the interface; otherwise, these addresses will be invalid and the IPv6 protocol on the interface will be disabled.</p> <p>If the IPv4 address family is deleted from the multiprotocol VRF table, the IPv4 and VRRP IPv4 addresses of all interfaces</p>

	bound to the VRF table will be deleted, and the IPv4 static routes in the VRF table or next-hop routes are also deleted. If the IPv6 address family is deleted from the multiprotocol VRF table, the IPv6 and VRRP IPv6 addresses of all interfaces bound to the VRF table will be deleted, the IPv6 protocol on the interfaces will be disabled, and the IPv6 static routes in the VRF table or next-hop routes are also deleted.
--	--

➤ Adding the Direct Route and Host Route on an Interface to a VRF Table Without Binding the Interface

Command	vrf receive <i>vrf-name</i>
Parameter	<i>vrf-name</i> : Indicates the name of a VRF table.
Description	
Command Mode	Interface configuration mode
Usage Guide	This command is used to add the host route and direct route on an interface to a VRF table. If you need to add the host route and direct route on an interface to multiple VRF tables, run the command multiple times. Different from the vrf forwarding command, the vrf receive command does not bind an interface to the corresponding VRF table. The interface is still a global interface and does not belong to any VRF table. The vrf forwarding and vrf receive commands are mutually exclusive on the same interface.

➤ Displaying the VRF Information on a Device

Command	show vrf [brief detail ipv4 ipv6] [<i>vrf-name</i>]
Parameter	brief : Displays brief information.
Description	detail : Displays detailed information. ipv4 : Displays the brief information of an IPv4 VRF table. ipv6 : Displays the brief information of an IPv6 VRF table. <i>vrf-name</i> : Indicates the name of a VRF table.
Command Mode	Privilege, global and interface configuration modes
Usage Guide	This command is used to display the information of a specified VRF table to check whether the VRF table is bound with the correct interface.

➤ Displaying the Routes in a VRF Table

Command	show ip route vrf <i>vrf-name</i>
Parameter	<i>vrf-name</i> : Indicates the name of a VRF table.
Description	
Command Mode	Privilege, global and interface configuration modes
Usage Guide	This command is used to check whether a specified VRF table contains corresponding routes.

Configuration Example

 The following example only describes VRF-related configuration on A1, B1, MCE1, and PE1. The configuration on A2, B2, MCE2, and PE2 is similar.

➤ VRF on CEs and PEs (MCE Application)

<p>Scenario Figure 11-5</p>																																					
	<p>VPN a and VPN b have independent address spaces. VPN a runs RIP and VPN b runs OSPF.</p>																																				
<p>Configuration Requirements</p>	<p>The routes in VPN a are separated from those in VPN b. A1 and A2 can access each other, and B1 and B2 can access each other.</p>																																				
<p>Configuration Steps</p>	<ul style="list-style-type: none"> ● Connect MCE1 and A1 through RIP. Extend RIP routes on A1. On MCE1, create a VRF table for VPN a, bind the directly connected interface, and configure RIP routes. ● Connect MCE1 and B1 through OSPF. Extend OSPF routes on B1. On MCE1, create a VRF table for VPN b, bind the directly connected interface, and configure OSPF routes. ● Connect MCE1 and PE1 through BGP. On MCE1 and PE1, create a VRF table for each VPN, bind the VLAN interface, and configure BGP routes. ● Configure the physical link between MCE1 and PE1 in Trunk mode. ● In the VRF instance for VPN a on MCE1, redistribute the RIP routes to BGP, and redistribute the BGP routes to RIP. ● In the VRF instance for VPN b on MCE1, redistribute the OSPF routes to BGP, and redistribute the BGP routes to OSPF. <p>i Planning of interfaces and addresses:</p> <table border="1" data-bbox="329 1176 1489 1892"> <thead> <tr> <th>Interface Description</th> <th>Interface Name</th> <th>IP Address/Mask</th> <th>VRF Table</th> </tr> </thead> <tbody> <tr> <td>Physical interface on A1 connected to MCE1</td> <td>GE0/1</td> <td>10.10.1.2/24</td> <td>-</td> </tr> <tr> <td>Physical interface on B1 connected to MCE1</td> <td>GE0/2</td> <td>10.10.2.2/24</td> <td>-</td> </tr> <tr> <td>Physical interface on MCE1 connected to A1</td> <td>GE0/1</td> <td>10.10.1.1/24</td> <td>VRF table for VPN a</td> </tr> <tr> <td>Physical interface on MCE1 connected to B1</td> <td>GE0/2</td> <td>10.10.2.1/24</td> <td>VRF table for VPN b</td> </tr> <tr> <td>Logical interface on MCE1 connected to PE1</td> <td>VLAN10</td> <td>10.10.10.1/24</td> <td>VRF table for VPN a</td> </tr> <tr> <td>Logical interface on MCE1 connected to PE1</td> <td>VLAN20</td> <td>10.10.20.1/24</td> <td>VRF table for VPN b</td> </tr> <tr> <td>Logical interface on PE1 connected to MCE1</td> <td>VLAN10</td> <td>10.10.10.2/24</td> <td>VRF table for VPN a</td> </tr> <tr> <td>Logical interface on PE1 connected to MCE1</td> <td>VLAN20</td> <td>10.10.20.2/24</td> <td>VRF table for VPN b</td> </tr> </tbody> </table>	Interface Description	Interface Name	IP Address/Mask	VRF Table	Physical interface on A1 connected to MCE1	GE0/1	10.10.1.2/24	-	Physical interface on B1 connected to MCE1	GE0/2	10.10.2.2/24	-	Physical interface on MCE1 connected to A1	GE0/1	10.10.1.1/24	VRF table for VPN a	Physical interface on MCE1 connected to B1	GE0/2	10.10.2.1/24	VRF table for VPN b	Logical interface on MCE1 connected to PE1	VLAN10	10.10.10.1/24	VRF table for VPN a	Logical interface on MCE1 connected to PE1	VLAN20	10.10.20.1/24	VRF table for VPN b	Logical interface on PE1 connected to MCE1	VLAN10	10.10.10.2/24	VRF table for VPN a	Logical interface on PE1 connected to MCE1	VLAN20	10.10.20.2/24	VRF table for VPN b
Interface Description	Interface Name	IP Address/Mask	VRF Table																																		
Physical interface on A1 connected to MCE1	GE0/1	10.10.1.2/24	-																																		
Physical interface on B1 connected to MCE1	GE0/2	10.10.2.2/24	-																																		
Physical interface on MCE1 connected to A1	GE0/1	10.10.1.1/24	VRF table for VPN a																																		
Physical interface on MCE1 connected to B1	GE0/2	10.10.2.1/24	VRF table for VPN b																																		
Logical interface on MCE1 connected to PE1	VLAN10	10.10.10.1/24	VRF table for VPN a																																		
Logical interface on MCE1 connected to PE1	VLAN20	10.10.20.1/24	VRF table for VPN b																																		
Logical interface on PE1 connected to MCE1	VLAN10	10.10.10.2/24	VRF table for VPN a																																		
Logical interface on PE1 connected to MCE1	VLAN20	10.10.20.2/24	VRF table for VPN b																																		
<p>A1</p>	<pre>A1(config)#interface GigabitEthernet 0/1 A1(config-if-GigabitEthernet 0/1)#no switchport port</pre>																																				

	<pre>A1(config-if-GigabitEthernet 0/1)#ip address 10.10.1.2 255.255.255.0 A1(config-if-GigabitEthernet 0/1)#exit A1(config)#router rip A1(config-router)#version 2 A1(config-router)#no auto-summary A1(config-router)#network 10.10.1.0 0.0.0.255</pre>
B1	<pre>B1(config)#interface GigabitEthernet 0/2 B1(config-if-GigabitEthernet 0/1)#no switchport port B1(config-if-GigabitEthernet 0/1)#ip address 10.10.2.2 255.255.255.0 B1(config-if-GigabitEthernet 0/1)#exit B1(config)#router ospf 1 B1(config-router)#network 10.10.2.0 0.0.0.255 area 0</pre>
MCE1	<pre>#Create a VRF table for VPN a and a VRF table VPN b, and enable the IPv4 address family. MCE1(config)#vrf definition vpna MCE1(config-vrf)#address-family ipv4 MCE1(config-vrf-af)#exit MCE1(config-vrf)#exit MCE1(config)#vrf definition vpnb MCE1(config-vrf)#address-family ipv4 MCE1(config-vrf-af)#exit MCE1(config-vrf)#exit</pre>
	<pre>#Bind interfaces to the VRF tables. MCE1(config)#interface GigabitEthernet 0/1 MCE1(config-if-GigabitEthernet 0/1)#no switchport port MCE1(config-if-GigabitEthernet 0/1)#vrf forwarding vpna MCE1(config-if-GigabitEthernet 0/1)#ip address 10.10.1.1 255.255.255.0 MCE1(config-if-GigabitEthernet 0/1)#exit MCE1(config)#interface GigabitEthernet 0/2 MCE1(config-if-GigabitEthernet 0/2)#no switchport port MCE1(config-if-GigabitEthernet 0/2)#vrf forwarding vpnb MCE1(config-if-GigabitEthernet 0/2)#ip address 10.10.2.1 255.255.255.0 MCE1(config-if-GigabitEthernet 0/2)#exit MCE1(config)#interface vlan 10</pre>

	<pre>MCE1(config-if-VLAN 10)#vrf forwarding vpna MCE1(config-if-VLAN 10)#ip address 10.10.10.1 255.255.255.0 MCE1(config-if-VLAN 10)#exit MCE1(config)#interface vlan 20 MCE1(config-if-VLAN 20)#vrf forwarding vpnb MCE1(config-if-VLAN 20)#ip address 10.10.20.1 255.255.255.0 MCE1(config-if-VLAN 20)#exit</pre>
	<p>#Configure the interface connected to PE1 in Trunk mode.</p> <pre>MCE1(config)#interface GigabitEthernet 0/3 MCE1(config-if-GigabitEthernet 0/3)#switchport mode trunk MCE1(config-if-GigabitEthernet 0/3)#exit</pre>
	<p>#Configure RIP and BGP routes in the VRF table for VPN a, and introduce routes in the two VRF tables to each other.</p> <pre>MCE1(config)#router rip MCE1(config-router)#address-family ipv4 vrf vpna MCE1(config-router-af)# version 2 MCE1(config-router-af)# no auto-summary MCE1(config-router-af)#network 10.10.1.0 0.0.0.255 MCE1(config-router-af)#redistribute bgp subnets MCE1(config-router-af)#exit MCE1(config)# router bgp 100 MCE1(config-router)#address-family ipv4 vrf vpna MCE1(config-router-af)#neighbor 10.10.10.2 remote-as 200 MCE1(config-router-af)#redistribute rip MCE1(config-router-af)#exit</pre>
	<p>#Configure OSPF and BGP routes in the VRF table for VPN b, and introduce routes in the two VRF tables to each other.</p> <pre>MCE1(config)#router ospf 1 vrf vpnb MCE1(config-router)#network 10.10.2.0 0.0.0.255 area 0 MCE1(config-router)#redistribute bgp subnets MCE1(config-router)#exit MCE1(config)# router bgp 100 MCE1(config-router)#address-family ipv4 vrf vpnb MCE1(config-router-af)#neighbor 10.10.20.2 remote-as 200 MCE1(config-router-af)#redistribute ospf 1 MCE1(config-router-af)#exit</pre>

<p>PE1</p>	<p>#Create a VRF table for VPN a and a VRF table VPN b, and enable the IPv4 address family.</p> <pre> PE1(config)#vrf definition vpna PE1(config-vrf)#address-family ipv4 PE1(config-vrf-af)#exit PE1(config-vrf)#exit PE1(config)#vrf definition vpnb PE1(config-vrf)#address-family ipv4 PE1(config-vrf-af)#exit PE1(config-vrf)#exit </pre>
	<p>#Bind interfaces to the VRF tables.</p> <pre> PE1(config)#vlan 10 PE1(config-vlan)#exit PE1(config)#vlan 20 PE1(config-vlan)#exit PE1(config)#interface vlan 10 PE1(config-if-VLAN 10)#vrf forwarding vpna PE1(config-if-VLAN 10)#ip address 10.10.10.2 255.255.255.0 PE1(config-if-VLAN 10)#exit PE1(config)#interface vlan 20 PE1(config-if-VLAN 20)#vrf forwarding vpnb PE1(config-if-VLAN 20)#ip address 10.10.20.2 255.255.255.0 PE1(config-if-VLAN 20)#exit </pre>
	<p>#Configure the interface on PE1 connected to MCE1 in Trunk mode.</p> <pre> PE1(config)#interface GigabitEthernet 0/3 PE1(config-if-GigabitEthernet 0/3)#switchport mode trunk PE1(config-if-GigabitEthernet 0/3)#exit </pre>
	<p>#Configure BGP routes in the VRF table for VPN a.</p> <pre> PE1(config)# router bgp 200 PE1(config-router)#address-family ipv4 vrf vpna PE1(config-router-af)#neighbor 10.10.10.1 remote-as 100 PE1(config-router-af)#exit </pre>
	<p>#Configure BGP routes in the VRF table for VPN b.</p> <pre> PE1(config)# router bgp 200 </pre>

	<pre>PE1(config-router)#address-family ipv4 vrf vpnb PE1(config-router-af)#neighbor 10.10.20.1 remote-as 100 PE1(config-router-af)#exit</pre>
Verification	<ul style="list-style-type: none"> ● On A1, run the show ip route command to display the routes in VPN a. ● On B2, run the show ip route command to display the routes in VPN b. ● On MCE1, run the show ip route vrf vpna command to display the routes in VPN a, and run the show ip route vrf vpnb command to display the routes in VPN b. ● On PE1, run the show ip route vrf vpna command to display the routes in VPN a, and run the show ip route vrf vpnb command to display the routes in VPN b.

Common Errors

- A multiprotocol VRF table is configured, but no address family is enabled.
- An interface is bound to a VRF table after the IP interface of the interface is configured.
- When a physical link is used to forward packets from multiple VPNs, the corresponding physical interface is bound to a VRF table.
- VPN routes are not introduced to BGP.

11.5 Monitoring

Clearing

Running the **clear** commands may lose vital information and thus interrupt services.

Description	Command
Clears the routes in a specified VRF table.	clear ip route vrf <i>vrf-name</i>

Displaying

Description	Command
Displays the information of a single-protocol VRF table.	show ip vrf [brief detail interfaces] [<i>vrf-name</i>]
Displays the information of a multiprotocol VRF table.	show vrf [ipv4 ipv6 brief detail] [<i>vrf-name</i>]
Displays the global VRF information.	show global-vrf [ipv4 ipv6 brief detail]

Debugging

System resources are occupied when debugging information is output. Therefore, disable debugging immediately after use.

Description	Command
Displays the debugging information during the processes where a VRF table is created, an address family is enabled, and an interface is bound to the VRF table.	debug vrf

Prints the information of interface-related VRF operation debugging.	debug vrf interface
--	----------------------------

12 Configuring L3MAC

12.1 Overview

A layer-3 MAC address for forwarding can be configured for a device so that packets whose destination MAC addresses match the configured layer-3 MAC address are forwarded at layer 3. In data center scenarios, this MAC address can be configured in static ARP entries of neighbors so that routing can be triggered on any neighbor device.

12.2 Applications

Application	Description
Data Center Scenario	Layer-3 routing can be triggered on any neighbor without perceiving the layer-3 MAC address of the device.

12.2.1 Data Center Scenario

Scenario

A data center adopting the topology shown in the figure below is used as an example:

- A global layer-3 MAC address is configured on SW2 and SW3.
- A static ARP entry is configured on SW1.
- The MAC address in the static ARP entry configured on SW1 is the global layer-3 MAC address of its neighbors, that is, SW2 and SW3.

Figure 1-1

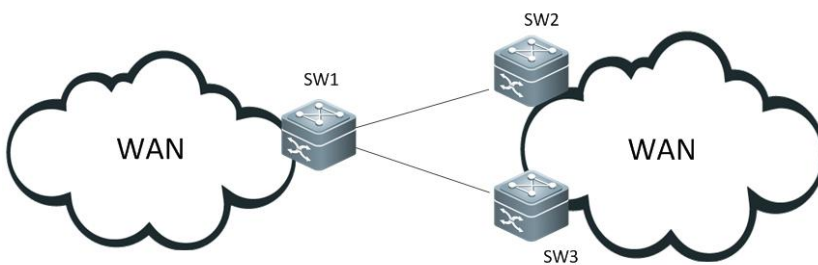

Deployment

- Packets from SW1 can be routed at layer 3 through its neighbors: SW2 and SW3.

12.3 Configuration

Configuration	Description and Command	
Adding a Layer-3 MAC Address	Mandatory.	
	I3intf-mac-add	Adds a layer-3 MAC address.

12.3.1 Adding a Layer-3 MAC Address

Configuration Effect

- Add a global layer-3 MAC address so that layer-3 routing can be triggered when packets matching this layer-3 MAC address are received.

Notes

- Up to two layer-3 MAC addresses can be added.

Configuration Steps

▾ Adding a Layer-3 MAC Address

Command	I3intf-mac-add <i>mac</i>
Parameter Description	<i>mac</i> : Indicates the layer-3 MAC address.
Command Mode	Global configuration mode
Usage Guide	N/A

▾ Deleting a Layer-3 MAC Address

Command	no I3intf-mac-add <i>mac</i>
Parameter Description	<i>mac</i> : Indicates the layer-3 MAC address.
Command Mode	Global configuration mode
Usage Guide	N/A

Verification

1. Run the **show run** command to check whether the current configuration is correct.
2. Run the **show I3intf-mac-add** command to check whether the current configuration is correct.

Configuration Example

▾ Adding a Layer-3 MAC Address

<p>Scenario Figure 1-2</p>	
<p>Configuration Steps</p>	<p>Configure a static ARP entry on SW1, and a global layer-3 MAC address on SW2 and SW3.</p>
<p>SW2</p>	<pre>SW2FS# configure terminal SW2#(FS(config)#I3intf-mac-add 0000.0001.2233</pre>
<p>SW3</p>	<pre>SW3FS# configure terminal SW3#(FS(config)#I3intf-mac-add 0000.0001.2233</pre>
<p>SW1</p>	<pre>SW1FS# configure terminal SW1FS(config)# arp 192.168.22.20 0000.0001.2233 arpa</pre>
<p>Verification</p>	<ol style="list-style-type: none"> 1. Run the show I3intf-mac-add command to display the global MAC address configured on SW2 and SW3. 2. Pump traffic and verify that packets from SW1 are routed at layer 3 regardless of whether the next hop of SW1 is SW2 or SW3.
<p>SW2</p>	<pre>SW2(config)#FS#show I3intf-mac-add I3intf mac address: 0000.0001.2235</pre>
<p>SW3</p>	<pre>SW3(config)#FS#show I3intf-mac-add I3intf mac address: 0000.0001.2235</pre>

12.4 Monitoring

Displaying

Description	Command
Displays the configured global layer-3 MAC address of the device.	show I3intf-mac-add

13 Configuring Hardware Capacity Query

13.1 Overview

The FSOS provides the function of querying the hardware capacity and usage of the route forward information database (FIB).

Protocols and Standards

N/A

13.2 Features

Basic Concepts

Route hardware resources are classified into IPv4 and IPv6 route resources by protocol, and are classified into host and network route resources by route prefix.

Route resource allocation varies with the chip hardware type.

- S6220H series, S65 series, and N18000-X DB series

Products of these series use XGS chips. Their route hardware resources consist of the L3_ENTRY, L3_DEFIP, L3_DEFIP_128, and ALPM tables. The L3_ENTRY table can store IPv4/IPv6 host routes. The L3_DEFIP table can store IPv4 and IPv6_64 routes. The L3_DEFIP_128 table can store IPv6 routes with a mask of 65 to 128 bits. The ALPM table can store IPv4/IPv6 routes. IPv4 and IPv6 routes occupy different quantities of hardware entries, and can be converted in the following ways:

Calculation rules for the L3_ENTRY table:

- One IPV4_HOST route occupies one L3_ENTRY entry.
- One IPV4_HOSTFULL route occupies two L3_ENTRY entries.
- One IPV6_HOST route occupies two L3_ENTRY entries.
- One IPV6_HOSTFULL route occupies four L3_ENTRY entries.

Calculation rules for the L3_DEFIP table: (If ALPM is enabled, conversion is not required and the L3_DEFIP entry usage is not displayed.)

- Two IPV4 routes occupy one L3_DEFIP entry. (If there is only one IPv4 route, the IPv4 route also occupies one L3_DEFIP entry.)
- One IPV6_64 route occupies one L3_DEFIP entry.

Calculation rules for the L3_DEFIP_128 table: (If ALPM is enabled, conversion is not required and the L3_DEFIP_128 entry usage is not displayed.)

- One IPV6_128 route occupies one L3_DEFIP_128 entry.

Calculation rules for the ALPM table: (If ALPM is disabled, related ALPM entries are set to 0 and the ALPM entry usage is not displayed.)

- One IPV4 route occupies one ALPM entry.
- One IPV6 route occupies 1.5 ALPM entries when IPV6_128 is disabled.
- One IPV6 route occupies three ALPM entries when IPV6_128 is enabled.

- N18000-X CB series

Fixed capacities are allocated to manage host and network route resources, respectively. IPv4 and IPv6 host routes share host route resources. IPv4 and IPv6 network routes share network route resources. An IPv6 route occupies four times of resources over an IPv4 route. For example, when the total host route resource capacity is 200 K, 200 K IPv4 host routes, 50 K IPv6 host routes, or 100 K IPv4 host routes and 25 K IPv6 host routes are supported.

The network route resource capacity of the N18000-X CB series is determined by the prefix length of installed routes, to provide references for the guarantee capacity (minimum) and theoretical capacity (maximum).

Route tables are hash tables, and hash collisions easily occur. Some hardware resources may be incompletely used.

Verification

Displaying Resource Usage in Standalone Mode

- Run the **show route-res usage slot slot_num** command to display the resource usage.

Command	show route-res usage slot slot_num
Parameter	slot_num: Specifies the ID of the slot in which the line card of the chassis-type device resides, where 0 indicates a box-type device.
Description	
Command Mode	Privileged EXEC mode, global configuration mode, and interface configuration mode
Usage Guide	N/A
Command Presentation	<pre> FS#show route-res usage slot 0 Switch Mode Current:default Switch Mode Next :default ----- L3 Software Statistics: ----- Switch Slot Chip Name Used Description ----- 1 0 0 IPV4_LPM 0 ipv4 route in lpm table 1 0 0 IPV4_HOST 0 ipv4 route in l3_entry table 1 0 0 IPV4_HOSTFULL 0 ipv4 route in l3_entry_double table ----- 1 0 0 IPV6_64_LPM 0 ipv6-64 route in lpm table 1 0 0 IPV6_128_LPM 0 ipv6-65~128 route in lpm table 1 0 0 IPV6_HOST 0 ipv6 route in l3_entry_double 1 0 0 IPV6_HOST_FULL 0 ipv6 route in l3_entry_qual ----- Switch Slot Chip Name Used Max Description ----- 1 0 0 NEXTHOP 0 49152 nexthop number 1 0 0 ECMP_GROUP 0 4096 ecmp group number ----- L3 Forwarding Resources: ----- Switch Slot Chip Resource Service Max Used[%] Remain ----- 1 0 0 L3_ENTRY 212992 0[0%] 212992 1 0 0 IPV4_HOST 0 212992 1 0 0 IPV4_HOSTFULL 0 106496 </pre>

1	0	0	IPV6_HOST	0	106496
1	0	0	IPV6_HOSTFULL	0	53248

1	0	0	L3_DEFIP	6144	0[0%] 6144
1	0	0	IPV4	0	12288
1	0	0	IPV6_64	0	6144

1	0	0	L3_DEFIP_128	1024	0[0%] 1024
1	0	0	IPV6_128	0	1024

📌 **Displaying Resource Usage in VSU Mode**

- Run the **show route-res usage switch switch_num slot slot_num** command to display the resource usage of a line card.

Command	show route-res usage switch switch_num slot slot_num
Parameter Description	<p><i>switch_num</i>: Indicates the device ID of the chassis- or box-type device in VSU mode. In standalone mode, the keyword switch is not displayed.</p> <p><i>slot_num</i>: Specifies the ID of the slot in which the line card of the chassis-type device resides, where 0 indicates a box-type device.</p>
Command Mode	Privileged EXEC mode, global configuration mode, and interface configuration mode
Usage Guide	N/A
Command Presentation	<pre>FS#show route-res usage switch 1 slot 0 Switch Mode Current:default Switch Mode Next :default ----- L3 Software Statistics: ----- Switch Slot Chip Name Used Description ----- 1 0 0 IPV4_LPM 7 ipv4 route in lpm table 1 0 0 IPV4_HOST 9 ipv4 route in l3_entry table 1 0 0 IPV4_HOSTFULL 3 ipv4 route in l3_entry_double table ----- 1 0 0 IPV6_64_LPM 8 ipv6-64 route in lpm table 1 0 0 IPV6_128_LPM 0 ipv6-65~128 route in lpm table 1 0 0 IPV6_HOST 9 ipv6 route in l3_entry_double 1 0 0 IPV6_HOST_FULL 0 ipv6 route in l3_entry_qual ----- Switch Slot Chip Name Used Max Description ----- 1 0 0 NEXTHOP 33 49152 nexthop number 1 0 0 ECMP_GROUP 1 4096 ecmp group number -----</pre>

L3 Forwarding Resources:								
Switch	Slot	Chip	Resource	Service	Max	Used[%]	Remain
1	0	0	L3_ENTRY		212992	33[0%]	212959
1	0	0		IPV4_HOST		9		212959
1	0	0		IPV4_HOSTFULL		3		106479
1	0	0		IPV6_HOST		9		106479
1	0	0		IPV6_HOSTFULL		0		53239
1	0	0	L3_DEFIP		6144	12[0%]	6132
1	0	0		IPV4		7		12264
1	0	0		IPV6_64		8		6132
1	0	0	L3_DEFIP_128		1024	0[0%]	1024
1	0	0		IPV6_128		0		1024

➤ **Displaying Resource Usage of All Slots in Standalone or VSU Mode**

- Run the **show route-res usage all** command to display the resource usage of all line cards.

Command	show route-res usage all
Parameter Description	N/A
Command Mode	Privileged EXEC mode, global configuration mode, and interface configuration mode
Usage Guide	N/A
Command Presentation	N/A

Configuration Example

Verification	Run the show route-res usage slot slot_num command to display the resource usage.
	<pre>FS#show route-res usage slot 1 Switch Mode Current: dual-stack-alm Switch Mode Next : default ----- L3 Software Statistics: ----- Slot Chip Name Used Description ----- 1 0 IPV4_LPM 0 ipv4 route in lpm table 1 0 IPV4_HOST 0 ipv4 route in l3_entry table</pre>

1	0	IPV4_HOSTFULL	0		ipv4 route in l3_entry_double table	
1	0	IPV6_64_LPM	0		ipv6-64 route in lpm table	
1	0	IPV6_128_LPM	0		ipv6-65~128 route in lpm table	
1	0	IPV6_HOST	0		ipv6 route in l3_entry_double	
1	0	IPV6_HOST_FULL	0		ipv6 route in l3_entry_qual	
1	0	NEXTHOP	0	/49152	nexthop number	
1	0	ECMP_GROUP	0	/4096	ecmp group number	
1	0	ENCAP	0	/49152	encap number	

L3 Forwarding Resources:						

Slot	Chip	Resource	Service	Max	Used[%]	Remain

1	0	L3_ENTRY		16384	5[0%]	16379
1	0		IPV4_HOST		1	
1	0		IPV4_HOSTFULL		1	
1	0		IPV6_HOST		1	
1	0		IPV6_HOST_FULL		0	
1	0	L3_DEFIP		14336	2[0%]	14334
1	0		IPV4		2	
1	0		IPV6_64		1	
1	0	L3_DEFIP_128		1024	1[0%]	1023
1	0		IPV6_128		1	
1	0	ALPM		0	0[0%]	383989
1	0		IPV4			
1	0		IPV6_64			
1	0		IPV6_128			

13.3 Monitoring

Clearing

N/A

Displaying

Description	Command
Displays the FIB hardware capacity and usage of a specified switch line card in standalone mode.	show route-res usage slot <i>slot_num</i>
Displays the FIB hardware capacity and usage of a specified switch line card in VSU mode.	show route-res usage switch <i>switch_num</i> slot <i>slot_num</i>
Displays the FIB hardware capacities and usage of all line cards.	show route-res usage all

Debugging

N/A



The preceding **show** commands apply to chassis- and box-type devices in standalone and VSU modes.

Multicast Configuration

1. Configuring IP Multicasting
2. Configuring IPv6 Multicast
3. Configuring IGMP
4. Configuring MLD
5. Configuring PIM-DM
6. Configuring PIM-SM
7. Configuring PIM-SMv6
8. Configuring MSDP
9. Configuring IGMP Snooping
10. Configuration MLD Snooping

14 Configuring IP Multicasting

14.1 Overview

IP multicasting is abstracted hardware multicasting and an extended multicast routing protocol on the standard IP network layer.

In traditional IP transmission, only one host can send packets to a single host (unicast communication) or all hosts (broadcast communication). However, the multicast technology provides the third choice: a host can send packets to certain specified hosts.

IP multicasting is applicable to one-to-many multimedia applications.

14.2 Applications

Application	Description
PIM-DM Applications	The PIM-DM multicast service is provided on the same network.
PIM-SM Applications	The PIM-SM multicast service is provided on the same network.

14.2.1 PIM-DM Applications

Scenario

The PIM-DM multicast service is provided on the same network.

As shown in Figure 1- 1:

- A multicast source sends a multicast packet, and receiver A and receiver B on the same network receive the multicast packet.

Figure 1- 1

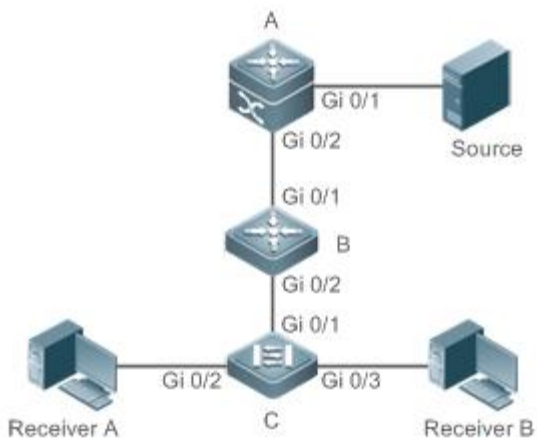

Remarks	A and B are layer-3 devices and C is a layer-2 access device. Source is connected to the Gi 0/1 interface of A, and receiver A and receiver B are connected to the Gi 0/2 and Gi 0/3 interfaces of C.
----------------	--

Deployment

- Run the Open Shortest Path First (OSPF) protocol on the same network to implement unicast routing.
- Run PIM-DM on the same network to implement multicast routing.

- Run the Internet Group Membership Protocol (IGMP) in a user host network segment to implement group member management.

14.2.2 PIM-SM Applications

Scenario

The PIM-SM multicast service is provided on the same network.

As shown in Figure 1-2:

- A multicast source sends a multicast packet, and receiver A and receiver B on the same network receive the multicast packet.

Figure 1-2

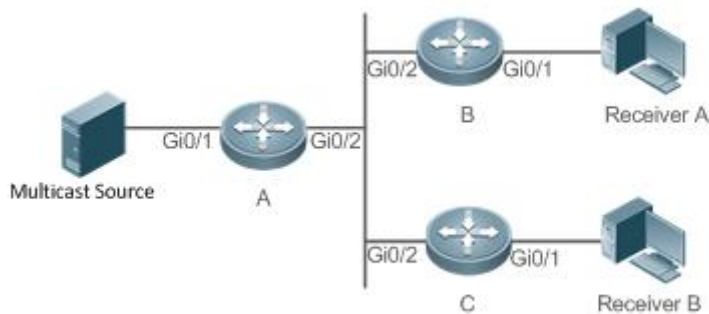

Remarks	<p>A, B, and C are layer-3 routers.</p> <p>The multicast source is connected to the Gi 0/1 interface of A, receiver B is connected to the Gi 0/1 interface of B, and receiver B is connected to the Gi 0/1 interface of C.</p>
----------------	--

Deployment

- Run OSPF on the same network to implement unicast routing.
- Run PIM-SM on the same network to implement multicast routing.
- Run IGMP in a user host network segment to implement group member management.

14.3 Features

Basic Concepts

📌 PIM Routers and PIM Interfaces

Routers enabled with PIM are called PIM routers. Interfaces enabled with PIM protocol are called PIM interfaces.

Multicast packets are forwarded on PIM routers. The PIM interfaces for receiving multicast packets are called upstream interfaces, and the PIM interfaces for sending multicast packets are called downstream interfaces.

The network segments where upstream interfaces are located are called upstream network segments. The network segments where downstream interfaces are located are called downstream network segments.

📌 PIM Network and PIM Domain

PIM routers are connected through PIM interfaces and form a PIM network.

On certain PIM interfaces, borders are configured to divide a large PIM network into multiple PIM domains. Borders may reject specified multicast packets or limit transmission of PIM messages.

➤ **Multicast Distribution Tree, DR and RP**

Multicast packets are transmitted from one point to multiple points. The forwarding path is in a tree structure. This forwarding path is called a multicast distribution tree (MDT) and has the following types:

- Rendezvous Point Tree (RPT): The RP is regarded as the root and the designated router (DR) that connects group members is regarded as a leaf.
- Shortest Path Tree (SPT): The DR that connects multicast sources is regarded as the root, and RP or DR that connects group members is regarded as a leaf.

The DR and RP are functional roles for a PIM router.

- The RP collects multicast sources and group member information on the network.
- The DR that connects multicast sources reports multicast source information to the RP. The DR that connects group members reports group member information to the RP.

➤ **(*G) and (S,G)**

- (*G): Packets sent from any source to group G, routing entries corresponding to the packets, and forwarding path (RPT) corresponding to the packets.
- (S,G): Packets sent from source S to group G, routing entries corresponding to the packets, and forwarding path (SPT) corresponding to the packets.

➤ **ASM and SSM**

PIM-SM supports the following multicast models that are applicable to different multicast address segments:

- Any-Source Multicast (ASM): In the ASM model, user hosts cannot select multicast sources. User hosts join a group and receive packets sent from all sources to the group.
- Source-Specific Multicast (SSM): In the SSM model, user hosts can select multicast sources. User hosts specify source addresses when joining a group and receive only packets sent from specified sources to the group.

i SSM model requirements: User hosts must know the multicast source address in advance using other network services so that the hosts can select multicast sources.

Overview

Feature	Description
Configuring Basic Functions of IP Multicasting	Creates a PIM network and provides data sources and user terminals on the network with the IPv4 multicast service.
Configuring a TTL Threshold	Configures a TTL threshold for an interface, that is, the minimum TTL value of multicast packets allowed on an interface.
Configuring the Number of Entries That Can Be Added to the Multicast Routing Table	Limits the number of entries that can be added to the multicast routing table.

Feature	Description
Configuring an IP Multicasting Border	Configures an interface as a multicast border for a specified group.
Configuring an IP Multicasting Static Route	Allows the multicast forwarding path to be different from the unicast path.
Configuring Layer-2 Direction Control for Multicast Streams	Allows a specified multicast stream to be configured with multiple commands, that is, to be configured with multiple ports that can forward the stream. Once direction control is configured for a multicast stream, the stream can be forwarded only by these configured interfaces. Other interfaces are not permitted to forward the stream.
Configuring RPF Route Selection Based on the Longest Match Rule	Selects an optimal route respectively from the multicast static routing table, MBGP routing table, and unicast routing table according to RPF rules. Among these three routes, the one with the longest match mask is selected as the RPF route.
Configuring Multicast Non-Stop Forwarding Parameters	During normal running, SSP synchronizes the hardware multicast forwarding table to the management board in real time. After the management board is switched, the command for configuring the multicast control plane of the original slave management board is loaded, and the multicast protocol (such as PIM-SM or IGMP Snooping) re-converges. The multicast non-stop forwarding function ensures continuous forwarding of multicast data streams during re-convergence of the multicast protocol.
Configuring an Overwriting Mechanism Upon Overflow of Multicast Hardware Forwarding Entries	Deletes the earliest hardware entries and adds new entries if the hardware forwarding table overflows when you create multicast forwarding entries.

14.3.1 Configuring Basic Functions of IP Multicasting

Create a PIM network and provide data sources and user terminals on the network with the IPv4 multicast service.

Working Principle

A device maintains the routing table for forwarding multicast packets through multicast routing protocols (such as PIM-DM or PIM-SM) and learns the states of group members in the directly connected network segment through IGMP. A host sends IGMP Report messages to join a specified IGMP group.

Related Configuration

📌 Enabling IPv4 Multicast Routing

By default, IPv4 multicast routing is disabled.

Run **ip multicast-routing** to enable IPv4 multicast routing.

📌 Configuring IP Multicasting on an Interface

By default, IP multicasting is disabled on an interface.

Run **ip pim sparse-mode** or **ip pim dense-mode** to enable IP multicasting on an interface.

14.3.2 Configuring a TTL Threshold

Configure a TTL threshold for an interface, that is, the minimum TTL value of multicast packets allowed on an interface.

Working Principle

Configure a TTL threshold for an interface and check the TTL values of multicast packets. Multicast packets whose TTL values are larger than the TTL threshold of the interface are forwarded and those whose TTL values are smaller are discarded.

Related Configuration

📌 Configuring a TTL Threshold

By default, the TTL threshold of an interface is 0.

Run **ip multicast ttl-threshold *ttl-value*** to change the TTL threshold of an interface. The value ranges from 0 to 255.

A larger value of *ttl-value* means a larger TTL value of multicast packets to be forwarded.

14.3.3 Configuring the Number of Entries That Can Be Added to the Multicast Routing Table

Each multicast data packet received on the device maintains a corresponding IP multicast route forwarding entry. However, excess multicast routing entries may exhaust device memory and deteriorate device performance. You can limit the number of entries in the IP multicast routing table based on the actual network and service performance requirements.

Working Principle

The number of entries in the IP multicasting routing table is limited based on the actual network and service performance requirements to ensure device performance.

Related Configuration

📌 Configuring the Number of Entries That Can Be Added to the Multicast Routing Table

By default, a maximum of 1024 entries can be added to an IP multicast routing table.

Run **ip multicast route-limit *limit* [*threshold*]** to change the number of entries that can be added to the IP multicasting routing table. The value ranges from 1 to 65536.

A larger value of *limit* means a larger number of entries that can be added to the IP multicasting routing table.

14.3.4 Configuring an IP Multicasting Border

Configure an IP multicasting border to specify the transmission range of multicast packets.

Working Principle

An IP multicasting border is configured to specify the transmission range of multicast packets. When an IP multicasting border is configured on an interface, this interface cannot forward or receive multicast packets, including those sent from the local host.

Related Configuration

📌 Configuring an IP Multicasting Border

By default, no IP multicasting border is configured.

Run **ip multicast boundary *access-list* [*in* | *out*]** to configure an IP multicasting border.

14.3.5 Configuring an IP Multicasting Static Route

Configure an IP multicasting static route to specify an RPF interface or RPF neighbor for multicast packets from specified multicast sources.

Working Principle

An RPF check is performed once multicast packets are forwarded. An IP multicasting static route can be configured to specify an RPF interface or RPF neighbor for multicast packets from specified multicast sources.

Related Configuration

📌 Configuring an IP Multicasting Static Route

By default, no IP multicasting static route is configured.

Run **ip mroute** *source-address mask* { [**bgp** | **isis** | **ospf** | **rip** | **static**] { *v4rpf-address* | *interface-type interface-number* } } [*distance*] to configure an IP multicasting static route.

14.3.6 Configuring Layer-2 Direction Control for Multicast Streams

Configure layer-2 direction control for multicast streams to control the forwarding of multicast streams on an interface.

Working Principle

Configure layer-2 direction control for multicast streams and a forwarding interface so that multicast streams can be forwarded only through configured interfaces. In this case, layer-2 forwarding of multicast streams can be controlled.

Related Configuration

📌 Configuring Layer-2 Direction Control for Multicast Streams

By default, layer-2 direction control for multicast streams is disabled.

Run **ip multicast static** *source-address group-address interface-type interface-number* to configure layer-2 direction control for multicast streams.

14.3.7 Configuring RPF Route Selection Based on the Longest Match Rule

Select an optimal route respectively from the multicast static routing table, MBGP routing table, and unicast routing table and select the one with the longest match mask as the RPF route from the three optimal routes.

Working Principle

A multicast static route, an MBGP route, and a unicast route that can be used for RPF check are selected respectively from the multicast static routing table, MBGP routing table, and unicast routing table according to RPF rules.

- If the longest match rule is used, the route with the longest match mask is selected as the RPF route. If the three routes have the same mask, the one with the highest priority is selected as the RPF route. If they have the same priority, the RPF routes are selected in the sequence of multicast static route, MBGP route, and unicast route.
- Otherwise, the one with the highest priority is selected as the RPF route. If they have the same priority, the RPF routes are selected in the sequence of multicast static route, MBGP route, and unicast route.

Related Configuration

✚ **Configuring RPF Route Selection Based on the Longest Match Rule**

By default, the route with the highest priority is selected as the RPF route. If they have the same priority, the RPF routes are selected in the sequence of multicast static route, MBGP route, and unicast route.

Run **ip multicast rpf longest-match** to configure RPF route selection based on the longest match rule.

14.3.8Configuring Multicast Non-Stop Forwarding Parameters

The non-stop forwarding function ensures continuous forwarding of multicast data streams during the re-convergence of multicast protocols.

Working Principle

During normal running, SSP synchronizes the hardware multicast forwarding table to the management board in real time. After the management board is switched, the command for configuring the multicast control plane of the original slave management board is loaded, and the multicast protocol (such as PIM-SM or IGMP Snooping) re-converges. The multicast non-stop forwarding function ensures continuous forwarding of multicast data streams during re-convergence of multicast protocols.

After the configured protocol convergence period times out, all multicast forwarding table entries that are not updated during the convergence period are deleted.

Related Configuration

✚ **Configuring the Maximum Period for Multicast Protocol Convergence**

By default, the maximum period for multicast protocol convergence is 20s.

Run **msf nsf convergence-time time** to configure the maximum period for multicast protocol convergence. The value ranges from 0 to 3600s.

A larger value of *time* means a longer maximum period for multicast protocol convergence.

✚ **Configuring the Multicast Packet Leakage Period**

By default, the multicast packet leakage period is 30s.

Run **msf nsf leak interval** to configure the multicast packet leakage period. The value ranges from 0 to 3600s.

A larger value of *interval* means a longer leakage period.

14.3.9Configuring an Overwriting Mechanism Upon Overflow of Multicast Hardware Forwarding Entries

Delete the earliest hardware entries and adds new entries if the hardware forwarding table overflows when you create multicast forwarding entries.

Working Principle

Delete the earliest hardware entries and adds new entries if the hardware forwarding table overflows when you create multicast forwarding entries .

Related Configuration

✚ **Configuring an Overwriting Mechanism Upon Overflow of Multicast Hardware Forwarding Entries**

By default, the overwriting mechanism upon the overflow of multicast hardware forwarding entries is disabled.

Run **msf ipmc-overflow override** to configure the overwriting mechanism upon overflow of multicast hardware forwarding entries.

14.4 Configuration

Configuration	Description and Command
Configuring Basic Functions of IP Multicasting	(Mandatory) It is used to configure the multicast service.
	ip multicast-routing Enables the IPv4 multicast routing function.
Configuring a TTL Threshold	Optional.
	ip multicast ttl-threshold <i>ttl-value</i> Configures a TTL threshold for an interface.
Configuring the Number of Entries That Can Be Added to the Multicast Routing Table	ip multicast route-limit <i>limit [threshold]</i> Limits the number of entries that can be added to the multicast routing table.
Configuring an IP Multicasting Border	ip multicast boundary <i>access-list [in out]</i> Configures an interface as a multicast border for a specified group.
Configuring an IP Multicasting Static Route	ip mroute <i>source-address mask { [bgp isis ospf rip static] { v4rpf-address interface-type interface-number } } [distance]</i> Configures an IP multicasting static route.
Configuring Layer-2 Direction Control for Multicast Streams	ip multicast static <i>source-address group-address interface-type interface-number</i> Controls the direction of data streams on layer-2 interfaces.
Configuring RPF Route Selection Based on the Longest Match Rule	ip multicast rpf longest-match Configures RPF route selection based on the longest match rule.
Configuring Multicast Non-Stop Forwarding Parameters	msf nsf convergence-time <i>time</i> Configures the maximum period for multicast protocol convergence.
	msf nsf leak <i>time</i> Configures the multicast packet leakage period.
Configuring an Overwriting Mechanism Upon Overflow of Multicast Hardware Forwarding Entries	msf ipmc-overflow override Configures the overwriting mechanism upon overflow of multicast hardware forwarding entries.

14.4.1 Configuring Basic Functions of IP Multicasting

Configuration Effect

- Create a PIM network and provide data sources and user terminals on the network with the IPv4 multicast service.

Notes

- A PIM network needs to use existing unicast routes on the network. Therefore, IPv4 routes must be configured on the network.

Configuration Steps

📌 Enabling IPv4 Multicast Routing

- Mandatory.
- IPv4 multicast routing should be enabled on each router unless otherwise specified.

➤ **Enabling IP Multicasting for an Interface**

- Mandatory.
- IP multicasting protocol should be enabled on interfaces unless otherwise specified:

Verification

Enable multicast sources to send multicast packets and user hosts to join the groups.

- Check whether the user hosts can successfully receive packets from each group.

Related Commands

➤ **Enabling IPv4 Multicast Routing**

Command	ip multicast-routing
Parameter	N/A
Description	
Command Mode	Global configuration mode
Usage Guide	-

➤ **Configuring IP Multicasting**

- For IGMP configuration, see the IGMP section.
- For PIM-DM configuration, see the PIM-DM section.
- For PIM-SM configuration, see the PIM-SM section.
- After layer-3 multicasting is enabled in the private VLAN and super VLAN and a multicast source exists in the sub-VLAN, an extra entry whose ingress is the sub-VLAN into which the multicast stream enters needs to be copied due to the validity check during multicast forwarding. This results in occupation of one more multicast hardware entry and one less in the multicast capacity.

➤ **Displaying Information About the Multicast Forwarding Table**

Command	show ip mroute [group-or-source-address [group-or-source-address]] [dense sparse] [summary count]
Parameter Description	<p><i>group-or-source-address</i>: Specifies a group address or source address.</p> <p><i>group-or-source-address</i>: Specifies a group address or source address.</p> <p>dense: Displays the core entry of PIM-DM multicast.</p> <p>sparse: Displays the core entry of PIM-SM multicast.</p> <p>summary: Displays summary information about multicast routing entries.</p> <p>count: Displays counting information about multicast routing entries.</p>
Command Mode	Privilege, global and interface configuration modes
Usage Guide	<p>The three parameters are optional, and the source address and group address must be specified simultaneously.</p> <p>When no source address or group address is specified, all MFC entries are displayed.</p> <p>When only the source address and group address are specified, MFC entries of the source address and group address are displayed.</p>

Configuration Example

Creating the IP Multicast Service on the IPv4 Network and Supporting PIM-DM

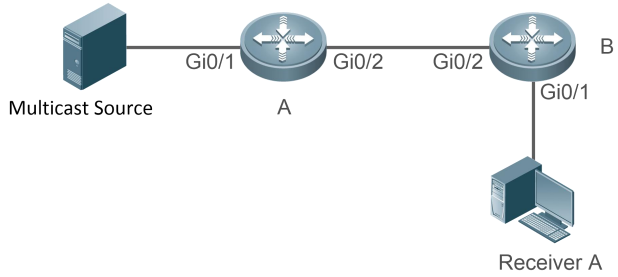
<p>Scenario Figure 1-3</p>	
<p>Configuration Steps</p>	<ul style="list-style-type: none"> ● Configure an IPv4 unicast routing protocol (such as OSPF) on a router. ● Enable IPv4 multicast routing on all routers. ● Enable PIM-DM on device interconnection interfaces and interfaces for connecting user hosts and multicast sources.
<p>A</p>	<pre>A# configure terminal A(config)# ip multicast-routing A(config)# interface GigabitEthernet 0/1 A(config-if)# ip pim dense-mode A(config-if)# exit A(config)# interface GigabitEthernet 0/2 A(config-if)# ip pim dense-mode A(config-if)# exit</pre>
<p>B</p>	<pre>B# configure terminal B(config)# ip multicast-routing B(config)# interface GigabitEthernet 0/1 B(config-if)# ip pim dense-mode B(config-if)# exit B(config)# interface GigabitEthernet 0/2 B(config-if)# ip pim dense-mode B(config-if)# exit</pre>
<p>Verification</p>	<p>Enable the multicast source (192.168.1.100) to send packets to G (233.3.3.3). Enable receiver A to join G.</p> <ul style="list-style-type: none"> ● Check multicast packets received by receiver A. Receiver A should be able to receive multicast packets from G. ● Check multicast forwarding tables on A and B.

A	<pre> A# show ip mroute IP Multicast Routing Table Flags: I - Immediate Stat, T - Timed Stat, F - Forwarder installed, R - RPT, S - SPT, s - SSM Group Timers: Uptime/Stat Expiry Interface State: Interface (TTL) (192.168.1.100, 233.3.3.3), uptime 00:01:55, stat expires 00:02:19 Owner PIMDM, Flags: TFS Incoming interface: GigabitEthernet 0/1 Outgoing interface list: GigabitEthernet 0/2 (1) </pre>
B	<pre> B# show ip mroute IP Multicast Routing Table Flags: I - Immediate Stat, T - Timed Stat, F - Forwarder installed, R - RPT, S - SPT, s - SSM Group Timers: Uptime/Stat Expiry Interface State: Interface (TTL) (192.168.1.100, 233.3.3.3), uptime 00:00:35, stat expires 00:02:55 Owner PIMDM, Flags: TFS Incoming interface: GigabitEthernet 0/2 Outgoing interface list: GigabitEthernet 0/1 (1) </pre>

Common Errors

- An IPv4 unicast route is incorrectly configured.
- IPv4 multicast routing is not enabled on a router.
- IP multicasting is not enabled on an interface.

14.4.2Configuring a TTL Threshold

Configuration Effect

- Configure a TTL threshold for an interface and check the TTL values of multicast packets. Multicast packets whose TTL values are larger than the TTL threshold of the interface are forwarded and those whose TTL values are smaller are discarded.

Notes

- The basic functions of IP multicasting must be configured.

Configuration Steps

- Set a TTL threshold on PIM router interfaces unless otherwise specified.

Verification

Enable multicast sources to send multicast packets and user hosts to join the groups.

- Set a TTL threshold to a value that is larger than the TTL value of the multicast packet on the PIM router interface directly connected to the user host and check whether the user can receive the multicast packet.

Related Commands

▾ **Configuring a TTL Threshold**

Command	ip multicast ttl-threshold <i>ttl-value</i>
Parameter Description	<i>ttl-value</i> : Specifies a TTL threshold for an interface. The value ranges from 0 to 255. The default value is 0.
Command Mode	Interface configuration mode
Usage Guide	A multicast-enabled device can retain a TTL threshold for each interface. Multicast packets whose TTL values are larger than the TTL threshold of the interface are forwarded and those whose TTL values are smaller are discarded. A TTL threshold takes effect only for multicast frames and must be configured on layer-3 interfaces.

Configuration Example

▾ **Creating the IP Multicast Service on the IPv4 Network and Configuring a TTL Threshold**

<p>Scenario Figure 1-4</p>	
<p>Configuration Steps</p>	<ul style="list-style-type: none"> ● Configure the basic functions of IP multicasting. (Omitted) ● Configure the TTL threshold as 100 on the Gi 0/2 interface of device A.
<p>A</p>	<pre>A# configure terminal A(config)#int gigabitEthernet 0/2</pre>

	<pre>A(config-if-GigabitEthernet 0/2)#ip multicast ttl-threshold 100 A(config-if-GigabitEthernet 0/2)# exit</pre>
<p>Verification</p>	<p>Enable the multicast source (192.168.1.100) to send packets to G (233.3.3.3). Enable receiver A to join G.</p> <ul style="list-style-type: none"> ● Configure the TTL threshold as 100 on the Gi 0/2 interface of device A, which is larger than the TTL value of the multicast packet. ● Check the difference between the route forwarding entries before and after the TTL threshold is configured.
<p>Before Configuring the TTL Threshold</p>	<pre>A# show ip mroute IP Multicast Routing Table Flags: I - Immediate Stat, T - Timed Stat, F - Forwarder installed, R - RPT, S - SPT, s - SSM Group Timers: Uptime/Stat Expiry Interface State: Interface (TTL) (192.168.1.100, 233.3.3.3), uptime 00:00:08, stat expires 00:03:29 Owner PIMDM, Flags: TFS Incoming interface: GigabitEthernet 0/1 Outgoing interface list: GigabitEthernet 0/2 (1)</pre>
<p>After Configuring the TTL Threshold</p>	<pre>A# show ip mroute IP Multicast Routing Table Flags: I - Immediate Stat, T - Timed Stat, F - Forwarder installed, R - RPT, S - SPT, s - SSM Group Timers: Uptime/Stat Expiry Interface State: Interface (TTL) (192.168.1.100, 233.3.3.3), uptime 00:00:01, stat expires 00:03:29 Owner PIMDM, Flags: TFS Incoming interface: GigabitEthernet 0/1 Outgoing interface list: GigabitEthernet 0/2 (100)</pre>

14.4.3 Configuring the Number of Entries That Can Be Added to the Multicast Routing Table

Configuration Effect

- Each multicast data packet received on the device maintains a corresponding IP multicast route forwarding entry. However, excess multicast routing entries may exhaust device memory and deteriorate device performance. You can limit the number of entries in the IP multicast routing table based on the actual network and service performance requirements.

Notes

- The basic functions of IP multicasting must be configured.

Configuration Steps

- Limit the number of entries in the IP multicast routing table based on the actual network and service performance requirements.

Verification

Send N groups of multicast packets from the multicast source on the network, configure user hosts to join the groups, configure the number of entries that can be added to the IP multicast routing table as N-1, and check whether the multicast packet received by the user host is that of the N-1 group.

Related Commands

Configuring the Number of Entries That Can Be Added to the Multicast Routing Table

Command	<code>ip multicast route-limit limit [threshold]</code>
Parameter Description	<p><i>limit</i>: Specifies the number of entries in the multicast routing table. The value ranges from 1 to 65536. The default value is 1024.</p> <p><i>threshold</i>: Specifies the number of entries in the multicast routing table that triggers the warning message. The default value is 65536.</p>
Command Mode	Global configuration mode
Usage Guide	Due to limitations on hardware resources, routing entries that exceed the range permitted by hardware can be forwarded only by software, deteriorating the performance.

Configuration Example

Creating the IP Multicast Service on the IPv4 Network and Configuring the Number of Entries That Can Be Added to the Multicast Routing Table

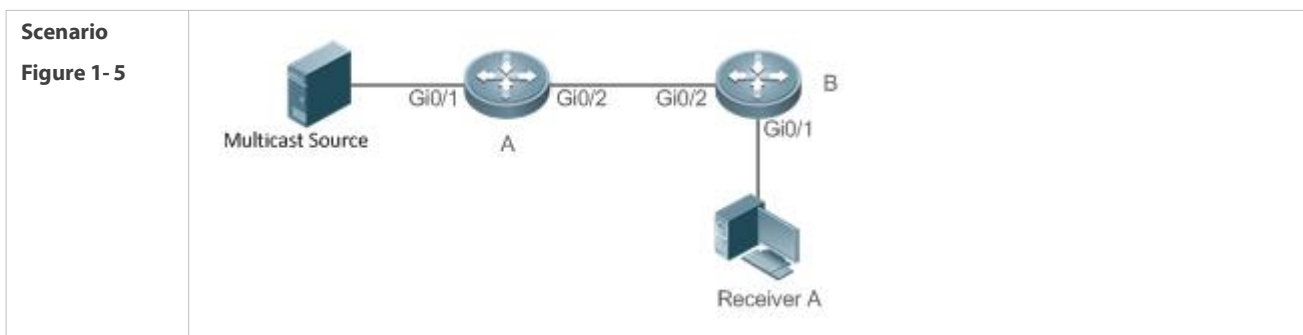

<p>Configuration Steps</p>	<ul style="list-style-type: none"> ● Configure basic the functions of IP multicasting. (Omitted) ● Configure the number of entries that can be added to the multicast routing table on device B as 2.
<p>B</p>	<pre>B# configure terminal B(config)# ip multicast route-limit 2</pre>
<p>Verification</p>	<p>Enable the multicast source (192.168.1.100) to send packets to G1 (233.3.3.1), G2 (233.3.3.2), and G3 (233.3.3.3).Enable receiver A to join G1, G2, and G3.</p> <ul style="list-style-type: none"> ● Check multicast packets received by receiver A. Receiver A should be able to receive multicast packets from two groups among G1, G2, and G3. ● Check multicast routing entries on A and B. ● When the number of entries in the IP multicasting routing table reaches the upper threshold, a prompt message is displayed.
<p>A</p>	<pre>A# show ip mroute IP Multicast Routing Table Flags: I – Immediate Stat, T – Timed Stat, F – Forwarder installed, R – RPT, S – SPT, s – SSM Group Timers: Uptime/Stat Expiry Interface State: Interface (TTL) (192.168.1.100, 233.3.3.1), uptime 00:00:06, stat expires 00:03:24 Owner PIMDM, Flags: TFS Incoming interface: GigabitEthernet 0/1 Outgoing interface list: GigabitEthernet 0/2 (1) (192.168.1.100, 233.3.3.2), uptime 00:00:05, stat expires 00:03:25 Owner PIMDM, Flags: TFS Incoming interface: GigabitEthernet 0/1 Outgoing interface list: GigabitEthernet 0/2 (1) (192.168.1.100, 233.3.3.3), uptime 00:00:00, stat expires 00:03:30 Owner PIMDM, Flags: TFS</pre>

	<p>Incoming interface: GigabitEthernet 0/1</p> <p>Outgoing interface list:</p> <p>GigabitEthernet 0/2 (1)</p>
<p>B</p>	<pre> B# show ip mroute IP Multicast Routing Table Flags: I – Immediate Stat, T – Timed Stat, F – Forwarder installed, R – RPT, S – SPT, s – SSM Group Timers: Uptime/Stat Expiry Interface State: Interface (TTL) (192.168.1.100, 233.3.3.1), uptime 00:01:13, stat expires 00:03:23 Owner PIMDM, Flags: TFS Incoming interface: GigabitEthernet 0/2 Outgoing interface list: GigabitEthernet 0/1 (1) (192.168.1.100, 233.3.3.3), uptime 00:06:08, stat expires 00:03:23 Owner PIMDM, Flags: TFS Incoming interface: GigabitEthernet 0/2 Outgoing interface list: GigabitEthernet 0/1 (1) </pre>
	<p>When the number of entries in the IP multicasting routing table reaches the upper threshold, a prompt message is displayed.</p> <pre> B#*Dec 26 10:43:07: %MROUTE-4-ROU TELIMIT: IPv4 Multicast route limit 2 exceeded - VRF default. </pre>

Common Errors

- An IPv4 unicast route is incorrectly configured.

14.4.4Configuring an IP Multicasting Border

Configuration Effect

- Configure an IP multicasting border to specify the transmission range of multicast packets.

Notes

- The basic functions of IP multicasting must be configured.

Configuration Steps

- Configure an IP multicasting border on PIM router interfaces unless otherwise specified.

Verification

Enable multicast sources to send multicast packets and user hosts to join the groups. Configure an IP multicasting border on the PIM router interface connected to the user host and check whether the user can receive the multicast packet.

Related Commands

📌 **Enabling IPv4 Multicast Routing**

Command	ip multicast boundary <i>access-list</i> [in out]
Parameter	<i>access-list</i> : Indicates the group address range defined by ACL.
Description	in : Indicates that the IP multicasting border takes effect in the incoming direction of the multicast stream. out : Indicates that the IP multicasting border takes effect in the outgoing direction of the multicast stream.
Command Mode	Interface configuration mode
Usage Guide	After this command is executed, IGMP and PIM-SM packets in the group range are filtered on this interface and multicast data streams are not going in and out through this interface. The ACL associated with this command can be a standard ACL or an extended ACL. For extended ACLs, only the destination address is matched and the source address is matched.

Configuration Example

📌 **Creating the IP Multicast Service on the IPv4 Network and Configuring an IP Multicasting Border**

<p>Scenario Figure 1-6</p>	
<p>Configuration Steps</p>	<ul style="list-style-type: none"> ● Configure the basic functions of IP multicasting. (Omitted) ● Configure an ACL on device A. ● Configure an IP multicasting border on the Gi 0/1 interface of device A.
<p>A</p>	<pre>A# configure terminal A(config)#ip access-list standard ip_multicast A(config-std-nacl)#deny any A(config-std-nacl)#exit A(config)# interface GigabitEthernet 0/1 A(config-if-GigabitEthernet 0/1)#ip multicast boundary ip_multicast A</pre>

	A(config-if-GigabitEthernet 0/1)# exit
Verification	Enable the multicast source (192.168.1.100) to send packets to G (233.3.3.3). Enable receiver A to join G. <ul style="list-style-type: none"> ● Run debug ip pim sparse-mode events.
A	<pre>A# debug ip pim sparse-mode events Jan 1 20:58:34: %7: VRF(0): No cache message: src 192.168.1.100 for 233.3.3.3 vif 2 *Jan 1 20:58:34: %7: VRF(0): Ignore No cache message: src 192.168.1.100 for 233.3.3.3 vif 2 in PIM_BOUNDARY_FLT_BOTH range</pre>

Common Errors

- An IPv4 unicast route is incorrectly configured.

14.4.5 Configuring an IP Multicasting Static Route

Configuration Effect

- Configure an IP multicasting static route to specify an RPF interface or RPF neighbor for multicast packets from specified multicast sources.

Notes

- The basic functions of IP multicasting must be configured.

Configuration Steps

- An IP multicasting static route can be configured on each device unless otherwise specified.

Verification

Run **show ip rpf source-address** to check the RPF information of a specified source.

Related Commands

↘ Configuring Basic Functions of IP Multicasting

Command	ip mroute <i>source-address mask</i> { [bgp isis ospf rip static] { <i>v4rpf-address</i> <i>interface-type interface-number</i> } } [<i>distance</i>]
Parameter Description	<p><i>source-address</i>: Specifies the multicast source address.</p> <p><i>mask</i>: Specifies the mask of the multicast source address.</p> <p><i>protocol</i>: Indicates the unicast routing protocol currently used.</p> <p><i>rpf-address</i>: Specifies the address of the RPF neighbor (next hop of the multicast source).</p> <p><i>interface-type interface-number</i>: Indicates the RPF interface (outgoing interface of the multicast source).</p> <p><i>distance</i>: Specifies the route management distance. The value ranges from 0 to 255. The default value is 0.</p>
Command Mode	Global configuration mode
Usage Guide	Multicast static routes are applicable only to RPF check.

	If the IP address of the outgoing interface, but not the next hop, of the static multicast route needs to be specified, the outgoing interface must be a point-to-point type.
--	---

📌 **Displaying the RPF Information of a Specified Source Address**

Command	<code>show ip rpf source-address</code>
Parameter Description	<i>source-address</i> : Specifies the source IP address.
Command Mode	Privilege, global and interface configuration modes
Usage Guide	The three parameters are optional, and the source address and group address must be specified simultaneously. When no source address or group address is specified, all MFC entries are displayed. When only the source address and group address are specified, MFC entries of the source address and group address are displayed.

Configuration Example

📌 **Creating the IP Multicast Service on the IPv4 Network and Supporting PIM-DM**

Scenario Figure 1-7	
Configuration Steps	<ul style="list-style-type: none"> ● Configure the basic functions of IP multicasting. (Omitted) ● Configure a static route to the receiver on device B.
A	<pre>B# configure terminal B(config)# ip mroute 10.10.10.10 255.255.255.255 ospf 192.168.1.1 1</pre>
Verification	Run <code>show ip rpf</code> to view the RPF information to the receiver before and after the configuration.
Before Configuration	<pre>B# show ip rpf 10.10.10.10 RPF information for 10.10.10.10 RPF interface: GigabitEthernet 0/2 RPF neighbor: 192.168.2.1 RPF route: 10.10.10.10/32 RPF type: unicast (ospf) RPF recursion count: 0 Doing distance-preferred lookups across tables Distance: 110 Metric: 1</pre>

After Configuration	<pre> B# show ip rpf 10.10.10.10 RPF information for 10.10.10.10 RPF interface: GigabitEthernet 0/0 RPF neighbor: 192.168.1.1 RPF route: 10.10.10.10/32 RPF type: static RPF recursion count: 0 Doing distance-preferred lookups across tables Distance: 1 Metric: 0 </pre>
----------------------------	---

Common Errors

- An IPv4 unicast route is incorrectly configured.
- IPv4 multicast routing is not enabled on a device.

14.4.6 Configuring Layer-2 Direction Control for Multicast Streams

Configuration Effect

Configure layer-2 direction control for multicast streams to control the forwarding of multicast streams on an interface.

Notes

- The basic functions of IP multicasting must be configured.

Configuration Steps

- Layer-2 direction control for multicast streams can be configured on layer-2 devices unless otherwise specified.

Verification

Send multicast packets on the network containing layer-2 device A, connect multiple user hosts to VLAN 1 of layer-2 device A to receive the group, configure layer-2 direction control for multicast streams on device A, and check whether multicast packets are sent to the configured layer-2 interface.

Related Commands

↘ Configuring Layer-2 Direction Control for Multicast Streams

Command	ip multicast static <i>source-address group-address interface-type interface-number</i>
Parameter Description	<i>source-address</i> : Specifies the multicast source address. <i>group-address</i> : Specifies the multicast group address. <i>interface-type interface-number</i> : Specifies a layer-2 interface that is allowed to forward the multicast flow.
Command Mode	Global configuration mode
Usage Guide	Allow a specified multicast flow to be configured with multiple commands, that is, to be configured with multiple

interfaces. Once direction control is configured for a multicast stream, the stream can be forwarded only by these configured interfaces. Other interfaces are not permitted to forward the stream.

This command controls only the forwarding of multicast streams on the interface, but does not directly affect the processing of multicast protocols on the protocol packets. However, since certain features of the multicast protocol are driven by multicast data streams, behaviors of the multicast routing protocols may also be affected.

Configuration Example

Creating the IP Multicast Service on the IPv4 Network and Configuring Layer-2 Direction Control for Multicast Streams

<p>Scenario Figure 1- 8</p>	
<p>Configuration Steps</p>	<ul style="list-style-type: none"> ● Configure the basic functions of IP multicasting. (Omitted) ● Configure layer-2 direction control for multicast streams on device B so that the streams are sent only to the Gi0/2 interface.
<p>B</p>	<pre>A# configure terminal A(config)# ip multicast static 192.168.1.100 233.3.3.3 gigabitEthernet0/2</pre>
<p>Verification</p>	<p>Enable the multicast source (192.168.1.100) to send packets to G (233.3.3.1). Enable receivers A and B to join G.</p> <ul style="list-style-type: none"> ● Check multicast packets received by receiver A. Receiver B should not be able to receive multicast packets from G.

Common Errors

- An IPv4 unicast route is incorrectly configured.

14.4.7Configuring RPF Route Selection Based on the Longest Match Rule

Configuration Effect

- Select an optimal route respectively from the multicast static routing table, MBGP routing table, and unicast routing table and select the one with the longest match mask as the RPF route from the three optimal routes.

Notes

- The basic functions of IP multicasting must be configured.

Configuration Steps

- Configure RPF route selection based on the longest match rule on each device unless otherwise specified.

Verification

Configure a multicast static route and a unicast static route to have the same priority and configure the unicast static route to have a longer mask length.

- Run **show ip rpf source-address** to check the RPF information of a specified source.

Related Commands

Configuring RPF Route Selection Based on the Longest Match Rule

Command	ip multicast rpf longest-match
Parameter	N/A
Description	
Command Mode	Global configuration mode
Usage Guide	<p>The steps for selecting RPF routes are as follows:</p> <ol style="list-style-type: none"> 1, Select an optimal route respectively from the multicast static routing table, MBGP routing table, and unicast routing table for RPF check. 2, Select one from the three routes as the RPF route. <p>If the longest match rule is used, the route with the longest match mask is selected. If the three routes have the same mask, the one with the highest priority is selected. If they have the same priority, the RPF routes are selected in the sequence of multicast static route, MBGP route, and unicast route.</p> <p>If the longest match rule is not used, the route with the longest match mask is selected. If they have the same priority, the RPF routes are selected in the sequence of multicast static route, MBGP route, and unicast route.</p>

Configuration Example

Creating the IP Multicast Service on the IPv4 Network and Configuring RPF Route Selection Based on the Longest Match Rule

<p>Scenario</p> <p>Figure 1-9</p>	
<p>Configuration Steps</p>	<ul style="list-style-type: none"> ● Configure the basic functions of IP multicasting. (Omitted) ● On device B, configure an IP multicast static route whose mask length is smaller than that of the unicast static route. ● Configure RPF route selection based on the longest match rule on device B.
<p>B</p>	<pre> B# configure terminal B(config)# ip multicast-routing B(config)# ip mroute 10.10.10.10 255.255.0.0 ospf 192.168.1.1 B(config)# ip multicast rpf longest-match </pre>

Verification	Run show ip rpf to check the RFP information of the multicast source before and after configuring RPF route selection based on the longest match rule.
Before configuration	<pre> B#show ip rpf 10.10.10.10 RPF information for 10.10.10.10 RPF interface: GigabitEthernet 0/0 RPF neighbor: 192.168.1.1 RPF route: 10.10.0.0/16 RPF type: static RPF recursion count: 0 Doing distance-preferred lookups across tables Distance: 0 Metric: 0 </pre>
After configuration	<pre> B# show ip rpf 10.10.10.10 RPF information for 10.10.10.10 RPF interface: GigabitEthernet 0/2 RPF neighbor: 192.168.2.1 RPF route: 10.10.10.10/32 RPF type: unicast (ospf) RPF recursion count: 0 Doing prefix-length-preferred lookups across tables Distance: 110 Metric: 1 </pre>

Common Errors

- An IPv4 unicast route is incorrectly configured.
- IPv4 multicast routing is not enabled on a router.

14.4.8Configuring Multicast Non-Stop Forwarding Parameters

Configuration Effect

- The non-stop forwarding function ensures continuous forwarding of multicast data streams during re-convergence of multicast protocols.

Notes

- The basic functions of IP multicasting must be configured.

Configuration Steps

➤ **Configuring the Maximum Period for Multicast Protocol Convergence**

- The maximum period for multicast protocol convergence can be specified on each device unless otherwise specified.

➤ **Configuring the Multicast Packet Leakage Period**

- The multicast leakage period can be configured on each device unless otherwise specified.

Verification

Run **show msf nsf** to check the configured multicast non-stop forwarding parameters.

Related Commands

➤ **Configuring the Maximum Period for Multicast Protocol Convergence**

Command	msf nsf convergence-time <i>time</i>
Parameter	convergence-time <i>time</i> : Specifies the maximum period for multicast protocol convergence. The value ranges from 0 to 3600s. The default value is 20s.
Description	
Command	Global configuration mode
Mode	
Usage Guide	-

➤ **Configuring the Multicast Packet Leakage Period**

Command	msf nsf leak <i>interval</i>
Parameter	leak <i>interval</i> : Specifies the multicast packet leakage period. The value ranges from 0 to 3600s. The default value is 30s.
Description	
Command	Global configuration mode
Mode	
Usage Guide	-

➤ **Displaying Multicast Non-Stop Forwarding Configurations**

Command	show msf nsf
Parameter	-
Description	
Command	Privilege, global and interface configuration modes
Mode	
Usage Guide	-

Configuration Example

➤ **Creating the IP Multicast Service on the IPv4 Network and Supporting PIM-DM**

Scenario	Basic environment of the IP multicasting service (Omitted)
Configuration Steps	<ul style="list-style-type: none"> ● Configure the basic functions of IP multicasting. (Omitted) ● Configure the maximum period for multicast protocol convergence. ● Configure the multicast packet leakage period.

A	<pre>A# configure terminal A(config)# msf nsf convergence-time 200 A(config)# msf nsf leak 300</pre>
Verification	Run show msf nsf to display multicast non-stop forwarding configurations.
A	<pre>A# show msf nsf Multicast HA Parameters -----+-----+ protocol convergence timeout 200 secs flow leak interval 300 secs</pre>

14.4.9 Configuring an Overwriting Mechanism Upon Overflow of Multicast Hardware Forwarding Entries

Configuration Effect

- Delete the earliest hardware entries and adds new entries if the hardware forwarding table overflows when you create multicast forwarding entries.

Notes

- The basic functions of IP multicasting must be configured.

Configuration Steps

- The overwriting mechanism upon overflow of multicast hardware forwarding entries can be configured on each device unless otherwise specified.

Verification

Run **show running-config** to check whether the overwriting mechanism upon overflow of multicast hardware forwarding entries is configured.

Related Commands

📌 Configuring an Overwriting Mechanism Upon Overflow of Multicast Hardware Forwarding Entries

Command	msf ipmc-overflow override
Parameter	-
Description	
Command Mode	Global configuration mode
Usage Guide	-

Configuration Example

📌 Creating the IP Multicast Service on the IPv4 Network and Configuring an Overwriting Mechanism Upon Overflow of Multicast Hardware Forwarding Entries

Scenario	Basic environment of the IP multicasting service (Omitted)
Configuration Steps	<ul style="list-style-type: none"> ● Configure the basic functions of IP multicasting. (Omitted) ● Configure the overwriting mechanism upon overflow of multicast hardware forwarding entries.
A	<pre>A# configure terminal A(config)#msf ipmc-overflow override</pre>
Verification	Run show running-config to check whether the overwriting mechanism upon overflow of multicast hardware forwarding entries is configured.
A	<pre>A# show running-config ... msf ipmc-overflow override ...</pre>

14.5 Monitoring

Clearing



Running the **clear** commands may lose vital information and interrupt services.

Description	Command
Clears the IPv4 multicast forwarding table.	clear ip mroute { * <i>v4group-address</i> [<i>v4source-address</i>] }
Resets statistics in the IPv4 multicast forwarding table.	clear ip mroute statistics { * <i>v4group-address</i> [<i>v4source-address</i>] }

Displaying

Description	Command
Displays help guidance information of each multicast module.	multicast help
Displays status of the IPv4 multicast modules.	view multicast
Displays the IPv4 multicast forwarding table.	show ip mroute [<i>group-or-source-address</i> [<i>group-or-source-address</i>]] [dense sparse] [summary count]
Displays IPv4 static multicast route information.	show ip mroute static
Displays the RFP Information of a specified IPv4 source address.	show ip rpf { <i>source-address</i> [<i>group-address</i>] [rd route-distinguisher] } [metric]
Displays information about IPv4 multicast interfaces.	show ip mvif [<i>interface-type interface-number</i>]
Displays the IPv4 layer-3 multicast forwarding table.	show ip mrf mfc

Description	Command
Displays the IPv4 multi-layer multicast forwarding table.	show msf msc
Displays IPv4 multicast non-stop forwarding configurations.	show msf nsf

Debugging



System resources are occupied when debugging information is output. Therefore, disable debugging immediately after use.

Description	Command
Debugs running of the multicast core.	debug nsm mcast all
Debugs communication between the IPv4 multicast core and the protocol module.	debug nsm mcast fib-msg
Debugs the interface running of the IPv4 multicast core.	debug nsm mcast vif
Debugs the interface and entry statistics processing of the IPv4 multicast core.	debug nsm mcast stats
Debugs the processing of IPv4 layer-3 multicast packet forwarding.	debug ip mrf forwarding
Debugs the operation on layer-3 multicast forwarding entries on an IPv4 network.	debug ip mrf mfc
Debugs the processing of layer-3 multicast forwarding events on an IPv4 network.	debug ip mrf event
Debugs the processing of IPv4 multi-layer multicast packet forwarding.	debug msf forwarding
Debugs the operation on multi-layer multicast forwarding entries on an IPv4 network.	debug msf mfc
Debugs the bottom-layer hardware processing of IPv4 multi-layer multicast packet forwarding.	debug msf ssp
Debugs the invocation of API interfaces provided by IPv4 multi-layer multicast forwarding.	debug msf api
Debugs the processing of multi-layer multicast forwarding events on an IPv4 network.	debug msf events

15 Configuring IPv6 Multicast

15.1 Overview

IPv6 multicast is enrichment and enhancement of IPv4 multicast. In comparison with IPv4 multicast, the IPv6 multicast address mechanism is greatly enriched.

In traditional IP transmission, a host is allowed to send packets only to a single host (unicast communication) or all hosts (broadcast communication). The multicast technology provides a third choice: A host is allowed to send packets to certain hosts.

The IP multicast technology is applicable to one-to-many multimedia applications.

Protocols and Standards

IPv6 multicast covers the following protocols:

- Multicast Listener Discovery (MLD): Runs between a multicast device and a host, and tracks and learns relationships of group members.
- Protocol Independent Multicast – Sparse Mode for IPv6 (PIM-SMv6): Runs between devices and implements multicast packet forwarding by establishing a multicast routing table.

15.2 Applications

Application	Description
Typical Application of PIM-SMv6	The PIM-SMv6 multicast service is provided in the same network.

15.2.1 Typical Application of PIM-SMv6

Scenario

The PIM-SMv6 multicast service is provided in the same network.

As shown in the following figure:

- R1 and the multicast source are in the same network, R2 is configured as a rendezvous point (RP), R3 is in the same network as Receiver A, and R4 is in the same network as Receiver B. Assume that devices and hosts are correctly connected, IPv6 is enabled on each interface, and IPv6 unicast is enabled on each device.

Figure 2- 1

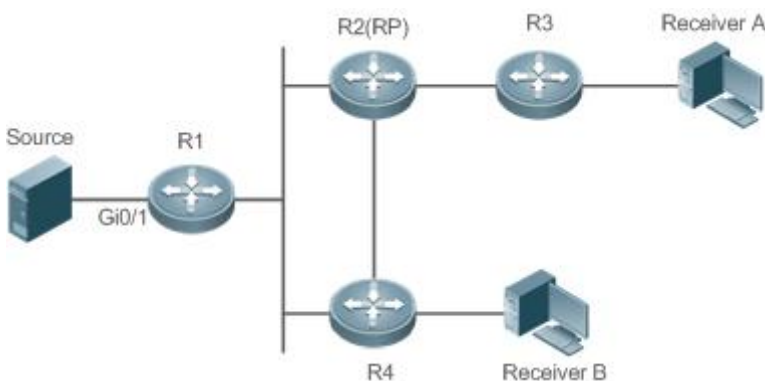

Remarks	<p>R1, R2, R3, and R4 are Layer-3 devices and R2 functions as an RP.</p> <p>The multicast source is directly connected to R1, Receiver A is directly connected to R3, and Receiver B is directly connected to R4.</p>
----------------	---

Deployment

- Run the Open Shortest Path First for IPv6 (OSPFv6) protocol in the same network to implement unicast routing.
- Run the PIM-SMv6 protocol in the same network to implement multicast routing.

15.3 Features

Basic Concepts

↘ PIM Router and PIM Interface

Routers where the PIM protocol is enabled are called PIM routers. Interfaces where the PIM protocol is enabled are called PIM interfaces.

Multicast packets are forwarded by PIM routers. The PIM interfaces for receiving multicast packets are called upstream interfaces, and the PIM interfaces for transmitting multicast packets are called downstream interfaces.

Network segments where upstream interfaces are located are called upstream network segments. Network segments where downstream interfaces are located are called downstream network segments.

↘ PIM Network and PIM Domain

PIM routers are connected through PIM interfaces and form a PIM network.

On some PIM interfaces, borders are set to divide a large PIM network into multiple PIM domains. The borders may reject specific multicast packets or limit transmission of PIM messages.

↘ Multicast Distribution Tree, DR, RP

Multicast packets are transmitted from one point to multiple points. The forwarding path presents a tree structure. This forwarding path is called a multicast distribution tree (MDT). MDTs are classified into two types:

- Rendezvous point tree (RPT): Uses the rendezvous point (RP) as the root and designated routers (DRs) connected to group members as leaves.
- Shortest path tree (SPT): Use the DR connected to a multicast source as the root and the RPs or DRs connected to group members as leaves.

DRs and RPs are function roles of PIM routers.

- RPs collect information about multicast sources and group members in the network.
- The DR connected to a multicast source reports multicast source information to the RP and the DRs connected to group members report the group member information to the RP.

↘ (*,G), (S,G)

- (*,G): Indicates the packets transmitted from any source to Group G, routing entries corresponding to the packets, and forwarding path (RPT) corresponding to the packets.

- (S,G): Indicates the packets transmitted from Source S to Group G, routing entries corresponding to the packets, and forwarding path (SPT) corresponding to the packets.

▾ ASM, SSM

PIM-SM supports two multicast service models: any-source multicast (ASM) and source-specific multicast (SSM), which are applicable to different multicast address segments.

- ASM: In the ASM model, a user host cannot select a multicast source. The user host joins a multicast group and receives all packets sent from all sources to the multicast group.
- SSM: In the SSM model, a user host can select a multicast source. The user host specifies the source address when joining a multicast group, and then receives packets only from the specified source to the multicast group.
- i** SSM model requirement: Other network services must be used to enable a user host to know the position of a multicast source in advance so that the user host selects the multicast source.

Overview

Feature	Description
Configuring IPv6 Multicast Basic Functions	Creates a PIM network to provide the IPv6 multicast service for data sources and user terminals in the network.
Configuring the Number of Entries That Can Be Added to the IPv6 Multicast Routing Table	Restricts the number of entries that can be added to the multicast routing table.
Configuring the IPv6 Multicast Border	Sets an interface as the multicast border of a specific group range.
Configuring IPv6 Multicast Static Routing	Configures multicast static routing to adopt multicast forwarding paths different from unicast forwarding paths.
Configuring Layer-2 Flow Direction Control for Multicast Streams	Multiple commands can be configured for a multicast stream, that is, multiple ports can be allowed to forward the multicast stream. If flow direction control is configured for a multicast stream, the multicast stream can be forwarded only by the configured ports. Other ports are not allowed to forward the multicast stream.
Configuring RPF Route Selection According to the Longest Matching Principle	One optimal route is selected from each of the multicast static routing table, MBGP routing table, and unicast routing table according to RPF rules. Among the three optimal routes, the route with the longest subnet mask matching is selected as the RPF route.

15.3.1 Configuring IPv6 Multicast Basic Functions

Create a PIM network to provide the IPv6 multicast service for data sources and user terminals in the network.

Working Principle

A device maintains the routing table used for multicast packet forwarding over an IPv6 multicast routing protocol (such as PIM-SMv6), and learns information about the status of group members in the directly-connected network segments over the MLDv1/v2 protocol. A host joins a specific IPv6 multicast group by transmitting the MLD REPORT message.

Related Configuration

↳ Enabling the IPv6 Multicast Routing Function

The IPv6 multicast routing function is disabled by default.

Run the **ipv6 multicast-routing** command to enable the IPv6 multicast routing function.

↳ Configuring an IP Multicast Protocol on an Interface

The IPv6 multicast protocol is disabled on an interface by default.

Run the **ipv6 pim dense-mode** command to enable the IPv6 multicast protocol on an interface.

15.3.2 Configuring the Number of Entries That Can Be Added to the IPv6 Multicast Routing Table

Every multicast data packet received by the device is used to maintain relevant IPv6 multicast routing entries. Excessive multicast routing entries, however, may deplete the device memory and degrade the device performance. Users can restrict the number of entries in the IPv6 multicast routing table based on the actual networking conditions and service performance requirements.

Working Principle

Restrict the number of entries in the IPv6 multicast routing table based on the actual networking conditions and service performance requirements, so as to sustain the device performance.

Related Configuration

↳ Configuring the Number of Entries That Can Be Added to the IPv6 Multicast Routing Table

By default, 1,024 entries can be added to the IP multicast routing table.

Run the **ipv6 multicast route-limit limit [threshold]** command to adjust the number of entries that can be added to the IPv6 multicast routing table. The value ranges from 1 to 65,536.

A larger value of *limit* means that more entries can be added to the IPv6 multicast routing table, and a smaller value of *limit* means that fewer entries can be added to the IPv6 multicast routing table.

15.3.3 Configuring the IPv6 Multicast Border

Configure the IPv6 multicast border to restrict the transmission scope of multicast packets.

Working Principle

Configure the multicast border to specify the transmission scope of multicast packets. When the multicast forwarding border is configured on an interface, multicast packets including multicast packets sent by the local device cannot be forwarded or received by this interface.

Related Configuration

↳ Configuring the IPv6 Multicast Border

No multicast border is configured by default.

Run the **ipv6 multicast boundary access-list-name [in | out]** command to configure the multicast border.

15.3.4 Configuring IPv6 Multicast Static Routing

Configure IPv6 multicast static routing to specify a reverse path forwarding (RPF) interface or RPF neighbor for multicast packets from a specific multicast source.

Working Principle

The RPF check is conducted during forwarding of multicast packets. IPv6 multicast static routing can be configured to specify an RPF interface or RPF neighbor for multicast packets from a specific multicast source.

Related Configuration

📌 Configuring IPv6 Multicast Static Routing

No multicast static routing is configured by default.

Run the **ipv6 mroute** *ipv6-prefix/prefix-length* [**bgp** | **isis** | **ospfv3** | **ripng** | **static**] { *ipv6-prefix* | *interface-type interface-number* } [*distance*] command to configure IPv6 multicast static routing.

15.3.5 Configuring Layer-2 Flow Direction Control for Multicast Streams

Configure Layer-2 flow direction control for multicast streams to control the forwarding behavior of multicast streams on ports.

Working Principle

Configure Layer-2 flow direction control for multicast streams to configure the ports that are allowed to forward multicast streams. Then, multicast streams are forwarded only by the configured ports, thereby controlling Layer-2 forwarding of multicast streams.

Related Configuration

📌 Configuring Layer-2 Flow Direction Control for Multicast Streams

Layer-2 flow direction control is disabled for multicast streams by default.

Run the **ipv6 multicast static** *source-address group-address interface-type interface-number* command to configure the Layer-2 flow direction control for multicast streams.

15.3.6 Configuring RPF Route Selection According to the Longest Matching Principle

Among the three optimal routes selected from the multicast static routing table, Multiprotocol Border Gateway Protocol (MBGP) routing table, and unicast routing table, select the optimal route with the longest subnet mask matching as the RPF route.

Working Principle

According to RPF rules, select a multicast static route, MBGP route, and unicast route used for the RPF check respectively from the multicast static routing table, MBGP routing table, and unicast routing table.

- If route selection according to the longest matching principle is configured, the route with the longest subnet mask matching is selected out of the three routes as the RPF route. If the three routes share the same subnet mask, the route with the highest priority is selected. If the three routes have the same priority, the RPF route is selected according to the sequence of multicast static route, MBGP route, and unicast route.

- If route selection according to the longest matching principle is not configured, the route with the highest priority is selected. If the three routes have the same priority, the RPF route is selected according to the sequence of multicast static route, MBGP route, and unicast route.

Related Configuration

▾ **Configuring RPF Route Selection According to the Longest Matching Principle**

A route with the highest priority is selected as the RPF route by default. If the routes have the same priority, the RPF route is selected according to the sequence of multicast static route, MBGP route, and unicast route.

Run the **ipv6 multicast rpf longest-match** command to configure RPF route selection according to the longest matching principle.

15.4 Configuration

Configuration	Description and Command	
Configuring IPv6 Multicast Basic Functions	(Mandatory) It is used to create a multicast service.	
	ipv6 multicast-routing	Enables the IPv6 multicast routing function.
Configuring the Number of Entries That Can Be Added to the IPv6 Multicast Routing Table	Optional.	
	ipv6 multicast route-limit <i>limit</i> [<i>threshold</i>]	Restricts the number of entries that can be added to the multicast routing table.
Configuring the IPv6 Multicast Border	ipv6 multicast boundary <i>access-list-name</i> [<i>in</i> <i>out</i>]	Sets an interface as the multicast border of a specific group range.
Configuring IPv6 Multicast Static Routing	ipv6 mroute <i>ipv6-prefix/prefix-length</i> [<i>protocol</i>] { <i>v6rpf-address</i> <i>interface-type interface-number</i> } [<i>distance</i>]	Configures IPv6 multicast static routing.
Configuring Layer-2 Flow Direction Control for Multicast Streams	ipv6 multicast static <i>source-address group-address interface-type interface-number</i>	Controls the flow direction of data streams on Layer-2 ports.
Configuring RPF Route Selection According to the Longest Matching Principle	ipv6 multicast rpf longest-match	Configures RPF route selection according to the longest matching principle.

15.4.1 Configuring IPv6 Multicast Basic Functions

Configuration Effect

- Create a PIM network to provide the IPv6 multicast service for data sources and user terminals in the network.

Notes

- The PIM network needs to use existing unicast routing in the network. Therefore, IPv6 unicast routing must be configured in the network.

Configuration Steps

▾ **Enabling the IPv6 Multicast Routing Function**

- Mandatory.

- Enable the IPv6 multicast routing function on each router unless otherwise specified.

➤ **Enabling an IP Multicast Protocol on Interfaces**

- Mandatory.
- Enable the IPv6 multicast protocol function on interfaces unless otherwise specified.

Verification

Make multicast sources in the network send multicast packets and make a user host join the groups.

- Check whether the user host can successfully receive packets from each group.

Related Commands

➤ **Enabling the IPv6 Multicast Routing Function**

Command	ipv6 multicast-routing
Parameter	N/A
Description	
Command Mode	Global configuration mode
Usage Guide	The IPv6 multicast routing function must be enabled before various IPv6 multicast protocols are enabled. The IPv6 multicast routing function and the MLD snooping function are mutually exclusive.

➤ **Configuring IPv6 Multicast Protocols**

- i** For details about the MLD configuration method, see the *Configuring MLD*.
- i** For details about the PIM-SMv6 configuration method, see the *Configuring PIM-SMv6*.
- i** After the Layer-3 multicast function is enabled on a private VLAN and Super VLAN, if there is a multicast source in the sub-VLAN, an entry needs to be additionally copied, with the inlet of the sub-VLAN where multicast streams enter because the validity check needs to be conducted at the inlet during multicast packet forwarding. As a result, one more multicast hardware entry is occupied, and the multicast capacity needs to be decreased by one.

➤ **Displaying Multicast Forwarding Table Information**

Command	show ipv6 mroute [<i>group-or-source-address</i> [<i>group-or-source-address</i>]] [sparse] [summary count]
Parameter Description	<i>group-or-source-address</i> : Indicates the group address or source address. <i>group-or-source-address</i> : Indicates the group address or source address. sparse : Displays the core entry of the PIM-SMv6 multicast routing table. summary : Displays the summary of IPv6 multicast routing entries. count : Displays the count information about IPv6 multicast routing entries.
Command Mode	Privileged EXEC mode, global configuration mode, and interface configuration mode
Usage Guide	N/A

Configuration Example

➤ **Creating the IPv6 Multicast Service on an IPv6 Network to Support PIMv6-SM**

<p>Scenario Figure 2-2</p>	
<p>Configuration Steps</p>	<ul style="list-style-type: none"> ● Configure an IPv6 unicast routing protocol (for example, OSPFv3) on routers. ● Enable the IPv6 multicast routing function on all routers. ● Enable the PIMv6-SM function on device interconnection interfaces, interface for connecting to the user host, and interface for connecting to the multicast source.
<p>A</p>	<pre>A# configure terminal A(config)# ipv6 multicast-routing A(config)# interface gigabitEthernet 0/1 A(config-if-GigabitEthernet 0/1)#ipv6 pim sparse-mode A(config-if)# exit A(config)# interface gigabitEthernet 0/2 A(config-if-GigabitEthernet 0/2)#ipv6 pim sparse-mode A(config-if)# exit</pre>
<p>B</p>	<pre>B# configure terminal B(config)# ipv6 multicast-routing B(config)# interface gigabitEthernet 0/1 B(config-if-GigabitEthernet 0/1)#ipv6 pim sparse-mode B(config-if)# exit B(config)# interface GigabitEthernet 0/2 B(config-if-GigabitEthernet 0/2)#ipv6 pim sparse-mode B(config-if)# exit</pre>
<p>Verification</p>	<p>Make Multicast Source (2001::1) send packets to G(ff16::16) and make Receiver A join G.</p> <ul style="list-style-type: none"> ● Check multicast packets received by Receiver A. Receiver A should be able to receive multicast packets from G. ● Check the multicast forwarding table on Receiver A and Device B.
<p>A</p>	<pre>A# show ipv6 mroute</pre>

	<p>IPv6 Multicast Routing Table</p> <p>Flags: I - Immediate Stat, T - Timed Stat, F - Forwarder installed, R - RPT, S - SPT, s - SSM Group</p> <p>Timers: Uptime/Stat Expiry</p> <p>Interface State: Interface</p> <p>(2001::1, ff16::16), uptime 00:03:12, stat expires 00:02:03</p> <p>Owner PIMSMV6, Flags: TFS</p> <p>Incoming interface: GigabitEthernet 0/1</p> <p>Outgoing interface list: GigabitEthernet 0/2</p>
<p>B</p>	<p>B# show ipv6 mroute</p> <p>IPv6 Multicast Routing Table</p> <p>Flags: I - Immediate Stat, T - Timed Stat, F - Forwarder installed, R - RPT, S - SPT, s - SSM Group</p> <p>Timers: Uptime/Stat Expiry</p> <p>Interface State: Interface</p> <p>(2001::1, ff16::16), uptime 00:00:23, stat expires 00:03:07</p> <p>Owner PIMSMV6, Flags: TFR</p> <p>Incoming interface: GigabitEthernet 0/2</p> <p>Outgoing interface list: GigabitEthernet 0/1</p>

Common Errors

- IPv6 unicast routing is incorrectly configured.
- IPv6 multicast routing is not enabled on a router.
- No IPv6 multicast protocol is enabled on an interface.

15.4.2 Configuring the Number of Entries That Can Be Added to the IPv6 Multicast Routing Table

Configuration Effect

- Every multicast data packet received by the device is used to maintain relevant IPv6 multicast routing entries. Excessive multicast routing entries, however, may deplete the device memory and degrade the device performance. Users can restrict the

number of entries in the IPv6 multicast routing table based on the actual networking conditions and service performance requirements.

Notes

- The IPv6 multicast basic functions must be configured.

Configuration Steps

- Restrict the number of entries in the IPv6 multicast routing table based on the actual networking conditions and service performance requirements.

Verification

Make multicast sources in the network send multicast packets to N different multicast groups and make a user host join these groups. Set the number of entries that can be added to the IPv6 multicast routing table to N-1 on the device and check that multicast packets received by the user host are from N-1 groups.

Related Commands

➤ **Configuring the Number of Entries That Can Be Added to the IP Multicast Routing Table**

Command	<code>ipv6 multicast route-limit limit [threshold]</code>
Parameter Description	<p><i>limit</i>: Indicates the number of multicast routing entries. The value ranges from 1 to 65,536 and the default value is 1,024.</p> <p><i>threshold</i>: Indicates the multicast routing entry quantity for triggering an alarm. The default value is 65,536.</p>
Command Mode	Global configuration mode
Usage Guide	Routing entries that are beyond the allowable range of hardware can be forwarded only by software due to hardware resource restrictions, making the performance deteriorate.

Configuration Example

➤ **Creating the IPv6 Multicast Service on an IPv6 Network and Configuring the Number of Entries That Can Be Added to the IPv6 Multicast Routing Table**

<p>Scenario</p> <p>Figure 2-3</p>	
Configuration Steps	<ul style="list-style-type: none"> ● Configure IP multicast basic functions (omitted). ● Set the number of entries that can be added to the IP multicast routing table to 2 on Device B.
B	B# configure terminal

	<pre>B(config)# ipv6 multicast route-limit 2</pre>
<p>Verification</p>	<p>Make Multicast Source (2001::1) send packets to G1(ff16::16), G2(ff16::17), and G3(ff16::18) and make Receiver A join G1, G2, and G3.</p> <ul style="list-style-type: none"> ● Check multicast packets received by Receiver A. Receiver A should be able to receive multicast packets from two groups of G1, G2, and G3. ● Check multicast routing entries on Receiver A and Device B. ● A prompt is displayed when the number of entries in the multicast routing table reaches the upper limit.
<p>A</p>	<pre>A# show ipv6 mroute IPv6 Multicast Routing Table Flags: I - Immediate Stat, T - Timed Stat, F - Forwarder installed, R - RPT, S - SPT, s - SSM Group Timers: Uptime/Stat Expiry Interface State: Interface (2001::1, ff16::16), uptime 00:01:01, stat expires 00:02:29 Owner PIMSMV6, Flags: TFS Incoming interface: GigabitEthernet 0/1 Outgoing interface list: GigabitEthernet 0/2 (2001::1, ff16::17), uptime 00:01:01, stat expires 00:02:29 Owner PIMSMV6, Flags: TFS Incoming interface: GigabitEthernet 0/1 Outgoing interface list: GigabitEthernet 0/2 (2001::1, ff16::18), uptime 00:00:57, stat expires 00:02:33 Owner PIMSMV6, Flags: TFS Incoming interface: GigabitEthernet 0/1 Outgoing interface list: GigabitEthernet 0/2</pre>
<p>B</p>	<pre>B# show ipv6 mroute</pre>

	<p>IPv6 Multicast Routing Table</p> <p>Flags: I - Immediate Stat, T - Timed Stat, F - Forwarder installed, R - RPT, S - SPT, s - SSM Group</p> <p>Timers: Uptime/Stat Expiry</p> <p>Interface State: Interface</p> <p>(2001::1, ff16::16), uptime 00:00:29, stat expires 00:03:01</p> <p>Owner PIMSMV6, Flags: TFR</p> <p>Incoming interface: GigabitEthernet 0/2</p> <p>Outgoing interface list: GigabitEthernet 0/1</p> <p>(2001::1, ff16::17), uptime 00:00:29, stat expires 00:03:01</p> <p>Owner PIMSMV6, Flags: TFR</p> <p>Incoming interface: GigabitEthernet 0/2</p> <p>Outgoing interface list: GigabitEthernet 0/1</p>
	<p>A prompt is displayed when the number of entries in the multicast routing table reaches the upper limit.</p> <pre>B#* Jan 3 21:40:07: %MROUTE-4-ROU TELIMIT: IPv6 Multicast route limit 2 exceeded..</pre>

Common Errors

- IPv6 unicast routing is incorrectly configured.

15.4.3 Configuring the IPv6 Multicast Border

Configuration Effect

- Configure the IPv6 multicast border to restrict the transmission scope of multicast packets.

Notes

- The IPv6 multicast basic functions must be configured.

Configuration Steps

- Configure the IPv6 multicast border on each PIM router interface unless otherwise specified.

Verification

Make multicast sources send multicast packets to multicast groups and make a user host join these multicast groups. Configure the IPv6 multicast border on the PIM router interface connected to the user host and check whether the user host can receive multicast packets.

Related Commands

▾ **Enabling the IPv6 Multicast Routing Function**

Command	ipv6 multicast boundary <i>access-list-name</i> [in out]
Parameter Description	<i>access-list-name</i> : Uses the group address range defined by an access control list (ACL). in : Indicates that the multicast border takes effect in the incoming direction of multicast streams. out : Indicates that the multicast border takes effect in the outgoing direction of multicast streams.
Command Mode	Interface configuration mode
Usage Guide	The ACL referenced in this command can be a standard ACL or an extended ACL. If an extended ACL is used, only destination addresses need to be matched. This command can be used to filter MLD and PIM-SMv6 protocol packets relevant to the IPv6 multicast group range. Multicast data streams are not transmitted or received by multicast border interfaces.

Configuration Example

▾ **Creating the IPv6 Multicast Service on an IPv6 Network and Configuring the IPv6 Multicast Border**

Scenario Figure 2-4	
Configuration Steps	<ul style="list-style-type: none"> ● Configure IP multicast basic functions (omitted). ● Configure an ACL on Device A. ● Configure the IP multicast border on Interface Gi0/1 of Device A.
A	<pre>A# configure terminal A(config)# ipv6 access-list ip_multicast A(config-ipv6-acl)#deny udp any any A(config-ipv6-acl)#exit A(config)# interface GigabitEthernet 0/1 A(config-if-GigabitEthernet 0/1)#ip multicast boundary ip_multicast A A(config-if-GigabitEthernet 0/1)# exit</pre>

Verification	<p>Make Multicast Source (192.168.1.100) send packets to G (233.3.3.3) and make Receiver A join G.</p> <ul style="list-style-type: none"> Run the debug ipv6 pim sparse-mode events command to debug multicast events in SM mode.
A	<pre>A# debug ipv6 pim sparse-mode events Dec 28 11:54:07: %7: No cache message: src 2001::1 for ff16::16 vif 1 *Dec 28 11:54:07: %7: Ignore No cache message: src 2001::1 for ff16::16 vif 1 in PIM6_BOUNDARY_FLT_BOTH range</pre>

Common Errors

- IPv6 unicast routing is incorrectly configured.

15.4.4 Configuring IPv6 Multicast Static Routing

Configuration Effect

- Configure IPv6 multicast static routing to specify an RPF interface or RPF neighbor for multicast packets from a specific multicast source.

Notes

- The IPv6 multicast basic functions must be configured.

Configuration Steps

- Configure IPv6 multicast static routing on each device unless otherwise specified.

Verification

Configure IPv6 multicast static routing and then run the **show ipv6 rpf v6source-address** command to check RPF information about a specific multicast source.

Related Commands

▾ **Configuring IPv6 Multicast Static Routing**

Command	ipv6 mroute <i>ipv6-prefix/prefix-length</i> [<i>protocol</i>] { <i>v6rpf-address</i> <i>interface-type interface-number</i> } [<i>distance</i>]
Parameter Description	<p><i>ipv6-prefix</i>: Indicates the IPv6 address of a multicast source.</p> <p><i>prefix-length</i>: Indicates the subnet mask of the IPv6 address of the multicast source.</p> <p><i>protocol</i>: Indicates the unicast routing protocol that is being used currently.</p> <p><i>v6rpf-address</i>: Indicates the IPv6 address of the RPF neighbor (next hop to the multicast source).</p> <p><i>interface-type interface-number</i>: Indicates the RPF interface (outbound interface to the multicast source).</p> <p><i>distance</i>: Indicates the route management distance. The value ranges from 0 to 255 and the default value is 0.</p>
Command Mode	Global configuration mode
Usage Guide	<p>IPv6 multicast static routing is used only for the RPF check.</p> <p>To specify the outbound interface rather than the next-hop IP address of IPv6 static multicast routing, the outbound interface must be of the point-to-point type.</p>

▾ **Displaying RPF Information About a Specific Source Address**

Command	show ipv6 rpf v6source-address
Parameter	v6source-address: Indicates the IPv6 source address.
Description	
Command Mode	Privileged EXEC mode, global configuration mode, and interface configuration mode
Usage Guide	N/A

Configuration Example

📌 **Creating the IPv6 Multicast Service on an IPv6 Network and Configuring IPv6 Multicast Static Routing**

<p>Scenario Figure 2-5</p>	
<p>Configuration Steps</p>	<ul style="list-style-type: none"> ● Configure IPv6 multicast basic functions (omitted). ● Configure a static route to the receiver on Device B.
<p>A</p>	<pre>B# configure terminal B(config)# ipv6 mroute 2005::/64 ospfv3 2002::2</pre>
<p>Verification</p>	<p>Run the show ipv6 rpf command to display the RPF information received by the receiver before and after configuration.</p>
<p>Before Configuration</p>	<pre>B# show ipv6 rpf 2005::1 RPF information for 2005::1 RPF interface: GigabitEthernet 0/1 RPF neighbor: fe80::2d0:f8ff:fe22:341b RPF route: 2005::1/128 RPF type: unicast (ospf) RPF recursion count: 0 Doing distance-preferred lookups across tables Distance: 110 Metric: 1</pre>
<p>After Configuration</p>	<pre>B# show ipv6 rpf 2005::1 RPF information for 2005::1 RPF interface: GigabitEthernet 0/2 RPF neighbor: 2002::2 RPF route: 2005::/64</pre>

	<p>RPF type: unicast (ospf)</p> <p>RPF recursion count: 0</p> <p>Doing distance-preferred lookups across tables</p> <p>Distance: 110</p> <p>Metric: 1</p>
--	---

Common Errors

- IPv6 unicast routing is incorrectly configured.
- IPv6 multicast routing is not enabled on a router.

15.4.5 Configuring Layer-2 Flow Direction Control for Multicast Streams

Configuration Effect

Configure Layer-2 flow direction control for multicast streams to control the forwarding behavior of multicast streams on ports.

Notes

- The IPv6 multicast basic functions must be configured.

Configuration Steps

- Configure Layer-2 flow direction control for multicast streams on devices unless otherwise specified.

Verification

Make Device A send multicast packets to multicast groups in the network. Multiple user hosts connected to VLAN 1 of Device A receive multicast packets from these multicast groups. Configure Layer-2 flow direction control for multicast streams on Device A so that multicast packets are sent to configured ports.

Related Commands

↘ Configuring Layer-2 Flow Direction Control for Multicast Streams

Command	ipv6 multicast static <i>source-address group-address interface-type interface-number</i>
Parameter	<i>source-address</i> : Indicates the multicast source address.
Description	<i>group-address</i> : Indicates the multicast group address. <i>interface-type interface-number</i> : Indicates a Layer-2 port that is allowed to forward multicast streams.
Command Mode	Global configuration mode
Usage Guide	<p>Multiple commands can be configured for a multicast stream, that is, multiple ports can be allowed to forward the multicast stream. If flow direction control is configured for a multicast stream, the multicast stream can be forwarded only by the configured ports. Other ports are not allowed to forward the multicast stream.</p> <p>This command controls only the forwarding behavior of multicast streams on ports. It does not directly affect processing of protocol packets by multicast protocols. Some features of multicast protocols (such as PIM-SMv6) are driven by multicast data streams, and therefore, the behavior of the multicast routing protocols may still be affected.</p>

Configuration Example

➤ **Creating the IPv6 Multicast Service on an IPv6 Network and Configuring Layer-2 Flow Direction Control for Multicast Streams**

<p>Scenario Figure 2- 6</p>	
<p>Configuration Steps</p>	<ul style="list-style-type: none"> ● Configure IP multicast basic functions (omitted). ● Configure Layer-2 flow direction control for multicast streams on Device B so that multicast streams are transmitted only to Interface Gi0/2.
<p>B</p>	<pre>A# configure terminal A(config)# ipv6 multicast static 2001::1 ff16::16 gigabitEthernet 0/2</pre>
<p>Verification</p>	<p>Make Multicast Source (2001:: 1) send packets to G (ff16::16) and make Receiver A and Receive B join G.</p> <ul style="list-style-type: none"> ● Receiver A should be able to receive multicast packets from G but Receiver B cannot receive multicast packets from G.

Common Errors

- IPv6 unicast routing is incorrectly configured.

15.4.6Configuring RPF Route Selection According to the Longest Matching Principle

Configuration Effect

Among the three optimal routes selected from the multicast static routing table, MBGP routing table, and unicast routing table, select the optimal route with the longest subnet mask matching as the RPF route.

Notes

- The IP multicast basic functions must be configured.

Configuration Steps

- Configure RPF route selection according to the longest matching principle on each device unless otherwise specified.

Verification

Configure a multicast static route and a unicast static route with the same priority and configure the unicast static route to have the longest subnet mask matching.

- Run the **show ipv6 rpf v6source-address** command to check RPF information about a specific source.

Related Commands

➤ **Configuring RPF Route Selection According to the Longest Matching Principle**

Command	ipv6 multicast rpf longest-match
Parameter Description	N/A
Command Mode	Global configuration mode
Usage Guide	<p>The steps of selecting an RPF route are as follows:</p> <p>Select one optimal route used for the RPF check from each of the IPv6 multicast static routing table, IPv6 MBGP routing table, and IPv6 unicast routing table.</p> <p>Select one route out of the three optimal routes as the RPF route.</p> <p>If the command for selecting the RPF route according to the longest matching principle is configured, the route with the longest subnet mask matching is selected out of the three optimal routes as the RPF route. If the three routes share the same subnet mask, the route with the highest priority is selected. If the routes have the same priority, the RPF route is selected according to the sequence of IPv6 multicast static route, IPv6 MBGP route, and IPv6 unicast route.</p> <p>If the command for selecting the RPF route according to the longest matching principle is not configured, the route with the highest priority is selected out of the three optimal routes as the RPF route. If the routes have the same priority, the RPF route is selected according to the sequence of IPv6 multicast static route, IPv6 MBGP route, and IPv6 unicast route.</p>

Configuration Example

➤ **Creating the IPv6 Multicast Service on the IPv6 Network and Configuring the RPF Route Selection According to the Longest Matching Principle**

Scenario Figure 2-7	
Configuration Steps	<ul style="list-style-type: none"> ● Configure IP multicast basic functions (omitted). ● Configure an IPv6 multicast static route with the subnet mask length smaller than that of the unicast route on Device B. ● Configure the RPF route selection according to the longest matching principle on Device B.
B	<pre> B# configure terminal B(config)# ipv6 multicast-routing B(config)# ipv6 mroute 2005::/64 ospfv3 2002::2 B(config)# ipv6 multicast rpf longest-match </pre>
Verification	Run the show ipv6 rpf command to display the RPF information about the multicast source before and after RPF route selection according to the longest matching principle is configured.

<p>Before Configuration</p>	<pre>B# show ipv6 rpf 2005::1 RPF information for 2005::1 RPF interface: GigabitEthernet 0/2 RPF neighbor: 2002::2 RPF route: 2005::/64 RPF type: unicast (ospf) RPF recursion count: 0 Doing distance-preferred lookups across tables Distance: 110 Metric: 1</pre>
<p>After Configuration</p>	<pre>B# show ipv6 rpf 2005::1 RPF information for 2005::1 RPF interface: GigabitEthernet 0/1 RPF neighbor: fe80::2d0:f8ff:fe22:341b RPF route: 2005::1/128 RPF type: unicast (ospf) RPF recursion count: 0 Doing distance-preferred lookups across tables Distance: 110 Metric: 1</pre>

Common Errors

- IPv6 unicast routing is incorrectly configured.
- IPv6 multicast routing is not enabled on a router.

15.5 Monitoring

Clearing

 Running the **clear** commands may lose vital information and thus interrupt services.

Description	Command
Clears the IPv6 multicast forwarding table.	clear ipv6 mroute { * v6group-address [v6source-address] }
Clears the statistics in the IPv6 multicast forwarding table.	clear ipv6 mroute statistics { * v6group-address [v6source-address] }

Displaying

Description	Command
Displays the IPv6 multicast forwarding table information.	show ipv6 mroute [<i>group-or-source-address</i> [<i>group-or-source-address</i>]] [sparse] [summary count]
Displays RPF information about a specific IPv6 source address.	show ipv6 rpf <i>v6source-address</i>
Displays information the IPv6 static multicast route.	show ipv6 mroute static
Displays information about the configured IPv6 multicast interface that takes effect.	show ipv6 mvif [<i>interface-type interface-number</i>]
Displays the IPv6 Layer-3 multicast forwarding table.	show ipv6 mrf mfc
Displays the IPv6 multi-layer multicast forwarding table.	show msf6 msc

Debugging



System resources are occupied when debugging information is output. Therefore, disable debugging immediately after use.

Description	Command
Debugs all running processes of the IPv6 multicast.	debug nsm mcast6 all
Debugs the communication between the IPv6 multicast and the protocol module.	debug nsm mcast6 fib-msg
Debugs the interface running of the IPv6 multicast.	debug nsm mcast6 mif
Debugs the processing of interfaces and behavior statistics of the IPv6 multicast.	debug nsm mcast6 stats
Debugs the Layer-3 multicast forwarding of IPv6.	debug ipv6 mrf forwarding
Debugs the operation process of IPv6 Layer-3 multicast forwarding entries.	debug ipv6 mrf mfc
Debugs the processing of IPv6 Layer-3 multicast forwarding events.	debug ipv6 mrf event
Debugs the forwarding of IPv6 multi-layer multicast packets.	debug msf6 forwarding
Debugs the operation process of IPv6 multi-layer multicast forwarding entries.	debug msf6 mfc
Debugs the underlying hardware for IPv6 multi-layer multicast forwarding.	debug msf6 ssp
Debugs the APIs for IPv6 multi-layer multicast forwarding.	debug msf6 api
Debugs the processing of IPv6 multi-layer multicast forwarding events.	debug msf6 event

16 Configuring IGMP

16.1 Overview

The Internet Group Management Protocol (IGMP) is a member of TCP/IP protocol family. It manages IP multicast members and is used to establish and maintain multicast group membership between hosts and directly neighboring multicast routers. IGMP behaviors are classified into host behaviors and device behaviors.

- At present, three IGMP versions are available, which are IGMPv1, IGMPv2 and IGMPv3.
- All IGMP versions support the Any-Source Multicast (ASM) model.
- IGMPv3 can be directly used for the Source-Specific Multicast (SSM) model.
- IGMPv1 and IGMPv2 can be used for the SSM model only when the IGMP SSM Mapping technology is supported.

Protocols and Standards

- RFC 1112: Host Extensions for IP Multicasting
- RFC 2236: Internet Group Management Protocol, Version 2
- RFC 3376: Internet Group Management Protocol, Version 3
- RFC 4605: Internet Group Management Protocol (IGMP) / Multicast Listener Discovery (MLD)-Based Multicast Forwarding ("IGMP/MLD Proxying")

16.2 Applications

Application	Description
Local IGMP Service	Implements the IGMP service in a local network.
IGMP Proxy Service	In a simple tree network topology, use the IGMP proxy service instead of the PIM service.

16.2.1 Local IGMP Service

Scenario

As shown in Figure 3- 1, receivers 1 and 2 and routers A and B form a local network.

Query packets sent by router A or B are valid in the LAN, whereas Report packets sent by receivers 1 and 2 are also valid locally.

Figure 3- 1

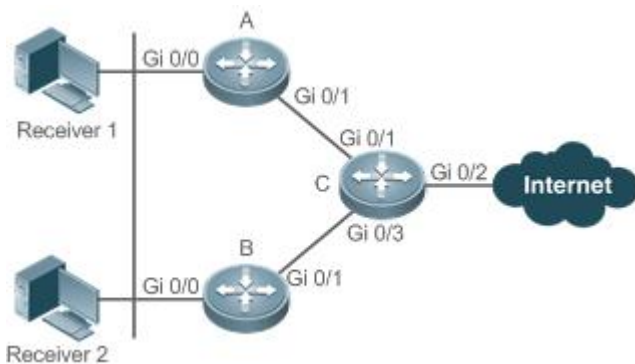

Remarks	C is the egress gateway (EG) device.
----------------	--------------------------------------

A and B are core routers.

Deployment

- Routers A, B and C run OSPF.
- The interfaces of A, B and C run multicast protocols (PIM-SM or PIM-DM).

16.2.2IGMP Proxy Service

Scenario

As shown in Figure 3- 2, router A implements the proxy function working as a host and forms a local network group with router B. Router A forwards Report packets sent by receivers 1 and 2.

Figure 3- 2

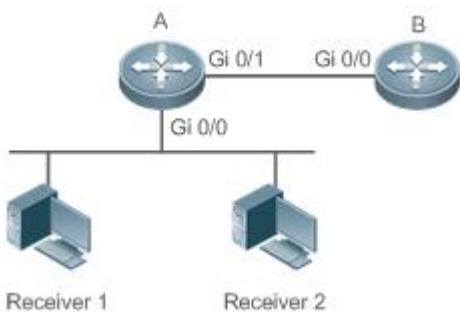

Remarks Router A implements the proxy function.
Router B provides the PIM service.

Deployment

- Routers A and B run OSPF.
- The interfaces of A and B run multicast protocols (PIM-SM or PIM-DM).
- The multicast proxy function is implemented on the interfaces Gi0/0 and Gi0/1 of router A.

16.3Features

Basic Concepts

↘ **Host Behavior and Device Behavior**

- Layer-3 multicast devices that run multicast management protocols are called devices and their behaviors are called device behaviors.
- PCs or simulated PCs that run multicast management protocols are called hosts and their behaviors are called host behaviors.

↘ **Querier**

- Devices compete against each other by comparing IP addresses. Devices with lower IP addresses become queriers and send Query packets regularly.

↘ **IGMP Proxy-Service Interface**

- This interface performs host behaviors, receives Query packets sent by upstream devices (hence also called uplink interface), and sends Report information collected by the router proxy.

↘ IGMP Mroute-Proxy Interface

- This interface implements the router functions, sends packets received by the IGMP PROXY-SERVICE interface (hence also called downlink interface), and collects host information and sends the host information to the IGMP PROXY-SERVICE interface.

↘ IGMP SSM Mapping

- Mapping of the SSM model. IGMPv1 and IGMPv2 do not support the SSM model, but can enable the SSM-MAP function to support the SSM model.

Overview

Feature	Description
IGMP Router	Sends Query packets and obtains local member information.
IGMP Querier	Selects a unique querier from a network segment.
IGMP Group Filtering	Filters group members and limit the number of group members.
Static IGMP Group	Static group information is available on a router; therefore, it is unnecessary for the host to send a Report packet to obtain the static group information.
Simulating Hosts to Join IGMP Groups	Simulate the host behavior to directly join a multicast group on an interface.
IGMP Proxy	Use this function in a simple tree network topology where no complex multicast route protocols (such as PIM) need to be executed.
IGMP SSM Mapping	Provide the SSM model support for IGMPv1 and IGMPv2. When a host joins a group, you can specify a source to save bandwidth and prevent unwanted and invalid multicast data streams from occupying network bandwidth, especially in a network environment where multiple multicast sources share one multicast address.
Router Alert Option	Checks whether IGMP packets contain the Router Alert option and discards the packets without the Router Alert option. Sends IGMP packets with the Router Alert option.

16.3.1IGMP Router

- This function is used to send Query packets and obtain local member information.

Working Principle

- In a multicast network running the IGMP, a multicast device periodically sends IGMP Query packets and confirms information about local members based on responses.
- Only one multicast device sends IGMP Query packets in one network segment and this device is called querier. The querier is determined by means of selection. Initially, all multicast devices are in the Querier state. When a device receives a membership query from a device with a lower IP address, the device changes from the Querier state to the Non-querier state. Therefore, only one device is in the Querier state finally. This device has the lowest IP address among all multicast devices in the network.
- The querier sends IGMP packets of different versions based on the IGMP version settings. In addition, the following querier parameters can be modified: frequency for the querier to send IGMP Query packets, query times and query interval for the last member, maximum response time of IGMP Query packets, and keepalive time of the existing querier.

Related Configuration

↳ Enabling IGMP

IGMP is disabled on an interface by default.

You can run the **ip pim { sparse-mode | dense-mode }** command to enable or disable IGMP for an interface.

IGMP can be enabled only when Sparse Mode (SM) or Dense Mode (DM) is configured on the interface.

↳ Specifying the IGMP Version

IGMPv2 is enabled by default.

You can run the **ip igmp version { 1 | 2 | 3 }** command to set or reset the IGMP version.

↳ Configuring the Last-Member Query Interval

The interval for sending the last-member Query packets is 1s by default.

You can run the **ip igmp last-member-query-interval interval** command to set or reset the interval for an interface to send Query packets.

A larger value means a larger interval; a smaller value means a smaller interval.

↳ Configuring the Last-Member Query Times

The number of the last-member query times is 2 by default.

You can run the **ip igmp last-member-query-count count** command to set or reset the number of the last-member query times.

A larger value means more last-member query times; a smaller value means fewer last-member query times.

↳ Configuring the Common Member Query Interval

The common member query interval is 125s by default.

You can run the **ip igmp query-interval seconds** command to set or reset the common member query interval.

A larger value means a larger common query interval; a smaller value means a smaller common query interval.

↳ Configuring the Maximum Response Time

The maximum response time is 10s by default.

You can run the **ip igmp query-max-response-time seconds** command to set or reset the maximum response time.

A larger value means longer response time; a smaller value means shorter response time.

16.3.2IGMP Querier

Select a unique querier from a network segment. The querier sends Query packets to obtain group information of the local network.

Working Principle

In a multicast network running IGMP, a multicast device is specified for sending IGMP Query packets. This device is determined through selection. At the beginning, all devices are in the Querier state. When the devices receive membership queries from a device with a lower IP address, the devices change from the Querier state to the Non-querier state. Therefore, only one device is in the Querier state finally. This device has the lowest IP address among all multicast devices in the network. When the selected querier fails,

IGMPv2 also works. Non-querier devices maintain the interval timer for survival of querier. This timer is reset each time a device receives a membership Query packet. If the timer expires, a new round of querier selection starts.

Related Configuration

↘ **Configuring the Querier Timeout**

The querier timeout is 255s by default.

You can run the **ip igmp query-timeout** *seconds* command to set the querier timeout.

A larger value means longer survival time; a smaller value means shorter survival time.

16.3.3IGMP Group Filtering

Filter group members and limit the number of group members.

Working Principle

To prevent hosts in a network segment where an interface resides from joining a multicast group, you can configure an ACL on this interface as a filter. The interface will filter the received IGMP membership Report packets based on this ACL, maintain group membership only for multicast groups allowed by this ACL and set the maximum number of router members.

Related Configuration

↘ **Configuring the IGMP Group ACL**

By default, no ACL is used and any group is allowed to join.

You can run the **ip igmp access-group** *access-list-name* command to set or reset the multicast group ACL.

After the ACL is configured, a router receives only packets set in the ACL.

↘ **Configuring the Maximum Number of IGMP Group Members**

The maximum number of IGMP group members is 1,024 by default.

You can run the **ip igmp limit** *number* command to set or reset the maximum number of multicast group members.

A larger value means more members; a smaller value means fewer members.

16.3.4Static IGMP Group

When static IGMP groups are available on a router, it is unnecessary for the host to send a Report packet to obtain the static group information. The router can directly exchange group information with a PIM router.

Working Principle

You need to set static group information manually.

Related Configuration

↘ **Configuring a Static Group**

No static group is configured by default.

You can run the **ip igmp static-group** *group-address* command to configure a static group.

16.3.5 Simulating Hosts to Join IGMP Groups

Simulate the host behavior to directly join a multicast group on an interface.

Related Configuration

▾ Configuring the Join-Group function

No join-group information is set by default.

You can run the **ip igmp join-group** *group-address* command to configure the address of the multicast group to be joined by the simulated host.

16.3.6 IGMP Proxy

Use this function in a simple tree network topology where no complex multicast route protocols (such as PIM) need to be executed. In this way, a downstream proxy host can send IGMP packets and maintain the membership.

Working Principle

When an upstream router is configured as an IGMP proxy-service interface, it is equal to a host that can receive Query packets sent by upstream routers or forward group information sent by downstream hosts. When a downstream router is configured as an IGMP multicast proxy interface, it is equal to a router that can forward Query packets sent by upstream routers or receive Report packets sent by downstream routers.

Related Configuration

▾ Configuring the IGMP Proxy Service

The IGMP proxy service function is disabled by default.

You can run the **ip igmp proxy-service** command to enable the IGMP proxy service.

This function is mandatory when a proxy is to be used.

▾ Configuring the IGMP Mroute Proxy

The IGMP mroute proxy function is disabled by default.

You can run the **ip igmp mroute-proxy** *interfacename* command to enable the IGMP mroute proxy.

This function is mandatory when a proxy is to be used.

16.3.7 IGMP SSM Mapping

Provide the SSM model support for IGMPv1 and IGMPv2. When a host joins a group, you can specify a source to save bandwidth and prevent unwanted and invalid multicast data streams from occupying network bandwidth, especially in a network environment where multiple multicast sources share one multicast address.

Working Principle

Based on IGMP v1/v2, IGMPv3 provides an extra function, namely, the multicast source filter function. In IGMPv1/v2, a host determines to join a group only based on the group address and then receive multicast streams sent to this group address from any source. A host using IGMPv3 advertises the multicast group that the host wants to join and the addresses of multicast sources from which this host

wants to receive packets. IGMPv1 and IGMPv2 also implement "source address filtering" in some sense; however, they implement this function on the multicast receivers by enabling the SSM mapping function and configuring the static SSM mapping group.

Related Configuration

📌 **Enabling IGMP SSM Mapping**

The SSM mapping function is disabled by default.

You can run the **ip igmp ssm-map enable** command to enable the function.

Mandatory.

📌 **Configuring Static IGMP SSM Mapping**

No static SSM mapping is set by default.

You can run the **ip igmp ssm-map static access-list-num A.B.C.D** command to configure static SSM mapping.

16.3.8 Router Alert Option

Check whether IGMP packets contain the Router Alert option and discard packets without the Router Alert option.

Support sending IGMP packets containing the Router Alert option.

Working Principle

If a packet contains the Router Alert option, the device needs to check the packet in depth and updates the control data accordingly.

If the packet does not contain the option, the device does not check the packet.

After Router Alert option check is enabled, the IGMP packets not containing the Router Alert option are discarded.

After enabled with the function of sending packets with Router Alert option, the device sends IGMP packets with Router Alert option encapsulated.

Related Configuration

📌 **Checking Router Alert Option**

Router Alert option check is disabled by default.

You can run the **ip igmp enforce-router-alert** command to enable the function.

📌 **Sending IGMP Packets with Router Alert Option Encapsulated**

Packets are sent without the Router Alert option by default.

You can run the **ip igmp send-router-alert** command to enable the function.

16.4 Configuration

Configuration			Description and Command		
Configuring Functions	IGMP	Basic	 (Mandatory) It is used to set up the multicast service.		
			ip multicast-routing		Enables the IPv4 multicast routing function.
			ip pim { sparse-mode dense-mode }		Enables the PIM-SM or PIM-DM function.
Configuring IGMP Routers			ip igmp version { 1 2 3 }	Specifies the IGMP version.	

	ip igmp last-member-query-interval interval	Configures the last-member query interval.
	ip igmp last-member-query-count <i>count</i>	Configures the last-member query times.
	ip igmp query-interval <i>seconds</i>	Configures the membership query interval.
	ip igmp query-max-response-time <i>seconds</i>	Configures the maximum response time.
Configuring IGMP Querier	ip igmp query-timeout <i>seconds</i>	Configures the querier timeout.
Configuring IGMP Group Filtering	ip igmp access-group <i>access-list</i>	Configures the IGMP group ACL.
	ip igmp limit <i>number</i> [except <i>access-list</i>]	Configures the maximum number of IGMP group members.
Configuring IGMP Proxy	ip igmp proxy-service	Configures the IGMP proxy service.
	ip igmp mroute-proxy <i>interface-type interface-number</i>	Configures the IGMP mroute proxy.
Configuring IGMP SSM Mapping	ip igmp ssm-map enable	Enables IGMP SSM mapping.
	ip igmp ssm-map static <i>access-list source-address</i>	Configures static IGMP SSM mapping.
Configuring Alert Option	ip igmp enforce-router-alert	Checks the Router Alert option.
	ip igmp send-router-alert	Sends IGMP packets containing the Router Alert option.

16.4.1 Configuring IGMP Basic Functions

Configuration Effect

- Enable the multicast routing function of a local network and collect group information of the local network.

Notes

- An interface must be enabled with the PIM-SM or PIM-DM function.

Configuration Steps

➤ Enabling the IPv4 Multicast Routing Function

- Mandatory.
- If there is no special requirement, the IPv4 multicast routing function should be enabled on each router in the local network.

➤ Enabling the PIM-SM or PIM-DM Function

- Mandatory.
- If there is no special requirement, the PIM-SM or PIM-DM function should be directly enabled on an interface of the local network.

Verification

Run the **show ip igmp interface** *interface-type interface-number* command to check whether IGMP is enabled on the interface.

Related Commands

➤ **Enabling the IPv4 Multicast Routing Function**

Command	ip multicast-routing
Parameter	N/A
Description	
Command Mode	Global configuration mode
Usage Guide	N/A

➤ **Enabling the PIM-SM or PIM-DM Function**

Command	ip pim { sparse-mode dense-mode }
Parameter	N/A
Description	
Command Mode	Interface configuration mode
Usage Guide	PIM interfaces must be layer-3 interfaces, including routing interfaces, L3AP, SVI and loopback interfaces. All PIM interfaces should be accessible to IPv4 unicast routes.

Configuration Example

➤ **Enabling IGMP for a Local Network**

Scenario	<ul style="list-style-type: none"> Configure an IPv4 unicast routing protocol (such as OSPF) on a router and ensure that the loopback interface is accessible to a unicast route. Enable the IPv4 multicast route function on all routers. Enable the PIM-SM or PIM-DM function on interfaces interconnecting devices and interfaces connecting user hosts and multicast sources.
	<pre>VSU(config)#ip multicast-routing VSU(config)#int gi 0/5 VSU(config-if-GigabitEthernet 0/5)#ip add 192.168.1.90 255.255.255.0 VSU(config-if-GigabitEthernet 0/5)#ip pim sparse-mode</pre>
Verification	Run the show ip igmp interface interface-type interface-number command to check whether IGMP is enabled on the interface.
	<pre>VSU#show ip igmp interface gigabitEthernet 0/5 Interface GigabitEthernet 0/5 (Index 5) IGMP Active, Querier, Version 2 (default) Internet address is 192.168.1.90 IGMP interface limit is 1024 IGMP interface has 1 group-record states IGMP interface has 0 static-group records IGMP activity: 3 joins, 0 leaves</pre>

```
IGMP query interval is 125 seconds
IGMP querier timeout is 255 seconds
IGMP max query response time is 10 seconds
Last member query response interval is 10
Last member query count is 2
Group Membership interval is 260 seconds
Robustness Variable is 2
```

Common Errors

- Routers in the network are not enabled with the multicast routing function.
- No multicast interface is available in the network.

16.4.2 Configuring IGMP Routers

Configuration Effect

- Modify the IGMP router parameters will affect the type of packets to be sent and the sending method.

Notes

- The basic functions of IGMP must be configured.

Configuration Steps

▾ Specifying the IGMP Version

Optional.

If there is no special requirement, you can perform this configuration on all router interfaces directly connected to the local network.

▾ Configuring the Last-Member Query Interval

Optional.

If there is no special requirement, you can perform this configuration on all router interfaces directly connected to the local network.

▾ Configuring the Last-Member Query Times

Optional.

If there is no special requirement, you can perform this configuration on all router interfaces directly connected to the local network.

▾ Configuring the Common Member Query Interval

Optional.

If there is no special requirement, you can perform this configuration on all router interfaces directly connected to the local network.

▾ Configuring the Maximum Response Time

Optional.

If there is no special requirement, you can perform this configuration on all router interfaces directly connected to the local network.

Verification

Run the **show ip igmp interface** *interface-type interface-number* command to display the interface configurations.

Related Commands

↘ Specifying the IGMP Version

Command	ip igmp version { 1 2 3 }
Parameter Description	1: Indicates IGMPv 1. 2: Indicates IGMPv 2. 3: Indicates IGMPv 3.
Command Mode	Interface configuration mode
Usage Guide	After this command is configured, IGMP will automatically restart.

↘ Configuring the Last-Member Query Interval

Command	ip igmp last-member-query-interval <i>interval</i>
Parameter Description	<i>Interval</i> : Indicates the interval for sending the Query packets of a specific group. The value ranges from 1 to 255 in the unit of 0.1s, and the default value is 10 (namely, 1s).
Command Mode	Interface configuration mode
Usage Guide	This command applies only to IGMPv2 or IGMPv3. When an interface receives a Leave packet, the interface sends Query packets of the group continually and waits for a response from the host. After timeout occurs, the IGMP router assumes that the group member does not exist in the directly connected network segment and deletes the interface from the IGMP group. The timeout duration is equal to the value of last-member-query-interval multiplied by last-member-query-count plus 1/2 of query-max-response-time .

↘ Configuring the Last-Member Query Times

Command	ip igmp last-member-query-count <i>count</i>
Parameter Description	<i>count</i> : Indicates the times for sending the Query packets of a specific group, ranging from 2 to 7. The default value is 2.
Command Mode	Interface configuration mode
Usage Guide	This command applies only to IGMPv2 or IGMPv3. When an interface receives a Leave packet, the interface sends Query packets of the group continually and waits for a response from the host. After timeout occurs, the IGMP router assumes that the group member does not exist in the directly connected network segment and deletes the interface from the IGMP group. The timeout duration is equal to the value of last-member-query-interval multiplied by last-member-query-count plus 1/2 of query-max-response-time .

↘ Configuring the Common Member Query Interval

Command	ip igmp query-interval <i>seconds</i>
Parameter Description	<i>seconds</i> : Indicates the common member query interval, ranging from 1 to 18,000s. The default value is 125.

Command Mode	Interface configuration mode
Usage Guide	N/A

▾ **Configuring the Maximum Response Time**

Command	ip igmp query-max-response-time <i>seconds</i>
Parameter Description	<i>seconds</i> : Indicates the maximum response time, ranging from 1 to 25s. The default value is 10.
Command Mode	Interface configuration mode
Usage Guide	After sending Query packets, the interface waits for a response. If timeout occurs, the IGMP router assumes that the group member does not exist in the directly connected network segment and deletes the group information.

Configuration Example

▾ **Configuring Basic Router Parameters**

Scenario	<ul style="list-style-type: none"> ● Configure basic functions of IGMP. ● Specify the IGMPv3. ● Configure the last-member query interval to 15 (1.5s). ● Configure the number of the last-member queries to 3. ● Configure the common member query interval to 130s. ● Configure the maximum response time to 15s.
	<pre>VSU(config-if-GigabitEthernet 0/5)#ip igmp version 3 VSU(config-if-GigabitEthernet 0/5)#ip igmp last-member-query-count 3 VSU(config-if-GigabitEthernet 0/5)#ip igmp last-member-query-interval 15 VSU(config-if-GigabitEthernet 0/5)#ip igmp query-interval 130 VSU(config-if-GigabitEthernet 0/5)#ip igmp query-max-response-time 15</pre>
Verification	Run the show ip igmp interface <i>interface-type interface-number</i> command to check the IGMP functions of the interface.
	<pre>VSU#show ip igmp interface gigabitEthernet 0/5 Interface GigabitEthernet 0/5 (Index 5) IGMP Enabled, Active, Querier, Version 3 Internet address is 192.168.1.90 IGMP interface limit is 1024 IGMP interface has 1 group-record states IGMP interface has 0 static-group records IGMP activity: 3 joins, 0 leaves IGMP query interval is 130 seconds IGMP querier timeout is 267 seconds</pre>

	IGMP max query response time is 15 seconds Last member query response interval is 15 Last member query count is 3 Group Membership interval is 275 seconds Robustness Variable is 2 VSU#
--	---

Common Errors

- The basic functions of IGMP are not enabled.

16.4.3 Configuring IGMP Querier

Configuration Effect

- Select a unique querier in a local network.

Notes

- The basic functions of IGMP must be configured.

Configuration Steps

- If necessary, the querier timeout can be configured.
- If there is no special requirement, you can perform the configuration on all interfaces enabled with IGMP in the local network.

Verification

Run the **show ip igmp interface** *interface-type interface-number* command to display the interface configurations.

Related Commands

↘ Configuring the Querier Timeout

Command	ip igmp query-timeout <i>seconds</i>
Parameter Description	<i>seconds</i> : Indicates the keepalive time of the querier, ranging from 60 to 300s. The default value is 255s.
Command Mode	Interface configuration mode
Usage Guide	After sending Query packets, an interface waits for Query packets sent by other devices. If timeout occurs, the IGMP router assumes that the querier is unique in the directly connected network segment.

Configuration Example

↘ Configuring the Querier Timeout

Scenario	<ul style="list-style-type: none"> ● Configure basic functions of IGMP. ● Set the querier timeout to 280S.
	<pre>VSU(config-if-GigabitEthernet 0/5)#ip igmp query-timeout 280</pre>

<p>Scenario</p>	<ul style="list-style-type: none"> ● Configure basic functions of IGMP. ● Specify the IGMPv3. ● Configure the last-member query interval to 15 (1.5s). ● Configure the number of the last-member queries to 3. ● Configure the common member query interval to 130s. ● Configure the maximum response time to 15s.
	<pre>VSU(config-if-GigabitEthernet 0/5)#ip igmp version 3 VSU(config-if-GigabitEthernet 0/5)#ip igmp last-member-query-count 3 VSU(config-if-GigabitEthernet 0/5)#ip igmp last-member-query-interval 15 VSU(config-if-GigabitEthernet 0/5)#ip igmp query-interval 130 VSU(config-if-GigabitEthernet 0/5)#ip igmp query-max-response-time 15</pre>
<p>Verification</p>	<p>Run the show ip igmp interface <i>interface-type interface-number</i> command to check the IGMP functions of the interface.</p>
	<pre>VSU#show ip igmp interface gigabitEthernet 0/5 Interface GigabitEthernet 0/5 (Index 5) IGMP Enabled, Active, Querier, Version 3 Internet address is 192.168.1.90 IGMP interface limit is 1024 IGMP interface has 1 group-record states IGMP interface has 0 static-group records IGMP activity: 11 joins, 0 leaves IGMP query interval is 130 seconds IGMP querier timeout is 280 seconds IGMP max query response time is 15 seconds Last member query response interval is 15 Last member query count is 3 Group Membership interval is 275 seconds Robustness Variable is 2 VSU#</pre>

Common Errors

- The basic functions of IGMP are not enabled.

16.4.4Configuring IGMP Group Filtering

Configuration Effect

- A router filters IGMP group members.

Notes

- The basic functions of IGMP must be configured.

Configuration Steps

➤ **Configuring the IGMP Group ACL**

Optional.

If there is no special requirement, you can perform this configuration on all router interfaces directly connected to the local network.

➤ **Configuring the Maximum Number of IGMP Group Members**

Optional.

If there is no special requirement, you can perform this configuration on all router interfaces directly connected to the local network.

Verification

➤ **IGMP Group ACL**

- Configure an interface to allow only groups in ACL 1 to join. The access addresses of ACL 1 are 225.0.0.1~225.0.0.255.
- Configure the interface to join a group whose address is 225.0.0.5.
- Configure the interface to join a group whose address is 236.0.0.5.
- View the group information of the current interface.

➤ **Maximum Number of IGMP Group Members**

- Set the maximum member quantity to 5 on an interface.
- Configure the interface to join a group whose address is from 225.0.0.5 to 225.0.0.10.
- View the group information of the interface.

Related Commands

➤ **Configuring the IGMP Group ACL**

Command	ip igmp access-group <i>access-list</i>
Parameter	<i>access-list</i> : Defines a group address range by using a standard IP ACL or an extended ACL. The value ranges from 1 to 199, 1300 to 2699 and characters.
Description	
Command Mode	Interface configuration mode
Usage Guide	Configure this command on an interface to control the groups that hosts in a directly connected network segment can join. Use an ACL to limit the group address range. If Report packets denied by the ACL are received, the packets will be discarded. When IGMPv3 is enabled, this command supports an extended ACL. If the received IGMP Report information is (S1,S2,S3...Sn,G), this command will apply the corresponding ACL to the (0,G) information for matching. Therefore, you must configure a (0,G) record explicitly for the extended ACL in order to normally filter (S1,S2,S3...Sn,G).

➤ **Configuring the Maximum Number of IGMP Group Members**

Command	ip igmp limit <i>number</i> [except <i>access-list</i>]
Parameter Description	<p><i>number</i>: Indicates the maximum number of IGMP group members, whose value range varies with devices. The default value is 1,024 for an interface and 65,536 globally.</p> <p>except <i>access-list</i>: Indicates that the groups in the ACL are not counted.</p> <p>access-list indicates a standard IP ACL. The value ranges from 1 to 99, 1300 to 1999 and words.</p>
Command Mode	Interface configuration mode
Usage Guide	<p>Global configuration mode: Limits the maximum quantity of the IGMP group members in a system.</p> <p>Interface configuration mode: limits the maximum quantity of IGMP group members on an interface.</p> <p>If the quantity of group members exceeds the interface or global limit, the Report packets received subsequently will be ignored.</p> <p>If an Except ACL is configured, Report packets within a specified range can be normally processed; therefore, the generated group members are not counted.</p> <p>The interface and global configurations can be performed independently. If the global quantity limit is smaller than that for an interface, the global configuration shall be used.</p>

Configuration Example

↘ **Configuring IGMP Group Filtering**

Scenario	<ul style="list-style-type: none"> ● Configure the basic functions of IGMP. ● Configure the access address range of ACL 1 from 225.0.0.1 to 225.0.0.255. ● Set the address of the group to be joined to 225.0.0.5. ● Set the address of the group to be joined to 236.0.0.5.
	<pre>VSU(config)#access-list 1 permit 225.0.0.1 225.0.0.255 VSU(config-if-GigabitEthernet 0/5)#ip igmp access-group 1 VSU(config-if-GigabitEthernet 0/5)#ip igmp join-group 225.0.0.5 VSU(config-if-GigabitEthernet 0/5)#ip igmp join-group 236.0.0.5</pre>
Verification	Run the show ip igmp groups [<i>interface-type interface-number</i>] [<i>group-address</i>] [detail] command to display the group information of the interface.
	<pre>VSU(config-if-GigabitEthernet 0/5)#show ip igmp groups IGMP Connected Group Membership Group Address Interface Uptime Expires Last Reporter 225.0.0.5 GigabitEthernet 0/5 00:14:00 00:02:45 192.168.1.90</pre>

↘ **Configuring the Maximum Number of IGMP Group Members**

Scenario	<ul style="list-style-type: none"> ● Configure the basic functions of IGMP. ● Configure the maximum number of IGMP group members for the interface to 5. ● Add group information (225.0.0.5~225.0.0.12). ● View group information.
	<pre>VSU(config-if-GigabitEthernet 0/5)#ip igmp limit 5</pre>

	<pre>VSU(config-if-GigabitEthernet 0/5)# VSU(config-if-GigabitEthernet 0/5)#ip igmp join-group 225.0.0.5 VSU(config-if-GigabitEthernet 0/5)#ip igmp join-group 225.0.0.6 VSU(config-if-GigabitEthernet 0/5)#ip igmp join-group 225.0.0.7 VSU(config-if-GigabitEthernet 0/5)#ip igmp join-group 225.0.0.8 VSU(config-if-GigabitEthernet 0/5)#ip igmp join-group 225.0.0.9 VSU(config-if-GigabitEthernet 0/5)#ip igmp join-group 225.0.0.10 VSU(config-if-GigabitEthernet 0/5)#ip igmp join-group 225.0.0.11 VSU(config-if-GigabitEthernet 0/5)#ip igmp join-group 225.0.0.12</pre>
<p>Verification</p>	<p>Run the show ip igmp groups [<i>interface-type interface-number</i>] [<i>group-address</i>] [detail] command to display the group information of the interface.</p>
	<pre>VSU(config-if-GigabitEthernet 0/5)#show ip igmp groups IGMP Connected Group Membership Group Address Interface Uptime Expires Last Reporter 225.0.0.5 GigabitEthernet 0/5 00:20:15 00:03:09 192.168.1.90 225.0.0.6 GigabitEthernet 0/5 00:20:24 00:02:58 192.168.1.90 225.0.0.7 GigabitEthernet 0/5 00:00:15 00:04:29 192.168.1.90 225.0.0.8 GigabitEthernet 0/5 00:00:13 00:04:34 192.168.1.90 225.0.0.9 GigabitEthernet 0/5 00:00:11 00:04:33 192.168.1.90</pre>

Common Errors

- The basic functions of IGMP are not enabled.

16.4.5Configuring IGMP Proxy

Configuration Effect

- Configure the router proxy function and collect local member information.

Notes

- The basic functions of IGMP must be configured.

Configuration Steps

↘ Configuring the IGMP Proxy Service

- Optional.
- If there is no special requirement, you can perform this configuration on directly connected upstream router interfaces.

↘ Configuring the IGMP Mroute Proxy

- Optional.

- If there is no special requirement, you can perform this configuration on directly connected downstream host interfaces.

Verification

- Set interface 7 for directly connecting to an upstream router as a multicast proxy server.
- Set interface 1 for directly connecting to a downstream host as a multicast proxy.
- Set interface 1 to be joined by groups whose addresses are 225.0.0.6 and 225.5.5.5.
- View the current group information.

Related Commands

📄 **Configuring the IGMP Proxy Service**

Command	ip igmp proxy-service
Parameter	N/A
Description	
Command Mode	Interface configuration mode
Usage Guide	<p>Run the ip igmp proxy-service command to set the uplink interface as a Proxy-Service interface.</p> <p>Run the ip igmp mroute-proxy command to set the downlink interface as a Mroute-Proxy interface.</p> <p>Forward IGMP Query packets from the Proxy-Service interface to the Mroute-Proxy interface. Forward IGMP Report packets from the Mroute-Proxy interface to the Proxy-Service interface.</p> <p>A device allows a maximum of 32 Proxy-Service interfaces. After a Proxy-Service interface receives an IGMP Query packet, the interface sends a response based on the IGMP group member records.</p> <p>If the switchport command is executed on the Proxy-Service interface, the ip igmp mroute-proxy command configured on the Mroute-Proxy interface will be deleted automatically.</p>

📄 **Configuring the IGMP Mroute Proxy**

Command	ip igmp mroute-proxy <i>interface-type interface-number</i>
Parameter	N/A
Description	
Command Mode	Interface configuration mode
Usage Guide	<p>Run the ip igmp proxy-service command to set the uplink interface as a Proxy-Service interface.</p> <p>Run the ip igmp mroute-proxy command to set the downlink interface as a Mroute-Proxy interface.</p> <p>Forward IGMP Query packets from the Proxy-Service interface to the Mroute-Proxy interface. Forward IGMP Report packets from the Mroute-Proxy interface to the Proxy-Service interface.</p>

Configuration Example

Scenario	<ul style="list-style-type: none"> ● Configure basic functions of IGMP. ● Configure interface 7 as a proxy server. ● Configure interface 1 as a multicast proxy. ● Set interface 1 to be joined by groups whose addresses are 225.0.0.6 and 225.5.5.5.
	<pre>VSU(config-if-GigabitEthernet 0/7)#ip igmp proxy-service VSU(config-if-GigabitEthernet 0/7)#exit</pre>

	<pre>VSU(config)#int gi 0/1 VSU(config-if-GigabitEthernet 0/1)#ip igmp mroute-proxy gigabitEthernet 0/7 VSU(config-if-GigabitEthernet 0/1)#ip igmp join-group 225.0.0.6 VSU(config-if-GigabitEthernet 0/1)#ip igmp join-group 225.5.5.5</pre>
Verification	<p>Run the show ip igmp groups [<i>interface-type interface-number</i>] [<i>group-address</i>] [detail] command to display the group information of the interface.</p>
	<pre>VSU(config-if-GigabitEthernet 0/1)#show ip igmp groups IGMP Connected Group Membership Group Address Interface Uptime Expires Last Reporter 225.0.0.6 GigabitEthernet 0/1 00:23:05 00:02:40 192.168.36.90 225.5.5.5 GigabitEthernet 0/1 00:22:06 00:02:41 192.168.36.90 IGMP Proxy-server Connected Group Membership Group Address Interface Uptime 225.0.0.6 GigabitEthernet 0/7 00:23:05 225.5.5.5 GigabitEthernet 0/7 00:22:06 VSU(config-if-GigabitEthernet 0/1)#</pre>

Common Errors

- The basic functions of IGMP are not enabled.

16.4.6 Configuring IGMP SSM Mapping

Configuration Effect

- IGMPv3 supports source filtering; however, IGMPv1 and IGMPv2 do not support source filtering, but provides the SSM mapping function to filter sources.

Notes

- The basic functions of IGMP must be configured.

Configuration Steps

➤ **Enabling SSM Mapping**

(Mandatory) Enable the SSM mapping function.

Enable the SSM mapping function on a router.

➤ **Configuring Static SSM Mapping**

Optional.

Configure this function on routers enabled with SSM mapping.

Verification

Run the **show ip igmp ssm-mapping** [*group-address*] command to display SSM mapping information.

Related Commands

↘ **Enabling SSM Mapping**

Command	ip igmp ssm-map enable
Parameter Description	N/A
Command Mode	Global configuration mode
Usage Guide	Run the ip igmp ssm-map enable command to enable the SSM mapping function. Run the ip igmp ssm-map static command to set static mapping entries. Run IGMPv3 on the interface. When IGMPv1 or IGMPv2 Report packets are received, source addresses of static mappings can be added.

↘ **Configuring Static SSM Mapping**

Command	ip igmp ssm-map static <i>access-list source-address</i>
Parameter Description	<i>N/Access-list</i> : Indicates the group address range set by a standard IP ACL. The value ranges from 1 to 99, 1300 to 1999 and words. <i>source-address</i> : Indicates the source address.
Command Mode	Global configuration mode
Usage Guide	Run the ip igmp ssm-map enable command to enable the SSM mapping function. Run the ip igmp ssm-map static command to set static mapping entries. Run IGMPv3 on the interface. When IGMPv1 or IGMPv2 Report packets are received, source addresses of static mappings can be added.

Configuration Example

Scenario	<ul style="list-style-type: none"> ● Configure the basic functions of IGMP. ● Enable SSM mapping. ● Configure static SSM mapping ACL 1.
	<pre>VSU(config)#ip igmp ssm-map enable VSU(config)#ip igmp ssm-map static 1 192.168.5.9</pre>
Verification	Run the show ip igmp ssm-mapping [group-address] command to display SSM mapping information.
	<pre>VSU#show ip igmp ssm-mapping SSM Mapping : Enabled Database : Static mappings configured</pre>

Common Errors

- The basic functions of IGMP are not enabled.

16.4.7 Configuring Alert Option

Configuration Effect

Check whether IGMP packets contain the Router Alert option and discards the packets without the Router Alert option.

Support sending IGMP packets with the Router Alert option.

Notes

The basic functions of IGMP must be configured.

Configuration Steps

Checking Router Alert Option

Optional.

Sending IGMP Packets with Router Alert Option Encapsulated

Optional,

Verification

▾ Checking Router Alert Option

Check whether the IGMP-enabled interface discards the IGMP packets without the Router Alert option.

▾ Sending IGMP Packets with Router Alert Option Encapsulated

Check whether the IGMP-enabled interface sends the IGMP packets containing the Router Alert option.

Related Commands

▾ Checking Router Alert Option

Command	ip igmp [vrf vrf-name] enforce-router-alert
Parameter Description	vrf vrf-name : Specifies a VRF.
Command Mode	Global configuration mode
Usage Guide	Run the ip igmp enforce-router-alert command to enable Router Alert option check. Run the no ip igmp enforce-router-alert command to disable Router Alert option check.

▾ Sending IGMP Packets with Router Alert Option Encapsulated

Command	ip igmp [vrf vrf-name] send-router-alert
Parameter	vrf vrf-name : Specifies a VRF.

Description	
Command Mode	Global configuration mode
Usage Guide	Run the ip igmp send-router-alert command to enable the function of sending IGMP packets containing Router Alert option. Run the no ip igmp send-router-alert command to disable the function.

Configuration Example

↘ Checking Router Alert Option

Scenario	Configure the basic functions of IGMP. Configure Router Alert option check.
	<pre>VSU(config)#ip igmp enforce-router-alert</pre>
Verification	IGMP packets containing Router Alert option 225.1.1.1 are sent to the IGMP-enabled interface and these packets are processed. Run the show ip igmp groups command and you will see 225.1.1.1. IGMP packets not containing Router Alert option 225.1.1.1 are sent to the IGMP-enabled interface and these packets are discarded. Run the show ip igmp groups command and you will not see 225.1.1.1

↘ Sending IGMP Packets with Router Alert Option Encapsulated

Scenario	Configure the basic functions of IGMP. Configure the function of sending IGMP packets containing router alert option.
	<pre>VSU(config)#ip igmp send-router-alert</pre>
Verification	Check whether the IGMP-enabled interface sends the IGMP packets containing the Router Alert option.

16.5 Monitoring

Clearing

Description	Command
Clears dynamic group membership from the IGMP buffer.	clear ip igmp group
Clears interface information from the IGMP buffer.	clear ip igmp interface <i>interface-type interface-number</i>

Displaying

Description	Command
Displays all groups in a directly connected subnet.	show ip igmp groups
Displays details about all groups in a	show ip igmp groups detail

directly connected subnet.	
Displays specified groups in a directly connected subnet.	show ip igmp groups <i>A.B.C.D</i>
Displays details about specified groups in a directly connected subnet.	show ip igmp groups <i>A.B.C.D detail</i>
Displays IGMP configurations of a specified interface in a directly connected subnet.	show ip igmp interface <i>interface-type interface-number</i>
Displays details about all groups of a specified interface in a directly connected subnet.	show ip igmp groups <i>interface-type interface-number detail</i>
Displays information about a specified group of a specified interface in a directly connected subnet.	show ip igmp groups <i>interface-type interface-number A.B.C.D</i>
Displays details about a specified group of a specified interface in a directly connected subnet.	show ip igmp groups <i>interface-type interface-number A.B.C.D detail</i>
Displays configurations of an IGMP interface.	show ip igmp interface [<i>interface-type interface-number</i>]
Displays configurations of all IGMP interfaces.	show ip igmp interface
Displays configurations of IGMP SSM mapping.	show ip igmp ssm-mapping
Displays the information of IGMP SSM mapping to <i>A.B.C.D</i> .	show ip igmp ssm-mapping <i>A.B.C.D</i>

Debugging

Description	Command
Displays whether IGMP debugging is enabled.	show debugging
Debugs all IGMP information.	debug ip igmp all
Debugs IGMP packet decoding.	debug ip igmp decode
Debugs IGMP packet encoding.	debug ip igmp encode
Debugs IGMP events.	debug ip igmp events
Debugs IGMP FSM.	debug ip igmp fsm
Debugs IGMP state machine.	debug ip igmp tib
Debugs IGMP warning.	debug ip igmp warning

17 Configuring MLD

17.1 Overview

Multicast Listener Discovery (MLD) is a protocol used in the multicast technology.

This protocol receives the multicast member relationship between hosts and routers to determine multicast flow forwarding. Using information obtained from MLD, a device maintains an interface-based multicast listener status table. The multicast listener status table is activated only when at least one host in the link of the interface is a group member.

Currently, MLD has two versions: MLDv1 and MLDv2.

- MLD of both versions supports the Any-Source Multicast (ASM) model.
- MLDv2 can be directly applied to the Source-Specific Multicast (SSM) model.
- MLDv1 can be applied to the SSM model only when MLD SSM mapping is configured.

Protocols and Standards

- RFC2710: Multicast Listener Discovery (MLDv1) for IPv6
- RFC3810: Multicast Listener Discovery Version 2 (MLDv2) for IPv6

17.2 Applications

Application	Description
Configuring the MLD Service on the Local Network	Implements the MLD service on the local network.
Configuring the MLD Proxy Service	In the simple tree topology, the MLD proxy service, instead of the PIM service, is used.

17.2.1 Configuring the MLD Service on the Local Network

Scenario

As shown in Figure 4- 1, the local network consists of receiver 1, receiver 2, router A, and router B.

Query messages sent by router A or router B are valid on the local network, and Report messages sent by receiver A and receiver B are also valid on the local network.

Figure 4- 1

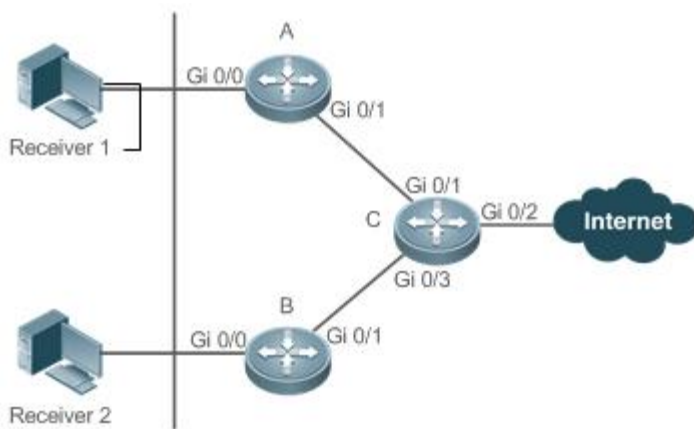

Remarks	Router C is the egress gateway. Routers A and B are local routers.
----------------	---

Deployment

- Routers A, B, and C run the OSPFv6 protocol.
- Interfaces on routers A, B, and C run the multicast protocol (PIM SMv6).

17.2.2 Configuring the MLD Proxy Service

Scenario

As shown Figure 4-2, the proxy function is enabled on router A. Router A functions as a host and forms a local management group with router B. Router A forwards Report messages from receivers 1 and 2.

Figure 4-2

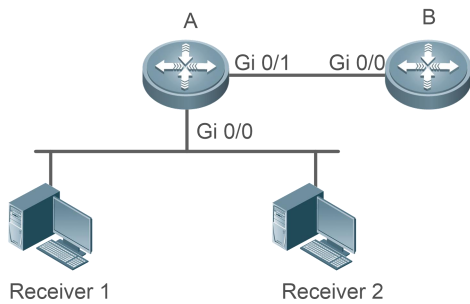

Remarks	Router A functions as the proxy. Router B provides the PIM service.
----------------	--

Deployment

- Routers A and B run the OSPFv6 protocol.
- Interfaces on routers A and B run the multicast protocol (PIM SMv6).
- The multicast proxy service is enabled on Gi 0/0 and Gi 0/1 of router A.

17.3 Features

Basic Concepts

Host Behaviors and Device Behaviors

Layer-3 multicast devices running multicast management protocols are referred to as devices and their behaviors are device behaviors.

PCs or simulated PCs running multicast management protocols are referred to as hosts and their behaviors are host behaviors.

Querier

Devices interact and compete with each other. After IP address comparison, the device with a lower IP address becomes the querier and periodically sends Query messages.

MLD PROXY-SERVICE Interface

This interface, also called uplink interface, implements host behaviors. It receives Query messages sent by upstream devices and sends Report messages collected by the router proxy.

MLD MROUTE-PROXY Interface

This interface, also called downlink interface, implements router functions. It sends messages received by the proxy service interface and collects and sends host information to the proxy service interface.

↘ MLD SSM-MAP

SSM mapping refers to mapping of source-specific multicast. MLDv1 does not support the SSM model until the SSM-MAP function is enabled.

Overview

Feature	Description
Setting MLD Router Parameters	Sends Query messages to obtain local member information.
Querier Selection Process or Timeout Mechanism	Selects the unique querier in the current network segment.
Filtering MLD Groups	Filters group members and limits the number of group members.
Supporting Static MLD Groups	Stores static group information on the local router instead of obtaining group information by sending Report messages.
Configuring Simulated Host Group Information	Simulates host behaviors to directly configure group joining information.
Supporting MLD Proxy	Uses this function in the simple tree topology instead of complex multicast routing protocols, such as the PIM.
Supporting SSM-MAP	Provides the SSM model for MLDv1. When a host is added to a group, a specific source can be specified to avoid network bandwidth occupation by unnecessary and invalid multicast data streams. This function is especially useful on a network where multiple multicast sources share the same multicast address.

17.3.1 Setting MLD Router Parameters

Sends Query messages to obtain local member information.

Working Principle

A device periodically sends Query messages to ensure that a group has at least one host. If no host is available in a group, the group will be deleted.

Related Configuration

↘ Enabling MLD

By default, MLD is disabled on an interface.

Run the **ipv6 pim { sparse-mode }** command to enable or disable MLD on an interface.

MLD can be enabled only after PIM SM is enabled on the interface.

↘ Configuring MLD Version

By default, the MLD version is 2.

Run the **ipv6 mld version { 1 | 2 }** command to configure or restore the MLD version of an interface.

✚ **Configuring the Query Interval of the Last Member**

By default, the interval for sending Query messages is 1s.

Run the **ipv6 mld last-member-query-interval** *interval* command to configure or restore the interval for sending Query messages.

A larger value means a longer interval for sending Query messages.

✚ **Configuring the Number of Times for Querying the Last Member**

By default, the number of times for querying the last member is 2.

Run the **ipv6 mld last-member-query-count** *count* command to configure or restore the number of times for querying the last member.

A larger value means a larger number of times for querying the last member.

✚ **Configuring the Interval for Querying a Common Member**

By default, the interval for querying a common member is 125s.

Run the **ipv6 mld query-interval** *seconds* command to configure or restore the interval for querying a common member.

A larger value means a longer interval for querying a common member.

✚ **Configuring the Maximum Response Time**

By default, the maximum response time is 10s.

Run the **ipv6 mld query-max-response-time** *seconds* command to configure or restore the maximum response time.

A larger value means a longer maximum response time.

17.3.2 Querier Selection Process or Timeout Mechanism

Selects the unique querier in the current network segment. The querier sends a Query message to obtain group information on the local network.

Working Principle

On a multicast network running MLD, a multicast device dedicated to query sends MLD Query messages. The device is determined by election. Initially, all devices are in the querier state. When receiving member relationship Query messages from devices with lower IP addresses, the devices switch from the receiver state to non-querier state. Therefore, there is only one device in the query state in the end. This device has the lowest IP address among all multicast devices on the network. When the querier device does not work, MLD also works. Non-querier devices maintain the keepalive interval timer for other queriers. The timer is reset once the device receives a member relationship query message. If the timer times out, the device starts to send Query messages and a new querier election starts.

Related Configuration

✚ **Configuring the Keepalive Interval of the Querier**

By default, the keepalive interval of the querier is 255s.

Run the **ipv6 mld querier-timeout** *seconds* command to configure or restore the keepalive interval of the querier.

A larger value means a longer keepalive interval of the querier.

17.3.3 Filtering MLD Groups

Filters group members and limits the number of group members.

Working Principle

If you do not want hosts in the network segment where an interface resides to be added to certain multicast groups, you can configure ACL rules on the interface as a filter. The interface will filter received MLD member relationship Report messages based on the ACL rules and maintain member relationships only for multicast groups permitted by the rules. The largest number of router members can also be set.

Related Configuration

📄 Configuring Access Control for Multicast Groups

By default, no access control is configured and hosts can be added to any groups.

Run the **ipv6 mld access-group** *access-list-name* command to configure or restore access control for multicast groups.

After the configuration, the router can receive messages only from hosts in groups specified in the access list.

📄 Configuring the Maximum Number of MLD Group Members

By default, an MLD group has a maximum of 1024 members.

Run the **ipv6 mld limt** *number* command to configure or restore the maximum number of MLD group members.

A larger value means a larger number of group members.

17.3.4 Supporting Static MLD Groups

Stores static group information on a local router instead of obtaining group information by sending Report messages. The local router can directly exchange group information with the PIM router.

Working Principle

Manually configure static group information.

Related Configuration

📄 Configuring Static-Group

By default, no static group information is configured.

Run the **ipv6 mld static-group** *group-address* command to configure or cancel static group information.

17.3.5 Configuring Simulated Host Group Information

Simulates host behaviors to directly configure group joining information.

Related Configuration

📄 Configuring Join-Group

By default, no join-group information is configured.

Run the **ipv6 mld join-group** *group-address* command to configure or cancel join-group information.

17.3.6 Supporting MLD Proxy

In the simple tree topology, it is not necessary to run complex multicast routing protocols (such as PIM). In this case, MLD proxy can be used to send MLD messages for downstream hosts and maintain member relationships.

Working Principle

When an upstream router is configured as an MLD proxy service interface, it functions as a host and can receive Query messages from upstream routers as well as forward group information of downstream hosts. When a downstream router is configured as an MLD multicast proxy interface, it functions as a router and can forward Query messages of upstream routers as well as receive Report messages from downstream routers.

Related Configuration

✚ Configuring MLD PROXY-SERVICE

By default, the MLD proxy service is disabled on an interface.

Run the **ipv6 mld proxy-service** command to configure or cancel the MLD proxy function on an interface.

This function must be configured when proxy is used.

✚ Configuring MLD MROUTE-PROXY

By default, the multicast proxy service is disabled on an interface.

Run the **ipv6 mld mroute-proxy** interfacename command to configure or cancel the multicast proxy function on an interface.

This function must be configured when proxy is used.

17.3.7 Supporting SSM-MAP

This function provides the SSM model for MLDv1. When a host is added to a group, a specific source can be specified to avoid network bandwidth occupation by unnecessary and invalid multicast data streams. This function is especially useful on a network where multiple multicast sources share the same multicast address.

Working Principle

Based on MLDv1, MLDv2 provides an extra function, that is, source filtering multicast. In MLDv1, a host determines to join a group only based on the group address and receives multicast streams sent to the group address from any source. However, an MLDv2 host advertises the multicast group that the host wants to join and the address of the multicast source that it wants to receive. In MLDv1, source address filtering can be implemented to some extent, but filtering is implemented by enabling SSM-MAP and configuring SSM-MAP static groups on multicast flow receivers.

Related Configuration

✚ Enabling MLD SSM-MAP

By default, SSM-MAP is disabled.

Run the **ipv6 mld ssm-map enable** command to enable or disable the SSM-MAP function.

This function must be enabled when SSM-MAP is used.

✚ Configuring MLD SSM-MAP STATIC

By default, no SSM-MAP static link table is configured.

Run the **ipv6 mld ssm-map static** *access-list-num A.B.C.D* command to enable or disable the SSM-MAP static link table.

17.4 Configuration

Configuration	Description and Command	
Configuring Basic Functions of MLD	(Mandatory) It is used to configure the multicast service.	
	ipv6 multicast-routing	Enables the IPv6 multicast routing function.
	ipv6 pim sparse-mode	Enables the PIM-SM function.
Configuring MLD Router Parameters	ipv6 mld version { 1 2 }	Configures the MLD version.
	ipv6 mld last-member-query-interval <i>interval</i>	Configures the interval for querying the last member.
	ipv6 mld last-member-query-count <i>count</i>	Configures the number of times for querying the last member.
	ipv6 mld query-interval <i>seconds</i>	Configures the interval for querying a common member.
	ipv6 mld query-max-response-time <i>seconds</i>	Configures the maximum response interval.
Querier Selection Process or Timeout Mechanism	ipv6 mld querier-timeout <i>seconds</i>	Configures the keepalive interval of the querier.
Filtering MLD Groups	ipv6 mld access-group <i>access-list</i>	Filters MLD group members.
MLD Proxy	ipv6 mld proxy-service	Configures the MLD PROXY-SERVICE.
	ipv6 mld mroute-proxy <i>interface-type interface-number</i>	Configures the MLD MROUTE-PROXY.
Supporting SSM-MAP	ipv6 mld ssm-map enable	Enables the SSM-MAP function.
	ipv6 mld ssm-map static <i>access-list source-address</i>	Configures the SSM-MAP static link table.

17.4.1 Configuring Basic Functions of MLD

Configuration Effect

- Enable the multicast routing function and collect group information on the local network.

Notes

- The PIM SM function must be enabled on an interface.

Configuration Steps

➤ Enabling the IPv6 Multicast Routing Function

- Mandatory.
- The IPv6 multicast routing function should be enabled on all routers on the local network unless otherwise specified.

➤ Enabling the PIM SM Function

- Mandatory.

- The PIM SM function should be directly enabled on an interface on the local network unless otherwise specified.

Verification

Run the **show ipv6 mld interface *interface-type* *interface-number*** command to check whether MLD is enabled on the interface.

Related Commands

↘ **Enabling the IPv6 Multicast Routing Function**

Command	ipv6 multicast-routing
Parameter	N/A
Description	
Command Mode	Global configuration mode
Usage Guide	-

↘ **Enabling the PIM SM Function**

Command	ipv6 pim { sparse-mode }
Parameter	-
Description	
Command Mode	Interface configuration mode
Usage Guide	PIM interfaces must be layer-3 interfaces, including: routing, L3AP, SVI, and loopback interfaces. IPv6 unicast routes should be accessible to all PIM interfaces.

Configuration Example

↘ **Enabling MLD on the Local Network**

Configuration Steps	<ul style="list-style-type: none"> ● Configure an IPv6 unicast routing protocol (such as OSPF) on a router and ensure that unicast routes are accessible to the loopback interface. (Omitted) ● Enable the IPv6 multicast routing function on all routers. ● Enable the PIM SM function on device interconnection interfaces and interfaces for connecting user hosts and multicast sources.
	<pre>VSU(config)#ipv6 multicast-routing VSU(config)#int gi 0/1 VSU(config-if-GigabitEthernet 0/1)# ipv6 address 2001::1/64 VSU(config-if-GigabitEthernet 0/1)#ipv6 pim sparse-mode</pre>
Verification	Run the show ipv6 mld interface <i>interface-type</i> <i>interface-number</i> command to check whether MLD is enabled on the interface.
	<pre>VSU#show ipv6 mld interface gigabitEthernet 0/1 Interface GigabitEthernet 0/1 (Index 1) MLD Active, Querier, Version 2 (default)</pre>

```

Internet address is fe80::2d0:f8ff:fe22:33b1
MLD interface limit is 1024
MLD interface has 0 group-record states
MLD interface has 0 join-group records
MLD interface has 0 static-group records
MLD activity: 0 joins, 0 leaves
MLD query interval is 125 seconds
MLD querier timeout is 255 seconds
MLD max query response time is 10 seconds
Last member query response interval is 10 (1/10s)
Last member query count is 2
Group Membership interval is 260
Robustness Variable is 2

```

Common Errors

- Multicast routing is disabled on routers on the network.
- No multicast interface is available on the network.

17.4.2 Configuring MLD Router Parameters

Configuration Effect

- Modify MLD router parameters to change the message type or sending mode.

Notes

- The basic functions of MLD must be configured.

Configuration Steps

▾ Configuring MLD Version

Optional.

This parameter can be configured on all router interfaces directly connected to the local network unless otherwise specified.

▾ Configuring the Interval for Querying the Last Member

Optional.

This parameter can be configured on all router interfaces directly connected to the local network unless otherwise specified.

▾ Configuring the Number of Times for Querying the Last Member

Optional.

This parameter can be configured on all router interfaces directly connected to the local network unless otherwise specified.

➤ **Configuring the Interval for Querying a Common Member**

Optional.

This parameter can be configured on all router interfaces directly connected to the local network unless otherwise specified.

➤ **Configuring the Maximum Response Interval**

Optional.

This parameter can be configured on all router interfaces directly connected to the local network unless otherwise specified.

Verification

Run the **show ipv6 mld interface** *interface-type interface-number* command to view the configuration information.

Related Commands

➤ **Configuring the MLD Version**

Command	ipv6 mld version { 1 2 }
Parameter	1: Indicates version 1.
Description	2: Indicates version 2.
Command Mode	Interface configuration mode
Usage Guide	After this command is executed, MLD will automatically restart.

➤ **Configuring the Interval for Querying the Last Member**

Command	ipv6 mld last-member-query-interval <i>interval</i>
Parameter Description	<i>Interval</i> : Specifies the interval for sending Query messages of a specified group. The unit is 0.1s, the value ranges from 1 to 255, and the default value is 10 (1s).
Command Mode	Interface configuration mode
Usage Guide	After receiving the Done message, the interface will continuously send Query messages of a specified group and wait for responses from the host. After timeout, it is considered that the no group member exists in the directly-connected network segment and the interface is deleted from the MLD group member record. The timeout interval is calculated as follows: Timeout interval = last-member-query-interval x last-member-query-count + query-max-response-time/2.

➤ **Configuring the Number of Times for Querying the Last Member**

Command	ipv6 mld last-member-query-count <i>count</i>
Parameter Description	<i>count</i> : Specifies the number of times for sending Query messages of a specified group. The value ranges from 2 to 7. The default value is 2.
Command Mode	Interface configuration mode
Usage Guide	After receiving the Done message, the interface will continuously send Query messages of a specified group and wait for responses from the host. After timeout, it is considered that the no group member exists in the directly-connected network segment and the interface is deleted from the MLD group member record. The timeout interval is calculated as follows:

	Timeout interval = last-member-query-interval x last-member-query-count + query-max-response-time/2
--	---

✚ Configuring the Interval for Querying a Common Member

Command	ipv6 mld query-interval <i>seconds</i>
Parameter	<i>seconds</i> : Specifies the interval for querying a common member. The unit is s, the value ranges from 1 to 18000, and the default value is 125.
Description	
Command Mode	Interface configuration mode
Usage Guide	-

✚ Configuring the Maximum Response Interval

Command	ipv6 mld query-max-response-time <i>seconds</i>
Parameter	<i>seconds</i> : Specifies the maximum response time. The unit is s, the value ranges from 1 to 25, and the default value is 10.
Description	
Command Mode	Interface configuration mode
Usage Guide	After sending Query messages, the interface waits for responses. After timeout, it is considered that no group member exists in the directly-connected network segment and group information is deleted.

Configuration Example

✚ Configuring Basic Router Parameters

Configuration Steps	<ul style="list-style-type: none"> ● Configure basic functions of MLD. (Omitted) ● Configure MLD version 2. ● Configure the interval for querying the last member as 15 (1.5s). ● Configure the number of times for querying the last member as 3. ● Configure the interval for querying the common member as 130s. ● Configure the maximum response time as 15s.
	<pre>VSU(config-if-GigabitEthernet 0/1)#ipv6 mld version 2 VSU(config-if-GigabitEthernet 0/1)#ipv6 mld last-member-query-count 3 VSU(config-if-GigabitEthernet 0/1)#ipv6 mld last-member-query-interval 15 VSU(config-if-GigabitEthernet 0/1)#ipv6 mld query-interval 130 VSU(config-if-GigabitEthernet 0/1)#ipv6 mld query-max-response-time 15</pre>
Verification	Run the show ipv6 mld interface <i>interface-type interface-number</i> command to check whether MLD is enabled on the interface.

```

VSU(config-if-GigabitEthernet 0/1)# show ipv6 mld interface gi 0/1

Interface GigabitEthernet 0/1 (Index 1)

  MLD Enabled, Active, Querier, Version 2 (default)

  Internet address is fe80::2d0:f8ff:fe22:33b1

  MLD interface limit is 1024

  MLD interface has 0 group-record states

  MLD interface has 0 join-group records

  MLD interface has 0 static-group records

  MLD activity: 0 joins, 0 leaves

  MLD query interval is 130 seconds

  MLD querier timeout is 267 seconds

  MLD max query response time is 15 seconds

  Last member query response interval is 15 (1/10s)

  Last member query count is 3

  Group Membership interval is 275

  Robustness Variable is 2
    
```

Common Errors

- Basic functions of MLD are not enabled.

17.4.3 Querier Selection Process or Timeout Mechanism

Configuration Effect

- Select the unique querier on the local network.

Notes

- The basic functions of MLD must be configured.

Configuration Steps

- This function must be configured if the querier keepalive interval needs to be configured.
- This function can be configured on all MLD-enabled interfaces on the local network.

Verification

Run the **show ipv6 mld interface** *interface-type interface-number* command to view the configuration information of the interface.

Related Commands

📄 **Configuring the Keepalive Interval of Other Queriers**

Command	ipv6 mld querier-timeout <i>seconds</i>
----------------	--

<p>Configuration Steps</p>	<ul style="list-style-type: none"> ● Configure basic functions of MLD. (Omitted) ● Configure MLD version 2. ● Configure the interval for querying the last member as 15 (1.5s). ● Configure the number of times for querying the last member as 3. ● Configure the interval for querying the common member as 130s. ● Configure the maximum response time as 15s.
	<pre>VSU(config-if-GigabitEthernet 0/1)#ipv6 mld version 2 VSU(config-if-GigabitEthernet 0/1)#ipv6 mld last-member-query-count 3 VSU(config-if-GigabitEthernet 0/1)#ipv6 mld last-member-query-interval 15 VSU(config-if-GigabitEthernet 0/1)#ipv6 mld query-interval 130 VSU(config-if-GigabitEthernet 0/1)#ipv6 mld query-max-response-time 15</pre>
<p>Parameter Description</p>	<p><i>seconds</i>: Specifies the keepalive interval for other queriers. The unit is s, the value ranges from 60 to 300, and the default value is 255.</p>
<p>Command Mode</p>	<p>Interface configuration mode</p>
<p>Usage Guide</p>	<p>After sending Query messages, the interface waits for Query messages from other devices. After timeout, it is considered that it is the unique querier in the directly-connected network segment.</p>

Configuration Example

📌 **Configuring the Keepalive Interval of Other Queriers**

<p>Configuration Steps</p>	<ul style="list-style-type: none"> ● Configure the basic functions of MLD. (Omitted) ● Configure the keepalive interval of a querier as 280s.
	<pre>VSU(config-if-GigabitEthernet 0/1)#ipv6 mld querier-timeout 280</pre>
<p>Verification</p>	<p>Run the show ipv6 mld interface <i>interface-type interface-number</i> command to check whether MLD is enabled on the interface.</p>
	<pre>VSU#show ipv6 mld interface gigabitEthernet 0/1 Interface GigabitEthernet 0/1 (Index 1) MLD Enabled, Active, Querier, Version 2 (default) Internet address is fe80::2d0:f8ff:fe22:33b1 MLD interface limit is 1024 MLD interface has 0 group-record states MLD interface has 0 join-group records MLD interface has 0 static-group records MLD activity: 0 joins, 0 leaves MLD query interval is 130 seconds MLD querier timeout is 280 seconds</pre>

MLD max query response time is 15 seconds
 Last member query response interval is 15 (1/10s)
 Last member query count is 3
 Group Membership interval is 275
 Robustness Variable is 2

Common Errors

- The basic functions of MLD are not enabled.

17.4.4 Filtering MLD Groups

Configuration Effect

- A router filters MLD group information.

Notes

- The basic functions of MLD must be configured.

Configuration Steps

↘ Configuring Access Control for Multicast Groups

Optional.

This function can be configured on all router interfaces directly connected to the local network unless otherwise specified.

↘ Configuring the Maximum Number of MLD Group Members

Optional.

This function can be configured on all router interfaces directly connected to the local network unless otherwise specified.

Verification

↘ Filtering MLD Groups

Configure the interface to allow for only groups in link table 1. The access address of link table 1 is (FF66::100/64).

Configure the interface to add a group FF66::05.

Configure the interface to add a group FF65::05.

Check group information on the interface.

↘ Configuring the Maximum Number of MLD Group Members

Configure the number of group members as 5 on the interface.

Configure the interface to add a group (FF66::05 ~ FF65::0B).

Check group information on the interface.

Related Commands

↘ Configuring Access Control for Multicast Groups

Command	ipv6 mld access-group <i>access-list</i>
Parameter Description	<i>access-list</i> : Specifies the group address range by using IP standard ACLs or IP extended ACLs. The value ranges from 1 to 199, 1300 to 2699, and WORD.
Command Mode	Interface configuration mode
Usage Guide	<p>After running this command on the interface, you can control the groups that hosts in the directly-connected network segment can join. Use ACLs to limit the group address range. Report messages denied by the ACLs will be discarded.</p> <p>When MLDv2 is enabled, this command supports extended ACLs to precisely filter source record information in MLDv2 messages. When the received MLD Report message is (S1,S2,S3...Sn,G), this command will match (0,G) using the corresponding ACLs. Therefore, to normally use this command, you must explicitly configure a (0, G) in the extended ACLs to filter (S1,S2,S3...Sn,G).</p>

📌 **Configuring the Maximum Number of MLD Group Members**

Command	ipv6 mld limit <i>number</i> [except <i>access-list</i>]
Parameter Description	<p><i>number</i>: Specifies the maximum number of MLD group members. The value range depends on the specific device. The interface default value is 1024 and the global one is 65536.</p> <p>except <i>access-list</i>: Groups in the access list are not counted. The access list is an IP standard ACL. The value ranges from 1 to 99, 1300 to 1999, and WORD.</p>
Command Mode	Interface configuration mode
Usage Guide	<p>Global configuration mode: Limits the number of MLD group members on the whole device.</p> <p>Interface configuration mode: Limits the number of MLD group members of the interface.</p> <p>If the number of group members exceeds the interface limit or global limit, subsequent Report messages will be ignored.</p> <p>If an except list is configured, Report messages in a specified range can be normally processed. Therefore, the group members are not counted.</p> <p>Interface and global limits can be configured separately. If the global limit is smaller than the interface limit, use the global limit.</p>

Configuration Example

📌 **Configuring Group Filtering**

Configuration Steps	<ul style="list-style-type: none"> ● Configure the basic functions of MLD. (Omitted) ● Configure the access address of link table 1 as (FF66::100/64). ● Configure the group to join as FF66::05. ● Configure the group to join as FF65::05.
	<pre> VSU(config)#ipv6 access-list acl VSU(config-ipv6-acl)#permit ipv6 ::/64 ff66::100/64 VSU(config-ipv6-acl)#permit ipv6 2222::3333/64 ff66::100/64 VSU(config-ipv6-acl)#exit VSU(config)# </pre>

	<pre>VSU(config)#int gi 0/1 VSU(config-if-GigabitEthernet 0/1)#ipv6 mld access-group acl VSU(config-if-GigabitEthernet 0/1)#ipv6 mld join-group ff66::5 VSU(config-if-GigabitEthernet 0/1)#ipv6 mld join-group ff65::5</pre>
Verification	Run the show ipv6 mld groups [<i>interface-type interface-number</i>] [<i>group-address</i>] [detail] command to view the group information on the interface.
	<pre>VSU#show ipv6 mld groups MLD Connected Group Membership Group Address Interface Uptime Expires Last Reporter ff66::5 GigabitEthernet 0/1 00:05:07 00:03:46 fe80::2d0:f8ff:fe22:33b1</pre>

↘ Configuring the Maximum Number of MLD Group Members

Configuration Steps	<ul style="list-style-type: none"> ● Configure the basic functions of MLD. (Omitted) ● Configure the maximum number of group members on the interface as 5. ● Add group information (FF66::5 ~ FF66::0B). ● View the group information.
	<pre>VSU(config-if-GigabitEthernet 0/1)#ipv6 mld limit 5 VSU(config-if-GigabitEthernet 0/1)#ipv6 mld join-group ff66::5 VSU(config-if-GigabitEthernet 0/1)#ipv6 mld join-group ff66::6 VSU(config-if-GigabitEthernet 0/1)#ipv6 mld join-group ff66::7 VSU(config-if-GigabitEthernet 0/1)#ipv6 mld join-group ff66::8 VSU(config-if-GigabitEthernet 0/1)#ipv6 mld join-group ff66::9 VSU(config-if-GigabitEthernet 0/1)#ipv6 mld join-group ff66::A VSU(config-if-GigabitEthernet 0/1)#ipv6 mld join-group ff66::B</pre>
Verification	Run the show ipv6 mld groups [<i>interface-type interface-number</i>] [<i>group-address</i>] [detail] command to view group information on the interface.
	<pre>MLD Connected Group Membership Group Address Interface Uptime Expires Last Reporter ff66::5 GigabitEthernet 0/1 00:00:36 00:04:00 fe80::2d0:f8ff:fe22:33b1 ff66::6 GigabitEthernet 0/1 00:00:34 00:04:01 fe80::2d0:f8ff:fe22:33b1 ff66::7 GigabitEthernet 0/1 00:00:22 00:04:13 fe80::2d0:f8ff:fe22:33b1 ff66::8 GigabitEthernet 0/1 00:00:18 00:04:19 fe80::2d0:f8ff:fe22:33b1 ff66::9 GigabitEthernet 0/1 00:00:14 00:04:21 fe80::2d0:f8ff:fe22:33b1</pre>

Common Errors

- The basic functions of MLD are not enabled.

17.4.5MLD Proxy

Configuration Effect

- Configure the router proxy function and collect local member information.

Notes

- The basic functions of MLD must be configured.

Configuration Steps

⌵ Configuring MLD PROXY-SERVICE

Optional.

This function can be configured on the interface of routers directly connected to the upstream devices unless otherwise specified.

⌵ Configuring MLD MROUTE-PROXY

Optional

This function can be configured on the interface of hosts directly connected to the downstream devices unless otherwise specified.

Verification

- Configure the interface that directly connects interface 7 and upstream router as the multicast proxy service.
- Configure the interface that directly connects interface 1 and downstream host as the multicast proxy.
- Configure groups FF66::05 and FF66::06 to be added to interface 1.
- Check information of the current group.

Related Commands

⌵ Configuring MLD PROXY-SERVICE

Command	ipv6 mld proxy-service
Parameter	-
Description	
Command Mode	Interface configuration mode
Usage Guide	<p>Run the ipv6 mld proxy-service command to configure the upstream interface as the proxy-service interface.</p> <p>Run the ipv6 mld mroute-proxy command to configure the downstream interface as the mroute-proxy interface.</p> <p>Configure the proxy-service interface to forward MLD Query messages to the mroute-proxy interface. Configure the mroute-proxy interface to forward MLD Reports messages to the proxy-service interface.</p> <p>A maximum of 32 proxy-service interfaces can be configured on a device. After receiving MLD Query messages, the proxy-service interface sends a response based on the MLD group member records.</p> <p>If you run switchport command on the proxy-service interface, the ipv6 mld mroute-proxy command configured on the mroute-proxy interface will be automatically deleted.</p>

⌵ Configuring MLD MROUTE-PROXY

Command	ipv6 mld mroute-proxy <i>interface-type interface-number</i>
Parameter	-

Description	
Command	Interface configuration mode
Mode	
Usage Guide	<p>Run the ipv6 mld proxy-service command to configure the upstream interface as the proxy-service interface.</p> <p>Run the ipv6 mld mroute-proxy command to configure the downstream interface as the mroute-proxy interface.</p> <p>Configure the proxy-service interface to forward MLD Query messages to the mroute-proxy interface. Configure the mroute-proxy interface to forward MLD Reports messages to the proxy-service interface.</p>

Configuration Example

Configuration Steps	<ul style="list-style-type: none"> ● Configure MLD basic functions. (Omitted) ● Configure interface 7 as the proxy server. ● Configure interface 1 as the multicast proxy. ● Configure groups FF66::05 and FF66::06 to be added to interface 1.
	<pre>VSU(config-if-GigabitEthernet 0/7)#ipv6 mld proxy-service VSU(config-if-GigabitEthernet 0/7)#exit VSU(config)#int gi 0/1 VSU(config-if-GigabitEthernet 0/1)#ipv6 mld mroute-proxy gigabitEthernet 0/7 VSU(config-if-GigabitEthernet 0/1)#ipv6 mld join-group ff66::05 VSU(config-if-GigabitEthernet 0/1)#ipv6 mld join-group ff66::06</pre>
Verification	<p>Run the show ipv6 mld groups [<i>interface-type interface-number</i>] [<i>group-address</i>] [detail] command to view the group information on the interface.</p>
	<pre>VSU(config-if-GigabitEthernet 0/1)#show ipv6 mld groups MLD Connected Group Membership Group Address Interface Uptime Expires Last Reporter ff66::5 GigabitEthernet 0/1 00:00:11 00:04:31 fe80::2d0:f8ff:fe22:33b1 ff66::6 GigabitEthernet 0/1 00:00:11 00:04:33 fe80::2d0:f8ff:fe22:33b1 MLD Proxy-server Connected Group Membership Group Address Interface Uptime ff66::5 GigabitEthernet 0/7 00:00:11 ff66::6 GigabitEthernet 0/7 00:00:11</pre>

Common Errors

- The basic functions of MLD are not enabled.

17.4.6 Supporting SSM-MAP

Configuration Effect

- MLDv2 supports source filtering while MLDv1 does not. However, MLDv1 provides the SSM-MAP function to implement source filtering.

Notes

- **The basic functions of MLD must be configured.**

Configuration Steps

↘ **Enabling SSM-MAP**

This function must be configured if SSM-MAP.

This function must be enabled on a router where SSM-MAP is enabled.

↘ **Configuring an SSM-MAP Static Link Table**

Optional.

This function must be enabled on a router where SSM-MAP is enabled.

Verification

Run the **show ipv6 mld ssm-mapping** [*group-address*] command to display SSM-MAP information.

Related Commands

↘ **Enabling SSM-MAP**

Command	ipv6 mld ssm-map enable
Parameter Description	-
Command Mode	Global configuration mode
Usage Guide	Run the ipv6 mld ssm-map enable command to enable the SSM-MAP function. Run the ipv6 mld ssm-map static command to configure static mapping table items. The interface runs MLDv2. When receiving Report messages from MLDv1, the interface adds the static mapping source address.

↘ **Configuring an SSM-MAP Static Link Table**

Command	ipv6 mld ssm-map static access-list source-address
Parameter Description	access-list: Specifies the group address range configured by the ACL. source-address: Source address
Command Mode	Global configuration mode
Usage Guide	Run the ipv6 mld ssm-map enable command to enable the SSM-MAP function. Run the ipv6 mld ssm-map static command to configure static mapping table items. The interface runs MLDv2. When receiving Report messages from MLDv1, the interface adds the static mapping source address.

Configuration Example

Configuration Steps	<ul style="list-style-type: none"> ● Configure the basic functions of MLD. (Omitted) ● Enable SSM-MAP.
----------------------------	--

	<ul style="list-style-type: none"> Configure SSM-MAP static link table 3.
	<pre>VSU(config)#ipv6 mld ssm-map enable VSU(config)#ipv6 mld ssm-map static 3 1500::5</pre>
Verification	Run the show ipv6 mld ssm-mapping [<i>group-address</i>] command to view SSM mapping information.
	<pre>VSU(config)#show ipv6 mld ssm-mapping SSM Mapping : Enabled Database : Static mappings configured</pre>

Common Errors

- The basic functions of MLD are not enabled.

17.5 Monitoring

Clearing

Description	Command
Clears dynamic group member records in the MLD cache.	clear ipv6 mld group [<i>group-address</i>] [<i>interface-type interface-number</i>]
Clears all MLD statistics and group member records on the interface.	clear ipv6 mld interface <i>interface-type interface-number</i>

Displaying

Description	Command
Displays groups directly connected to the device and group information learned from MLD.	show ipv6 mld groups [<i>group-address</i> <i>interface-type interface-number</i>] [detail]
Displays configurations of the interface.	show ipv6 mld interface [<i>interface-type interface-number</i>]
Displays SSM-MAP information.	show ipv6 mld ssm-mapping [<i>group-address</i>]

Debugging

System resources are occupied when debugging information is output. Therefore, disable debugging immediately after use.

Description	Command
Displays the MLD debugging switch status.	show debugging
Debugs all MLD information.	debug ipv6 mld all
Debugs MLD packet resolution.	debug ipv6 mld decode
Debugs MLD packet encoding.	debug ipv6 mld encode
Debugs MLD event information.	debug ipv6 mld events
Debugs MLD Finite State Machine (FSM).	debug ipv6 mld fsm
Debugs MLD state machine information.	debug ipv6 mld tib

Debugs MLD warning.	<code>debug ipv6 mld warning</code>
---------------------	-------------------------------------

18 Configuring PIM-DM

18.1 Overview

Protocol Independent Multicast (PIM) is an intra-domain multicast routing protocol.

A multicast source sends a packet to a group address. The packet is forwarded by network devices hop by hop and finally reaches the group members. On layer-3 network devices, PIM is used to create and maintain multicast routing entries, so as to support multicast forwarding.

PIM works in two modes: Protocol Independent Multicast - Sparse Mode (PIM-SM) and Protocol Independent Multicast - Dense Mode (PIM-DM).

- PIM-SM is applicable to large-scale networks where group members are sparsely distributed in a wide scope.
- PIM-DM is applicable to small networks where group members are densely distributed.

Protocols and Standards

- RFC3973: Protocol Independent Multicast - Dense Mode (PIM-DM)
- RFC2715: Interoperability Rules for Multicast Routing Protocols

18.2 Applications

Application	Description
Providing the Multicast Service in the Same Network	The multicast service is provided in the same network.

18.2.1 Providing the Multicast Service in the Same Network

Scenario

The multicast service is provided in the same network.

The following figure is taken as an example:

- A multicast source sends a multicast packet, and Receiver A and Receiver B in the same network receive the multicast packet.

Figure 5- 1

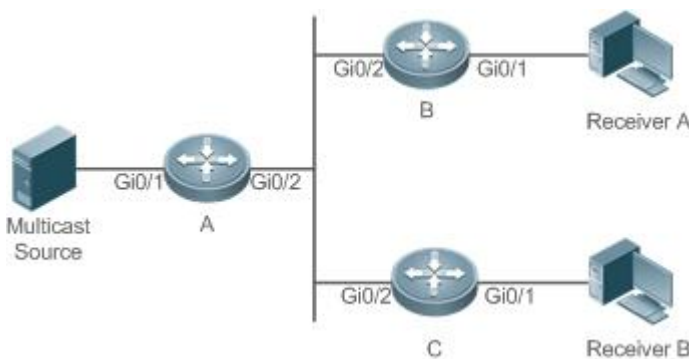

Remarks	A, B, and C are Layer-3 routers. The multicast source is connected to the Gi0/1 interface of A, Receiver A is connected to the Gi0/1 interface of B, and Receiver B is connected to Gi0/1 of C.
----------------	--

Deployment

- Run the Open Shortest Path First (OSPF) protocol in the same network to implement unicast routing.
- Run the PIM-DM protocol in the same network to implement multicast routing.
- Run the Internet Group Management Protocol (IGMP) in a user host network segment to implement group member management.

18.3PIM-DM Application in a Hot Backup Environment

Scenario

In a hot backup environment, run PIM-DM. A device performs hot backup switching to ensure that traffic is not interrupted.

Figure 5- 2

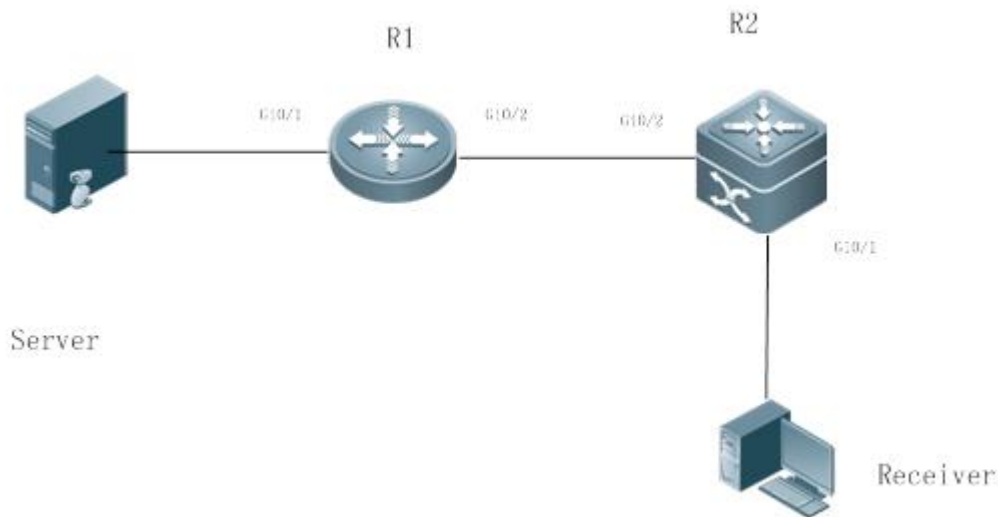

Remarks	R1 is connected to the video server, R2 is directly connected to the receiver, and R2 runs in hot backup mode. A Layer-3 multicast protocol runs on R1 and R2.
----------------	---

Deployment

- Run OSPF on R1 and R2 to implement unicast routing.
- Run PIM-DM on R1 and R2 to implement multicast routing.
- Make R2 run in a hot backup environment.

Remarks	R2 may perform hot backup switching in the hot backup environment. In this case, the query interval of PIM Hello packets (the default value is 30 seconds) needs to be adjusted on R2 because the keepalive timer of the neighbor in PIM Hello packets of R1 may have expired (the default value is 3.5 times the query interval, that is, 105 seconds). The multicast
----------------	--

function relies on the unicast function currently, and the multicast function starts convergence after the unicast function convergence is complete. For example, the default graceful restart (GR) convergence time of the unicast function is 120 seconds. It is recommended that the query interval of PIM Hello packets be set to 60 seconds. The keepalive time of the neighbor in PIM Hello packets is 210 seconds. In this scenario, the query interval of PIM Hello packets need to be set with a reference to the GR convergence time of the unicast function and the value of 3.5 times the query interval of PIM Hello packets must be larger than the GR convergence time of the unicast function. In a hot backup environment, it is recommended that the query interval of PIM Hello packets be larger than the default value (30 seconds). Otherwise, the keepalive timer of the neighbor in PIM Hello packets of the peer end times out during hot backup switching.

18.4 Features

Basic Concepts

↘ PIM Router and PIM Interface

Routers where the PIM protocol is enabled are called PIM Routers. Interfaces where the PIM protocol is enabled are called PIM interfaces.

Multicast packets are forwarded on PIM routers. The PIM interfaces where multicast packets are received are called Upstream Interfaces, and the PIM interfaces where multicast packets are sent are called Downstream Interfaces.

The network segments where upstream interfaces are located are called Upstream Network Segments. The network segments where downstream interfaces are located are called Downstream Network Segments.

↘ PIM Network and PIM Domain

PIM routers are connected through PIM interfaces and form a PIM network.

On some PIM interfaces, borders can be set to divide a large PIM network into multiple PIM domains. The borders are able to reject specified multicast packets or limit the transmission of PIM messages.

↘ Multicast Distribution Tree

Multicast packets are packets transmitted from one point to multiple points. The forwarding path is in a tree structure. This forwarding path is called the Multicast Distribution Tree (MDT).

↘ (*,G), (S,G)

- (*,G): Packets sent from any source to Group G, the corresponding routing entries, and the forwarding path called Rendezvous Point Tree (RPT).
- (S,G): Packets sent from Source S to Group G, the corresponding routing entries, and the forwarding path called Shortest Path Tree (SPT).

Overview

Feature	Description
PIM-DM Neighbor	Neighbor relationships are established between PIM routers to form a PIM network.
PIM-DM MDT	PIM-DM creates the MDT by using flooding, pruning, and grafting.
PIM-DM SRM	PIM-DM uses a State Refresh Message (SRM) to update the network state.
MIB	The Simple Network Management Protocol (SNMP) manager uses information in the Management

Information Base (MIB) to directly manage the PIM-DM function.
--

18.4.1 PIM-DM Neighbor

Neighbor relationships are established between PIM routers to form a PIM network. Neighbor relationships must be established between PIM routers before PIM control messages can be exchanged or multicast packets can be forwarded.

Working Principle

A Hello message is sent from a PIM interface. For the IPv4 multicast packet with the Hello message encapsulated, the destination address is 224.0.0.13 (indicating all PIM routers in the same network segment), the source address is the IP address of the PIM interface, and the Time To Live (TTL) value is 1. For the IPv6 multicast packet with the Hello message encapsulated, the destination address is ff02::d.

Function of a Hello message: It is used to discover neighbors, coordinate protocol parameters, and maintain neighbor relationships.

📌 Discovering Neighbors

PIM routers in the same network segment receive multicast packets from the destination address 224.0.0.13 or ff02::d. In this way, the PIM routers obtain neighbor information and establish neighbor relationships.

When a PIM interface is enabled or detects a new neighbor, a Triggered-Hello-Delay message is used to generate a random time. Within the time, the interface sends Hello packets.

📌 Coordinating Protocol Parameters

A Hello message includes multiple protocol parameters, which are described as follows:

- DR_Priority: Router interfaces contend for the designated router (DR) based on their DR priorities. A higher priority means a higher chance of winning.
- Holdtime: Time in which a neighbor is held in the reachable state
- LAN_Delay: LAN delay for transmitting a Prune message in a shared network segment
- Override-Interval: Prune override time carried in a Hello message.

When a PIM router receives a Prune message from an upstream interface, it indicates that downstream interfaces exist in the shared network segment. If the PIM router still needs to receive multicast data, the PIM router must send a Prune Override message to the upstream interface within the Override-Interval.

$\text{LAN_Delay} + \text{Override-Interval} = \text{PPT (Prune-Pending Timer)}$. After a PIM router receives a Prune message from a downstream interface, the PIM router will not immediately perform pruning until PPT times out. Within the time of PPT, if the PIM router receives a Prune rejection message from the downstream interface, the PIM router cancels pruning.

📌 Maintaining Neighbor Relationships

A Hello message is sent periodically between PIM routers. If a Hello packet is not received from a PIM neighbor within Holdtime, the neighbor is considered unreachable and is deleted from the neighbor list. Any change of PIM neighbors will cause change of the multicast topology in the network. If an upstream or downstream neighbor in an MDT is unreachable, multicast routes converge again and the MDT is reshaped.

Related Configuration

📌 Enabling PIM-DM on an Interface

By default, PIM-DM is disabled on an interface.

Use the **ip pim dense-mode** command to enable or disable PIM-DM on an interface.

PIM-DM must be enabled on an interface to involve the interface in the PIM protocol.

📌 Setting the Interval of Hello Messages on an Interface

By default, a Hello message is sent at an interval of 30 seconds.

The **ip pim query-interval** *interval-seconds* command is used to adjust the interval of Hello messages. The value of the interval ranges from 1 to 65,535.

A Hello message is transmitted less frequently when the value of *interval-seconds* is larger.

18.4.2 PIM-DM MDT

PIM-DM creates the MDT by using flooding, pruning, and grafting.

Working Principle

When a multicast source sends multicast packets, the system may forward them to the outgoing interfaces of multicast neighbors and local members, depending on the results of the Reverse Path Forwarding (RPF) check. The packets not passing the RPF check are discarded. If an outgoing interface exists, the packets that have passed the RPF check are accepted for forwarding; if no outgoing interface exist, a prune packet is sent to upstream devices. After the upstream interface receives the prune packet, the upstream interface transmits the source interface of the prune packet as the Pruned state and sets the Prune Timer (PT). In this way, the MDT based on the multicast source is created.

When the system receives a Join message from a local member, if a downstream device in the Pruned state sends a Graft message to an upstream device, the upstream device returns a Graft Ack message and resume multicast forwarding to the interfaces of the downstream device after receiving the Graft message.

 In network deployment, when multiple PIM-DM neighbors are created through multiple links between devices and downstream devices have no or less need in receiving, the CPU usage may be high. In this scenario, PIM-SM is recommended to deploy the environment.

Related Configuration

📌 Configuring the Prune Override Interval on an Interface

By default, the prune override interval is 500 ms.

The **ip pim override-interval** *interval-milliseconds* command is used to modify the prune override interval.

18.4.3 PIM-DM SRM

PIM-DM uses an SRM to refresh the network state.

Working Principle

Devices connected to a multicast source periodically send SRMs to downstream devices to notify changes of the network topology. After receiving the SRMs, the adjacent devices receiving the SRMs add the local topology state information to the messages by modifying some fields in SRMs, and send the messages to downstream devices. When the messages reach leaf devices, the state information of the entire network is updated.

Related Configuration

↘ **Disabling the Processing and Forwarding of SRMs**

By default, the processing and forwarding of SRMs are enabled.

The **ip pim state-refresh disable** command is used to disable the processing and forwarding of SRMs.

- Disabling the SRM function may cause the converged PIM-DM MDT to re-converge, which leads to unnecessary bandwidth waste and multicast routing table flapping. Therefore, it is recommended not to disable SRM in general conditions.

↘ **Setting the Interval of SRMs**

By default, an SRM is sent at an interval of 60 seconds.

The **ip pim state-refresh origination-interval interval-seconds** command is used to adjust the interval of SRMs. The value of the interval ranges from 1 to 100.

SRMs are transmitted less frequently when the value of *interval-seconds* is larger.

- Only devices that are directly connected to a multicast source will periodically send a PIM SRM to downstream interfaces. For a device not directly connected to the multicast source, the interval of SRMs on its downstream interfaces is invalid.

18.4.4MIB

Connected to other agents, the Simple Network Management Protocol (SNMP) manager uses information in the Management Information Base (MIB) to directly manage the PIM-DM function.

Working Principle

The MIB specifies variables (namely information that can be queried and set by the management process) maintained by network elements and directly manages the PIM-DM function.

Related Configuration

↘ **Enabling PIM-DM MIB**

By default, the PIM-DM MIB function is enabled.

The **ip pim mib dense-mode** command is used to enable the PIM-DM MIB function.

18.5Configuration

Configuration			Description and Command	
Configuring PIM-DM Functions	Basic		(Mandatory) It is used to create the multicast service.	
			ip multicast-routing	Enables IPv4 multicast routing.
			ip pim dense-mode	Enables PIM-DM.
Configuring PIM-DM Neighbors			(Optional) It is used to limit the (S,G) pairs of legitimate multicast packets in Any Source Multicast (ASM) model.	
			ip pim query-interval interval-seconds	Sets the Interval of Hello messages on an interface.
			ip pim propagation-delay interval-milliseconds	Sets the prune propagation delay on an

Configuration	Description and Command	
		interface.
	ip pim override-interval <i>interval-milliseconds</i>	Sets the prune override interval on an Interface.
	ip pim neighbor-filter <i>access-list</i>	Configures neighbor filtering on an interface.
Configuring PIM-DM SRMs	ip pim state-refresh disable	Disables the processing and forwarding of SRMs.
	ip pim state-refresh origination-interval <i>interval-seconds</i>	Sets the Interval of SRMs on an interface.
Configuring PIM-DM MIB	ip pim mib dense-mode	Enables PIM-DM MIB.

18.5.1 Configuring PIM-DM Basic Functions

Configuration Effect

- Create a PIM-DM network and provide data sources and user terminals in the network with the IPv4 multicast service.

Notes

- PIM-DM needs to use the unicast routes existing in the network. Therefore, IPv4 unicast routing must be configured in the network.

Configuration Steps

↘ Enabling IPv4 Multicast Routing

- Mandatory
- IPv4 multicast routing should be enabled on each router unless otherwise specified.

↘ Enabling PIM-DM

- Mandatory
- PIM-DM should be enabled on the following interfaces unless otherwise specified: interconnected interfaces on routers and interfaces connecting multicast sources and user hosts.

Verification

Make multicast sources send multicast packets and make user hosts join the groups.

- Check whether the user hosts can successfully receive packets from each group.
- Check whether correct PIM-DM routing entries are created on routers.

Related Commands

↘ Enabling IPv4 Multicast Routing

Command	ip multicast-routing
Parameter	N/A
Description	
Command Mode	Global configuration mode
Usage Guide	N/A

➤ **Enabling PIM-DM**

Command	ip pim dense-mode
Parameter	N/A
Description	
Command Mode	Interface configuration mode
Usage Guide	PIM interfaces must be at Layer-3, including: routing interfaces, aggregate ports(APs), switch virtual interfaces (SVIs), and loopback interfaces. For all PIM interfaces, IPv4 unicast routes should be reachable.

➤ **Displaying the PIM-SM Routing Table**

Command	show ip pim dense-mode mroute [<i>group-or-source-address</i> [<i>group-or-source-address</i>]] [summary]
Parameter	<i>group-or-source-address</i> : Indicates a group address or source address.
Description	<i>group-or-source-address</i> : Indicates a group address or source address (The two addresses cannot be group addresses or source addresses at the same time). summary : Displays the routing table summary.
Command Mode	Privileged EXEC mode/Global configuration mode/Interface configuration mode
Usage Guide	Check whether sufficient routing entries are provided. Check the upstream and downstream interface lists and ensure that a correct SPT tree is created.

Configuration Example

➤ **Enabling IPv4 Multicast Routing on the IPv4 Network**

Scenario Figure 5- 3	
Configuration Steps	<ul style="list-style-type: none"> ● Configure IPv4 unicast routing protocols (for example, OSPF) on all the routers. ● Enable the IPv4 multicast routing function on all the routers. ● Enable the PIM-DM function on all the interconnected interfaces of the routers, Source, and Receiver..
A	<pre>A# configure terminal A(config)# ip multicast-routing A(config)# interface GigabitEthernet 0/1 A(config-if)# ip pim dense-mode A(config-if)# exit A(config)# interface GigabitEthernet 0/2</pre>

	<pre>A(config-if)# ip pim dense-mode A(config-if)# exit</pre>
B	<pre>B# configure terminal B(config)# ip multicast-routing B(config)# interface GigabitEthernet 0/1 B(config-if)# ip pim dense-mode B(config-if)# exit B(config)# interface GigabitEthernet 0/2 B(config-if)# ip pim dense-mode B(config-if)# exit</pre>
Verification	<p>Configure the multicast source (192.168.1.10) to send packets to G (229.1.1.1). Make Receiver A join G.</p> <ul style="list-style-type: none"> ● Check whether the multicast packets from Source G are received by Receiver A.. ● Check PIM-DM routing tables on Router A and Router B.
A	<pre>A# show ip pim dense-mode mroute PIM-DM Multicast Routing Table (192.168.1.10, 229.1.1.1) MRT lifetime expires in 182 seconds Source directly connected on GigabitEthernet 0/1 State-Refresh Originator State: Originator SRT:57, SAT:147 Upstream IF: GigabitEthernet 0/1 Upstream State: Forwarding Assert State: NoInfo Downstream IF List: GigabitEthernet 0/2, in 'olist': Downstream State: NoInfo Assert State: NoInfo</pre>
B	<pre>B# show ip pim dense-mode mroute PIM-DM Multicast Routing Table (192.168.1.10, 229.1.1.1) MRT lifetime expires in 130 seconds RPF Neighbor: 192.168.2.1, Nexthop: 192.168.2.1, GigabitEthernet 0/2 Upstream IF: GigabitEthernet 0/2</pre>

Upstream State: Forwarding Assert State: Loser, AT:125 Downstream IF List: GigabitEthernet 0/1, in 'olist': Downstream State: NoInfo Assert State: NoInfo
--

Common Errors

- IPv4 unicast routing is incorrectly configured.
- IPv4 multicast routing is not enabled on a certain router.
- PIM-DM is not enabled on a certain interface.

18.5.2 Configuring PIM-DM Neighbors

Configuration Effect

- Coordinate protocol parameters and adjust parameters in the Hello packet.
- Enable neighbor filtering to improve network security.

Notes

- Basic functions of PIM-DM must be configured.

Configuration Steps

- Set parameters on PIM router interfaces unless otherwise specified.

Verification

- Set parameters in a Hello packet on an interface and run the **debug ip pim dense-mode encode** command to check parameters.
- Enable neighbor filtering and run the **show ip pim dense-mode decode** command to display neighbor filtering information.
- Run the **show running-config interface [interface-type interface-number]** command to display configurations on an interface.

Related Commands

⌵ Setting the Interval of Hello Messages

Command	ip pim query-interval <i>interval-seconds</i>
Parameter Description	<i>interval-seconds</i> : The value ranges from 1 to 65,535 in the unit of seconds.
Command Mode	Interface configuration mode
Usage Guide	When the Hello interval is set, the holdtime value will be updated as its 3.5 times.

i Every time when the interval of Hello messages is updated, the holdtime value is automatically updated as 3.5 times of the interval. If the result of the interval of Hello messages multiplied by 3.5 is greater than 65,535, the holdtime value is updated as

65,535.

➤ **Setting the Prune Propagation Delay**

Command	ip pim propagation-delay <i>interval-milliseconds</i>
Parameter	<i>interval-milliseconds</i> : The value ranges from 1 to 32,767 in the unit of milliseconds.
Description	
Command Mode	Interface configuration mode
Usage Guide	Set propagation-delay of an interface, that is, configure the prune propagation delay of an interface.

➤ **Setting the Prune Override Interval**

Command	ip pim override-interval <i>interval-milliseconds</i>
Parameter	<i>interval-milliseconds</i> : The value ranges from 1 to 32,767 in the unit of milliseconds.
Description	
Command Mode	Interface configuration mode
Usage Guide	Set override-interval of an interface, that is, configure the prune override time of an interface.

➤ **Configuring PIM-DM Neighbor Filtering**

Command	ip pim neighbor-filter <i>access-list</i>
Parameter	<i>access-list</i> : The supported ACL ranges from 1 to 99. Naming an ACL is also supported.
Description	
Command Mode	Interface configuration mode
Usage Guide	Only addresses that meet ACL filtering conditions can be used as PIM neighbors of the current interface. Otherwise, the addresses filtered out cannot be neighbors. Peering refers to exchange of protocol packets between PIM neighbors. If peering with a PIM device is suspended, the neighbor relationship with it cannot be formed so that PIM protocol packets will not be received from the device.

Configuration Example

➤ **Configuring PIM-DM Neighbors on the IPv4 Network**

Scenario Figure 5-4	
Configuration Steps	<ul style="list-style-type: none"> ● Configure basic functions of PIM-DM (omitted). ● Set protocol parameters in a Hello packet on the Gi0/1 interface of device A.
A	<pre>A# configure terminal A(config)# interface GigabitEthernet 0/1</pre>

	<pre>A(config-if)# ip pim query-interval 60 A(config-if)# ip pim propagation-delay 800 A(config-if)# ip pim override-interval 1000 A(config-if)# exit</pre>
Verification	<ul style="list-style-type: none"> ● Run the show running-config interface [<i>interface-type interface-number</i>] command to display configurations on an interface. ● Run the debug ip pim dense-mode encode command to debug parameters in a Hello packet.
A	<pre>A# (config)#show running-config interface gigabitEthernet 0/1 Building configuration... Current configuration : 245 bytes ! interface GigabitEthernet 0/1 ip pim dense-mode ip pim query-interval 60 ip pim propagation-delay 800 ip pim override-interval 1000</pre>
	<pre>A# debug ip pim dense-mode encode *Dec 22 15:00:58: %7: [ENCODE] Enc Hello: Hello Hold-Time 210 *Dec 22 15:00:58: %7: [ENCODE] Enc Hello: Hello Gen-ID 1362200073 *Dec 22 15:00:58: %7: [ENCODE] Enc Hello: Hello PD=800 ms, OI=1000 ms *Dec 22 15:00:58: %7: [ENCODE] Enc Hello: Hello SR-Interval 60 *Dec 22 15:00:58: %7: [ENCODE] Enc Msg Hdr: Hello Checksum=65396, MsgLen=34 Assert State: Loser, AT:125</pre>

Configuring PIM-DM Neighbor Filtering on the IPv4 Network

Scenario Figure 5- 5	
Configuration Steps	<ul style="list-style-type: none"> ● Configure basic functions of PIM-DM (omitted). ● Configure an ACL on device A. ● Configure PIM neighbor filtering on the Gi0/1 interface of device A.
A	<pre>A# configure terminal</pre>

	<pre>A(config)# interface GigabitEthernet 0/1 A(config-if)# ip pim query-interval 60 A(config-if)# ip pim propagation-delay 800 A(config-if)# ip pim override-interval 1000 A(config-if)# exit</pre>
<p>Verification</p>	<ul style="list-style-type: none"> ● Run the show running-config interface [<i>interface-type interface-number</i>] command to display configurations on the interface. ● Run the debug ip pim dense-mode decode command to debug parameters in a Hello packet.
<p>A</p>	<pre>A#show running-config interface gigabitEthernet 0/2 Building configuration... Current configuration : 187 bytes ! interface GigabitEthernet 0/1 ip pim dense-mode ip pim neighbor-filter pim-dm</pre>
	<pre>A# debug ip pim dense-mode decode Dec 22 15:15:47: %7: [DECODE] Dec Msg: PIM Hello message, version 2 Dec 22 15:09:47: %7: [DECODE] Dec Msg: Neighbor 192.168.2.2/32 on GigabitEthernet 0/1 denied by access-list pim-dm</pre>

Common Errors

- IPv4 unicast routing is incorrectly configured.
- IPv4 multicast routing is not enabled on a certain router.
- PIM-DM is not enabled on a certain interface.

18.5.3Configuring PIM-DM SRMs

Configuration Effect

- Enable or disable the PIM-DM SRM function.
- Adjust the interval of SRMs.

Notes

- Basic functions of PIM-DM must be configured.

Configuration Steps

- The interval of SRMs is only applicable only to the PIM router interfaces that are directly connected to the multicast source.

Verification

- Configure the PIM-DM SRMs and run the **show running-config** command to display the SRM status.
- Run the **show ip pim dense-mode track** command to display the SRM number.
- Run the **show running-config interface [interface-type interface-number]** command to display interface configurations.

Related Commands

▾ **Disabling the Processing and Forwarding of SRMs**

Command	ip pim state-refresh disable
Parameter	N/A
Description	
Command Mode	Global configuration mode
Usage Guide	When the processing and forwarding of SRMs are disabled, the State Refresh Capable option is not included in a Hello packet, and is not processed when the Hello packet is received. Disabling the SRM function may cause the converged PIM-DM MDT to re-converge, which leads to unnecessary bandwidth waste and multicast routing table flapping. Therefore, it is recommended not to disable this function in general conditions.

▾ **Setting the Interval of SRMs**

Command	ip pim state-refresh origination-interval interval-seconds
Parameter	<i>interval-seconds</i> : The value ranges from 1 to 100 in the unit of second.
Description	
Command Mode	Interface configuration mode
Usage Guide	N/A

Configuration Example

▾ **Disabling the Processing and Forwarding of SRMs on an Interface on the IPv4 Network**

Scenario Figure 5-6	
Configuration Steps	<ul style="list-style-type: none"> ● Configure basic functions of PIM-DM (omitted). ● Disable processing and forwarding of a PIM-DM SRM on an Interface of device A.
A	A# configure terminal

	A(config)# ip pim state-refresh disable
Verification	<ul style="list-style-type: none"> Run the show running-config command to check the configuration.
A	<pre>A# (config)# show running-config ... ! ip pim state-refresh disable ! ...</pre>

📌 **Setting the Interval of SRMs on the IPv4 Network**

Scenario Figure 5- 7	
Configuration Steps	<ul style="list-style-type: none"> Configure basic functions of PIM-DM (omitted). Set the interval of PIM-DM SRMs on the Gi0/1 interface of device A.
A	<pre>A# configure terminal A(config)# interface GigabitEthernet 0/1 A(config-if)# ip pim state-refresh origination-interval 5 A(config-if)# exit</pre>
Verification	<ul style="list-style-type: none"> Run the show running-config interface [interface-type interface-number] command to display interface configurations. Run the show ip pim dense-mode track command to display the SRM number.
A	<pre>A#show running-config interface gigabitEthernet 0/1 Building configuration... Current configuration : 201 bytes ! interface GigabitEthernet 0/1 ip pim dense-mode</pre>

ip pim state-refresh origination-interval 5		
A #show ip pim dense-mode track		
PIM packet counters		
Elapsed time since counters cleared: 00:18:54		
	received	sent
Valid PIMDM packets:	38	102
Hello:	38	76
Join/Prune:	0	0
Graft:	0	0
Graft-Ack:	0	0
Assert:	0	0
State-Refresh:	0	26
PIM-SM-Register:	0	
PIM-SM-Register-Stop:	0	
PIM-SM-BSM:	0	
PIM-SM-C-RP-ADV:	0	
Unknown Type:	0	
Errors:		
Malformed packets:	0	
Bad checksums:	0	
Unknown PIM version:	0	
Send errors:	0	

Common Errors

- IPv4 unicast routing is incorrectly configured.
- IPv4 multicast routing is not enabled on a certain router.
- PIM-DM is not enabled on a certain interface.

18.5.4Configuring PIM-DM MIB

Configuration Effect

- Enable the MIB function for PIM-DM.

Verification

- Configure the MIB function of PIM-SM and run the **show running-config** command to check whether the function is configured.

Related Commands

↳ Enabling PIM-DM MIB

Command	ip pim mib dense-mode
Parameter	N/A
Description	
Command Mode	Global configuration mode
Usage Guide	N/A

18.6 Monitoring

Clearing

Description	Command
Resets the statistic start time and clears the counters of PIM-DM packets.	clear ip pim dense-mode track

Displaying

Description	Command
Displays the help information of the commands with IP PIM as the key word.	ip pim help
Displays help information about configuration examples.	pim-dm help
Displays PIM-DM information of an interface.	show ip pim dense-mode interface [<i>interface-type interface-number</i>] [detail]
Displays the PIM-DM neighbors.	show ip pim dense-mode neighbor [<i>interface-type interface-number</i>]
Displays the PIM-DM next-hop information .	show ip pim dense-mode nexthop
Displays the PIM-DM routing table.	show ip pim dense-mode mroute [<i>group-or-source-address</i> [<i>group-or-source-address</i>]] [summary]
Displays the number of PIM-DM packets sent and received since the statistic start time.	show ip pim dense-mode track
Displays the PIM-DM running status.	view pim-dm

19 Configuring PIM-SM

19.1 Overview

Protocol Independent Multicast (PIM) is an intra-domain multicast routing protocol.

A multicast source sends a packet to a group address. The packet is forwarded by network devices hop by hop and finally reaches the group members. On Layer-3 network devices, PIM is used to create and maintain multicast routing entries, so as to support multicast forwarding.

PIM works in two modes: Protocol Independent Multicast - Sparse Mode (PIM-SM) and Protocol Independent Multicast - Dense Mode (PIM-DM).

- PIM-SM is applicable to large-scale networks where group members are sparsely distributed in a wide scope.
- PIM-DM is applicable to small networks where group members are densely distributed.

Protocols and Standards

- RFC4601: Protocol Independent Multicast -Sparse Mode (PIM-SM)
- RFC5059: Bootstrap Router (BSR) Mechanism for Protocol Independent Multicast (PIM)
- RFC3962: Protocol Independent Multicast - Dense Mode protocol
- RFC4607: Source-Specific Multicast for IP

19.2 Applications

Application	Description
Enabling ASM for PIM-SM	The receiver receives any multicast source.
Enabling SSM for PIM-SM	The receiver receives only a specific multicast source.

19.2.1 Enabling ASM for PIM-SM

Scenario

Provide multicast services within only one domain.

For example, in the following figure, the receiver receives any multicast source.

Figure 6- 1

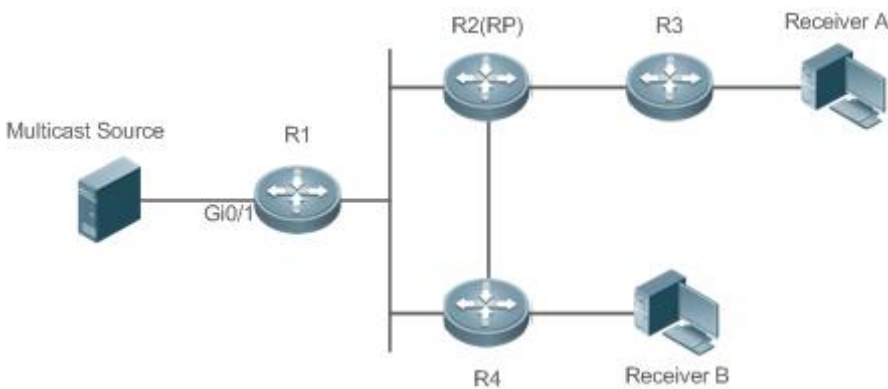

Remarks	<p>R 1 is connected directly to the multicast source.</p> <p>R 2 serves as the rendezvous point (RP).</p> <p>R 3 is connected directly to Receiver A.</p> <p>R 4 is connected directly to Receiver B.</p>
----------------	---

Deployment

- Run the Open Shortest Path First (OSPF) protocol to realize unicast routing.
- Run PIM-SM to realize multicast routing.
- Run the Internet Group Management Protocol (IGMP) in the network segment of the user host to manage group members.

19.2.2 Enabling SSM for PIM-SM

Scenario

Provide multicast services within only one domain.

For example, in the following figure, the receiver receives a specific multicast source.

Figure 6- 2

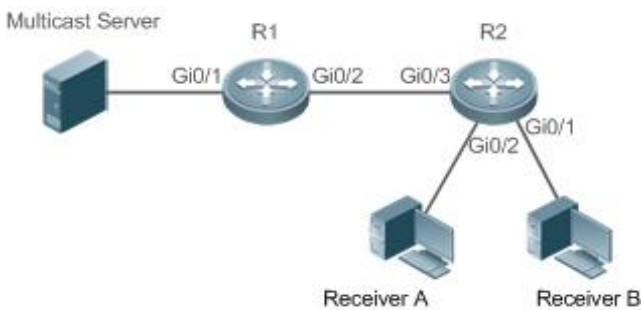

Remarks	
	R 1 is connected directly to the multicast source.
	R 2 serves as the RP.
	R 2 is connected directly to Receiver A.
	R 2 is connected directly to Receiver B.

Deployment

- Run the OSPF protocol to realize unicast routing.
- Run PIM-SM to realize multicast routing.
- Run the source-specific multicast (SSM) of PIM-SM within the domain.
- Run IGMPv3 in the network segment of the user host to manage group members.

19.3 PIM-SM Application in a Hot Backup Environment

Scenario

In a hot backup environment, run PIM-SM. A device performs hot backup switching to ensure that traffic is not interrupted.

Figure 6- 3

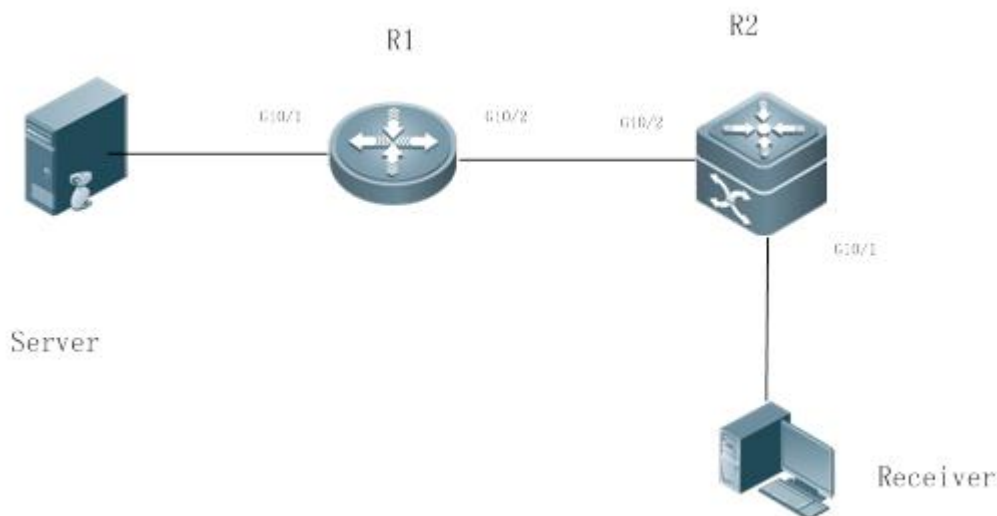

Remarks	R1 is connected to the video server, R2 is directly connected to the receiver, and R2 runs in hot backup mode. A Layer-3 multicast protocol runs on R1 and R2.
----------------	---

Deployment

- Run OSPF on R1 and R2 to implement unicast routing.
- Run PIM-SM on R1 and R2 to implement multicast routing.
- Make R2 run in a hot backup environment.

Remarks	R2 may perform hot backup switching in the hot backup environment. In this case, the query interval of PIM Hello packets (the default value is 30 seconds) needs to be adjusted on R2 because the keepalive timer of the neighbor in PIM Hello packets of R1 may have expired (the default value is 3.5 times the query interval, that is, 105 seconds). The multicast function relies on the unicast function currently, and the multicast function starts convergence after the unicast function convergence is complete. For example, the default graceful restart (GR) convergence time of the unicast function is 120 seconds. It is recommended that the query interval of PIM Hello packets be set to 60 seconds. The keepalive time of the neighbor in PIM Hello packets is 210 seconds. In this scenario, the query interval of PIM Hello packets need to be set with a reference to the GR convergence time of the unicast function and the value of 3.5 times the query interval of PIM Hello packets must be larger than the GR convergence time of the unicast function. In a hot backup environment, it is recommended that the query interval of PIM Hello packets be larger than the default value (30 seconds). Otherwise, the keepalive timer of the neighbor in PIM Hello packets of the peer end times out during hot backup switching.
----------------	---

19.4Features

Basic Concepts

📌 PIM Router and PIM Interface

A router running PIM is called a PIM router. An interfaces running PIM is called a PIM interface.

Multicast packets are forwarded on PIM routers. The PIM interfaces where multicast packets are received are called upstream interfaces, and the PIM interfaces where multicast packets are sent are called downstream interfaces.

The network segments where upstream interfaces are located are called upstream network segments, and the network segments where downstream interfaces are located are called downstream network segments.

➤ **PIM Network and PIM Domain**

PIM routers are connected through PIM interfaces to form a PIM network.

On some PIM interfaces, borders can be set to divide a large PIM network into multiple PIM domains. The borders can reject the passage of specific multicast packets or limit the transmission of PIM packets.

➤ **Multicast Distribution Tree, DR, and RP**

Multicast packets are transmitted from one point to multiple points, forming a tree-shaped forwarding path. Such forwarding path is called the multicast distribution tree (MDT), which includes the following two types:

- RP Tree (RPT): It is rooted at an RP, and uses the designated router (DR) of the member groups connected to it as its leaves.
- Shortest path tree (SPT): It is rooted at a DR that is connected to the multicast source, and uses the RP or the DR of the member groups connected to it as its leaves.

Both the DR and RP are the functions of a PIM router.

- An RP collects the information of a multicast source or multicast member on the network.
- The DR connected to the multicast source advertises the multicast source information to the RP; the DR connected to multicast group members advertises the information of multicast group members to the RP.

➤ **(*, G), (S, G)**

- (*, G): Indicates the packets sent from any source to a group (G), the corresponding route entries, and the RPT.
- (S, G): Indicates the packets sent from the source (S) to a group (G), the corresponding routing entries, and the SPT.

➤ **ASM, SSM**

PIM-SM supports both any-source multicast (ASM) and SSM, and it is applicable to different multicast group address segments.

- ASM: In this model, a user is not allowed to select a multicast source. The user host joins a group, and receives the packets sent from all sources.
- SSM: In this model, a user can select a multicast source. The user host joins a group and specifies the source address. Then only the packets sent from this source address is received.



Requirements for using an SSM model: Before selecting a multicast source, you need to learn the address of the multicast source using other network services.

Overview

Feature	Description
PIM-SM Neighbor	Establishes neighbor relationships between PIM routers to form a PIM network.
DR Election	In the network segment where group member hosts are located, PIM neighbors compete for the DR, and the one wins the election becomes the DR for connecting to the group members. In the network segment where the multicast source is located, PIM neighbors compete for the DR, and the one wins the election becomes the DR for connecting to the multicast source.

Feature	Description
BSR Mechanism	On a PIM network, the BSR generates periodic candidate RPs and bootstrap packets of corresponding group addresses.
RP Mechanism	On a PIM network, through static RP configuration or dynamic RP election, the location of the RP can be learned by each PIM router.
Register Information of the Multicast Source	When the multicast source is detected on the network, the source DR sends a register packet to the RP, which obtains the source information and multicast packet.
Creating an RPT	When a group member is detected on the network, the DR connecting to the group members send packets toward the RP to form an RPT. If the multicast source already exists on the network, the packets arrived at the RP can be sent to the group members along the RPT.
Creating an SPT	When data packets arrive at the DR connecting to group members, the DR sends these packets toward the multicast source to form an SPT, and multicast packets are sent to group members along the SPT.
ASM and SSM	A PIM router can provide multicast services of both ASM model and SSM model at the same time. SSM model applies to the groups whose addresses are within the range of the SSM addresses. For other groups, use ASM model.

19.4.1 PIM-SM Neighbor

Neighbor relationships are established between PIM routers to form a PIM network. Neighbor relationships must be established between PIM routers before PIM control packets can be exchanged or multicast packets can be forwarded.

Working Principle

A PIM interface sends a Hello packet. For the IPv4 multicast packet whose Hello packet is encapsulated, the destination address is 224.0.0.13 (indicating all PIM routers in the same network segment), the source address is the IP address of the PIM interface, and the Time To Live (TTL) value is 1. For the IPv6 multicast packet whose Hello packet is encapsulated, the destination address is ff02::d.

A Hello packet is used to discover neighbors, coordinate protocol parameters, and maintain neighbor relationships.

📌 Discovering Neighbors

PIM routers in the same network segment receive multicast packets from the destination address 224.0.0.13. In this way, the PIM routers obtain neighbor information and establish neighbor relationships.

When a PIM interface is enabled or detects a new neighbor, a triggered-hello-delay packet is used to generate a random time. Within the time, the interface sends Hello packets.

📌 Coordinating Protocol Parameters

A Hello packet includes multiple protocol parameters, which are described as follows:

- DR_Priority: indicates the priority of a router interface for competing for the DR. A higher priority means a higher chance of winning.
- Holdtime: Indicates the time in which a neighbor is held in the reachable state
- LAN_Delay: Indicates the LAN delay for transmitting a Prune packet in a shared network segment.
- Override-Interval: Indicates the prune override time carried in a Hello packet.

When a PIM router receives a Prune packet from an upstream interface, it indicates that downstream interfaces exist in the shared network segment. If the PIM router still needs to receive multicast data, the PIM router must send a Prune Override packet to the upstream interface within the override interval.

$LAN_Delay + Override\ Interval = PPT$ (Prune-Pending Timer). After a PIM router receives a Prune packet from a downstream interface, the PIM router will not immediately perform pruning until PPT times out. Within the time of PPT, if the PIM router receives a Prune rejection packet from the downstream interface, the PIM router cancels pruning.

✚ Maintaining Neighbor Relationships

A Hello packet is sent periodically between PIM routers. If a Hello packet is not received from a PIM neighbor within Holdtime, the neighbor is considered unreachable and is deleted from the neighbor list. Any change of PIM neighbors will cause change of the multicast topology in the network. If an upstream or downstream neighbor in an MDT is unreachable, multicast routes converge again and the MDT is reshaped.

Related Configuration

✚ Enabling PIM-SM on an Interface

By default, PIM-SM is disabled on an interface.

Run **ip pim sparse-mode** to enable or disable PIM-SM on an interface.

PIM-SM must be enabled on an interface to involve the interface in the PIM protocol. If PIM-SM is not enabled for the interface of a DR, static RP, candidate RP (C-RP), or candidate BSR (C-BSR), corresponding roles of the PIM protocol cannot be run.

✚ Setting the Interval of Hello Packets on an Interface

By default, a Hello packet is sent every 30s.

Run **ip pim query-interval *interval-seconds*** to adjust the interval of Hello packets. The value ranges from 1 to 65,535.

A Hello packet is transmitted less frequently when the value of *interval-seconds* is greater.

19.4.2DR Election

In the network segment where group member hosts are located, PIM neighbors compete for the DR, and the one wins the election becomes the DR for connecting to the group members.

In the network segment where the multicast source is located, PIM neighbors compete for the DR, and the one wins the election becomes the DR for connecting to the multicast source.

The DR sends Join/Prune packets toward the MDT, or sends the multicast source data to the MDT.

Working Principle

When creating a PIM neighbor, you can send a Hello packet to obtain the IP address and DR priority of the neighbor to elect a DR.

Two parameters play a key role in winning the DR election: the DR priority of an interface and the IP address of the interface.

✚ DR Priority of an Interface

During the DR election, the PIM router with the highest DR priority will be elected as the DR.

✚ Interface IP Address

During the DR election, if the priority of interfaces is the same, then interface IP addresses will be compared. The interface with the maximum IP address will be elected as the DR.

Related Configuration

📌 Enabling PIM-SM on an Interface

By default, PIM-SM is disabled on an interface.

Run **ip pim sparse-mode** to enable or disable PIM-SM on an interface.

PIM-SM must be enabled on an interface to involve the interface in the PIM protocol. If PIM-SM is not enabled for the interface of a DR, static RP, C-RP, or C-BSR, corresponding protocols cannot be run.

📌 Adjusting the DR Priority of an Interface

By default, the DR priority is 1.

Run **ip pim dr-priority *priority-value*** to adjust the DR priority of the interface. The value ranges from 0 to 4,294,967,294.

The DR priority is used in the DR election in the network segment directly connected the interface. A greater value indicates a higher priority.

19.4.3 BSR Mechanism

On a PIM network, the BSR generates periodic candidate RPs and bootstrap packets of corresponding group addresses. These bootstrap packets are sent hop by hop in the domain. All the routers on the entire network will receive these bootstrap packets, and record these candidate RPs and their corresponding group addresses.

Working Principle

One or multiple candidate BSRs are configured in a PIM-SM domain. You need to apply a certain algorithm to select the BSR from these candidate BSRs.

Related Configuration

📌 Configuring Candidate BSRs

By default, candidate BSRs are not configured.

Run **ip pim bsr-candidate *interface-type interface-number* [*hash-mask-length* [*priority-value*]]** to configure or cancel the configuration of candidate BSRs.

Through bootstrap packet (BSM) learning and competition of candidate BSRs, a unique BSR is generated for the PIM-SM domain.

📌 Configuring BSR Borders

By default, BSR borders are not configured.

Run **ip pim bsr-border** to configure or cancel the configuration of BSR borders.

After this command is configured, BSMs received by the interface will be discarded and will not be forwarded by this interface, preventing BSM flooding.

📌 Filtering BSMs

By default, BSMs from the BSR are not filtered.

Run **ip pim accept-bsr list { <1-99> | <1300-1999> | *WORD* }** to configure whether to filter BSMs.

If this function is enabled, only legible BSMs are received by the interface; if this function is disabled, all the external BSMs will be received by the device running PIM-SM.

➤ **Configuring Legible C-RP Addresses and the Multicast Groups They Serve for a Candidate BSR**

By default, Candidate-RP-Advertisement (C-RP-Adv) packets are not filtered by a candidate BSR.

Run **ip pim accept-crp list** { <100-199> | <2000-2699> | *WORD* } to configure whether to filter C-RP-Adv packets.

If this function is enabled, C-RP addresses and corresponding multicast groups are filtered by a candidate BSR. If this function is disabled, all external C-RP-Adv packets are received by a candidate BSR.

➤ **Allowing a C-BSR to Receive a C-RP-ADV Packet Whose Prefix-Count Is 0**

By default, a candidate BSR cannot receive a C-RP-ADV packet whose prefix-count is 0.

Run **ip pim accept-crp-with-null-group** to configure whether to receive a C-RP-ADV packet whose prefix-count is 0.

If this function is enabled, a C-RP-ADV packet whose prefix-count is 0 can be received by a candidate BSR. If this function is disabled, a C-RP-ADV packet whose prefix-count is 0 cannot be received by a candidate BSR.

19.4.4RP Mechanism

On a PIM network, through static RP configuration or dynamic RP election, the location of the RP can be learned by each PIM router. The RP as the root of the RPT, is the point where the RPT is rooted at and RPT data traffic is forwarded from.

Working Principle

All PIM routers in the same PIM domain must be mapped to the same RP as a specific multicast group address. On a PIM network, an RP can be configured as static or dynamic.

➤ **Static RP**

In static RP configuration, RP addresses are configured directly on PIM routers and these addresses are learnt by the entire PIM network.

➤ **Dynamic RP**

In a PIM-SM domain, there are candidate RPs that send unicast packets (including RP addresses and the multicast groups they serve) to the BSR, which generates periodic candidate RPs and bootstrap packets of corresponding group addresses. These bootstrap packets are sent hop by hop in the domain, and received and saved by PIM routers, which apply a hash function to map the group addresses to the candidate RP that can provide services. Then the RP corresponds to these multicast group addresses can be confirmed.

Related Configuration

➤ **Configuring Static RP Addresses**

By default, no RP address is configured.

Run **ip pim rp-address** *rp-address* [*access-list*] to configure a static RP address for a PIM router.

To use static RP addresses, the static RP address of all routers in the PIM-SM domain must be the same, so that the PIM SM multicast routing remains consistent.

➤ **Configuring Candidate C-RP Addresses**

By default, no C-RP address is configured.

Run **ip pim rp-candidate** *interface-type interface-number* [**priority** *priority-value*] [**interval** *interval-seconds*] [**group-list** *access-list*] to configure or cancel a PIM router as a candidate C-RP.

After a candidate RP is configured, it can send periodic C-RP-Adv packets to the BSR, and the information carried by these C-RP-Adv packets will be advertised to all PIM-SMs in the domain, ensuring the uniqueness of RP mapping.

📌 Ignoring the RP Priority in RP-Set

By default, C-RP of the highest priority is configured.

Run **ip pim ignore-rp-set-priority** to select or deselect the RP priority when selecting the corresponding RP of a multicast group.

If you want to select an RP from multiples RPs that serve the same multicast group address, you can run this command to ignore the RP priority. If this command is not configured, RP priority will be considered when two RPs are compared.

19.4.5 Register Information of the Multicast Source

When the multicast source is detected on the network, the source DR sends a register packet to the RP, which obtains the source information and multicast packet.

Working Principle

When a source DR receives a multicast packet from the host directly connected to it, the source DR encapsulates the multicast packet into the register packet, and sends the unicast packet to RP to form an (S, G) entry.

If the RP has an outgoing interface for the forwarding entry, it encapsulates the data packet and forwards the packet to the outgoing interface.

If the RP does not have the forwarding entry of the present group, it generates the (S, G) entry and enables the timer. If the timer times out, the RP sends a Register-Stop packet to the DR to delete the entry. The source DR sends an inspection packet before timeout after it receives the Register-Stop packet.

If no Register-Stop packet is received by the DR, the DR on the timeout data source will encapsulate the multicast data in the register packet and send the unicast packet to the RP.

If a Register-Stop packet is received by the DR, time-delay will be performed once again, and an inspection packet will be sent before time delay.

Related Configuration

📌 Detecting the Reachability of a Register Packet

By default, the reachability of an RP is not detected.

Run **ip pim register-rp-reachability** to configure or cancel the detection of the reachability of an RP.

You can enable this function if you want to detect whether an RP is reachable for a register packet sent from a DR. After this function is enabled, the DR will detect the reachability of a register packet before it is sent to an RP, namely, the DR will check whether a route to the RP exists in the unicast routing entry and static multicast routing entry. If the route does not exist, the register packet will not be sent.

📌 Configuring an RP to Filter the Addresses of Register Packets

By default, all register packets are received an RP.

Run **ip pim accept-register** { **list** *access-list* [**route-map** *map-name*] | **route-map** *map-name* [**list** *access-list*] } to configure an RP to filter or cancel the filtering of the source addresses of received register packets.

You can run this command if you want to filter the source addresses of received register packets. If this function is not enabled, all register packets will be received by the RP. If this function is disabled, only the register packets whose source addresses and multicast group addresses included in access control lists (ACLs) are processed; otherwise, the packets will be filtered.

↳ Limiting the Speed for Sending a Register Packet

By default, the speed for sending a register packet is not limited.

Run **ip pim register-rate-limit** *rate* to limit or cancel the limitation of the speed for sending a register packet.

If the **no** form of this command is configured, the speed is not limited. This command takes effect for only the register packet of each (S, G) packet, but not all the register packets in the entire system.

↳ Calculating the Checksum of the Entire Register Packet Length

By default, the checksum of a register packet is calculated as stipulated by the protocol.

Run **ip pim register-checksum-wholepkt** [**group-list** *access-list*] to configure the checksum of the register packet length.

You can enable this function if you want to include the length of encapsulated multicast packets into the checksum of the register packet length. If this function is disabled, the checksum of a register packet is calculated as stipulated by the protocol.

↳ Configuring an RP to Forward Multicast Data Packets to Downstream Interfaces After Decapsulating Register Packets

By default, register packets are not decapsulated and multicast packet are not forwarded to interfaces.

Run **ip pim register-decapsulate-forward** to forward or cancel the forwarding of data packets to downstream interfaces.

You can run this command if you want to decapsulate a register packet and forward the multicast packet. If this function is disabled, the multicast packet will not be forwarded.

↳ Configuring the Source IP Address of a Register Packet

By default, the source IP address of a register packet is the same as the interface address of the DR connected to the multicast source.

Run **ip pim register-source** { *local_address* | *Interface-type interface-number* } to configure the source IP address.

You can run this command if you want to configure the source IP address of the register packet sent by a DR. If this function is disabled or the **no** form of this command is used, the source address of the register packet will be the same as the interface address of the DR connected to the multicast source. If you want to configure *local_address*, the configured address must be reachable for a unicast route. *Interface-type interface-number* can be a typical a loopback interface or an interface of other types. The interface address must have been advertised by a unicast route.

↳ Configuring the Suppression Time of a Register Packet

By default, the suppression time of a register packet is 60s.

Run **ip pim register-suppression** *seconds* to configure the suppression time.

If you run this command on a DR, you can change the suppression time of the register packets sent from the DR. If you run this command but does not run **ip pim rp-register-kat** on an RP, the keepalive period of the RP will be changed.

↳ Configuring the Inspection Time of a Null Register Packet

By default, the inspection time is 5s.

Run **ip pim probe-interval** *interval-seconds* to configure the inspection time.

In the time interval before the timeout of register packet suppression, the source DR can send a null register packet to an RP. This time interval is called the inspection time, which is 5s by default.

📌 **Configuring the Time of a RP KAT**

By default, the default value of a keepalive timer (KAT) is used. The default value is calculated as follows: Suppression time of a register packet x 3 + Inspection time of a null register packet.

Run **ip pim rp-register-kat** *seconds* to configure the KAT time.

You can run this command if you want to configure the keepalive time of (S, G) of a register packet sent from an RP.

19.4.6 Creating an RPT

When a group member is detected on the network, the DR connecting to the group members send packets toward the RP to form an RPT. If the multicast source already exists on the network, the packets arrived at the RP can be sent to the group members along the RPT.

Working Principle

To create an RPT, perform the following steps:

A receiver DR receives an IGMP (*, G) include report packet from the receiving end.

If the DR is not the RP of this group (G), the DR will send a (*, G) Join packet toward the RP. The router receiving this (*, G) Join packet will send the packet hop by hop until it is received by the RP, which means that the RP has joined the RPT.

When the data source host sends the multicast data to a group, the source data is encapsulated in the register packet, and sent from the source DR to the RP in unicast mode. Then the RP decapsulates the register packet, takes the data packets out, and forwards these packets to each group member along the RPT.

The RP sends the (S, G) Join packets along the data source to join the SPT of this source.

After the SPT between the RPs to the source DR is created, the data packets from the data source will be sent decapsulated to the RPs along the SPT.

When the first multicast data packet arrives at an RP along the SPT, the RP sends a Register-Stop packet to the source DR to stop sending a register packet. After the source DR receives the Register-Stop packet, it stops encapsulating a register packet and sends the packet along the SPT to the RP, which will forwards the packet to each group member.

Related Configuration

📌 **Configuring the Interval for Sending a Join/Prune Packet**

By default, the interval for sending a Join/Prune packet is 60s.

Run **ip pim jp-timer** *seconds* to configure the interval for sending a Join/Prune packet.

You can run this command to configure the interval for sending a Join/Prune packet. If not configured, the value will be a default 60s.

19.4.7 Creating an SPT

When data packets arrive at the DR connecting to group members, the DR sends these packets toward the multicast source to form an SPT, and multicast packets are sent to group members along the SPT. In this way, the burden on RP in the RPT is reduced, and the source DR will arrive at the receiver DR with less hops.

Working Principle

To create an SPT, perform the following steps:

The receiver DR sends (*, G) Join packets toward the source DR along the SPT, and (*, G) Join packets are then sent hop by hop until they are received by the source DR, forming an SPT.

Related Configuration

By default, SPT switchover is not enabled.

Run **ip pim spt-threshold [group-list access-list]** to configure whether to switch to an SPT.

If this function is enabled, upon the reception of the first (S, G) packet, a PIM Join packet is triggered, and an SPT is created. If **group-list** is specified, all the specified groups will be switched to the SPT. If the **no** form of this command is used and **group-list** is not specified, an RPT will not be switched to an SPT, and the DR will remain in the RPT and send a Prune packet toward the source DR; if the **no** form of this command is used and **group-list** is specified, and that the ACLs have been configured, it means that the association between **group-list** and the ACLs is canceled, and all the groups are allowed to switch from an RPT to an SPT.

19.4.8 ASM and SSM

A PIM router can provide multicast services of both ASM model and SSM model at the same time. SSM model applies to the groups whose addresses are within the range of the SSM addresses. For other groups, use ASM model. In an ASM model, only the multicast group (G) is specified for a multicast receiver, and the multicast source (S) is not specified. In an SSM model, both the multicast source (S) and multicast group (G) can be specified for a multicast receiver.

Working Principle



To realize SSM in an IPv4 router, IGMPv3 needs to be applied for managing membership between the host and devices, and PIM-SM needs to be applied to connect to devices.

In an SSM model, as a multicast receiver has learnt the (S, G) of the multicast source through a certain channel (for example, by visiting the server or receiving an advertisement), when a multicast receiver needs to request a multicast service, the multicast receiver can send the IGMP (S, G) Join packet toward the router of last hop. For example, as shown in Figure 6-3, the multicast receiver 1 sends the IGMP (S, G) Join packet to request the multicast service (S, G). After the router of last hop receives the IGMP (S, G) Join packet, it sends the PIM (S, G) Join packet to the multicast source hop by hop. As shown in Figure 6-4, when R 1 receives the IGMP (S, G) Join packet sent from multicast Receiver 1, R 1 sends the PIM (S, G) Join packet to R 3, which then sends the packet to R 4, thereby forming an SPT connecting the multicast receiver and multicast source.

Figure 6- 4 SSM Model

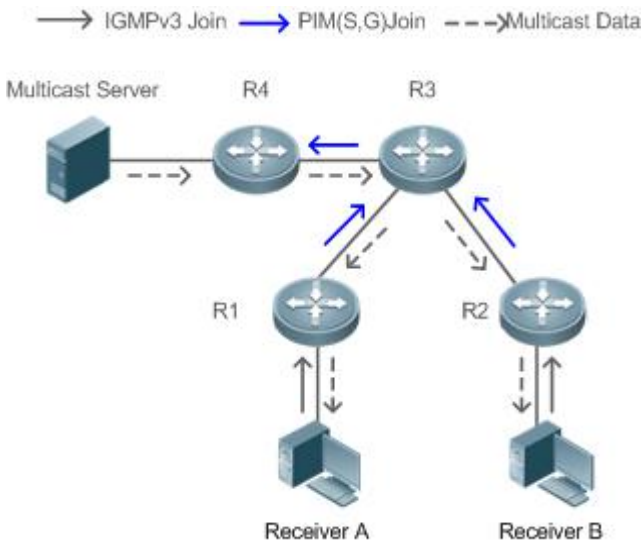

To create an SSM model, the following requirements need to be met:

- A multicast receiver needs to learn the (S, G) of the multicast source in advance, and an IGMP (S, G) Join packet needs to be sent if the receiver needs to request a multicast service.
- IGMPv3 must be run on the interface of the last hop router connecting to the multicast receiver. IGMPv1 and IGMPv2 does not support SSM.
- PIM-SM and SSM must be run on the devices connecting the multicast receiver and multicast source.

The default range of SSM groups is 232/8. You can run a command to change the value.

An SSM has the following features:

- A multicast receiver can learn the information of the multicast source through a certain channel (for example, by visiting the server or receiving an advertisement) in advance.
- An SSM model is a specific subnet of PIM-SM. It handles only the PIM (S, G) Join and PIM (S, G) Prune packets and discards the RPT-related packets, for example, PIM (*, G) Join/Prune packets, that are within the scope the SSM. If the SSM detects a register packet within the scope, it will respond immediately with a Register-Stop packet.
- If an RP is not required, the election and distribution of RP information are not performed. The MDTs in an SSM are all SPTs.

Related Configuration



ASM is enabled by default.



Run `ip pim ssm { default | range access-list }` to configure whether to switch to SSM.

In SSM, multicast packets can be received by the multicast source directly but not along the RP tree.

19.5 Configuration

Configuration			Description and Command	
Configuring Functions	Basic	PIM-SM	(Mandatory) It is used to configure the multicast service.	
			<code>ip multicast-routing</code>	Enables IPv4 multicast routing.
			<code>ip pim sparse-mode</code>	Enables PIM-SM.

Configuration	Description and Command	
	ip pim rp-address	Configures a static RP.
	ip pim rp-candidate	Configures a C-RP.
	ip pim bsr-candidate	Configures a C-BSR.
	ip pim ssm	Enables SSM.
Configuring PIM-SM Neighbors	 (Optional) It is used to configure the parameters for sending and receiving the Hello packets between neighbors.	
	ip pim query-interval <i>interval-seconds</i>	Configures the interval for sending Hello packets.
	ip pim propagation-delay <i>milliseconds</i>	Configures the prune propagation delay.
	ip pim override-interval <i>milliseconds</i>	Configures the prune override interval.
	ip pim neighbor-tracking	Enables the suppression capability of an interface for sending Join packets.
	ip pim triggered-hello-delay <i>interval-seconds</i>	Configures the delay for sending Hello packets.
	ip pim dr-priority <i>priority-value</i>	Configures the DR priority of a Hello packet.
	ip pim neighbor-filter <i>access_list</i>	Configures neighbor filtering.
Configuring BSR Parameters	 (Optional) It is used to configure a BSR.	
	ip pim bsr-border	Configures BSR borders.
	ip pim accept-bsr list { <1-99> <1300-1999> <i>WORD</i> }	Configures BSM packets limit on a PIM router.
	ip pim accept-crp list <i>access-list</i>	Configures a C-BSR to inspect the address range of a C-PR.
Configuring RP and DR Parameters	 (Optional) It is used to configure the parameters of an RP or a DR.	
	ip pim ignore-rp-set-priority	Ignores the C-RP priority.
	ip pim register-rp-reachability	Enables the source DR to detect the RP reachability.
	ip pim accept-register list <i>access-list</i>	Configures the range of source register (S, G) addresses.
	ip pim register-rate-limit <i>rate</i>	Limits the speed for sending register packets.
	ip pim register-checksum-wholepkt [group-list <i>access-list</i>]	Calculates the checksum of the entire register packet.
	ip pim register-decapsulate-forward	Enables an RP to decapsulate a register packet and forwards the multicast packet to interfaces.
	ip pim register-source { <i>local_address</i> <i>Interface-type interface-number</i> }	Configures the source IP address of a register packet.
	ip pim register-suppression <i>seconds</i>	Configures the suppression time of a register packet.
	ip pim probe-interval <i>seconds</i>	Configures the inspection time of a null register packet.
	ip pim rp-register-kat <i>seconds</i>	Configures the interval of KATs on an RP.

Configuration	Description and Command	
Configuring the Interval for Sending a Join/Prune Packet	 (Optional) It is used to specify the interval for sending a Join/Prune packet.	
	ip pim jp-timer <i>seconds</i>	Configures the interval for sending a Join/Prune packet.
Configuring the Router of Last Hop to Switch from an RPT to SPT	 (Optional) It is used to switch from SPT to RPT.	
	ip pim spt-threshold [group-list <i>access-list</i>]	Enables SPT switchover.

19.5.1 Configuring Basic PIM-SM Functions

Configuration Effect

- Create a PIM-SM network and provide data sources and user terminals on the network with the IPv4 multicast service.
- Any of ASM or SSM or both models can be configured.

Notes

- PIM-SM needs to use existing unicast routes on the network. Therefore, IPv4 unicast routes must be configured on the network.
- If the PIM network needs to support SSM multicast services, IGMPv3 or SSM mapping must be configured.

Configuration Steps

▾ Enabling IPv4 Multicast Routing

- Mandatory.
- If not specified, IPv4 multicast routing must be enabled on each router.

▾ Enabling PIM-SM

- Mandatory.
- If not specified, PIM-SM must be enabled on the following interfaces: interconnecting router interfaces, interfaces of static RPs, C-RPs, and C-BSRs, and the interfaces connecting to the multicast source and user hosts.

▾ Configuring an RP

- An RP must be configured if ASM multicast services need to be provided on a PIM network.
- An RP can be configured in three models: configuring only a static RP, configuring only a dynamic RP, and configuring both a static RP and dynamic RP. If both a static RP and dynamic RP are configured, the dynamic RP takes precedence over the static RP.
- Configuring a static RP: If not specified, a static RP should be configured on each router.
- Configuring a dynamic RP: If not specified, a C-RP and C-BSR should be configured on one or multiple routers.

▾ Enabling SSM

- SSM must be enabled if SSM multicast services need to be provided on a PIM network.
- If not specified, SSM must be enabled on every router.

Verification

Send multicast packets from the multicast source to the groups within the address range of ASM and SSM, and join user hosts to these groups.

- Check whether the user hosts can successfully receive packets from each group.
- Check whether PIM-SM routing entries are created on routers correctly.

Related Commands

▾ Enabling IPv4 Multicast Routing

Command	ip multicast-routing
Parameter	N/A
Description	
Command Mode	Global configuration mode
Usage Guide	N/A

▾ Enabling PIM-SM

Command	ip pim sparse-mode
Parameter	N/A
Description	
Command Mode	Interface configuration mode
Usage Guide	PIM interfaces must be at Layer-3, including: routing interfaces, aggregate ports (APs), switch virtual interfaces (SVIs), and loopback interfaces. For all PIM interfaces, IPv4 unicast routes should be reachable.

▾ Configuring a Static RP

Command	ip pim rp-address <i>rp-address</i> [<i>access_list</i>]
Parameter	
Description	<i>rp-address</i> : Indicates the address of an RP. <i>access_list</i> : Specifies the range of multicast group addresses served by a static RP using an ACL. By default, an RP services all groups.
Command Mode	Global configuration mode
Usage Guide	This command is used to locate a static RP. A static RP should be one with good routing performance. It is recommended that the address of the loopback interface be used as the static RP address. The static RP of all routers must be the same (including the RP address and the range of multicast group addresses it serves). It is recommended that the address of the loopback interface be used as the static RP address. The load can be shared if you configure multiple static RPs to serve different multicast group addresses. It is recommended that the address of the loopback interface be used as the static RP address.

▾ Configuring a C-RP

Command	ip pim rp-candidate <i>interface-type interface-number</i> [priority <i>priority-value</i>] [interval <i>seconds</i>] [group-list <i>access_list</i>]
----------------	---

Parameter Description	<p><i>interface-type interface-number</i>: Uses the address of this interface as the address of the C-RP.</p> <p>priority <i>priority-value</i>: Competes for the RP priority. A greater value indicates a higher priority. The value ranges from 0 to 255 (192 by default).</p> <p>interval <i>seconds</i>: Indicates the interval for sending a C-RP packet to a BSR. The value ranges from 1 to 16,383 (60 by default).</p> <p>group-list <i>access_list</i>: Specifies the range of multicast group addresses served by a C-RP using an ACL. By default, a C-RP services all multicast groups.</p>
Command Mode	Global configuration mode
Usage Guide	<p>This command is used to configure a router as a C-RP.</p> <p>A C-RP should be one with good routing performance. A C-RP and C-BSR can be on the same router or different routers.</p> <p>It is recommended that the address of the loopback interface be used as the C-RP address.</p> <p>If multiple C-RPs serve the same group, redundancy can be realized.</p> <p>If multiple C-RPs serve the different groups, load can be shared.</p>

↘ Configuring a C-BSR

Command	ip pim bsr-candidate <i>interface-type interface-number</i> [<i>hash-mask-length</i> [<i>priority-value</i>]]
Parameter Description	<p><i>interface-type interface-number</i>: Uses the address of this interface as the address of the C-BSR.</p> <p><i>hash-mask-length</i>: Indicates the length of hash mask used to competing for the RP. The value ranges from 0 to 32 (10 by default).</p> <p><i>priority-value</i>: Indicates the priority for competing for the BSR. A greater value indicates a higher priority. The value ranges from 0 to 255 (64 by default).</p>
Command Mode	Global configuration mode
Usage Guide	<p>This command is used to configure a router as a C-BSR.</p> <p>A C-BSR should be one with good routing performance. A C-RP and C-BSR can be on the same router or different routers.</p> <p>It is recommended that the address of the loopback interface be used as the C-BSR address.</p> <p>Configuring multiple C-BSRs can realize redundancy.</p>

↘ Enabling SSM

Command	ip pim ssm { default range <i>access_list</i> }
Parameter Description	<p>default: Indicates the default range of SSM group addresses, which is 232.0.0.0/8.</p> <p>range <i>access_list</i>: Specifies the range of SSM group addresses using an ACL.</p>
Command Mode	Global configuration mode
Usage Guide	The SSM group addresses configured on all routers must be the same.

↘ Displaying the PIM-SM Routing Entry

Command	show ip pim sparse-mode mroute [<i>group-or-source-address</i> [<i>group-or-source-address</i>]] [proxy]
Parameter Description	<p><i>group-or-source-address</i>: Indicates a multicast group address or source address (the two addresses cannot be multicast group addresses or source addresses at the same time).</p> <p>proxy: Indicates the RPF vector carried by an entry.</p>

Command	Privileged EXEC mode/Global configuration mode/Interface configuration mode
Mode	
Usage Guide	Check whether sufficient routing entries are provided. Check the upstream and downstream interface lists and ensure that a correct SPT tree is created.

Configuration Example

➤ **Enabling IPv4 Multicast Routing to Support ASM and SSM**

<p>Scenario Figure 6-5</p>	
<p>Configuration Steps</p>	<ul style="list-style-type: none"> ● Configure a IPv4 unicast routing protocol (such as OSPF) on a router, and the router is reachable for the unicast route of a loopback interface. (Omitted) ● Enable IPv4 multicast routing on all the routers. ● Enable PIM-SM on all the interconnected interfaces of the routers, Source, and Receiver. ● Configure C-RP and C-BSR on the loopback interfaces of Router A and Router B, and enable PIM-SM on the loopback interfaces. ● Enable SSM on all routers. ● Enable IGMPv3 on the router interfaces connecting to user terminals. (Omitted)
<p>A</p>	<pre> A# configure terminal A(config)# ip multicast-routing A(config)# ip pim ssm default A(config)# interface GigabitEthernet 0/1 A(config-if)# ip pim sparse-mode A(config-if)# exit A(config)# interface GigabitEthernet 0/2 A(config-if)# ip pim sparse-mode A(config-if)# exit A(config)# interface loopback 0 A(config-if)# ip pim sparse-mode A(config-if)# exit A(config)# ip pim rp-candidate loopback 0 </pre>

<p>B</p>	<pre> B# configure terminal B(config)# ip multicast-routing B(config)# ip pim ssm default B(config)# interface GigabitEthernet 0/1 B(config-if)# ip pim sparse-mode B(config-if)# exit B(config)# interface GigabitEthernet 0/2 B(config-if)# ip pim sparse-mode B(config-if)# exit B(config)# interface loopback 0 B(config-if)# ip pim sparse-mode B(config-if)# exit B(config)# ip pim bsr-candidate loopback 0 </pre>
<p>Verification</p>	<p>Send packets from S (192.168.1.10) to G 1 (229.1.1.1) and G2 (232.1.1.1). Add the user to G 1 and G 2, and specify the source when the user joins G 2.</p> <ul style="list-style-type: none"> ● Check that multicast packets from S (192.168.1.10) to G 1 and G 2 are received by the user. ● Check the PIM-SM routing entries on Router A and Router B. Entries (*, 229.1.1.1), (192.168.1.10, 229.1.1.1), and (192.168.1.10, 232.1.1.1) should be displayed.
<p>A</p>	<pre> switch#show ip pim sparse-mode mroute IP Multicast Routing Table (*,*,RP) Entries: 0 (*,G) Entries: 3 (S,G) Entries: 2 (S,G,rpt) Entries: 2 FCR Entries: 0 REG Entries: 0 (*, 229.1.1.1) RP: 192.168.10.10 RPF nbr: 0.0.0.0 RPF idx: None Upstream State: JOINED 00 01 02 03 04 05 06 07 08 09 10 11 12 13 14 15 16 17 18 19 20 21 22 23 24 25 26 27 28 29 30 31 </pre>

```
Local
0 . . . . i . . . . .
1 . . . . .
Joined
0 . . . . .
1 . . . . .
Asserted
0 . . . . .
1 . . . . .
FCR:

(192.168.1.10, 229.1.1.1)
RPF nbr: 192.168.2.1
RPF idx: GigabitEthernet 0/2
SPT bit: 1
Upstream State: JOINED
jt_timer expires in 8 seconds
kat expires in 207 seconds
  00 01 02 03 04 05 06 07 08 09 10 11 12 13 14 15 16 17 18 19 20 21 22 23 24 25 26 27 28 29 30 31
Local
0 . . . . .
1 . . . . .
Joined
0 . . . . .
1 . . . . .
Asserted
0 . . . . .
1 . . . . .
Outgoing
0 . . . . o . . . . .
1 . . . . .

(192.168.1.10, 229.1.1.1, rpt)
RP: 192.168.10.10
```

```

RPF nbr: 0.0.0.0

RPF idx: None

Upstream State: PRUNED

  00 01 02 03 04 05 06 07 08 09 10 11 12 13 14 15 16 17 18 19 20 21 22 23 24 25 26 27 28 29 30 31

Local
0 . . . . .
1 . . . . .

Pruned
0 . . . . .
1 . . . . .

Outgoing
0 . . . o . . . . .
1 . . . . .

(*, 232.1.1.1)

RP: 192.168.10.10

RPF nbr: 0.0.0.0

RPF idx: None

Upstream State: JOINED

  00 01 02 03 04 05 06 07 08 09 10 11 12 13 14 15 16 17 18 19 20 21 22 23 24 25 26 27 28 29 30 31

Local
0 . . . i . . . . .
1 . . . . .

Joined
0 . . . . .
1 . . . . .

Asserted
0 . . . . .
1 . . . . .

FCR:

(192.168.1.10, 232.1.1.1)

RPF nbr: 192.168.2.1

RPF idx: GigabitEthernet 0/2

SPT bit: 1

```

```

Upstream State: JOINED

jt_timer expires in 8 seconds

kat expires in 207 seconds

 00 01 02 03 04 05 06 07 08 09 10 11 12 13 14 15 16 17 18 19 20 21 22 23 24 25 26 27 28 29 30 31

Local
0 . . . . .
1 . . . . .

Joined
0 . . . . .
1 . . . . .

Asserted
0 . . . . .
1 . . . . .

Outgoing
0 . . . o . . . . .
1 . . . . .

(192.168.1.10, 232.1.1.1, rpt)
RP: 192.168.10.10
RPF nbr: 0.0.0.0
RPF idx: None

Upstream State: PRUNED

 00 01 02 03 04 05 06 07 08 09 10 11 12 13 14 15 16 17 18 19 20 21 22 23 24 25 26 27 28 29 30 31

Local
0 . . . . .
1 . . . . .

Pruned
0 . . . . .
1 . . . . .

Outgoing
0 . . . o . . . . .
1 . . . . .

(*, 239.255.255.250)
RP: 192.168.10.10

```

	<pre>RPF nbr: 0.0.0.0 RPF idx: None Upstream State: JOINED 00 01 02 03 04 05 06 07 08 09 10 11 12 13 14 15 16 17 18 19 20 21 22 23 24 25 26 27 28 29 30 31 Local 0 . . . i 1 Joined 0 . j 1 Asserted 0 1 FCR: A#</pre>
B	<pre>B#show ip pim sparse-mode mroute IP Multicast Routing Table (*,*,RP) Entries: 0 (*,G) Entries: 1 (S,G) Entries: 1 (S,G,rpt) Entries: 1 FCR Entries: 0 REG Entries: 1 (192.168.1.10, 229.1.1.1) RPF nbr: 0.0.0.0 RPF idx: None SPT bit: 1 Upstream State: JOINED kat expires in 38 seconds 00 01 02 03 04 05 06 07 08 09 10 11 12 13 14 15 16 17 18 19 20 21 22 23 24 25 26 27 28 29 30 31 Local</pre>

```
0 . . . . .
Joined
0 . . j . . . . .
Asserted
0 . . . . .
Outgoing
0 . . o . . . . .

(192.168.1.10, 229.1.1.1, rpt)
RP: 192.168.10.10
RPF nbr: 192.168.2.2
RPF idx: GigabitEthernet 0/2
Upstream State: RPT NOT JOINED
  00 01 02 03 04 05 06 07 08 09 10 11 12 13 14 15 16 17 18 19 20 21 22 23 24 25 26 27 28 29 30 31
Local
0 . . . . .
Pruned
0 . . . . .
Outgoing
0 . . . . .

(192.168.1.10, 232.1.1.1)
RPF nbr: 0.0.0.0
RPF idx: None
SPT bit: 1
Upstream State: JOINED
kat expires in 38 seconds
  00 01 02 03 04 05 06 07 08 09 10 11 12 13 14 15 16 17 18 19 20 21 22 23 24 25 26 27 28 29 30 31
Local
0 . . . . .
Joined
0 . . j . . . . .
Asserted
0 . . . . .
```



```

Outgoing
0 . . . o . . . . .

(192.168.1.10, 232.1.1.1, rpt)
RP: 192.168.10.10
RPF nbr: 192.168.2.2
RPF idx: GigabitEthernet 0/2
Upstream State: RPT NOT JOINED

 00 01 02 03 04 05 06 07 08 09 10 11 12 13 14 15 16 17 18 19 20 21 22 23 24 25 26 27 28 29 30 31

Local
0 . . . . .

Pruned
0 . . . . .

Outgoing
0 . . . . .

(*, 239.255.255.250)
RP: 192.168.10.10
RPF nbr: 192.168.2.2
RPF idx: GigabitEthernet 0/2
Upstream State: JOINED
jt_timer expires in 15 seconds

 00 01 02 03 04 05 06 07 08 09 10 11 12 13 14 15 16 17 18 19 20 21 22 23 24 25 26 27 28 29 30 31

Local
0 . . i . . . . .

Joined
0 . . . . .

Asserted
0 . . . . .

FCR:

```

Common Errors

- IPv4 unicast routing is incorrectly configured.
- IPv4 multicast routing is not enabled on a certain router.
- SSM is not enabled on a router or the SSM group address is different from that of the others!

- PIM-SM is not enabled on an interface (for example, the interface is configured as a C-RP or C-BSR interface, or is used to connecting to the user host or used as an interface of the multicast source).
- IGMPv3 is not enabled on an interface connecting to the used host.
- RP is not configured on the network.
- A static RP is not configured on a router, or the configured static RP is different from that on other routers.
- C-RPs are configured on the network, but C-BSRs are not.
- Static RPs, C-RPs or C-BSRs are unreachable for unicast routes.

19.5.2 Configuring PIM-SM Neighbors

Configuration Effect

- Coordinate protocol parameters and adjust parameters in the Hello packet.
- A RIM router is used to discover neighbors, coordinate protocol parameters, and maintain neighbor relationships.
- Maintain neighbor relationships and filter the neighbors.

Notes

- Basic PIM-SM functions must be configured.

Configuration Steps

- Configure parameters on PIM router interfaces If not specified.

Verification

Configure the parameters of a Hello packet sent from an interface and run **debug ip pim sparse-mode packet** to display the parameters.

Enable neighbor filtering and run **show ip pim sparse-mode neighbor** to display neighbor information.

Related Commands

↘ Configuring the Interval for Sending Hello Packets

Command	ip pim query-interval <i>interval-seconds</i>
Parameter Description	Indicates the interval for sending Hello packets, Indicates the suppression time of a register packet in the unit of seconds. The value ranges from 1 to 65,535 (30 by default).
Command Mode	Interface configuration mode
Usage Guide	Every time when the interval for sending Hello packets is updated, the holdtime value is automatically updated as 3.5 times of the interval. If the result of the interval for sending Hello packets multiplied by 3.5 is greater than 65,535, the holdtime value is forcibly updated as 18,725.

↘ Configuring the Prune Propagation Delay

Command	ip pim propagation-delay <i>milliseconds</i>
Parameter	<i>milliseconds</i> : The unit is ms. The value ranges from 1 to 32,767 (500 by default).

Description	
Command	Interface configuration mode
Mode	
Usage Guide	<p>Once the prune propagation delay or prune override interval is changed, the Join/Prune packet override interval will be changed.</p> <p>As specified by the protocol, the Join/Prune packet override interval must be smaller than the holdtime of a Join/Prune packet; otherwise, short break-up of traffic may be caused. The administrator should maintain such configuration.</p>

↘ Configuring the Prune Override Interval

Command	ip pim override-interval <i>milliseconds</i>
Parameter	<i>milliseconds</i> : The unit is ms. The value ranges from 1 to 65,535 (2,500 by default).
Description	
Command	Interface configuration mode
Mode	
Usage Guide	<p>Once the prune propagation delay or prune override interval is changed, the Join/Prune packet override interval will be changed.</p> <p>As specified by the protocol, the Join/Prune packet override interval must be smaller than the holdtime of a Join/Prune packet; otherwise, short break-up of traffic may be caused. The administrator should maintain such configuration.</p>

↘ Enabling Suppression Capability of an Interface for Sending Join Packets

Command	ip pim neighbor-tracking
Parameter	N/A
Description	
Command	Interface configuration mode
Mode	
Usage Guide	<p>Once Join packets suppression of an interface is enabled, when the present router is to send a Join packet to the upstream neighbor, which has sent a Join packet to its own upstream neighbor, the present router will not send the Join packet; if Join packets suppression is disabled, the Join packet will be sent. When Join packets suppression from downstream receivers are disabled, upstream neighbors will learn how many downstream neighbors are there by counting the Join packets it received, which is called neighbor tracking.</p>

↘ Configuring the Delay for Sending Hello Packets

Command	ip pim triggered-hello-delay <i>interval-seconds</i>
Parameter	<i>Seconds</i> : The unit is second. The value ranges from 1 to 5 (5 by default).
Description	
Command	Interface configuration mode
Mode	
Usage Guide	<p>When a PIM interface is enabled or detects a new neighbor, a triggered-hello-delay packet is used to generate a random time. Within the time, the interface sends Hello packets.</p>

↘ Configuring the DR Priority of a Hello Packet

Command	ip pim dr-priority <i>priority-value</i>
----------------	---

Parameter	<i>priority-value</i> : Indicates the priority. A greater value indicates a higher priority.
Description	The value ranges from 0 to 4,294,967,294 (1 by default).
Command Mode	Interface configuration mode
Usage Guide	<p>A DR may be selected based on the following principles:</p> <p>If all the Hello packets sent from the routers on a local area network (LAN) are configured with priorities, when selecting a DR, the priorities will be compared, and the router with the highest priority will be selected as the DR. If the priority of all routers is the same, their IP addresses will be compared, and the router with the maximum IP address will be selected as the DR.</p> <p>If the priority of the Hello packets sent from a certain router is not configured, the IP addresses of the routers will be compared, and the router with the maximum IP address will be selected as the DR.</p>

📌 **Configuring Neighbor Filtering**

Command	ip pim neighbor-filter <i>access_list</i>
Parameter Description	<i>access_list</i> : Configures the range of neighbor addresses using a standard IP ACL. The value can be set from 1 to 99 or a string.
Command Mode	Interface configuration mode
Usage Guide	Enabling neighbor filtering can enhance the security of the PIM network and limit the range of legible neighbor addresses. Once a neighbor is filtered out, PIM-SM will not establish peering with it or stop the peering with it.

📌 **Displaying the Neighbor Information of an Interface**

Command	show ip pim sparse-mode neighbor [detail]
Parameter Description	detail : Displays detailed information.
Command Mode	Privileged EXEC mode/Global configuration mode/Interface configuration mode
Usage Guide	N/A

Configuration Example

Configuration Steps	<ul style="list-style-type: none"> ● Configure basic PIM-SM functions. (Omitted) ● Configure the interval for sending Hello packets as 50s. ● Configure the prune propagation delay as 400 ms. ● Configure the prune override interval as 3,000 ms. ● Enable suppression capability of an interface for sending Join packets. ● Configure the delay for sending Hello packets as 3s. ● Configure the DR priority of a hello packet as 5.
	<pre>FS# configure terminal FS (config)#int gi 0/1 FS (config-if-GigabitEthernet 0/1)#ip pim query-interval 50 FS (config-if-GigabitEthernet 0/1)#ip pim propagation-delay 400</pre>

	<pre>FS (config-if-GigabitEthernet 0/1)#ip pim override-interval 3000 FS (config-if-GigabitEthernet 0/1)#ip pim triggered-hello-delay 3 FS (config-if-GigabitEthernet 0/1)#ip pim neighbor-tracking</pre>
Verification	Run debug ip pim sparse-mode packet to display the parameters of a Hello packet.
	<pre>FS# debug ip pim sparse-mode packet 00:01:49:43: %7: VRF(0): Hello send to GigabitEthernet 0/1 00:01:49:43: %7: Send Hello packet 00:01:49:43: %7: Holdtime: 175 00:01:49:43: %7: T-bit: on 00:01:49:43: %7: Propagation delay: 400 00:01:49:43: %7: Override interval: 3000 00:01:49:43: %7: DR priority: 5 00:01:49:43: %7: Gen ID: 355154648 00:01:49:43: %7: RPF Vector capable</pre>
Configuration Steps	Configure neighbor filtering and set the allowed address range to 192.168.1.0 to 192.168.1.255.
	<pre>FS# configure terminal FS (config)#int gi 0/1 FS (config-if-GigabitEthernet 0/1)# ip pim neighbor-filter 1 % access-list 1 not exist FS(config)# access-list 1 permit 192.168.1.0 0.0.0.255 FS(config)#</pre>
Verification	Display neighbor information before neighbor filtering is configured.
	<pre>FS# show ip pim sparse-mode neighbor Neighbor Interface Uptime/Expires Ver DR Address Priority/Mode 192.168.36.89 GigabitEthernet 0/1 01:12:13/00:01:32 v2 1 / P</pre>
	Display neighbor information after neighbor filtering is configured.
	<pre>FS# show ip pim sparse-mode neighbor</pre>

Common Errors

- Basic PIM-SM functions are not configured or the configuration is not successful.

19.5.3 Configuring BSR Parameters

Configuration Effect

- Configure the address range of BSM packets.

Notes

- Basic PIM-SM functions must be configured.
- C-RPs and C-BSRs must be configured.
- Boarders must be configured on the interfaces between domains.

Configuration Steps

↘ Configuring Boarders

- Boarders must be configured if there are multiple domains.
- Boarders are configured on the interfaces separating two domains.

↘ Configuring BSM Packets Limit on a PIM Router

- Optional.
- If not specified, BSM packets limit can be configured on all PIM routers.

↘ Configuring a C-BSR to Inspect the Address Range of a C-PR

- Optional.
- If not specified, C-PR range inspection can be configured on all C-BSRs.

↘ Allowing a C-BSR to Receive a C-RP-ADV Packet Whose Prefix-Count Is 0

- Optional.
- If not specified, this function can be configured on all C-BSRs.

Verification

↘ Border Inspection

Enable basic PIM-SM functions. Configure two routers to be in different domains, configure Router B as the C-BSR, and Router A to receive BSM packets.

Configure the junction of Router A and Router B as the border so that Router A does not receive BSM packets.

↘ Configuring to Inspect BSM Packets Limit on a PIM Router

When basic PIM-SM functions are enabled, and Router B is set as the C-BSR, Router A can receive BSM packets. When the address range of C-BSRs are limited on Router A, BSM packets will not be received by Router A.

↘ Configuring a C-BSR to Inspect the Address Range of a C-PR

When basic PIM-SM functions are enabled, Router B is set as the C-BSR, and Router A as the C-RP, if the address range of the C-RPs is limited on C-BSR, Router B will not receive the packets sent from the C-RPs.

Related Commands

↘ Configuring BSR Boarders

Command	ip pim bsr-border
Parameter	N/A
Description	
Command Mode	Interface configuration mode
Usage Guide	To prevent BSM flooding, you can configure a BSR boarder on an interface, so that the BSM packets arriving at this interface will be discarded but not forwarded.

↘ Configuring BSM Packets Limit on a PIM Router

Command	ip pim accept-bsr list { <1-99> <1300-1999> <i>WORD</i> }
Parameter	
Description	list access-list: Configures the range of BSR addresses using a standard IP ACL. The value can be 1 to 99, 1,300 to 1,999, or a string.
Command Mode	Global configuration mode
Usage Guide	After this function is enabled, PIM-SM routers receive only the BSM packets sent from legible BSRs.

↘ Configuring a C-BSR to Inspect the Address Range of a C-PR

Command	ip pim accept-crp list <i>access-list</i>
Parameter	
Description	list access-list: Specifies the range of C-RP addresses and the multicast group addresses they serve using an extended IP ACL. The value can be 100 to 199, 2,000 to 2,699, or a string.
Command Mode	Global configuration mode
Usage Guide	This command should be configured on a C-BSR. When the C-BSR becomes a BSR, it can set the range of legible C-RP addresses and the range of multicast group addresses they serves.

↘ Displaying BSM Packets Information

Command	show ip pim sparse-mode bsr-router
Parameter	N/A
Description	
Command Mode	Privileged EXEC mode/Global configuration mode/Interface configuration mode
Usage Guide	N/A

↘ Displaying the Packets of All RPs and the Multicast Group Addresses They Serve

Command	show ip pim sparse-mode rp mapping
Parameter	N/A
Description	
Command Mode	Privileged EXEC mode/Global configuration mode/Interface configuration mode
Usage Guide	N/A

Configuration Example

➤ **Configuring BSR Boarders**

Configuration Steps	<ul style="list-style-type: none"> ● Configure basic PIM-SM functions. (Omitted) ● On Router A, configure the address of the C-RP as 192.168.8.8. ● On Router B, configure the address of the C-RP as 192.168.5.5, and the address of the C-BSR as 192.168.6.6. ● Configure a BSR boarder on the junction of Router A and Router B.
	<pre>FS# configure terminal FS(config)# int GigabitEthernet 0/1 FS(config-if-GigabitEthernet 0/1)# ip pim bsr-border FS(config)# end</pre>
Verification	Before configuring the boarder, display the BSM information on Router A.
	<pre>FS# show ip pim sparse-mode bsr-router PIMv2 Bootstrap information This system is the Bootstrap Router (BSR) BSR address: 192.168.6.6 Uptime: 01:14:25, BSR Priority: 64, Hash mask length: 10 Next bootstrap packet in 00:00:52 Role: Candidate BSR Priority: 64, Hash mask length: 10 State: Elected BSR Candidate RP: 192.168.8.8(Loopback 0) Advertisement interval 60 seconds Next Cand_RP_advertisement in 00:00:06</pre>
	 Candidate RP: Indicates all the C-RPs configured on the existing router. It does not include the C-RPs configured on other routers.
	After the boarder is configured, display the BSM information on Router A.
	<pre>FS# show ip pim sparse-mode bsr-router</pre>

➤ **Configuring BSM Packets Limit on a PIM Router, Filtering BSM Source Addresses, and Configuring the Range of BSM Source Addresses to 192.168.1.1 to 192.168.1.255**

Configuration Steps	<ul style="list-style-type: none"> ● Configure basic PIM-SM functions. (Omitted) ● On Router A, configure the address of the C-RP as 192.168.8.8. ● On Router B, configure the address of the C-RP as 192.168.5.5, and the address of the C-BSR as 192.168.6.6. ● On Router A, configure the range of allowed BSM source addresses to 192.168.1.1 to 192.168.1.255.
	<pre>FS# configure terminal FS(config)# ip pim accept-bsr list 1</pre>

	<pre>% access-list 1 not exist FS(config)# access-list 1 permit 192.168.1.0 0.0.0.255 FS(config)#</pre>
Verification	Before configuring BSM packets limit, display the BSM information on Router A.
	<pre>FS#show ip pim sparse-mode bsr-router PIMv2 Bootstrap information BSR address: 192.168.6.6 Uptime: 00:00:11, BSR Priority: 64, Hash mask length: 10 Expires: 00:01:59 Role: Non-candidate BSR Priority: 0, Hash mask length: 10 State: Accept Preferred Candidate RP: 192.168.8.8(Loopback 0) Advertisement interval 60 seconds Next Cand_RP_advertisement in 00:00:06</pre>
	After BSM packets limit is configured, display the BSM information on Router A.
	<pre>FS# show ip pim sparse-mode bsr-router Candidate RP: 192.168.8.8(Loopback 0) Advertisement interval 60 seconds Next Cand_RP_advertisement in 00:00:06</pre>

➤ **Configuring a C-BSR to Inspect the Address Range of a C-PR, Filtering C-RP Addresses, and Configuring the Range of C-RP Addresses to 192.168.1.1 to 192.168.1.255**

Configuration Steps	<ul style="list-style-type: none"> ● Configure basic PIM-SM functions. (Omitted) ● On Router A, configure the address of the C-RP as 192.168.8.8. ● On Router B, configure the address of the C-RP as 192.168.5.5, and the address of the C-BSR as 192.168.6.6. ● On Router B, configure the range of allowed C-RP source addresses to 192.168.1.1 to 192.168.1.255.
	<pre>FS# configure terminal FS(config)# ip pim accept-cr list 100 % access-list 1 not exist FS(config)# access-list 1 permit 192.168.1.0 0.0.0.255 FS(config)#</pre>
Verification	Before configuring C-RP filtering, display the information of all RP groups on Router B.
	<pre>FS#show ip pim sparse-mode rp mapping PIM Group-to-RP Mappings This system is the Bootstrap Router (v2)</pre>

	<pre> Group(s): 224.0.0.0/4 RP: 192.168.8.8(Not self) Info source: 192.168.8.8, via bootstrap, priority 192 Uptime: 00:15:16, expires: 00:02:18 RP: 192.168.5.5(Self) Info source: 192.168.6.6, via bootstrap, priority 192 Uptime: 18:52:30, expires: 00:02:00 </pre>
	<p>After C-RP filtering is configured, display the information of all RP groups on Router B.</p>
	<pre> FS#show ip pim sparse-mode rp mapping PIM Group-to-RP Mappings This system is the Bootstrap Router (v2) Group(s): 224.0.0.0/4 RP: 192.168.5.5(Self) Info source: 192.168.6.6, via bootstrap, priority 192 Uptime: 21:38:20, expires: 00:02:10 </pre>
	<p> After C-RP filtering is configured on a router, only the C-RP packets sent from other routers are filtered, and those sent from the present router are not filtered.</p>

Common Errors

- Basic PIM-SM functions are not configured or the configuration is not successful.
- C-BSRs are not configured.
- The BSR border is not configured on the interfaces of different domains.

19.5.4 Configuring RP and DR Parameters

Configuration Effect

- Ignore the C-RP priority and reselect an RP.
- Detect the reachability of an RP for the source DR.
- Configure the range of (S, G) addresses of source register packets, and allow the ASM to serve only the multicast packets within the range.
- Limit the speed of the source DR for sending register packets.
- Configure the checksum of the register packet length.
- Configure an RP to decapsulate register packets and forward the multicast packets to downstream interfaces.
- Configure the source IP address of a register packet.
- Configure the suppression time of a register packet.
- Configure the inspection time of a null register packet.

- Configure the (S, G) lifetime based on the register packet received by an RP.

Notes

- Basic PIM-SM functions must be configured.

Configuration Steps

↘ Ignoring the C-RP Priority and Reselecting an RP

- Optional.
- If not specified, the C-RP priority can be disabled on every router.

↘ Detecting the Reachability of an RP for the Source DR

- Optional.
- If not specified, this function can be enabled on the DR connected directly to the data source.

↘ Configuring the Range of Source Register (S, G) Addresses

- Optional.
- If not specified, source register address filtering can be enabled on all C-RPs or static RPs.

↘ Limiting the Speed of the Source DR for Sending Register Packets

- Optional.
- If not specified, this function can be enabled on the source DR.

↘ Configuring the Checksum of the Register Packet Length

- Optional.
- If not specified, this function can be enabled on all C-RPs or static RPs.

↘ Configuring Whether to Forward the Multicast Packet After Decapsulating a Register Packet

- Optional.
- If not specified, this function can be enabled on all C-RPs or static RPs.

↘ Configuring the Source IP Address of a Register Packet

- Optional.
- If not specified, the source IP address of a register packet can be configured on the DR connected directly to the data source.

↘ Configuring the Suppression Time of a Register Packet

- Optional.
- If not specified, the suppression time of a register packet can be configured on the DR connected directly to the data source.

↘ Configuring the Inspection Time of a Null Register Packet

- Optional.
- If not specified, the inspection time of a null register packet can be configured on the DR connected directly to the data source.

➤ **Configuring the (S, G) Lifetime Based on the Register Packet Received by an RP**

- Optional.
- If not specified, the (S, G) lifetime can be configured on all C-RPs or static RPs.

Verification

➤ **Ignoring the C-RP priority**

On Router A, configure the C-RP address as 192.168.8.8, and default priority as 192. On Router B, configure the C-RP address as 192.168.5.5, priority as 200, and C-BSR address as 192.168.6.6.

- Run **show ip pim sparse-mode rp** 233.3.3.3 to display the RPs of the present group.

➤ **Enabling the Source DR to Detect RP Reachability**

On Router A, configure the C-RP address as 192.168.8.8, and default priority as 192. On Router B, configure the C-RP address as 192.168.5.5, priority as 192, and C-BSR address as 192.168.6.6. Enable Router B to detect RP reachability.

- Run **show running-config** to check whether the preceding configurations take effect.

➤ **Configuring the Range of Source Register (S, G) Addresses**

On Router A, configure the C-RP address as 192.168.8.8, and default priority as 192. On Router B, configure the address of the C-BSR as 192.168.6.6. Configure the source address as 192.168.1.100 and the multicast group address as 233.3.3.3. On Router A, configure the range of allowed source multicast group addresses to 192.168.2.0 to 192.168.2.255.

- Run **show ip pim sparse-mode mroute** to display the (S, G) entry.

➤ **Limiting the Speed of the Source DR for Sending Register Packets**

Configure the speed of Router B for sending register packets, and run **show ip pim sparse-mode track** to display the number of packets that has been sent.

➤ **Configuring the Checksum of the Register Packet Length**

On Router A, configure to calculate the checksum of the entire register packet length but not just the packet header. Run **show running-config** to check the configuration.

➤ **Forwarding an RP Register Packet After It Is Decapsulated**

On Router A, configure to forward a register packet after it is decapsulated. Run **show running-config** to display the configuration.

➤ **Configuring the Source IP Address of a Register Packet**

Configure the source address of a register packet on Router B, and run **show running-config** to display the configuration.

➤ **Configuring the Suppression Time of a Register Packet and the Inspection Time of a Null Register Packet**

On Router B, configure the suppression time and inspection time of a register packet, and run **show ip pim sparse-mode track** to display the configuration.

➤ **Configuring an RP to Receive Register Packets and the (S, G) Lifetime**

On Router A, configuring an RP to receive register packets and the (S, G) lifetime, and run **show ip pim sparse-mode mroute** to display the maximum (S, G) lifetime.

Related Commands

↳ Ignoring the C-RP priority

Command	ip pim ignore-rp-set-priority
Parameter	N/A
Description	
Command Mode	Global configuration mode
Usage Guide	N/A

↳ Displaying the RP Corresponding to a Group

Command	show ip pim sparse-mode rp-hash <i>group-address</i>
Parameter	<i>group-address</i> : Indicates the parsed multicast group address.
Description	
Command Mode	Privileged EXEC mode/Global configuration mode/Interface configuration mode
Usage Guide	N/A

↳ Enabling the Source DR to Detect RP Reachability

Command	ip pim register-rp-reachability
Parameter	N/A
Description	
Command Mode	Global configuration mode
Usage Guide	After this function is enabled, the source DR will detect the RP reachability before sending a register packet. If the RP is unreachable, the packet will not be sent.

↳ Configuring the Range of Source Register (S, G) Addresses

Command	ip pim accept-register { list <i>access-list</i> [route-map <i>map-name</i>] route-map <i>map-name</i> [list <i>access-list</i>] }
Parameter	
Description	list <i>access-list</i> : Configures the range of (S, G) addresses using an extended IP ACL. The value can be 100 to 199, 2,000 to 2699, or a string. route-map <i>map-name</i> : Configures the range of (S, G) addresses using a route map.
Command Mode	Global configuration mode
Usage Guide	This command is run on a static RP or a C-RP to specify the source address and multicast group address of a register packet.

↳ Displaying a Multicast Routing Entry

Command	show ip pim sparse-mode mroute [<i>group-or-source-address</i> [<i>group-or-source-address</i>]] [proxy]
Parameter	<i>group-or-source-address</i> : Indicates a multicast group address or source address (the two addresses cannot be multicast group addresses or source addresses at the same time).
Description	Proxy : Indicates the RPF vector carried by an entry.

Command Mode	Privileged EXEC mode/Global configuration mode/Interface configuration mode
Usage Guide	You can specify either a multicast group address or source address, or both a multicast group address and source address; or you can specify neither a multicast group address nor source address. The two addresses cannot be multicast group addresses or source addresses at the same time.

▾ Limiting the Speed of the Source DR for Sending Register Packets

Command	ip pim register-rate-limit rate
Parameter Description	<i>Rate</i> : Indicates the maximum number of register packets that can be sent each second. The value ranges from 1 to 65,535.
Command Mode	Global configuration mode
Usage Guide	This command takes effect for only the register packet of each (S, G) packet, but not all the register packets in the entire system. Enabling this command can reduce the burden on the source DR and RPs. Only the packets within the speed limit can be sent.

▾ Displaying the Counters of PIM-SM Packets

Command	show ip pim sparse-mode track
Parameter Description	N/A
Command Mode	Privileged EXEC mode/Global configuration mode/Interface configuration mode
Usage Guide	The start time for counting PIM-SM packets is automatically enabled upon system startup. Run clear ip pim sparse-mode track to reset the start time and clear the PIM-SM packet counters.

▾ Calculating the Checksum of the Entire Register Packet Length

Command	ip pim register-checksum-wholepkt [group-list access-list]
Parameter Description	group-list access-list : Configures the multicast group addresses applicable to this configuration using an ACL. <i>access-list</i> : The value can be set to 1 to 99, and 1300 to 1999. It also supports the naming of the ACL.
Command Mode	Global configuration mode
Usage Guide	You can enable this function if you want to calculate the length of the entire PIM-SM packet, including that of the multicast packet encapsulated in the register packet, but not just the length of the PIM-SM packet header. If group-list access-list is specified, this configuration takes effect for all multicast group addresses.

▾ Enabling an RP to Decapsulate a Register Packet and Forward the Multicast Packet to Interfaces

Command	ip pim register-decapsulate-forward
Parameter Description	N/A
Command Mode	Global configuration mode
Usage Guide	This command is configured on a static RP or a C-RP. It is used to decapsulate a register packet with multicast packet and forward the multicast packet to interfaces.

	If there are too many register packets to be decapsulated, the CPU will be greatly burdened. In this case, this function is recommended to be disabled.
--	---

↘ Configuring the Source IP Address of a Register Packet

Command	ip pim register-source { <i>local_address</i> <i>Interface-type interface-number</i> }
Parameter	<i>local_address</i> : Specifies the source IP address of a register packet.
Description	<i>interface-type interface-number</i> : Specifies the IP address of this interface as the source IP address of the register packet.
Command Mode	Global configuration mode
Usage Guide	The specified address must be reachable. When an RP sends a Register-Stop packet, the PIM router corresponds to this address need to respond. Therefore, it is recommended that a loopback address (or other physical addresses) be used. This configuration does not require the enabling of PIM.

↘ Configuring the Suppression Time of a Register Packet

Command	ip pim register-suppression <i>seconds</i>
Parameter	<i>Seconds</i> : Indicates the suppression time of a register packet in the unit of seconds. The value ranges from 1 to 65,535 (60 by default).
Description	
Command Mode	Global configuration mode
Usage Guide	If you configure this parameter on a DR, the suppression time of a register packet sent from the DR will be changed. If ip pim rp-register-kat is not configured and if you configure this parameter on an RP, the RP keepalive will be changed.

↘ Configuring the Inspection Time of a Null Register Packet

Command	ip pim probe-interval <i>seconds</i>
Parameter	<i>Seconds</i> : Indicates the inspection time of a null register packet in the unit of seconds. The value ranges from 1 to 65,535 (5 by default).
Description	
Command Mode	Global configuration mode
Usage Guide	The inspection time of a null register packet indicates the period of time for sending a null register packet to an RP before the timeout of suppression time. The inspection time cannot exceed half of the suppression time; otherwise, the configuration will not take effect, and a warning message will be displayed. Meanwhile, the result of suppression time multiplied by 3 plus the inspection time cannot exceed 65,535, otherwise, a warning will be displayed.

↘ Configuring the Interval of KATs on an RP

Command	ip pim rp-register-kat <i>seconds</i>
Parameter	<i>Seconds</i> : Indicates the interval of a KAT
Description	in the unit of second. The value ranges from 1 to 65,535 (210 by default).
Command Mode	Global configuration mode
Usage Guide	N/A

Configuration Example

➤ **Configuring the RPs of Corresponding Multicast Group Addresses When the C-RP Priority is Considered or Not Considered**

<p>Configuration Steps</p>	<ul style="list-style-type: none"> ● Configure basic PIM-SM functions. (Omitted) ● On Router A, configure the address of the C-RP as 192.168.8.8. ● On Router B, configure the address of the C-RP as 192.168.5.5, priority as 200, and the address of the C-BSR as 192.168.6.6. ● Display the group corresponding to 233.3.3.3. ● Configure to ignore the C-RP priority on Router B.
	<pre>FS# configure terminal FS(config)# ip pim ignore-rp-set-priority</pre>
<p>Verification</p>	<p>Display the information before you configure to ignore the C-RP priority.</p>
	<pre>FS# show ip pim sparse-mode rp-hash 233.3.3.3 RP: 192.168.8.8 Info source: 192.168.8.8, via bootstrap PIMv2 Hash Value 10(mask 255.192.0.0) RP 192.168.8.8, via bootstrap, priority 192, hash value 1084558102 RP 192.168.5.5, via bootstrap, priority 200, hash value 1094656709</pre>
	<p>Display the information after you configure to ignore the C-RP priority.</p>
	<pre>FS# show ip pim sparse-mode rp-hash 233.3.3.3 RP: 192.168.5.5 Info source: 192.168.6.6, via bootstrap PIMv2 Hash Value 10(mask 255.192.0.0) RP 192.168.8.8, via bootstrap, priority 192, hash value 1084558102 RP 192.168.5.5, via bootstrap, priority 200, hash value 1094656709</pre>

➤ **Configuring to Inspect the Reachability of a Source RP**

<p>Configuration Steps</p>	<ul style="list-style-type: none"> ● Configure basic PIM-SM functions. (Omitted) ● Configure to inspect the reachability of a source RP.
	<pre>FS(config)# ip pim register-rp-reachability</pre>
<p>Verification</p>	<p>Run show running-config to check whether the following information is displayed.</p>
	<pre>FS(config)#show running-config ip pim register-rp-reachability</pre>

➤ **Configuring the Range of Source Register (S, G) Addresses**

<p>Configuration Steps</p>	<ul style="list-style-type: none"> ● Configure basic PIM-SM functions. (Omitted) ● Configure source address filtering on Router A. The allowed address range is from 192.168.2.0 to 192.168.2.255.
	<pre>FS#show ip pim sparse-mode mroute FS(config)#ip pim accept-register list 101 % access-list 101 not exist FS(config)#access-list 101 permit ip 192.168.2.0 0.0.0.255 any FS#show ip pim sparse-mode mroute</pre>
<p>Verification</p>	<p>Before enabling source address filtering, run show ip pim sparse-mode mroute to display the multicast entry, and check whether the (S, G) entry and (S, G, RPT) entry exist.</p>
	<pre>FS#show ip pim sparse-mode mroute IP Multicast Routing Table (*,*,RP) Entries: 0 (*,G) Entries: 1 (S,G) Entries: 1 (S,G,rpt) Entries: 1 FCR Entries: 0 REG Entries: 0 (192.168.1.100, 233.3.3.3) RPF nbr: 192.168.36.90 RPF idx: VLAN 1 SPT bit: 0 Upstream State: NOT JOINED kat expires in 187 seconds 00 01 02 03 04 05 06 07 08 09 10 11 12 13 14 15 16 17 18 19 20 21 22 23 24 25 26 27 28 29 30 31 Local 0 Joined 0 Asserted 0</pre>

<pre> Outgoing 0 (192.168.1.100, 233.3.3.3, rpt) RP: 192.168.8.8 RPF nbr: 0.0.0.0 RPF idx: None Upstream State: RPT NOT JOINED 00 01 02 03 04 05 06 07 08 09 10 11 12 13 14 15 16 17 18 19 20 21 22 23 24 25 26 27 28 29 30 31 Local 0 Pruned 0 Outgoing 0 (*, 239.255.255.250) RP: 192.168.8.8 RPF nbr: 0.0.0.0 RPF idx: None Upstream State: JOINED 00 01 02 03 04 05 06 07 08 09 10 11 12 13 14 15 16 17 18 19 20 21 22 23 24 25 26 27 28 29 30 31 Local 0 Joined 0 . j Asserted 0 FCR: </pre>	<p>After source address filtering is enabled, run show ip pim sparse-mode mroute to display the multicast entry, and check whether the (S, G) entry and (S, G, RPT) entry exist.</p>
<pre> FS#show ip pim sparse-mode mroute IP Multicast Routing Table </pre>	

```

(*,*,RP) Entries: 0
(*,G) Entries: 1
(S,G) Entries: 0
(S,G,rpt) Entries: 0
FCR Entries: 0
REG Entries: 0

(*, 239.255.255.250)
RP: 192.168.8.8
RPF nbr: 0.0.0.0
RPF idx: None
Upstream State: JOINED
 00 01 02 03 04 05 06 07 08 09 10 11 12 13 14 15 16 17 18 19 20 21 22 23 24 25 26 27 28 29 30 31
Local
0 . . . . .
Joined
0 . j . . . . .
Asserted
0 . . . . .
FCR:
    
```

Limiting the Speed of the Source DR for Sending Register Packets

<p>Configuration Steps</p>	<ul style="list-style-type: none"> ● Configure basic PIM-SM functions. (Omitted) ● Check the number of PIM-SM packets sent by Router B. ● Check the number of PIM-SM packets sent by Router B in 1s. ● Configure the speed of Router B for sending register packets. ● Check the number of PIM-SM packets sent by Router B in 1s.
	<pre>FS (config)#ip pim register-rate-limit 1</pre>
<p>Verification</p>	<p>Display the number of PIM-SM packets sent by Router B before you configure the speed. The information should be displayed as follows:</p>
	<pre>FS#show ip pim sparse-mode track PIM packet counters track Elapsed time since counters cleared: 04d01h01m</pre>

	received	sent
Valid PIM packets:	18754	29771
Hello:	11149	17842
Join-Prune:	0	3234
Register:	0	3211
Register-Stop:	3192	0
Assert:	0	0
BSM:	0	5484
C-RP-ADV:	4413	0
PIMDM-Graft:	0	
PIMDM-Graft-Ack:	0	
PIMDM-State-Refresh:	0	
Unknown PIM Type:	0	
Errors:		
Malformed packets:		0
Bad checksums:		0
Send errors:		0
Packets received with unknown PIM version: 0		
FS#		

Display the number of PIM-SM packets sent by Router B in 1s before the speed is configured. The information should be displayed as follows:

```
FS #show ip pim sparse-mode track
PIM packet counters track
Elapsed time since counters cleared: 04d01h04ms
```

	received	sent
Valid PIM packets:	18765	29789
Hello:	11154	17852
Join-Prune:	0	3236
Register:	0	3214
Register-Stop:	3195	0
Assert:	0	0
BSM:	0	5487

<pre> C-RP-ADV: 4416 0 PIMDM-Graft: 0 PIMDM-Graft-Ack: 0 PIMDM-State-Refresh: 0 Unknown PIM Type: 0 Errors: Malformed packets: 0 Bad checksums: 0 Send errors: 0 Packets received with unknown PIM version: 0 FS# </pre>
<p>Display the number of PIM-SM packets sent by Router B after the speed is configured. The information should be displayed as follows:</p>
<pre> FS#show ip pim sparse-mode track PIM packet counters track Elapsed time since counters cleared: 04d01h06m received sent Valid PIM packets: 18777 29808 Hello: 11159 17862 Join-Prune: 0 3239 Register: 0 3215 Register-Stop: 3196 0 Assert: 0 0 BSM: 0 5489 C-RP-ADV: 4419 0 PIMDM-Graft: 0 PIMDM-Graft-Ack: 0 PIMDM-State-Refresh: 0 Unknown PIM Type: 0 Errors: Malformed packets: 0 </pre>

	<pre>Bad checksums: 0 Send errors: 0 Packets received with unknown PIM version: 0 FS#</pre>
--	---

➤ **Configuring the Checksum of the Register Packet Length**

Configuration Steps	<ul style="list-style-type: none"> ● Configure basic PIM-SM functions. (Omitted) ● Calculate the checksum of the entire register packet length. ● Run show running-config to check whether the preceding configurations take effect.
	<pre>FS(config)#ip pim register-checksum-wholepkt</pre>
Verification	<p>Display the configurations on Router A, which should be as follows:</p>
	<pre>FS#show running-config ! ip pim register-checksum-wholepkt ip pim rp-candidate Loopback 0 !</pre>

➤ **Enabling an RP to Decapsulate a Register Packet and Forward the Multicast Packet to Interfaces**

Configuration Steps	<ul style="list-style-type: none"> ● Configure basic PIM-SM functions. (Omitted) ● Enable Router A to forward a register packet. ● Run show running-config to check whether the preceding configurations take effect.
	<pre>FS(config)#ip pim register-decapsulate-forward</pre>
Verification	<p>Display the configurations on Router A, which should be as follows:</p>
	<pre>FS#show running-config ! ! ip pim register-decapsulate-forward ip pim register-checksum-wholepkt ip pim rp-candidate Loopback 0 ! ! !</pre>



➤ **Configuring the Source IP Address of a Register Packet**

Configuration Steps	<ul style="list-style-type: none"> ● Configure basic PIM-SM functions. (Omitted) ● Configure the source address of Loop 2 as 192.168.2.2. ● Configure source address interface for the register packet of Router B as Loop 2. ● Run show running-config to check whether the preceding configurations take effect.
Verification	<p>Display the configurations on Router B, which should be as follows:</p> <pre>FS#show running-config ! ! ! ip pim register-source Loopback 1 ip pim bsr-candidate Loopback 0 ! ! !</pre>

➤ **Configuring the Suppression Time of a Register Packet and the Inspection Time of a Null Register Packet**

Configuration Steps	<ul style="list-style-type: none"> ● Configure basic PIM-SM functions. (Omitted) ● Configure the suppression time of a register packet on Router B to 20s. ● Configure the inspection time of a null register packet on Router B to 2s. ● Run show ip pim sparse-mode track to display number of register packets.
	<pre>FS(config)#ip pim register-suppression 20 FS(config)#ip pim probe-interval 2</pre>
Verification	<p>Display the number of register packets on Router B. The information should be displayed as follows:</p> <pre>FS#show ip pim sparse-mode track PIM packet counters track Elapsed time since counters cleared: 04d23h15m received sent Valid PIM packets: 23788 43249 Hello: 13817 23178 Join-Prune: 0 4568</pre>

Register:	0	8684
Register-Stop:	4223	0
Assert:	0	0
BSM:	0	6819
C-RP-ADV:	5748	0
PIMDM-Graft:	0	
PIMDM-Graft-Ack:	0	
PIMDM-State-Refresh:	0	
Unknown PIM Type:	0	
Errors:		
Malformed packets:		0
Bad checksums:		0
Send errors:		0
Packets received with unknown PIM version: 0		
FS#		
FS#		

In 18s, display the number of register packets on Router B. The information should be displayed as follows:

```

FS#show ip pim sparse-mode track
PIM packet counters track
Elapsed time since counters cleared: 04d23h17m

                received                sent
Valid PIM packets: 23798                43263
Hello:             13820                23184
Join-Prune:        0                    4569
Register:          0                    8685
Register-Stop:    4224                  0
Assert:            0                    0
BSM:               0                    6820
C-RP-ADV:         5749                  0
PIMDM-Graft:      0
PIMDM-Graft-Ack:  0
PIMDM-State-Refresh: 0
    
```



```

Unknown PIM Type:      0

Errors:

Malformed packets:      0

Bad checksums:          0

Send errors:            0

Packets received with unknown PIM version: 0

FS#
    
```

➤ **Configuring an RP to Receive Register Packets and the (S, G) Lifetime**

Configuration Steps	<ul style="list-style-type: none"> ● Configure basic PIM-SM functions. (Omitted) ● Configure Router A to receive register packets and the (S, G) lifetime is 60s. ● Run show ip pim sparse-mode mroute to display number of register packets.
	<pre>FS(config)#ip pim rp-register-kat 60</pre>
Verification	<p>After the lifetime is configured, check that the (S, G) lifetime on Router A does not exceed 60s.</p>
	<pre> FS(config)#show ip pim sparse-mode mroute IP Multicast Routing Table (*,*,RP) Entries: 0 (*,G) Entries: 1 (S,G) Entries: 1 (S,G,rpt) Entries: 1 FCR Entries: 0 REG Entries: 0 (192.168.1.100, 233.3.3.3) RPF nbr: 192.168.36.90 RPF idx: VLAN 1 SPT bit: 0 Upstream State: NOT JOINED kat expires in 49 seconds 00 01 02 03 04 05 06 07 08 09 10 11 12 13 14 15 16 17 18 19 20 21 22 23 24 25 26 27 28 29 30 31 Local 0 </pre>

```
Joined
0 . . . . .
Asserted
0 . . . . .
Outgoing
0 . . . . .

(192.168.1.100, 233.3.3.3, rpt)
RP: 192.168.8.8
RPF nbr: 0.0.0.0
RPF idx: None
Upstream State: RPT NOT JOINED
  00 01 02 03 04 05 06 07 08 09 10 11 12 13 14 15 16 17 18 19 20 21 22 23 24 25 26 27 28 29 30 31
Local
0 . . . . .
Pruned
0 . . . . .
Outgoing
0 . . . . .

(*, 239.255.255.250)
RP: 192.168.8.8
RPF nbr: 0.0.0.0
RPF idx: None
Upstream State: JOINED
  00 01 02 03 04 05 06 07 08 09 10 11 12 13 14 15 16 17 18 19 20 21 22 23 24 25 26 27 28 29 30 31
Local
0 . . . . .
Joined
0 . j . . . . .
Asserted
0 . . . . .
FCR:
```

```
FS(config)#
FS(config)#show ip pi
```

Common Errors

- Basic PIM-SM functions are not configured or the configuration is not successful.
- The (S, G) of register packets is not configured on a C-RP or static RP, or the configuration is not successful.
- The ACL for limiting the (S, G) of register packets is not configured or the range of (S, G) in this ACL is not correctly configured.
- The range of (S, G) of register packets on each C-RP or static RP is not the same.

19.5.5 Configuring the Interval for Sending a Join/Prune Packet

Configuration Effect

- Change the interval for sending a Join/Prune packet to form an RPT or SPT.

Notes

- Basic PIM-SM functions must be configured.

Configuration Steps

- Configure the interval for sending a Join/Prune packet.

Verification

On Router B, configure the interval for sending a Join/Prune packet as 120s. Run **show ip pim sparse-mode mroute** to display the lifetime of the entry.

Related Commands

📌 **Configuring the Interval for Sending a Join/Prune Packet**

Command	ip pim jp-timer <i>seconds</i>
Parameter	<i>Seconds</i> : Indicates the interval for sending a Join/Prune packet.
Description	The unit is second. The value ranges from 1 to 65,535 (60 by default).
Command Mode	Global configuration mode
Usage Guide	N/A

Configuration Example

📌 **Configuring the Interval for Sending a Join/Prune Packet**

Configuration Steps	<ul style="list-style-type: none"> ● Configure basic PIM-SM functions. (Omitted) ● Configure the interval for sending a Join/Prune packet.
	FS(config)#ip pim jp-timer 120
Verification	Run show ip pim sparse-mode mroute to display the maximum timeout time of a Join/Prune packet.
	FS(config)#show ip pim sparse-mode mroute

```

IP Multicast Routing Table

(*,*,RP) Entries: 0

(*,G) Entries: 1

(S,G) Entries: 1

(S,G,rpt) Entries: 1

FCR Entries: 0

REG Entries: 1

(192.168.1.100, 233.3.3.3)

RPF nbr: 0.0.0.0

RPF idx: None

SPT bit: 1

Upstream State: JOINED

jt_timer expires in 96 seconds

kat expires in 92 seconds

  00 01 02 03 04 05 06 07 08 09 10 11 12 13 14 15 16 17 18 19 20 21 22 23 24 25 26 27 28 29 30 31

Local
0 . . . . .
1 . . . . .

Joined
0 . . . . .
1 . . . . .

Asserted
0 . . . . .
1 . . . . .

Outgoing
0 . . . . .
1 . . o . . . . .

.

(192.168.1.100, 233.3.3.3, rpt)

RP: 192.168.8.8

RPF nbr: 192.168.36.89

RPF idx: GigabitEthernet 0/1

```

```

Upstream State: RPT NOT JOINED

 00 01 02 03 04 05 06 07 08 09 10 11 12 13 14 15 16 17 18 19 20 21 22 23 24 25 26 27 28 29 30 31

Local
0 . . . . .
1 . . . . .

Pruned
0 . . . . .
1 . . . . .

Outgoing
0 . . . . .
1 . . . . .

(*, 239.255.255.250)
RP: 192.168.8.8
RPF nbr: 192.168.36.89
RPF idx: GigabitEthernet 0/1
Upstream State: JOINED
jt_timer expires in 119 seconds

 00 01 02 03 04 05 06 07 08 09 10 11 12 13 14 15 16 17 18 19 20 21 22 23 24 25 26 27 28 29 30 31

Local
0 . . . . i . . . . .
1 . . . . .

Joined
0 . . . . .
1 . . . . .

Asserted
0 . . . . .
1 . . . . .

FCR:

VSU(config)#
    
```

Common Errors

- Basic PIM-SM functions are not configured or the configuration is not successful.

19.5.6 Configuring the Router of Last Hop to Switch from an RPT to SPT

Configuration Effect

- Switch from an RPT to SPT

Notes

- Basic PIM-SM functions must be configured.

Configuration Steps

- Configure the router of last hop to switch from an RPT to SPT.

Verification

Configure basic PIM-SM functions first. Configure the source DR to send the data traffic (*, 233.3.3.3), and the receiving end to join group 233.3.3.3 forcibly to form an RPT. Configure the receiver DR to switch from the RPT to SPT forcibly. Run **show running-config** to display the result.

Related Commands

▾ Enabling SPT switchover

Command	ip pim spt-threshold [group-list access-list]
Parameter	
Description	group-list access-list: Specifies the range of multicast group addresses allowed for SPT switchover using an ACL. access-list: The supported value ranges from 1 to 99 or 1,300 to 1,999. Naming an ACL is also supported.
Command Mode	Global configuration mode
Usage Guide	If group-list access-list is not specified, all groups are allowed to perform SPT switchover.

Configuration Example

▾ Configuring the Router of Last Hop to Switch from an RPT to SPT

Configuration Steps	<ul style="list-style-type: none"> ● Configure basic PIM-SM functions. (Omitted) ● Configure the source DR to send the data traffic of group 233.3.3.3. ● Configure the receiver DR to receive the data traffic of group 233.3.3.3. ● Configure the receiver DR of last hop to switch from an RPT to SPT.
	<pre>FS(config)#ip pim spt-threshold</pre>
Verification	Run show running-config to display the configuration.
	<pre>! ! ip pim jp-timer 120 ip pim spt-threshold ip pim rp-candidate Loopback 0 !</pre>



19.6 Monitoring

Clearing



Running the **clear** commands may lose vital information and thus interrupt services.

Description	Command
Clears multicast routing entries.	clear ip mroute { * <i>group-address</i> [<i>source-address</i>] }
Clears the counters of multicast routes.	clear ip mroute statistics { * <i>group-address</i> [<i>source-address</i>] }
Clears the information about dynamic RPs.	clear ip pim sparse-mode bsr rp-set *
Clears the counters of PIM-SM packets.	clear ip pim sparse-mode track

Displaying

Description	Command
Displays the details of BSR information.	show ip pim sparse-mode bsr-router
Displays the PIM-SM information of an interface.	show ip pim sparse-mode interface [<i>interface-type interface-number</i>] [detail]
Displays the local IGMP information about a PIM-SM interface.	show ip pim sparse-mode local-members [<i>interface-type interface-number</i>]
Displays the information about a PIM-SM multicast routing entry, and displays the RPF vector of a PIM-SM entry using proxy .	show ip pim sparse-mode mroute [<i>group-or-source-address</i> [<i>group-or-source-address</i>]] [proxy]
Displays the information about PIM-SM neighbors.	show ip pim sparse-mode neighbor [detail]
Displays the information about the next hop of PIM-SM obtained from the NSM.	show ip pim sparse-mode nexthop
Displays the information about the RP corresponding the multicast group address <i>group-address</i> .	show ip pim sparse-mode rp-hash <i>group-address</i>
Displays the information about all the RPs and the groups they serve.	show ip pim sparse-mode rp mapping
Displays the number of PIM-SM packets sent and received since the statistic start time.	show ip pim sparse-mode track

20 Configuring PIM-SMv6

20.1 Overview

Protocol Independent Multicast (PIM) is a multicast routing protocol.

PIM does not rely on a specific unicast routing protocol. It uses the unicast routing table established by any unicast routing protocol to complete the reverse path forwarding (RPF) check and establish multicast routes. PIM does not need to transmit and receive multicast route updates. Therefore, the overhead of PIM is much lower than that of other multicast routing protocols.

PIM defines two modes: dense mode and sparse mode. Protocol Independent Multicast Sparse Mode (PIM-SM) is applicable to various network environments.

i PIM-SM running on IPv6 is called PIM-SMv6.

Protocols and Standards

- RFC4601: Protocol Independent Multicast -Sparse Mode (PIM-SM)
- RFC5059: Bootstrap Router (BSR) Mechanism for Protocol Independent Multicast (PIM)
- RFC3962: Protocol Independent Multicast - Dense Mode protocol
- RFC4607: Source-Specific Multicast for IP

20.2 Applications

Application	Description
ASM Implementation by Using PIM-SMv6	A receiver receives packets from any multicast source.
SSM Implementation by Using PIM-SMv6	A receiver selects a multicast source.
Application Example of an Embedded RP	An embedded RP address is configured within the IPv6 multicast group address.
PIM-SMv6 Application in a Hot Backup Environment	The multicast PIM-SMv6 protocol runs in a hot backup environment.

20.2.1 ASM Implementation by Using PIM-SMv6

Scenario

The multicast service is provided only in one domain.

As shown in the following figure, receivers receive packets from any multicast source.

Figure 7- 1

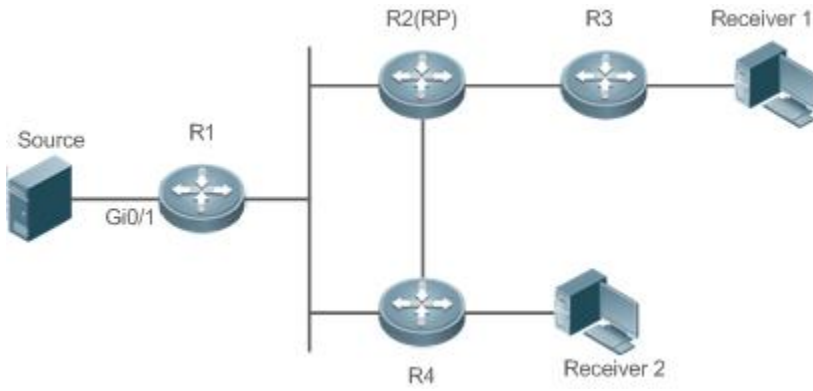

Remarks	R1 is directly connected to the multicast source. R2 is configured as a rendezvous point (RP). R3 is directly connected to Receiver A. R4 is directly connected to Receiver B.
----------------	---

Deployment

- Run the Open Shortest Path First for IPv6 (OSPFv6) protocol in the domain to implement unicast routing.
- Run the PIM-SMv6 protocol in the domain to implement multicast routing.
- Run the Internet Group Management Protocol version 6 (IGMPv6) protocol in a user host network segment to implement group member management.

20.2.2SSM Implementation by Using PIM-SMv6

Scenario

The multicast service is provided only in one domain.

As shown in the following figure, receivers receive packets from a specific multicast source.

Figure 7- 2

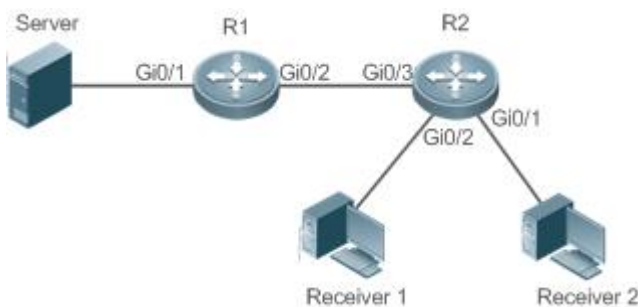

Remarks	R1 is directly connected to the multicast source. R2 is configured as an RP. R2 is directly connected to Receiver A. R2 is directly connected to Receiver B.
----------------	---

Deployment

- Run the OSPFv6 protocol in the domain to implement unicast routing.

- Run the PIM-SMv6 protocol in the domain to implement multicast routing.
- Enable the source-specific multicast (SSM) function of the PIM-SMv6 protocol to implement the SSM function.
- Run the Internet Group Management Protocol version 3 (IGMPv3) in a user host network segment to implement group member management.

20.2.3 Application Example of an Embedded RP

Scenario

The multicast service is provided only in one domain.

As shown in the following figure, an RP address is configured for R2 to make the router become an embedded RP.

Figure 7-3

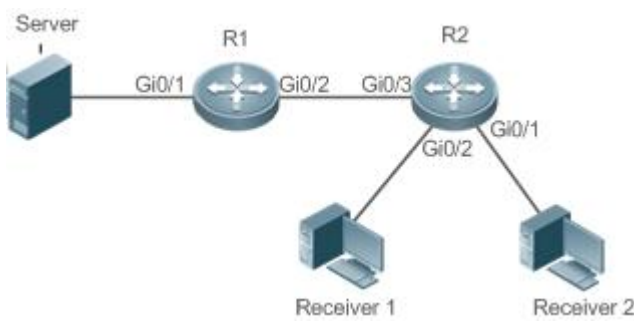

Remarks	<p>R1 is directly connected to the multicast source.</p> <p>R2 is configured as an RP.</p> <p>R2 is directly connected to Receiver A.</p> <p>R2 is directly connected to Receiver B.</p> <p>R2 is configured as an embedded RP.</p>
----------------	---

Deployment

- Run the OSPFv6 protocol in the domain to implement unicast routing.
- Run the PIM-SMv6 protocol in the domain to implement multicast routing.
- Enable the SSM function of the PIM-SMv6 protocol to implement the SSM function.
- Run the IGMPv3 protocol in a user host network segment to implement group member management.
- Configure the RP address and embedded RP on R2.

20.2.4 PIM-SMv6 Application in a Hot Backup Environment

Scenario

In a hot backup environment, run PIM-SMv6. A device performs hot backup switching to ensure that traffic is not interrupted.

Figure 7-4

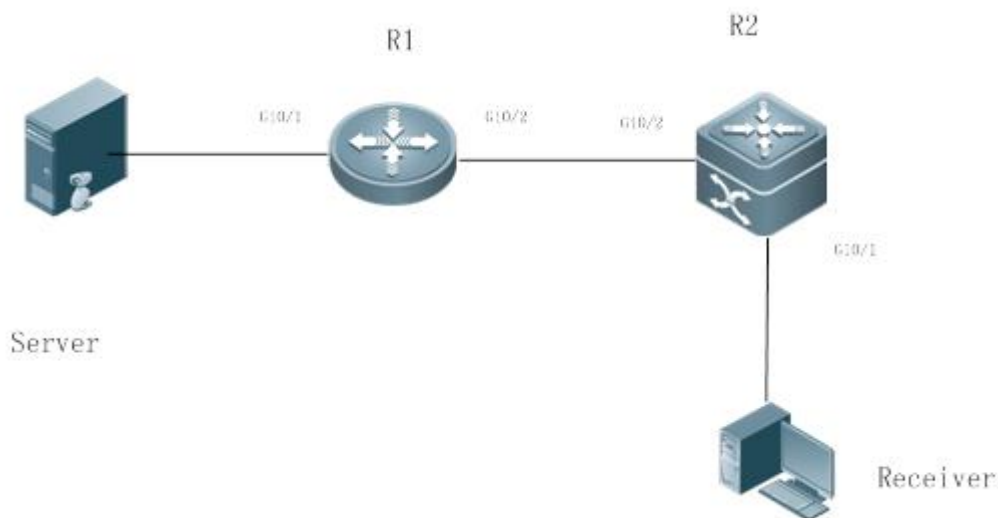

Remarks	R1 is connected to the video server, R2 is directly connected to the receiver, and R2 runs in hot backup mode. A Layer-3 multicast protocol runs on R1 and R2.
----------------	---

Deployment

- Run OSPF on R1 and R2 to implement unicast routing.
- Run PIM-SMv6 on R1 and R2 to implement multicast routing.
- Make R2 run in two-node cluster hot backup mode.

Remarks	R2 may perform hot backup switching in the hot backup environment. In this case, the query interval of PIM Hello packets (the default value is 30 seconds) needs to be adjusted on R2 because the keepalive timer of the neighbor in PIM Hello packets of R1 may have expired (the default value is 3.5 times the query interval, that is, 105 seconds). The multicast function relies on the unicast function currently, and the multicast function starts convergence after the unicast function convergence is complete. For example, the default graceful restart (GR) convergence time of the unicast function is 120 seconds. It is recommended that the query interval of PIM Hello packets be set to 60 seconds. The keepalive time of the neighbor in PIM Hello packets is 210 seconds. In this scenario, the query interval of PIM Hello packets need to be set with a reference to the GR convergence time of the unicast function and the value of 3.5 times the query interval of PIM Hello packets must be larger than the GR convergence time of the unicast function. In addition, if the convergence time of the unicast function is long, the transmission interval of PIM Join/Prune packets also need to be adjusted, because the keepalive time of PIM Join/Prune packets is 3.5 times the transmission interval of PIM Join/Prune packets. The default keepalive time of PIM Join/Prune packets is 210 seconds. If R2 is configured as a dynamic RP, the interval for a candidate RP (C-RP) to transmit C-RP notifications also needs to be adjusted. The default transmission interval is 60 seconds and the keepalive time is 2.5 times the transmission interval of C-RP notifications. For example, if the convergence time of the unicast function is longer than 150 seconds, the transmission interval of C-RP notifications needs to be adjusted. In a hot backup environment, it is recommended that the query interval of PIM Hello packets be larger than the default value (30 seconds). Otherwise, the keepalive timer of the neighbor in PIM Hello packets of the peer end times out during hot backup switching.
----------------	---

20.3 Features

Basic Concepts

↘ PIM Router and PIM Interface

Routers where the PIM protocol is enabled are called PIM routers. Interfaces where the PIM protocol is enabled are called PIM interfaces.

Multicast packets are forwarded by PIM routers. The PIM interfaces for receiving multicast packets are called upstream interfaces, and the PIM interfaces for transmitting multicast packets are called downstream interfaces.

Network segments where upstream interfaces are located are called upstream network segments. Network segments where downstream interfaces are located are called downstream network segments.

↘ PIM Network and PIM Domain

PIM routers are connected through PIM interfaces and form a PIM network.

On some PIM interfaces, borders are set to divide a large PIM network into multiple PIM domains. The borders may reject specific multicast packets or limit transmission of PIM messages.

↘ Multicast Distribution Tree, DR, RP

Multicast packets are transmitted from one point to multiple points. The forwarding path presents a tree structure. This forwarding path is called a multicast distribution tree (MDT). MDTs are classified into two types:

- Rendezvous point tree (RPT): Uses the rendezvous point (RP) as the root and designated routers (DRs) connected to group members as leaves.
- Shortest path tree (SPT): Use the DR connected to a multicast source as the root and the RPs or DRs connected to group members as leaves.

DRs and RPs are function roles of PIM routers.

- RPs collect information about multicast sources and group members in the network.
- The DR connected to a multicast source reports multicast source information to the RP and the DRs connected to group members report the group member information to the RP.

↘ (*,G), (S,G)

- (*,G): Indicates the packets transmitted from any source to Group G, routing entries corresponding to the packets, and forwarding path (RPT) corresponding to the packets.
- (S,G): Indicates the packets transmitted from Source S to Group G, routing entries corresponding to the packets, and forwarding path (SPT) corresponding to the packets.

↘ ASM, SSM

PIM-SM supports two multicast service models: any-source multicast (ASM) and source-specific multicast (SSM), which are applicable to different multicast address segments.

- ASM: In the ASM model, a user host cannot select a multicast source. The user host joins a multicast group and receives all packets sent from all sources to the multicast group.

- SSM: In the SSM model, a user host can select a multicast source. The user host specifies the source address when joining a multicast group, and then receives packets only from the specified source to the multicast group.
- **i** SSM model requirement: Other network services must be used to enable a user host to know the position of a multicast source in advance so that the user host selects the multicast source.

Overview

Feature	Description
Establishment of PIM Neighbor Relationships	Neighbor relationships are established between PIM routers to form a PIM network.
DR Election	In the shared network segment connected to group members, DR election is conducted among PIM neighbors to elect the DR connected to group members. In the shared network segment connected to a multicast source, DR election is conducted among PIM neighbors to elect the DR connected to the multicast source.
RP Mechanism	In a PIM network, the RP is statically configured or dynamically elected so that each PIM router knows the position of the RP.
Registration Information About a Multicast Source	When a multicast source arises in a network, the DR connected to the multicast source transmits the Register packet to the RP so that the RP obtains information about the multicast source and multicast packets.
RPT Establishment	When a group member arises in a network, the DR connected to the group member transmits the Join packet in the RP direction to establish an RPT. If there is a multicast source in the network, the multicast packet transmitted to the RP can reach the group member along the RPT.
SPT Establishment	When a data packet reaches the DR connected to a group member, the DR connected to the group member transmits the Join packet in the multicast source direction to establish an SPT. Then, multicast packets are forwarded along the SPT.
ASM and SSM Models	PIM routers provide multicast services of the ASM model and SSM model. The SSM model is used for groups within the SSM address range, and the ASM model is used for other groups.

20.3.1 Establishment of PIM Neighbor Relationships

Neighbor relationships are established between PIM routers to form a PIM network. Neighbor relationships must be established between PIM routers before other PIM control messages are exchanged or multicast packets are forwarded.

Working Principle

A Hello message is sent by a PIM interface. For the multicast packet for encapsulating the Hello message, the destination address is ff02::d (indicating all PIM routers in the same network segment), the source address is the IP address of the PIM interface, and the time to live (TTL) value is 1.

Hello messages are used to discover neighbors, negotiate about protocol parameters, and maintain neighbor relationships.

🔽 Discovering PIM Neighbors

PIM routers in the same network segment receive multicast packets with the destination address of ff02::d. In this way, the PIM routers obtain neighbor information and establish neighbor relationships.

When a PIM interface is enabled or detects a new neighbor, the Triggered-Hello-Delay message is used to generate a random time period. Within the time period, the interface sends Hello packets.

↘ **Negotiating About Protocol Parameters**

A Hello message contains multiple protocol parameters, which are described as follows:

- DR_Priority: Indicates the priority of each router interface for DR election. A higher priority means a higher possibility of being elected as the DR.
- Holdtime: Indicates the timeout time in which a neighbor is held in the reachable state.
- LAN_Delay: Indicates the delay for transmitting a Prune message in a shared network segment.
- Override-Interval: Indicates the prune override time carried in a Hello message.

When a PIM router receives a Prune message from an upstream interface, it indicates that other downstream interfaces exist in the shared network segment. If the PIM router still needs to receive multicast data, it must send a Prune Override message to the upstream interface within the time of **Override-Interval**.

$\text{LAN_Delay} + \text{Override-Interval} = \text{PPT}$ (Prune-Pending Timer). After a PIM router receives a Prune message from a downstream interface, it does not immediately perform pruning but waits for PPT timeout. After the PPT times out, the PIM router performs pruning. Within the time of PPT, if the PIM router receives a Prune Override message from the downstream interface, it cancels pruning.

↘ **Maintaining Neighbor Relationships**

A Hello message is sent periodically between PIM routers. If a Hello packet is not received from a PIM neighbor within Holdtime, the neighbor is considered unreachable and is deleted from the neighbor list. Any changes in PIM neighbors will cause multicast topology changes in the network. If an upstream neighbor or a downstream neighbor in an MDT is unreachable, multicast routing re-convergence is performed again and the MDT is migrated.

Related Configuration

↘ **Enabling the PIM-SMv6 Function on an Interface**

By default, the PIM-SMv6 function is disabled on an interface.

Run the **ipv6 pim sparse-mode** command to enable or disable the PIM-SMv6 function on an interface.

The PIM-SMv6 function must be enabled on an interface so that the interface participates in the operation of PIM protocols. If the PIM-SMv6 function is disabled on an interface that functions as a DR, static RP, candidate - rendezvous point (C-RP), or candidate - bootstrap router (C-BSR), the corresponding protocol role does not take effect.

↘ **Adjusting the Transmission Interval of Hello Messages on an Interface**

By default, Hello messages are transmitted at an interval of 30 seconds.

Run the **ipv6 pim query-interval seconds** command to adjust the transmission interval of Hello messages on an interface. The value ranges from 1 to 65,535.

A larger value of *interval-seconds* means a larger transmission interval of Hello messages and a smaller value of *interval-seconds* means a smaller transmission interval of Hello messages.

20.3.2DR Election

In the shared network segment connected to group members, DR election is conducted among PIM neighbors to elect the DR connected to the group members.

In the shared network segment connected to a multicast source, DR election is conducted among PIM neighbors to elect the DR connected to the multicast source.

The DR transmits the Join/Prune message in the MDT root node direction for the directly connected group members, or transmits data of the directly connected multicast source to the MDT.

Working Principle

The neighbor IP address and DR priority are obtained from Hello packets of neighbors during establishment of PIM neighbor relationships, so as to elect the DR.

The key of DR election is the DR priorities and IP addresses of interfaces.

↘ Interface DR Priority

A higher interface DR priority means a higher probability that a PIM router is successfully elected as the DR during the DR election.

↘ Interface IP Address

If interfaces of PIM routers share the same DR priority during DR election, IP addresses of neighbors are compared. A larger IP address means a higher probability that a PIM router is successfully elected as the DR.

Related Configuration

↘ Setting IP Addresses of Interfaces

By default, no IP addresses are configured for interfaces.

Run the **ipv6 address** command to set an IP address for an interface.

When PIM routers share the same DR priority, the PIM router with a larger IP address is elected as the DR.

↘ Enabling the PIM-SMv6 Function on an Interface

By default, the PIM-SMv6 function is disabled on an interface.

Run the **ipv6 pim sparse-mode** command to enable or disable the PIM-SMv6 function on an interface.

The PIM-SMv6 function must be enabled on an interface so that the interface participates in the operation of PIM protocols. If the PIM-SMv6 function is disabled on an interface that functions as a DR, static RP, C-RP, or C-BSR, the corresponding protocol role does not take effect.

↘ Adjusting the DR Priority of an Interface

By default, the DR priority is 1.

Run the **ipv6 pim dr-priority *priority-value*** command to adjust the DR priority of an interface. The priority value ranges from 0 to 4,294,967,294.

The DR priority of an interface is used to elect the DR in the directly connected network segment of the interface. A larger priority value means a higher probability that a PIM router is elected as the DR.

20.3.3 BSR Mechanism

In a PIM network, the bootstrap router (BSR) periodically generates bootstrap messages (BSMs) including information about a series of C-RPs and relevant group addresses. BSMs are transmitted hop by hop in the entire domain. PIM routers throughout the network receive BSMs and record information about C-RPs and the relevant group addresses.

Working Principle

One or more C-BSRs are configured in the PIM-SMv6 domain and the BSR is elected from the candidate BSRs according to certain rules.

Related Configuration

▾ Configuring a C-BSR

By default, no C-BSR is configured.

Run the **ipv6 pim bsr-candidate** *interface-type interface-number [hash-mask-length [priority-value]]* command to configure or cancel a C-BSR.

C-BSRs elect the globally unique BSR in the PIM-SM domain by means of BSM learning and election. The BSR transmits BSMs.

▾ Configuring the BSR Border

By default, no BSR border is configured.

Run the **ipv6 pim bsr-border** command to configure or cancel the BSR border.

After this command is configured for an interface, the interface immediately discards the received BSMs and does not forward BSMs, thereby preventing BSM flooding. No BSR border is configured if this command is not configured.

▾ Defining the Valid BSR Range

By default, the BSMs of BSRs are not filtered.

Run the **ipv6 pim accept-bsr list** *ipv6_access-list* command to define or cancel the BSR range.

After this command is configured, the valid BSR range is defined. If this command is not configured, the device with the PIM-SMv6 function enabled will receive all BSMs.

▾ Configuring a C-BSR to Restrict the Address Range of Valid C-RPs and the Range of Multicast Groups Served by the C-RPs

A C-BSR receives notifications from all C-RPs.

Run the **ipv6 pim accept-crp list** *ipv6_access-list* command to configure whether to filter notifications from C-RPs.

After this command is configured, the C-BSR restricts the address range of valid C-RPs and the range of multicast groups served by the C-RPs. If this command is not configured, the C-BSR receives notifications from all C-RPs.

▾ Configuring a C-BSR to Receive C-RP-ADV Packets with prefix-count of 0

By default, a C-BSR does not receive C-RP-ADV packets with prefix-count of 0.

Run the **ipv6 pim accept-crp-with-null-group** command to configure whether to receive C-RP-ADV packets with prefix-count of 0.

After this command is configured, the C-BSR can receive C-RP-ADV packets with prefix-count of 0. If this command is not configured, the C-BSR does not process C-RP-ADV packets with prefix-count of 0.

20.3.4RP Mechanism

In a PIM network, the RP is statically configured or dynamically elected so that each PIM router knows the position of the RP. The RP serves as the root of the RPT. The RPT establishment and the forwarding of RPT data streams must use the RP as the forwarding point.

Working Principle

All PIM routers in a PIM domain must be able to be mapped to the same RP through a specific multicast group address. RPs are classified into static RPs and dynamic RPs in a PIM network.

Static RP

In static RP configuration, the RP address is directly configured on each PIM router so that all PIM routers in the PIM network know the RP address.

Dynamic RP

C-RPs are also configured in the PIM-SMv6 domain. These C-RPs transmit data packets that contain their addresses and information about multicast groups served by them to the BSR in unicast mode. The BSR periodically generates BSMs that contain information about a series of C-RPs and their group addresses. BSMs are transmitted hop by hop in the entire domain. Devices receive and store these BSMs. The DR at the receive end uses a hash algorithm to map a group address to the C-RP that can serve the group. Then, the RP corresponding to the group address can be determined.

Related Configuration

Setting a Static RP Address

By default, no RP address is configured.

Run the **ipv6 pim rp-address** *ipv6_rp-address* [*ipv6_access-list*] command to configure or cancel a static RP address for a PIM router.

An RP must be configured so as to implement ASM in a PIM-SMv6 network. You can configure a static RP or dynamic RP.

If a static RP is configured in a PIM-SMv6 network, the static RP configuration on all devices in the PIM-SMv6 domain must be consistent to prevent multicast route ambiguity in the PIM-SMv6 domain.

Configuring a C-RP Address

By default, no C-RP address is configured.

Run the **ipv6 pim rp-candidate** *interface-type interface-number* [**priority** *priority-value*] [**interval** *interval-seconds*] [**group-list** *ipv6_access-list*] command to configure or cancel a PIM router as a C-RP.

C-RPs periodically transmit C-RP notifications to the BSR. Information contained in these C-RP notifications is dispersed to all PIM-SMv6 devices in the domain, thereby ensuring the uniqueness of RP mapping.

Ignoring the RP Priority in RP Setting

By default, a C-RP with a higher priority is selected preferentially.

Run the **ipv6 pim ignore-rp-set-priority** command to specify or ignore the RP priority when selecting the RP for a group.

When one RP needs to be selected for a multicast address and multiple RPs can serve this multicast address, use this command if the RP priority needs to be ignored during the RP comparison. If this command is not configured, the RP priority will be considered during the RP comparison.

Configuring the Static RP First

By default, a dynamic C-RP is adopted preferentially.

Run the **ipv6 pim static-rp-preferred** command to select the static RP first during RP selection.

After this command is configured, the static RP is adopted first. If this command is not configured, a C-RP is adopted first.

✚ **Configuring the Embedded RP Function**

By default, the embedded RP function is enabled for all IPv6 multicast group addresses where the RP address is embedded.

Run the **ipv6 pim rp embedded [group-list *ipv6_acl_name*]** command to enable the embedded RP function.

The embedded RP function is the peculiar RP discovery mechanism of IPv6 PIM. This mechanism uses the IPv6 multicast address where the RP address is embedded, to enable a multicast device to directly extract the RP address from the multicast address. By default, the embedded RP function is enabled for all IPv6 multicast group addresses where the RP address is embedded.

20.3.5 Registration Information About a Multicast Source

When a multicast source arises in a network, the DR connected to the multicast source transmits the Register packet to the RP so that the RP obtains information about the multicast source and multicast packets.

Working Principle

The DR at the data source end receives a multicast data packet from the directly connected host, and encapsulates the multicast data into a Register message. Then, it transmits the Register message to the RP in unicast mode. The RP generates the (S,G) entry.

If the forwarding entry contains an outgoing interface on the RP, the RP forwards the encapsulated data packet to the outgoing interface.

If the RP does not have the forwarding entry of the current group, it starts the (S,G) entry start timer. After the timer expires, the RP transmits the Register-Stop message to the DR and deletes the entry. After the DR at the data source end receives the Register-Stop message, the DR transmits the probing packet before the Register-Stop message timer expires.

If the DR does not receive the Register-Stop message, after the timer expires, the DR at the data source end encapsulates the multicast data into the Register message and transmits it to the RP in unicast mode.

If the DR receives the Register-Stop message, it re-starts the delay and re-transmits the probing packet before the delay expires.

Related Configuration

✚ **Configuring Reachability Detection of RP Register Packets**

By default, the RP reachability is not detected.

Run the **ipv6 pim register-rp-reachability** command to set or cancel the RP reachability detection.

If the RP reachability needs to be detected for the Register packet transmitted from the DR to the RP, you can configure this command. After this command is configured, the RP reachability is detected before the DR transmits the Register packet to the RP. That is, the DR queries the unicast routing table and static multicast routing table to check whether a route reachable to the RP exists. If no, the DR does not transmit the Register packet.

✚ **Configuring the RP to Filter Register Packets**

By default, the RP allows every received Register packet.

Run the **ipv6 pim accept-register { list *ipv6_access-list* [route-map *map-name*] | route-map *map-name* [list *ipv6_access-list*] }** command to enable or disable the RP to filter received Register packets.

To filter received Register packets on the RP, configure this command. If this command is not configured, the RP allows every received Register packet. If this command is configured, only Register packets whose source addresses and group addresses are allowed by the ACL are processed. Otherwise, the Register packets are filtered out.

✚ **Configuring the Transmission Rate Limit for Register Packets**

By default, the transmission rate of Register packets is not limited.

Run the **ipv6 pim register-rate-limit** *rate* command to configure whether to limit the transmission rate of Register packets.

If **no** is set in this command, the transmission rate is not limited. This command is used to configure the transmission rate of Register packets from the (S,G) multicast group address rather than the transmission rate of Register packets of the entire system.

✚ **Configuring the Checksum Calculation of a Register Packet Based on the Entire Register Packet**

By default, the checksum in a Register packet is calculated in default mode specified in the protocol.

Run the **ipv6 pim register-checksum-wholepkt** [**group-list** *ipv6_access-list*] command to set the packet length for checksum calculation.

If the entire PIM protocol packet including the encapsulated multicast data packet is used for checksum calculation of a Register packet, use this command. If this command is not configured, the checksum in a Register packet is calculated in default mode specified in the protocol.

✚ **Configuring the Source Address of Register Packets**

By default, the source address of Register packets uses the address of the DR interface connected to a multicast source.

Run the **ipv6 pim register-source** { *ipv6_local_address* | *interface-type interface-number* } command to configure the source address of Register packets.

To configure the source address of Register packets transmitted from the DR, use this command. If this command is not configured or **no** is set in this command, the source address of Register packets uses the address of the DR interface connected to a multicast source. If the address parameter of this command is used, the configured address must be a reachable unicast route. If the interface parameter of this command is used, this interface may be a loopback interface or an interface of other types and the interface address must be an advertised unicast route.

✚ **Configuring the Suppression Time of Register Packets**

The default suppression time of Register packets is 60 seconds.

Run the **ipv6 pim register-suppression** *seconds* command to configure the suppression time.

If this command is used to configure the suppression time of Register packets, configuring the value on the DR will change the suppression time of Register packets on the DR. If the **ipv6 pim rp-register-kat** *seconds* command is not configured, defining the value on the RP will change the keepalive time on the RP.

✚ **Configuring the Probing Time of NULL Register Packets**

The default probing time is 5 seconds.

Run the **ipv6 pim probe-interval** *interval-seconds* command to set the probing time.

The source DR transmits the NULL-Register packet to the RP within a certain interval prior to the timeout of the suppression time of the Register packet. This interval is the probing time. The default probing time is 5 seconds.

✚ **Configuring the Time Value of the RP KAT Timer**

By default, the KAT default value is used. KAT default value = Registration suppression time x 3 + Registration detection time.

Run the **ipv6 pim rp-register-kat seconds** command to set time of the KAT timer.

To configure the keepalive time of Register packets from the (S,G) multicast group address on the RP, use this command.

20.3.6RPT Establishment

When a group member arises in a network, the DR connected to the group member transmits the Join packet in the RP direction to establish an RPT. If there is a multicast source in the network, the multicast packet transmitted to the RP can reach the group member along the RPT.

Working Principle

The RPT establishment process is as follows:

11. The DR at the receive end receives an MLD (*,G)Include report packet from a receiver.
12. If the DR at the receive end is not the RP of Group G, the DR at the receive end transmits one (*,G)join packet in the RP direction. The upstream device that receives the (*,G)join packet transmits the (*,G)join packet in the RP direction. The (*,G)join packet is transmitted hop by hop till the RP of Group G receives the (*,G)join packet, indicating that the DR at the receive end joins the RPT.
13. When the data source host transmits multicast data to a group, the source data is encapsulated into the Register message and is transmitted to the RP in unicast mode by the DR at the data source end. The RP decapsulates the Register message, retrieves the data packet, and then forwards it to each group member along the RPT.
14. The RP transmits the (S,G)join packet to the DR at the data source end to join the SPT of this data source.
15. After the SPT from the RP to the DR at the data source end is established, data packets from the data source are transmitted to the RP along the SPT without encapsulation.
16. When the first multicast data packet reaches the RP along the SPT, the RP transmits the Register-Stop message to the DR at the data source end to enable the DR to stop the encapsulation of Register packets. After the DR at the data source end receives the Register-Stop message, it does not encapsulate the Register packets but transmits the Register packets to the RP along the SPT of the data source. The RP forwards the Register packets to each group member along the RPT.

Related Configuration

Configuring the Transmission Interval of Join/Prune Packets

The default transmission interval of Join/Prune packets is 60 seconds.

Run the **ipv6 pim jp-timer seconds** command to set the transmission interval of Join/Prune packets.

To change the default transmission interval of Join/Prune packets, configure this command. If this command is not configured, the default transmission interval of Join/Prune packets is 60 seconds.

20.3.7SPT Establishment

When a data packet reaches the DR connected to a group member, the DR connected to the group member transmits the Join packet in the multicast source direction to establish an SPT. Then, multicast packets are forwarded along the SPT, thereby relieving the load of the RP in the RPT and reducing the number of hops from the DR at the data source end to the receive end.

Working Principle

The SPT establishment process is as follows:

The DR at the receive end transmits the (*,G)join packet to the DR at the source end along the SPT. The (*,G)join packet is transmitted hop by hop till the DR at the source end receives the (*,G)join packet, forming an SPT.

Related Configuration

By default, SPT switching is disabled.

Run the **ipv6 pim spt-threshold [group-list ipv6_access-list]** command to configure whether to start SPT switching.

After this command is configured, when the DR receives the (S,G) packet from the first group member, one PIM Join message is generated and forwarded to the RP to establish a SPT tree. If **group-list** is defined, the defined group is switched from the RPT to the SPT. If **no** is set in this command and **group-list** is not defined, the switching from the RPT to the SPT is disabled and the device redirects to the RPT and transmits one Prune packet to the source. If **no** is set in this command, **group-list** is defined, and the defined ACL is a configured ACL, the ACL associated with **group-list** is cancelled and all groups are allowed to switch from the RPT to the SPT.

20.3.8ASM and SSM Models

PIM-SM supports two multicast models: ASM and SSM. In the ASM model, a multicast data receiver specifies only to join a multicast group G but does not specify the multicast source S. In the SSM model, a multicast data receiver can specify both the multicast source S and multicast group G.

- i** When the SSM model is implemented over IPv6, MLDv2 needs to be used to manage the member relationship between hosts and devices and PIM-SMv6 needs to be used to connect devices.

In the SSM model, a multicast receiver learns about the multicast source (S,G) information by means of some channels (such as accessing the server or receiving advertisements) in advance. When the multicast receiver needs to order a multicast service, it directly transmits the MLD(S,G) Join packet to the last-hop device, for example, as shown in the following figure, Multicast Receiver 1 transmits the MLD(S,G) Join packet to order the multicast service (S,G). After receiving the MLD(S,G) Join packet from the multicast receiver, the last-hop device transmits the PIM(S,G) Join packet to the multicast source hop by hop, for example, as shown in the following figure, after receiving the MLD(S,G) Join packet from Multicast Receiver 1, R1 transmits the PIM(S,G) Join packet to R3, which transmits the PIM (S,G) Join packet to R4. As a result, the SPT from the multicast receiver to the multicast source is established.

Figure 7- 5

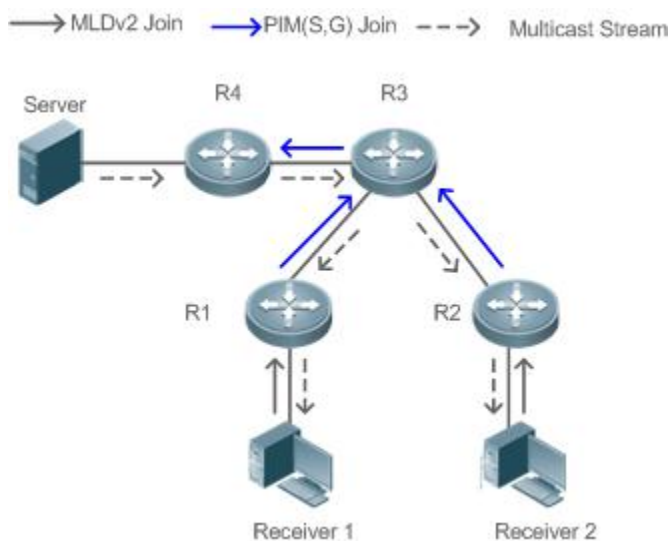

The following conditions need to be met for the implementation of the SSM model:

- A multicast receiver learns about the multicast source (S,G) information beforehand by means of some channels. The multicast receiver initiates the MLD(S,G) Join packet to the desired multicast service.
- MLDv2 must be enabled on the interface of the last-hop device connected to the multicast receiver. MLDv1 does not support SSM.
- PIM-SM and SSM must be enabled on the intermediate devices between the multicast receiver and the multicast source.
-  After the SSM function is enabled, the default group range of SSM is FF3x::/32. You can run a command to change the group range of SSM.

The SSM model has the following features:

- In the SSM model, a multicast receiver can learn about the multicast source information in advance by means of some channels (for example, receiving advertisements or accessing a specified server).
- The SSM model is a specific subset of PIM-SM and processes only PIM(S,G) Join and PIM(S,G) Prune messages. It discards RPT-relevant messages within the SSM range, for example, PIM(*,G) Join/Prune messages. For Register packets within the SSM range, it immediately responds with the Register-Stop packet.
- In the SSM model, no RP is required and the election and distribution of RP messages are not required. The established MDT is the SPT in SSM.

20.4 Configuration

20.4.1 Configuring Basic Functions of PIM-SMv6

Configuration Effect

- Create a PIM network to provide the IPv6 multicast service for data sources and user terminals in the network.
- Both or either of the two multicast service models (ASM and SSM) can be supported.

Notes

- PIM-SMv6 needs to use the IPv6 unicast routing function.
- If the PIM network needs to support the multicast service of the SSM model, MLDv3 or SSM Mapping needs to be configured.

Configuration Steps

▾ Enabling the IPv6 Multicast Routing Function

- Mandatory.
- The IPv6 multicast routing function should be enabled on each router unless otherwise specified.

▾ Enabling the PIM-SMv6 Function

- Mandatory.
- The PIM-SMv6 function should be enabled on the following interfaces unless otherwise specified: router interconnection interfaces, interface that function as a static RP, C-RP, or C-BSR, interface for connecting to a multicast source, and interface for connecting to a user host.

▾ Enabling the PIM-SMv6 PASSIVE Mode

- In a PIM network, if an interface needs to receive only multicast data packets and does not need to participate in the establishment of the PIM network topology, the interface can be configured to work in PIM-SMv6 PASSIVE mode.
- The PIM-SMv6 PASSIVE function should be enabled on the following interfaces unless otherwise specified: interface for connecting the stub network device to a user host. After the PIM-SMv6 PASSIVE mode is configured, this interface neither transmits nor receives PIM packets.

➤ **Configuring an RP**

- If a PIM network needs to support the multicast service of the ASM model, an RP must be configured.
- There are three methods of configuring an RP: configuring only a static RP, configuring only a dynamic RP, and configuring both a static RP and a dynamic RP. If both a static RP and a dynamic RP are configured, the dynamic RP is preferred.
- Configuring a static RP: A static RP should be configured on each router unless otherwise specified.
- Configuring a dynamic RP: A C-RP or C-BSR should be configured on one or more routers unless otherwise specified.

➤ **Enabling the SSM**

- If a PIM network needs to support the multicast service of the SSM model, the SSM must be enabled.
- The SSM should be enabled on each router unless otherwise specified.

Verification

Make a multicast source in the network send packets to groups within the range of ASM and SSM and make a user host join the groups.

- Check whether the user host can successfully receive packets from each group.
- Check whether correct PIM-SMv6 routing entries are created on routers.

Related Commands

➤ **Enabling the IPv6 Multicast Routing Function**

Command	ipv6 multicast-routing
Parameter	N/A
Description	
Command Mode	Global configuration mode
Usage Guide	N/A

➤ **Enabling the PIM-SMv6 Function**

Command	ipv6 pim sparse-mode
Parameter	N/A
Description	
Command Mode	Interface configuration mode
Usage Guide	Before enabling the PIM-SMv6 function, enable the multicast routing forwarding function in global configuration mode. Otherwise, multicast data packets cannot be forwarded even if the PIM-SMv6 function is enabled. When the PIM-SMv6 function is enabled, MLD is automatically enabled on each interface without manual

	<p>configuration.</p> <p>If the message "Failed to enable PIM-SMv6 on <interface name>, resource temporarily unavailable, please try again" is displayed during the configuration of this command, try to configure this command again.</p> <p>If the message "PIM-SMv6 Configure failed! VIF limit exceeded in NSM!!!" is displayed during the configuration of this command, the configured number of multicast interfaces reaches the upper limit of multicast interfaces that can be configured on the device. If the PIM-SMv6 function still needs to be enabled on an interface, delete some unnecessary PIM-SMv6 or PIM-DMv6 interfaces.</p> <p>If an interface is of the tunnel type, only the 6Over4 configuration tunnel, 6Over4 GRE tunnel, 6Over6 configuration tunnel, and 6Over6 GRE tunnel support the IPv6 multicast function. The multicast function can also be enabled on tunnel interfaces that do not support the multicast function but no prompts are displayed and multicast packets are neither received nor transmitted.</p> <p>Multicast tunnels can be established only on Ethernet ports. Embedded tunnels and QoS/ACL of multicast data are not supported.</p>
--	--

▾ Enabling the PIM-SMv6 PASSIVE Function

Command	ipv6 pim sparse-mode passive
Parameter	N/A
Description	
Command Mode	Interface configuration mode
Usage Guide	<p>Before enabling the PIM-SMv6 function, enable the multicast routing forwarding function in global configuration mode. Otherwise, multicast data packets cannot be forwarded even if the PIM-SMv6 PASSIVE function is enabled.</p> <p>When the PIM-SMv6 function is enabled, MLD is automatically enabled on each interface without manual configuration.</p> <p>Interfaces with the PIM-SMv6 PASSIVE function enabled neither receive nor transmit PIM packets but can forward multicast packets. Therefore, the PIM-SMv6 PASSIVE mode is generally configured on the interface of the stub network device connected to a user host, so as to prevent Layer-2 flooding of PIM Hello packets.</p>

▾ Configuring a Static RP

Command	ipv6 pim rp-address <i>ipv6_rp-address</i> [<i>ipv6_access-list</i>]
Parameter Description	<p><i>ipv6_rp-address</i>: Indicates the IPv6 address of an RP.</p> <p><i>ipv6_access_list</i>: References an IPv6 ACL to restrict the group address range served by the static RP. A named ACL is supported.</p>
Command Mode	Global configuration mode
Usage Guide	<p>Multicast static RPs can be configured. A static RP and a C-RP can coexist.</p> <p>Notes:</p> <ol style="list-style-type: none"> 1. If both the BSR mechanism and RP static configuration are effective, the dynamic configuration is preferred. 2. A control list can be used to statically configure the address of an RP for multiple multicast groups (using the ACL) or all multicast groups (without using the ACL), but one static RP address cannot be used multiple times. 3. If multiple static RPs serve the same group, the static RP with a larger IPv6 address is used preferentially. 4. Only multicast groups with the addresses allowed by the ACL are effective. By default, all multicast groups are allowed.

	<p>5. After the configuration is complete, the static RP source address will be inserted into the group range-based static RP group tree structure. The multicast static group in each group range maintains the linked list structure of one static RP group. This linked list is arranged in descending order by IPv6 address. When an RP is selected for a group range, the RP with the largest IPv6 address will be selected.</p> <p>6. When a static RP address is deleted, this address is deleted from all existing groups and an address is selected from the existing static RP tree structure as the RP address.</p>
--	--

↘ **Configuring a C-RP**

Command	ipv6 pim rp-candidate <i>interface-type interface-number</i> [priority <i>priority-value</i>] [interval <i>interval-seconds</i>] [group-list <i>ipv6_access-list</i>]
Parameter Description	<p><i>interface-type interface-number</i>: Indicates an interface name. This interface address is used as the C-RP address.</p> <p>priority <i>priority-value</i>: Specifies the priority of the C-RP. The value ranges from 0 to 255 and the default value is 192.</p> <p>interval <i>seconds</i>: Indicates the interval for transmitting C-RP messages to the BSR, with the unit of seconds. The value ranges from 1 to 16,383 and the default value is 60.</p> <p>group-list <i>ipv6_access-list</i>: References an IPv6 ACL to restrict the group address range served by the C-RP. A named ACL is supported.</p>
Command Mode	Global configuration mode
Usage Guide	<p>In the PIM-SMv6 protocol, the RPT created by the multicast routing uses an RP as the root node. After the BSR is elected, all C-RPs periodically transmit C-RP messages to the BSR in unicast mode and then the BSR disperses the messages in the entire PIM domain.</p> <p>To specify an interface as the C-RP of a specific group range, contain the ACL option in this command. Note that the calculation of the group range is based only on the permitted access control entries (ACEs) and denied ACEs are not involved in the calculation.</p> <p>If group-list <i>ipv6_access-list</i> is not carried in the command, all groups are served.</p>

↘ **Configuring a C-BSR**

Command	ipv6 pim bsr-candidate <i>interface-type interface-number</i> [<i>hash-mask-length</i> [<i>priority-value</i>]]
Parameter Description	<p><i>interface-type interface-number</i>: Indicates an interface name. This interface address is used as the C-BSR address.</p> <p><i>hash-mask-length</i>: Indicates the hash mask length. The value ranges from 0 to 128 and the default value is 126.</p> <p><i>priority-value</i>: Indicates the priority. The value ranges from 0 to 255 and the default value is 64.</p>
Command Mode	Global configuration mode
Usage Guide	<p>A unique BSR must exist in a PIM-SMv6 domain. The BSR collects and advertises RP information. The unique well-known BSR is elected from multiple C-BSRs by means of BSMs. All C-BSRs consider that they are the BSR before knowing the BSR information. They periodically transmit BSMs that contain the BSR address and priority in the PIM-SMv6 domain.</p> <p>This command can be used to enable a device to transmit one BSM to all PIM neighbors by using the allocated BSR address. Each neighbor compares the original BSR address with the address in the received BSM. If the IPv6 address in the received BSM is equal to or larger than its BSR address, the neighbor stores this address as the BSR address and forwards the BSM. Otherwise, the neighbor discards the BSM.</p> <p>The current device deems that it is the BSR till it receives a BSM from another C-BSR and learns that the C-BSR has a higher priority (or the same priority but a larger IPv6 address).</p>

➤ **Enabling the SSM**

Command	<code>ipv6 pim ssm { default range ipv6_access-list }</code>
Parameter	default: The default group address range of SSM is FF3x::/32.
Description	range ipv6_access-list: References an IPv6 ACL to restrict the SSM group address range. A named ACL is supported.
Command Mode	Global configuration mode
Usage Guide	To apply SSM in a PIM-SMv6 network, you must configure this command.

➤ **Displaying the PIM-SM Routing Table**

Command	<code>show ipv6 pim sparse-mode mroute [group-or-source-address [group-or-source-address]]</code>
Parameter	<i>group-or-source-address:</i> Indicates the group address or source address. The two addresses cannot be group addresses or source addresses at the same time.
Command Mode	Privileged EXEC mode, global configuration mode, and interface configuration mode
Usage Guide	A group address, a source address, or both group address and source address can be specified each time. You can also not specify a specific group address or source address but you cannot specify two group addresses or two source addresses at the same time.

Configuration Example

➤ **Creating the IPv6 Multicast Service on an IPv6 Network to Support ASM and SSM**

<p>Scenario Figure 7-6</p>	
<p>Configuration Steps</p>	<ul style="list-style-type: none"> ● Configure an IPv6 unicast routing protocol (such as OSPFv6) on the routers and ensure that the unicast routes of the loopback interfaces are reachable. (Omitted) ● Enable the IPv6 multicast routing function on all routers. ● Enable the PIM-SMv6 function on device interconnection interfaces, interface for connecting to the user host, and interface for connecting to the multicast source. ● Configure a C-RP and a C-BSR on the loopback interfaces of Router A and Router B. Enable the PIM-SMv6 function on the loopback interfaces. ● Enable SSM on all routers. ● Enable MLDv3 on the router interface for connecting to the user host. (Omitted)

A	<pre> switch(config)#ipv6 multicast-routing switch(config)#ipv6 pim ssm default switch(config)#int gi 0/2 switch(config-if-GigabitEthernet 0/2)#ipv6 add 2000::2/64 switch(config-if-GigabitEthernet 0/2)#ipv6 pim sparse-mode switch(config-if-GigabitEthernet 0/2)#exit switch(config)#int gi 0/1 switch(config-if-GigabitEthernet 0/1)#ipv6 add 1000::1/64 switch(config-if-GigabitEthernet 0/1)#ipv6 pim sparse-mode switch(config-if-GigabitEthernet 0/1)#exit switch(config)#int Loopback 0 switch(config-if-Loopback 0)#ipv6 add 3000::5/64 switch(config-if-Loopback 0)#ipv6 pim sparse-mode switch(config-if-Loopback 0)#exit switch(config)#ipv6 pim rp-candidate Loopback 0 </pre>
B	<pre> FS(config)#ipv6 multicast-routing FS(config)#ipv6 pim ssm default FS(config)#int gi 0/2 FS(config-if-GigabitEthernet 0/2)#ipv6 add 2000::1/64 FS(config-if-GigabitEthernet 0/2)#ipv6 pim sparse-mode FS(config-if-GigabitEthernet 0/2)#exit FS(config)#int gi 0/1 FS(config-if-GigabitEthernet 0/1)#ipv6 add 1100::1/64 FS(config-if-GigabitEthernet 0/1)#ipv6 pim sparse-mode FS(config-if-GigabitEthernet 0/1)#exit FS(config)#int Loopback 0 FS(config-if-Loopback 0)#ipv6 add 5000::5/64 FS(config-if-Loopback 0)#ipv6 pim sparse-mode FS(config-if-Loopback 0)#exit FS(config)#ipv6 pim bsr-candidate Loopback 0 </pre>
Verification	<p>Make Source(2000::2/64) send packets to G1(ff16::1) and make User join G1.</p> <ul style="list-style-type: none"> ● Check the multicast packets received by the User. The User should be able to receive multicast packets from G1. ● Check PIM-SMv6 routing tables on Router A and Router B. Entries should exist on the PIM-SMv6 routing tables.

A

```

switch(config)# show ipv6 pim sparse-mode mroute

IPv6 Multicast Routing Table

(*,*,RP) Entries: 0
(*,G) Entries: 1
(S,G) Entries: 1
(S,G,rpt) Entries: 1
FCR Entries: 0
REG Entries: 0

(*,ff16::1)
RP: 3000::5
RPF nbr: ::
RPF idx: None
Upstream State: JOINED

 00 01 02 03 04 05 06 07 08 09 10 11 12 13 14 15 16 17 18 19 20 21 22 23 24 25 26 27 28 29 30 31
Local
0 . . . i . . . . . . . . . . . . . . . . . . . . . . . . . . . . . . . . . . . . . . . . . . . . . . . . . . . .
1 . . . . . . . . . . . . . . . . . . . . . . . . . . . . . . . . . . . . . . . . . . . . . . . . . . . .
Joined
0 . . . . . . . . . . . . . . . . . . . . . . . . . . . . . . . . . . . . . . . . . . . . . . . . . . . .
1 . . . . . . . . . . . . . . . . . . . . . . . . . . . . . . . . . . . . . . . . . . . . . . . . . . . .
Asserted
0 . . . . . . . . . . . . . . . . . . . . . . . . . . . . . . . . . . . . . . . . . . . . . . . . . . . .
1 . . . . . . . . . . . . . . . . . . . . . . . . . . . . . . . . . . . . . . . . . . . . . . . . . . . .
FCR:

(1100::2, ff16::1)
RPF nbr: fe80::21a:a9ff:fe3a:6355
RPF idx: GigabitEthernet 0/2
SPT bit: 1
Upstream State: JOINED
jt_timer expires in 44 seconds
kat expires in 194 seconds
    
```

	<pre>00 01 02 03 04 05 06 07 08 09 10 11 12 13 14 15 16 17 18 19 20 21 22 23 24 25 26 27 28 29 30 31 Local 0 1 Joined 0 1 Asserted 0 1 Outgoing 0 . . 0 1 (1100::2, ff16::1, rpt) RP: 3000::5 RPF nbr: :: RPF idx: None Upstream State: PRUNED 00 01 02 03 04 05 06 07 08 09 10 11 12 13 14 15 16 17 18 19 20 21 22 23 24 25 26 27 28 29 30 31 Local 0 1 Pruned 0 1 Outgoing 0 . . 0 1</pre>
B	<pre>FS#show ipv6 pim sparse-mode mroute IPv6 Multicast Routing Table (*,*,RP) Entries: 0 (*,G) Entries: 0</pre>

```

(S,G) Entries: 1
(S,G,rpt) Entries: 1
FCR Entries: 0
REG Entries: 1

(1100::2, ff16::1)
RPF nbr: ::
RPF idx: None
SPT bit: 1
Upstream State: JOINED
kat expires in 20 seconds

 00 01 02 03 04 05 06 07 08 09 10 11 12 13 14 15 16 17 18 19 20 21 22 23 24 25 26 27 28 29 30 31
Local
0 . . . . .
Joined
0 . j . . . . .
Asserted
0 . . . . .
Outgoing
0 . o . . . . .

(1100::2, ff16::1, rpt)
RP: 3000::5
RPF nbr: fe80::2d0:f8ff:fe22:341b
RPF idx: GigabitEthernet 0/2
Upstream State: RPT NOT JOINED

 00 01 02 03 04 05 06 07 08 09 10 11 12 13 14 15 16 17 18 19 20 21 22 23 24 25 26 27 28 29 30 31
Local
0 . . . . .
Pruned
0 . . . . .
Outgoing
0 . . . . .

```

Common Errors

- IPv6 unicast routing is incorrectly configured.
- IPv6 multicast routing is not enabled on a router.
- SSM is not enabled on a router or the SSM group address range of the router is different from that of other routers.
- PIM-SMv6 is not enabled on an interface (for example, interface that is specified as a C-RP or C-BSR, or interface that functions as the gateway of a user host or multicast source).
- MLDv3 is not enabled on an interface connected to a user host.
- No RP is configured in the network.
- No static RP is configured on a router or the configured static RP is different from that on other routers.
- A C-RP is configured but no C-BSR is configured in the network.
- The unicast route to the static RP, C-RP, or C-BSR is unreachable.

20.4.2 Configuring PIM Neighbor Parameters

Configuration Effect

- Negotiate about protocol parameters and adjust parameters in a Hello packet.
- PIM routers discover neighbors, negotiate about protocol parameters, and maintain neighbor relationships.
- Protect neighbor relationships to restrict neighbors.

Notes

- The basic functions of PIM-SMv6 must be configured.

Configuration Steps

- Set parameters on each PIM router interface unless otherwise specified.

Verification

Set parameters in a Hello packet on an interface and run the **debug ipv6 pim sparse-mode packet** command to check parameters in the Hello packet.

Set neighbor filtering and run the **show ipv6 pim sparse-mode neighbor** command to check the neighbor relationship.

Related Commands

▾ Configuring the Transmission Interval of Hello Messages

Command	ipv6 pim query-interval <i>seconds</i>
Parameter	Indicates the transmission interval of Hello packets.
Description	The unit is seconds. The value ranges from 1 to 65,535 and the default value is 30 .
Command Mode	Interface configuration mode
Usage Guide	Each time the transmission interval of Hello messages is updated, the Holdtime of Hello messages is accordingly updated according to the following rule: The Holdtime of Hello messages is updated to 3.5 times transmission interval of Hello messages. If the transmission interval of Hello messages multiplied by 3.5 is larger than 65,535, the transmission interval of Hello messages is forcibly updated to 18,725.

✚ Configuring the Propagation Delay for Hello Messages

Command	ipv6 pim propagation-delay <i>milliseconds</i>
Parameter Description	<i>milliseconds</i> : The unit is milliseconds. The value ranges from 1 to 32,767 and the default value is 500 .
Command Mode	Interface configuration mode
Usage Guide	Changing the propagation delay or prune override delay will affect J/P-override-interval. According to the protocol, J/P-override-interval must be smaller than the Holdtime of Join-Prune packets. Otherwise, short flow interruption will be incurred. This must be maintained and guaranteed by network administrators.

✚ Configuring the Prune Override Interval for Hello Messages

Command	ipv6 pim override-interval <i>milliseconds</i>
Parameter Description	<i>milliseconds</i> : The unit is milliseconds. The value ranges from 1 to 65,535 and the default value is 2500 .
Command Mode	Interface configuration mode
Usage Guide	Changing the propagation delay or prune override delay will affect J/P-override-interval. According to the protocol, J/P-override-interval must be smaller than the Holdtime of Join-Prune packets. Otherwise, short flow interruption will be incurred.

✚ Configuring the Interface Joining Suppression Capability for Hello Messages

Command	ipv6 pim neighbor-tracking
Parameter Description	N/A
Command Mode	Interface configuration mode
Usage Guide	When the joining suppression capability of an interface is enabled and the local router needs to transmit a Join packet to an upstream neighbor, the Join packet of the local router is suppressed and is not transmitted if the local router receives a Join packet from a neighbor to the upstream router. If the joining suppression capability of the interface is disabled, the local router transmits the Join packet. When the joining suppression capability of a downstream receiver is disabled, the upstream neighbor can accurately know the number of receivers connected to the downstream neighbor through the received Join packet, thereby implementing neighbor tracking.

✚ Configuring the Delay of Sending Out Hello Messages

Command	ipv6 pim triggered-hello-delay <i>seconds</i>
Parameter Description	<i>Seconds</i> : The unit is seconds. The value ranges from 1 to 5 and the default value is 5 .
Command Mode	Interface configuration mode
Usage Guide	When an interface is enabled or detects a new neighbor, the Triggered-Hello-Delay message is used to generate a random time period. Within the time period, the interface sends Hello packets.

✚ Configuring the DR Priority for Hello Messages

Command	ipv6 pim dr-priority <i>priority-value</i>
Parameter	<i>priority-value</i> : Indicates the priority. A larger value means a higher priority.
Description	The value ranges from 0 to 4,294,967,294 and the default value is 1.
Command Mode	Interface configuration mode
Usage Guide	<p>The process of selecting a DR is as follows:</p> <p>The priority parameter is set for Hello packets of devices in the same LAN. The priority is compared for the selection of a DR. The device with a higher priority is the DR. If multiple devices share the same priority, the device with a larger IP address is the DR.</p> <p>When the priority parameter is not set for Hello packets of a device in a LAN, the device with a larger IP address is elected as the DR in the LAN.</p>

📌 **Configuring Neighbor filtering**

Command	ipv6 pim neighbor-filter <i>ipv6_access-list</i>
Parameter	<i>ipv6_access-list</i> : References an IPv6 ACL to restrict the neighbor address range.
Description	
Command Mode	Interface configuration mode
Usage Guide	This command can be used to filter neighbors to strengthen the security of the PIM network and restrict the address range of legitimate neighbors. If a neighbor is rejected by an ACL, PIM-SMv6 will not establish a peering relationship with this neighbor or suspend the peering relationship with this neighbor.

📌 **Displaying Neighbor Information About an Interface**

Command	show ipv6 pim sparse-mode neighbor [detail]
Parameter	detail : Displays details.
Description	
Command Mode	Privileged EXEC mode, global configuration mode, and interface configuration mode
Usage Guide	N/A

Configuration Example

Configuration Steps	<ul style="list-style-type: none"> ● Configure basic functions of PIM-SMv6. (Omitted) ● Set the transmission interval of Hello packets of PIM-SMv6 to 50 seconds. ● Set the propagation delay of Hello packets of PIM-SMv6 to 400 milliseconds. ● Set the prune override interval of Hello packets of PIM-SMv6 to 3,000 milliseconds. ● Configure the interface joining suppression capability for Hello messages of PIM-SMv6. ● Set the delay of sending out Hello messages of PIM-SMv6 to 3 seconds. ● Set the DR priority of Hello messages of PIM-SMv6 to 5.
----------------------------	---

	<pre>switch # configure terminal switch (config)#int gi 0/1 switch (config-if-GigabitEthernet 0/1)#ipv6 pim query-interval 50 switch (config-if-GigabitEthernet 0/1)#ipv6 pim propagation-delay 400 switch (config-if-GigabitEthernet 0/1)#ipv6 pim override-interval 3000 switch (config-if-GigabitEthernet 0/1)#ipv6 pim triggered-hello-delay 3 switch (config-if-GigabitEthernet 0/1)# ipv6 pim dr-priority 5</pre>
Verification	Run the debug ipv6 pim sparse-mode packet command to check parameters in a Hello packet.
	<pre>switch # debug ipv6 pim sparse-mode packet *Jan 2 02:37:55: %7: Hello send to GigabitEthernet 0/2 *Jan 2 02:37:55: %7: Send Hello message *Jan 2 02:37:55: %7: Holdtime: 175 *Jan 2 02:37:55: %7: T-bit: off *Jan 2 02:37:55: %7: Propagation delay: 400 *Jan 2 02:37:55: %7: Override interval: 3000 *Jan 2 02:37:55: %7: DR priority: 5 *Jan 2 02:37:55: %7: Gen ID: 99572792 *Jan 2 02:37:55: %7: Secondary Addresses: *Jan 2 02:37:55: %7: 2000::2</pre>
Configuration Steps	Configure neighbor filtering on an interface to receive neighbor packets with the address of (8000::1/64).
	<pre>switch(config-if-GigabitEthernet 0/2)#ipv6 pim neighbor-filter acl % access-list acl not exist switch(config-if-GigabitEthernet 0/2)#exit switch(config)#ipv6 access-list acl switch(config-ipv6-acl)#permit ipv6 8000::1/64 any</pre>
Verification	Before neighbor filtering is configured, display the neighbor information.
	<pre>switch#show ipv6 pim sparse-mode neighbor Neighbor Address Interface Uptime/Expires DR Pri/Mode fe80::21a:a9ff:fe3a:6355 GigabitEthernet 0/2 00:32:29/00:01:16 1 /</pre>
Verification	After neighbor filtering is configured, the neighbor information is blank.

```
switch#show ipv6 pim sparse-mode neighbor
```

Common Errors

- The basic functions of PIM-SMv6 are not configured or fail to be configured.

20.4.3 Configuring BSR Parameters

Configuration Effect

- Restrict the range of BSMs.

Notes

- The basic functions of PIM-SMv6 must be configured.
- A C-RP and a C-BSR must be configured.
- The border must be configured on the interface between domains.

Configuration Steps

↘ Configuring the Border

- The border must be configured if there are multiple domains.
- Configure the border the interface between two domains.

↘ Configuring a PIM Router to Restrict BSMs

- Optional.
- This configuration can be performed on a PIM router unless otherwise specified.

↘ Configuring a C-BSR to Restrict the C-PR Range

- Optional.
- This configuration can be performed on all C-BSRs unless otherwise specified.

↘ Configuring a C-BSR to Receive C-RP-ADV Packets with prefix-count of 0

- Optional.
- This configuration can be performed on all C-BSRs unless otherwise specified.

Verification

↘ Verifying the Border

Enable the basic functions of PIM-SMv6, set two routers in different domains, and set Router B as a C-BSR. Router A can normally receive BSMs.

Set the common border between Router A and Router B as a border interface. Router A cannot receive BSMs.

↘ Verifying a PIM Router to Restrict BSMs

Enable the basic functions of PIM-SMv6 and set Router B as a C-BSR. Router A can normally receive BSMs. Restrict the C-BSR range on Router A. Router A cannot receive BSMs.

↘ Verifying a C-BSR to Restrict the C-PR Range

Enable the basic functions of PIM-SMv6, set Router B as a C-BSR, set Router A as a C-RP, and restrict the C-RP range on the C-BSR. Router B cannot receive packets from the C-RP.

Related Commands

↘ Configuring the BSR Border

Command	ipv6 pim bsr-border
Parameter	N/A
Description	
Command Mode	Interface configuration mode
Usage Guide	The BSR border can be configured on an interface to restrict flooding of BSMs. When this interface receives BSMs, it immediately discards them and BSMs are not forwarded by this interface.

↘ Configuring a PIM Router to Restrict BSMs

Command	ipv6 pim accept-bsr list <i>ipv6_access-list</i>
Parameter Description	list <i>ipv6_access-list</i> : References an IPv6 ACL to restrict the BSR address range. A named ACL is supported.
Command Mode	Global configuration mode
Usage Guide	N/A

↘ Configuring a C-BSR to Restrict the C-PR Range

Command	ipv6 pim accept-crp list <i>ipv6_access-list</i>
Parameter Description	list <i>ipv6_access-list</i> : References an IPv6 ACL to restrict the address range of the C-RP and the group address range served by the C-RP. A named ACL is supported.
Command Mode	Global configuration mode
Usage Guide	Configure this command on a C-BSR. When this C-BSR is elected as the BSR, it can restrict the address range of the valid C-RP and the multicast group range served by the C-RP.

↘ Displaying BSMs

Command	show ipv6 pim sparse-mode bsr-router
Parameter Description	N/A
Command Mode	Privileged EXEC mode, global configuration mode, and interface configuration mode
Usage Guide	N/A

↘ Displaying All RPs Configured on the Local Device and the Multicast Groups Served by the RPs

Command	show ipv6 pim sparse-mode rp mapping
Parameter	N/A
Description	
Command Mode	Privileged EXEC mode, global configuration mode, and interface configuration mode
Usage Guide	N/A

Configuration Example

Configuring the BSR Border

Configuration Steps	<ul style="list-style-type: none"> Configure basic functions of PIM-SMv6. (Omitted) Configure the BSR border on the juncture interface between Router B and Router A.
	<pre>FS(config-if-GigabitEthernet 0/2)#ipv6 pim bsr-border</pre>
Verification	<p>Before the BSR border is configured, the BSM information of Router A is displayed as follows:</p> <pre>switch#show ipv6 pim sparse-mode bsr-router PIMv2 Bootstrap information BSR address: 5000::5 Uptime: 00:05:42, BSR Priority: 64, Hash mask length: 126 Expires: 00:01:28 Role: Non-candidate BSR Priority: 0, Hash mask length: 126 State: Accept Preferred Candidate RP: 3000::5(Loopback 0) Advertisement interval 60 seconds Next Cand_RP_advertisement in 00:00:24 switch#</pre>
	<p> Candidate RP: Indicates all C-RPs configured on the local router, excluding other routers.</p>
	<p>After the BSR border is configured, the BSM information of Router A is displayed as follows:</p> <pre>switch#show ipv6 pim sparse-mode bsr-router Candidate RP: 3000::5(Loopback 0) Advertisement interval 60 seconds Next Cand_RP_advertisement in 00:00:53</pre>

Configuring a PIM Router to Restrict the Source Address Range of BSMs to (8000::5/64)

Configuration Steps	<ul style="list-style-type: none"> ● Configure basic functions of PIM-SMv6. (Omitted) ● Configure PIM Router A to restrict BSMs. The restricted source address range is (8000::5/64).
	<pre>switch(config)#ipv6 access-list acl switch(config-ipv6-acl)#permit ipv6 8000::5/64 any switch(config-ipv6-acl)#exit switch(config)#ipv6 pim accept-crp list acl</pre>
Verification	<p>Before the BSM restriction is configured, the BSM information of Router A is displayed as follows:</p>
	<pre>switch#show ipv6 pim sparse-mode bsr-router PIMv2 Bootstrap information BSR address: 5000::5 Uptime: 00:05:42, BSR Priority: 64, Hash mask length: 126 Expires: 00:01:28 Role: Non-candidate BSR Priority: 0, Hash mask length: 126 State: Accept Preferred Candidate RP: 3000::5(Loopback 0) Advertisement interval 60 seconds Next Cand_RP_advertisement in 00:00:24 switch#</pre>
	<p>After the BSM restriction is configured, the BSM information of Router A is displayed as follows:</p>
	<pre>switch#show ipv6 pim sparse-mode bsr-router Candidate RP: 3000::5(Loopback 0) Advertisement interval 60 seconds Next Cand_RP_advertisement in 00:00:34</pre>

📌 **Configuring a C-BSR to Restrict the Source Address Range of C-PR Packets to (9000::5/64)**

Configuration Steps	<ul style="list-style-type: none"> ● Configure basic functions of PIM-SMv6. (Omitted) ● Configure Router B to restrict C-RP packets. The restricted source address range is (9000::5/64).
	<pre>FS(config)#ipv6 access-list acl FS(config-ipv6-acl)#permit ipv6 9000::5/64 any FS(config-ipv6-acl)#exit FS(config)#ipv6 pim accept-crp list acl</pre>

Verification	Before C-RP packet filtering is configured, information about all RP groups on Router B is displayed as follows:
	<pre> FS#show ipv6 pim sparse-mode rp mapping PIM Group-to-RP Mappings This system is the Bootstrap Router (v2) Group(s): ff00::/8 RP: 3000::5(Not self) Info source: 3000::5, via bootstrap, priority 192 Uptime: 00:02:26, expires: 00:02:08 FS# </pre>
	After C-RP packet filtering is configured, information about all RP groups on Router B is displayed as follows:
	<pre> FS#show ipv6 pim sparse-mode rp mapping PIM Group-to-RP Mappings This system is the Bootstrap Router (v2) </pre>

➤ **Configuring the Static RP First**

Configuration Steps	<ul style="list-style-type: none"> ● Configure basic functions of PIM-SMv6. (Omitted) ● Set the address of Interface Loopback0 of Router A to 3000::5. (Omitted) ● Set the address of Interface Loopback1 of Router A to 4000::5. (Omitted) ● Set the static address of Router A to 3300::5. (Omitted) ● Set the static address of Router B to 3300::5. ● Configure the static RP first on Router A.
	<pre> switch(config)#ipv6 pim rp-address 3300::5 switch(config)#ipv6 pim static-rp-preferred </pre>
Verification	Before static RP first is configured, display information about the RP corresponding to FF16::1.
	<pre> switch#show ipv6 pim sparse-mode rp ff16::1 RP: 4000::5 Info source: 5000::5, via bootstrap PIMv2 Hash Value 126 RP 4000::5, via bootstrap, priority 56, hash value 892666309 RP 3000::5, via bootstrap, priority 200, hash value 1161101765 RP 3300::5, static (hash value 204800453 not used) </pre>
Verification	After static RP first is configured, display information about the RP corresponding to FF16::1.

```

switch(config)#show ipv6 pim sparse-mode rp ff16::1

RP: 3300::5 (Static)

PIMv2 STATIC RP PREFERRED

PIMv2 Hash Value 126

RP 4000::5, via bootstrap, priority 56, hash value 892666309

RP 3000::5, via bootstrap, priority 200, hash value 1161101765

RP 3300::5, static (hash value 204800453 not used)

switch(config)#

```

Common Errors

- The basic functions of PIM-SMv6 are not configured or fail to be configured.
- No C-BSR is configured.
- The BSR border is not configured on an interface between different domains.

20.4.4 Configuring RP and DR Parameters

Configuration Effect

- Configure the ignorance of the C-RP priority for the RP reselection.
- Configure the DR at the data source end to detect the RP reachability.
- Restrict the (S,G) multicast group address of the data source so that the ASM model provides the multicast service only for multicast packets within the allowable range.
- Configure the rate limit for the DR at the data source end to transmit Register packets.
- Configure the checksum length of Register packets.
- Configure the source address of Register packets.
- Configure the suppression time of Register packets.
- Configure the probing time of NULL packets.
- Configure the TTL of Register packets received by the RP from the (S,G) multicast group address.
- Configure the static RP first.

Notes

- The basic functions of PIM-SMv6 must be configured.

Configuration Steps

📌 Configuring the Ignorance of the C-RP Priority for the RP Reselection

- Optional.

- The ignorance of the C-RP priority can be enabled on each router unless otherwise specified.
- ▼ **Configuring the DR at the Data Source End to Detect the RP Reachability**
 - Optional.
 - The reachability detection can be enabled on the DR that is directly connected to the data source unless otherwise specified.
- ▼ **Restricting the (S,G) Address Range of Register Packets at the Data Source End**
 - Optional.
 - The (S,G) address range of Register packets at the data source end can be restricted on all routers that function as C-RPs or static RPs unless otherwise specified.
- ▼ **Restricting the Rate for the DR at the Data Source End to Transmit Register Packets**
 - Optional.
 - The transmission rate limit of Register packets can be enabled on the DR that is directly connected to the data source unless otherwise specified.
- ▼ **Configuring the Checksum Length of Register Packets**
 - Optional.
 - The checksum length of Register packets can be configured on all C-RPs or static RPs unless otherwise specified.
- ▼ **Configuring the Source Address of Register Packets**
 - Optional.
 - The source address of Register packets can be configured on the DR that is directly connected to the data source unless otherwise specified.
- ▼ **Configuring the Suppression Time of Register Packets**
 - Optional.
 - The suppression time of Register packets can be configured on the DR that is directly connected to the data source unless otherwise specified.
- ▼ **Configuring the Probing Time of NULL Packets**
 - Optional.
 - The probing time of NULL packets can be configured on the DR that is directly connected to the data source unless otherwise specified.
- ▼ **Configuring the TTL of Register Packets Received by the RP from the (S,G) Multicast Group Address**
 - Optional.
 - The TTL of Register packets from the (S,G) multicast group address can be configured on all routers that function as C-RPs or static RPs unless otherwise specified.
- ▼ **Configuring the Static RP First**
 - Optional.

- The static RP first can be configured on all routers unless otherwise specified.

Verification

↘ Verifying the Ignorance of the C-RP Priority

Set the address to 3000::5 and priority to 200 for Interface Loopback0 on Router A. Set the address to 4000: : 5 and priority to 56 for Interface Loopback1 on Router A. Set the C-BSR address to 5000: : 5 on Router B.

- Run the **show ipv6 pim sparse-mode rp ff16::2** command to display information about the RP that serves the current group.

↘ Verifying the DR at the Data Source End to Detect the RP Reachability

Set the address to 3000::5 and priority to 200 for Interface Loopback0 on Router A. Set the address to 4000: : 5 and priority to 56 for Interface Loopback1 on Router A. Set the C-BSR address to 5000: : 5 on Router B. Configure the RP reachability detection on Router B.

- Run the **show running-config** command to check whether the RP reachability detection is configured.

↘ Verifying the Restriction of the (S,G) Address Range of Register Packets at the Data Source End

Set the address to 3000::5 and priority to 200 for Interface Loopback0 on Router A. Set the address to 4000: : 5 and priority to 56 for Interface Loopback1 on Router A. Set the C-BSR address to 5000: : 5 on Router B. The address of the multicast group is FF16::2. Set Router A to receive packets only from the multicast source with the source address of (1300::1/64).

- Run the **show ip pim sparse-mode mroute** command to display the (S,G) entries.

↘ Verifying the Rate Limit for the DR at the Data Source End to Transmit Register Packets

- Set the rate of transmitting Register packets for Router B and then run the **show ip pim sparse-mode track** command to check the number of transmitted Register packets for confirmation.

↘ Verifying the Checksum Length of Register Packets

- Set Router A to check a Register packet based on the entire packet rather than based only on the packet header and Register packet header. Run the **show running-config** command to check the configuration.

↘ Verifying the Source Address of Register Packets

- Configure the source address of Register packets on Router B and run the **show running-config** command to check the configuration on Router A.

↘ Verifying the Suppression Time and Probing Time of Register Packets

- Configure the suppression time and probing time of Register packets on Router B and run the **show running-config** command to check the configuration.

↘ Verifying the TTL of Register Packets Received by the RP from the (S,G) Multicast Group Address

- Configure the TTL of Register packets from the (S,G) multicast group address on Router A and run the **show ip pim sparse-mode mroute** command to display the maximum (S,G) TTL.

↘ Verifying the Static RP First

- Configure a static RP and a C-RP on Router A, configure the static RP first, and then run the **show ipv6 pim sparse-mode rp ff16::2** command to display information about the current RP.

Related Commands

↳ Ignoring the C-RP Priority

Command	ipv6 pim ignore-rp-set-priority
Parameter	N/A
Description	
Command Mode	Global configuration mode
Usage Guide	N/A

↳ Displaying Information About the RP That Serves a Group

Command	show ipv6 pim sparse-mode rp-hash <i>group-address</i>
Parameter	<i>group-address</i> : Indicates the parsed group address.
Description	
Command Mode	Privileged EXEC mode, global configuration mode, and interface configuration mode
Usage Guide	N/A

↳ Configuring the DR Directly Connected to the Data Source to Detect RP Reachability

Command	ipv6 pim register-rp-reachability
Parameter	N/A
Description	
Command Mode	Global configuration mode
Usage Guide	After this command is configured, the RP reachability is detected before Register packets are transmitted. If the RP is reachable, Register packets are transmitted. If the RP is unreachable, Register packets are not transmitted.

↳ Restricting the (S,G) Address Range of Register Packets at the Data Source End

Command	ipv6 pim accept-register { list <i>ipv6_access-list</i> [route-map <i>map-name</i>] route-map <i>map-name</i> [list <i>ipv6_access-list</i>] }
Parameter	list <i>ipv6_access-list</i> : References an IP extended ACL to restrict the (S,G) address range. The value range is 100-199, 2000-2699, and Word. route-map <i>map-name</i> : Uses a route map to restrict the (S,G) address range.
Description	
Command Mode	Global configuration mode
Usage Guide	After this command is configured, when receiving a Register packet from an unauthorized source, the RP immediately returns the Register-Stop packet.

↳ Displaying Multicast Routing Entries

Command	show ipv6 pim sparse-mode mroute [<i>group-or-source-address</i> [<i>group-or-source-address</i>]]
Parameter	<i>group-or-source-address</i> : Indicates the group address or source address. The two addresses cannot be group addresses or source addresses at the same time.
Description	
Command Mode	Privileged EXEC mode, global configuration mode, and interface configuration mode

Mode	
Usage Guide	A group address, a source address, or both addresses can be specified each time. You can also not specify a specific group address or source address but you cannot specify two group addresses or two source addresses at the same time.

✚ Configuring the Rate Limit for the DR to Transmit Register Packets

Command	ipv6 pim register-rate-limit <i>rate</i>
Parameter Description	<i>Rate</i> : Indicates the number of Register packets that are allowed to be transmitted per second. The value ranges from 1 to 65,535.
Command Mode	Global configuration mode
Usage Guide	This command is used to configure the transmission rate of Register packets from the (S,G) multicast group address rather than the Register packets of the entire system. After this command is configured, the load of the source DR and RP will be relieved and Register packets whose rate does not exceed the limit will be transmitted.

✚ Displaying the Statistics on PIM Packets

Command	show ipv6 pim sparse-mode track
Parameter Description	N/A
Command Mode	Privileged EXEC mode, global configuration mode, and interface configuration mode
Usage Guide	When the system is started, the statistics start time point is first set. Each time clear ip pim sparse-mode track is called, the statistics start time point is set again and the PIM packet counter is cleared.

✚ Configuring the Checksum Calculation of a Register Packet Based on the Entire Packet

Command	ipv6 pim register-checksum-wholepkt [group-list <i>ipv6_access-list</i>]
Parameter Description	group-list <i>access-list</i> : Uses an ACL to restrict the group addresses that use this configuration. <i>access-list</i> : Supports digits <1,99> and <1300,1999>. A named ACL is supported.
Command Mode	Global configuration mode
Usage Guide	The device calculates the checksum of a Register packet based on the entire PIM protocol packet including the encapsulated multicast data packet, rather than the PIM header of the Register packet. If group-list <i>ipv6_access-list</i> is not carried in this command, all group addresses apply this configuration.

✚ Configuring the Source Address of Register Packets

Command	ipv6 pim register-source { <i>ipv6_local_address</i> <i>interface-type interface-number</i> }
Parameter Description	<i>local_address</i> : Specifies an IPv6 address as the source address of Register packets. <i>interface-type interface-number</i> : Specifies the IPv6 address of an interface as the source address of Register packets.
Command Mode	Global configuration mode
Usage Guide	The configured address must be reachable. When the RP receives a Register packet, it transmits the Register-Stop packet with the source IPv6 address of the Register packet as the destination address. PIM-SMv6 does not need to be enabled on associated interfaces.

↘ Configuring the Suppression Time of Register Packets

Command	ipv6 pim register-suppression <i>seconds</i>
Parameter Description	<i>Seconds</i> : Indicates the suppression time of Register packets. The unit is seconds. The value ranges from 1 to 65,535 and the default value is 60 .
Command Mode	Global configuration mode
Usage Guide	Configuring this value on the DR will change the suppression time of Register packets defined on the DR. If the ipv6 pim rp-register-kat command is not configured, configuring this value on the RP will change the keepalive time of the RP.

↘ Configuring the Probing Time of Register Packets

Command	ipv6 pim probe-interval <i>seconds</i>
Parameter Description	<i>Seconds</i> : Indicates the probing time of Register packets. The unit is seconds. The value ranges from 1 to 65,535 and the default value is 5 .
Command Mode	Global configuration mode
Usage Guide	Probing time of Register packets is the interval for the source DR to transmit the NULL-Register packet to the RP prior to the timeout of the suppression time of Register packets. The probing time of Register packets cannot be larger than half of the suppression time of Register packets. Otherwise, the configuration fails and a warning is displayed. In addition, the suppression time of Register packets multiplied by three plus the probing time of Register packets cannot be larger than 65,535. Otherwise, a warning will be displayed.

↘ Configuring the KAT Interval on the RP

Command	ipv6 pim rp-register-kat <i>seconds</i>
Parameter Description	<i>Seconds</i> : Indicates the time of the KAT timer. The unit is seconds. The value ranges from 1 to 65,535 and the default value is 210 .
Command Mode	Global configuration mode
Usage Guide	N/A

↘ Configuring the Static RP First

Command	ipv6 pim static-rp-preferred
Parameter Description	N/A
Command Mode	Global configuration mode
Usage Guide	After this command is configured, the priority of the static RP is higher than that of the RP elected by using the BSR mechanism.

Configuration Example

↘ Configuring Whether the C-RP Priority Is Considered for the Group-to-RP Mapping

<p>Configuration Steps</p>	<ul style="list-style-type: none"> ● Configure basic functions of PIM-SMv6. (Omitted) ● Set the address to 3000::5 and priority to 200 for Interface Loopback0 on Router A. (Omitted) ● Set the address to 4000: : 5 and priority to 56 for Interface Loopback1 on Router A. (Omitted) ● Set the C-BSR address to 5000: : 5 on Router B. (Omitted) ● Display the group corresponding to FF16::1. ● Configure the ignorance of C-RP priority on Router B.
	<pre>switch#configure terminal FS(config)# ipv6 pim ignore-rp-set-priority</pre>
<p>Verification</p>	<p>Before the ignorance of the C-RP priority is configured, the following information is displayed:</p>
	<pre>switch(config)#show ipv6 pim sparse-mode rp FF16::1 RP: 4000::5 Info source: 5000::5, via bootstrap PIMv2 Hash Value 126 RP 4000::5, via bootstrap, priority 56, hash value 892666309 RP 3000::5, via bootstrap, priority 200, hash value 1161101765</pre>
	<p>After the ignorance of the C-RP priority is configured, the following information is displayed:</p>
	<pre>switch(config)#show ipv6 pim sparse-mode rp FF16::1 RP: 3000::5 Info source: 5000::5, via bootstrap</pre>

📌 **Configuring the Reachability Detection of the RP Directly Connected to the Data Source**

<p>Configuration Steps</p>	<ul style="list-style-type: none"> ● Configure basic functions of PIM-SMv6. (Omitted) ● Configure the reachability detection of the RP directly connected to the data source.
	<pre>FS(config)#ipv6 pim register-rp-reachability</pre>
<p>Verification</p>	<p>Run the show running-config command to check the configuration. The following information is displayed:</p>
	<pre>FS(config)#show running-config ! ! ! ipv6 pim register-rp-reachability ipv6 pim bsr-candidate Loopback 0 ! !</pre>

➤ **Restricting the (S,G) Address Range of Register Packets at the Data Source End**

<p>Configuration Steps</p>	<ul style="list-style-type: none"> ● Configure basic functions of PIM-SMv6. (Omitted) ● Set Router A to filter packets by source address and receive packets only from the source address (1300::1/64).
	<pre>switch(config)#ipv6 pim accept-register list acl % access-list 101 not exist switch(config)#ipv6 access-list acl switch(config-ipv6-acl)#permit ipv6 1300::1/64 any switch(config-ipv6-acl)#exit</pre>
<p>Verification</p>	<p>Before the (S,G) address range of Register packets at the data source end is restricted, run the show ipv6 pim sparse-mode mroute command to display multicast entries. The (S,G) entry and (S,G,RPT) entry exist.</p>
	<pre>switch#show ipv6 pim sparse-mode mroute IPv6 Multicast Routing Table (*,*,RP) Entries: 0 (*,G) Entries: 1 (S,G) Entries: 1 (S,G,rpt) Entries: 1 FCR Entries: 0 REG Entries: 0 (*, ff16::1) RP: 4000::5 RPF nbr: :: RPF idx: None Upstream State: JOINED 00 01 02 03 04 05 06 07 08 09 10 11 12 13 14 15 16 17 18 19 20 21 22 23 24 25 26 27 28 29 30 31 Local 0 . . . i 1 Joined 0 1 Asserted 0</pre>

```

1 . . . . .
FCR:

(1100::2, ff16::1)
RPF nbr: fe80::21a:a9ff:fe3a:6355
RPF idx: GigabitEthernet 0/2
SPT bit: 1
Upstream State: JOINED
jt_timer expires in 36 seconds
kat expires in 191 seconds
    00 01 02 03 04 05 06 07 08 09 10 11 12 13 14 15 16 17 18 19 20 21 22 23 24 25 26 27 28 29 30 31
Local
    
```

After the (S,G) address range of Register packets at the data source end is restricted, run the **show ipv6 pim sparse-mode mroute** command to display multicast entries. The (S,G) entry and (S,G,RPT) entry exist.

```

switch#show ipv6 pim sparse-mode mroute

IPv6 Multicast Routing Table

(*,*,RP) Entries: 0
(*,G) Entries: 1
(S,G) Entries: 0
(S,G,rpt) Entries: 1
FCR Entries: 0
REG Entries: 0

(*, ff16::1)
RP: 4000::5
RPF nbr: ::
RPF idx: None
Upstream State: JOINED
    00 01 02 03 04 05 06 07 08 09 10 11 12 13 14 15 16 17 18 19 20 21 22 23 24 25 26 27 28 29 30 31
Local

0 . . . . i . . . . .
1 . . . . .
    
```



```

Joined
0 . . . . .
1 . . . . .
Asserted
0 . . . . .
1 . . . . .
FCR:

(1100::2, ff16::1, rpt)
RP: 4000::5
RPF nbr: ::
RPF idx: None
Upstream State: PRUNED

    00 01 02 03 04 05 06 07 08 09 10 11 12 13 14 15 16 17 18 19 20 21 22 23 24 25 26 27 28 29 30 31

Local
0 . . . . .
    
```

➤ **Restricting the Rate for the DR at the Data Source End to Transmit Register Packets**

<p>Configuration Steps</p>	<ul style="list-style-type: none"> ● Configure basic functions of PIM-SMv6. (Omitted) ● Check the number of PIM packets transmitted by Router B. ● Check the number of PIM packets transmitted by Router B one second later. ● Set the rate for Router B to transmit Register packets. ● Check the number of PIM packets transmitted by Router B one second later.
	<pre>FS(config)#ipv6 pim register-rate-limit 1</pre>
<p>Verification</p>	<p>Before the rate limit is configured, check the number of PIM packets transmitted by the DR. The following information is displayed:</p>
	<pre> FS#show ipv6 pim sparse-mode track PIMv6 packet counters track Elapsed time since counters cleared: 17:14:54 received sent Valid PIMv6 packets: 5064 7727 Hello: 1329 4057 Join-Prune: 863 0 </pre>

Register:	0	2636
Register-Stop:	975	0
Assert:	0	0
BSM:	0	1034
C-RP-ADV:	1897	0
PIMDM-Graft:	0	
PIMDM-Graft-Ack:	0	
PIMDM-State-Refresh:	0	
Unknown PIM Type:	0	
Errors:		
Malformed packets:		0
Bad checksums:		0
Send errors:		5
Packets received with unknown PIM version: 0		

Before the rate limit is configured, check the number of PIM packets transmitted by the DR one second later. The following information is displayed:

```
FS#show ipv6 pim sparse-mode track
PIMv6 packet counters track
Elapsed time since counters cleared: 17:14:55
```

	received	sent
Valid PIMv6 packets:	5064	7727
Hello:	1335	4063
Join-Prune:	866	0
Register:	0	2639
Register-Stop:	978	0
Assert:	0	0
BSM:	0	1035
C-RP-ADV:	1897	0
PIMDM-Graft:	0	
PIMDM-Graft-Ack:	0	
PIMDM-State-Refresh:	0	
Unknown PIM Type:	0	

<pre> Errors: Malformed packets: 0 Bad checksums: 0 Send errors: 5 Packets received with unknown PIM version: 0 </pre>
<p>After the rate limit is configured, check the number of PIM packets transmitted by the DR. The following information is displayed:</p>
<pre> FS#show ipv6 pim sparse-mode track PIMv6 packet counters track Elapsed time since counters cleared: 17:14:56 received sent Valid PIMv6 packets: 5064 7727 Hello: 1341 4069 Join-Prune: 869 0 Register: 0 2640 Register-Stop: 979 0 Assert: 0 0 BSM: 0 1036 C-RP-ADV: 1897 0 PIMDM-Graft: 0 PIMDM-Graft-Ack: 0 PIMDM-State-Refresh: 0 Unknown PIM Type: 0 Errors: Malformed packets: 0 Bad checksums: 0 Send errors: 5 Packets received with unknown PIM version: 0 </pre>

↘ Configuring the Checksum Length of Register Packets

Configuration Steps	<ul style="list-style-type: none"> ● Configure basic functions of PIM-SMv6. (Omitted) ● Configure the checksum calculation of a Register packet based on the entire packet on Router A.
----------------------------	---

	<ul style="list-style-type: none"> ● Run the show running-config command to check the configuration.
	<pre>switch(config)#ipv6 pim register-checksum-wholepkt switch(config)#show running-config</pre>
Verification	Check the configuration on Router A. The configuration is displayed as follows:
	<pre>! ! ipv6 pim register-checksum-wholepkt ipv6 pim rp-candidate Loopback 0 priority 200 ipv6 pim rp-candidate Loopback 1 priority 56 ipv6 pim ssm default ! !</pre>

📌 **Configuring the Source Address of Register Packets**

Configuration Steps	<ul style="list-style-type: none"> ● Configure basic functions of PIM-SMv6. (Omitted) ● Set the source address of Interface Loopback1 to 5500::5/64 on Router B. (Omitted) ● Set the source address of Register packets to the address of Interface Loopback2 on Router B. (Omitted) ● Run the show running-config command to check the configuration.
	<pre>FS(config)#ipv6 pim register-source Loopback 1</pre>
Verification	Check the configuration on Router B.
	<pre>! ! ipv6 pim register-source Loopback 1 ipv6 pim register-rate-limit 1 ipv6 pim bsr-candidate Loopback 0 ! !</pre>

📌 **Configuring the Suppression Time and Probing Time of Register Packets**

Configuration Steps	<ul style="list-style-type: none"> ● Configure basic functions of PIM-SMv6. (Omitted) ● Set the suppression time to 20 seconds on Router B. ● Set the probing time to 2 seconds on Router B. ● Run the show running-config command to check the configuration.
	<pre>FS(config)#ipv6 pim register-suppression 20 FS(config)#ipv6 pim probe-interval 2</pre>

	FS(config)# show ip pim sparse-mode track
Verification	Check the configuration on Router B.
	<pre>! ipv6 pim register-source Loopback 1 ipv6 pim register-rate-limit 1 ipv6 pim register-suppression 20 ipv6 pim probe-interval 2 ipv6 pim bsr-candidate Loopback 0 ! !</pre>

📌 Configuring the TTL of Register Packets Received by the RP from the (S,G) Multicast Group Address

Configuration Steps	<ul style="list-style-type: none"> ● Configure basic functions of PIM-SMv6. (Omitted) ● Set the TTL of Register packets received by Router A from the (S,G) multicast group address to 60 seconds. ● Run the show ip pim sparse-mode mroute command to check the number of Register packets.
	FS(config)#ip pim rp-register-kat 60
Verification	After the TTL is configured, check the TTL of Register packets from the (S,G) multicast group address on Router A. The TTL is not larger than 60 seconds.
	<pre>switch(config)#show ipv6 pim sparse-mode mroute IPv6 Multicast Routing Table (*,*,RP) Entries: 0 (*,G) Entries: 0 (S,G) Entries: 1 (S,G,rpt) Entries: 1 FCR Entries: 0 REG Entries: 0 (1100::2, ff16::1) RPF nbr: fe80::21a:a9ff:fe3a:6355 RPF idx: GigabitEthernet 0/2 SPT bit: 0 Upstream State: NOT JOINED kat expires in 60 seconds 00 01 02 03 04 05 06 07 08 09 10 11 12 13 14 15 16 17 18 19 20 21 22 23 24 25 26 27 28 29 30 31</pre>

	Local
	0
	1
	Joined
	0
	1
	Asserted
	0
	1
	Outgoing
	0
	1
	 (1100::2, ff16::1, rpt)
	RP: 4000::5
	RPF nbr: ::
	RPF idx: None

Common Errors

- The basic functions of PIM-SMv6 are not configured or fail to be configured.
- The (S,G) address range of Register packets at the data source end is not restricted or fails to be configured on a C-RP or static RP.
- When the (S,G) address range of Register packets at the data source end is restricted, the referenced ACL is not configured or the source/group address range allowed by the ACL is configured incorrectly.
- The source/group address ranges allowed by C-RPs or static RPs are inconsistent.

20.4.5 Configuring the Transmission Interval of Join/Prune Packets

Configuration Effect

- Change the transmission interval of Join/Prune packets to form an RPT or SPT.

Notes

- The basic functions of PIM-SMv6 must be configured.

Configuration Steps

- Configure the transmission interval of Join/Prune packets.

Verification

Set the transmission interval of Join/Prune packets to 120 seconds on Router B. Run the **show ipv6 pim sparse-mode mroute** command to check the entry TTL.

Related Commands

▾ **Configuring the Transmission Interval of Join/Prune Packets**

Command	ipv6 pim jp-timer <i>seconds</i>
Parameter	<i>Seconds</i> : Indicates the transmission interval of Join/Prune packets.
Description	The unit is seconds. The value ranges from 1 to 65,535 and the default value is 60 .
Command Mode	Global configuration mode
Usage Guide	N/A

Configuration Example

▾ **Configuring the Transmission Interval of Join/Prune Packets on a Router**

Configuration Steps	<ul style="list-style-type: none"> ● Configure basic functions of PIM-SMv6. (Omitted) ● Configure the transmission interval of Join/Prune packets on a router.
	<pre>FS(config)#ip pim jp-timer 120</pre>
Verification	Run the show ipv6 pim sparse-mode mroute command to check the entry. The transmission time of Join/Prune packets is not larger than 120.
	<pre>switch(config)#show ipv6 pim sparse-mode mroute IPv6 Multicast Routing Table (*,*,RP) Entries: 0 (*,G) Entries: 1 (S,G) Entries: 1 (S,G,rpt) Entries: 1 FCR Entries: 0 REG Entries: 0 (*, ff16::1) RP: 4000::5 RPF nbr: :: RPF idx: None Upstream State: JOINED 00 01 02 03 04 05 06 07 08 09 10 11 12 13 14 15 16 17 18 19 20 21 22 23 24 25 26 27 28 29 30 31 Local</pre>

```

0 . . . . i . . . . .
1 . . . . .
Joined
0 . . . . .
1 . . . . .
Asserted
0 . . . . .
1 . . . . .
FCR:

(1100::2, ff16::1)
RPF nbr: fe80::21a:a9ff:fe3a:6355
RPF idx: GigabitEthernet 0/2
SPT bit: 1
Upstream State: JOINED
jt_timer expires in 116 seconds
kat expires in 59 seconds

 00 01 02 03 04 05 06 07 08 09 10 11 12 13 14 15 16 17 18 19 20 21 22 23 24 25 26 27 28 29 30 31
Local
0 . . . . .
    
```

Common Errors

- The basic functions of PIM-SMv6 are not configured or fail to be configured.

20.4.6 Configuring the Last-Hop Device to Switch from the RPT to the SPT

Configuration Effect

- Switch the last-hop device from the RPT to the SPT.

Notes

- The basic functions of PIM-SMv6 must be configured.

Configuration Steps

- Configure the last-hop device to switch from the RPT to the SPT.

Verification

Configure basic functions of PIM-SMv6, make the DR at the data source end transmit data streams to Group FF16::1, and make the receiver forcibly join the Group FF16::1 to form a RPT. The DR at the receive end forcibly performs the switching from the RPT to SPT. Check the configuration on the RP.

Related Commands

▾ **Enabling the SPT Switching Function**

Command	ipv6 pim spt-threshold [group-list ipv6_access-list]
Parameter	group-list <i>ipv6_access-list</i> : References an IPv6 ACL to restrict the group address range that allows SPT switching.
Description	<i>ipv6_access-list</i> : A named ACL is supported.
Command Mode	Global configuration mode
Usage Guide	If group-list <i>ipv6_access-list</i> parameter is not carried in this command, all multicast groups are allowed to conduct SPT switching. If no is set in this command, group-list is carried, and the carried ACL is a configured ACL, the restriction of the ACL associated with group-list is cancelled and all groups are allowed to switch from the RPT to the SPT.

Configuration Example

▾ **Configuring the Last-Hop Device to Switch from the RPT to the SPT**

Configuration Steps	<ul style="list-style-type: none"> ● Configure basic functions of PIM-SMv6. (Omitted) ● Make the DR at the data source end transmit code streams to Group FF16::1. ● Make the DR at the receive end receive code streams from Group FF16::1. ● Configure the last-hop device to switch from the RPT to the SPT on the DR at the receive end.
	<pre>switch(config)#ipv6 pim spt-threshold</pre>
Verification	Run the show running-config command to check the configuration.
	<pre>switch(config)#show running-config ! ! ip pim jp-timer 120 ip pim spt-threshold ip pim rp-candidate Loopback 0 ! !</pre>

20.5 Monitoring

Clearing

Running the **clear** commands may lose vital information and thus interrupt services.

Description	Command
-------------	---------

Clears information about the dynamic RP.	clear ipv6 pim sparse-mode bsr rp-set *
Sets the packet statistics start time again and clears the PIMv6 packet counter.	clear ipv6 pim sparse-mode track

Displaying

Description	Command
Displays details about the BSR.	show ipv6 pim sparse-mode bsr-router
Displays the PIM-SM information about an interface.	show ipv6 pim sparse-mode interface [<i>interface-type interface-number</i>] [detail]
Displays the local MLD information about a PIM-SMv6 interface.	show ipv6 pim sparse-mode local-members [<i>interface-type interface-number</i>]
Displays the PIM-SMv6 routing information.	show ipv6 pim sparse-mode mroute [<i>group-or-source-address</i> [<i>group-or-source-address</i>]]
Displays the PIM-SMv6 neighbor information.	show ipv6 pim sparse-mode neighbor [detail]
Displays next hop-relevant information, including the next-hop interface ID, address, and metric.	show ipv6 pim sparse-mode nexthop
Displays all RPs configured on the local device and the groups served by the RPs.	show ipv6 pim sparse-mode rp mapping
Displays information about the RP that serves the group address.	show ipv6 pim sparse-mode rp-hash <i>ipv6-group-address</i>
Displays the number of PIM packets transmitted and received from the statistics start time to the current time.	show ipv6 pim sparse-mode track

21 Configuring MSDP

21.1 Overview

Multicast Source Discovery Protocol is used to connect multiple rendezvous points (RPs) on the network and share the multicast source information among these RPs.

- Use MSDP among multiple Protocol Independent Multicast - Sparse-Mode (PIM-SM) domains to share the multicast source information of these PIM-SM domains to implement cross-domain multicast.
- Use MSDP in a PIM-SM domain to share the multicast source information of multiple RPs to implement anycast-RP.

Protocols and Standards

- RFC3618: Multicast Source Discovery Protocol(MSDP)

21.2 Applications

Application	Description
Cross-Domain Multicast	Connect multiple ASs, share the multicast resources among autonomous systems (ASs), and provide the multicast service across ASs.
Anycast-RP	Share the multicast source information among multiple RPs in a single AS.

21.2.1 Cross-Domain Multicast

Scenario

Connect multiple ASs, run PIM-SM within the ASs, and establish an MSDP peer relationship between RPs of different ASs.

As shown in Figure 8- 1, DR 1 connected to the multicast source registers with RP 1 in the local domain. DR 2 connected to the group member host triggers a join towards RP 2 in the local domain. RP 1 uses the SA message to notify RP 2 of the multicast source information. RP 2 continues to trigger a join towards the multicast source to build a multicast distribution tree (MDT).

Cross-domain multicast allows group member hosts to apply for the multicast streams across ASs.

Figure 8- 1

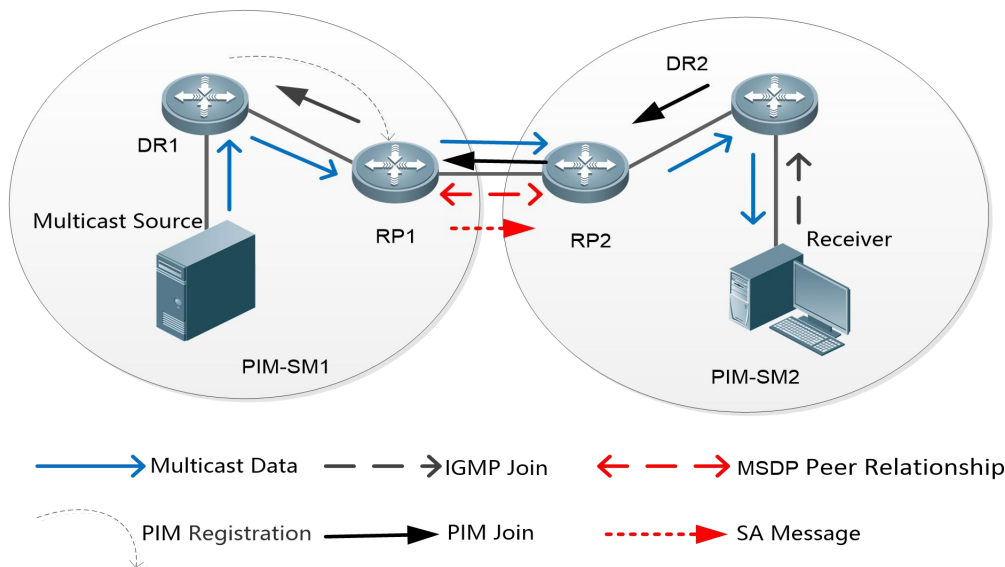

Deployment

- Run Open Shortest Path First (OSPF) within each AS, and run Border Gateway Protocol (BGP) between ASs to implement cross-domain unicast.
- Run PIM-SM within each AS, and run MSDP between ASs to implement cross-domain multicast.

21.2.2 Anycast-RP

Scenario

PIM-SM runs within each AS. Multiple RPs exist, use the same RP address, and serve the same group. An MSDP peer relationship is established between these RPs.

As shown in Figure 8- 2, DR 1 connected to the multicast source registers with the nearest RP 1 in the local domain. DR 2 connected to the group member host triggers a join towards the nearest RP 2. RP 1 uses the SA message to notify RP 2 of the multicast source information. RP 2 continues to trigger a join towards the multicast source to build an MDT.

Anycast-RP provides redundancy and load balancing for RPs, and helps accelerate convergence of multicast routes.

Figure 8- 2

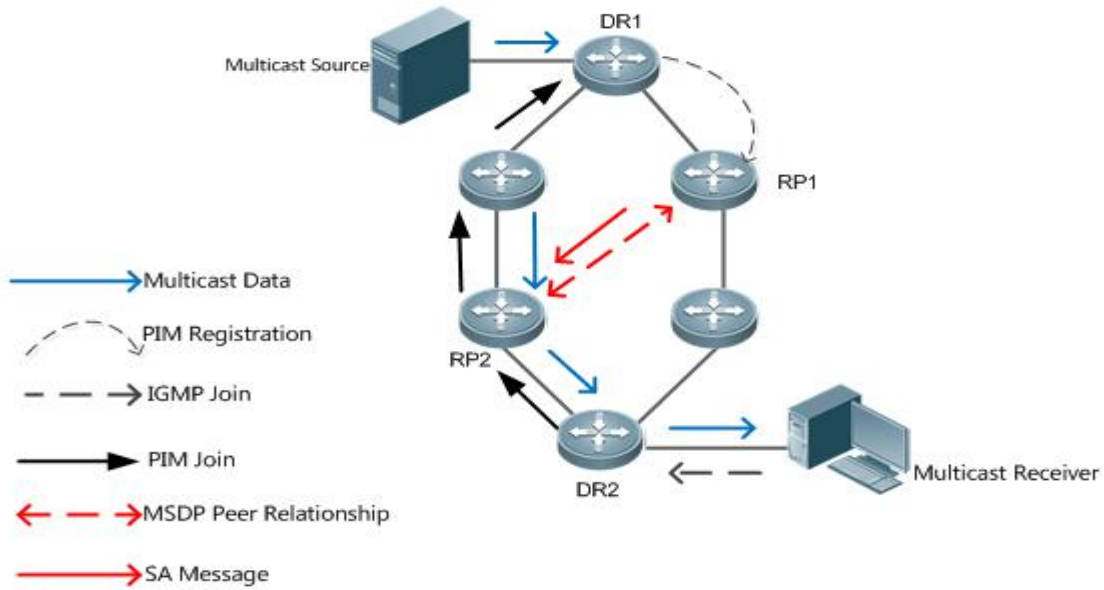

Deployment

- Run OSPF within each AS to implement intra-domain unicast.
- Run PIM-SM within each AS to implement intra-domain multicast.
- Run MSDP among RPs to share the multicast source information.

21.3Features

Function	Description
Establishing an MSDP Peer Relationship	Connect multiple RPs to share the multicast source information.
Receiving and Forwarding SA Messages	Prevent SA flooding and suppress SA storms.

21.3.1Establishing an MSDP Peer Relationship

Working Principle

Configure one or more pairs of MDSP peers on the network to connect RPs, thereby notifying other RPs of the multicast source information on an RP.

Use the TCP connection between MDSP peers through port 639. So far as the unicast route is reachable, the MSDP peer relationship can be established.

Figure 8-3

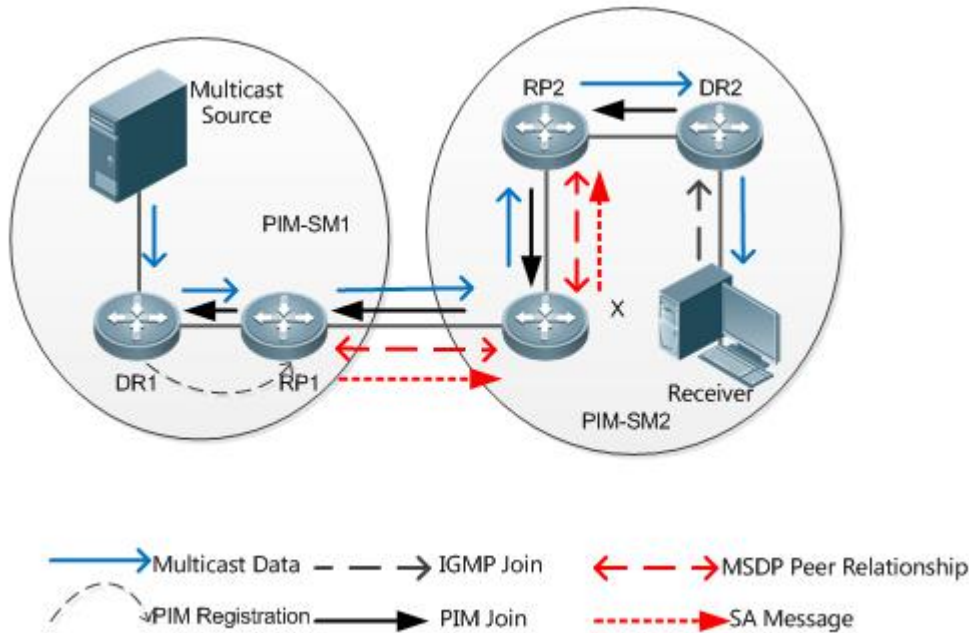

➤ **RP Connected to the Multicast Source**

Configure the MSDP peer on the RP connected to the multicast source. Then, this RP can use SA messages to send the local multicast source information to other RPs.

As shown in Figure 8-3, DR 1 registers the multicast source information with RP 1. As a peer relationship is established between RP 1 and RP 2, RP 1 sends the multicast source information to X.

➤ **SA Message Forwarder**

Non-RPs can also act as MSDP peers, but only forwards SA messages.

As shown in Figure 8-3, X forwards SA messages sent from RP 1 to RP 2. In this way, the multicast source information is transferred to RP 2.

➤ **RP Connected to the Multicast Receiver**

Configure the MSDP peer on the RP connected to the multicast receiver. Then, this RP can trigger a join towards the multicast source based on the received SA message.

As shown in Figure 8-3, DR 2 triggers a join towards RP 2. As RP 2 already obtains the multicast source information, RP 2 continues to trigger a join towards the multicast source, thus establishing an MDT from DR 1 to DR 2.

21.3.2 Receiving and Forwarding SA Messages

Working Principle

An SA message contains the multicast source address, multicast group address, and RP address. The RP address is the IP address of the RP with which the multicast source is registered.

- The RP encapsulates the locally registered multicast source information in an SA message, sends the message to all its MSDP peers.

- On receiving the SA message, each MSDP peer performs the Peer-RPF check, compares the SA-Cache, and matches the SA message against the SA incoming and outgoing filtering rules. If the SA message passes the Peer-RPF check, does not exist in the SA SA-Cache, and meets the outgoing filtering rules, this SA message is forwarded to other MSDP peers.

 The SA request and SA response messages are also used between MSDP peers to transfer source information of a specific group.

Peer-RPF Check

Any SA message coming from an MSDP peer (address: N) will be checked as follows:

-  Judge whether the SA message passes the Peer-RPF check in the following sequence. Once the SA message passes the Peer-RPF check, accept the SA message; otherwise, drop the SA message.
45. If N is a member of the mesh group, the SA message passes the Peer-RPF check; otherwise, go to step 2.
 46. If N is the only active MSDP peer on the local device, the SA message passes the Peer-RPF check; otherwise, go to step 3.
 47. If N is the RP address in the SA message, the SA message passes the Peer-RPF check; otherwise, go to step 4.
 48. If an EBGP route to the RP address in the SA message exists on the local device, and the next hop of this route is N, the SA message passes the Peer-RPF check; otherwise, go to step 5.
 49. If an optimum route to the RP address in the SA message exists on the local device, check as follows:
 - If this optimum route is a distance vector route (such as the BGP/RIP route), and this router is advertised by N, the SA message passes the Peer-RPF check.
 - If this optimum route is a link status route (such as the OSPF/IS-IS route), and the next hop of this router is N, the SA message passes the Peer-RPF check.
 - Otherwise, go to step 6.
 50. If an optimum route to the RP address in the SA message exists on the local device, and this route is a MBGP/BGP route, extract the nearest AS of the AS-Path of this MBGP/BGP route. If the local device has multiple MSDP peers in this AS and N is the MSDP peer with the largest IP address, or N is the only MSDP peer in this AS, the SA message passes the Peer-RPF check; otherwise, go to step 7.
 51. If N is the default MSDP peer, the SA message passes the Peer-RPF check; otherwise, go to step 8.
 52. The SA message fails in the Peer-RPF check.

The Peer-RPF check helps prevent loops and SA flooding.

Mesh Group

In a mesh group, an MSDP peer relationship is established on every two members.

- For SA messages coming from entities outside the mesh group, after passing the Peer-RPF check and SA-Cache comparison, these SA messages are forwarded to other members in the group.
- Intra-group SA messages are no longer forwarded to other members in the group.

The mesh group helps reduce the number of SA messages.

Figure 8-4

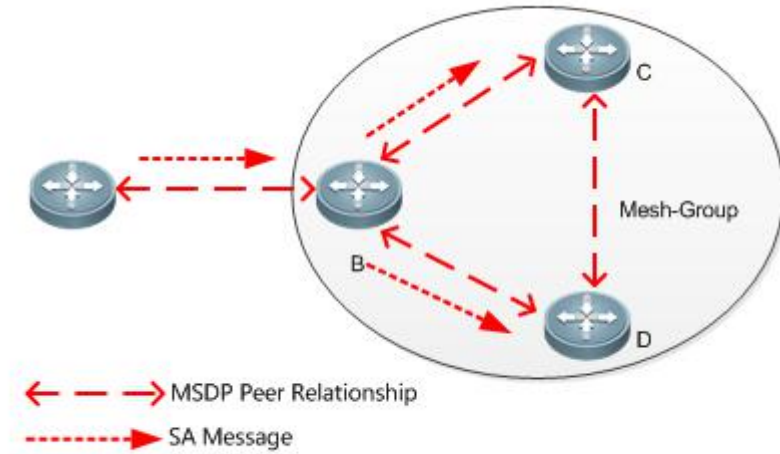

SA Cache

The SA cache is used to buffer the SA message status. Expired SA messages will be deleted.

When an MSDP peer receives an SA message, if this message does not exist in the SA cache and passes the Peer-RPF check, the message is stored in the SA cache. If this message already exists in the SA cache, the message is ignored. This helps suppress the SA storms.

When an MSDP peer receives an SA message, if this message already exists in the SA cache, the message is immediately responded. This helps improve the protocol efficiency.

21.4 Configuration

Configuration Item	Description and Command
Configuring Cross-Domain Multicast	⚠ This configuration is mandatory in the cross-domain multicast scenario. ip msdp peer <i>peer-address</i> connect-source <i>interface-type interface-number</i>
	Establishes an MSDP peer relationship.
Configuring an Anycast-RP	⚠ This configuration is mandatory in the Anycast-RP scenario. ip msdp peer <i>peer-address</i> connect-source <i>interface-type interface-number</i>
	Establishes an MSDP peer relationship.
	ip msdp originator-id <i>interface-type interface-number</i>
Modifies the RP address in the SA message.	
Configuring the Peer-RPF Check Green Channel	⚠ Optional. It is used to let SA message successfully pass the Peer-RPF check. ip msdp default-peer <i>peer-address</i> [prefix-list <i>prefix-list-name</i>]
	Configures the default MSDP peer.
	ip msdp mesh-group <i>mesh-name peer-address</i>
Configures an MSDP mesh group.	

Configuration Item	Description and Command
Enabling Security Measures	Optional. It is used to prevent illegal TCP connections and suppress SA storms.
	ip msdp password peer <i>peer-address</i> [<i>encryption-type</i>] <i>string</i> Enables TCP MD5 encryption.
	ip msdp sa-limit <i>peer-address</i> <i>sa-limit</i> Limits the number of SA messages in the SA cache.
Restricting Broadcasting of SA Messages	Optional. It is used to restrict releasing, receiving, and forwarding of SA messages.
	ip msdp redistribute [list <i>access-list</i>] [route-map <i>route-map</i>] Filters the source information released locally.
	ip msdp filter-sa-request <i>peer-address</i> [list <i>access-list</i>] Filters received SA requests.
	ip msdp sa-filter in <i>peer-address</i> [list <i>access-list</i>] [route-map <i>route-map</i>] [rp-list <i>rp-access-list</i>] [rp-route-map <i>rp-route-map</i>] Filters received SA messages.
	ip msdp sa-filter out <i>peer-address</i> [list <i>access-list</i>] [route-map <i>route-map</i>] [rp-list <i>rp-access-list</i>] [rp-route-map <i>rp-route-map</i>] Filters sent SA messages.
Managing MSDP Peers	Optional. It is used to conveniently manage the MSDP peer relationship.
	ip msdp description <i>peer-address</i> <i>text</i> Adds a description to an MSDP peer.
	ip msdp shutdown <i>peer-address</i> Shuts down an MSDP peer.
Modifying Protocol Parameters	Optional. You are advised not to modify the default values of protocol parameters.
	ip msdp timer <i>interval</i> Modifies the TCP reconnection interval.
	ip msdp ttl-threshold <i>peer-address</i> <i>ttl-value</i> Modify the TTL value of the multicast data packet carried in the SA message.

21.4.1 Configuring Cross-Domain Multicast

Configuration Effect

Establish the MSDP peer relationship between multiple ASs so that group member hosts can apply for the multicast streams across ASs.

Notes

- The inter-AC unicast route must be reachable.
- Run PIM-SM within each AS, and configure the BSR border.

Configuration Steps

➤ Establishing an MSDP Peer Relationship

- Mandatory.
- Establish a peer relationship between RPs of the corresponding multicast PIM domain.

- Establish an MSDP peer relationship between EBGp devices of different ASs.
- Establish an MSDP peer relationship between the RP and the EBGp device in each AS.

Command	ip msdp peer <i>peer-address connect-source interface-type interface-number</i>
Parameter	<i>peer-address</i> : Indicates the IP address of a remote peer.
Description	<i>interface-type interface-number</i> : Indicates the local interface, which is used to establish a TCP connection with the remote peer.
Defaults	N/A
Command Mode	Global configuration mode
Usage Guide	<p>The peer relationship is a bidirectional relationship. Therefore, this command must be configured on both sides. The IP address and local interface of the MSDP peer must be the same as those of the EBGp peer.</p> <p>To ensure that SA messages can successfully pass the Peer-RPF check, you are advised to:</p> <ul style="list-style-type: none"> ● Configure a mesh group. ● Configure the default MSDP peer.

Verification

Send a packet from a source (S) close to an RP to the group (G), and enable a host close to another RP to join G.

- Verify that the host can receive the (S, G) packet.
- Run the **show ip msdp summary** command on an RP in another AS to display the status of the MSDP peer.
- Run the **show ip msdp sa-cache** command on an RP in another AS to display the learned MSDP source information.

📄 Displaying the Learned MSDP Source Information

Command	show ip msdp sa-cache
Parameter	N/A
Description	
Command Mode	Privileged mode, global configuration mode, or interface configuration mode
Usage Guide	<p>If no address is specified, all the (S, G) information is displayed by default.</p> <p>If an address is specified, the device checks whether this address is a unicast or multicast address. If the address is a unicast address, this address is treated as the multicast source (S), and all (S, G) information in which the multicast source is S will be displayed. If the address is a multicast address, this address is treated as the multicast group (G), and all (S, G) information in which the multicast group is G will be displayed. If this address is neither a unicast or multicast address, no information is displayed.</p> <p>If two addresses are specified, one address is treated as the multicast source (S), and the other as the multicast group (G). If one address is the unicast address, and the other address is the multicast group address, no information is displayed.</p>
	<pre> uijie# show ip msdp sa-cache MSDP Source-Active Cache: 2 entries (200.200.200.200, 227.1.2.2), RP: 20.20.20.20, (M)BGP/AS 100, 04:17:09/00:02:05, Peer 200.200.200.2 Learned from peer 200.200.200.2, RPF peer 200.200.200.2, SAs received: 277, Encapsulated data received: 0 </pre>

(200.200.200.200, 227.1.2.3), RP: 20.20.20.20, (M)BGP/AS 100, 04:17:09/00:02:05, Peer 200.200.200.2 Learned from peer 200.200.200.2, RPF peer 200.200.200.2, SAs received: 277, Encapsulated data received: 0

📌 **Displaying the Brief MSDP Peer Information**

Command	show ip msdp summary
Parameter	N/A
Description	
Command Mode	Privileged mode, global configuration mode, or interface configuration mode
Usage Guide	N/A

```

FS# show ip msdp summary

Msdp Peer Status Summary

Peer Address   As   State   Uptime/Downtime   Reset-Count   Sa-Count   Peer-description
200.200.200.2 100   Up      04:22:11          10            6616      No description
200.200.200.3 100   Down    19:17:13          4             0         peer-A
                
```

Configuration Example

📌 **Configuring Cross-Domain Multicast**

Scenario
Figure 8-5

The following table lists the interfaces and IP addresses of different devices:

Device	Interface	IP Address	Remark
A	G0/1	100.100.100.1/24	N/A

		Loopback0	10.10.10.10/32	RP address, which is used to establish an MSDP connection.
B	G0/1		100.100.100.2/24	N/A
	G0/2		1.1.1.1/24	BSR border
	Loopback0		20.20.20.20/32	Used to establish the EBGP and MSDP connections.
C	G0/1		1.1.1.2/24	BSR border
	G0/2		2.2.2.1/24	BSR border
	Loopback0		30.30.30.30/32	Used to establish the EBGP and MSDP connections.
D	G0/2		2.2.2.2/24	BSR border
	G0/1		3.3.3.1/24	N/A
	Loopback0		40.40.40.40/32	Used to establish the EBGP and MSDP connections.
E	G0/1		3.3.3.2/24	N/A
	Loopback0		50.50.50.50/32	RP address, which is used to establish an MSDP connection.
Configuration Steps	<ul style="list-style-type: none"> ● Configure IP addresses of interfaces. ● Enable OSPF in each AS. Set up an EBGP peer relationship between AS 200 and AS 100 and between AS 200 and AS 300. Introduce BGP and OSPF to each other. ● Enable PIM-SM in each AS, configure C-BSR and C-RP, and configure the BSR border. ● Establish the MSDP peer relationship between EBGP peers and between the RP and EBGP peers. <p> The IP address and local interface of the MSDP peer must be the same as those of the EBGP peer.</p>			
A	<pre>A#configure terminal A(config)#ip multicast-routing A(config)#interface GigabitEthernet 0/1 A(config-if-GigabitEthernet 0/1)#ip pim sparse-mode A(config-if-GigabitEthernet 0/1)# exit A(config)#interface loopback 0 A(config-if-loopback 0)#ip pim sparse-mode A(config-if-loopback 0)# exit A(config)#ip pim rp-candidate loopback 0 A(config)#ip pim bsr-candidate loopback 0 A(config)#ip msdp peer 10.10.10.10 connect-source loopback 0</pre>			
B	<pre>B#configure terminal B(config)#ip multicast-routing B(config)#interface GigabitEthernet 0/1</pre>			

	<pre> B(config-if-GigabitEthernet 0/1)#ip pim sparse-mode B(config-if-GigabitEthernet 0/1)# exit B(config)#interface GigabitEthernet 0/2 B(config-if-GigabitEthernet 0/2)#ip pim sparse-mode B(config-if-GigabitEthernet 0/2)#ip pim bsr-border B(config-if-GigabitEthernet 0/2)# exit B(config)#interface loopback 0 B(config-if-loopback 0)#ip pim sparse-mode B(config-if-loopback 0)# exit B(config)#ip msdp peer 10.10.10.10 connect-source loopback 0 B(config)#ip msdp peer 30.30.30.30 connect-source loopback 0 </pre>
C	<pre> C#configure terminal C(config)#ip multicast-routing C(config)#interface GigabitEthernet 0/1 C(config-if-GigabitEthernet 0/1)#ip pim sparse-mode C(config-if-GigabitEthernet 0/1)#ip pim bsr-border C(config-if-GigabitEthernet 0/1)# exit C(config)#interface GigabitEthernet 0/2 C(config-if-GigabitEthernet 0/2)#ip pim sparse-mode C(config-if-GigabitEthernet 0/2)#ip pim bsr-border C(config-if-GigabitEthernet 0/2)# exit C(config)#interface loopback 0 C(config-if-loopback 0)#ip pim sparse-mode C(config-if-loopback 0)# exit C(config)#ip msdp peer 20.20.20.20 connect-source loopback 0 C(config)#ip msdp peer 40.40.40.40 connect-source loopback 0 </pre>
D	<pre> D#configure terminal D(config)#ip multicast-routing D(config)# ip pim ssmdefault D(config)#interface GigabitEthernet 0/1 D(config-if-GigabitEthernet 0/1)#ip pim sparse-mode D(config-if-GigabitEthernet 0/1)# exit D(config)#interface GigabitEthernet 0/2 </pre>

	<pre>D(config-if-GigabitEthernet 0/2)#ip pim sparse-mode D(config-if-GigabitEthernet 0/2)#ip pim bsr-border D(config-if-GigabitEthernet 0/2)# exit D(config)#interface loopback 0 D(config-if-loopback 0)#ip pim sparse-mode D(config-if-loopback 0)# exit D(config)#ip msdp peer 30.30.30.30 connect-source loopback 0 D(config)#ip msdp peer 50.50.50.50 connect-source loopback 0</pre>
E	<pre>E#configure terminal E(config)#ip multicast-routing E(config)#interface GigabitEthernet 0/1 E(config-if-GigabitEthernet 0/1)#ip pim sparse-mode E(config-if-GigabitEthernet 0/1)# exit E(config)#interface loopback 0 E(config-if-loopback 0)#ip pim sparse-mode E(config-if-loopback 0)# exit E(config)#ip pim rp-candidate loopback 0 E(config)#ip pim bsr-candidate loopback 0 E(config)#ip msdp peer 50.50.50.50 connect-source loopback 0</pre>
Verification	<p>Use the multicast source to send the packet (200.200.200.200,225.1.1.1), and enable the host to join the group 225.1.1.1.</p> <ul style="list-style-type: none"> ● Verify that the host receives this packet. ● On device C, check the status and SA message of the MSDP peer.
D	<pre>D# show ip msdp summary Msdp Peer Status Summary Peer Address As State Uptime/Downtime Reset-Count SA-Count Peer-Description 30.30.30.30 200 Up 00:01:420 1 1 No description D# show ip msdp sa-cache MSDP Source-Active Cache: 1 entries (200.200.200.200,225.1.1.1),RP:10.10.10.10,(M)BGP/AS 100, 00:00:18/00:01:57, Peer 30.30.30.30 Learned from peer 30.30.30.30, RPF peer 30.30.30.30, SAs received: 1, Encapsulated data received: 1</pre>

Common Errors

- The BSR border is not configured, or is not configured on a correct interface.
- PIM-SM is not enabled on the local interface used to establish the MSDP peer connection or on the interface of the peer IP address.
- SA messages cannot pass the Peer-RPF check.

21.4.2 Configuring an Anycast-RP

Configuration Effect

Establish the MSDP peer relationship within an AS to provide redundancy and load balancing for RPs.

Notes

- The inter-AC unicast route must be reachable.
- PIM-SM must run within the AS, and multiple RPs using the same IP addresses must be configured.
- The C-RP and C-BSR cannot be configured on the same interface.

Configuration Steps

✚ Establishing an MSDP Peer Relationship

- Mandatory.
- Configure the following command on each RP of the same AS to establish an MSDP peer relationship with each of other RPs:

Command	ip msdp peer <i>peer-address</i> connect-source <i>interface-type interface-number</i>
Parameter	<i>peer-address</i> : Indicates the IP address of a remote peer.
Description	<i>interface-type interface-number</i> : Indicates the local interface, which is used to establish a TCP connection with the remote peer.
Defaults	The MSDP peer relationship is not established.
Command Mode	Global configuration mode
Usage Guide	The peer relationship is a bidirectional relationship. Therefore, this command must be configured on both sides. To ensure that SA messages can successfully pass the Peer-RPF check, you are advised to configure a mesh group.

✚ Modifying the RP Address in the SA Message

- Mandatory.
- Configure the following command on each RP of the same AS:

Command	ip msdp originator-id <i>interface-type interface-number</i>
Parameter	<i>interface-type interface-number</i> : Uses the IP address of this interface as the RP address in the SA message.
Description	
Defaults	By default, the RP address in the SA message is not modified.
Command Mode	Global configuration mode
Usage Guide	In the anycast-RP application scenario, the RP addresses on all RP devices are the same. If the RP address in an SA message is not modified, the RP device may determine that this SA message is sent by itself and therefore discards this message. Therefore, you need to configure different RP addresses for SA messages sent by different RP devices.

Verification

Send a packet from a source (S) close to an RP to the group (G), and enable a host close to another RP to join G.

- Verify that the host can receive the (S, G) packet.
- Run the **show ip msdp sa-cache** command on an RP in another AS to display the learned MSDP source information.

▾ Displaying the Learned MSDP Source Information

Command	show ip msdp sa-cache
Parameter	N/A
Description	
Command Mode	Privileged mode, global configuration mode, or interface configuration mode
Usage Guide	<p>If no address is specified, all the (S, G) information is displayed by default.</p> <p>If an address is specified, the device checks whether this address is a unicast or multicast address. If the address is a unicast address, this address is treated as the multicast source (S), and all (S, G) information in which the multicast source is S will be displayed. If the address is a multicast address, this address is treated as the multicast group (G), and all (S, G) information in which the multicast group is G will be displayed. If this address is neither a unicast nor multicast address, no information is displayed.</p> <p>If two addresses are specified, one address is treated as the multicast source (S), and the other as the multicast group (G). If one address is the unicast address, and the other address is the multicast group address, no information is displayed.</p>
	<pre> FS# show ip msdp sa-cache MSDP Source-Active Cache: 2 entries (200.200.200.200, 227.1.1.2.2), RP: 20.20.20.20, (M)BGP/AS 100, 04:17:09/00:02:05, Peer 200.200.200.2 Learned from peer 200.200.200.2, RPF peer 200.200.200.2, SAs received: 277, Encapsulated data received: 0 (200.200.200.200, 227.1.1.2.3), RP: 20.20.20.20, (M)BGP/AS 100, 04:17:09/00:02:05, Peer 200.200.200.2 Learned from peer 200.200.200.2, RPF peer 200.200.200.2, SAs received: 277, Encapsulated data received: 0 </pre>

Configuration Example

▾ Sharing the Source information Among Anycast-RPs in the Same Multicast Domain

Scenario
Figure 8-6

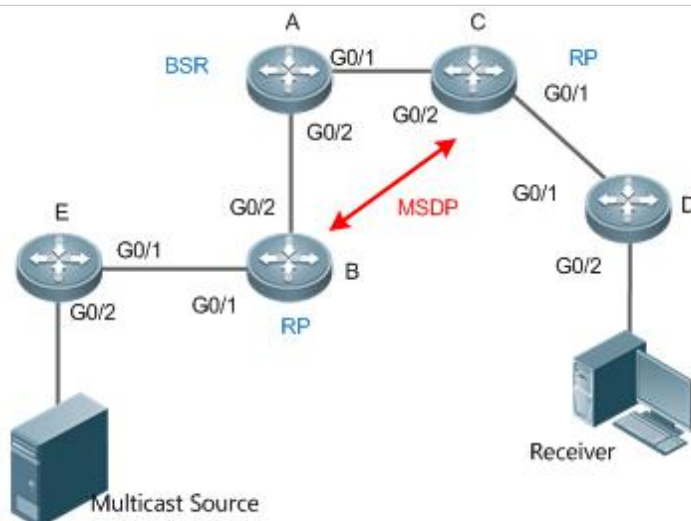

The following table lists the interfaces and IP addresses of different devices:

Device	Interface	IP Address	Remark
A	G0/2	2.2.2.1/24	
	G0/1	1.1.1.1/24	
	Loopback0	100.100.100.100/32	The C-BSR is configured on this interface.
B	G0/2	2.2.2.2/24	
	G0/1	3.3.3.1/24	
	Loopback1	20.20.20.20/32	Used to establish an MSDP connection and modify the RP address in the SA message.
	Loopback0	10.10.10.10/32	The C-RP is configured on this interface.
C	G0/2	1.1.1.2/24	
	G0/1	4.4.4.1/24	
	Loopback1	30.30.30.30/32	Used to establish an MSDP connection and modify the RP address in the SA message.
	Loopback0	10.10.10.10/32	The C-RP is configured on this interface.
D	G0/1	4.4.4.2/24	
	G0/2	5.5.5.1/24	
E	G0/1	3.3.3.2/24	
	G0/2	6.6.6.1/24	

Configuration Steps

- Configure IP addresses of interfaces.
- Enable OSPF within the AS.
- Enable PIM-SM within the AS, and configure the C-BSR and C-RP.
- Establish the MSDP peer relationship between RPs, and modify the RP address in the SA message.
- Configure a mesh group.

A

```
A#configure terminal
A(config)#ip multicast-routing
A(config)#interface GigabitEthernet 0/1
A(config-if-GigabitEthernet 0/1)#ip pim sparse-mode
```

	<pre>A(config-if-GigabitEthernet 0/1)# exit A(config)#interface GigabitEthernet 0/2 A(config-if-GigabitEthernet 0/2)#ip pim sparse-mode A(config-if-GigabitEthernet 0/2)# exit A(config)#interface loopback 0 A(config-if-loopback 0)#ip pim sparse-mode A(config-if-loopback 0)# exit A(config)#ip pim bsr-candidate loopback0</pre>
B	<pre>B#configure terminal B(config)#ip multicast-routing B(config)#interface GigabitEthernet 0/1 B(config-if-GigabitEthernet 0/1)#ip pim sparse-mode B(config-if-GigabitEthernet 0/1)# exit B(config)#interface GigabitEthernet 0/2 B(config-if-GigabitEthernet 0/2)#ip pim sparse-mode B(config-if-GigabitEthernet 0/2)# exit B(config)#interface loopback 0 B(config-if-loopback 0)#ip pim sparse-mode B(config-if-loopback 0)# exit B(config)#interface loopback 1 B(config-if-loopback 1)#ip pim sparse-mode B(config-if-loopback 1)# exit B(config)#ip pim rp-candidate loopback 0 B(config)#ip msdp peer 30.30.30.30 connect-source loopback 1 B(config)# ip msdp originator-id loopback 1 B(config)#ip msdp mesh-group mesh-name 30.30.30.30</pre>
C	<pre>C#configure terminal C(config)#ip multicast-routing C(config)#interface GigabitEthernet 0/1 C(config-if-GigabitEthernet 0/1)#ip pim sparse-mode C(config-if-GigabitEthernet 0/1)# exit C(config)#interface GigabitEthernet 0/2 C(config-if-GigabitEthernet 0/2)#ip pim sparse-mode</pre>

	<pre>C(config-if-GigabitEthernet 0/2)# exit C(config)#interface loopback 0 C(config-if-loopback 0)#ip pim sparse-mode C(config-if-loopback 0)# exit C(config)#interface loopback 1 C(config-if-loopback 1)#ip pim sparse-mode C(config-if-loopback 1)# exit C(config)#ip pim rp-candidate loopback 0 C(config)#ip msdp peer 20.20.20.20 connect-source loopback 1 C(config)# ip msdp originator-id loopback 1 C(config)#ip msdp mesh-group mesh-name 20.20.20.20</pre>
D	<pre>D#configure terminal D(config)#ip multicast-routing D(config)#interface GigabitEthernet 0/1 D(config-if-GigabitEthernet 0/1)#ip pim sparse-mode D(config-if-GigabitEthernet 0/1)# exit D(config)#interface GigabitEthernet 0/2 D(config-if-GigabitEthernet 0/2)#ip pim sparse-mode D(config-if-GigabitEthernet 0/2)# exit</pre>
E	<pre>E#configure terminal E(config)#ip multicast-routing E(config)#interface GigabitEthernet 0/1 E(config-if-GigabitEthernet 0/1)#ip pim sparse-mode E(config-if-GigabitEthernet 0/1)# exit E(config)#interface GigabitEthernet 0/2 E(config-if-GigabitEthernet 0/2)#ip pim sparse-mode E(config-if-GigabitEthernet 0/2)# exit</pre>
Verification	<p>Use the multicast source to send the packet (6.6.6.6,225.1.1.1), and enable the host to join the group 225.1.1.1.</p> <ul style="list-style-type: none"> ● Verify that the host receives this packet. ● On device C, check the status and SA message of the MSDP peer.
C	<pre>C# show ip msdp summary Msdp Peer Status Summary Peer Address As State Uptime/Downtime Reset-Count SA-Count Peer-Description</pre>

20.20.20.20 Unknown Up 00:01:420 1 No description C# show ip msdp sa-cache MSDP Source-Active Cache: 1 entries (6.6.6.6,225.1.1.1),RP:10.10.10.10,(M)BGP/AS unknown, 00:00:18/00:01:57, Peer 20.20.20.20 Learned from peer 20.20.20.20, RPF peer 20.20.20.20,
--

Common Errors

- The C-BSR and C-RP are configured on the same interface.
- The RP address in the SA message is not modified.
- SA messages cannot pass the Peer-RPF check.

21.4.3 Configuring the Peer-RPF Check Green Channel

Configuration Effect

Configure the Peer-RPF check green channel so that all SA messages sent from a specified MSDP peer can pass the Peer-RPF check.

Configure an MSDP mesh group so that all SA messages sent from members of the mesh group can pass the Peer-RPF check.

Notes

- The MSDP peer relationship must be established between devices.

Configuration Steps

⚡ **Configuring the Default MSDP Peer**

- Optional.
- On an MSDP peer, if it is not necessary to perform the Peer-RPF check on SA messages sent from a specified peer, configure this peer as the default peer.

Command	ip msdp default-peer <i>peer-address</i> [prefix-list <i>prefix-list-name</i>]
Parameter	<i>peer-address</i> : Indicates the IP address of a remote peer.
Description	prefix-list <i>prefix-list-name</i> : Specifies the prefix list, which is used to limit the RPs initiating SA messages.
Defaults	By default, no default peer is configured.
Command Mode	Global configuration mode
Usage Guide	If the command does not contain prefix-list <i>prefix-list-name</i> , all SA messages are accepted. If the command contains prefix-list <i>prefix-list-name</i> but the specified prefix list does not exist, all SA messages are accepted. If the command contains prefix-list <i>prefix-list-name</i> , and the specified prefix list exists, only the SA messages initiated by RPs specified in this prefix list are accepted.

⚡ **Creating a Mesh Group**

- Optional.
- Among multiple MSDP peers, if SA messages coming from any of these peers pass the Peer-RPF check by default, you can add these peers to a mesh group.

Command	ip msdp mesh-group <i>mesh-name</i> <i>peer-address</i>
Parameter	<i>mesh-name</i> : Indicates the name of the mesh group. The name is case sensitive.
Description	<i>peer-address</i> : Indicates the IP address of the MSDP peer to be added to the mesh group.
Defaults	By default, no mesh group is configured.
Command Mode	Global configuration mode
Usage Guide	An MSDP peer relationship must be established between every two MSDP peers added to the same mesh group. All SA messages sent by members of the mesh group can pass the Peer-RPF check.

Verification

- Check whether SA messages sent by the default peer can pass the Peer-RPF check.
- Check the configuration of the mesh group, and check whether all SA messages sent by members of the mesh group can pass the Peer-RPF check.

📄 **Displaying Information about the Peer-RPF Check of a Specified MSDP Peer**

Command	show ip msdp rpf-peer <i>ip-address</i>
Parameter	<i>peer-address</i> : Indicates the IP address of the SA message initiator.
Description	
Command Mode	Privileged mode, global configuration mode, or interface configuration mode
Usage Guide	N/A
	<pre> FS# show ip msdp rpf-peer 1.1.1.1 RPF peer information for 1.1.1.1 RPF peer: 200.200.200.2 RPF rule: Peer is only active peer RPF route/mask: Not-used RPF type: Not-used </pre>

📄 **Displaying the Mesh Group Configuration**

Command	show ip msdp mesh-group
Parameter	N/A
Description	
Command Mode	Privileged mode, global configuration mode, or interface configuration mode
Usage Guide	N/A
	<pre> FS# show ip msdp mesh-group MSDP peers in each Mesh-group, <Mesh-group name>:<# peers> </pre>

```
msdp-mesh:
1.1.1.2
1.1.1.3
```

Configuration Example

📌 **Configuring the Peer-RPF Check and a Mesh Group**

Figure 8-7

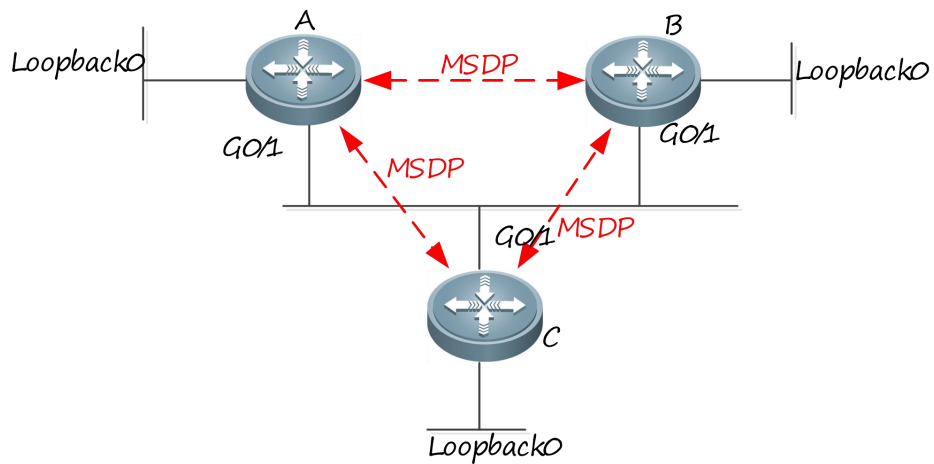

The following table lists the interfaces and IP addresses of different devices:

Device	Interface	IP Address	Remark
A	G0/1	20.0.0.3/24	
	Loopback0	10.1.1.1/24	
B	G0/1	20.0.0.4/24	
	Loopback0	40.0.0.1/24	
	G0/1	20.0.0.222/24	
	Loopback0	30.0.0.2/24	

Configuration Steps

- Configure IP addresses of interfaces.
- Enable OSPF within the AS.
- Establish the MSDP peer relationship between A and B and between A and C.
- Enable PIM-SM on the G0/1 interface of device C.
- Before configuration, there are two active MSDP peers on device A, but it is not known which one should be selected as the RPF peer. Therefore, display the RPF peer information. "RPF peer does not exist" is displayed.
- Configure the default MSDP peer, and check whether the configuration is successful.
- Configure a mesh group.

```
A#configure terminal
A(config)#ip msdp peer 20.0.0.4 connect-source gi0/1
A(config)#ip msdp peer 30.0.0.2 connect-source loopback 0
```

```
B#configure terminal
B(config)#ip msdp peer 20.0.0.3 connect-source gi0/1
```

C	<pre>C#configure terminal C(config)#ip msdp peer 10.0.0.1 connect-source loopback 0 C(config)#interface GigabitEthernet 0/1 C(config-if-GigabitEthernet 0/1)#ip pim sparse-mode C(config-if-GigabitEthernet 0/1)# exit</pre>
	<ul style="list-style-type: none"> ● Before configuration, there are two active MSDP peers on device A, but it is not known which one should be selected as the RPF peer. Therefore, display the RPF peer information. "RPF peer does not exist" is displayed. ● Configure the default MSDP peer. Then, display the RPF peer information. " Peer is best default peer" is displayed.
A	<pre>A#configure terminal A(config)#ip msdp default-peer 30.0.0.2</pre> <ul style="list-style-type: none"> ● Cancel the default peer, and send the multicast source information to device C. Information is displayed on device A, indicating that the SA message is received, but does not pass the Peer-RPF check. ● On device A, add 30.0.0.2 to the mesh group. Then, device A can receive the SA message normally.
A	<pre>A#configure terminal A(config)#no ip msdp default-peer 30.0.0.2</pre>
A	<pre>A#configure terminal A(config)#ip msdp mesh-group first 30.0.0.2</pre>
Verification	N/A

21.4.4 Enabling Security Measures

Configuration Effect

Enable MD5 encryption on TCP connections between MSDP peers to prevent illegal TCP connections.

Limit the number of SA messages in the SA cache of a specified MSDP peer to suppress SA storms.

Notes

- The MSDP peer relationship must be established between devices.

Configuration Steps

📌 Configuring MD5 Encryption on TCP Connections Between MSDP Peers

- Optional.
- Configure consistent MD5 encryption on MSDP peers that require encryption.

Command	ip msdp password peer <i>peer-address</i> [<i>encryption-type</i>] <i>string</i>
Parameter	<i>peer-address</i> : Indicates the IP address of a remote peer.
Description	<i>encryption-type</i> : Indicates the encryption level. Currently, only levels 0 to 7 are supported. 0 is the lowest level, and 7 is the highest level. The default value is 0. <i>string</i> : Indicates the cipher used for TCP MD5 authentication.

Defaults	By default, MD5 encryption is not configured.
Command Mode	Global configuration mode
Usage Guide	<p>To authenticate the ID of an MSDP peer, enable MD5 encryption on the TCP connection established with this MSDP peer. The MSDP peer must have the consistent configuration, and the cipher must be the same; otherwise, the connection fails.</p> <p>If the configuration or cipher changes, the local device does not stop the current session, and will attempt to use a new cipher to retain the current session until timeout.</p> <p>If the encryption level is set to 7, the cipher text length must be an even number equaling to or greater than 4; otherwise, the configuration fails.</p>

▾ **Limiting the Number of SA Messages in the SA Cache of a Specified MSDP Peer**

- Optional.
- Perform this configuration if you need to limit the number of SA messages in the SA cache of a specified MSDP peer.

Command	ip msdp sa-limit <i>peer-address sa-limit</i>
Parameter Description	<i>peer-address</i> : Indicates the IP address of a remote peer. <i>sa-limit</i> : Indicates the maximum number of SA messages in the SA cache.
Defaults	The default value is 1,024.
Command Mode	Global configuration mode
Usage Guide	An MSDP peer relationship must be established between every two MSDP peers added to the same mesh group. Assume that the number of SA messages in the SA cache already exceeds the limit. After the configuration is completed, the number of SA messages in the SA cache does not exceed the limit.

Verification

- Check the connection between peers on which MD5 encryption is configured.
- Send a number of source information packets that exceeds the limit to the peer where the maximum number of SA messages in the SA cache is configured. Check whether all the source information can be learned.

▾ **Displaying the Number of SA Messages Learned from a Specified Peer**

Command	show ip msdp count
Parameter Description	N/A
Command Mode	Privileged mode, global configuration mode, or interface configuration mode
Usage Guide	N/A
	<pre> FS# show ip msdp count SA State per Peer Counters, <Peer>: <# SA learned> 1.1.1.2 : 0 100.100.100.14 : 0 </pre>

```

100.100.100.15 : 0
100.100.100.200: 0
200.200.200.2  : 2
200.200.200.3  : 0
200.200.200.6  : 0
200.200.200.13 : 0
200.200.200.66 : 0

SA State per ASN Counters, <asn>: <# sources>/<# groups>

Total entries: 2

100: 1/2
    
```

Configuration Example

➤ **Configuring MD5 Encryption on an MSDP Peer and Limiting the Number of SA Messages Sent by This MSDP Peer in the SA Cache**

<p>Scenario Figure 8- 8</p>	
<p>Configuration Steps</p>	<ul style="list-style-type: none"> ● Establish an MSDP peer relationship between A and B. ● Configure MD5 encryption on device A. ● After MSDP timeout, configure the MD5 cipher of the peer on device B, which is the same as the cipher on device A. Then, the session is reconnected. ● On device A, set the maximum number of SA messages sent by the peer 20.0.0.4 in the SA cache to 10.
<p>A</p>	<pre> A#configure A(config)# ip msdp password peer 20.0.0.4 0 1234567 A(config)# ip msdp sa-limit 20.0.0.4 10 </pre>
<p>B</p>	<pre> B#configure B(config)# ip msdp password peer 20.0.0.4 0 1234567 </pre>
<p>Verification</p>	<ul style="list-style-type: none"> ● After MD5 is configured on device A, but is not configured on device B, a message will be displayed, indicating the MD5 encryption failure. At this time, the MSDP peer is in DOWN state. ● A period of time after MD5 is configured on device B, the MSDP peer is in DOWN state. ● Send 20 multicast source packets to device B. A message will be displayed on device A, indicating that the number of SA messages exceeds the limit.
<p>A</p>	<pre> A# debug ip msdp sa-cache A# show ip msdp count </pre>

21.4.5 Restricting Broadcasting of SA Messages

Configuration Effect

Configure the SA message filtering rules to restricting broadcasting of SA messages.

Notes

- The MSDP peer relationship must be established between devices.

Configuration Steps

📌 Filtering the Source Information Released Locally

- Optional.
- Configure the SA release filtering rule on an MSDP device where releasing of the SA information needs to be limited.

Command	ip msdp redistribute [list access-list] [route-map route-map]
Parameter	list access-list: Indicates the access control list (ACL) used to control the ranges of S and G.
Description	route-map route-map: Indicates the route map used to control the ranges of S and G.
Defaults	By default, no rule is configured to filter locally released SA information.
Command Mode	Global configuration mode
Usage Guide	<p>After this command is configured, only the accepted (S, G) information (either coming from the local domain or other domains) can be injected to the MSDP.</p> <p>If the command contains list access-list, only the (S, G) information matching this ACL can be released.</p> <p>If the command contains route-map route-map, only the (S, G) information matching this route map can be released.</p> <p>If the command contains both parameters, only the (S, G) information matching the ACL and route map can be released.</p> <p>If the command does not contain any parameter, no (S, G) information is released.</p>

📌 Filtering Received SA Requests

- Optional.
- Perform this configuration on the MSDP device where responding to the SA requests needs to be limited.

Command	ip msdp filter-sa-request peer-address [list access-list]
Parameter	peer-address: Indicates the IP address of a remote peer.
Description	list access-list: Indicates the ACL used to control the range of the group address.
Defaults	By default, no rule is configured to filter received SA requests.
Command Mode	Global configuration mode
Usage Guide	<p>Use this command if you need to control the SA requests that can be accepted and responded.</p> <p>If the command does not contain list access-list, all SA requests will be ignored.</p> <p>If the command contains list access-list, but this AC does not exist, all SA requests will be ignored.</p> <p>If the command contains list access-list, and this AC exists, only the SA requests allowed by the ACL will be accepted,</p>

	and others are ignored.
--	-------------------------

➤ **Filtering Received SA Messages**

- Optional.
- Perform this configuration on an MSDP device where the incoming SA information needs to be limited.

Command	ip msdp sa-filter in <i>peer-address</i> [list <i>access-list</i>] [route-map <i>route-map</i>] [rp-list <i>rp-access-list</i>] [rp-route-map <i>rp-route-map</i>]
Parameter	<i>peer-address</i> : Indicates the IP address of a remote peer.
Description	<p>list <i>access-list</i>: Indicates the number or name of the extended IP ACL of a specified (S, G). It is used to control the multicast source information (S, G) that is allowed to pass.</p> <p>route-map <i>route-map</i>: Indicates the name of the route map of the specified (S, G). The multicast source information (S, G) is allowed to pass only when the AS path of the route on the S matches the AS path in the route map.</p> <p>rp-list <i>rp-access-list</i>: Indicates the number or name of the standard ACL of a specified RP. It is used to control the RPs, of which the multicast source information (S, G) that is allowed to pass.</p> <p>rp-route-map <i>rp-route-map</i>: Indicates the name of the route map of a specified RP. The multicast source information (S, G) is allowed to pass only when the AS path of the route on the RP matches the AS path in the route map.</p>
Defaults	By default, no rule is configured to filter incoming SA messages.
Command Mode	Global configuration mode
Usage Guide	<p>If this command is configured, but no ACL or route map is specified, all incoming SA messages will be filtered.</p> <p>If only one keyword (list or route-map) is specified, and every multicast source record (S, G) in the SA message meets the rule specified by the keyword, the multicast source record (S, G) will be received.</p> <p>If either rp-list or rp-route-map is specified, and the RP address contained in the SA message meets the rule specified by this keyword, this SA message will be received.</p> <p>If two or more of the keywords (including list, route-map, rp-list, and rp-route-map) are specified, only multicast source record (S, G) in the SA message that meets the rules specified by all the available keywords can be received.</p>

➤ **Filtering Sent SA Messages**

- Optional.
- Perform this configuration on an MSDP device where the outgoing SA information needs to be limited.

Command	ip msdp sa-filter out <i>peer-address</i> [list <i>access-list</i>] [route-map <i>route-map</i>] [rp-list <i>rp-access-list</i>] [rp-route-map <i>rp-route-map</i>]
Parameter	<i>peer-address</i> : Indicates the IP address of a remote peer.
Description	<p>list <i>access-list</i>: Indicates the number or name of the extended IP ACL of the specified (S, G). It is used to control the multicast source information (S, G) that is allowed to pass.</p> <p>route-map <i>route-map</i>: Indicates the name of the route map of the specified (S, G). The multicast source information (S, G) is allowed to pass only when the AS path of the route on the S matches the AS path in the route map.</p> <p>rp-list <i>rp-access-list</i>: Indicates the number or name of the standard ACL of a specified RP. It is used to control the RPs, of which the multicast source information (S, G) that is allowed to pass.</p> <p>rp-route-map <i>rp-route-map</i>: Indicates the name of the route map of a specified RP. The multicast source information (S, G) is allowed to pass only when the AS path of the route on the RP matches the AS path in the route map.</p>
Defaults	By default, no rule is configured to filter outgoing SA messages.
Command	Global configuration mode

Mode	
Usage Guide	<p>If this command is configured, but no ACL or route map is specified, no SA message will be sent to this MSDP peer.</p> <p>If only one of the keywords (including list, route-map, rp-list, and rp-route-map) is specified, any multicast source record (S, G) that meets the rule specified by the keyword will be forwarded to this MSDP peer.</p> <p>If two or more of the keywords (including list, route-map, rp-list, and rp-route-map) is specified, any multicast source record (S, G) that meets the rules specified by all the available keywords will be forwarded to this MSDP peer.</p>

Verification

- Check whether SA messages initiated by the local device meet the filtering rules.
- Check whether SA messages learned by the local device meet the filtering rules.

📌 **Displaying SA Messages Initiated by the Local Device**

Command	show ip msdp sa-originated
Parameter	N/A
Description	
Command Mode	Privileged mode, global configuration mode, or interface configuration mode
Usage Guide	<p>If the local device is the RP of PIM-SM, multicast source (S, G) information is registered on the RP, and the MSDP peer is configured on the local device, you can run this command to display the (S, G) information initiated by the local device.</p> <p>The (S, G) information displayed by this command has met the criteria specified by the redistribution command ip msdp redistribute, but such (S, G) information can be sent to the MSDP peer only when the information meets the outgoing SA information filtering rules specified by the ip msdp sa-filter out command.</p>
	<pre> FS# show ip msdp sa-originated MSDP Source-Active Originated: 5 entries (192.168.23.78, 225.0.0.1), RP: 192.168.23.249 (192.168.23.79, 225.0.0.2), RP: 192.168.23.249 (192.168.23.80, 225.0.0.3), RP: 192.168.23.249 (192.168.23.81, 225.0.0.4), RP: 192.168.23.249 (192.168.23.82, 225.0.0.5), RP: 192.168.23.249 </pre>

Configuration Example

📌 **Configuring Rules for Filtering Incoming or Outgoing SA Messages**

Scenario
Figure 8-9

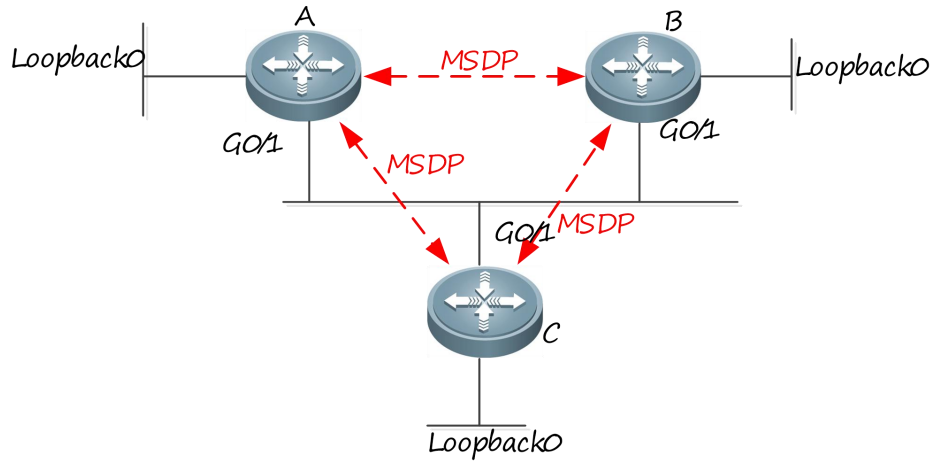

The following table lists the interfaces and IP addresses of different devices:

Device	Interface	IP Address	Remark
A	G0/1	20.0.0.3/24	
	Loopback0	10.1.1.1/24	
B	G0/1	20.0.0.4/24	
	Loopback0	40.0.0.1/24	
	G0/1	20.0.0.222/24	
	Loopback0	30.0.0.2/24	

Configuration Steps

- Complete the basic configuration, as described in section 8.4.3 "Configuring the Peer-RPF Check Green Channel".
- Configure rules for filtering incoming SA messages on device A.
- Configure rules for filtering outgoing SA messages on device A.
- Send the multicast source information to device C.

A

```
A#configure
A(config)# ip msdp sa-filter in 30.0.0.2
A(config)# ip msdp sa-filter in 30.0.0.2 list 100
A(config)# ip access-list extended 100
A(config-ext-nacl)# permit ip host 20.0.0.100 host 225.0.0.1
A(config)# ip msdp sa-filter in 30.0.0.2 rp-list rp-acl-1
A(config)# ip access-list standard rp-acl-1
A(config-std-nacl) # permit host 20.0.0.221
A(config)# ip msdp sa-filter in 30.0.0.2 rp-route-map rp-rm-1
A(config)# route-map rp-rm-1
A(config-route-map)#match as-path 1
A(config)# ip as-path access-list 1 permit 2
A#configure
A(config)# ip msdp sa-filter out 30.0.0.2
```

	<pre>A(config)# ip msdp sa-filter out 30.0.0.2 list 101 A(config)# ip access-list extended 101 A(config-ext-nacl)# permit ip host 20.0.0.100 host 225.0.0.1 A(config)# ip msdp sa-filter out 30.0.0.2 rp-list rp-acl-2 A(config)# ip access-list standard rp-acl-2 A(config-std-nacl) # permit host 20.0.0.221 A(config)# ip msdp sa-filter out 30.0.0.2 rp-route-map rp-rm-2 A(config)# route-map rp-rm-1 A(config-route-map)#match as-path 1 A(config)# ip as-path access-list 1 permit 2</pre>
Verification	<ul style="list-style-type: none"> ● Send the multicast source information to device C in various scenarios. ● On device A, check whether the learned multicast source information meets the incoming requirements. ● On device B, check whether the learned multicast source information meets the outgoing requirements.
A	<pre>A#show ip msdp sa-cache</pre>
B	<pre>B#show ip msdp sa-cache</pre>
C	<pre>B#show ip msdp sa-originated</pre>

21.4.6 Managing MSDP Peers

Configuration Effect

Manage MSDP peers by adding descriptions to a specified MSDP or reset an MSDP peer.

Notes

- MSDP peers must be created in advance.

Configuration Steps

⤵ Configuring the Description for an MSDP Peer

- Optional.
- Perform this configuration on an MSDP peer that should be managed.

Command	ip msdp description <i>peer-address text</i>
Parameter	<i>peer-address</i> : Indicates the IP address of a remote peer.
Description	<i>text</i> : Indicates the string that describes the MSDP peer.
Defaults	By default, no description information is configured of an MSDP peer.
Command Mode	Global configuration mode
Usage Guide	N/A

⤵ Shutting Down an MSDP Peer

- Optional.
- Perform this configuration when it is required to temporarily shut down the connection with a specified peer.

Command	ip msdp shutdown <i>peer-address</i>
Parameter	<i>peer-address</i> : Indicates the IP address of an MSDP peer.
Description	
Defaults	By default, an MSDP peer is not shut down.
Command Mode	Global configuration mode
Usage Guide	This command shuts down only the TCP connection with an MSDP peer, but does not delete this MSDP peer or configuration of this MSDP peer.

Verification

- Display information about a specified MSDP peer, and check whether the description and peer status meet the requirements.

📄 **Displaying Information about a Specified MSDP Peer**

Command	show ip msdp peer [<i>peer-address</i>]
Parameter	N/A
Description	
Command Mode	Privileged mode, global configuration mode, or interface configuration mode
Usage Guide	N/A
	<pre> FS#show ip msdp peer 20.0.0.1 MSDP PEER 20.0.0.1 (No description), AS unknown Connection status: State: Listen, Resets: 1, Connection source: GigabitEthernet 0/1 (20.0.0.2) Uptime(Downtime): 00:00:25, Message sent/received: 13/19 Input messages discarded: 0 Connection and counters cleared 00:13:25 ago Local Address of connection: 20.0.0.2 MD5 signature protection on MSDP TCP connection: enabled SA Filtering: Input (S,G) Access-list filter: None Input (S,G) route-map filter: None Input RP Access-list filter: None Input RP Route-map filter: None Output (S,G) Access-list filter: None Output (S,G) Route-map filter: None Output RP Access-list filter: None </pre>

<p>Output RP Route-map filter: None</p> <p>SA-Requests:</p> <p style="padding-left: 20px;">Input filter: None</p> <p>Peer ttl threshold: 0</p> <p>SAs learned from this peer: 2, SAs limit: No-limit</p> <p>Message counters:</p> <p style="padding-left: 20px;">SA messages discarded: 0</p> <p style="padding-left: 20px;">SA messages in/out: 13/0</p> <p style="padding-left: 20px;">SA Requests discarded/in: 0/0</p> <p style="padding-left: 20px;">SA Responses out: 0</p> <p style="padding-left: 20px;">Data Packets in/out: 6/0</p>

Configuration Example

➤ **Configuring the Description of an MSDP Peer and Shutting Down the Connection with This Peer**

<p>Scenario Figure 8- 10</p>	
<p>Configuration Steps</p>	<ul style="list-style-type: none"> ● Establish the MSDP peer relationship between device A and device B. ● Configure the description "peer-router-B" for the peer 20.0.0.4 on device A. ● Wait 60, and shut down the connection with the MSDP peer 20.0.0.4 on device A.
<p>A</p>	<pre>A#configure A(config)# ip msdp peer 20.0.0.4 connect-source gi0/1 A(config)# ip msdp description 20.0.0.4 peer-router-B A(config)# end A# show ip msdp peer 20.0.0.4 A#configure A(config)# ip msdp shutdown 20.0.0.4 A(config)# show ip msdp peer 20.0.0.4</pre>
<p>B</p>	<pre>B# configure B(config)# ip msdp peer 20.0.0.3 connect-source gi0/1 B(config)# end</pre>

Verification	<ul style="list-style-type: none"> ● Run the show ip msdp peer [<i>peer-address</i>] command to display the brief information of a specified peer, including the description and connection status of this MSDP peer.
A	A# show ip msdp peer 20.0.0.4

21.4.7 Modifying Protocol Parameters

Configuration Effect

Manage MSDP peers by adding descriptions to a specified MSDP or reset an MSDP peer.

Notes

- MSDP peers must be created in advance.

Configuration Steps

⚡ Configuring the TCP Reconnection Interval of an MSDP Peer

- Optional.
- Perform this configuration on the device where the TCP reconnection interval of an MSDP peer needs to be modified.

Command	ip msdp timer <i>interval</i>
Parameter Description	<i>interval</i> : Indicates the TCP reconnection interval. The unit is second. The value ranges from 1 to 60. The default value is 30.
Defaults	By default, the reconnection interval is 30s.
Command Mode	Global configuration mode
Usage Guide	Within the TCP reconnection interval, the MSDP peer on the proactive connection side can initiate at most one TCP connection. In some application scenarios, you can shorten the TCP reconnection interval to accelerate convergence of the MSDP peer relationship.

⚡ Configuring the TTL of the Multicast Packet Contained in the SA Message

- Optional.
- Perform this configuration on the MSDP device where inter-RP transfer of multicast packets should be restricted.

Command	ip msdp ttl-threshold <i>peer-address</i> <i>ttl-value</i>
Parameter Description	<i>peer-address</i> : Indicates the IP address of an MSDP peer. <i>peer-address</i> <i>ttl-value</i> : Indicates the TTL value. The value ranges from 0 to 255. The default value is 0.
Defaults	By default, the TTL value of the multicast packet contained in the SA message is not restricted.
Command Mode	Global configuration mode
Usage Guide	<p>This command restricts the sending of multicast packet encapsulated in the SA message. A multicast packet is sent to the MSDP peer only when the TTL value in the IP header of the multicast packet is equal to or greater than the preset TTL threshold. If the the TTL value in the IP header of the multicast packet is smaller than the preset TTL threshold, the multicast packet will be removed from the SA message and discarded before the SA message is sent to the MSDP peer.</p> <p>This command affects the sending of multicast packet in the SA message, but does not affect the sending of the</p>

	multicast source information (S, G) in the SA message.
--	--

➤ **Configuring the MSDP Peer Capacity Supported by a Device**

- Optional.
- If the default capacity (64 MSDP peers) is insufficient to support applications, you can modify the capacity on the device.

Command	ip msdp peer-limit <i>peer-limit</i>
Parameter	<i>peer-limit</i> : Indicates the maximum number of MSDP peers that can be configured. The value ranges from 1 to 128.
Description	The default value is 64.
Defaults	By default, at most 64 peers can be configured.
Command Mode	Global configuration mode
Usage Guide	This command is used to configure the maximum number of MSDP peers supported by a device. When configuring this command, if the number of MSDP peers on the device exceeds the value to be configured, a prompt will be displayed, and the configuration fails. The configuration can succeed only after the extra number peers are deleted.

➤ **Configuring the SA Cache Capacity Supported by a Device**

- Optional.
- Perform this configuration on a device where the SA cache capacity should be adjusted.

Command	ip msdp global-sa-limit <i>sa-limit</i>
Parameter	<i>sa-limit</i> : Indicates the maximum capacity of the SA cache supported by the device. The value ranges from 1 to 4,096.
Description	The default value is 1,024.
Defaults	By default, the SA cache supports 1,024 SA messages.
Command Mode	Global configuration mode
Usage Guide	This command is used to adjust the SA cache capacity of the device. You are advised to configure this command when the device is being started. If the capacity is increased when MSDP is in service, the adjustment does not affect the SA cache that is originally learned. If the capacity is increased when MSDP is in service, all SA caches that are originally learned from other devices or the SA caches initiated by the local devices must be deleted and re-learned.

Verification

- Shut down the connection with an MSDP peer. After the reconnection interval elapses, check whether the MSDP peer is in UP date again.

Configuration Example

➤ **Setting the MSDP Peer Reconnection Interval to 20s**

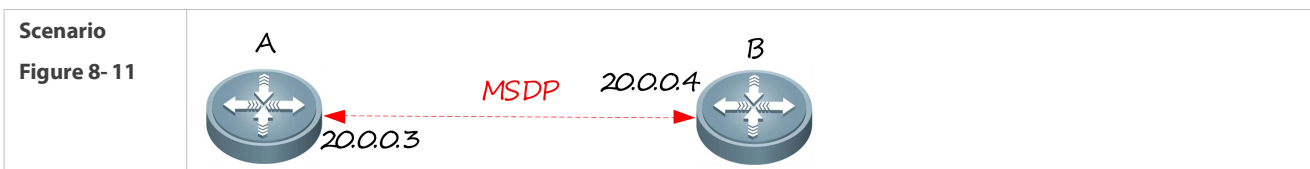

Configuration Steps	<ul style="list-style-type: none"> Establish the MSDP peer relationship between device A and device B. On device A, set the MSDP peer reconnection interval to 20s.
A	<pre>A#configure A(config)# ip msdp peer 20.0.0.4 connect-source gi0/1 A(config)# ip msdp description 20.0.0.4 peer-router-B A(config)# end A# show ip msdp peer 20.0.0.4 A#configure A(config)# ip msdp timer 20 A(config)# end</pre>
B	<pre>B# configure B(config)# ip msdp peer 20.0.0.3 connect-source gi0/1 B(config)# end</pre>
Verification	<ul style="list-style-type: none"> On device B, shut down and then immediately reconnect the connection with the MSDP peer. Check whether the MSDP peer is in UP state within 20s.
A	<pre>A#debug ip msdp timer</pre>
B	<pre>B# configure B(config)# show ip msdp peer 20.0.0.3</pre>

21.5 Monitoring

Clearing



Running the **clear** commands may lose vital information and thus interrupt services.

Description	Command
Resets the TCP connection with a specified MSDP peer.	clear ip msdp peer <i>peer-address</i>
Clears the SA cache.	clear ip msdp sa-cache <i>[group-address]</i>
Clears the statistics of MSDP peers.	clear ip msdp statistics <i>[peer-address]</i>

Displaying

Description	Command
Displays the number of sources and number of groups generated by SA messages.	show ip msdp count <i>[as-number]</i>
Displays information about a mesh	show ip msdp mesh-group

Description	Command
group.	
Displays detailed information about MSDP peers.	show ip msdp peer [<i>peer-address</i>]
Displays information about the MSDP RPF peer corresponding to the specified initiator address.	show ip msdp rpf-peer <i>ip-address</i>
Displays the learned (S, G) information.	show ip msdpsa-cache [<i>group-address</i> <i>source-address</i>] [<i>group-address</i>] <i>source-address</i>] [<i>as-number</i>]
Displays the (S, G) information initiated by the local device.	show ip msdpsa-originated
Displays brief information about all MSDP peers.	show ip msdp summary

Debugging



System resources are occupied when debugging information is output. Therefore, disable debugging immediately after use.

Description	Command
Debugs MSDP peers.	debug ip msdp peer

22 Configuring IGMP Snooping

22.1 Overview

Internet Group Management Protocol (IGMP) snooping is a mechanism of listening to IP multicast. It is used to manage and control the forwarding of IP multicast traffic within VLANs, realizing Layer-2 multicasting.

As shown in the following figure, when a Layer-2 device is not running IGMP snooping, IP multicast packets are broadcasted within the VLAN; when the Layer-2 device is running IGMP snooping, IP multicast packets are transmitted only to profile members.

Figure 9- 1 Networking Topology of IP Multicast Forwarding within the VLAN Before and After IGMP Snooping Is Run on the Layer-2 Device

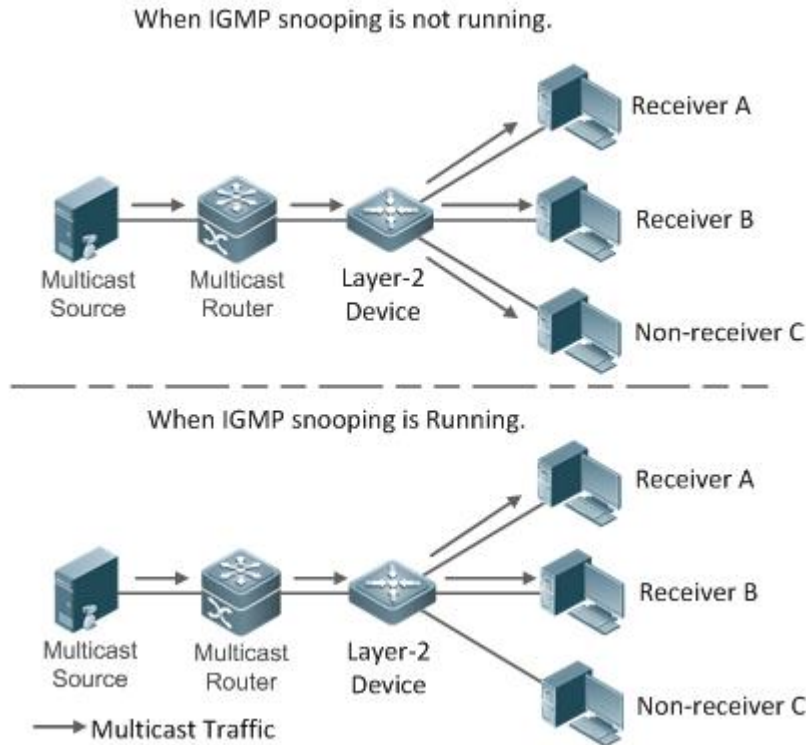

Protocols and Standards

- RFC4541: Considerations for Internet Group Management Protocol (IGMP) and Multicast Listener Discovery (MLD) Snooping Switches

22.2 Applications

Application	Description
Layer-2 Multicast Control	Enables precise forwarding of Layer-2 multicast packets to avoid flooding at this layer.
Shared Multicast Services (Multicast VLAN)	Multiple users can share the multicast traffic of the same VLAN.
Premium Channels and Preview	Controls the range of multicast addresses that allow user demanding and allows preview for profiles who are inhibited from demanding.

22.2.1 Layer-2 Multicast Control

Scenario

As shown in the following figure, multicast packets are transmitted to users through a Layer-2 switch. When Layer-2 multicast control is not performed, namely, when IGMP snooping is not implemented, multicast packets are flooded to all the users including those who are not expected to receive these packets. After IGMP snooping is implemented, the multicast packets from an IP multicast profile will no longer be broadcast within the VLAN but transmitted to designated receivers.

Figure 9- 2 Networking Topology of Implementing Layer-2 Multicast Control (Multicast VLAN)

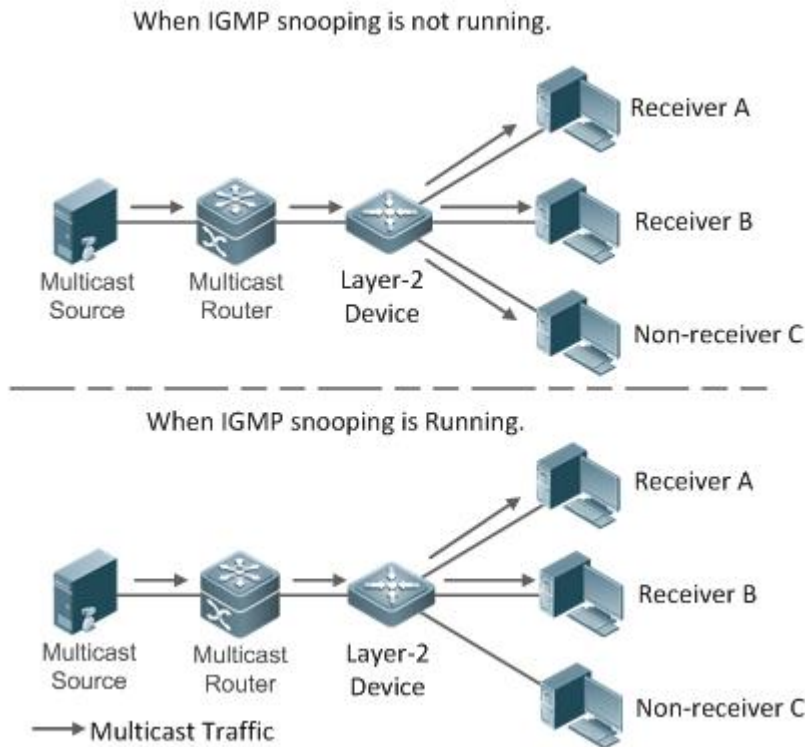

Deployment

Configure basic IGMP snooping functions.

22.2.2 Shared Multicast Services (Multicast VLAN)

Scenario

In Shared VLAN Group Learning (SVGL) mode or IVGL-SVGL mode (IVGL: Independent VLAN Group Learning), a device running IGMP snooping can provide shared multicast services (or multicast VLAN services) to the VLAN users. Typically, this function is used to provide the same video-on-demand (VOD) services to multiple VLAN users.

The following figure shows the operation of a Layer-2 multicast device in SVGL mode of IGMP snooping. The multicast router sends a multicast packet to VLAN 1, and the Layer-2 multicast device automatically transfers the packet to VLAN 1, VLAN 2, and VLAN 3. In this way, the multicast services of VLAN 1 are shared by VLAN 2 and VLAN 3.

Figure 9- 3 Networking Topology of Shared Multicast Services (Multicast VLAN)

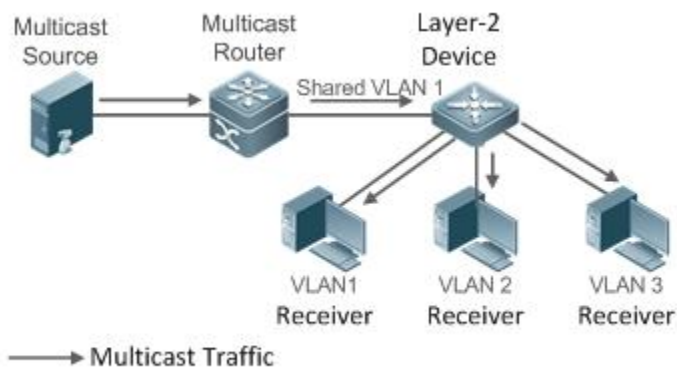

i If the Layer-2 multicast device operates in IVGL mode, the router must send a packet to each VLAN, which wastes bandwidth and burdens the Layer-2 multicast device.

Deployment

- Configure basic IGMP snooping functions (in SVGL mode or IVGL-SVG mode).

22.2.3 Premium Channels and Preview

Scenario

In VOD application, by limiting the range of the multicast addresses that a user host can access, unpaid users will not be able to watch the premium channels. Thereafter, the preview service is offered to unpaid users before they decide whether to pay for it.

The users can preview a premium channel for a certain period of time (for example 1 minute) after demanding it.

Deployment

- Configure basic IGMP snooping functions (in any working mode).
- Configure the range of multicast addresses that a user can access.
- Enable the preview function for VOD profiles that are denied access.

22.3 Features

Basic Concepts

➤ Multicast Router Ports and Member Ports

i IGMP snooping is VLAN-based. The ports involved refer to the member ports within the VLAN.

The device running IGMP snooping identifies the ports within the VLAN as a multicast router port or member port so as to manage and control the forwarding of IP multicast traffic within the VLAN. As shown in the following figure, when IGMP snooping is run on a Layer-2 device, multicast traffic enters the multicast router port and exits from the member ports.

Figure 9-4 Networking Topology of Two IGMP Snooping Ports

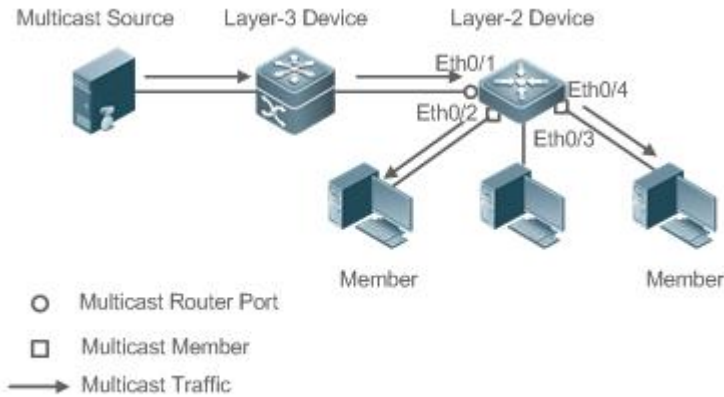

- Multicast router port: The location of the multicast source is directed by the port on the Layer-2 multicast device which is connected to the multicast router (Layer-3 multicast device): By listening to IGMP packets, the Layer-2 multicast device can automatically detect the multicast router port and maintain the port dynamically. It also allows users to configure a static router port.
- Member port: The port is on a Layer-2 multicast device and is connected to member hosts. It directs the profile members. It is also called the Listener Port. By listening to IGMP packets, the Layer-2 multicast device can automatically detect the member port and maintain the port dynamically. It also allows users to configure a static member port.

IGMP Snooping Forwarding Entry

The device running IGMP snooping forwards IP multicast packets in accordance with the IGMP snooping forwarding entry.

An IGMP snooping forwarding entry includes the following items: source address (S), profile address (G), VLAN ID (VLAN_ID), multicast router port, and member port. It indicates that packets of required features (including S, G, and VLAN_ID) should enter the multicast router port and exit from a member port. An IGMP snooping forwarding entry is identified using a group of S, G, and VLAN_ID.

To display the IGMP snooping forwarding entry, run the **show ip igmp snooping gda-table** command.

```
FS# show ip igmp snooping gda-table
Multicast Switching Cache Table

D: DYNAMIC //Dynamic member port
S: STATIC //Static member port
M: MROUTE //Multicast router port (dynamic or static)
(*, 233.3.6.29, 1): // (S: any; G: 233.3.6.29; VLAN_ID: VLAN 1)

VLAN(1) 3 OPORTS:
    GigabitEthernet 0/3(S)
    GigabitEthernet 0/2(M)
    GigabitEthernet 0/1(D)
(*, 233.3.6.30, 1): // (S: any; G: 233.3.6.30; VLAN_ID: VLAN 1)

VLAN(1) 2 OPORTS:
```

GigabitEthernet 0/2(M)
GigabitEthernet 0/1(D)

Overview

Feature	Description
Listening to IGMP Packets	Discovers and identifies the router port and member port to establish and maintain the IGMP snooping forwarding entries. :
IGMP Snooping Working Modes	Provides independent or shared multicast services to the user VLAN.
Multicast Security Control	Controls the multicast service scope and load to prevent illegal multicast traffic.
Profile	Defines the range of multicast addresses that permit or deny user requests for reference of other functions.
Handling QinQ	Sets the forwarding mode of multicast packets on the QinQ interface.
IGMP Querier	On a network without a Layer-3 multicast device, the Layer-2 multicast device acts as an IGMP querier.

22.3.1 Listening to IGMP Packets

A device running IGMP snooping analyzes IGMP packets received, and finds and identifies the router port and member port using these packets, thereby creating and maintaining an IGMP snooping entry.

Working Principle

A device running IGMP snooping can identify and handle the following types of IGMP packets:

Query Packets

 An IGMP querier periodically sends General Query packets. When the IGMP querier receives Leave packets, it sends Group-Specific Query packets.

When the device running IGMP snooping receives the Query packets, it performs the following operations within the VLAN:

- Forward the IGMP Query packets to all the ports (except the receiving port of these packets).
- If the receiving port is a dynamic router port, reset the aging timer. If the timer expires, the port will no longer be used as the dynamic router port.
- If the receiving port is not a dynamic router port, use it as a dynamic router port and enable the aging timer. If the timer expires, the port will no longer be used as the dynamic router port.
- For general queries, reset the aging timer for all the dynamic member ports. If the timer expires, the port will no longer be used as the dynamic member port for the general group. By default, the maximum response time carried by the IGMP query packets is used as the timeout time of the aging timer. If **ip igmp snooping query-max-response-time** is run, the time displayed is used as the timeout time of the aging timer.
- For designated query packets, reset the aging timer for all the dynamic member ports of the designated profile. If the timer expires, the port will no longer be used as the dynamic member port of the designated profile. By default, the maximum response time carried by the IGMP query packets is used as the timeout time of the aging timer. If **ip igmp snooping**

query-max-response-time is run, the time displayed is used as the timeout time of the aging timer.

- If dynamic router port learning is disabled, IGMP snooping will not learn the dynamic router port.

↘ Report Packets

i When a member host receives a query, it responds to the query with a Report packet. If a host requests to join a profile, it will also send a report.

i . For IGMPv3 Report packets, FS products only process group information contained in the packets .

When the device running IGMP snooping receives the Report packets, it performs the following operations within the VLAN:

- Forward the Report packets from all the router ports. After the **ip igmp snooping suppression enable** command is run in one IGMP query cycle, only the first report received by each profile will be forwarded.
- If the port on which Report packets are received is a dynamic member port, reset the aging timer. If the timer expires, the port will no longer be used as the dynamic member port of the designated profile.
- If the port on which Report packets are received is not a dynamic member port, use it as a dynamic member port and enable the aging timer. If the timer expires, the port will no longer be used as the dynamic member port of the designated profile.

↘ Leave Packets

i If a host requests to leave a profile, it will send a Leave packet.

When the device running IGMP snooping receives the Leave packets, it performs the following operations within the VLAN:

- Forward the leave packets from all the router ports.
- If the port on which leave packets are received is a dynamic member port and the Leave function is enabled, the port will be immediately deleted from the IGMP snooping forwarding entry of the designated profile and will no longer be used as the dynamic member port.
- If the port on which the leave packets are received is a dynamic member port and the Leave function is disabled, the port state should be maintained.

Related Configuration

↘ Configuring a Static Router Port

Run the **ip igmp snooping vlan mrouter interface** command to configure a static router port.

↘ Configuring a Static Member Port

Run the **ip igmp snooping vlan static interface** command to configure a static member port.

↘ Enabling Report Suppression

Report suppression is disabled by default.

Run the **ip igmp snooping suppression enable** command to enable report suppression.

After report suppression is enabled, in one IGMP query cycle, only the first Report packet received by each profile will be forwarded.

The source media access control (MAC) address of the forwarded report will be changed to the MAC address of the device.

↘ Enabling Immediate Leave

Immediate leave is disabled by default.

Run the **ip igmp snooping fast-leave enable** command to enable immediate leave.

↳ **Enabling Dynamic Router Port Learning**

Dynamic router port learning is enabled by default.

Run the **no ip igmp snooping mrouter learn pim-dvmrp** command to disable dynamic router port learning.

Run the **no ip igmp snooping vlan vid mrouter learn pim-dvmrp** command to disable dynamic router port learning for designated VLANs.

↳ **Configuring the Aging Time of a Dynamic Router Port**

The default aging time is 300s.

When a dynamic router port receives a query packet, the aging timer of the port is enabled or reset; if the aging time is not configured, the maximum response time carried by the query packet is used as the aging time.

Run **ip igmp snooping dyn-mr-aging-time** to configure the aging time of the dynamic router port.

↳ **Configuring the Aging Time of a Dynamic Member Port**

The default aging time is 260s.

When a dynamic member port receives a query packet, the aging timer of the port is enabled or reset, and the aging time is the maximum response time carried by the query packet.

When a dynamic member port receives a Report packet, the aging timer of the port is enabled or reset, and the aging time is the maximum response time of the dynamic member port.

Run **ip igmp snooping host-aging-time** to configure the aging time of the dynamic member port.

↳ **Configuring the Maximum Response Time of a Query Packet**

The maximum response time of a query packet is not configured by default and the maximum response time carries by the query packet is used.

Run **ip igmp snooping query-max-response-time** to configure the maximum response time of a query packet.

22.3.2IGMP Snooping Working Modes

A device running in the three modes (IVGL, SVGL, and IVGL-SVGL) of IGMP snooping can provide independent multicast services or shared multicast services to the user VLAN.

Working Principle

↳ **IVGL**

In IVGL mode, a device running IGMP snooping can provide independent multicast services to each user VLAN.

Independent multicast services indicate that multicast traffic can be forwarded only within the VLAN it belongs to, and a user host can subscribe to the multicast traffic within the VLAN that the host belongs to.

↳ **SVGL**

In SVGL mode, a device running IGMP snooping can provide shared multicast services to the user VLAN.

Shared multicast services can be provided only on shared VLANs and sub VLANs and SVGL multicast addresses are used. In a shared VLAN, the multicast traffic within the range of SVGL multicast addresses is forwarded to a sub VLAN, and the user hosts within the sub VLAN subscribe to such multicast traffic from the shared VLAN.

- In a shared VLAN and sub VLAN, shared multicast services will be provided to the multicast traffic within the range of SVGL multicast addresses. Other multicast traffic will be discarded.
- Other VLANs (except shared VLANs and sub VLANs) apply to independent multicast services.
- i** When the user VLAN is set to a shared VLAN or sub VLAN, shared multicast services are provided; when a user VLAN is set to other VLANs, independent multicast services are provided.

↘ **IVGL-SVGL**

IVGL-SVGL mode is also called the hybrid mode. In this mode, a device running IGMP snooping can provide both shared and independent multicast services to the user VLAN.

- In a shared VLAN and sub VLAN, multicast services will be provided to the multicast traffic within an SVGL profile. For other multicast traffic, independent multicast services will be provided.
- Other VLANs (except shared VLANs and sub VLANs) apply to independent multicast services.
- i** When a user VLAN is configured as a shared VLAN or sub VLAN, both public multicast services and independent multicast services are available. When a user VLAN is configured as a VLAN other than shared VLAN and sub VLAN, only the independent multicast services are available.

Related Configuration

↘ **Enabling IGMP Snooping and Selecting a Working Mode**

IGMP snooping is disabled by default.

Run the **ip igmp snooping ivgl** command to enable IGMP snooping in IVGL mode.

Run the **ip igmp snooping svgl** command to enable IGMP snooping in SVGL mode.

Run the **ip igmp snooping ivgl-svgl** command to enable IGMP snooping in IVGL-SVGL mode.

A working mode must be designated when enabling IGMP snooping, namely, one of the preceding working modes must be selected.

↘ **Configuring Shared VLAN**

The shared VLAN is VLAN 1 by default.

Run the **ip igmp snooping svgl vlan** command to designate a VLAN as the shared VLAN.

In SVGL mode and IVGL-SVGL mode, only one VLAN can be configured as the shared VLAN.

↘ **Configuring Sub VLAN**

By default, a sub VLAN is any VLAN except the shared VLAN.

Run the **ip igmp snooping svgl subvlan** command to designate a VLAN as the sub VLAN.

In SVGL mode and IVGL-SVGL mode, the number of sub VLANs is not limited.

↘ **Configuring an SVGL Profile**

No default setting.

Run the **ip igmp snooping svgl profile profile_num** command to configure the address range of an SVGL profile.

! In SVGL mode and IVGL-SVGL mode, the SVGL profile range must be configured; otherwise, shared multicast services cannot be

provided.

22.3.3IGMP Security Control

A device running IGMP snooping can control the multicast service scope and load, and effectively prevents illegal multicast traffic.

Working Principle

▾ Configuring the Profile Filtering for User Demanding

By configuring the profile list that a user can access, you can customize the multicast service scope to guarantee the interest of operators and prevent illegal multicast traffic.

To enable this function, you should use a profile to define the range of multicast addresses that a user is allowed to access.

- When the profile is applied on a VLAN, you can define the multicast addresses that a user is allowed to access within the VLAN.
- When the profile is applied on an interface, you can define the multicast addresses that a user is allowed to access under the port.

▾ Multicast Preview

If the service provider wants to allow the users to preview some multicast video traffic that denies the users' access, and stop the multicast video traffic after the preview duration is reached, the user-based multicast preview function should be provided.

The multicast preview function is used together with multicast permission control. For example, in the application of videos, the administrator controls some premium channels by running the **ip igmp profile** command on a port or VLAN. In this way, unsubscribed users will not be able to watch these channels on demand. If users want to preview the channels before they decide whether to pay for watching or not, the multicast preview function can be enabled, allowing the premium channels to be previewed by unpaid users for a certain period of time (for example 1 minute).

▾ Controlling the Maximum Number of Profiles Allowed for Concurrent Request

If there is too much multicast traffic requested at the same time, the device will be severely burdened. Configuring the maximum number of profiles allowed for concurrent request can guarantee the bandwidth.

- You can limit the number of profiles allowed for concurrent request globally.
- You can also limit the number of profiles allowed for concurrent request on a port.

▾ Controlling the Entry of Multicast Traffic

By running the **ip igmp snooping source-check port** command to enable source port inspection, you can restrict the entry of multicast traffic to prevent illegal traffic.

- When source port inspection is enabled, only the multicast traffic entered from the router port is considered as legal; the traffic from other ports is considered as illegal and will be discarded.
- When source port inspection is disabled, the traffic entered from any port is considered as legal.

▾ Configuring the Source IP Inspection for Multicast Traffic

By enabling source IP inspection, you can restrict the IP address of multicast traffic to prevent illegal traffic.

Source IP inspection includes the inspection of the source IP addresses of specific profiles and of default profiles.

- Inspection of the source IP addresses of default profiles (also called source-check default-server): Specifies the source IP

addresses for all the multicast profiles within all VLANs. Only the multicast traffic whose source IP address is the same as the set one is considered as legal.

- Inspection of the source IP addresses of specific profiles (also called limit-ipmc): Specifies the source IP addresses for specific multicast profiles within specific VLANs. Among the multicast traffic received from the specific multicast profiles within the VLANs, only the one with the same source IP address as the set one is considered as legal and will be forwarded by the multicast device; other traffic will be discarded.

Related Configuration

↘ **Configuring the Profile Filtering**

By default, profiles are not filtered and allow user access.

To filter multicast profiles, run the **ip igmp snooping filter** command in interface configuration mode or global configuration mode.

↘ **Enabling Preview**

Preview is not enabled by default.

Run the **ip igmp snooping preview** command to enable preview and restrict the range of the profiles permitted for multicast preview.

Run the **ip igmp snooping preview interval** to set the multicast preview duration.

↘ **Configuring the Maximum Number of Profiles Allowed for Concurrent Request on a Port**

By default, the number of profiles allowed for concurrent request is not limited.

Run the **ip igmp snooping max-groups** command to configure the maximum number of profiles allowed for concurrent request.

↘ **Configuring the Maximum Number of Multicast Profiles Allowed Globally**

By default, the maximum number of multicast profiles allowed globally is 65,536.

Run the **ip igmp snooping l2-entry-limit** command to configure the maximum number of multicast profiles allowed globally.

↘ **Enabling Source Port Inspection**

By default, source port inspection is not configured.

Run the **ip igmp snooping source-check port** command to enable source port inspection.

↘ **Enabling Source IP Inspection**

By default, source IP inspection is disabled.

- Run the **ip igmp snooping source-check default-server** *address* command to enable source IP inspection and specify the default source IP address (applicable to any profile of any VLAN).
- (Optional) Run the **ip igmp snooping limit-ipmc vlan** *vid* **address** *group-address* **server** *source-address* command to specify a specific source IP address for a specific profile of specific VLAN (applicable to a specific profile of specific VLAN).

First, you must enable source IP inspection to specify default source address, and then a specific source address can be specified for a specific profile of specific VLAN. If a source address is specified for a specific profile of specific VLAN, the multicast traffic of the specific profile will perform inspection for the source address specified by this command. Other multicast traffic will perform inspection for default source addresses.

22.3.4IGMP Profile

A multicast profile is used to define the range of multicast addresses that permit or deny user demanding request for reference of other functions.

Working Principle

The profile is used to define the range of multicast addresses.

When SVGL mode is enabled, an SVGL profile is used to define the range of SVGL multicast addresses.

When the multicast filter is configured on an interface, a profile is used to define the range of multicast addresses that permit or deny user request under the interface.

When a VLAN filter is configured, a profile is used to define the range of multicast addresses that permit or deny user request under within the VLAN.

When the preview function is enabled, a profile is used to define the range of multicast address allowed for preview.

Related Configuration

📌 Configuring a Profile

Default configuration:

- Create a profile, which is **deny** by default.

Configuration steps:

- Run the **ip igmp profile** *profile-number* command to create a profile.
- Run the **range** *low-address high_address* command to define the range of multicast addresses. Multiple address ranges are configured for each profile.
- (Optional) Run the **permit** or **deny** command to permit or deny user request (**deny** by default). Only one **permit** or **deny** command can be configured for each profile.

22.3.5IGMP QinQ

Working Principle

On a device with IGMP snooping enabled and dot1q-tunnel (QinQ) port configured, IGMP snooping will handle the IGMP packets received by the QinQ port using the following two approaches:

- Approach 1: Create a multicast entry on the VLAN where IGMP packets are located. The forwarding of IGMP packets on the VLAN where these packets are located is called transparent transmission. For example, presume that IGMP snooping is enabled for a device, Port A is designated as the QinQ port, the default VLAN of this port is VLAN 1, and it allows the passage of VLAN 1 and VLAN 10 packets. When a multicast Query packet is sent by VLAN 10 to Port A, IGMP snooping establishes a multicast entry for VLAN 10 and forwards the multicast Query packet to the router port of VLAN 10.
- Approach 2: Create a multicast entry on the default VLAN of the QinQ port. Encapsulate the multicast packet with the VLAN tag of the default VLAN where the QinQ port is located and forward the packet within the default VLAN. For example, presume that IGMP snooping is enabled for a device, Port A is designated as the QinQ port, the default VLAN of this port is VLAN 1, and it allows the passage of VLAN 1 and VLAN 10 packets. When a multicast Query packet is sent by VLAN 10 to Port A, IGMP snooping establishes a multicast entry for VLAN 1, encapsulates the multicast query packet with the tag of VLAN 1, and forward the packet to VLAN 1 router port.

Related Configuration

↳ Configuring QinQ

By default, IGMP snooping works in the mode specified in Approach 2.

Run the **ip igmp snooping tunnel** command to implement Approach 1.

22.3.6IGMP Querier

On a network with a Layer-3 multicast device, the Layer-3 multicast device acts as an IGMP querier. In this case, a Layer-2 device needs only to listen to IGMP packets to establish and maintain the forwarding entry, realizing Layer-2 multicast.

On a network without a Layer-3 multicast device, the Layer-2 multicast device must be configured with the IGMP querier function so that the device can listen to IGMP packets. In this case, a Layer-2 device needs to act as an IGMP querier as well as listen to IGMP packets to establish and maintain the forwarding entry to realize Layer-2 multicast.

Working Principle

A Layer-2 device acts as an IGMP querier to periodically send IGMP Query packets, listen to and maintain the IGMP Report packets replied by a user, and create a Layer-2 multicast forwarding entry. You can adjust relevant parameters of the Query packets sent by the IGMP querier through configuration.

When the device receives a Protocol-Independent Multicast (PIM) or Distance Vector Multicast Routing Protocol (DVMRP) packet, it considers that a multicast router, which will act as an IGMP querier, exists on the network and disables the querier function. In this way, IGMP routing will not be affected.

When the device receives the IGMP Query packets from other devices, it will compete with other devices for the IGMP querier.

↳ Enabling the Querier Function

You can enable the querier for a specific VLAN or all VLANs.

Only when the global querier function is enabled can the queriers for specific VLANs take effect.

↳ Specifying the IGMP Version for a Querier

The version of IGMP used for sending Query packets can be configured as IGMPv1 or IGMPv2.

↳ Configuring the Source IP Address of a Querier

You can configure the source IP address of a query packet sent by the querier based on VLANs.

When the source IP address of the querier is not configured, the querier will not take effect.

↳ Configuring the Query Interval of a Querier

You can configure the intervals for sending global Query packets based on different queriers on different VLANs.

↳ Configuring the Maximum Response Time of a Query Packet

You can configure the maximum response time carried by a Query packet that is sent by a querier. As IGMPv1 does not support the carrying of maximum response time by a Query packet, this configuration does not take effect when the querier is running IGMPv1. You can configure different maximum response time for queriers on different VLANs.

↳ Configuring the Aging Time of a Querier

When other IGMP queriers exist on a network, the existing device will compete with other queriers. If the existing device fails to be elected and is in the non-querier state, the aging timer of a querier will be enabled. After the timer expires, other queriers on the network are considered as expired and the existing device will be resumed as the querier.

Related Configuration

✚ Enabling the Querier Function

By default, the querier function of a device is disabled.

Run the **ip igmp snooping querier** command to enable the global querier function.

Run the **ip igmp snooping vlan num querier** command to enable the querier function for specific VLANs.

✚ Specifying the IGMP Version for a Querier

By default, a querier runs IGMPv2.

Run the **ip igmp snooping querier version** command to configure the global querier version.

Run the **ip igmp snooping vlan querier version** command to specify the querier version for specific VLANs.

✚ Configuring the Source IP Address of a Querier

By default, the source IP address of a querier is 0.

Run the **ip igmp snooping querier address** command to enable global source IP addresses of queriers.

Run the **ip igmp snooping vlan querier address** command to specify the source IP addresses of the queriers on specific VLANs.

✚ Configuring the Query Interval of a Querier

By default, the query interval of a querier is 60s.

Run the **ip igmp snooping querier query-interval** command to enable the global query interval of queriers.

Run **ip igmp snooping vlan querier query-interval** to specify the global query interval of the queriers on specific VLANs.

✚ Configuring the Maximum Response Time of a Query Packet

By default, the maximum response time of a query packet is 10s.

Run the **ip igmp snooping querier max-response-time** command to configure the maximum response time of the query packets sent by global queriers.

Run the **ip igmp snooping vlan querier max-response-time** command to specify the maximum response time of the query packets sent by the queriers on specific VLANs.

✚ Configuring the Aging Time of a Querier

By default, the aging time of a querier is 125s.

Run the **ip igmp snooping querier max-response-time** command to configure the aging time of global queriers.

Run the **ip igmp snooping vlan querier max-response-time** command to configure the aging time of queriers on specific VLANs.

22.4 Configuration

Configuration			Description and Command	
Configuring Snooping Mode)	Basic Functions (IVGL Mode)	IGMP (IVGL Mode)	Any of IVGL mode, SVGL mode, and IVGL-SVGL mode must be selected. It is used to enable IGMP snooping in IVGL mode.	
			ip igmp snooping ivgl	Enables global IGMP snooping in IVGL mode.
			no ip igmp snooping vlan num	Disables IGMP snooping for a VLAN.
Configuring Snooping Mode)	Basic Functions (SVGL Mode)	IGMP (SVGL Mode)	Any of IVGL mode, SVGL mode, and IVGL-SVGL mode must be selected. It is used to enable IGMP snooping in SVGL mode.	
			ip igmp snooping svgl	Enables global IGMP snooping in IVGL mode.
			no ip igmp snooping vlan num	Disables IGMP snooping for a VLAN.
			ip igmp snooping svgl profile profile_num	Configures the SVGL profile.
			ip igmp snooping svgl vlan	Specifies the SVGL shared VLAN.
			ip igmp snooping svgl subvlan	Specifies the SVGL sub VLAN.
Configuring Snooping (IVGL-SVGL Mode)	Basic Functions	IGMP (IVGL-SVGL Mode)	Any of IVGL mode, SVGL mode, and IVGL-SVGL mode must be selected. It is used to enable IGMP snooping in IVGL-SVGL mode.	
			ip igmp snooping ivgl-svgl	Enables global IGMP snooping in IVGL-SVGL mode.
			no ip igmp snooping vlan num	Disables IGMP snooping for a VLAN.
			ip igmp snooping svgl profile profile_num	Configures the SVGL profile.
			ip igmp snooping svgl vlan	Specifies the SVGL shared VLAN.
			ip igmp snooping svgl subvlan	Specifies the SVGL sub VLAN.
Configuring Processing	the Packet		(Optional) It is used to adjust relevant configurations for processing protocol packets.	
			ip igmp snooping vlan vlan-id mrouter interface interface-id	Configures a static router port.
			p igmp snooping vlan vid static group-address interface interface-type interface-number	Configures a static member port.
			ip igmp snooping vlan vlan-id mrouter learn pim-dvmrp	Enables dynamic router port learning.
			ip igmp snooping dyn-mr-aging-time time	Configures the aging time of a dynamic router port.
			ip igmp snooping host-aging-time time	Configures the aging time of a dynamic member port.
			ip igmp snooping fast-leave enable	Enables the immediate-leave function for a dynamic member port.
			ip igmp snooping query-max-response-time time	Configures the maximum response time of an IGMP query packet.
			ip igmp snooping suppression enable	Enables IGMP Report packet suppression.
Configuring Control	IGMP Security		(Optional) It used to guarantee the security when a user requests a multicast profile.	
			ip igmp snooping filter profile-number	Configures the profile filtering for user access.

	ip igmp snooping vlan num filter profile-number	Configures the per-VLAN profile filtering for user access.
	ip igmp snooping l2-entry-limit number	Configures the maximum number of profiles globally for user access.
	ip igmp snooping max-groups number	Configures the maximum number of dynamic profiles for user access.
	ip igmp snooping source-check port	Enables source IP inspection, which ensures the multicast traffic from the router port is legal.
	ip igmp snooping source-check default-server address	Enables source IP inspection. The multicast traffic whose source IP address matches the specified source IP address is considered as legal traffic.
	ip igmp snooping limit-ipmc vlan vid address group-address server source-address	Specifies a VLAN. In the multicast traffic of multicast addresses, the one whose source IP address matches the specified source IP address is considered as legal traffic.
	ip igmp snooping preview profile-number	Enables the preview function for a specified profile.
	ip igmp snooping preview interval num	Configures the preview duration.
Configuring an IGMP Profile	(Optional) It is used to define the range of multicast addresses that permits or denies the access of a user host.	
	ip igmp profile profile-number	Creates a profile.
	range low-address high_address	Configures the profile range.
	permit	Permits the access of a user host.
	deny	Denies the access of a user host.
Configuring IGMP QinQ	(Optional) It is used to configure QinQ interface to forward multicast packets using the VLAN identifier (VID) carried by packets.	
	ip igmp snooping tunnel	Configures QinQ to transmit IGMP packets transparently.
Configuring an IGMP Querier	(Optional) It is used to enable IGMP querier function on a network without a Layer-3 multicast device.	
	ip igmp snooping querier	Enables global querier function.
	ip igmp snooping vlan num querier	Enables the querier for a VLAN.
	ip igmp snooping querier version num	Specifies the IGMP version for queriers globally.
	ip igmp snooping vlan num querier version num	Specifies the IGMP version for a querier of a VLAN.
	ip igmp snooping querier address a.b.c.d	Configures the source IP address of queriers globally.
	ip igmp snooping vlan num querier address a.b.c.d	Configures the source IP address for a querier of a VLAN.

	ip igmp snooping querier query-interval num	Configures the query interval of queriers globally.
	ip igmp snooping vlan num querier query-interval num	Configures the query interval for a querier of a VLAN.
	ip igmp snooping querier max-response-time num	Configures the maximum response time for query packets globally.
	ip igmp snooping vlan num querier max-response-time num	Configures the maximum response time of query packets for a VLAN.
	ip igmp snooping querier timer expiry num	Configures the aging timer for queriers globally.
	ip igmp snooping vlan num querier timer expiry num	Configures the aging timer for a querier of a VLAN.

22.4.1 Configuring Basic IGMP Snooping Functions (IVGL Mode)

Configuration Effect

- Enable IGMP snooping to realize Layer-2 multicast.
- Provide independent multicast services to each VLAN.

Notes

- IP multicast cannot be realized in SVGL mode. If IP multicast must be used, select the IVGL mode.

Configuration Steps

✚ Enabling Global IGMP Snooping in IVGL Mode

Mandatory.

After IGMP snooping is enabled globally, this function will be enabled for all VLANs.

If not specified, it is advised to run global IGMP snooping on all the devices connected user hosts.

✚ Disabling IGMP Snooping for a VLAN

(Optional) You can use this function if you wish to disable IGMP snooping on specified VLANs.

Only when global IGMP snooping is enabled can it be disabled on specified VLANs.

In IVGL mode, each VLAN can enjoy independent multicast services. Disabling any VLAN multicast services will not interfere in the services provided to the others.

Verification

- Run the **show ip igmp snooping gda-table** command to display the IGMP snooping forwarding table and verify that the member ports include only those connecting member hosts.
- Run the **show ip igmp snooping** command to display the basic IGMP snooping information and verify that IGMP snooping is working in IVGL mode.

Related Commands

✚ Enabling Global IGMP Snooping in IVGL Mode

Command	ip igmp snooping ivgl
Parameter	N/A
Description	
Command Mode	Global configuration mode
Usage Guide	After this command is executed, IGMP snooping will be run on all VLANs. By default, IGMP snooping is disabled.

↘ **Disabling IGMP Snooping for a VLAN**

Command	no ip igmp snooping vlan num
Parameter	N/A
Description	
Command Mode	Global configuration mode
Usage Guide	Only when global IGMP snooping is enabled can it be disabled on specified VLANs. In IVGL mode, you can disable IGMP snooping on any VLAN.

↘ **Displaying the IGMP Snooping Entry**

Command	show ip igmp snooping gda-table
Parameter	N/A
Description	
Command Mode	Privileged EXEC mode, global configuration mode, or interface configuration mode
Usage Guide	This command is used to verify that the ports include only those connecting member hosts.

↘ **Displaying the IGMP Snooping Working Mode**

Command	show ip igmp snooping
Parameter	N/A
Description	
Command Mode	Privileged EXEC mode, global configuration mode, or interface configuration mode
Usage Guide	If a device is running in IVGL mode, the following information is displayed: <pre>IGMP Snooping running mode: IVGL</pre>

Configuration Example

↘ **Providing Layer-2 Multicast Services for the Subnet Hosts**

<p>Scenario Figure 9-5</p>	
	<p>A is the multicast router and is connected directly to the multicast source. B is the Layer-2 device and is connected directly to the user host. Receiver 1, Receiver 2, and Receiver 3 belong to VLAN 1.</p>
<p>Configuration Steps</p>	<ul style="list-style-type: none"> ● Configure the IP address and VLAN. ● Enable multicast routing on A and enable the multicast routing protocol on Layer-3 interface (Gi0/1 and VLAN 1). ● Enable IGMP snooping on B and select IVGL mode.
<p>A</p>	<pre>A# configure terminal A(config)# ip multicast-routing A(config)# interface GigabitEthernet 0/1 A(config-if-GigabitEthernet 0/1)# ip pim sparse-mode A(config-if-GigabitEthernet 0/1)# exit A(config)# interface vlan 1 A(config-if-VLAN 1)# ip pim sparse-mode A(config-if-VLAN 1)# exit</pre>
<p>B</p>	<pre>B# configure terminal B(config)# ip igmp snooping ivgl</pre>
<p>Verification</p>	<p>Send packets from the source (10.1.1.1) to G (229.1.1.1) to add Receiver 1 to G.</p> <ul style="list-style-type: none"> ● Confirm that the packets (10.1.1.1 and 229.1.1.1) are received by Receiver 1. ● Display the IGMP snooping forwarding entry on B and ensure that the port (10.1.1.1, 229.1.1.1, 1) includes only Fa0/2. ● Check whether the IGMP snooping working mode is IVGL.
<p>B</p>	<pre>B# show ip igmp snooping gda-table</pre>

Multicast Switching Cache Table

D: DYNAMIC

S: STATIC

M: MROUTE

(*;224.1.1.1, 1):

VLAN(1) 2 OPORTS:

FastEthernet 0/1(M)

FastEthernet 0/2(D)

B# show ip igmp snooping

IGMP Snooping running mode: IVGL

IGMP Snooping L2-entry-limit: 65536

Source port check: Disable

Source ip check: Disable

IGMP Fast-Leave: Disable

IGMP Report suppress: Disable

IGMP Global Querier: Disable

IGMP Preview: Disable

IGMP Tunnel: Disable

IGMP Preview group aging time : 60(Seconds)

Dynamic Mroute Aging Time : 300(Seconds)

Dynamic Host Aging Time : 260(Seconds)

vlan 1

IGMP Snooping state: Enable

Multicast router learning mode: pim-dvmrp

IGMP Fast-Leave: Disabled

IGMP VLAN querier: Disable

IGMP VLAN Mode: STATIC

Common Errors

- The working mode of IGMP snooping is improper.

22.4.2 Configuring Basic IGMP Snooping Functions (SVGL Mode)

Configuration Effect

- Enable IGMP snooping and select SVGL mode to realize Layer-2 multicast.
- Share the VLAN multicast services.

Configuration Steps

▾ Enabling Global IGMP Snooping in SVGL Mode

Mandatory.

Enable global IGMP snooping in SVGL mode.

Configure the range of associated SVGL profiles.

▾ Specifying the SVGL Shared VLAN

(Optional) By default, VLAN 1 is used as the shared VLAN. You can adjust this configuration for other options.

▾ Specifying the SVGL Sub VLAN

(Optional) By default, all the VLANs are used as the sub VLANs of SVGL and can share the multicast services of the shared VLAN. You can adjust this configuration for other options.

Verification

- Run the **show ip igmp snooping** command to display the basic IGMP snooping information and verify that IGMP snooping is working in SVGL mode.
- Run the **show ip igmp snooping gda-table** command to check whether inter-VLAN multicast entries are properly formed.

Related Commands

▾ Enabling Global IGMP Snooping in SVGL Mode

Command	ip igmp snooping svgl
Parameter	N/A
Description	
Command Mode	Global configuration mode
Usage Guide	By default, IGMP snooping is disabled. After the SVGL mode is selected, the range of profiles within SVGL multicast addresses needs to be associated.

▾ Configuring the SVGL profile

Command	ip igmp snooping svgl profile <i>profile_num</i>
Parameter	<i>profile_num</i> : Configures SVGL to associate a profile.
Description	
Command Mode	Global configuration mode
Usage Guide	By default, no profile is associated with SVGL.

➤ **Specifying the SVGL Shared VLAN**

Command	ip igmp snooping svgl vlan vid
Parameter	vid: Indicates a VLAN.
Description	
Command Mode	Interface configuration mode
Usage Guide	By default, VLAN 1 is used as the shared VLAN.

➤ **Specifying the SVGL Sub VLAN**

Command	ip igmp snooping svgl subvlan vid-range
Parameter	vid-range: Indicates VLAN ID or the range of VLAN IDs.
Description	
Command Mode	Interface configuration mode
Usage Guide	By default, all the VLANs except the shared VLAN are used as sub VLANs.

➤ **Displaying the IGMP Snooping Working Mode**

Command	show ip igmp snooping
Parameter	N/A
Description	
Command Mode	Privileged EXEC mode, global configuration mode, or interface configuration mode
Usage Guide	If a device is running in SVGL mode, the following information is displayed: <div style="background-color: #f0f0f0; padding: 5px; border: 1px solid #ccc;"> IGMP Snooping running mode: SVGL </div>

Configuration Example

➤ **Enabling SVGL on the Access Device**

<p>Scenario Figure 9-6</p>	
	<p>A is the multicast router and is connected directly to the multicast source. B is the Layer-2 device and is connected directly to the user host. Receiver 1 is connected to VLAN 2, Receiver 2 is connected to VLAN 3, and Receiver 3 is connected to VLAN 4.</p>

<p>Configuration Steps</p>	<ul style="list-style-type: none"> ● Configure the IP address and VLAN. (Omitted) ● Enable multicast routing on A and enable the multicast routing protocol on Layer-3 interface (Gi0/1 and VLAN 1). ● Enable IGMP snooping on B and select SVGL mode. ● Configure the range of associated SVGL multicast addresses on B.
<p>A</p>	<pre>A# configure terminal A(config)# ip multicast-routing A(config)# interface GigabitEthernet 0/1 A(config-if-GigabitEthernet 0/1)# ip pim sparse-mode A(config-if-GigabitEthernet 0/1)# exit A(config)# interface vlan 1 A(config-if-VLAN 1)# ip pim sparse-mode A(config-if-VLAN 1)# exit</pre>
<p>B</p>	<pre>B# configure terminal B(config)#ip igmp profile 1 B(config-profile)#permit B(config-profile)#range 224.1.1.1 238.1.1.1 B(config-profile)#exit B(config)#ip igmp snooping svgl B(config)#ip igmp snooping svgl profile 1</pre>
<p>Verification</p>	<p>Send packets from the source (10.1.1.1) to G (229.1.1.1) and add Receiver 1, Receiver 2 and Receiver 3 to G.</p> <ul style="list-style-type: none"> ● Confirm that the packets (10.1.1.1 and 224.1.1.1) are received by Receiver 1, Receiver 2, and Receiver 3. ● Display the IGMP snooping forwarding entry on B and ensure that the ports (*, 224.1.1.1, 1) include Gi0/2, Gi0/3, and Gi0/4. ● Check whether the IGMP snooping working mode is SVGL.
<p>B</p>	<pre>B# show ip igmp snooping gda-table Multicast Switching Cache Table D: DYNAMIC S: STATIC M: MROUTE (*,224.1.1.1, 1): VLAN(2) 1 OPORTS: GigabitEthernet 0/2(D) VLAN(3) 1 OPORTS:</pre>

GigabitEthernet 0/3(D) VLAN(4) 1 OPORTS: GigabitEthernet 0/4(D)
<pre> B# show ip igmp snooping IGMP Snooping running mode: SVGL IGMP Snooping L2-entry-limit: 65536 SVGL vlan: 1 SVGL profile number: 1 Source port check: Disable Source ip check: Disable IGMP Fast-Leave: Disable IGMP Report suppress: Disable IGMP Globle Querier: Disable IGMP Preview: Disable IGMP Tunnel: Disable IGMP Preview group aging time : 60(Seconds) Dynamic Mroute Aging Time : 300(Seconds) Dynamic Host Aging Time : 260(Seconds) </pre>

Common Errors

- The SVGL profile is not configured.
- The sent multicast traffic is not within the SVGL profile.

22.4.3 Configuring Basic IGMP Snooping Functions (IVGL-SVGL Mode)

Configuration Effect

- Enable IGMP snooping and select IVGL-SVGL mode to realize Layer-2 multicast.
- The SVGL profiles can share the multicast services.
- The non-SVGL profiles run in IVGL mode.

Configuration Steps

✚ Enabling Global IGMP Snooping in IVGL-SVGL Mode

Mandatory.

Enable global IGMP snooping in IVGL-SVGL mode.

Configure the range of associated SVGL profiles.

➤ Specifying the SVGL Shared VLAN

(Optional) By default, VLAN 1 is used as the shared VLAN. You can adjust this configuration for other options.

➤ Specifying the SVGL Sub VLAN

(Optional) By default, all the VLANs are used as the sub VLANs of SVGL and can share the multicast services of the shared VLAN. You can adjust this configuration for other options.

Verification

- Run the **show ip igmp snooping** command to display the basic IGMP snooping information and verify that IGMP snooping is working in IVGL-SVGL mode.
- Run the **show ip igmp snooping gda-table** command to check whether inter-VLAN multicast entries are properly formed for the SVGL profiles.
- Run the **show ip igmp snooping gda-table** command to check whether intra-VLAN multicast entries are properly formed for the SVGL profiles.

Related Commands

➤ Enabling Global IGMP Snooping in IVGL-SVGL Mode

Command	ip igmp snooping ivgl-svgl
Parameter	N/A
Description	
Command Mode	Global configuration mode
Usage Guide	By default, IGMP snooping is disabled. After the IVGL-SVGL mode is selected, the SVGL profiles needs to be associated.

➤ Configuring the SVGL Profile

Command	ip igmp snooping svgl profile <i>profile_num</i>
Parameter	<i>profile_num</i> : Configures SVGL to associate a profile.
Description	
Command Mode	Global configuration mode
Usage Guide	By default, no profile is associated with SVGL.

➤ Specifying the SVGL Shared VLAN

Command	ip igmp snooping svgl vlan <i>vid</i>
Parameter	<i>vid</i> : Indicates a VLAN.
Description	
Command Mode	Interface configuration mode
Usage Guide	By default, VLAN 1 is used as the shared VLAN.

➤ Specifying the SVGL Sub VLAN

Command	ip igmp snooping svgl subvlan <i>vid-range</i>
Parameter	<i>vid-range</i> : Indicates VLAN ID or the range of VLAN IDs.
Description	
Command Mode	Interface configuration mode
Usage Guide	By default, all the VLANs except the shared VLAN are used as sub VLANs.

▾ **Displaying the IGMP Snooping Working Mode**

Command	show ip igmp snooping
Parameter	N/A
Description	
Command Mode	Privileged EXEC mode, global configuration mode, or interface configuration mode
Usage Guide	If a device is running in SVGL mode, the following information is displayed: <div style="background-color: #f0f0f0; padding: 5px;">IGMP Snooping running mode: SVGL</div>

▾ **Displaying the IGMP Snooping Working Mode**

Command	show ip igmp snooping
Parameter	N/A
Description	
Command Mode	Privileged EXEC mode, global configuration mode, or interface configuration mode
Usage Guide	If a device is running in IVGL-SVGL mode, the following information is displayed: <div style="background-color: #f0f0f0; padding: 5px;">IGMP Snooping running mode: IVGL-SVGL</div>

Configuration Example

▾ **Enabling IVGL-SVGL on the Access Device**

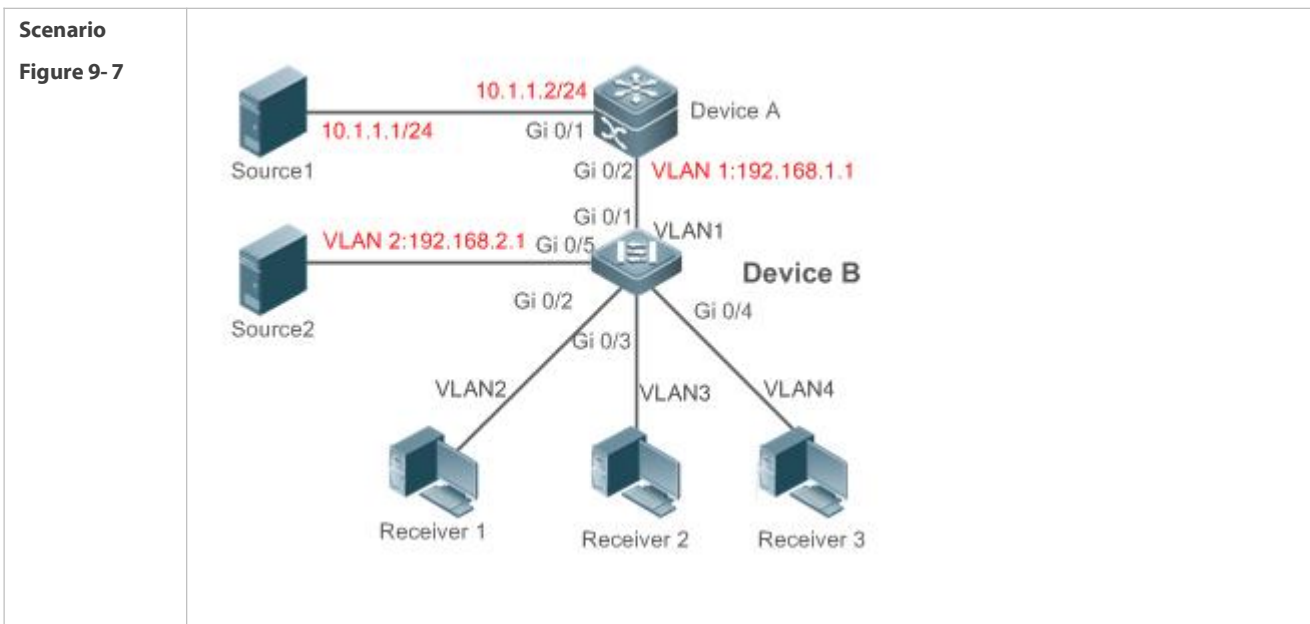

	<p>A is the multicast router and is connected directly to multicast Source 1.</p> <p>B is a Layer-2 device and is connected directly to the user host and multicast Source 2.</p> <p>Receiver 1 is connected to VLAN 2, Receiver 2 is connected to VLAN 3, and Receiver 3 is connected to VLAN 4.</p>
<p>Configuration Steps</p>	<ul style="list-style-type: none"> ● Configure the IP address and VLAN. ● Enable multicast routing on A and enable the multicast routing protocol on Layer-3 interface (Gi0/1 and VLAN 1). ● Enable IGMP snooping on B and select IVGL-SVGL mode. ● Configure the range of associated SVGL multicast addresses on B.
<p>A</p>	<pre>A# configure terminal A(config)# ip multicast-routing A(config)# interface GigabitEthernet 0/1 A(config-if-GigabitEthernet 0/1)# ip pim sparse-mode A(config-if-GigabitEthernet 0/1)# exit A(config)# interface vlan 1 A(config-if-VLAN 1)# ip pim sparse-mode A(config-if-VLAN 1)# exit</pre>
<p>B</p>	<pre>B# configure terminal B(config)#ip igmp profile 1 B(config-profile)#permit B(config-profile)#range 224.1.1.1 238.1.1.1 B(config-profile)#exit B(config)#ip igmp snooping ivgl-svgl B(config)#ip igmp snooping svgl profile 1</pre>
<p>Verification</p>	<p>Send packets from Source 1 (10.1.1.1) to G (224.1.1.1) and add Receiver 1, Receiver 2 and Receiver 3 to G.</p> <p>Send packets from Source 2 (192.168.2.1) to the destination (239.1.1.1) and add Receiver 1 239.1.1.1.</p> <ul style="list-style-type: none"> ● Confirm that the packets (10.1.1.1 and 224.1.1.1) are received by Receiver 1, Receiver 2, and Receiver 3. ● Check that packets (192.168.2.1 and 239.1.1.1) can be received by Receiver 1. ● Display the IGMP snooping forwarding entry on B and ensure that the ports (*, 224.1.1.1, 1) include Gi0/2, Gi0/3, and Gi0/4, and the port (*, 239.1.1.1, 1) is Gi0/2. ● Check whether the IGMP snooping working mode is IVGL-SVGL.
<p>B</p>	<pre>B# show ip igmp snooping gda-table Multicast Switching Cache Table D: DYNAMIC S: STATIC M: MROUTE</pre>

```
(* ,224.1.1.1, 1):
```

```
VLAN(2) 1 OPORTS:
```

```
    GigabitEthernet 0/2(D)
```

```
VLAN(3) 1 OPORTS:
```

```
    GigabitEthernet 0/3(D)
```

```
VLAN(4) 1 OPORTS:
```

```
    GigabitEthernet 0/4(D)
```

```
(* ,239.1.1.1, 2):
```

```
VLAN(2) 1 OPORTS:
```

```
    GigabitEthernet 0/2(D)
```

```
B# show ip igmp snooping
```

```
IGMP Snooping running mode: IVGL-SVGL
```

```
IGMP Snooping L2-entry-limit: 65536
```

```
SVGL vlan: 1
```

```
SVGL profile number: 0
```

```
Source port check: Disable
```

```
Source ip check: Disable
```

```
IGMP Fast-Leave: Disable
```

```
IGMP Report suppress: Disable
```

```
IGMP Globle Querier: Disable
```

```
IGMP Preview: Disable
```

```
IGMP Tunnel: Disable
```

```
IGMP Preview group aging time : 60(Seconds)
```

```
Dynamic Mroute Aging Time : 300(Seconds)
```

```
Dynamic Host Aging Time : 260(Seconds)
```

Common Errors

- The SVGL profile is not configured.
- The sent multicast traffic is not within the SVGL profile.
- The IVGL multicast traffic cannot be forwarded within the SVGL profile.

22.4.4 Configuring the Packet Processing

Configuration Effect

- Configure specified ports as the static router ports to receive the multicast traffic from all profiles.
- Configure specified ports as the static member ports to receive the multicast traffic from specified profiles
- Enable Report packets suppression to forward only the first Report packet from a specified VLAN or profile to the router port within a query interval, and the following Report packets will not be forwarded to the router port, thereby reducing the quantity of packets on the network.
- Configure the immediate-leave function to delete a port from the entry of member ports when a leave packet is received by the port.
- Disable dynamic router port learning to disable the learning of any router port.
- Based on network load and configuration of a multicast device, you can adjust the aging time of a router port and member port as well as the maximum response time of a query packet.

Notes

- Only when basic IGMP snooping is configured can relevant configurations take effect.

Configuration Steps

▾ Configuring a Static Router Port

- Optional.
- You can perform this configuration if you want to specify a static port to receive all the multicast traffic within the VLAN.

▾ Configuring a Static Member Port

- Optional.
- You can perform this configuration if you want to specify a static port to receive specific multicast traffic within the VLAN.

▾ Enabling Report Packet Suppression

- Optional.
- When there are numerous receivers to receive the packets from the same multicast profile, you can enable Report packets suppression to suppress the number of Report packets to be sent.

▾ Enabling the Immediate-Leave Function

- Optional.
- When there is only one receiver on a port, you can enable Leave to speed up the convergence of protocol upon leave.

▾ Disabling Dynamic Router Port Learning

- Optional.
- This function is used when multicast traffic needs to be forwarded only within the Layer-2 topology but not to a Layer-3 router.

▾ Configuring the Aging Time of a Dynamic Router Port

- Optional.
- You can configure the aging time based on network load.

➤ **Configuring the Aging Time of a Dynamic Member Port**

- Optional.
- You can configure the aging time based on the interval for sending IGMP query packets by the connected multicast router. Typically, the aging time is calculated as follows: Interval for sending IGMP query packets x 2 + Maximum response time of IGMP packets

➤ **Configuring the Maximum Response Time of a Query Packet**

- Optional.
- You can configure the aging time based on network load.

Verification

- Run the **show ip igmp snooping mrouter** command to check whether the configured static router port has an "S" in the displayed configuration information.
- Run the **show ip igmp snooping gda** command to check whether the configured static member port is marked with an S.
- Run the **show ip igmp snooping** command to check whether Report packets suppression, immediate leave, router port learning, router port aging time, member port aging time, and the maximum response time of the Query packet take effect.

Related Commands

➤ **Configuring a Static Router Port**

Command	ip igmp snooping vlan vid mrouter interface <i>interface-type interface-number</i>
Parameter	<i>vid</i> : Indicates a VLAN. The value ranges from 1 to 4,094.
Description	<i>interface-type interface-number</i> : Indicates an interface name.
Command Mode	Global configuration mode
Usage Guide	In SVGL mode, if a sub VLAN is not configured, only the configurations for the static router port within the shared VLAN can take effect, and the others can be configured but cannot take effect. If a sub VLAN is configured, only the configurations for the static router port within the shared VLAN or a non-sub VLAN can take effect, and the others can be configured but cannot take effect. In IVGL-SVGL mode, if a sub VLAN is not configured, the configurations for the static router ports within all the VLANs can take effect; if a sub VLAN is configured, only the configurations for the static router port within the shared VLAN or a non-sub VLAN can take effect, and the others can be configured but cannot take effect. In IVGL mode, the configurations for the static router ports within all the VLANs can take effect.

➤ **Configuring a Static Member Port**

Command	ip igmp snooping vlan vid static group-address interface <i>interface-type interface-number</i>
Parameter	<i>vid</i> : Indicates a VLAN. The value ranges from 1 to 4,094.
Description	<i>group-address</i> : Indicates a profile address. <i>interface-type interface-number</i> : Indicates an interface name.
Command Mode	Global configuration mode
Usage Guide	By default, no static member port is configured.

➤ **Enabling Report Packet Suppression**

Command	ip igmp snooping suppression enable
Parameter	N/A
Description	
Command Mode	Global configuration mode
Usage Guide	<p>When Report packets suppression is enabled, only the first Report packet from a specified VLAN or profile is forwarded to the router port within a Query interval, and the following Report packets will not be forwarded to the router port, thereby reducing the quantity of packets on the network.</p> <p>Only the IGMPv1 and IGMPv2 Report packets can be suppressed, and the IGMPv3 Report packets cannot be suppressed.</p>

↘ Enabling the Immediate-Leave Function

Command	ip igmp snooping fast-leave enable
Parameter	N/A
Description	
Command Mode	Global configuration mode
Usage Guide	<p>When this function is enabled, a port will be deleted from the entry of the member port when the port receives a leave packet. After that, the packets will no longer be forwarded to this port when it receives the query packets of specified profiles. Leave packets include the IGMPv2 Leave packets as well as the IGMPv3 Report packets that include types but carry no source address.</p> <p>The immediate-leave function applies only to the scenario where only one host is connected to a device port. It is used to conserve bandwidth and resources.</p>

↘ Enabling Dynamic Router Port Learning

Command	ip igmp snooping [vlan vid] mrouter learn pim-dvmrp
Parameter	vlan vid: Specifies a VLAN. This configuration applies to all VLANs by default.
Description	
Command Mode	Global configuration mode
Usage Guide	A router port is the port that is connected directly to a multicast device running IGMP snooping and a multicast neighbor device running multicast routing protocol. By default, dynamic router port learning is enabled and the device automatically listens to IGMP Query packets, DVMRP packets, and PIM Hello packets.

↘ Configuring the Aging Time of a Dynamic Router Port

Command	ip igmp snooping dyn-mr-aging-time seconds
Parameter	seconds: Indicates the aging time of a dynamic router port in the unit of seconds. The value ranges from 1 to 3,600.
Description	
Command Mode	Global configuration mode
Usage Guide	<p>If a dynamic router port does not receive an IGMP general query packet or a PIM Hello packet before the aging timer expires, the device will delete this port from the router port entry.</p> <p>When dynamic router port learning is enabled, you can run this command to adjust the aging time of the dynamic router port. If the aging time is too short, the multicast device may frequently add or delete a router port.</p>

➤ **Configuring the Aging Time of a Dynamic Member Port**

Command	ip igmp snooping host-aging-time <i>seconds</i>
Parameter Description	<i>seconds</i> : Indicates the aging time.
Command Mode	Global configuration mode
Usage Guide	<p>The aging time of a dynamic member port indicates the time when a device port receives the IGMP join packet sent from host for subscribing to an IP multicast profile.</p> <p>When the IGMP join packet is received, the aging time of the dynamic member port will be reset. The value of the timer time is host-aging-time. If the timer expires, the multicast device deems that no user host for receiving the multicast packet exists under the port, and will delete the port from the entry of IGMP snooping member port. After the aging time is configured, the aging time of following received IGMP join packets will be host-aging-time. This configuration takes effect after the next IGMP join packet is received, and the timer of the port in use will not be refreshed.</p>

➤ **Configuring the Maximum Response Time of a Query Packet**

Command	ip igmp snooping query-max-response-time <i>seconds</i>
Parameter Description	<i>seconds</i> : Indicates the maximum response time.
Command Mode	Global configuration mode
Usage Guide	<p>When an IGMP general Query packet is received, the multicast device will reset the aging time of all the dynamic member ports, which is query-max-response-time. If the timer expires, the multicast device deems that no user host for receiving the multicast packet exists under the port, and will delete the port from the entry of IGMP snooping member port.</p> <p>When an IGMP profile-specific Query packet is received, the multicast device will reset the aging time of all the dynamic member ports of the specific profile, which is query-max-response-time. If the timer expires, the multicast device deems that no user host for receiving the multicast packet exists under the port, and will delete the port from the entry of IGMP snooping member port.</p> <p>This configuration takes effect after the next Query packet is received, and the timer in use will not be refreshed. The timer of an IGMPv3 profile-specific Query packet is not refreshed.</p>

➤ **Displaying Router Ports**

Command	show ip igmp snooping mroute
Parameter Description	N/A
Command Mode	Privileged EXEC mode, global configuration mode, or interface configuration mode
Usage Guide	<p>If the router port is successfully configured, an "S" will be displayed in the port information.</p> <pre>FS(config)#show ip igmp snooping mrouter Multicast Switching Mroute Port</pre>

```
D: DYNAMIC
S: STATIC
(*, *, 1):
VLAN(1) 1 MROUTES:
    GigabitEthernet 0/1(S)
```

▾ **Displaying the Information of Dynamic Router Port Learning**

Command	show ip igmp snooping
Parameter	N/A
Description	
Command Mode	Privileged EXEC mode, global configuration mode, or interface configuration mode
Usage Guide	Run the show ip igmp snooping command to display the aging time and learning status of the dynamic router port. <pre>Dynamic Mroute Aging Time : 300(Seconds) Multicast router learning mode: pim-dvmrp</pre>

▾ **Displaying the Information of a Member Port**

Command	show ip igmp snooping gda-table
Parameter	N/A
Description	
Command Mode	Privileged EXEC mode, global configuration mode, or interface configuration mode
Usage Guide	If the member port is successfully configured, an "S" will be displayed in the port information. <pre>FS(config)#show ip igmp snooping gda-table Multicast Switching Cache Table D: DYNAMIC S: STATIC M: MROUTE (*, 224.1.1.1, 1): VLAN(1) 1 OPORTS: GigabitEthernet 0/1(S)</pre>

▾ **Displaying Other Parameters**

Command	show ip igmp snooping
Parameter	N/A
Description	
Command Mode	Privileged EXEC mode, global configuration mode, or interface configuration mode

Usage Guide	<p>Run the show ip igmp snooping command to display the aging time of the router port, aging time of the dynamic member port, response time of the query packet, and Report packets suppression, and immediate leave.</p> <pre> IGMP Fast-Leave: Enable IGMP Report suppress: Enable Query Max Response Time: 20(Seconds) Dynamic Mroute Aging Time : 300(Seconds) Dynamic Host Aging Time : 260(Seconds) </pre>
--------------------	---

Configuration Example

Configuring a Static Router Port and Static Member Port

Configuration Steps	<ul style="list-style-type: none"> ● Configure basic IGMP snooping functions. ● Configure a static router port and static member port.
	<pre> FS# configure terminal FS(config)# ip igmp snooping vlan 1 mrouter interface GigabitEthernet 0/0 FS(config)# ip igmp snooping vlan 1 static 224.1.1.1 interface GigabitEthernet 0/0 FS(config)# end </pre>
Verification	<p>Run the show ip igmp snooping mrouter and show ip igmp snooping gda-table commands to check whether the configuration takes effect.</p> <pre> FS#show ip igmp snooping mrouter Multicast Switching Mroute Port D: DYNAMIC S: STATIC (*, *, 1): VLAN(1) 1 MROUTES: GigabitEthernet 0/0(S) FS#show ip igmp snooping gda-table Multicast Switching Cache Table D: DYNAMIC S: STATIC M: MROUTE (*, 224.1.1.1, 1): VLAN(1) 1 OPORTS: GigabitEthernet 0/0(SM) </pre>

➤ **Enabling Report Packet Suppression**

<p>Scenario Figure 9- 8</p>	
	<p>A is the multicast router and is connected directly to multicast Source 1. B is a Layer-2 device and is connected directly to the user host and multicast Source 2. Receiver 1, Receiver 2, and Receiver 3 are connected to VLAN 1.</p>
<p>Configuration Steps</p>	<ul style="list-style-type: none"> ● Configure the IP address and VLAN. (Omitted) ● Enable multicast routing on A and enable the multicast routing protocol on Layer-3 interface (Gi0/1 and VLAN 1). ● Enable IGMP snooping on B and select IVGL mode. ● Enable Report packets suppression on B.
<p>A</p>	<pre>A# configure terminal A(config)# ip multicast-routing A(config)# interface GigabitEthernet 0/1 A(config-if-GigabitEthernet 0/1)# ip pim sparse-mode A(config-if-GigabitEthernet 0/1)# exit A(config)# interface vlan 1 A(config-if-VLAN 1)# ip pim sparse-mode A(config-if-VLAN 1)# exit</pre>
<p>B</p>	<pre>B# configure terminal B(config)#ip igmp snooping ivgl B(config)# ip igmp snooping suppression enable</pre>
<p>Verification</p>	<p>Check whether Receiver 1 and Receiver 2 are added to profile 239.1.1.1, and only the IGMP Report packets of profile 239.1.1.1 are forwarded from interface Gi0/1 of B.</p>

B	<pre> B# show ip igmp snooping IGMP Snooping running mode: IVGL IGMP Snooping L2-entry-limit: 65536 Source port check: Disable Source ip check: Disable IGMP Fast-Leave: Disable IGMP Report suppress: Enable IGMP Globle Querier: Disable IGMP Preview: Disable IGMP Tunnel: Disable IGMP Preview group aging time : 60(Seconds) Dynamic Mroute Aging Time : 300(Seconds) Dynamic Host Aging Time : 260(Seconds) </pre>
----------	--

⤵ Configuring Other Parameters

Configuration Steps	<ul style="list-style-type: none"> ● Configure basic IGMP snooping functions. ● Enable Immediate-leave function. ● Disable router port learning. ● Configure the aging time of a router port. ● Configuring the aging time of a member port. ● Configure the response time of a Query packet.
	<pre> FS# configure terminal FS(config)# ip igmp snooping fast-leave enable FS(config)# no ip igmp snooping mrouter learn pim-dvmrp FS(config)#ip igmp snooping dyn-mr-aging-time 200 FS(config)#ip igmp snooping host-aging-time 100 FS(config)#ip igmp snooping query-max-response-time 60 FS(config)# end </pre>
Verification	Run the show ip igmp snooping command to check whether the configuration is successful.
	<pre> FS#show ip igmp snooping IGMP Snooping running mode: IVGL IGMP Snooping L2-entry-limit: 65536 Source port check: Disable Source ip check: Disable </pre>

IGMP Fast-Leave: Enable IGMP Report suppress: Enable IGMP Globle Querier: Disable IGMP Preview: Disable IGMP Tunnel: Disable Query Max Response Time: 60(Seconds) IGMP Preview group aging time : 60(Seconds) Dynamic Mroute Aging Time : 200(Seconds) Dynamic Host Aging Time : 100(Seconds)

Common Errors

- Basic IGMP snooping functions are not configured or the configuration is not successful.

22.4.5 Configuring IGMP Security Control

Configuration Effect

- Configure the range of multicast addresses that a user can access.
- Configure to allow a user from an unauthorized profile to preview a multicast channel.
- Configure the number of multicast addresses that a user can access.
- Configure to limit a user to receive only the multicast traffic from a router port to prevent illegal multicast traffic sent by the end user.
- Configure to limit a user to receive only the multicast traffic from designated source IP addresses to prevent illegal multicast traffic.

Notes

- Basic IGMP snooping functions must be configured.

Configuration Steps

↘ **Configuring the Profile Filtering**

- Optional.
- If you want to limit the profile packets to be received by a port, you can configure the profile filtering on the port.
- If you want to limit the multicast packets to be received by a VLAN, you can configure the per-VLAN profile filtering.

↘ **Enabling Multicast Preview**

- Optional.
- You can enable multicast preview for a user from an unauthorized profile.

↘ **Configuring the Maximum Number of Profiles**

- Optional.
- If you want to limit the number of multicast profiles that a port is allowed to receive, you can configure the maximum number of

multicast profiles allowed for this port.

- If you want to limit the number of multicast profiles that global ports are allowed to receive, you can configure the maximum number of multicast profiles allowed for these ports.

↘ **Configuring Source Port Inspection**

- Optional.
- You can perform this configuration if you want to allow a port to receive only the multicast traffic from the router port.

↘ **Configuring Source IP Inspection**

- Optional.
- You can perform this configuration to specify the source IP address for all the multicast profiles of all VLANs. Only the multicast traffic whose source IP address is the same as the set one is considered as legal.
- You can also specify the source IP addresses for specific multicast profiles within specific VLANs. Among the multicast traffic received from the specific multicast profiles within the VLANs, only the one with the same source IP address as the set one is considered as legal and will be forwarded by the multicast device; other traffic will be discarded.

Verification

- Run the **show ip igmp snooping interfaces** command to display the profile filtering and the maximum number of multicast profiles for a port.
- Run the **show ip igmp snooping vlan** command to display the per-VLAN profile filtering.
- Run the **show ip igmp snooping** command to check whether the maximum number of global multicast profiles, preview function, source port inspection, and source IP address inspection take effect.

Related Commands

↘ **Configuring the Profile Filtering**

Command	ip igmp snooping filter <i>profile-number</i>
Parameter	<i>profile-number</i> : Indicates a profile number.
Description	
Command Mode	Interface configuration mode
Usage Guide	N/A

↘ **Configuring the Per-VLAN Profile Filtering**

Command	ip igmp snooping vlan <i>vid filter</i> <i>profile-number</i>
Parameter	<i>vid</i> : Indicates a VLAN. The value ranges from 1 to 4,094.
Description	<i>profile-number</i> : Indicates a profile number.
Command Mode	Global configuration mode
Usage Guide	N/A

✚ Configuring the Maximum Number of Profiles on a Port

Command	ip igmp snooping max-groups <i>number</i>
Parameter Description	<i>number</i> : Indicates the maximum number of multicast profiles.
Command Mode	Interface configuration mode
Usage Guide	This value indicates only the number of dynamic multicast profiles, and the number of static profiles is not included. The counter of multicast profiles is based on the VLAN that the port belongs to. For example, if a port belongs to three VLANs, and all three of them receive a request packet from multicast profile 224.1.1.1 simultaneously, then the counter of multicast profiles will be 3 but not 1.

✚ Configuring the Maximum Number of Global Profiles

Command	ip igmp snooping l2-entry-limit <i>number</i>
Parameter Description	<i>number</i> : Indicates the maximum number of multicast profiles.
Command Mode	Global configuration mode
Usage Guide	This value includes the number of both dynamic profiles as well as static profiles.

✚ Configuring Source Port Inspection

Command	ip igmp snooping source-check port
Parameter Description	N/A
Command Mode	Global configuration mode
Usage Guide	After source port inspection is enabled, the multicast traffic received by a device will be discarded if no router port is detected in the network environment.

✚ Configuring Source IP Inspection

Command	ip igmp snooping source-check default-server <i>source-address</i>
Parameter Description	<i>source-address</i> : Indicates the source IP address.
Command Mode	Global configuration mode
Usage Guide	N/A

✚ Enabling Source IP Inspection for a Specific Profile

Command	ip igmp snooping limit-ipmc vlan <i>vid</i> address <i>group-address</i> server <i>source-address</i>
Parameter Description	<i>vid</i> vlan id <i>group-address</i> : Indicates a profile address. <i>source-address</i> : Indicates the source IP address.
Command Mode	Global configuration mode

Usage Guide	N/A
--------------------	-----

↘ **Enabling Preview**

Command	ip igmp snooping preview <i>profile-number</i>
Parameter Description	<i>profile number</i> : Indicates the range of multicast addresses allowed for preview. The value ranges from 1 to 1,024.
Command Mode	Global configuration mode
Usage Guide	N/A

↘ **Configuring the Preview Duration**

Command	ip igmp snooping preview interval <i>num</i>
Parameter Description	<i>num</i> : Specifies the preview duration which ranges from 1s to 300s (60s by default).
Command Mode	Global configuration mode
Usage Guide	This configuration allows unauthorized users to receive multicast traffic within the preview duration. After the duration is met, the preview will be stopped; the preview can be resumed in 300s.

↘ **Displaying the Per-Port Profile Filtering**

Command	show ip igmp snooping interface
Parameter Description	N/A
Command Mode	Privileged EXEC mode, global configuration mode, or interface configuration mode
Usage Guide	<p>If the function is configured, the profile will be displayed, for example:</p> <pre> FS#show ip igmp snooping interfaces gigabitEthernet 0/1 Interface Filter profile number max-group ----- GigabitEthernet 0/1 1 </pre>

↘ **Displaying the Per-VLAN Profile Filtering**

Command	show ip igmp snooping vlan
Parameter Description	N/A
Command Mode	Privileged EXEC mode, global configuration mode, or interface configuration mode
Usage Guide	<p>If the function is configured, the profile will be displayed, for example:</p> <pre> IGMP VLAN filter: 1 </pre>

↘ **Displaying the Maximum Number of Interface Profiles**

Command	show ip igmp snooping interface
Parameter Description	N/A
Command Mode	Privileged EXEC mode, global configuration mode, or interface configuration mode
Usage Guide	<p>If the maximum number of multicast addresses for a port is configured, the value will be displayed, for example:</p> <pre> FS#show ip igmp snooping interfaces gigabitEthernet 0/1 Interface Filter profile number max-group ----- - GigabitEthernet 0/1 1 200 </pre>

↘ **Displaying the Maximum Number of Global Profiles**

Command	show ip igmp snooping vlan
Parameter Description	N/A
Command Mode	Privileged EXEC mode, global configuration mode, or interface configuration mode
Usage Guide	<p>If the function is configured, the profile will be displayed, for example:</p> <pre> IGMP Snooping L2-entry-limit: 65536 </pre>

↘ **Displaying the Information of Source Port Inspection**

Command	show ip igmp snooping vlan
Parameter Description	N/A
Command Mode	Privileged EXEC mode, global configuration mode, or interface configuration mode
Usage Guide	<p>If source port inspection is enabled, the following information will be displayed:</p> <pre> Source port check: Enable </pre>

↘ **Displaying the Information of Source IP Inspection**

Command	show ip igmp snooping vlan
Parameter Description	N/A
Command Mode	Privileged EXEC mode, global configuration mode, or interface configuration mode
Usage Guide	<p>If source IP address inspection is enabled, the following information will be displayed:</p> <pre> Source ip check: Enable </pre>

↘ **Displaying the Information of the Preview Function**

Command	show ip igmp snooping
----------------	------------------------------

Parameter Description	N/A
Command Mode	Privileged EXEC mode, global configuration mode, or interface configuration mode
Usage Guide	<p>If the range of multicast addresses for a port is configured, preview will be enabled, for example:</p> <pre>IGMP Preview: Enable IGMP Preview group aging time : 60(Seconds)</pre>

Configuration Example

📌 **Configuring the Profile Filtering and the Maximum Number of Demanded Profiles**

<p>Scenario Figure 9-9</p>	
	<p>A is the multicast router and is connected directly to multicast Source 1. B is a Layer-2 device and is connected directly to the user host and multicast Source 2. Receiver 1, Receiver 2, and Receiver 3 are connected to VLAN 1. By configuring VLAN 1, you can configure to allow the users within VLAN 1 to receive only the profiles whose addresses range from 225.1.1.1 to 225.1.255.255. You can configure Receiver 1 to receive only the profiles whose addresses range from 225.1.1.1 to 225.1.1.255, Receiver 2 to receive only the profiles whose addresses range from 225.1.2.1 to 255.1.2.255, and Receiver 3 to receive only the profiles whose addresses range from 225.1.3.1 to 225.1.3.255. At most 10 profiles can be added to a port and at most 100 profiles can be added globally.</p>
<p>Configuration Steps</p>	<ul style="list-style-type: none"> ● Configure the IP address and VLAN. (Omitted) ● Enable multicast routing on A and enable the multicast routing protocol on Layer-3 interface (Gi0/1 and VLAN 1). ● Enable IGMP snooping on B and select IVGL mode. ● Configure the range and maximum number of multicast addresses on B.
<p>A</p>	<pre>A# configure terminal A(config)# ip multicast-routing</pre>

	<pre>A(config)# interface GigabitEthernet 0/1 A(config-if-GigabitEthernet 0/1)# ip pim sparse-mode A(config-if-GigabitEthernet 0/1)# exit A(config)# interface vlan 1 A(config-if-VLAN 1)# ip pim sparse-mode A(config-if-VLAN 1)# exit</pre>
B	<pre>B# configure terminal B(config)#ip igmp snooping ivgl B(config)#ip igmp profile 1 B(config-profile)#permit B(config-profile)#rang B(config-profile)#range 225.1.1.1 225.1.255.255 B(config-profile)#exit B(config)#ip igmp profile 2 B(config-profile)#permit B(config-profile)#range 225.1.1.1 225.1.1.255 B(config-profile)#exit B(config)#ip igmp profile 3 B(config-profile)#permit B(config-profile)#range 225.1.2.1 225.1.2.255 B(config-profile)#exit B(config)#ip igmp profile 4 B(config-profile)#permit B(config-profile)#range B(config-profile)#range 225.1.3.1 225.1.3.255 B(config-profile)#exit B(config)#ip igmp snooping l2-entry-limit 100 B(config)#ip igmp snooping vlan 1 filter 1 B(config)#int gigabitEthernet 0/2 FS(config-if-GigabitEthernet 0/0)#ip igmp snooping filter 2 FS(config-if-GigabitEthernet 0/0)#ip igmp snooping max-groups 10 B(config)#int gigabitEthernet 0/3 FS(config-if-GigabitEthernet 0/0)#ip igmp snooping filter 3 FS(config-if-GigabitEthernet 0/0)#ip igmp snooping max-groups 10</pre>

	<pre>B(config)#int gigabitEthernet 0/4 FS(config-if-GigabitEthernet 0/0)#ip igmp snooping filter 4 FS(config-if-GigabitEthernet 0/0)#ip igmp snooping max-groups 10</pre>															
<p>Verification</p>	<ul style="list-style-type: none"> ● Run the show ip igmp snooping interfaces command to display the profile filtering and the maximum number of multicast profiles for a port. ● Run the show ip igmp snooping command to display the maximum number of global multicast groups. 															
<p>B</p>	<pre>B#show ip igmp snooping interfaces</pre> <table border="1"> <thead> <tr> <th>Interface</th> <th>Filter profile number</th> <th>max-group</th> </tr> <tr> <th>-----</th> <th>-----</th> <th>-----</th> </tr> </thead> <tbody> <tr> <td>GigabitEthernet 0/2</td> <td>2</td> <td>10</td> </tr> <tr> <td>GigabitEthernet 0/3</td> <td>3</td> <td>10</td> </tr> <tr> <td>GigabitEthernet 0/4</td> <td>4</td> <td>10</td> </tr> </tbody> </table> <pre> B#show ip igmp snooping IGMP Snooping running mode: IVGL IGMP Snooping L2-entry-limit: 100 Source port check: Disable Source ip check: Disable IGMP Fast-Leave: Disable IGMP Report suppress: Disable IGMP Goble Querier: Disable IGMP Preview: Disable IGMP Tunnel: Disable IGMP Preview group aging time : 60(Seconds) Dynamic Mroute Aging Time : 300(Seconds) Dynamic Host Aging Time : 260(Seconds) </pre>	Interface	Filter profile number	max-group	-----	-----	-----	GigabitEthernet 0/2	2	10	GigabitEthernet 0/3	3	10	GigabitEthernet 0/4	4	10
Interface	Filter profile number	max-group														
-----	-----	-----														
GigabitEthernet 0/2	2	10														
GigabitEthernet 0/3	3	10														
GigabitEthernet 0/4	4	10														

➤ **Configuring Source Port Inspection**

<p>Scenario Figure 9- 10</p>	
	<p>A is the multicast router and is connected directly to multicast Source 1. B is a Layer-2 device and is connected directly to the user host and multicast Source 2. Receiver 1, Receiver 2, and Receiver 3 are connected to VLAN 1. Source 1 sends the multicast address traffic from profile 224.1.1.1, and Source 2 sends the multicast address traffic from profile 225.1.1.1. Receiver 1 can request profiles 224.1.1.1 and 225.1.1.1 respectively. Source port inspection is enabled.</p>
<p>Configuration Steps</p>	<ul style="list-style-type: none"> ● Configure the IP address and VLAN. ● Enable multicast routing on A and enable the multicast routing protocol on Layer-3 interface (Gi0/1 and VLAN 1). ● Enable IGMP snooping on B and select IVGL mode. ● Enable source port inspection on B.
<p>A</p>	<pre>A# configure terminal A(config)# ip multicast-routing A(config)# interface GigabitEthernet 0/1 A(config-if-GigabitEthernet 0/1)# ip pim sparse-mode A(config-if-GigabitEthernet 0/1)# exit A(config)# interface vlan 1 A(config-if-VLAN 1)# ip pim sparse-mode A(config-if-VLAN 1)# exit</pre>
<p>B</p>	<pre>B# configure terminal B(config)#ip igmp snooping ivgl B(config)#ip igmp snooping source-check port</pre>

<p>Verification</p>	<ul style="list-style-type: none"> ● Run the show ip igmp snooping mroute command to check whether Gi0/1 is learned as a router port. ● Check whether Receiver 1 can request the multicast traffic of profile 224.1.1 and cannot request that of profile 225.1.1.1.
<p>B</p>	<pre> Multicast Switching Mroute Port D: DYNAMIC S: STATIC (*, *, 1): VLAN(1) 1 MROUTES: GigabitEthernet 0/1(S) B#show ip igmp snooping IGMP Snooping L2-entry-limit: 100 Source port check: Enable Source ip check: Disable </pre>

Configuring Source IP Inspection

<p>Scenario Figure 9- 11</p>	
	<p>A is the multicast router and is connected directly to multicast Source 1.</p> <p>B is a Layer-2 device and is connected directly to the user host and multicast Source 2.</p> <p>Receiver 1, Receiver 2, and Receiver 3 are connected to VLAN 1.</p> <p>Source 1 sends the multicast address traffic from profiles 10.1.1.1 and 224.1.1.1, Source 2 sends the multicast address traffic from profiles 192.168.1.3 and 225.1.1.1, and Source 3 sends the multicast address traffic from profiles 192.168.1.3 and 226.1.1.1.</p> <p>Receiver 1 can request profiles 224.1.1.1, 225.1.1.1, and 226.1.1.1 respectively.</p> <p>The default IP address for source IP inspection is 10.1.1.1.</p> <p>Configure limit-ipmc and the multicast traffic of profile 225.1.1.1, and set the legal source address as 192.168.1.3.</p>

<p>Configuration Steps</p>	<ul style="list-style-type: none"> ● Configure the IP address and VLAN. ● Enable multicast routing on A and enable the multicast routing protocol on Layer-3 interface (Gi0/1 and VLAN 1). ● Enable IGMP snooping on B and select IVGL mode. ● Enable source port inspection on B.
<p>A</p>	<pre>A# configure terminal A(config)# ip multicast-routing A(config)# interface GigabitEthernet 0/1 A(config-if-GigabitEthernet 0/1)# ip pim sparse-mode A(config-if-GigabitEthernet 0/1)# exit A(config)# interface vlan 1 A(config-if-VLAN 1)# ip pim sparse-mode A(config-if-VLAN 1)# exit</pre>
<p>B</p>	<pre>B# configure terminal B(config)# ip igmp snooping ivgl B(config)# ip igmp snooping source-check default-server 10.1.1.1 B(config)# ip igmp snooping limit-ipmc vlan 1 address 225.1.1.1 server 192.168.1.3</pre>
<p>Verification</p>	<ul style="list-style-type: none"> ● Run the show ip igmp snooping command to check whether source IP inspection is enabled. ● Check whether Receiver 1 can request the multicast traffic of profile 224.1.1 and 225.1.1.1 and cannot request that of profile 226.1.1.1.
<p>B</p>	<pre>B#show ip igmp snooping IGMP Snooping running mode: IVGL IGMP Snooping L2-entry-limit: 65536 Source port check: Disable Source ip check: Enable IGMP Fast-Leave: Disable IGMP Report suppress: Disable IGMP Globle Querier: Disable IGMP Preview: Disable IGMP Tunnel: Disable IGMP Preview group aging time : 60(Seconds) Dynamic Mroute Aging Time : 300(Seconds) Dynamic Host Aging Time : 260(Seconds)</pre>

Common Errors

- Basic IGMP snooping functions are not configured or the configuration is not successful.
- The multicast router port is not learned, leading to failure to receive the multicast traffic.
- The IP address for source IP inspection is inconsistent with the multicast IP address, leading to failure to receive the multicast traffic.

22.4.6 Configuring an IGMP Profile

Configuration Effect

- Create an IGMP filtering profile.

Configuration Steps

↳ Creating a Profile

- (Optional) Create an IGMP filtering profile.

↳ Configuring the Profile Range

- (Optional) Configure the range of multicast profile addresses.

↳ Configuring the Profile Filtering

- (Optional) Configure the filtering mode of profile to **permit** or **deny**.

Verification

- Run the **show running-config** command to check whether the preceding configurations take effect.

Related Commands

↳ Creating a Profile

Command	ip igmp profile <i>profile-number</i>
Parameter	<i>profile-number</i> : Indicates the number of a profile.
Description	
Command Mode	Global configuration mode
Usage Guide	

↳ Configuring the Profile Range

Command	range <i>low-ip-address</i> [<i>high-ip-address</i>]
Parameter	<i>low-ip-address</i> : Specifies the start address.
Description	<i>low-ip-address</i> : Specifies the end address. Only one address is configured by default.
Command Mode	Profile configuration mode
Usage Guide	You can configure multiple addresses. If the IP addresses of different ranges are consecutive, the addresses will be combined.

↳ Configuring the Profile Filtering

Command	deny
Parameter	N/A
Description	
Command Mode	Profile configuration mode
Usage Guide	If the filtering mode of profile is set to deny while the range of multicast profiles is not specified, no profile is to be denied, which means to permit all profiles.

➤ **Configuring the Profile Filtering**

Command	permit
Parameter	N/A
Description	
Command Mode	Profile configuration mode
Usage Guide	If the filtering mode of profile is set to permit while the range of multicast profiles is not specified, no profile is to be permitted, which means to deny all profiles.

Configuration Example

➤ **Creating a Filtering Profile**

Configuration Steps	<ul style="list-style-type: none"> ● Create a filtering profile.
	<pre>B(config)#ip igmp profile 1 B(config-profile)#permit B(config-profile)#range B(config-profile)#range 224.1.1.1 235.1.1.1 B(config-profile)#</pre>
Verification	Run the show running-config command to check whether the configuration is successful.
	<pre>ip igmp profile 1 permit range 224.1.1.1 235.1.1.1 !</pre>

Common Errors

- Basic IGMP snooping functions are not configured or the configuration is not successful.
- The mode of profile is set to **permit** while the range of multicast profiles is not specified, leading to the denial of all profiles.

22.4.7 Configuring IGMP QinQ

Configuration Effect

- Create a multicast entry on the VLAN where IGMP packets are located. Forward IGMP packets on the VLAN where these packets are located, realizing transparent transmission.

Notes

- Basic IGMP snooping functions must be configured.

Configuration Steps

▾ **Configuring QinQ Transparent Transmission**

- If the QinQ interface needs to forward multicast packets on the VLANs where the VIDs of the packets specify, enable QinQ to realize transparent transmission.

Verification

- Run the **show ip igmp snooping** command to check whether the configuration takes effect.

Related Commands

▾ **Configuring QinQ Transparent Transmission**

Command	ip igmp snooping tunnel
Parameter	N/A
Description	
Command Mode	Global configuration mode
Usage Guide	Enable QinQ to realize transparent transmission of IGMP packets.

▾ **Displaying QinQ Configuration**

Command	show ip igmp snooping
Parameter	N/A
Description	
Command Mode	Privileged EXEC mode, global configuration mode, or interface configuration mode
Usage Guide	If QinQ is enabled, the following content is displayed. <div style="background-color: #f0f0f0; padding: 5px; margin-top: 5px;"> IGMP Tunnel: Enable </div>

Configuration Example

▾ **Configuring QinQ Transparent Transmission**

Configuration Steps	<ul style="list-style-type: none"> ● Configure basic IGMP snooping functions. ● Configure QinQ transparent transmission.
	<pre> FS# configure terminal FS(config)# ip igmp snooping tunnel FS(config)# FS(config)# end </pre>

Verification	Run the show ip igmp snooping command to check whether the configuration is successful.
	IGMP Tunnel: Enable

Common Errors

- Basic IGMP snooping functions are not configured or the configuration is not successful.

22.4.8 Configuring an IGMP Querier

Configuration Effect

- Configure the device as an IGMP querier, which will send IGMP Query packets periodically and collect user demanding information.

Notes

- Basic IGMP snooping functions must be configured.

Configuration Steps

↘ Enabling the Querier Function

- (Optional) Enable IGMP querier function globally or for a specified VLAN.
- (Optional) Disable the IGMP querier function for a specified VLAN.

↘ Configuring the Source IP Address of a Querier

- (Optional) You can configure the source IP address of a Query packet sent by the querier based on VLANs.
- After a querier is enabled, a source IP address must be specified for the querier; otherwise, the configuration will not take effect.

↘ Configuring the Maximum Response Time of a Query Packet

- (Optional) Adjust the maximum response time carried by an IGMP Query packet. As IGMPv1 does not support the carrying of maximum response time by a Query packet, this configuration does not take effect when the querier is running IGMPv1.

↘ Configuring the Query Interval of a Querier

- (Optional) Adjust the interval of the IGMP querier for sending query packets.

↘ Configuring the Aging Timer of a Querier

- (Optional) Configure the aging timer of other IGMP queriers on the network.

↘ Specifying the IGMP Version for a Querier

- (Optional) Specify the IGMP version for a querier (IGMPv2 by default).

Verification

- Run the **show ip igmp snooping querier detail** command to check whether the configuration takes effect.

Related Commands

↘ Enabling the IGMP Querier Function

Command	ip igmp snooping [vlan vid] querier
Parameter	vlan vid: Specifies a VLAN. This configuration applies to all VLANs by default.
Description	
Command Mode	Global configuration mode
Usage Guide	IGMP querier for a specified VLAN will take effect only after global IGMP querier is enabled. If global IGMP querier is disabled, IGMP querier for all the VLANs will be disabled.

✚ Configuring the Source IP Address of a Querier

Command	ip igmp snooping [vlan vid] querier address a.b.c.d
Parameter	vlan vid: Specifies a VLAN. This configuration applies to all VLANs by default.
Description	a.b.c.d: Indicates the source IP address.
Command Mode	Global configuration mode
Usage Guide	After a querier is enabled, a source IP address must be specified for the querier; otherwise, the configuration will not take effect. If the source IP address is specified by a VLAN, the address will be used preferentially.

✚ Configuring the Maximum Response Time of a Querier

Command	ip igmp snooping [vlan vid] querier max-response-time seconds
Parameter	vlan vid: Specifies a VLAN. This configuration applies to all VLANs by default.
Description	seconds: Indicates the maximum response time. in the unit of seconds. The value ranges from 1 to 25.
Command Mode	Global configuration mode
Usage Guide	If the query interval is specified by a VLAN, the value will be used preferentially.

✚ Configuring the Query Interval of a Querier

Command	ip igmp snooping [vlan vid] querier address a.b.c.d
Parameter	vlan vid: Specifies a VLAN. This configuration applies to all VLANs by default.
Description	seconds: Indicates the query interval in the unit of seconds. The value ranges from 1 to 18,000.
Command Mode	Global configuration mode
Usage Guide	If the query interval is specified by a VLAN, the value will be used preferentially.

✚ Configuring the Aging Timer of a Querier

Command	ip igmp snooping [vlan vid] querier timer expiry seconds
Parameter	vlan vid: Specifies a VLAN. This configuration applies to all VLANs by default.
Description	seconds: Indicates the timeout time in the unit of seconds. The value ranges from 60 to 300.
Command Mode	Global configuration mode
Usage Guide	A device may fail to be elected as the querier even when its querier function is enabled. If a device that fails to be elected does not receive the Query packet sent by the querier in the aging time, the querier in use is considered as expired, and a new round of election will be raised.

	If the aging time is specified by a VLAN, the value will be used preferentially.
--	--

➤ **Specifying the IGMP Version for a Querier**

Command	ip igmp snooping [vlan vid] querier version 1
Parameter Description	vlan vid: Specifies a VLAN. This configuration applies to all VLANs by default.
Command Mode	Global configuration mode
Usage Guide	A querier can be run in IGMPv1 and IGMPv2 (IGMPv2 by default). You can also run a command to configure the version to IGMPv1. If the IGMP version for a querier is specified by a VLAN, the version will be used preferentially.

➤ **Displaying the IGMP Querier Configuration**

Command	show ip igmp snooping querier detail
Parameter Description	N/A
Command Mode	Privileged EXEC mode, global configuration mode, or interface configuration mode
Usage Guide	<p>If QinQ is enabled, the following content is displayed.</p> <pre> FS(config)#show ip igmp snooping querier detail Vlan IP Address IGMP Version Port ----- Global IGMP switch querier status ----- admin state : Enable admin version : 2 source IP address : 1.1.1.1 query-interval (sec) : 60 max-response-time (sec) : 10 querier-timeout (sec) : 125 Vlan 1: IGMP switch querier status ----- admin state : Disable admin version : 2 source IP address : 1.1.1.1 query-interval (sec) : 60 </pre>

max-response-time (sec)	: 10
querier-timeout (sec)	: 125
operational state	: Disable
operational version	: 2

Configuration Example

▾ **Enabling the IGMP Querier Function**

<p>Scenario Figure 9- 12</p>	
	<p>In the scenario without Layer-3 multicast equipment, the multicast traffic can be forwarded only on the Layer-2 network. A acts as a Layer-2 device to connect to the multicast source and receiver.</p>
<p>Configuration Steps</p>	<ul style="list-style-type: none"> ● Enable global IGMP snooping on A in IVGL mode. ● Enable IGMP querier for VLAN 1 on A.
<p>A</p>	<pre>A(config)#ip igmp snooping ivgl A(config)#ip igmp snooping querier A(config)#ip igmp snooping querier address 10.1.1.1 A(config)#ip igmp snooping vlan 1 querier</pre>
<p>Verification</p>	<p>Run the show ip igmp snooping querier command to check whether the querier of VLAN 1 takes effect.</p>
<p>A</p>	<pre>A(config)#show ip igmp snooping querier Vlan IP Address IGMP Version Port ----- 1 10.1.1.1 2 switch A(config)#show ip igmp snooping querier vlan 1</pre>

```
Vlan 1:  IGMP switch querier status
-----
elected querier is 10.1.1.1      (this switch querier)
-----
admin state           : Enable
admin version        : 2
source IP address    : 10.1.1.1
query-interval (sec) : 60
max-response-time (sec) : 10
querier-timeout (sec) : 125
operational state    : Querier
operational version   : 2
```

Common Errors

- The source IP address is not configured for the querier and the querier does not take effect.

22.5 Monitoring

Clearing

Running the **clear** commands may lose vital information and thus interrupt services.

Description	Command
Clears the statistics on IGMP snooping.	clear ip igmp snooping statistics
Clears the dynamic router ports and member ports.	clear ip igmp snooping gda-table

Displaying

Description	Command
Displays basic IGMP snooping configurations.	show ip igmp snooping [vlan <i>vlan-id</i>]
Displays the statistics on IGMP snooping.	show ip igmp snooping statistics [vlan <i>vlan-id</i>]
Displays the router ports.	show ip igmp snooping mrouter
Displays the IGMP snooping entries.	show ip igmp snooping gda-table
Displays the profile.	show ip igmp profile [<i>profile-number</i>]
Displays the IGMP snooping configurations on an interface.	show ip igmp snooping interface <i>interface-name</i>
Displays the IGMP querier.	show ip igmp snooping querier [detail]
Displays user information.	show ip igmp snooping user-info

Debugging

System resources are occupied when debugging information is output. Therefore, disable debugging immediately after use.

Description	Command
Debugs all IGMP Snooping functions.	debug igmp-snp
Debugs the IGMP snooping events.	debug igmp-snp event
Debugs the IGMP snooping packets.	debug igmp-snp packet
Debugs the communications between IGMP snooping and MSF.	debug igmp-snp msf
Debugs the IGMP snooping alarms.	debug igmp-snp warning

23 Configuring MLD Snooping

23.1 Overview

Multicast Listener Discovery (MLD) Snooping is used to control and manage the forwarding behaviors of IPv6 multicast packets at Layer 2.

The device running MLD Snooping analyzes MLD packets received by a port to create a mapping between the port and the MAC multicast address and forwards IPv6 multicast data at Layer 2 based on the mapping. When MLD Snooping is disabled, IPv6 multicast data packets are broadcasted at Layer 2. When MLD Snooping is enabled, multicast data packets of a known IPv6 multicast group are forwarded to a specified receiver at Layer 2 instead of being broadcasted at Layer 2.

Protocols and Standards

RFC4541: Considerations for Internet Group Management Protocol (IGMP) and Multicast Listener Discovery (MLD) Snooping Switches

23.1.1 Two Types of MLD Snooping Ports

As shown in Figure 10- 1, the Layer-3 multicast device is connected to the multicast source. MLD Snooping is enabled on the access device. Host A and Host B are receivers (that is, members of the IPv6 multicast group).

Figure 10- 1 Two Types of MLD Snooping Ports

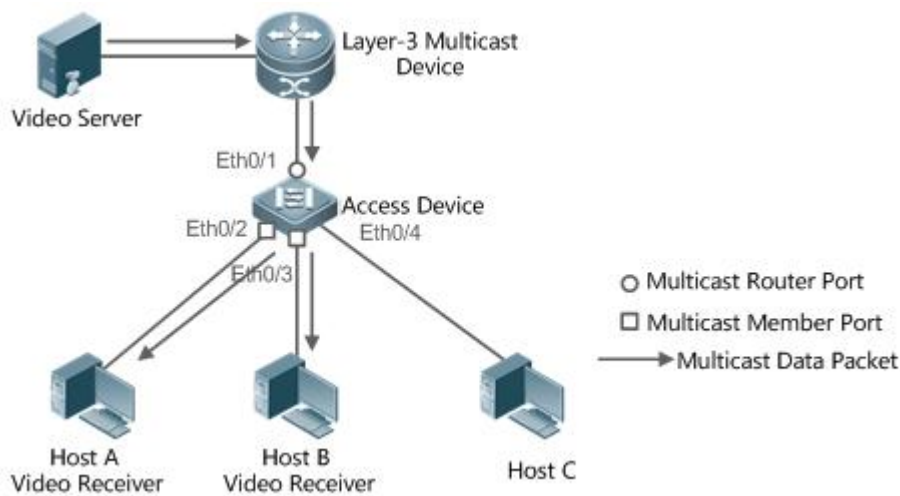

- Multicast router port: Indicates the port on the access device for connecting to the Layer-3 multicast device, for example, Port Eth0/1 of the access device.

- Member port: Is short for IPv6 multicast group member port, also called listener port, and indicates the port on the access device for connecting to an IPv6 multicast group member, for example, Port Eth0/2 and Port Eth0/3 on the access device.

23.1.2 Work Mode of MLD Snooping

- DISABLE mode: MLD Snooping does not take effect in this mode. That is, the Layer-2 multicast device does not "snoop" MLD packets between the host and the router, and multicast streams are broadcasted within VLANs.
- Independent VLAN Group Learn (IVGL) mode: In this mode, multicast streams between VLANs are mutually independent. A host can request only the multicast router port in the same VLAN as the host to receive multicast packets, and can forward the received multicast data packets of any VLAN only to the member port and multicast router port in the same VLAN as the host.
- Shared VLAN Group Learn (SVGL) mode: In this mode, hosts of VLANs share the same multicast stream. A host in one VLAN can request multicast streams of another VLAN. When a shared VLAN is specified, only the multicast data streams of this VLAN can be forwarded to hosts of other VLANs. Multicast data streams of a shared VLAN, can be forwarded to the member ports of this multicast address, even though some member ports do not belong to the shared VLAN. In SVGL mode, MLD profiles must be used to allocate a batch of multicast address ranges to SVGL. Within the multicast address ranges, member ports in the multicast forwarding entries support trans-VLAN packet forwarding. By default, all the group ranges are not within the SVGL application ranges, and all the multicast packets are discarded.
- IVGL-SVGL mode: In this mode, IVGL and SVGL coexist. You can use MLD profiles to allocate a batch of multicast address ranges to SVGL. Within the multicast address ranges, member ports in the multicast forwarding entries support trans-VLAN packet forwarding. Member ports in the multicast forward entries corresponding to other multicast address ranges must belong to the same VLAN.

23.1.3 Working Principle of MLD Snooping

The device running MLD Snooping processes different MLD packets as follows:

MLD QUERY

The Layer-3 multicast device regularly sends an MLD General Query packet to all hosts and routers (with the address of FF02::1) in the local network segment, to query the IPv6 multicast group members in this network segment. When receiving the MLD General Query packet, the device running MLD Snooping forwards the packet all ports in the VLAN except the one receiving the packet, and processes the port receiving the packet as follows:

- If the port is already in the router multicast port list, its aging timer is reset.
- If the port is not contained in the router multicast port list, the port is added to the router multicast port list and its aging timer is started.
- Each time the Layer-2 multicast device receives an MLD General Query packet, it starts the aging timer for each member port, and updates the timer time to the configured maximum response time of MLD query packet. When the aging timer time of a port is reduced to 0, it is deemed that no member receives multicast streams through this port, and therefore, the Layer-2 multicast device deletes the port from the MLD Snooping forwarding table.
- Each time the Layer 2 multicast device receives a MLD Group-Specific Query packet, it starts the aging timer for each member port in the specific group, and updates the timer time to the configured maximum response time of MLD query packet. When the aging timer time of a port is reduced to 0, it is deemed that no member receives multicast streams through this port, and therefore, the Layer-2 multicast device deletes the port from the MLD Snooping forwarding table.

- When the Layer-2 multicast device receives a MLD Group-Specific Query packet, it no longer updates the preceding two types of timers.

MLD REPORT

In either of the following cases, the host sends an MLD Membership Report packet to the MLD querier.

- After receiving an MLD query (General Query or Group-Specific Query) packet, an IPv6 multicast group member host responds with an MLD Membership Report packet.
- If a host needs to join an IPv6 multicast group, it actively sends an MLD Membership Report packet to MLD querier to request to join this IPv6 multicast group.

When receiving an MLD Membership Report packet, the device running MLD Snooping forwards it to all multicast router ports in the VLAN, retrieves, from the packet, the address of the IPv6 multicast group that the host needs to join, and processes the port receiving the packet as follows:

- If there is no forwarding entry corresponding to the IPv6 multicast group, the forwarding entry is created, the port is added to the egress port list as a dynamic member port, and its aging timer is started.
- If there is a forwarding entry corresponding to the IPv6 multicast group but the port is not contained in the egress port list, the port is added to the egress port list as a dynamic member port, and its aging timer is started.
- If there is a forwarding entry corresponding to the IPv6 multicast group and dynamic member port is contained in the egress port list, its aging timer is reset.

MLD LEAVE

When a host leaves an IPv6 multicast group, it sends an MLD Leave packet (with the address of FF02::2) to notify the multicast router that it has left the IPv6 multicast group. When receiving an MLD Leave packet from a member port, the device running MLD Snooping directly forwards it to the multicast router port. If the fast leave function is enabled, the device directly deletes the port from the forwarding port list of the relevant multicast group.

23.1.4 Source Port Check

The source port check function of MLD Snooping improves the network security.

This function strictly limits the ingress ports of MLD multicast streams. When this function is disabled, multicast streams from any port are valid and the Layer-2 multicast device forwards them to registered member ports according to the forwarding list of MLD Snooping. When this function is enabled, multicast streams only from the multicast router ports are valid and the Layer-2 multicast device forwards them to registered ports. Multicast data streams from non-multicast router ports are invalid and discarded.

23.2 Applications

Application	Description
MLD Snooping SVGL Trans-VLAN Multicast On demand	MLD Snooping works in SVGL mode
Source Port Filtering	Multicast streams only from multicast router ports are received.

23.2.1 MLD Snooping SVGL Trans-VLAN Multicast On demand

Scenario

As shown in Figure 10- 2, Host A of VLAN 3 and Host B of VLAN 4 order a video. The video streams are in VLAN 2.

- Enable the SVGL mode on the access device and set a shared VLAN 2.

Figure 10- 2

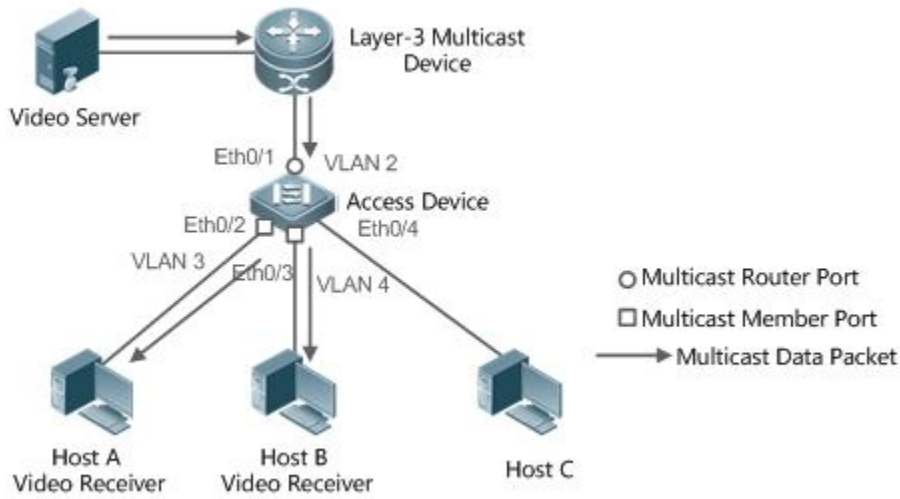

Remarks	VLAN 2 is a shared VLAN. VLAN 3 and VLAN 4 are the VLANs through which the video on-demand service is output.
----------------	--

Deployment

- Enable the Layer-3 multicast protocol on the Layer-3 multicast device.
- Enable the SVGL mode on the Layer-2 device.

23.2.2Source Port Filtering

Scenario

As shown in Figure 10- 3, when the source port check function is configured, video streams can be received only from the source multicast router port. Multicast video streams from other ports are invalid and discarded. Note that when the source port check function is configured, there shall be at least one multicast router port. Otherwise, packet filtering is not performed on the multicast router port even though the source port filtering is enabled. When the source port check function is not configured, multicast video streams from all ports are received by default.

- Enable the IVGL mode on the access device.

Figure 10- 3

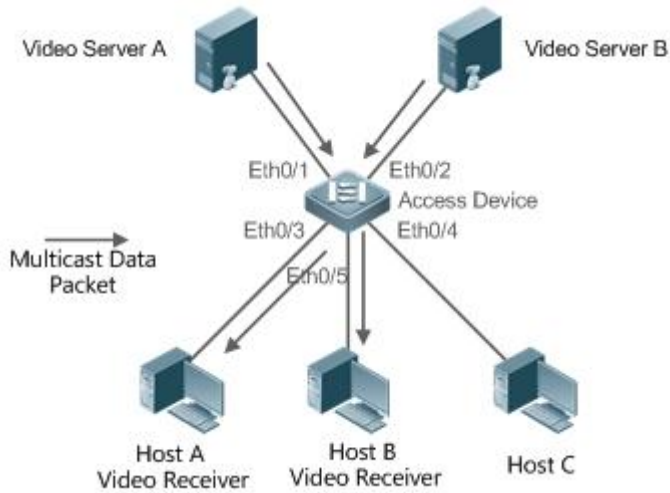

Remarks	<p>Port Eth0/1 is a multicast router port and Port Eth0/2 is a non-multicast router port.</p> <p>Video servers send same multicast video streams.</p> <p>Hosts A and B can receive multicast streams only from Video Server A.</p>
----------------	--

Deployment

- Enable the source port check function and configure a static multicast router port.
- Enable the IVGL mode on the Layer-2 device.

23.3Features

Basic Concepts

📌 **Multicast Router Port and Member Port**

Multicast router ports are classified into dynamic multicast router ports and static multicast router ports. If MLD Snooping is enabled, when the dynamic multicast router port learning function is enabled on a port, after receiving an MLD Query or PIMv6-Hello packet, the port learns the dynamic multicast router port and starts the aging timer of the dynamic multicast router port. A static multicast router port can be added by configuring the **ipv6 mld snooping vlan mrouter** command.

Member ports are classified into dynamic member ports and static member ports. If MLD Snooping is enabled, after receiving an MLD Report packet, a port learns the dynamic member router port and starts the aging timer of the dynamic member port. A static member port can be added by configuring the **ipv6 mld snooping vlan static interface** command.

📌 **Fast Leave and Packet Suppression**

When the fast leave function is enabled, a port is directly deleted after receiving an MLD Leave packet. The fast leave function is applicable only to scenarios in which only one user is connected to a port, and helps save the bandwidth. When multiple users are connected to a port, if the fast leave function is enabled, other users wanting to receive packets fail to receive any packets.

When the packet suppression function is enabled, only the first MLD Report packet is forwarded within one query period.

Overview

Feature	Description
---------	-------------

Globally Enabling MLD Snooping	Globally enables MLD Snooping and configures the work mode.
VLAN-based MLD Snooping	Enables or disables MLD Snooping for a single VLAN when MLD Snooping is globally enabled.
Aging Time of Multicast Router Ports	Adjusts the aging time of dynamic multicast router ports. The default aging time is 300s.
Dynamic Multicast Router Port Learning	After receiving an MLD query packet or a PIMv6 Hello packet, the port is learnt as a dynamic multicast router port.
Fast Leave of Multicast Group Member Ports	A member port can be quickly deleted, instead of being aged and deleted after the query interval of a Group-Specific Query expires.
MLD Report Packet Suppression	Only the first Report packet is processed within one query period, reducing the work load of the module.
Source Port Check	Multicast streams received only from a multicast router port can be forwarded. Packets received from non-multicast router ports cannot be forwarded.
Port-based Specific Multicast Group Filtering	Only multicast group packets that meet the filter conditions can be received.
Maximum Number of Multicast Groups Supported by a Port	Limits the maximum number of multicast groups that a port can join.

23.3.1 Globally Enabling MLD Snooping

Globally enable MLD Snooping and configure the work mode. Multicast forwarding entries can be learnt and multicast streams are forwarded to a specified port.

Working Principle

Enable MLD Snooping. When an MLD Report packet with the time to live (TTL) of 1 is received, a multicast forwarding entry is created and the forwarding egress is this port.

↳ Learning a Dynamic Member Port

After a valid MLD Report packet is received, a dynamic member port is learnt and a forwarding entry is generated. The forwarding egress of this entry is the member port.

↳ Coordinating Parameters

Configure the MLD Report packet suppression function.

Related Configuration

Configure the MLD Report packet suppression function so that only the first Report is processed within one query period, thereby reducing the number of packets in the network.

23.3.2 VLAN-based MLD Snooping

Enable or disable MLD Snooping for a single VLAN. By default, if MLD Snooping is globally enabled, the MLD Snooping function of each VLAN is enabled.

Related Configuration

Globally configure MLD Snooping. Then configure MLD Snooping for a single VLAN.

23.3.3 Aging Time of Multicast Router Ports

Multicast router ports are classified into dynamic multicast router ports and static multicast router ports. By default, the aging time of a dynamic multicast router port is 300s. Static multicast router ports are not aged.

Related Configuration

Ability of learning from dynamic multicast router port learning function

23.3.4 Dynamic Multicast Router Port Learning

By default, all ports support the dynamic multicast router port learning function.

Working Principle

When a port supports the dynamic multicast router port learning function, after receiving an MLD query packet or a PIMv6 Hello packet, the port is learnt as a dynamic multicast router port.

Related Configuration

Configure a port as a static multicast router port.

23.3.5 Aging Time of Dynamic Member Ports

Member ports are classified into dynamic member ports and static member ports. By default, the aging time of a dynamic member port is 260s. Static member ports are not aged.

23.3.6 Fast Leave of Multicast Group Member Ports

By default, the fast leave function of multicast group member ports are disabled. If the fast leave function is enabled, the port is directly deleted after receiving a done packet.

23.3.7 MLD Report Packet Suppression

By default, the MLD report packet suppression function is disabled. If the function is enabled, only the first Report packet is processed within one query interval, thereby reducing the number of packets in the network.

23.3.8 Source Port Check

The source port check function is disabled by default.

Working Principle

When the source port check function is enabled, packets only from multicast router ports are valid and packets from non-multicast router ports are invalid.

Related Configuration

Configure a port as a static multicast router port.

23.3.9 Port-based Specific Multicast Group Filtering

Under certain circumstances, you may use the port filtering function to control a port to forward multicast packets only of a certain range.

23.3.10 Maximum Number of Multicast Groups Supported by a Port

The maximum number of multicast groups that a port is allowed to join can control the maximum number of multicast groups supported by the port.

23.4 Configuration

Configuration	Description and Command	
Configuring Basic Functions of MLD Snooping	ipv6 mld snooping	Enables MLD Snooping and specifies the work mode.
	ipv6 mld snooping vlan <i>vlan-id</i> mrouter interface <i>interface-id</i>	Configures the static multicast router port.
	ipv6 mld snooping vlan <i>vlan-id</i> static <i>ip-addr</i> interface <i>interface-id</i>	Configures a static member port.
	ipv6 mld profile <i>profile-num</i>	Configures a profile.
	ipv6 mld snooping source-check port	Configures source port check.
	ipv6 mld snooping filter <i>profile-num</i>	Configures multicast group filtering for a port.
	ipv6 mld snooping max-groups <i>num</i>	Configures the maximum number of multicast groups that a port can join.

23.4.1 Configuring Basic Functions of MLD Snooping

Configuration Effect

- Enable MLD Snooping and configure the work mode.

Notes

- Enable MLD Snooping and set the work mode to SVGL. The MLD Snooping SVGL mode cannot coexist with IPv4 or IPv6 Layer-3 multicasting.
- When the work mode is SVGL or IVGL-SVGL, a profile must be associated to specify the multicast group range in which the SVGL mode applies.

Configuration Steps

➤ Enabling IPv6 MLD Snooping

- Mandatory.

Verification

Run the **show ipv6 mld snooping** command to check whether MLD Snooping is enabled.

- Check whether the device can create correct multicast forwarding entries.

Related Commands

↘ Enabling IPv6 MLD Snooping

Command	ipv6 mld snooping <i>mode</i>
Parameter	mode: Specifies the work mode.
Description	
Command	Global configuration mode
Mode	
Usage Guide	N/A

↘ Configuring a Profile

Command	ipv6 mld profile <i>profile-num</i>
Parameter	<i>profile-num:</i> Indicates the profile number.
Description	
Command	Global configuration mode
Mode	
Usage Guide	Run this command to configure a profile and enter the profile configuration mode.

↘ Configuring a Static Multicast Router Port

Command	ipv6 mld snooping vlan <i>vlan-id</i> mrouter interface <i>interface-id</i>
Parameter	vlan-id: Indicates the VLAN ID.
Description	<i>interface-id:</i> Indicates interface changes.
Command	Global configuration mode
Mode	
Usage Guide	N/A

↘ Configuring a Static Member Port

Command	ipv6 mld snooping vlan <i>vlan-id</i> static ip-addr interface <i>interface-id</i>
Parameter	vlan-id: Indicates the VLAN ID.
Description	<i>ip-addr:</i> Indicates the group address. <i>interface-id:</i> Indicates interface changes.
Command	Global configuration mode
Mode	
Usage Guide	N/A

↘ Configuring Source Port Check

Command	ipv6 mld snooping source-check port
Parameter	
Description	
Command	Global configuration mode
Mode	
Usage Guide	-

↘ Configuring Port-based Multicast Group Filtering

Command	ipv6 mld snooping filter <i>profile-num</i>
----------------	--

Parameter	<i>profile-num</i> : Indicates the profile number.
Description	
Command	Interface configuration port
Mode	
Usage Guide	N/A

↘ Configuring the Maximum Number of Multicast Groups Supported by a Port

Command	ipv6 mld snooping max-groups num
Parameter	<i>num</i> : Indicates the number of groups.
Description	
Command	Interface configuration port
Mode	
Usage Guide	N/A

↘ Configuring Report Packet Suppression

Command	ipv6 mld snooping suppression enable
Parameter	N/A
Description	
Command	Global configuration mode
Mode	
Usage Guide	<p>When the Report packet suppression function is enabled, only the first Report packet of a specific VLAN and group is forwarded to a multicast router port within one query interval. The subsequent Report packets are forwarded to the multicast router port, so as to reduce the number of packets in the network.</p> <p>This function can only suppress the Report packets of MLDv1. It is invalid on the Report packets of MLDv2.</p>

↘ Configuring Port Fast Leave

Command	ipv6 mld snooping fast-leave enable
Parameter	N/A
Description	
Command	Global configuration mode
Mode	
Usage Guide	<p>When the port fast leave function is enabled, after receiving a Leave packet, the port is directly deleted from the member ports in the corresponding forwarding entries. Later, when receiving a relevant Group-Specific Query packet, the device does not forward the packet to this port. The Leaver packet includes the Leave packet of MLDv1, include type of MLDv2, and Report packet containing no source address.</p> <p>This function is applicable only to scenarios in which only one user is connected to a port, and helps save bandwidth and resources.</p>

↘ Configuring Dynamic Multicast Router Port Learning

Command	ipv6 mld snooping [vlan vid] mrouter learn
Parameter	<i>vlan-id</i> : Specifies a VLAN ID. This function is applicable to all VLANs by default.
Description	
Command	Global configuration mode
Mode	

Usage Guide	A multicast router port is a port that directly connects an MLD Snooping-enabled multicast device to a neighbor multicast device in which a multicast routing protocol is enabled. By default, when the dynamic multicast router port learning function is enabled, the device automatically listens to the MLD Query/PIM Hello packet and dynamically identifies a multicast router port.
--------------------	--

↘ Configuring Aging Time of Dynamic Multicast Router Ports

Command	ipv6 mld snooping dyn-mr-aging-time <i>seconds</i>
Parameter Description	seconds: Indicates the aging time of dynamic multicast router ports. The unit is second and the value ranges from 1 to 3,600.
Command Mode	Global configuration mode
Usage Guide	If a dynamic multicast router port does not receive an MLD General Query packet or a PIM Hello packet before the timeout of its aging time, the device deletes the port from the multicast router port list. When the dynamic multicast router learning function is enabled, you can use this command to adjust the aging time of dynamic multicast router ports. If the aging time is too short, a multicast router port may be added and deleted frequently.

↘ Configuring Aging Time of Dynamic Member Ports

Command	ipv6 mld snooping host-aging-time <i>seconds</i>
Parameter Description	seconds: Indicates the aging time.
Command Mode	Global configuration mode
Usage Guide	The aging time of a dynamic member port refers to the aging time set when a dynamic member port of a device receives from the host an MLD packet of joining a certain IPv6 multicast group. After receiving an MLD Join packet from a dynamic member port, the device resets the aging timer of the dynamic member port and sets the timer time to host-aging-time. If the timer times out, it is deemed that no user host receives multicast packets through this port, and then the multicast device deletes the port from the MLD Snooping member port list. After this command is configured, the aging timer value of dynamic member ports when MLD Join packets are received subsequently is host-aging-time. The aging time takes effect immediately after configuration and the timers of started member ports are updated.

↘ Configuring Response Time of Query Packets

Command	ipv6 mld snooping query-max-response-time <i>seconds</i>
Parameter Description	seconds: Indicates the response time.
Command Mode	Global configuration mode
Usage Guide	After receiving an MLD General Query packet from a port, the multicast device resets the aging timers of all dynamic member ports and sets the timer time to query-max-response-time. If the timer times out, it is deemed that no user host receives multicast packets through the port, and then the multicast device deletes the port from the MLD Snooping member port list. After receiving an MLD Group-Specific Query packet from a port, the multicast device resets the aging timers of all dynamic member ports in the specific group and sets the timer time to query-max-response-time. If the timer times

	<p>out, it is deemed that no user host receives multicast packets through the port, and then the multicast device deletes the port from the MLD Snooping member port list.</p> <p>The configuration takes effect when the a query packet is received next time, and the configuration of currently started timers are not updated. For Group-Specific Query packets of MLDv2, timers are not updated.</p>
--	---

📌 **Checking Multicast Router Ports**

Command	show ipv6 mld snooping mroute
Parameter Description	N/A
Command Mode	Privileged EXEC mode, global configuration mode, interface configuration mode
Usage Guide	<p>If a multicast router port is successfully configured, the mark "S" is shown in the interface information displayed. For example:</p> <pre>FS(config)#show ipv6 mld snooping mrouter Multicast Switching Mroute Port D: DYNAMIC S: STATIC (*, *, 1): VLAN(1) 1 MROUTES: GigabitEthernet 0/1(S)</pre>

📌 **Checking Dynamic Multicast Router Port Learning**

Command	show ipv6 mld snooping
Parameter Description	N/A
Command Mode	Privileged EXEC mode, global configuration mode, interface configuration mode
Usage Guide	<p>Run the show ip igmp snooping command to check the aging time and learning status of dynamic multicast router ports.</p> <pre>Dynamic Mroute Aging Time : 300(Seconds) Multicast router learning mode: Enable</pre>

📌 **Checking Member Ports**

Command	show ipv6 mld snooping gda-table
Parameter Description	-
Command Mode	Privileged EXEC mode, global configuration mode, interface configuration mode
Usage Guide	<p>If a member port is successfully configured, the mark "S" is shown in the interface information displayed. For example:</p>

```
FS(config)#show ipv6 mld snooping gda-table
Multicast Switching Cache Table
D: DYNAMIC
S: STATIC
M: MROUTE
(*, FF15::100, 1):
VLAN(1) 2 OPORTS:
GigabitEthernet 3/7(S)
```

↘ Checking Other Parameters

Command	show ipv6 mld snooping
Parameter	-
Description	
Command Mode	Privileged EXEC mode, global configuration mode, interface configuration mode
Usage Guide	Run the show ipv6 mld snooping command to check the aging time of multicast router ports, aging time of dynamic member ports, response time of query packet, and Report packet suppression, and fast leave parameters. <pre>MLD-snooping mode: IVGL Source port check: Disable MLD Fast-Leave: Disable MLD Report suppress: Disable Query Max Response Time: 10 (Seconds) Dynamic Mroute Aging Time: 300(Seconds) Dynamic Host Aging Time: 260(Seconds)</pre>

23.5 Monitoring

Clearing

Running the **clear** commands may lose vital information and thus interrupt services.

Description	Command
Clears MLD Snooping multicast forwarding entries.	clear ipv6 mld snooping gda-table
Clears MLD Snooping statistics.	clear ipv6 mld snooping statistics

Displaying

Description	Command
Displays the current MLD Snooping mode.	show ipv6 mld snooping

Displays MLD Snooping forwarding entries.	show ipv6 mld snooping gda-table
Displays MLD Snooping statistics.	show ipv6 mld snooping statistics
Displays MLD Snooping multicast router ports.	show ipv6 mld snooping mrouter
Displays MLD Snooping interface information, interface filtering profiles and maximum number of groups that a port can join.	show ipv6 mld snooping interfaces <i>interface-type interface-name</i>
Displays multicast information about a single VLAN, on which MLD Snooping is configured.	show ipv6 mld snooping vlan <i>vid</i>
Displays an MLD Profile.	show ipv6 mld profile <i>profile-number</i>

Security Configuration

1. Configuring AAA
2. Configuring RADIUS
3. Configuring TACACS+
4. Configuring SCC
5. Configuring Password Policy
6. Configuring Storm Control
7. Configuring SSH
8. Configuring URPF
9. Configuring CPP
10. Configuring DHCP Snooping
11. Configuring NFPP
12. Configuring Security-log

1 Configuring AAA

1.1 Overview

Authentication, authorization, and accounting (AAA) provides a unified framework for configuring the authentication, authorization, and accounting services. FS Networks devices support the AAA application.

AAA provides the following services in a modular way:

Authentication: Refers to the verification of user identities for network access and network services. Authentication is classified into local authentication and authentication through Remote Authentication Dial In User Service (RADIUS) and Terminal Access Controller Access Control System+ (TACACS+).

Authorization: Refers to the granting of specific network services to users according to a series of defined attribute-value (AV) pairs. The pairs describe what operations users are authorized to perform. AV pairs are stored on network access servers (NASs) or remote authentication servers.

Accounting: Refers to the tracking of the resource consumption of users. When accounting is enabled, NASs collect statistics on the network resource usage of users and send them in AV pairs to authentication servers. The records will be stored on authentication servers, and can be read and analyzed by dedicated software to realize the accounting, statistics, and tracking of network resource usage.

AAA is the most fundamental method of access control. FS Networks also provides other simple access control functions, such as local username authentication and online password authentication. Compared to them, AAA offers higher level of network security.

AAA has the following advantages:

- Robust flexibility and controllability
- Scalability
- Standards-compliant authentication
- Multiple standby systems

1.2 Applications

Application	Description
Configuring AAA in a Single-Domain Environment	AAA is performed for all the users in one domain.
Configuring AAA in a Multi-Domain Environment	AAA is performed for the users in different domains by using different methods.

1.2.1 Configuring AAA in a Single-Domain Environment

Scenario

In the network scenario shown in Figure 1-1, the following application requirements must be satisfied to improve the security management on the NAS:

53. To facilitate account management and avoid information disclosure, each administrator has an individual account with different username and password.

- 54. Users must pass identity authentication before accessing the NAS. The authentication can be in local or centralized mode. It is recommended to combine the two modes, with centralized mode as active and local mode as standby. As a result, users must undergo authentication by the RADIUS server first. If the RADIUS server does not respond, it turns to local authentication.
- 55. During the authentication process, users can be classified and limited to access different NASs.
- 56. Permission management: Users managed are classified into Super User and Common User. Super users have the rights to view and configure the NAS, and common users are only able to view NAS configuration.
- 57. The AAA records of users are stored on servers and can be viewed and referenced for auditing. (The TACACS+ server in this example performs the accounting.)

Figure 1- 1

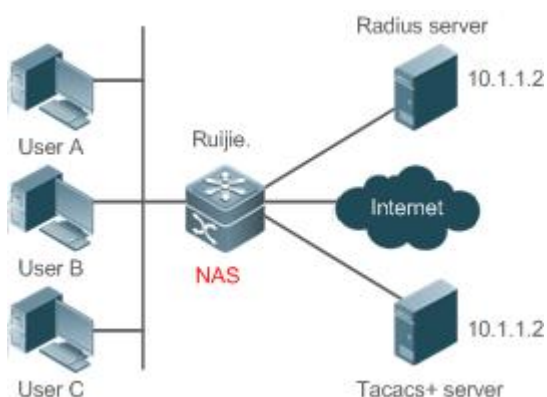

Remarks	<p>User A, User B, and User C are connected to the NAS in wired or wireless way.</p> <p>The NAS is an access or convergence switch.</p> <p>The RADIUS server can be the Windows 2000/2003 Server (IAS), UNIX system component, and dedicated server software provided by a vendor.</p> <p>The TACACS+ server can be the dedicated server software provided by a vendor.</p>
----------------	---

Deployment

- Enable AAA on the NAS.
- Configure an authentication server on the NAS.
- Configure local users on the NAS.
- Configure the authentication service on the NAS.
- Configure the authorization service on the NAS.
- Configure the accounting service on the NAS.

1.2.2Configuring AAA in a Multi-Domain Environment

Scenario

Configure the domain-based AAA service on the NAS.

- A user can log in by entering the username PC1@FS.net or PC2@FS.com.cn and correct password on an 802.1X client.
- Permission management: Users managed are classified into Super User and Common User. Super users have the rights to view and configure the NAS, and common users are only able to view NAS configuration.

- The AAA records of users are stored on servers and can be viewed and referenced for auditing.

Figure 1- 2

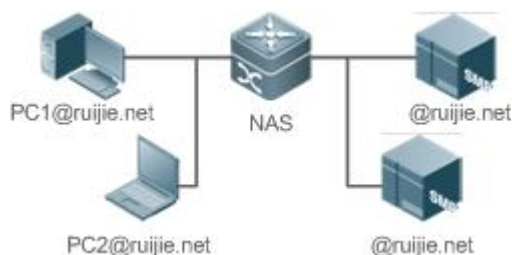

Remarks	<p>The clients with the usernames PC1@FS.net and PC2@FS.com.cn are connected to the NAS in wired or wireless way.</p> <p>The NAS is an access or convergence switch.</p> <p>The Security Accounts Manager (SAM) server is a universal RADIUS server provided by FS Networks.</p>
----------------	--

Deployment

- Enable AAA on the NAS.
- Configure an authentication server on the NAS.
- Configure local users on the NAS.
- Define an AAA method list on the NAS.
- Enable domain-based AAA on the NAS.
- Create domains and AV sets on the NAS.

1.3 Features

Basic Concepts

Local Authentication and Remote Server Authentication

Local authentication is the process where the entered passwords are verified by the database on the NAS.

Remote server authentication is the process where the entered passwords are checked by the database on a remote server. It is mainly implemented by the RADIUS server and TACACS+ server.

Method List

AAA is implemented using different security methods. A method list defines a method implementation sequence. The method list can contain one or more security protocols so that a standby method can take over the AAA service when the first method fails. On FS devices, the first method in the list is tried in the beginning and then the next is tried one by one if the previous gives no response. This method selection process continues until a security method responds or all the security methods in the list are tried out. Authentication fails if no method in the list responds.

A method list contains a series of security methods that will be queried in sequence to verify user identities. It allows you to define one or more security protocols used for authentication, so that the standby authentication method takes over services when the active security method fails. On FS devices, the first method in the list is tried in the beginning and then the next is tried one by one if the previous gives no response. This method selection process continues until a method responds or all the methods in the method list are tried out. Authentication fails if no method in the list responds.

! The next authentication method proceeds on FS devices only when the current method does not respond. When a method denies user access, the authentication process ends without trying other methods.

Figure 1-3

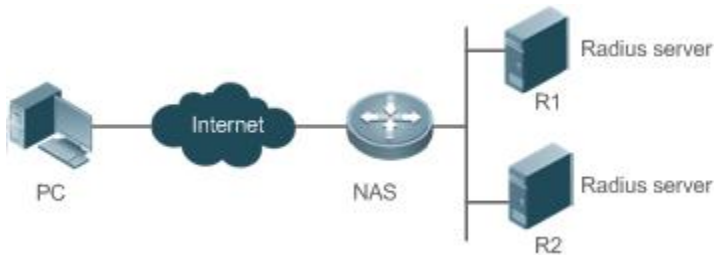

Figure 1-3 shows a typical AAA network topology, where two RADIUS servers (R1 and R2) and one NAS are deployed. The NAS can be the client for the RADIUS servers.

Assume that the system administrator defines a method list, where the NAS selects R1 and R2 in sequence to obtain user identity information and then accesses the local username database on the server. For example, when a remote PC user initiates dial-up access, the NAS first queries the user's identity on R1. When the authentication on R1 is completed, R1 returns an Accept response to the NAS. Then the user is permitted to access the Internet. If R1 returns a Reject response, the user is denied Internet access and the connection is terminated. If R1 does not respond, the NAS considers that the R1 method times out and continues to query the user's identity on R2. This process continues as the NAS keeps trying the remaining authentication methods, until the user request is authenticated, rejected, or terminated. If all the authentication methods are responded with Timeout, authentication fails and the connection will be terminated.

- i** The Reject response is different from the Timeout response. The Reject response indicates that the user does not meet the criteria of the available authentication database and therefore fails in authentication, and the Internet access request is denied. The Timeout response indicates that the authentication server fails to respond to the identity query. When detecting a timeout event, the AAA service proceeds to the next method in the list to continue the authentication process.
- i** This document describes how to configure AAA on the RADIUS server. For details about the configuration on the TACACS+ server, see the *Configuring TACACS+*.

➤ AAA Server Group

You can define an AAA server group to include one or more servers of the same type. If the server group is referenced by a method list, the NAS preferentially sends requests to the servers in the referenced server group when the method list is used to implement AAA.

➤ VRF-Enabled AAA Group

Virtual private networks (VPNs) enable users to share bandwidths securely on the backbone networks of Internet service providers (ISPs). A VPN is a site set consisting of shared routes. An STA site connects to the network of an ISP through one or multiple interfaces. AAA supports assigning a VPN routing forwarding (VRF) table to each user-defined server group.

When AAA is implemented by the server in a group assigned with a VRF table, the NAS sends request packets to the remote servers in the server group. The source IP address of request packets is an address selected from the VRF table according to the IP addresses of the remote servers.

If you run the **ip radius/tacacs+ source-interface** command to specify the source interface for the request packets, the IP address obtained from the source interface takes precedence over the source IP address selected from the VRF table.

Overview

Feature	Description
AAA Authentication	Verifies whether users can access the Internet.
AAA Authorization	Determines what services or permissions users can enjoy.
AAA Accounting	Records the network resource usage of users.
Multi-Domain AAA	Creates domain-specific AAA schemes for 802.1X stations (STAs) in different domains.
Login Switch for the AAA Slave Device	Provides a login switch to control login of the AAA slave device.
Authorization Result Caching	Caches authorization results returned from the server.

1.3.1 AAA Authentication

Authentication, authorization, and accounting are three independent services. The authentication service verifies whether users can access the Internet. During authentication, the username, password, and other user information are exchanged between devices to complete users' access or service requests. You can use only the authentication service of AAA.

-  To configure AAA authentication, you need to first configure an authentication method list. Applications perform authentication according to the method list. The method list defines the types of authentication and the sequence in which they are performed. Authentication methods are implemented by specified applications. The only exception is the default method list. All applications use the default method list if no method list is configured.

AAA Authentication Scheme

- No authentication (**none**)

The identity of trusted users is not checked. Normally, the no-authentication (None) method is not used.

- Local authentication (**local**)

Authentication is performed on the NAS, which is configured with user information (including usernames, passwords, and AV pairs). Before local authentication is enabled, run the **username password/secret** command to create a local user database.

- Remote server group authentication (**group**)

Authentication is performed jointly by the NAS and a remote server group through RADIUS or TACACS+. A server group consists of one or more servers of the same type. User information is managed centrally on a remote server, thus realizing multi-device centralized and unified authentication with high capacity and reliability. You can configure local authentication as standby to avoid authentication failures when all the servers in the server group fail.

AAA Authentication Types

FS products support the following authentication types:

- Login authentication

Users log in to the command line interface (CLI) of the NAS for authentication through Secure Shell (SSH), Telnet, and File Transfer Protocol (FTP).

- Enable authentication

After users log in to the CLI of the NAS, the users must be authenticated before CLI permission update. This process is called Enable authentication (in Privileged EXEC mode).

Related Configuration

Enabling AAA

By default, AAA is disabled.

To enable AAA, run the **aaa new-model** command.

↘ **Configuring an AAA Authentication Scheme**

By default, no AAA authentication scheme is configured.

Before you configure an AAA authentication scheme, determine whether to use local authentication or remote server authentication. If the latter is to be implemented, configure a RADIUS or TACACS+ server in advance. If local authentication is selected, configure the local user database information on the NAS.

↘ **Configuring an AAA Authentication Method List**

By default, no AAA authentication method list is configured.

Determine the access mode to be configured in advance. Then configure authentication methods according to the access mode.

1.3.2AAA Authorization

AAA authorization allows administrators to control the services or permissions of users. After AAA authorization is enabled, the NAS configures the sessions of users according to the user configuration files stored on the NAS or servers. After authorization, users can use only the services or have only the permissions permitted by the configuration files.

↘ **AAA Authorization Scheme**

- Direct authorization (**none**)

Direct authorization is intended for highly trusted users, who are assigned with the default permissions specified by the NAS.

- Local authorization (**local**)

Local authorization is performed on the NAS, which authorizes users according to the AV pairs configured for local users.

- Remote server-group authorization (**group**)

Authorization is performed jointly by the NAS and a remote server group. You can configure local or direct authorization as standby to avoid authorization failures when all the servers in the server group fail.

↘ **AAA Authorization Types**

- EXEC authorization

After users log in to the CLI of the NAS, the users are assigned with permission levels (0 to 15).

- Config-commands authorization

Users are assigned with the permissions to run specific commands in configuration modes (including the global configuration mode and sub-modes).

- Console authorization

After users log in through consoles, the users are authorized to run commands.

- Command authorization

Authorize users with commands after login to the CLI of the NAS.

- Network authorization

After users access the Internet, the users are authorized to use the specific session services. For example, after users access the Internet through PPP and Serial Line Internet Protocol (SLIP), the users are authorized to use the data service, bandwidth, and timeout service.

Related Configuration

↘ Enabling AAA

By default, AAA is disabled.

To enable AAA, run the **aaa new-model** command.

↘ Configuring an AAA Authorization Scheme

By default, no AAA authorization scheme is configured.

Before you configure an AAA authorization scheme, determine whether to use local authorization or remote server-group authorization. If remote server-group authorization needs to be implemented, configure a RADIUS or TACACS+ server in advance. If local authorization needs to be implemented, configure the local user database information on the NAS.

↘ Configuring an AAA Authorization Method List

By default, no AAA authorization method list is configured.

Determine the access mode to be configured in advance. Then configure authorization methods according to the access mode.

1.3.3AAA Accounting

In AAA, accounting is an independent process of the same level as authentication and authorization. During the accounting process, start-accounting, update-accounting, and end-accounting requests are sent to the configured accounting server, which records the network resource usage of users and performs accounting, audit, and tracking of users' activities.

In AAA configuration, accounting scheme configuration is optional.

↘ AAA Accounting Schemes

- No accounting (**none**)

Accounting is not performed on users.

- Local accounting (**local**)

Accounting is completed on the NAS, which collects statistics on and limits the number of local user connections. Billing is not performed.

- Remote server-group accounting (**group**)

Accounting is performed jointly by the NAS and a remote server group. You can configure local accounting as standby to avoid accounting failures when all the servers in the server group fail.

↘ AAA Accounting Types

- EXEC accounting

Accounting is performed when users log in to and out of the CLI of the NAS.

- Command accounting

Records are kept on the commands that users run on the CLI of the NAS.

- Network accounting

Records are kept on the sessions that users set up to access the Internet.

Related Configuration

▾ Enabling AAA

By default, AAA is disabled.

To enable AAA, run the **aaa new-model** command.

▾ Configuring an AAA Accounting Scheme

By default, no AAA accounting method is configured.

Before you configure an AAA accounting scheme, determine whether to use local accounting or remote server-group accounting. If remote server-group accounting needs to be implemented, configure a RADIUS or TACACS+ server in advance. If local accounting needs to be implemented, configure the local user database information on the NAS.

▾ Configuring an AAA Accounting Method List

By default, no AAA accounting method list is configured.

Determine the access mode to be configured in advance. Then configure accounting methods according to the access mode.

1.3.4 Multi-Domain AAA

In a multi-domain environment, the NAS can provide the AAA services to users in different domains. The user AVs (such as usernames and passwords, service types, and permissions) may vary with different domains. It is necessary to configure domains to differentiate the user AVs in different domains and configure an AV set (including an AAA service method list, for example, RADIUS) for each domain.

Our products support the following username formats:

1. userid@domain-name
2. domain-name\userid
3. userid.domain-name
4. userid

The fourth format (userid) does not contain a domain name, and it is considered to use the **default** domain name.

The NAS provides the domain-based AAA service based on the following principles:

- Resolves the domain name carried by a user.
- Searches for the user domain according to the domain name.
- Searches for the corresponding AAA method list name according to the domain configuration information on the NAS.
- Searches for the corresponding method list according to the method list name.
- Provides the AAA services based on the method list.

 If any of the preceding procedures fails, the AAA services cannot be provided.

Figure 1-4 shows the typical multi-domain topology.

Figure 1-4

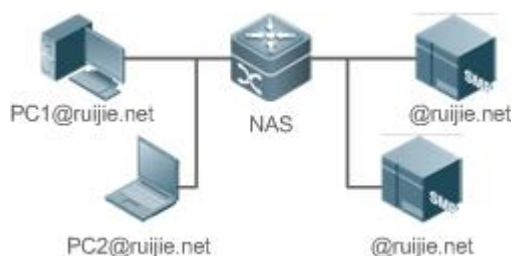

Related Configuration

✚ Enabling AAA

By default, AAA is disabled.

To enable AAA, run the **aaa new-model** command.

✚ Configuring an AAA Method List

By default, no AAA method list is configured.

For details, see section 5.2.1, section 5.2.2, and section 5.2.3.

✚ Enabling the Domain-Based AAA Service

By default, the domain-based AAA service is disabled.

To enable the domain-based AAA service, run the **aaa domain enable** command.

✚ Creating a Domain

By default, no domain is configured.

To configure a domain, run the **aaa domain domain-name** command.

✚ Configuring an AV Set for a Domain

By default, no domain AV set is configured.

A domain AV set contains the following elements: AAA method lists, the maximum number of online users, whether to remove the domain name from the username, and whether the domain name takes effect.

✚ Displaying Domain Configuration

To display domain configuration, run the **show aaa domain** command.

 The system supports a maximum of 32 domains.

1.3.5 Login Switch for the AAA Slave Device

A login switch is provided to control login of the AAA slave device. By default, the switch is off, so the slave device is not allowed to login. When the switch is turned on, the slave device can login.

Related Configuration

✚ Enabling AAA

By default, AAA is disabled.

To enable AAA, run the **aaa new-model** command.

➤ **Configuring a Login Switch for the AAA Slave Device**

By default, the slave device is not allowed to login.

Run the **aaa slave-login allow** command to permit login of the slave device.

1.3.6 Authorization Result Caching

The AAA module caches authorization results returned from the server. Therefore, later authorizations at the same level can be operated based on the cached resources.



Related Configuration





➤ **Configuring Authorization Result Caching**

By default, authorization results are not cached.

To enable authorization result caching, run the **aaa command-author cache** command.

1.4 Configuration

Configuration	Description and Command	
Configuring AAA Authentication	 Mandatory if user identities need to be verified.	
	aaa new-model	Enables AAA.
	aaa authentication login	Defines a method list of login authentication.
	aaa authentication enable	Defines a method list of Enable authentication.
	aaa authentication ppp	Defines a method list of PPP authentication.
	aaa authentication sslvpn	Defines a method list of SSL VPN authentication.
	login authentication	Applies login authentication to a specific terminated line.
	dot1x authentication	Indicates 802.1x authentication.
	aaa local authentication attempts	Sets the maximum number of login attempts.
Configuring AAA Authorization	 Mandatory if different permissions and services need to be assigned to users.	
	aaa new-model	Enables AAA.
	aaa authorization exec	Defines a method list of EXEC authorization.
	aaa authorization commands	Defines a method list of command authorization.
	aaa authorization network	Configures a method list of network authorization.
	authorization exec	Applies EXEC authorization methods to a specified VTY line.
Configuring AAA Accounting	 Mandatory if accounting, statistics, and tracking need to be performed on the network resource usage of users.	
	authorization commands	Applies command authorization methods to a specified VTY line.

Configuration	Description and Command	
	aaa new-model	Enables AAA.
	aaa accounting exec	Defines a method list of EXEC accounting.
	aaa accounting commands	Defines a method list of command accounting.
	aaa accounting network	Defines a method list of network accounting.
	accounting exec	Applies EXEC accounting methods to a specified VTY line.
	accounting commands	Applies command accounting methods to a specified VTY line.
	aaa accounting update	Enables accounting update.
	aaa accounting update periodic	Configures the accounting update interval.
Configuring an AAA Server Group	 Recommended if a server group needs to be configured to handle AAA through different servers in the group.	
	aaa group server	Creates a user-defined AAA server group.
	server	Adds an AAA server group member.
	ip vrf forwarding	Configures the VRF attribute of an AAA server group.
Configuring the Domain-Based AAA Service	 Mandatory if AAA management of 802.1X access STAs needs to be performed according to domains.	
	aaa new-model	Enables AAA.
	aaa domain enable	Enables the domain-based AAA service.
	aaa domain	Creates a domain and enters domain configuration mode.
	accounting network	Associates the domain with a network accounting method list.
	authorization network	Associates the domain with a network authorization method list.
	state	Configures the domain status.
username-format	Configures whether to contain the domain name in usernames.	
Configuring a Login Switch for the AAA Slave Device	 Mandatory if a login switch needs to be configured for the AAA slave device.	
	aaa slave-login allow	Allows login of the slave device.
Configuring Authorization Result Caching	 Mandatory if later authorizations at the same level need to be operated based on the former results.	
	aaa command-author cache	Caches authorization results.

1.4.1 Configuring AAA Authentication

Configuration Effect

Verify whether users are able to obtain access permission.

Notes

- If an authentication scheme contains multiple authentication methods, these methods are executed according to the configured sequence.
- The next authentication method is executed only when the current method does not respond. If the current method fails, the next method will be not tried.
- When the **none** method is used, users can get access even when no authentication method gets response. Therefore, the **none** method is used only as standby.
- **i** Normally, do not use None authentication. You can use the **none** method as the last optional authentication method in special cases. For example, all the users who may request access are trusted users and the users' work must not be delayed by system faults. Then you can use the **none** method to assign access permissions to these users when the authentication server does not respond. It is recommended that the local authentication method be added before the **none** method.
- If AAA authentication is enabled but no authentication method is configured and the default authentication method does not exist, users can directly log in to the Console without being authenticated. If users log in by other means, the users must pass local authentication.
- When a user enters the CLI after passing login authentication (the **none** method is not used), the username is recorded. When the user performs Enable authentication, the user is not prompted to enter the username again, because the username that the user entered during login authentication is automatically filled in. However, the user must enter the password previously used for login authentication.
- The username is not recorded if the user does not perform login authentication when entering the CLI or the **none** method is used during login authentication. Then, a user is required to enter the username each time when performing Enable authentication.

Configuration Steps

▾ Enabling AAA

- Mandatory.
- Run the **aaa new-model** command to enable AAA.
- By default, AAA is disabled.

▾ Defining a Method List of Login Authentication

- Run the **aaa authentication login** command to configure a method list of login authentication.
- This configuration is mandatory if you need to configure a login authentication method list (including the configuration of the default method list).
- By default, no method list of login authentication is configured.

▾ Defining a Method List of Enable Authentication

- Run the **aaa authentication enable** command to configure a method list of Enable authentication.
- This configuration is mandatory if you need to configure an Enable authentication method list. (You can configure only the default method list.)
- By default, no method list of Enable authentication is configured.

▾ Defining a Method List of PPP Authentication

- Run the **aaa authentication ppp** command to configure a method list of PPP authentication.
- This configuration is mandatory if you need to configure an authentication method list for PPP dial-up access.
- By default, no method list of PPP authentication is configured.

↘ **Defining a Method List of SSL VPN Authentication**

- Run the **aaa authentication sslvpn** command to configure a method list of SSL VPN authentication.
- This configuration is mandatory if you need to configure an SSL VPN authentication method list (including the configuration of the default method list).
- By default, no method list of SSL VPN authentication is configured.

↘ **Applying Login Authentication to a Specific Terminated Line**

- In the Line mode, run the **login authentication** command to apply login authentication to a specific terminated line.
- This configuration is mandatory, if you need to apply login authentication to a specific terminated line.
- By default, the default method list is applied to all terminated lines.

↘ **Setting the Maximum Number of Login Attempts**

- Optional.
- By default, a user is allowed to enter passwords up to three times during login.

↘ **Setting the Maximum Lockout Time After a Login Failure**

- Optional.
- By default, a user is locked for 15 minutes after entering wrong passwords three times.

Verification

- Run the **show aaa method-list** command to display the configured method lists.
- Run the **show aaa lockout** command to display the settings of the maximum number of login attempts and the maximum lockout time after a login failure.
- Run the **show running-config** command to display the authentication method lists associated with login authentication authentication.

Related Commands

↘ **Enabling AAA**

Command	aaa new-model
Parameter	N/A
Description	
Command Mode	Global configuration mode
Usage Guide	To enable the AAA services, run this command. None of the rest of AAA commands can be effective if AAA is not enabled.

↘ **Defining a Method List of Login Authentication**

Command	aaa authentication login { default <i>list-name</i> } <i>method1</i> [<i>method2...</i>]
Parameter	default: With this parameter used, the configured method list will be defaulted.
Description	<p><i>list-name:</i> Indicates the name of a login authentication method list in characters.</p> <p><i>method:</i> Indicates authentication methods from local, none, and group. A method list contains up to four methods.</p> <p>local: Indicates that the local user database is used for authentication.</p> <p>none: Indicates that authentication is not performed.</p> <p>group: Indicates that a server group is used for authentication. Currently, the RADIUS and TACACS+ server groups are supported.</p>
Command Mode	Global configuration mode
Usage Guide	<p>If the AAA login authentication service is enabled on the NAS, users must perform login authentication negotiation through AAA. Run the aaa authentication login command to configure the default or optional method lists for login authentication.</p> <p>In a method list, the next method is executed only when the current method does not receive response.</p> <p>After you configure login authentication methods, apply the methods to the VTY lines that require login authentication; otherwise, the methods will not take effect.</p>

▾ Defining a Method List of Enable Authentication

Command	aaa authentication enable default <i>method1</i> [<i>method2...</i>]
Parameter	default: With this parameter used, the configured method list will be defaulted.
Description	<p><i>list-name:</i> Indicates the name of an Enable authentication method list in characters.</p> <p><i>method:</i> Indicates authentication methods from enable, local, none, and group. A method list contains up to four methods.</p> <p>enable: Indicates that the password that is configured using the enable command is used for authentication.</p> <p>local: Indicates that the local user database is used for authentication.</p> <p>none: Indicates that authentication is not performed.</p> <p>group: Indicates that a server group is used for authentication. Currently, the RADIUS and TACACS+ server groups are supported.</p>
Command Mode	Global configuration mode
Usage Guide	<p>If the AAA login authentication service is enabled on the NAS, users must perform Enable authentication negotiation through AAA. Run the aaa authentication enable command to configure the default or optional method lists for Enable authentication.</p> <p>In a method list, the next method is executed only when the current method does not receive response.</p>

▾ Defining a Method List of PPP or SSL VPN Authentication

Command	aaa authentication { ppp sslvpn } { default <i>list-name</i> } <i>method1</i> [<i>method2...</i>]
Parameter	ppp: Configures a method list of PPP authentication.
Description	<p>sslvpn: Configures a method list of SSL VPN authentication.</p> <p>default: With this parameter used, the configured method list will be defaulted.</p> <p><i>list-name:</i> Indicates the name of an PPP authentication method list in characters.</p> <p><i>method:</i> Indicates authentication methods from local, none, group, and subs. A method list contains up to four methods.</p> <p>local: Indicates that the local user database is used for authentication.</p>

	<p>none: Indicates that authentication is not performed.</p> <p>group: Indicates that a server group is used for authentication. Currently, the RADIUS and the TACACS+ server group is supported.</p> <p>subs: Specifies the SUBS authentication method using the SUBS database.</p>
Command Mode	Global configuration mode
Usage Guide	<p>If the AAA PPP authentication service is enabled on the NAS, users must perform PPP authentication negotiation through AAA. Run the aaa authentication ppp command to configure the default or optional method lists for PPP authentication.</p> <p>In a method list, the next method is executed only when the current method does not receive response.</p>

➤ **Setting the Maximum Number of Login Attempts**

Command	aaa local authentication attempts <i>max-attempts</i>
Parameter Description	<i>max-attempts</i> : Indicates the maximum number of login attempts. The value ranges from 0 to 2,147,483,647.
Command Mode	Global configuration mode
Usage Guide	Use this command to set the maximum number of times a user can attempt to login. 0 indicates no limit.

➤ **Setting the Maximum Lockout Time After a Login Failure**

Command	aaa local authentication lockout-time <i>lockout-time</i>
Parameter Description	<i>lockout-time</i> : Indicates the time during which a user is locked after entering wrong passwords up to the specified times. The value ranges from 1 to 2,147,483,647, in the unit of minutes.
Command Mode	Global configuration mode
Usage Guide	Use this command to set the maximum time during which a user is locked after entering wrong passwords up to the specified times.

Configuration Example

➤ **Configuring AAA Login Authentication**

Configure a login authentication method list on the NAS containing **group** *radius* and **local** methods in order.

Scenario Figure 1-5	<pre> graph LR User[User] --- Gi01[Gi 0/1] --- NAS[NAS] NAS --- Gi02[Gi 0/2] --- Server[Server] Server --- IP[10.1.1.1] </pre>
Configuration Steps	<p>Step 1: Enable AAA.</p> <p>Step 2: Configure a RADIUS or TACACS+ server in advance if group-server authentication needs to be implemented. Configure the local user database information on the NAS if local authentication needs to be implemented. (This example requires the configuration of a RADIUS server and local database information.)</p> <p>Step 3: Configure an AAA authentication method list for login authentication users. (This example uses group <i>radius</i> and local in order.)</p> <p>Step 4: Apply the configured method list to an interface or line. Skip this step if the default authentication method is</p>

	used.
NAS	<pre> FS#configure terminal FS(config)#username user password pass FS(config)#aaa new-model FS(config)#radius-server host 10.1.1.1 FS(config)#radius-server key FS FS(config)#aaa authentication login list1 group radius local FS(config)#line vty 0 20 FS(config-line)#login authentication list1 FS(config-line)#exit </pre>
Verification	Run the show aaa method-list command on the NAS to display the configuration.
NAS	<pre> FS#show aaa method-list Authentication method-list: aaa authentication login list1 group radius local Accounting method-list: Authorization method-list: </pre>
	<p>Assume that a user remotely logs in to the NAS through Telnet. The user is prompted to enter the username and password on the CLI.</p> <p>The user must enter the correct username and password to access the NAS.</p>
User	<pre> User Access Verification Username:user Password:pass </pre>

➤ **Configuring AAA Enable Authentication**

Configure an Enable authentication method list on the NAS containing **group radius, local**, and then **enable** methods in order.

Scenario Figure 1-6	
Configuration	Step 1: Enable AAA.

<p>Steps</p>	<p>Step 2: Configure a RADIUS or TACACS+ server in advance if group-server authentication needs to be implemented. Configure the local user database information on the NAS if local authentication needs to be implemented. Configure Enable authentication passwords on the NAS if you use Enable password authentication.</p> <p>Step 3: Configure an AAA authentication method list for Enable authentication users.</p> <p> You can define only one Enable authentication method list globally. You do not need to define the list name but just default it. After that, it will be applied automatically.</p>
<p>NAS</p>	<pre>FS#configure terminal FS(config)#username user privilege 15 password pass FS(config)#enable secret w FS(config)#aaa new-model FS(config)#radius-server host 10.1.1.1 FS(config)#radius-server key FS FS(config)#aaa authentication enable default group radius local enable</pre>
<p>Verification</p>	<p>Run the show aaa method-list command on the NAS to display the configuration.</p>
<p>NAS</p>	<pre>FS#show aaa method-list Authentication method-list: aaa authentication enable default group radius local enable Accounting method-list: Authorization method-list:</pre>
	<p>The CLI displays an authentication prompt when the user level is updated to level 15. The user must enter the correct username and password to access the NAS.</p>
<p>NAS</p>	<pre>FS>enable Username:user Password:pass FS#</pre>

Common Errors

- No RADIUS server or TACACS+ server is configured.
- Usernames and passwords are not configured in the local database.

1.4.2 Configuring AAA Authorization

Configuration Effect

- Determine what services or permissions authenticated users can enjoy.

Notes

- EXEC authorization is often used with login authentication, which can be implemented on the same line. Authorization and authentication can be performed using different methods and servers. Therefore, the results of the same user may be different. If a user passes login authentication but fails in EXEC authorization, the user cannot enter the CLI.
- The authorization methods in an authorization scheme are executed in accordance with the method configuration sequence. The next authorization method is executed only when the current method does not receive response. If authorization fails using a method, the next method will be not tried.
- Command authorization is supported only by TACACS+.
- Console authorization: The FSOS can differentiate between the users who log in through the Console and the users who log in through other types of clients. You can enable or disable command authorization for the users who log in through the Console. If command authorization is disabled for these users, the command authorization method list applied to the Console line no longer takes effect.

Configuration Steps

▾ Enabling AAA

- Mandatory.
- Run the **aaa new-model** command to enable AAA.
- By default, AAA is disabled.

▾ Defining a Method List of EXEC Authorization

- Run the **aaa authorization exec** command to configure a method list of EXEC authorization.
- This configuration is mandatory if you need to configure an EXEC authorization method list (including the configuration of the default method list).
- By default, no EXEC authorization method list is configured.
-  The default access permission level of EXEC users is the lowest. (Console users can connect to the NAS through the Console port or Telnet. Each connection is counted as an EXEC user, for example, a Telnet user and SSH user.)

▾ Defining a Method List of Command Authorization

- Run the **aaa authorization commands** command to configure a method list of command authorization.
- This configuration is mandatory if you need to configure a command authorization method list (including the configuration of the default method list).
- By default, no command authorization method list is configured.

▾ Configuring a Method List of Network Authorization

- Run the **aaa authorization network** command to configure a method list of network authorization.

- This configuration is mandatory if you need to configure a network authorization method list (including the configuration of the default method list).
- By default, no authorization method is configured.

➤ **Applying EXEC Authorization Methods to a Specified VTY Line**

- Run the **authorization exec** command in line configuration mode to apply EXEC authorization methods to a specified VTY line.
- This configuration is mandatory if you need to apply an EXEC authorization method list to a specified VTY line.
- By default, all VTY lines are associated with the default authorization method list.

➤ **Applying Command Authorization Methods to a Specified VTY Line**

- Run the **authorization commands** command in line configuration mode to apply command authorization methods to a specified VTY line.
- This configuration is mandatory if you need to apply a command authorization method list to a specified VTY line.
- By default, all VTY lines are associated with the default authorization method list.

➤ **Enabling Authorization for Commands in Configuration Modes**

- Run the **aaa authorization config-commands** command to enable authorization for commands in configuration modes.
- By default, authorization is disabled for commands in configuration modes.

➤ **Enabling Authorization for the Console to Run Commands**

- Run the **aaa authorization console** command to enable authorization for console users to run commands.
- By default, authorization is disabled for the Console to run commands.

Verification

Run the **show running-config** command to verify the configuration.

Related Commands

➤ **Enabling AAA**

Command	aaa new-model
Parameter	N/A
Description	
Command Mode	Global configuration mode
Usage Guide	To enable the AAA services, run this command. None of the rest of AAA commands can be effective if AAA is not enabled.

➤ **Defining a Method List of EXEC Authorization**

Command	aaa authorization exec { default list-name } method1 [method2...]
Parameter	default: With this parameter used, the configured method list will be defaulted.
Description	<i>list-name:</i> Indicates the name of an EXEC authorization method list in characters. <i>method:</i> Specifies authentication methods from local , none , and group . A method list contains up to four methods. local: Indicates that the local user database is used for EXEC authorization.

	<p>none: Indicates that EXEC authorization is not performed.</p> <p>group: Indicates that a server group is used for EXEC authorization. Currently, the RADIUS and TACACS+ server groups are supported.</p>
Command Mode	Global configuration mode
Usage Guide	<p>The FSOS supports authorization of the users who log in to the CLI of the NAS to assign the users CLI operation permission levels (0 to 15). Currently, EXEC authorization is performed only on the users who have passed login authentication. If a user fails in EXEC authorization, the user cannot enter the CLI.</p> <p>After you configure EXEC authorization methods, apply the methods to the VTY lines that require EXEC authorization; otherwise, the methods will not take effect.</p>

📌 Defining a Method List of Command Authorization

Command	aaa authorization commands <i>level</i> { default <i>list-name</i> } <i>method1</i> [<i>method2...</i>]
Parameter Description	<p>default: With this parameter used, the configured method list will be defaulted.</p> <p><i>list-name:</i> Indicates the name of a command authorization method list in characters.</p> <p><i>method:</i> Indicates authentication methods from none and group. A method list contains up to four methods.</p> <p>none: Indicates that command authorization is not performed.</p> <p>group: Indicates that a server group is used for command authorization. Currently, the TACACS+ server group is supported.</p>
Command Mode	Global configuration mode
Usage Guide	<p>The FSOS supports authorization of the commands executable by users. When a user enters a command, AAA sends the command to the authentication server. If the authentication server permits the execution, the command is executed. If the authentication server forbids the execution, the command is not executed and a message is displayed showing that the execution is rejected.</p> <p>When you configure command authorization, specify the command level, which is used as the default level. (For example, if a command above Level 14 is visible to users, the default level of the command is 14.)</p> <p>After you configure command authorization methods, apply the methods to the VTY lines that require command authorization; otherwise, the methods will not take effect.</p>

📌 Configuring a Method List of Network Authorization

Command	aaa authorization network { default <i>list-name</i> } <i>method1</i> [<i>method2...</i>]
Parameter Description	<p>default: With this parameter used, the configured method list will be defaulted.</p> <p><i>list-name:</i> Indicates the name of a network authorization method list in characters.</p> <p><i>method:</i> Indicates authentication methods from none and group. A method list contains up to four methods.</p> <p>none: Indicates that authentication is not performed.</p> <p>group: Indicates that a server group is used for network authorization. Currently, the RADIUS and TACACS+ server groups are supported.</p>
Command Mode	Global configuration mode
Usage Guide	<p>The FSOS supports authorization of network-related service requests such as PPP and SLIP requests. After authorization is configured, all authenticated users or interfaces are authorized automatically.</p> <p>You can configure three different authorization methods. The next authorization method is executed only when the</p>

	current method does not receive response. If authorization fails using a method, the next method will be not tried. RADIUS or TACACS+ servers return a series of AV pairs to authorize authenticated users. Network authorization is based on authentication. Only authenticated users can perform network authorization.
--	---

📌 **Enabling Authorization for Commands in Configuration Modes (Including the Global Configuration Mode and Sub-Modes)**

Command	aaa authorization config-commands
Parameter	N/A
Description	
Command Mode	Global configuration mode
Usage Guide	If you need to enable authorization for commands only in non-configuration modes (for example, privileged EXEC mode), disable authorization in configuration modes by using the no form of this command. Then users can run commands in configuration mode and sub-modes without authorization.

📌 **Enabling Authorization for the Console to Run Commands**

Command	aaa authorization console
Parameter	N/A
Description	
Command Mode	Global configuration mode
Usage Guide	The FSOS can differentiate between the users who log in through the Console and the users who log in through other types of clients. You can enable or disable command authorization for the users who log in through the Console. If command authorization is disabled for these users, the command authorization method list applied to the Console line no longer takes effect.

Configuration Example

📌 **Configuring AAA EXEC Authorization**

Configure login authentication and EXEC authorization for users on VTY lines 0 to 4. Login authentication is performed in local mode, and EXEC authorization is performed on a RADIUS server. If the RADIUS server does not respond, users are redirected to the local authorization.

Scenario Figure 1-7	<pre> graph LR User[Laptop] --- Gi01[Gi 0/1] --- NAS[Switch] NAS --- Gi02[Gi 0/2] --- Server[Server 10.1.1.1] </pre>
Configuration Steps	<p>Step 1: Enable AAA.</p> <p>Step 2: Configure a RADIUS or TACACS+ server in advance if remote server-group authorization needs to be implemented. If local authorization needs to be implemented, configure the local user database information on the NAS.</p> <p>Step 3: Configure an AAA authorization method list according to different access modes and service types.</p> <p>Step 4: Apply the configured method list to an interface or line. Skip this step if the default authorization method is used. EXEC authorization is often used with login authentication, which can be implemented on the same line.</p>

<p>NAS</p>	<pre> FS#configure terminal FS(config)#username user password pass FS(config)#username user privilege 6 FS(config)#aaa new-model FS(config)#radius-server host 10.1.1.1 FS(config)#radius-server key test FS(config)#aaa authentication login list1 group local FS(config)#aaa authorization exec list2 group radius local FS(config)#line vty 0 4 FS(config-line)#login authentication list1 FS(config-line)# authorization exec list2 FS(config-line)#exit </pre>
<p>Verification</p>	<p>Run the show run and show aaa method-list commands on the NAS to display the configuration.</p>
<p>NAS</p>	<pre> FS#show aaa method-list Authentication method-list: aaa authentication login list1 group local Accounting method-list: Authorization method-list: aaa authorization exec list2 group radius local </pre>
	<pre> FS# show running-config aaa new-model ! aaa authorization exec list2 group local aaa authentication login list1 group radius local ! username user password pass username user privilege 6 ! radius-server host 10.1.1.1 radius-server key 7 093b100133 </pre>

```

!
line con 0
line vty 0 4
    authorization exec list2
    login authentication list1
!
End
    
```

📌 **Configuring AAA Command Authorization**

Provide command authorization for login users according to the following default authorization method: Authorize level-15 commands first by using a TACACS+ server. If the TACACS+ server does not respond, local authorization is performed. Authorization is applied to the users who log in through the Console and the users who log in through other types of clients.

<p>Scenario Figure 1-8</p>	
<p>Configuration Steps</p>	<p>Step 1: Enable AAA. Step 2: Configure a RADIUS or TACACS+ server in advance if remote server-group authorization needs to be implemented. If local authorization needs to be implemented, configure the local user database information on the NAS. Step 3: Configure an AAA authorization method list according to different access modes and service types. Step 4: Apply the configured method list to an interface or line. Skip this step if the default authorization method is used.</p>
<p>NAS</p>	<pre> FS#configure terminal FS(config)#username user1 password pass1 FS(config)#username user1 privilege 15 FS(config)#aaa new-model FS(config)#tacacs-server host 192.168.217.10 FS(config)#tacacs-server key aaa FS(config)#aaa authentication login default local FS(config)#aaa authorization commands 15 default group tacacs+ local FS(config)#aaa authorization console </pre>
<p>Verification</p>	<p>Run the show run and show aaa method-list commands on the NAS to display the configuration.</p>
<p>NAS</p>	<pre> FS#show aaa method-list Authentication method-list: aaa authentication login default local </pre>

	<p>Accounting method-list:</p> <p>Authorization method-list:</p> <p>aaa authorization commands 15 default group tacacs+ local</p>
	<pre>FS#show run ! aaa new-model ! aaa authorization console aaa authorization commands 15 default group tacacs+ local aaa authentication login default local ! ! nfpp ! vlan 1 ! username user1 password 0 pass1 username user1 privilege 15 no service password-encryption ! tacacs-server host 192.168.217.10 tacacs-server key aaa ! line con 0 line vty 0 4 ! ! end</pre>

📌 Configuring AAA Network Authorization



<p>Configuration</p> <p>Steps</p>	<p>Step 1: Enable AAA.</p> <p>Step 2: Configure a RADIUS or TACACS+ server in advance if remote server-group authorization needs to be implemented. If local authorization needs to be implemented, configure the local user database information on the NAS.</p> <p>Step 3: Configure an AAA authorization method list according to different access modes and service types.</p> <p>Step 4: Apply the configured method list to an interface or line. Skip this step if the default authorization method is used.</p>
<p>NAS</p>	<pre>FS#configure terminal FS(config)#aaa new-model FS(config)#radius-server host 10.1.1.1 FS(config)#radius-server key test FS(config)#aaa authorization network default group radius none FS(config)# end</pre>
<p>Verification</p>	<p>Run the show aaa method-list command on the NAS to display the configuration.</p>
<p>NAS</p>	<pre>FS#show aaa method-list Authentication method-list: Accounting method-list: Authorization method-list: aaa authorization network default group radius none</pre>

Common Errors

N/A

1.4.3Configuring AAA Accounting

Configuration Effect

- Record the network resource usage of users.
- Record the user login and logout processes and the commands executed by users during device management.

Notes

About accounting methods:

- If an accounting scheme contains multiple accounting methods, these methods are executed according to the method configuration sequence. The next accounting method is executed only when the current method does not receive response. If accounting fails using a method, the next method will be not tried.
- After the default accounting method list is configured, it is applied to all VTY lines automatically. If a non-default accounting method list is applied to a line, it will replace the default one. If you apply an undefined method list to a line, the system will

display a message indicating that accounting on this line is ineffective. Accounting will take effect only when a defined method list is applied.

EXEC accounting:

- EXEC accounting is performed only when login authentication on the NAS is completed. EXEC accounting is not performed if login authentication is not configured or the **none** method is used for authentication. If Start accounting is not performed for a user upon login, Stop accounting will not be performed when the user logs out.

Command accounting

- Only the TACACS+ protocol supports command accounting.

Configuration Steps

↘ Enabling AAA

- Mandatory.
- Run the **aaa new-model** command to enable AAA.
- By default, AAA is disabled.

↘ Defining a Method List of EXEC Accounting

- Run the **aaa accounting exec** command to configure a method list of EXEC accounting.
- This configuration is mandatory if you need to configure an EXEC accounting method list (including the configuration of the default method list).
- The default access permission level of EXEC users is the lowest. (Console users can connect to the NAS through the Console port or Telnet. Each connection is counted as an EXEC user, for example, a Telnet user and SSH user.)
- By default, no EXEC accounting method list is configured.

↘ Defining a Method List of Command Accounting

- Run the **aaa accounting commands** command to configure a method list of command accounting.
- This configuration is mandatory if you need to configure a command accounting method list (including the configuration of the default method list).
- By default, no command accounting method list is configured. Only the TACACS+ protocol supports command accounting.

↘ Defining a Method List of Network Accounting

- Run the **aaa accounting network** command to configure a method list of network accounting.
- This configuration is mandatory if you need to configure a network accounting method list (including the configuration of the default method list).
- By default, no network accounting method list is configured.

↘ Applying EXEC Accounting Methods to a Specified VTY Line

- Run the **accounting exec** command in line configuration mode to apply EXEC accounting methods to a specified VTY line.
- This configuration is mandatory if you need to apply an EXEC accounting method list to a specified VTY line.
- You do not need to run this command if you apply the default method list.

- By default, all VTY lines are associated with the default accounting method list.

➤ **Applying Command Accounting Methods to a Specified VTY Line**

- Run the **accounting commands** command in line configuration mode to apply command accounting methods to a specified VTY line.
- This configuration is mandatory if you need to apply a command accounting method list to a specified VTY line.
- You do not need to run this command if you apply the default method list.
- By default, all VTY lines are associated with the default accounting method list.

➤ **Enabling Accounting Update**

- Optional.
- It is recommended that accounting update be configured for improved accounting accuracy.
- By default, accounting update is disabled.

➤ **Configuring the Accounting Update Interval**

- Optional.
- It is recommended that the accounting update interval not be configured unless otherwise specified.

Verification

Run the **show running-config** command to verify the configuration.

Related Commands

➤ **Enabling AAA**

Command	aaa new-model
Parameter	N/A
Description	
Command Mode	Global configuration mode
Usage Guide	To enable the AAA services, run this command. None of the rest of AAA commands can be effective if AAA is not enabled.

➤ **Defining a Method List of EXEC Accounting**

Command	aaa accounting exec { default list-name } start-stop method1 [method2...]
Parameter	default: With this parameter used, the configured method list will be defaulted.
Description	<p><i>list-name:</i> Indicates the name of an EXEC accounting method list in characters.</p> <p><i>method:</i> Indicates authentication methods from none and group. A method list contains up to four methods.</p> <p>none: Indicates that EXEC accounting is not performed.</p> <p>group: Indicates that a server group is used for EXEC accounting. Currently, the RADIUS and TACACS+ server groups are supported.</p>
Command Mode	Global configuration mode
Usage Guide	The FSOS enables EXEC accounting only when login authentication is completed. EXEC accounting is not performed if login authentication is not performed or the none authentication method is used.

	<p>After accounting is enabled, when a user logs in to the CLI of the NAS, the NAS sends a start-accounting message to the authentication server. When the user logs out, the NAS sends a stop-accounting message to the authentication server. If the NAS does not send a start-accounting message when the user logs in, the NAS will not send a stop-accounting message when the user logs out.</p> <p>After you configure EXEC accounting methods, apply the methods to the VTY lines that require EXEC accounting; otherwise, the methods will not take effect.</p>
--	--

➤ **Defining a Method List of Command Accounting**

Command	aaa accounting commands <i>level</i> { default <i>list-name</i> } start-stop <i>method1</i> [<i>method2</i> ...]
Parameter Description	<p><i>level</i>: Indicates the command level for which accounting will be performed. The value ranges from 0 to 15. After a command of the configured level is executed, the accounting server records related information based on the received accounting packet.</p> <p>default: With this parameter used, the configured method list will be defaulted.</p> <p><i>list-name</i>: Indicates the name of a command accounting method list in characters.</p> <p><i>method</i>: Indicates authentication methods from none and group. A method list contains up to four methods.</p> <p>none: Indicates that command accounting is not performed.</p> <p>group: Indicates that a server group is used for command accounting. Currently, the TACACS+ server group is supported.</p>
Command Mode	Global configuration mode
Usage Guide	<p>The FSOS enables command accounting only when login authentication is completed. Command accounting is not performed if login authentication is not performed or the none authentication method is used. After accounting is enabled, the NAS records information about the commands of the configured level that users run and sends the information to the authentication server.</p> <p>After you configure command accounting methods, apply the methods to the VTY lines that require command accounting; otherwise, the methods will not take effect.</p>

➤ **Defining a Method List of Network Accounting**

Command	aaa accounting network { default <i>list-name</i> } start-stop <i>method1</i> [<i>method2</i> ...]
Parameter Description	<p>default: With this parameter used, the configured method list will be defaulted.</p> <p><i>list-name</i>: Indicates the name of a network accounting method list in characters.</p> <p>start-stop: Indicates that a start-accounting message and a stop-accounting message are sent when a user accesses a network and when the user disconnects from the network respectively. The start-accounting message indicates that the user is allowed to access the network, regardless of whether accounting is successfully enabled.</p> <p><i>method</i>: Indicates authentication methods from none and group. A method list contains up to four methods.</p> <p>none: Indicates that network accounting is not performed.</p> <p>group: Indicates that a server group is used for network accounting. Currently, the RADIUS and TACACS+ server groups are supported.</p>
Command Mode	Global configuration mode
Usage Guide	The FSOS sends record attributes to the authentication server to perform accounting of user activities. The start-stop keyword is used to configure user accounting options.

➤ **Enabling Accounting Update**

Command	aaa accounting update
----------------	------------------------------

Parameter Description	N/A
Command Mode	Global configuration mode
Usage Guide	Accounting update cannot be used if the AAA services are not enabled. After the AAA services are enabled, run this command to enable accounting update.

📌 **Configuring the Accounting Update Interval**

Command	aaa accounting update periodic <i>interval</i>
Parameter Description	<i>Interval</i> : Indicates the accounting update interval, in the unit of minutes. The shortest is 1 minute.
Command Mode	Global configuration mode
Usage Guide	Accounting update cannot be used if the AAA services are not enabled. After the AAA services are enabled, run this command to configure the accounting update interval.

Configuration Example

📌 **Configuring AAA EXEC Accounting**

Configure login authentication and EXEC accounting for users on VTY lines 0 to 4. Login authentication is performed in local mode, and EXEC accounting is performed on a RADIUS server.

Scenario Figure 1- 10	
Configuration Steps	<p>Step 1: Enable AAA.</p> <p>If remote server-group accounting needs to be implemented, configure a RADIUS or TACACS+ server in advance.</p> <p>Step 2: Configure an AAA accounting method list according to different access modes and service types.</p> <p>Step 3: Apply the configured method list to an interface or line. Skip this step if the default accounting method is used.</p>
NAS	<pre> FS#configure terminal FS(config)#username user password pass FS(config)#aaa new-model FS(config)#radius-server host 10.1.1.1 FS(config)#radius-server key test FS(config)#aaa authentication login list1 group local FS(config)#aaa accounting exec list3 start-stop group radius FS(config)#line vty 0 4 FS(config-line)#login authentication list1 FS(config-line)# accounting exec list3 </pre>

	FS(config-line)#exit
Verification	Run the show run and show aaa method-list commands on the NAS to display the configuration.
NAS	<pre> FS#show aaa method-list Authentication method-list: aaa authentication login list1 group local Accounting method-list: aaa accounting exec list3 start-stop group radius Authorization method-list: </pre>
	<pre> FS# show running-config aaa new-model ! aaa accounting exec list3 start-stop group radius aaa authentication login list1 group local ! username user password pass ! radius-server host 10.1.1.1 radius-server key 7 093b100133 ! line con 0 line vty 0 4 accounting exec list3 login authentication list1 ! End </pre>

📌 Configuring AAA Command Accounting

Configure command accounting for login users according to the default accounting method. Login authentication is performed in local mode, and command accounting is performed on a TACACS+ server.

<p>Scenario Figure 1- 11</p>	
<p>Configuration Steps</p>	<p>Step 1: Enable AAA. If remote server-group accounting needs to be implemented, configure a RADIUS or TACACS+ server in advance. Step 2: Configure an AAA accounting method list according to different access modes and service types. Step 3: Apply the configured method list to an interface or line. Skip this step if the default accounting method is used.</p>
<p>NAS</p>	<pre>FS#configure terminal FS(config)#username user1 password pass1 FS(config)#username user1 privilege 15 FS(config)#aaa new-model FS(config)#tacacs-server host 192.168.217.10 FS(config)#tacacs-server key aaa FS(config)#aaa authentication login default local FS(config)#aaa accounting commands 15 default start-stop group tacacs+</pre>
<p>Verification</p>	<p>Run the show aaa method-list command on the NAS to display the configuration.</p>
<p>NAS</p>	<pre>FS#show aaa method-list Authentication method-list: aaa authentication login default local Accounting method-list: aaa accounting commands 15 default start-stop group tacacs+ Authorization method-list:</pre>
	<pre>FS#show run ! aaa new-model ! aaa authorization config-commands aaa accounting commands 15 default start-stop group tacacs+ aaa authentication login default local !</pre>

```
!  
nfpf  
!  
vlan 1  
!  
username user1 password 0 pass1  
username user1 privilege 15  
no service password-encryption  
!  
tacacs-server host 192.168.217.10  
tacacs-server key aaa  
!  
line con 0  
line vty 0 4  
!  
!  
end
```

Common Errors

N/A

1.4.4 Configuring an AAA Server Group

Configuration Effect

- Create a user-defined server group and add one or more servers to the group.
- When you configure authentication, authorization, and accounting method lists, name the methods after the server group name so that the servers in the group are used to handle authentication, authorization, and accounting requests.
- Use self-defined server groups to separate authentication, authorization, and accounting.

Notes

In a user-defined server group, you can specify and apply only the servers in the default server group.

Configuration Steps

📌 Creating a User-Defined AAA Server Group

- Mandatory.
- Assign a meaningful name to the user-defined server group. Do not use the predefined **radius** and **tacacs+** keywords in naming.

➤ **Adding an AAA Server Group Member**

- Mandatory.
- Run the **server** command to add AAA server group members.
- By default, a user-defined server group does not have servers.

➤ **Configuring the VRF Attribute of an AAA Server Group**

- Optional.
- Run the **ip vrf forwarding** command to configure the VRF attribute of an AAA server group.
- By default, the AAA server group belongs to the global VRF table.

Verification

Run the **show aaa group** command to verify the configuration.

Related Commands

➤ **Creating a User-Defined AAA Server Group**

Command	aaa group server {radius tacacs+} <i>name</i>
Parameter Description	<i>name</i> : Indicates the name of the server group to be created. The name must not contain the radius and tacacs+ keywords because they are the names of the default RADIUS and TACACS+ server groups.
Command Mode	Global configuration mode
Usage Guide	Use this command to configure an AAA server group. Currently, the RADIUS and TACACS+ server groups are supported.

➤ **Adding an AAA Server Group Member**

Command	server <i>ip-addr</i> [auth-port <i>port1</i>] [acct-port <i>port2</i>]
Parameter Description	<i>ip-addr</i> : Indicates the IP address of a server. <i>port1</i> : Indicates the authentication port of a server. (This parameter is supported only by the RADIUS server group.) <i>port2</i> : Indicates the accounting port of a server. (This parameter is supported only by the RADIUS server group.)
Command Mode	Server group configuration mode
Usage Guide	When you add servers to a server group, the default ports are used if you do not specify ports.

➤ **Configuring the VRF Attribute of an AAA Server Group**

Command	ip vrf forwarding <i>vrf_name</i>
Parameter Description	<i>vrf_name</i> : Indicates the name of a VRF table.
Command Mode	Server group configuration mode
Usage Guide	Use this command to assign a VRF table to the specified server group.

Configuration Example

➤ **Creating an AAA Server Group**

Create RADIUS server groups named g1 and g2. The IP addresses of the servers in g1 are 10.1.1.1 and 10.1.1.2, and the IP addresses of the servers in g2 are 10.1.1.3 and 10.1.1.4.

<p>Scenario Figure 1-12</p>	
<p>Prerequisites</p>	<ol style="list-style-type: none"> 1. The required interfaces, IP addresses, and VLANs have been configured on the network, network connections have been set up, and the routes from the NAS to servers are reachable. 2. Enable AAA.
<p>Configuration Steps</p>	<p>Step 1: Configure a server (which belongs to the default server group). Step 2: Create user-defined AAA server groups. Step 3: Add servers to the AAA server groups.</p>
<p>NAS</p>	<pre> FS#configure terminal FS(config)#radius-server host 10.1.1.1 FS(config)#radius-server host 10.1.1.2 FS(config)#radius-server host 10.1.1.3 FS(config)#radius-server host 10.1.1.4 FS(config)#radius-server key secret FS(config)#aaa group server radius g1 FS(config-gs-radius)#server 10.1.1.1 FS(config-gs-radius)#server 10.1.1.2 FS(config-gs-radius)#exit FS(config)#aaa group server radius g2 FS(config-gs-radius)#server 10.1.1.3 FS(config-gs-radius)#server 10.1.1.4 FS(config-gs-radius)#exit </pre>
<p>Verification</p>	<p>Run the show aaa group and show run commands on the NAS to display the configuration.</p>
<p>NAS</p>	<pre> FS#show aaa group </pre>

Type	Reference	Name
radius	1	radius
tacacs+	1	tacacs+
radius	1	g1
radius	1	g2

```

FS#show run
!
radius-server host 10.1.1.1
radius-server host 10.1.1.2
radius-server host 10.1.1.3
radius-server host 10.1.1.4
radius-server key secret
!
aaa group server radius g1
  server 10.1.1.1
  server 10.1.1.2
!
aaa group server radius g2
  server 10.1.1.3
  server 10.1.1.4
!
!
    
```

Common Errors

- For RADIUS servers that use non-default authentication and accounting ports, when you run the **server** command to add servers, specify the authentication or accounting port.
- Only the RADIUS server group can be configured with the VRF attribute.

1.4.5 Configuring the Domain-Based AAA Service

Configuration Effect

Create AAA schemes for 802.1X users in different domains.

Notes

About referencing method lists in domains:

- The AAA method lists that you select in domain configuration mode should be defined in advance. If the method lists are not defined in advance, when you select them in domain configuration mode, the system prompts that the configurations do not exist.
- The names of the AAA method lists selected in domain configuration mode must be consistent with those of the method lists defined for the AAA service. If they are inconsistent, the AAA service cannot be properly provided to the users in the domain.

About the default domain:

- Default domain: After the domain-based AAA service is enabled, if a username does not carry domain information, the AAA service is provided to the user based on the default domain. If the domain information carried by the username is not configured in the system, the system determines that the user is unauthorized and will not provide the AAA service to the user. If the default domain is not configured initially, it must be created manually.
- When the domain-based AAA service is enabled, the default domain is not configured by default and needs to be created manually. The default domain name is **default**. It is used to provide the AAA service to the users whose usernames do not carry domain information. If the default domain is not configured, the AAA service is not available for the users whose usernames do not carry domain information.

About domain names:

- The domain names carried by usernames and those configured on the NAS are matched in the longest matching principle. For example, if two domains, **domain.com** and **domain.com.cn** are configured on a NAS and a user sends a request carrying **aaa@domain.com**, the NAS determines that the user belongs to **domain.com**, instead of **domain.com.cn**.
- If the username of an authenticated user carries domain information but the domain is not configured on the NAS, the AAA service is not provided to the user.

Configuration Steps

▾ Enabling AAA

- Mandatory.
- Run the **aaa new-model** command to enable AAA.
- By default, AAA is disabled.

▾ Enabling the Domain-Based AAA Service

- Mandatory.
- Run the **aaa domain enable** command to enable the domain-based AAA service.
- By default, the domain-based AAA service is disabled.

▾ Creating a Domain and Entering Domain Configuration Mode

- Mandatory.
- Run the **aaa domain** command to create a domain or enter the configured domain.
- By default, no domain is configured.

▾ Associating the Domain with an 802.1X Authentication Method List

- Run the **authentication login** command to associate the domain with the login authentication method list.
- Run the **authentication enable** command to associate the domain with the enable authentication method list.

- This configuration is mandatory if you need to specify the login or enable authentication method list to the domain.
- If no authentication method list is specified, the default list is enabled.

↘ **Associating the Domain with a Network Accounting Method List**

- Run the **accounting network** command to associate the domain with a network accounting method.
- This configuration is mandatory if you need to apply a specified network accounting method list to the domain.
- If a domain is not associated with a network accounting method list, by default, the global default method list is used for accounting.

↘ **Associating the Domain with a Commands, or EXEC Accounting Method List**

- Run the **accounting {commands | exec} { default | list-name }** command to associate the domain with a commands, or EXEC accounting method.
- This configuration is mandatory if you need to apply a specified commands, or EXEC accounting method list to the domain.
- If a domain is not associated with a commands, or EXEC accounting method list, by default, the global default method list is used for accounting.

↘ **Associating the Domain with a Network Authorization Method List**

- Run the **authorization network** command to associate the domain with a network authorization method list.
- This configuration is mandatory if you need to apply a specified network authorization method list to the domain.
- If a domain is not associated with a network authorization method list, by default, the global default method list is used for authorization.

↘ **Associating the Domain with a Commands, or EXEC Authorization Method List**

- Run the **authorization {commands | exec} { default | list-name }** command to associate the domain with a commands, or EXEC authorization method list.
- This configuration is mandatory if you need to apply a specified commands or EXEC authorization method list to the domain.
- If a domain is not associated with a commands or EXEC authorization method list, by default, the global default method list is used for authorization.

↘ **Configuring the Domain Status**

- Optional.
- When a domain is in Block state, the users in the domain cannot log in.
- By default, after a domain is created, its state is Active, indicating that all the users in the domain are allowed to request network services.

↘ **Configuring Whether to Contain the Domain Name in Usernames**

- Optional.
- By default, the usernames exchanged between the NAS and an authentication server carry domain information.

↘ **Configuring the Maximum Number of Domain Users**

- Optional.

- By default, the maximum number of access users allowed in a domain is not limited.

Verification

Run the **show aaa domain** command to verify the configuration.

Related Commands

↘ Enabling AAA

Command	aaa new-model
Parameter	N/A
Description	
Command Mode	Global configuration mode
Usage Guide	To enable the AAA services, run this command. None of the rest of AAA commands can be effective if AAA is not enabled.

↘ Enabling the Domain-Based AAA Service

Command	aaa domain enable
Parameter	N/A
Description	
Command Mode	Global configuration mode
Usage Guide	Use this command to enable the domain-based AAA service.

↘ Creating a Domain and Entering Domain Configuration Mode

Command	aaa domain { default domain-name }
Parameter	default: Uses this parameter to configure the default domain.
Description	<i>domain-name:</i> Indicates the name of the domain to be created.
Command Mode	Global configuration mode
Usage Guide	Use this command to configure a domain to provide the domain-based AAA service. The default parameter specifies the default domain. If a username does not carry domain information, the NAS uses the method list associated with the default domain to provide the AAA service to the user. The <i>domain-name</i> parameter specifies the name of the domain to be created. If the domain name carried by a username matches the configured domain name, the NAS uses the method list associated with this domain to provide the AAA service to the user. The system supports a maximum of 32 domains.

↘ Associating the Domain with a Login Authentication Method List

Command	authentication login { default list-name }
Parameter	default: Indicates that the default method list is used.
Description	<i>list-name:</i> Indicates the name of the method list to be associated.
Command Mode	Domain configuration mode
Usage Guide	Use this command to associate the domain with a login authentication method list.

↘ Associating the Domain with an Enable Authentication Method List

Command	authentication enable { default <i>list-name</i> }
Parameter	default: Indicates that the default method list is used.
Description	<i>list-name:</i> Indicates the name of the method list to be associated.
Command Mode	Domain configuration mode
Usage Guide	Use this command to associate the domain with an Enable authentication method list.

↘ Associating the Domain with a Network Accounting Method List

Command	accounting network { default <i>list-name</i> }
Parameter	default: Indicates that the default method list is used.
Description	<i>list-name:</i> Indicates the name of the method list to be associated.
Command Mode	Domain configuration mode
Usage Guide	Use this command to associate the domain with a network accounting method list.

↘ Associating the Domain with a Commands Accounting Method List

Command	accounting commands { default <i>list-name</i> }
Parameter	default: Indicates that the default method list is used.
Description	<i>list-name:</i> Indicates the name of the method list to be associated.
Command Mode	Domain configuration mode
Usage Guide	Use this command to associate the domain with a Commands accounting method list.

↘ Associating the Domain with an EXEC Accounting Method List

Command	accounting exec { default <i>list-name</i> }
Parameter	default: Indicates that the default method list is used.
Description	<i>list-name:</i> Indicates the name of the method list to be associated.
Command Mode	Domain configuration mode
Usage Guide	Use this command to associate the domain with an EXEC accounting method list.

↘ Associating the Domain with a Network Authorization Method List

Command	authorization network { default <i>list-name</i> }
Parameter	default: Indicates that the default method list is used.
Description	<i>list-name:</i> Indicates the name of the method list to be associated.
Command Mode	Domain configuration mode
Usage Guide	

↘ Associating the Domain with a Commands Authorization Method List

Command	authorization commands { default <i>list-name</i> }
Parameter	default: Indicates that the default method list is used.
Description	<i>list-name:</i> Indicates the name of the method list to be associated.

Command	Domain configuration mode
Mode	
Usage Guide	N/A

↘ **Associating the Domain with an EXEC Authorization Method List**

Command	authorization exec { default <i>list-name</i> }
Parameter	default: Indicates that the default method list is used.
Description	<i>list-name:</i> Indicates the name of the method list to be associated.
Command	Domain configuration mode
Mode	
Usage Guide	N/A

↘ **Configuring the Domain Status**

Command	state { block active }
Parameter	block: Indicates that the configured domain is invalid.
Description	active: Indicates that the configured domain is valid.
Command	Domain configuration mode
Mode	
Usage Guide	Use this command to make the configured domain valid or invalid.

↘ **Configuring Whether to Contain the Domain Name in Usernames**

Command	username-format { without-domain with-domain }
Parameter	without-domain: Indicates to remove domain information from usernames.
Description	with-domain: Indicates to keep domain information in usernames.
Command	Domain configuration mode
Mode	
Usage Guide	Use this command in domain configuration mode to determine whether to include domain information in usernames when the NAS interacts with authentication servers in a specified domain.

Common Errors

N/A

1.4.6 Configuring a Login Switch for the AAA Slave Device

Configuration Effect

When the switch is turned on, the slave device is allowed to login; otherwise, the slave device cannot login.

The configuration remains valid unless a change is made.

Notes

The **aaa new-model** command should be run first.

Configuration Steps

↘ **Configuring a Login Switch for the AAA Slave Device**

- Optional.
- By default, the slave device is not allowed to login.

Verification

Run the **show run** command to verify the configuration.

Related Commands

▾ **Configuring a Login Switch for the AAA Slave Device**

Command	aaa slave-login allow
Parameter	N/A
Description	
Command Mode	Global configuration mode
Usage Guide	By default, the switch is off, so the slave device is not allowed to login. When the switch is turned on, the slave device can login.

Configuration Example

▾ **Configuring a Login Switch for the AAA Slave Device**

Scenario Figure 1-13	
Configuration Steps	<p>The following example shows how to configure a login switch for the AAA slave device</p> <p>Step 1: Enable AAA.</p> <p>Step 2: Turn on the login switch.</p>
NAS	<pre>FS#configure terminal FS(config)#aaa new-model FS(config)#aaa slave-login allow</pre>
Verification	Run the show run command on the NAS to display the configuration.
NAS	<pre>FS#sh run inc aaa</pre>
	<pre>aaa new-model aaa slave-login allow</pre>

Common Errors

N/A

1.4.7 Configuring Authorization Result Caching

Configuration Effect

After this feature is configured, the AAA module caches authorization results returned from the server. Therefore, later authorizations at the same level can be operated based on the cache.

Notes

The cached authorization results, originating from specific levels of sessions and commands, can be applied only to sessions and commands at these levels.

Configuration Steps

Configuring Authorization Result Caching

- Optional.
- By default, authorization results are not cached.

Verification

Run the **show run** command to verify the configuration.

Related Commands

Configuring Authorization Result Caching

Command	aaa command-author cache
Parameter	N/A
Description	
Command Mode	Global configuration mode
Usage Guide	The AAA device caches authorization results returned from the server. Therefore, later authorizations at the same level can be operated based on the cached resources.

Configuration Example

Configuring Authorization Result Caching

Scenario Figure 1-14	
Configuration Steps	<p>The following example shows how to configure authorization result caching</p> <p>Step 1: Enable AAA.</p> <p>Step 2: Turn on the login switch.</p> <p>Step 3: Configure authorization result caching.</p>
NAS	<pre>FS#configure terminal FS(config)#aaa new-model</pre>

	<pre>FS(config)#aaa command-author cache FS(config)# aaa authorization commands 15 default group tacacs+</pre>
Verification	Run the show run command on the NAS to display the configuration.
NAS	<pre>FS#sh run inc aaa</pre>
	<pre>aaa new-model aaa authorization commands 15 default group tacacs+ aaa command-author cache</pre>

Common Errors

N/A

1.5 Monitoring

Clearing

Description	Command
Clears the locked users.	clear aaa local user lockout {all user-name <i>username</i> }

Displaying

Description	Command
Displays the accounting update information.	show aaa accounting update
Displays the current domain configuration.	show aaa domain
Displays the current lockout configuration.	show aaa lockout
Displays the AAA server groups.	show aaa group
Displays the AAA method lists.	show aaa method-list
Displays the AAA users.	show aaa user

2 Configuring RADIUS

2.1 Overview

The Remote Authentication Dial-In User Service (RADIUS) is a distributed client/server system.

RADIUS works with the Authentication, Authorization, and Accounting (AAA) to conduct identity authentication on users who attempt to access a network, to prevent unauthorized access. In FSOS implementation, a RADIUS client runs on a device or Network Access Server (NAS) and transmits identity authentication requests to the central RADIUS server, where all user identity authentication information and network service information are stored. In addition to the authentication service, the RADIUS server provides authorization and accounting services for access users.

RADIUS is often applied in network environments that have high security requirements and allow the access of remote users. RADIUS is a completely open protocol and the RADIUS server is installed on many operating systems as a component, for example, on UNIX, Windows 2000, and Windows 2008. Therefore, RADIUS is the most widely applied security server currently.

The Dynamic Authorization Extensions to Remote Authentication Dial In User Service is defined in the IETF RFC3576. This protocol defines a user offline management method. Devices communicate with the RADIUS server through the Disconnect-Messages (DMs) to bring authenticated users offline. This protocol implements compatibility between devices of different vendors and the RADIUS server in terms of user offline processing.

In the DM mechanism, the RADIUS server actively initiates a user offline request to a device, the device locates a user according to the user session information, user name, and other information carried in the request and brings the user offline. Then, the device returns a response packet that carries the processing result to the RADIUS server, thereby implementing user offline management of the RADIUS server.

Protocols and Standards

- RFC2865: Remote Authentication Dial In User Service (RADIUS)
- RFC2866: RADIUS Accounting
- RFC2867: RADIUS Accounting Modifications for Tunnel Protocol Support
- RFC2869: RADIUS Extensions
- RFC3576: Dynamic Authorization Extensions to Remote Authentication Dial In User Service (RADIUS)

2.2 Applications

Application	Description
Providing Authentication, Authorization, and Accounting Services for Access Users	Authentication, authorization, and accounting are conducted on access users on a network, to prevent unauthorized access or operations.
Forcing Users to Go Offline	The server forces an authenticated user to go offline.

2.2.1 Providing Authentication, Authorization, and Accounting Services for Access Users

Scenario

RADIUS is typically applied in the authentication, authorization, and accounting of access users. A network device serves as a RADIUS client and transmits user information to a RADIUS server. After completing processing, the RADIUS server returns the authentication acceptance/authentication rejection/accounting response information to the RADIUS client. The RADIUS client performs processing on the access user according to the response from the RADIUS server.

Figure 2- 1 Typical RADIUS Networking Topology

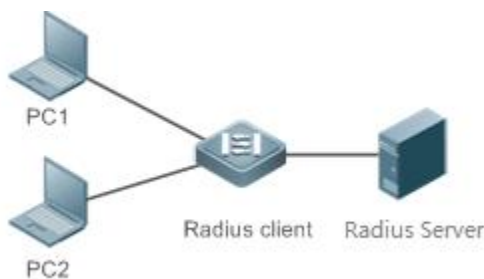

Remarks	PC 1 and PC 2 are connected to the RADIUS client as access users in wired or wireless mode, and initiate authentication and
----------------	---

accounting requests.

The RADIUS client is usually an access switch or aggregate switch.

The RADIUS server can be a component built in the Windows 2000/2003, Server (IAS), or UNIX operating system or dedicated server software provided by vendors.

Deployment

- Configure access device information on the RADIUS server, including the IP address and shared key of the access devices.
- Configure the AAA method list on the RADIUS client.
- Configure the RADIUS server information on the RADIUS client, including the IP address and shared key.
- Enable access control on the access port of the RADIUS client.
- Configure the network so that the RADIUS client communicates with the RADIUS server successfully.

2.2.2 Forcing Users to Go Offline

Scenario

The RADIUS server forces authenticated online users to go offline for the sake of management.

See Figure 2- 1 for the networking topology.

Deployment

- Add the following deployment on the basis of 1.2.1 "Deployment".
- Enable the RADIUS dynamic authorization extension function on the RADIUS client.

2.3 Features

Basic Concepts

📌 Client/Server Mode

- Client: A RADIUS client initiates RADIUS requests and usually runs on a device or NAS. It transmits user information to the RADIUS server, receives responses from the RADIUS server, and performs processing accordingly. The processing includes accepting user access, rejecting user access, or collecting more user information for the RADIUS server.
- Server: Multiple RADIUS clients map to one RADIUS server. The RADIUS server maintains the IP addresses and shared keys of all RADIUS clients as well as information on all authenticated users. It receives requests from a RADIUS client, conducts authentication, authorization, and accounting, and returns processing information to the RADIUS client.

📌 Structure of RADIUS Packets

The following figure shows the structure of RADIUS packets.

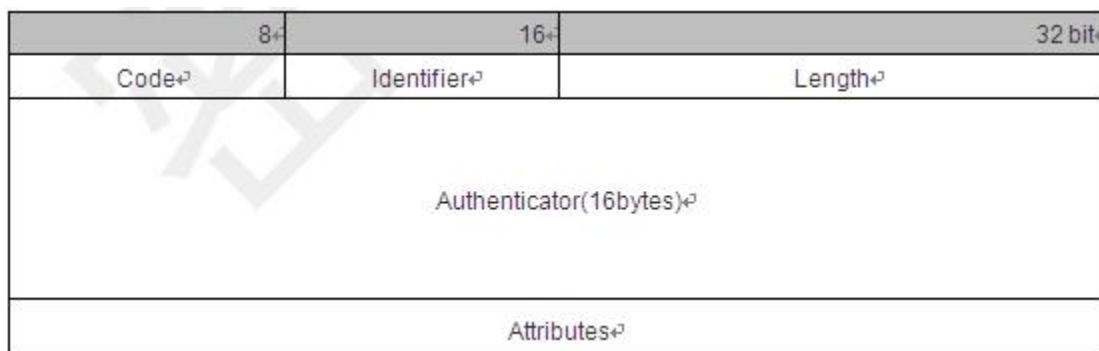

- Code: Identifies the type of RADIUS packets, which occupies one byte. The following table lists the values and meanings.

Code	Packet Type	Code	Packet Type
1	Access-Request	4	Accounting-Request
2	Access-Accept	5	Accounting-Response
3	Access-Reject	11	Access-Challenge

- Identifier: Indicates the identifier for matching request packets and response packets, which occupies one byte. The identifier values of request packets and response packets of the same type are the same.
- Length: Identifies the length of a whole RADIUS packet, which includes **Code**, **Identifier**, **Length**, **Authenticator**, and **Attributes**. It occupies two bytes. Bytes that are beyond the **Length** field will be truncated. If the length of a received packet is smaller than the value of **Length**, the packet is discarded.
- Authenticator: Verifies response packets of the RADIUS server by a RADIUS client, which occupies 16 bytes. This field is also used for encryption/decryption of user passwords.
- Attributes: Carries authentication, authorization, and accounting information, with the length unfixed. The **Attributes** field usually contains multiple attributes. Each attribute is represented in the Type, Length, Value (TLV) format. Type occupies one byte and indicates the attribute type. The following table lists common attributes of RADIUS authentication, authorization, and accounting. Length occupies one byte and indicates the attribute length, with the unit of bytes. Value indicates the attribute information.

Attribute No.	Attribute Name	Attribute No.	Attribute Name
1	User-Name	43	Acct-Output-Octets
2	User-Password	44	Acct-Session-Id
3	CHAP-Password	45	Acct-Authentic
4	NAS-IP-Address	46	Acct-Session-Time
5	NAS-Port	47	Acct-Input-Packets
6	Service-Type	48	Acct-Output-Packets
7	Framed-Protocol	49	Acct-Terminate-Cause
8	Framed-IP-Address	50	Acct-Multi-Session-Id
9	Framed-IP-Netmask	51	Acct-Link-Count
10	Framed-Routing	52	Acct-Input-Gigawords
11	Filter-ID	53	Acct-Output-Gigawords
12	Framed-MTU	55	Event-Timestamp
13	Framed-Compression	60	CHAP-Challenge
14	Login-IP-Host	61	NAS-Port-Type

Attribute No.	Attribute Name	Attribute No.	Attribute Name
15	Login-Service	62	Port-Limit
16	Login-TCP-Port	63	Login-LAT-Port
18	Reply-Message	64	Tunnel-Type
19	Callback-Number	65	Tunnel-Medium-Type
20	Callback-ID	66	Tunnel-Client-Endpoint
22	Framed-Route	67	Tunnel-Server-Endpoint
23	Framed-IPX-Network	68	Acct-Tunnel-Connection
24	State	69	Tunnel-Password
25	Class	70	ARAP-Password
26	Vendor-Specific	71	ARAP-Features
27	Session-Timeout	72	ARAP-Zone-Access
28	Idle-Timeout	73	ARAP-Security
29	Termination-Action	74	ARAP-Security-Data
30	Called-Station-Id	75	Password-Retry
31	Calling-Station-Id	76	Prompt
32	NAS-Identifier	77	Connect-Info
33	Proxy-State	78	Configuration-Token
34	Login-LAT-Service	79	EAP-Message
35	Login-LAT-Node	80	Message-Authenticator
36	Login-LAT-Group	81	Tunnel-Private-Group-id
37	Framed-AppleTalk-Link	82	Tunnel-Assignment-id
38	Framed-AppleTalk-Network	83	Tunnel-Preference
39	Framed-AppleTalk-Zone	84	ARAP-Challenge-Response
40	Acct-Status-Type	85	Acct-Interim-Interval
41	Acct-Delay-Time	86	Acct-Tunnel-Packets-Lost
42	Acct-Input-Octets	87	NAS-Port-Id

➤ Shared Key

A RADIUS client and a RADIUS server mutually confirm their identities by using a shared key during communication. The shared key cannot be transmitted over a network. In addition, user passwords are encrypted for transmission for the sake of security.

➤ RADIUS Server Group

The RADIUS security protocol, also called RADIUS method, is configured in the form of a RADIUS server group. Each RADIUS method corresponds to one RADIUS server group and one or more RADIUS servers can be added to one RADIUS server group. For details about the RADIUS method, see the *Configuring AAA*. If you add multiple RADIUS servers to one RADIUS server group, when the communication between a device and the first RADIUS server in this group fails or the first RADIUS server becomes unreachable, the device automatically attempts to communicate with the next RADIUS server till the communication is successful or the communication with all the RADIUS servers fails.

➤ RADIUS Attribute Type

- Standard attributes

- The RFC standards specify the RADIUS attribute numbers and attribute content but do not specify the format of some attribute types. Therefore, the format of attribute contents needs to be configured to adapt to different RADIUS server requirements. Currently, the format of the RADIUS Calling-Station-ID attribute (attribute No.: 31) can be configured.

The RADIUS Calling-Station-ID attribute is used to identify user identities when a network device transmits request packets to the RADIUS server. The RADIUS Calling-Station-ID attribute is a string, which can adopt multiple formats. It needs to uniquely identify a user. Therefore, it is often set to the MAC address of a user. For example, when IEEE 802.1X authentication is used, the Calling-Station-ID attribute is set to the MAC address of the device where the IEEE 802.1X client is installed. The following table describes the format of MAC addresses.

Format	Description
ietf	Indicates the standard format specified in the IETF standard (RFC3580), which is separated by the separator (-). Example: 00-D0-F8-33-22-AC
Normal	Indicates the common format that represents a MAC address (dotted hexadecimal format), which is separated by the separator (.). Example: 00d0.f833.22ac
Unformatted	Indicates the format without separators. This format is used by default. Example: 00d0f83322ac

- Private attributes

RADIUS is an extensible protocol. According to RFC2865, the Vendor-Specific attribute (attribute No.: 26) is used by device vendors to extend the RADIUS protocol to implement private functions or functions that are not defined in the standard RADIUS protocol. Table 1-3 lists private attributes supported by FS products. The **TYPE** column indicates the default configuration of private attributes of FS products and the **Extended TYPE** column indicates the default configuration of private attributes of other non-FS products.

ID	Function	TYPE	Extended TYPE
1	max-down-rate	1	76
2	port-priority	2	77
3	user-ip	3	3
4	vlan-id	4	4
5	last-supplicant-version	5	5
6	net-ip	6	6
7	user-name	7	7
8	password	8	8
9	file-directory	9	9
10	file-count	10	10
11	file-name-0	11	11
12	file-name-1	12	12
13	file-name-2	13	13
14	file-name-3	14	14
15	file-name-4	15	15
16	max-up-rate	16	16
17	current-supplicant-version	17	17
18	flux-max-high32	18	18
19	flux-max-low32	19	19

ID	Function	TYPE	Extended TYPE
20	proxy-avoid	20	20
21	dailup-avoid	21	21
22	ip-privilege	22	22
23	login-privilege	42	42
27	ipv4-multicast-address	87	87
62	sdg-type	62	62
85	sdg-zone-name	85	85
103	sdg-group-name	103	103

Overview

Feature	Description
RADIUS Authentication, Authorization, and Accounting	Conducts identity authentication and accounting on access users, safeguards network security, and facilitates management for network administrators.
Source Address of RADIUS Packets	Specifies the source IP address used by a RADIUS client to transmit packets to a RADIUS server.
RADIUS Timeout Retransmission	Specifies the packet retransmission parameter for a RADIUS client when a RADIUS server does not respond to packets transmitted from the RADIUS client within a period of time.
RADIUS Server Accessibility Detection	Enables a RADIUS client to actively detect whether a RADIUS server is reachable and maintain the accessibility of each RADIUS server. A reachable RADIUS server is selected preferentially to improve the handling performance of RADIUS services.
RADIUS Forced Offline	Enables a RADIUS server to actively force authenticated users to go offline.

2.3.1 RADIUS Authentication, Authorization, and Accounting

Conduct identity authentication and accounting on access users, safeguard network security, and facilitate management for network administrators.

Working Principle

Figure 2-2

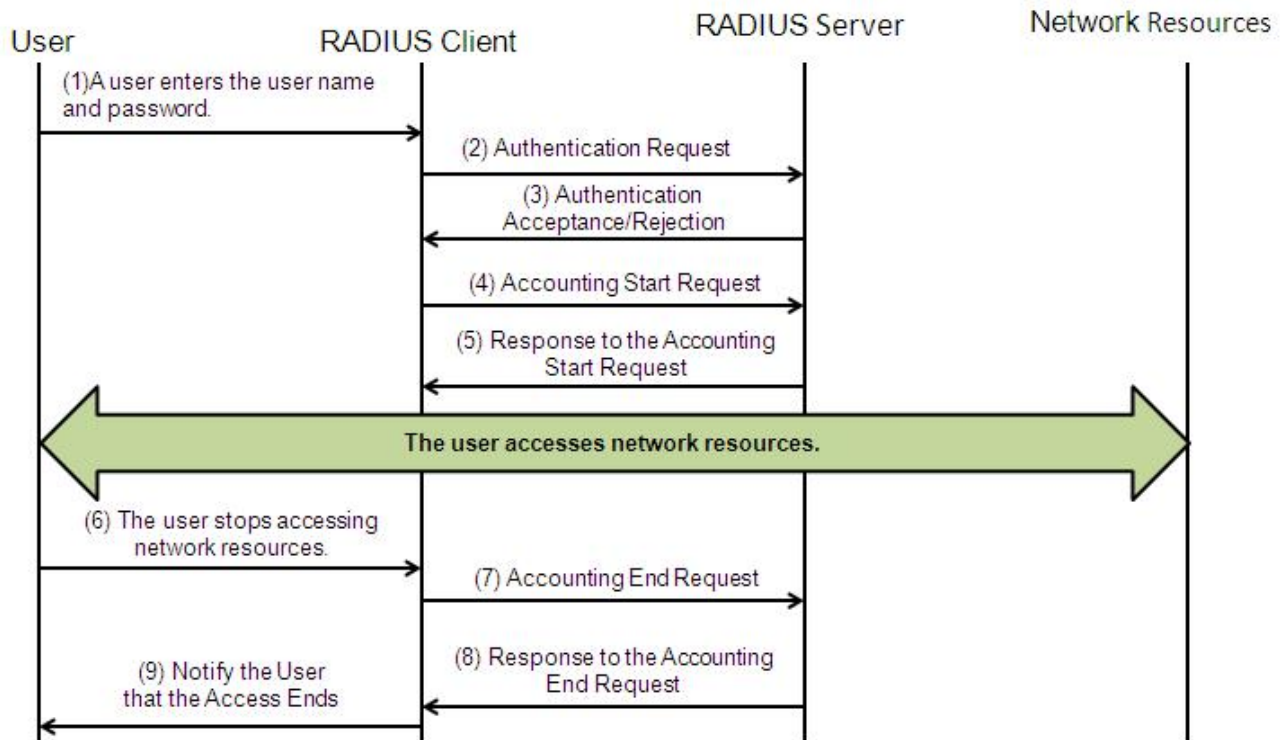

The RADIUS authentication and authorization process is described as follows:

1. A user enters the user name and password and transmits them to the RADIUS client.
2. After receiving the user name and password, the RADIUS client transmits an authentication request packet to the RADIUS server. The password is encrypted for transmission. For the encryption method, see RFC2865.
3. The RADIUS server accepts or rejects the authentication request according to the user name and password. When accepting the authentication request, the RADIUS server also issues authorization information apart from the authentication acceptance information. The authorization information varies with the type of access users.

The RADIUS accounting process is described as follows:

1. If the RADIUS server returns authentication acceptance information in Step (3), the RADIUS client sends an accounting start request packet to the RADIUS server immediately.
2. The RADIUS server returns the accounting start response packet, indicating accounting start.
3. The user stops accessing network resources and requests the RADIUS client to disconnect the network connection.
4. The RADIUS client transmits the accounting end request packet to the RADIUS server.
5. The RADIUS server returns the accounting end response packet, indicating accounting end.
6. The user is disconnected and cannot access network resources.

Related Configuration

➤ Configuring RADIUS Server Parameters

No RADIUS server is configured by default.

You can run the **radius-server host** command to configure a RADIUS server.

At least one RADIUS server must be configured so that RADIUS services run normally.

✚ **Configuring the AAA Authentication Method List**

No AAA authentication method list is configured by default.

You can run the **aaa authentication** command to configure a method list for different user types and select **group radius** when setting the authentication method.

The RADIUS authentication can be conducted only after the AAA authentication method list of relevant user types is configured.

✚ **Configuring the AAA Authorization Method List**

No AAA authorization method list is configured by default.

You can run the **aaa authorization** command to configure an authorization method list for different user types and select **group radius** when setting the authorization method.

The RADIUS authorization can be conducted only after the AAA authorization method list of relevant user types is configured.

✚ **Configuring the AAA Accounting Method List**

No AAA accounting method list is configured by default.

You can run the **aaa accounting** command to configure an accounting method list for different user types and select **group radius** when setting the accounting method.

The RADIUS accounting can be conducted only after the AAA accounting method list of relevant user types is configured.

2.3.2 Source Address of RADIUS Packets

Specify the source IP address used by a RADIUS client to transmit packets to a RADIUS server.

Working Principle

When configuring RADIUS, specify the source IP address to be used by a RADIUS client to transmit RADIUS packets to a RADIUS server, in an effort to reduce the workload of maintaining a large amount of NAS information on the RADIUS server.

Related Configuration

The global routing is used to determine the source address for transmitting RADIUS packets by default.

Run the **ip radius source-interface** command to specify the source interface for transmitting RADIUS packets. The device uses the first IP address of the specified interface as the source address of RADIUS packets.

2.3.3 RADIUS Timeout Retransmission

Working Principle

After a RADIUS client transmits a packet to a RADIUS server, a timer is started to detect the response of the RADIUS server. If the RADIUS server does not respond within a certain period of time, the RADIUS client retransmits the packet.

Related Configuration

✚ **Configuring the RADIUS Server Timeout Time**

The default timeout time is 5 seconds.

You can run the **radius-server timeout** command to configure the timeout time. The value ranges from 1 second to 1,000 seconds.

The response time of a RADIUS server is relevant to its performance and the network environment. Set an appropriate timeout time according to actual conditions.

✚ **Configuring the Retransmission Count**

The default retransmission count is 3.

You can run the **radius-server retransmit** command to configure the retransmission count. The value ranges from 1 to 100.

✚ **Configuring Whether to Retransmit Accounting Update Packets**

Accounting update packets are not retransmitted by default.

You can run the **radius-server account update retransmit** command to configure retransmission of accounting update packets for authenticated users.

2.3.4 RADIUS Server Accessibility Detection

Working Principle

A RADIUS client actively detects whether a RADIUS server is reachable and maintains the accessibility of each RADIUS server. A reachable RADIUS server is selected preferentially to improve the handling performance of RADIUS services.

Related Configuration

✚ **Configuring the Criteria for the Device to Judge That a RADIUS Server Is Unreachable**

The default criteria configured for judging that a RADIUS server is unreachable meet the two conditions simultaneously: 1. The device does not receive a correct response packet from the RADIUS security server within 60 seconds. 2. The device transmits the request packet to the same RADIUS security server for consecutive 10 times.

You can run the **radius-server dead-criteria** command to configure the criteria for the device to judge that the RADIUS security server is unreachable.

✚ **Configuring the Test User Name for Actively Detecting the RADIUS Security Server**

No test user name is specified for actively detecting the RADIUS security server by default.

You can run the **radius-server host x.x.x.testusername xxx** command to configure the test user name.

2.3.5 RADIUS Forced Offline

Working Principle

Figure 2-3 DM Message Exchange of the RADIUS Dynamic Authorization Extension Protocol



The preceding figure shows the exchange of DM messages between the RADIUS server and the device. The RADIUS server transmits the Disconnect-Request message to UDP Port 3799 of the device. After processing, the device returns the Disconnect-Response message that carries the processing result to the RADIUS server.

Related Configuration

N/A

2.4 Configuration

Configuration	Description and Command	
RADIUS Basic Configuration	(Mandatory) It is used to configure RADIUS authentication, authorization, and accounting.	
	radius-serverhost	Configures the IP address of the remote RADIUS security server.
	radius-serverkey	Configures the shared key for communication between the device and the RADIUS server.
	radius-serverretransmit	Configures the request transmission count, after which the device confirms that a RADIUS server is unreachable.
	radius-servertimeout	Configures the waiting time, after which the device retransmits a request.
	radius-server account update retransmit	Configures retransmission of accounting update packets for authenticated users.
	ip radius source-interface	Configures the source address of RADIUS packets.
Configuring the RADIUS Attribute Type	(Optional) It is used to define attribute processing adopted when the device encapsulates and parses RADIUS packets.	
	radius-serverattribute31	Configures the MAC address format of RADIUS attribute No. 31 (Calling-Station-ID).
	radius set qoscos	Sets the private attribute port-priority issued by the server to the COS value of an interface. For COS-relevant concepts, see the <i>Configuring QoS</i> .
	radius support cui	Configures the device to support the CUI attribute.
Configuring RADIUS Accessibility Detection	(Optional) It is used to detect whether a RADIUS server is reachable and maintain the accessibility of the RADIUS server.	
	radius-server dead-criteria	Configures the global criteria for judging that a RADIUS security server is unreachable.
	radius-server deadtime	Configures the duration for the device to stop transmitting

Configuration	Description and Command	
		request packets to an unreachable RADIUS server.
	radius-server host	Configures the IP address of the remote RADIUS security server, authentication port, accounting port, and active detection parameters.

2.4.1 RADIUS Basic Configuration

Configuration Effect

- RADIUS authentication, authorization, and accounting can be conducted after RADIUS basic configuration is complete.

Notes

- Before configuring RADIUS on the device, ensure that the network communication of the RADIUS server is in good condition.
- When running the **ip radius source-interface** command to configure the source address of RADIUS packets, ensure that the device of the source IP address communicates with the RADIUS server successfully.

Configuration Steps

↘ **Configuring the Remote RADIUS Security Server**

- Mandatory.
- Configure the IP address, authentication port, accounting port, and shared key of the RADIUS security server.

↘ **Configuring the Shared Key for Communication Between the Device and the RADIUS Server**

- Optional.
- Configure a shared key in global configuration mode for servers without a shared key.

 The shared key on the device must be consistent with that on the RADIUS server.

↘ **Configuring the Request Transmission Count, After Which the Device Confirms That a RADIUS Server Is Unreachable**

- Optional.
- Configure the request transmission count, after which the device confirms that a RADIUS server is unreachable, according to the actual network environment.

↘ **Configuring the Waiting Time, After which the Device Retransmits a Request**

- Optional.
- Configure the waiting time, after which the device retransmits a request, according to the actual network environment.

 In an 802.1X authentication environment that uses the RADIUS security protocol, if a network device serves as the 802.1X authenticator and FS SU is used as the 802.1X client software, it is recommended that **radius-server timeout** be set to 3 seconds (the default value is 5 seconds) and **radius-server retransmit** be set to 2 (the default value is 3) on the network device.

↘ **Configuring the Source Address of RADIUS Packets**

- Optional.
- Configure the source address of RADIUS packets according to the actual network environment.

Verification

- Configure the AAA method list that specifies to conduct authentication, authorization, and accounting on users by using RADIUS.
- Enable the device to interact with the RADIUS server. Conduct packet capture to confirm that the device communicates with the RADIUS server over the RADIUS protocol.

Related Commands

📌 **Configuring the Remote RADIUS Security Server**

Command	radius-server host [oob [via <i>mgmt_name</i>]] { <i>ipv4-address</i> } [auth-port <i>port-number</i>] [acct-port <i>port-number</i>][test username <i>name</i> [idle-time <i>time</i>] [ignore-auth-port] [ignore-acct-port]] [key [0 7] <i>text-string</i>]
Parameter Description	<p>oob: Indicates oob authentication, that is, the source interface for transmitting packets to the RADIUS server is an mgmt port.</p> <p>via<i>mgmt_name</i>: Specifies a specific mgmt port when oob supports multiple mgmt ports.</p> <p><i>ipv4-address</i>: Indicates the IPv4 address of the RADIUS security server.</p> <p>auth-port<i>port-number</i>: Indicates the UDP port for RADIUS identity authentication. The value ranges from 0 to 65,535. If it is set to 0, the host does not conduct identity authentication.</p> <p>acct-port <i>port-number</i>: Indicates the UDP port for RADIUS accounting. The value ranges from 0 to 65,535. If it is set to 0, the host does not conduct accounting.</p> <p>test username <i>name</i>: Enables the function of actively detecting the RADIUS security server and specifies the user name used for active detection.</p> <p>idle-time<i>time</i>: Indicates the interval for the device to transmit test packets to a reachable RADIUS security server. The default value is 60 minutes. The value ranges from 1 minute to 1,440 minutes (24 hours).</p> <p>ignore-auth-port: Disables the function of detecting the authentication port of the RADIUS security server. It is enabled by default.</p> <p>ignore-acct-port: Disables the function of detecting the accounting port of the RADIUS security server. It is enabled by default.</p> <p>key[0 7] <i>text-string</i> : Configures the shared key of the server. The global shared key is used if it is not configured.</p>
Command Mode	Global configuration mode
Usage Guide	A RADIUS security server must be defined to implement the AAA security service by using RADIUS. You can run the radius-server host command to define one or more RADIUS security servers. If a RADIUS security server is not added to a RADIUS server group, the device uses the global routing table when transmitting RADIUS packets to the RADIUS server. Otherwise, the device uses the VRF routing table of the RADIUS server group.

📌 **Configuring the Shared Key for Communication Between the Device and the RADIUS Server**

Command	radius-server key [0 7] <i>text-string</i>
Parameter Description	<p><i>text-string</i>: Indicates the text of the shared key.</p> <p>0 7: Indicates the encryption type of the key. The value 0 indicates no encryption and 7 indicates simple encryption. The default value is 0.</p>
Command Mode	Global configuration mode
Usage Guide	A shared key is the basis for correct communication between the device and the RADIUS security server. The same shared key must be configured on the device and RADIUS security server so that they can communicate with each other

	successfully.
--	---------------

↘ **Configuring the Request Transmission Count, After Which the Device Confirms That a RADIUS Server Is Unreachable**

Command	radius-server retransmit <i>retries</i>
Parameter Description	<i>retries</i> : Indicates the RADIUS retransmission count. The value ranges from 1 to 100.
Command Mode	Global configuration mode
Usage Guide	The prerequisite for AAA to use the next user authentication method is that the current security server used for authentication does not respond. The criteria for the device to judge that a security server does not respond are that the security server does not respond within the RADIUS packet retransmission duration of the specified retransmission count. There is an interval between consecutive two retransmissions.

↘ **Configuring the Waiting Time, After which the Device Retransmits a Request**

Command	radius-server timeout <i>seconds</i>
Parameter Description	<i>seconds</i> : Indicates the timeout time, with the unit of seconds. The value ranges from 1 second to 1,000 seconds.
Command Mode	Global configuration mode
Usage Guide	Use this command to adjust the packet retransmission timeout time.

↘ **Configuring Retransmission of Accounting Update Packets for Authenticated Users**

Command	radius-server account update retransmit
Parameter Description	N/A
Command Mode	Global configuration mode
Usage Guide	Configure retransmission of accounting update packets for authenticated users. Accounting update packets are not retransmitted by default. The configuration does not affect users of other types.

Configuration Example

↘ **Using RADIUS Authentication, Authorization, and Accounting for Login Users**

<p>Scenario Figure 2-4</p>	
<p>Configuration Steps</p>	<ul style="list-style-type: none"> ● Enable AAA. ● Configure the RADIUS server information. ● Configure to use the RADIUS authentication, authorization, and accounting methods. ● Apply the configured authentication method on the interface.
<p>RADIUS Client</p>	<pre> FS#configure terminal FS (config)#aaa new-model FS (config)# radius-server host 192.168.5.22 FS (config)#radius-server host 3000::100 FS (config)# radius-server key aaa FS (config)#aaa authentication login test group radius FS (config)#aaa authorizationexec test group radius FS (config)#aaa accountingexec test start-stop group radius FS (config)# line vty 0 4 FS (config-line)#login authentication test FS (config-line)# authorization exec test FS (config-line)# accounting exec test </pre>
<p>Verification</p>	<p>Telnet to a device from a PC. The screen requesting the user name and password is displayed. Enter the correct user name and password to log in to the device. After obtaining a certain access level granted by the server, only run commands under this access level. Display the authentication log of the user on the RADIUS server. Perform management operations on the device as the user and then log out. Display the accounting information on the user on the RADIUS server.</p>
	<pre> FS#show running-config ! radius-server host 192.168.5.22 radius-server host 3000::100 </pre>

```

radius-server key aaa

aaa new-model

aaa accounting exec test start-stop group radius

aaa authorization exec test group radius

aaa authentication login test group radius

no service password-encryption

iptcp not-send-rst

!

vlan 1

!

line con 0

line vty 0 4

    accounting exec test

    authorization exec test

    login authentication test

!

```

Common Errors

- The key configured on the device is inconsistent with that configured on the server.
- No method list is configured.

2.4.2 Configuring the RADIUS Attribute Type

Configuration Effect

- Define the attribute processing adopted when the device encapsulates and parses RADIUS packets.

Notes

- Private attributes involved in "Configuring the RADIUS Attribute Type" refer to FS private attributes.

Configuration Steps

↘ Configuring the MAC Address Format of RADIUS Attribute No. 31 (Calling-Station-ID)

- Optional.
- Set the MAC address format of **Calling-Station-Id** to a type supported by the server.

↘ Configuring the RADIUS Private Attribute Type

- Optional.
- If the server is a FS application server, the RADIUS private attribute type needs to be configured.

➤ **Setting the Private Attribute port-priority Issued by the Server to the COS Value of an Interface**

- Optional.
- Set the private attribute **port-priority** issued by the server to the COS value of an interface as required.

➤ **Configures the Device to Support the CUI Attribute**

- Optional.
- Configure whether the device supports the RADIUS CUI attribute as required.

➤ **Configuring the Mode of Parsing Private Attributes by the Device**

- Optional.
- Configure the index of a FS private attribute parsed by the device as required.

Verification

- Configure the AAA method list that specifies to conduct authentication, authorization, and accounting on users by using RADIUS.
- Enable the device to interact with the RADIUS server. Conduct packet capture to display the MAC address format of Calling-Station-Id.
- Enable the device to interact with the RADIUS server. Display the debug information of the device to check that FS private attributes are correctly parsed by the device.
- Enable the device to interact with the RADIUS server. Display the debug information of the device to check that the CUI attribute is correctly parsed by the device.

Related Commands

➤ **Configuring the MAC Address Format of RADIUS Attribute No. 31 (Calling-Station-ID)**

Command	radius-server attribute 31 mac format {ietf normal unformatted }
Parameter Description	<p>ietf: Indicates the standard format specified in the IETF standard (RFC3580), which is separated by the separator (-). Example: 00-D0-F8-33-22-AC.</p> <p>normal: Indicates the common format that represents a MAC address (dotted hexadecimal format), which is separated by the separator (.). Example: 00d0.f833.22ac.</p> <p>unformatted: Indicates the format without separators. This format is used by default. Example: 00d0f83322ac.</p>
Command Mode	Global configuration mode
Usage Guide	Some RADIUS security servers can identify only MAC addresses in the IETF format. In this case, set the MAC address format of Calling-Station-ID to IETF.

➤ **Setting the Private Attribute port-priority Issued by the Server to the COS Value of an Interface**

Command	radius set qoscos
Parameter Description	N/A
Command Mode	Global configuration mode

Usage Guide	Configure this command to use the issued QoS value as the CoS value. The QoS value is used as the DSCP value by default.
--------------------	--

↘ **Configures the Device to Support the CUI Attribute**

Command	radius support cui
Parameter	N/A
Description	
Command Mode	Global configuration mode
Usage Guide	Configure this command to enable the RADIUS-compliant device to support the CUI attribute.

↘ **Configuring the Mode of Parsing Private Attributes by the Device**

Command	Radius vendor-specific extend
Parameter	N/A
Description	
Command Mode	Global configuration mode
Usage Guide	Use this command to identify attributes of all vendor IDs by type.

Configuration Example

↘ **Configuring the RADIUS Attribute Type**

Scenario	One authentication device
Configuration Steps	<ul style="list-style-type: none"> ● Configure the MAC address format of RADIUS Calling-Station-Id. ● Set the QoS value issued by the RADIUS server as the COS value of the interface. ● Configure the RADIUS function to support the CUI attribute. ● Configure the device to support private attributes of other vendors.
	<pre>FS(config)#radius-server attribute 31 mac format ietf FS(config)#radiussetqoscos FS(config)#radiussupport cui FS(config)#radiusvendor-specific extend</pre>
Verification	Conduct packet capture or display debug information of the device to check whether the RADIUS standard attributes and private attributes are encapsulated/parsed correctly.

2.4.3Configuring RADIUS Accessibility Detection

Configuration Effect

The device maintains the accessibility status of each configured RADIUS server: reachable or unreachable. The device will not transmit authentication, authorization, and accounting requests of access users to an unreachable RADIUS server unless all the other servers in the same RADIUS server group as the unreachable server are all unreachable.

The device actively detects a specified RADIUS server. The active detection function is disabled by default. If the active detection function is enabled for a specified RADIUS server, the device will, according to the configuration, periodically transmits detection requests (authentication requests or accounting requests) to the RADIUS server. The transmission interval is as follows:

- For a reachable RADIUS server, the interval is the active detection interval of the reachable RADIUS server (the default value is 60 minutes).
- For an unreachable RADIUS server, the interval is always 1 minute.

Notes

All the following conditions need to be met before the active detection function is enabled for a specified RADIUS server:

- The test user name of the RADIUS server is configured on the device.
- At least one tested port (authentication port or accounting port) of the RADIUS server is configured on the device.

If the following two conditions are all met, it is deemed that a reachable RADIUS server becomes unreachable:

- After the previous correct response is received from the RADIUS server, the time set in **radius-server dead-criteria timeseconds** has elapsed.
- After the previous correct response is received from the RADIUS server, the count that the device transmits requests to the RADIUS server but fails to receive correct responses (including retransmission) reaches the value set in **radius-server dead-criteria triesnumber**.

If any of the following conditions is met, it is deemed that an unreachable RADIUS server becomes reachable:

- The device receives correct responses from the RADIUS server.
- The duration that the RADIUS server is in the unreachable state exceeds the time set in **radius-server deadtime** and the active detection function is disabled for the RADIUS server.
- The authentication port or accounting port of the RADIUS server is updated on the device.

Configuration Steps

✚ **Configuring the Global Criteria for Judging That a RADIUS Security Server Is Unreachable**

- Mandatory.
- Configuring the global criteria for judging that a RADIUS security server is unreachable is a prerequisite for enabling the active detection function.

✚ **Configuring the IP Address of the Remote RADIUS Security Server, Authentication Port, Accounting Port, and Active Detection Parameters**

- Mandatory.
- Configuring active detection parameters of the RADIUS server is a prerequisite for enabling the active detection function.

✚ **Configuring the Duration for the Device to Stop Transmitting Request Packets to an Unreachable RADIUS Server**

- Optional.
- The configured duration for the device to stop transmitting request packets to an unreachable RADIUS server takes effect only when the active detection function is disabled for the RADIUS server.

Verification

- Run the **show radius server** command to display the accessibility information of each RADIUS server.

Related Commands

➤ **Configuring the Global Criteria for Judging That a RADIUS Security Server Is Unreachable**

Command	radius-server dead-criteria { <i>timeseconds</i> [<i>triesnumber</i>] <i>triesnumber</i> }
Parameter Description	<p>timeseconds: Indicates the time condition parameter. If the device fails to receive a correct response packet from a RADIUS security server within the specified time, it is deemed that the RADIUS security server meets the inaccessibility duration condition. The value ranges from 1 second to 120 seconds.</p> <p>triesnumber: Indicates the consecutive request timeout count. If the timeout count of request packets transmitted by the device to the same RADIUS security server reaches the preset count, it is deemed that the RADIUS security server meets the consecutive timeout count condition of inaccessibility. The value ranges from 1 to 100.</p>
Command Mode	Global configuration mode
Usage Guide	If a RADIUS security server meets both the duration condition and the consecutive request timeout count condition, it is deemed that the RADIUS security server is unreachable. Users can use this command to adjust parameter values in the duration condition and consecutive request timeout count condition.

➤ **Configuring the Duration for the Device to Stop Transmitting Request Packets to an Unreachable RADIUS Server**

Command	Radius-server deadtime <i>minutes</i>
Parameter Description	<i>minutes</i> : Indicates the duration for the device to stop transmitting requests to an unreachable RADIUS security server, with the unit of minutes. The value ranges from 1 minute to 1,440 minutes (24 hours).
Command Mode	Global configuration mode
Usage Guide	If the active detection function is enabled for a RADIUS security server on the device, the time parameter in radius-server deadtime does not take effect on the RADIUS server. If the active detection function is disabled for a RADIUS security server, the device automatically restores the RADIUS security server to the reachable state when the duration that the RADIUS security server is in the unreachable state exceeds the time specified in radius-server deadtime .

Configuration Example

➤ **Configuring Accessibility Detection on the RADIUS Server**

Scenario Figure 2-5	
Configuration Steps	<ul style="list-style-type: none"> ● Configure the global criteria for judging that a RADIUS security server is unreachable. ● Configure the IP address of the remote RADIUS security server, authentication port, accounting port, and active detection parameters.
RADIUS Client	<pre>FS(config)#radius-server dead-criteria time120 tries 5 FS(config)# radius-server host 192.168.5.22 test username test ignore-acct-port idle-time 90</pre>

Verification	Disconnect the network communication between the device and the server with the IP address of 192.168.5.22. Conduct RADIUS authentication through the device. After 120 seconds, run the show radius server command to check that the server state is dead .
	<pre>FS#show running-config ... radius-server host 192.168.5.22 test username test ignore-acct-port idle-time 90 radius-server dead-criteria time 120 tries 5 ...</pre>

2.5 Monitoring

Clearing



Running the **clear** commands may lose vital information and thus interrupt services.

Description	Command
Clears statistics of the RADIUS dynamic authorization extension function and restarts statistics.	clear radius dynamic-authorization-extension statistics

Displaying

Description	Command
Displays global parameters of the RADIUS server.	show radius parameter
Displays the configuration of the RADIUS server.	show radius server
Displays the configuration of the RADIUS private attribute type.	show radius vendor-specific
Displays statistics relevant to the RADIUS dynamic authorization extension function.	show radius dynamic-authorization-extension statistics
Displays statistics relevant to RADIUS authentication.	show radius auth statistics
Displays statistics relevant to RADIUS accounting.	show radius acct statistics
Displays configuration of RADIUS server groups.	show radius group

Debugging



System resources are occupied when debugging information is output. Therefore, disable debugging immediately after use.

Description	Command
Debugs the RADIUS event.	debugradius event
Debugs RADIUS packet printing.	debugradius detail

Debugs the RADIUS dynamic authorization extension function.	debug radiusextension event
Debugs the RADIUS dynamic authorization extension packet printing.	debug radius extension detail

3 Configuring TACACS+

3.1 Overview

TACACS+ is a security protocol enhanced in functions based on the Terminal Access Controller Access Control System (TACACS) protocol. It is used to implement the authentication, authorization, and accounting (AAA) of multiple users.

Protocols and Standards

- RFC 1492 Terminal Access Controller Access Control System

3.2 Applications

Application	Description
Managing and Controlling Login of End Users	Password verification and authorization need to be conducted on end users.

3.2.1 Managing and Controlling Login of End Users

Scenario

TACACS+ is typically applied in the login management and control of end users. A network device serves as the TACACS+ client and sends a user name and password to the TACACS+ server for verification. The user is allowed to log in to the network device and perform operations after passing the verification and obtaining authorization. See the following figure.

Figure 3- 1

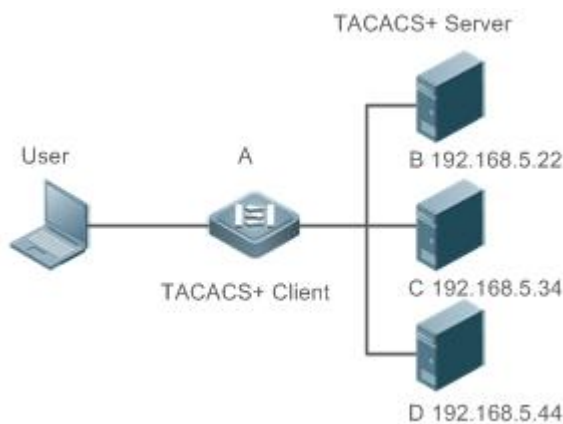

Remarks	<ul style="list-style-type: none"> ● A is a client that initiates TACACS+ requests. ● B, C, and D are servers that process TACACS+ requests.
----------------	--

Deployment

- Start the TACACS+ server on Server B, Server C, and Server D, and configure information on the access device (Device A) so that the servers provide TACACS+-based AAA function for the access device. Enable the AAA function on Device A to start authentication for the user login.
- Enable the TACACS+ client function on Device A, add the IP addresses of the TACACS+ servers (Server B, Server C, and Server D) and the shared key so that Device A communicates with the TACACS+ servers over TACACS+ to implement the AAA function.

3.3 Features

Basic Concepts

Format of TACACS+ Packets

Figure 3- 2

4	8	16	24	32 bit
Major	Minor	Packet type	Sequence no.	Flags
Session ID				
Length				

- Major Version: Indicates the major TACACS+ version number.
- Minor Version: Indicates the minor TACACS+ version number.
- Packet Type: Indicates the type of packets, with the options including:
 TAC_PLUS_AUTHEN: = 0x01 (authentication);
 TAC_PLUS_AUTHOR: = 0x02 (authorization);
 TAC_PLUS_ACCT: = 0x03 (accounting)
- Sequence Number: Indicates the sequence number of a data packet in the current session. The sequence number of the first TACACS+ data packet in a session must be 1 and the sequence number of subsequent each data packet increases by one. Therefore, the client sends data packets only with an odd sequence number and TACACS+ Daemon sends packets only with an even sequence number.
- Flags: Contains various bitmap format flags. One of the bits in the value specifies whether data packets need to be encrypted.
- Session ID: Indicates the ID of a TACACS+ session.
- Length: Indicates the body length of a TACACS+ data packet (excluding the header). Packets are encrypted for transmission on a network.

Overview

Feature	Description
TACACS+ Authentication, Authorization, and Accounting	Conducts authentication, authorization, and accounting on end users.

3.3.1 TACACS+ Authentication, Authorization, and Accounting

Working Principle

The following figure uses basic authentication, authorization, and accounting of user login to describe interaction of TACACS+ data packets.

Figure 3- 3

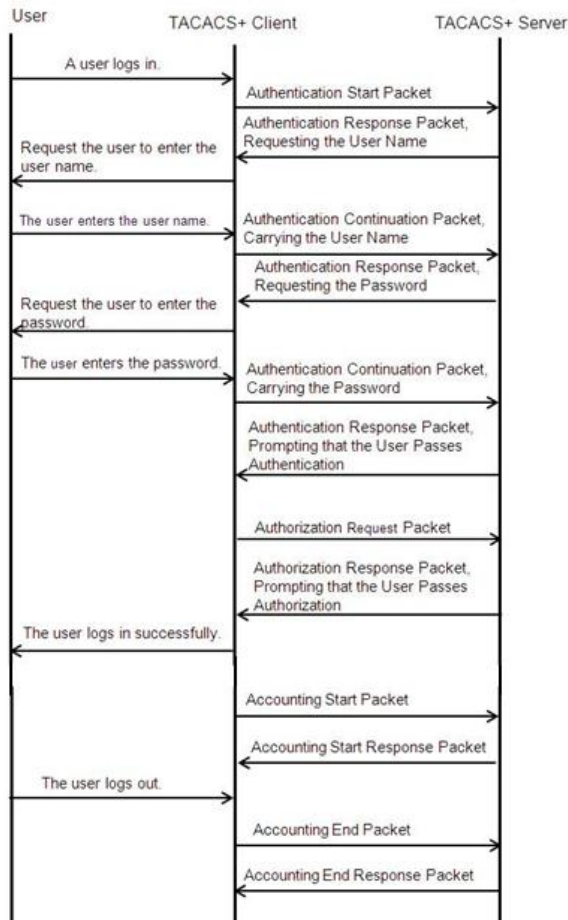

The entire basic message interaction process includes three sections:

1. The authentication process is described as follows:
 - 1) A user requests to log in to a network device.
 - 2) After receiving the request, the TACACS+ client sends an authentication start packet to the TACACS+ server.
 - 3) The TACACS+ server returns an authentication response packet, requesting the user name.
 - 4) The TACACS+ client requests the user to enter the user name.
 - 5) The user enters the login user name.
 - 6) After receiving the user name, the TACACS+ client sends an authentication continuation packet that carries the user name to the TACACS+ server.
 - 7) The TACACS+ server returns an authentication response packet, requesting the login password.
 - 8) The TACACS+ client requests the user to enter the login password.
 - 9) The user enters the login password.
 - 10) After receiving the login password, the TACACS+ client sends an authentication continuation packet that carries the login password to the TACACS+ server.

- 11) The TACACS+ server returns an authentication response packet, prompting that the user passes authentication.
2. The user authorization starts after successful authentication:
 - 1) The TACACS+ client sends an authorization request packet to the TACACS+ server.
 - 2) The TACACS+ server returns an authorization response packet, prompting that the user passes authorization.
 - 3) After receiving the authorization success packet, the TACACS+ client outputs the network device configuration screen for the user.
3. Accounting and audit need to be conducted on the login user after successful authorization:
 - 1) The TACACS+ client sends an accounting start packet to the TACACS+ server.
 - 2) The TACACS+ server returns an accounting response packet, prompting that the accounting start packet has been received.
 - 3) The user logs out.
 - 4) The TACACS+ client sends an accounting end packet to the TACACS+ server.
 - 5) The TACACS+ server returns an accounting response packet, prompting that the accounting end packet has been received.

3.4 Configuration

Configuration	Description and Command	
Configuring TACACS+ Basic Functions	(Mandatory) It is used to enable the TACACS+ security service.	
	tacacs-server host	Configures the TACACS+ server.
	tacacs-server key	Specifies the key shared by the server and network device.
	tacacs-server timeout	Configures the global waiting timeout time of the TACACS+ server for communication between a network device and the TACACS+ server.
Configuring Separate Processing of Authentication, Authorization, and Accounting of TACACS+	(Optional) It is used to separately process authentication, authorization, and accounting requests.	
	aaa group server tacacs+	Configures TACACS+ server groups and divides TACACS+ servers into different groups.
	nas-ip	Configures the source IP address for TACACS+ packets sent from the TACACS+ server group.
	server	Adds servers to TACACS+ server groups.

3.4.1 Configuring TACACS+ Basic Functions

Configuration Effect

- The TACACS+ basic functions are available after the configuration is complete. When configuring the AAA method list, specify the method of using TACACS+ to implement TACACS+ authentication, authorization, and accounting.

- When authentication, authorization, and accounting operations are performed, TACACS+ initiates the authentication, authorization, and accounting requests to configured TACACS+ servers according to the configured sequence. If response timeout occurs on a TACACS+ server, TACACS+ traverses the TACACS+ server list in sequence.

Notes

- The TACACS+ security service is a type of AAA service. You need to run the **aaa new-model** command to enable the security service.
- Only one security service is provided after TACACS+ basic functions are configured. To make the TACACS+ functions take effect, specify the TACACS+ service when configuring the AAA method list.

Configuration Steps

📌 **Enabling AAA**

- Mandatory. The AAA method list can be configured only after AAA is enabled. TACACS+ provides services according to the AAA method list.

Command	aaa new-model
Parameter	N/A
Description	
Defaults	The AAA function is disabled.
Command Mode	Global configuration mode
Usage Guide	The AAA method list can be configured only after AAA is enabled. TACACS+ provides services according to the AAA method list.

📌 **Configuring the IP Address of the TACACS+ Server**

- Mandatory. Otherwise, a device cannot communicate with the TACACS+ server to implement the AAA function.

Command	tacacs-server host [oob] [via mgmt_name] { ipv4-address ipv6-address } [port integer] [timeout integer] [key [0 7] text-string]
Parameter Description	<p><i>ipv4-address</i>: Indicates the IPv4 address of the TACACS+ server.</p> <p><i>ipv6-address</i>: Indicates the IPv6 address of the TACACS+ server.</p> <p>oob: Uses an MGMT port as the source interface for communicating with the TACACS+ server. A non-MGMT port is used for communication by default.</p> <p>via mgmt_name: Specifies a specific MGMT port when oob supports multiple MGMT ports.</p> <p>port integer: Indicates the TCP port used for TACACS+ communication. The default TCP port is 49.</p> <p>timeout integer: Indicates the timeout time of the communication with the TACACS+ server. The global timeout time is used by default.</p> <p>key [0 7] text-string: Indicates the shared key of the server. The global key is used if it is not configured. An encryption type can be specified for the configured key. The value 0 indicates no encryption and 7 indicates simple encryption. The default value is 0.</p>
Defaults	No TACACS+ server is configured.
Command Mode	Global configuration mode
Usage Guide	17. You can specify the shared key of the server when configuring the IP address of the server. If no shared key is

	<p>specified, the global key configured using the tacacs-server key command is used as the shared key of the server. The shared key must be completely the same as that configured on the server.</p> <p>18. You can specify the communication port of the server when configuring the IP address.</p> <p>19. You can specify the communication timeout time of the server when configuring the IP address.</p>
--	--

▾ **Configuring the Shared Key of the TACACS+ Server**

- Optional.
- If no global communication protocol is configured using this command, set **key** to specify the shared key of the server when running the **tacacs-server host** command to add server information. Otherwise, a device cannot communicate with the TACACS+ server.
- If no shared key is specified by using **key** when you run the **tacacs-server host** command to add server information, the global key is used.

Command	tacacs-server [key [0 7] text-string]
Parameter	<i>text-string</i> : Indicates the text of the shared key.
Description	0 7 : Indicates the encryption type of the key. The value 0 indicates no encryption and 7 indicates simple encryption.
Defaults	No shared key is configured for any TACACS+ server.
Command Mode	Global configuration mode
Usage Guide	This command is used to configure a global shared key for servers. To specify a different key for each server, set key when running the tacacs-server host command.

▾ **Configuring the Timeout Time of the TACACS+ Server**

- Optional.
- You can set the timeout time to a large value when the link between the device and the server is unstable.

Command	tacacs-server timeoutseconds
Parameter Description	<i>seconds</i> : Indicates the timeout time, with the unit of seconds. The value ranges from 1 second to 1,000 seconds.
Defaults	The default value is 5 seconds.
Command Mode	Global configuration mode
Usage Guide	This command is used to configure the global server response timeout time. To set different timeout time for each server, set timeout when running the tacacs-server host command.

Verification

Configure the AAA method list that specifies to conduct authentication, authorization, and accounting on users by using TACACS+.

- Enable the device to interact with the TACACS+ server and conduct packet capture to check the TACACS+ interaction process between the device and the TACACS+ server.
- View server logs to check whether the authentication, authorization, and accounting are normal.

Configuration Example

▾ **Using TACACS+ for Login Authentication**

<p>Scenario</p> <p>Figure 3- 4</p>	
<p>Remarks</p>	<ul style="list-style-type: none"> ● A is a client that initiates TACACS+ requests. ● B is a server that processes TACACS+ requests.
<p>Configuration Steps</p>	<ul style="list-style-type: none"> ● Enable AAA. ● Configure the TACACS+ server information. ● Configure the method of using TACACS+ for authentication. ● Apply the configured authentication method on an interface.
<p>A</p>	<pre> FS# configure terminal FS(config)# aaa new-model FS(config)# tacacs-server host 192.168.5.22 FS(config)# tacacs-server key aaa FS(config)# aaa authentication login test group tacacs+ FS(config)# line vty 0 4 FS(config-line)# login authentication test </pre>
<p>Verification</p>	<p>Telnet to a device from a PC. The screen requesting the user name and password is displayed. Enter the correct user name and password to log in to the device. View the authentication log of the user on the TACACS+ server.</p>

Common Errors

- The AAA security service is disabled.
- The key configured on the device is inconsistent with the key configured on the server.
- No method list is configured.

3.4.2Configuring Separate Processing of Authentication, Authorization, and Accounting of TACACS+

Configuration Effect

- The authentication, authorization, and accounting in the security service are processed by different TACACS+ servers, which improves security and achieves load balancing to a certain extent.

Notes

- The TACACS+ security service is a type of AAA service. You need to run the **aaa new-model** command to enable the security service.

- Only one security service is provided after TACACS+ basic functions are configured. To make the TACACS+ functions take effect, specify the TACACS+ service when configuring the AAA method list.

Configuration Steps

▾ Configuring TACACS+ Server Groups

- Mandatory. There is only one TACACS+ server group by default, which cannot implement separate processing of authentication, authorization, and accounting.
- Three TACACS+ server groups need to be configured for separately processing authentication, authorization, and accounting.

Command	aaa group server tacacs+group-name
Parameter Description	<i>group-name</i> : Indicates the name of a group. A group name cannot be radius or tacacs+, which are the names of embedded groups.
Defaults	No TACACS+ server group is configured.
Command Mode	Global configuration mode
Usage Guide	Group TACACS+ servers so that authentication, authorization, and accounting are completed by different server groups.

▾ Adding Servers to TACACS+ Server Groups

- Mandatory. If no server is added to a server group, a device cannot communicate with TACACS+ servers.
- In server group configuration mode, add the servers that are configured using the **tacacs-server host** command.

Command	server { ipv4-address ipv6-address }
Parameter Description	<i>ipv4-address</i> : Indicates the IPv4 address of the TACACS+ server. <i>ipv6-address</i> : Indicates the IPv6 address of the TACACS+ server.
Defaults	No server is configured.
Command Mode	TACACS+ server group configuration mode
Usage Guide	Before configuring this command, you must run the aaa group server tacacs+ command to enter the TACACS+ server group configuration mode. For the address of a server configured in a TACACS+ server group, the server must be configured using the tacacs-server host command in global configuration mode. If multiple servers are added to one server group, when one server does not respond, the device continues to send a TACACS+ request to another server in the server group.

▾ Configuring the Source IP Address for TACACS+ Packets Sent from the TACACS+ Server Group

Command	nas-ip { ipv4-address ipv6-address }
Parameter Description	<i>ipv4-address</i> : Indicates the source IPv4 address for the TACACS+ packets. <i>ipv6-address</i> : Indicates the source IPv6 address for the TACACS+ packets.
Defaults	No source IP address is configured.
Command Mode	TACACS+ server group configuration mode

Mode	
Usage Guide	Before configuring this command, you must run the aaa group server tacacs+ command to enter the TACACS+ server group configuration mode.

▾ Configuring VRF of a TACACS+ Server Group

- Optional. Configure Virtual Routing and Forwarding (VRF) if a device needs to send TACACS+ packets through a specified address.
- In server group configuration mode, use a configured VRF name to specify the routing for the communication of servers in this group.

Command	ip vrf forwarding <i>vrf-name</i>
Parameter Description	<i>vrf-name</i> : Indicates the VRF name.
Defaults	No VRF is specified by default.
Command Mode	TACACS+ server group configuration mode
Usage Guide	Before configuring this command, you must run the aaa group server tacacs+ command to enter the TACACS+ server group configuration mode. For VRF configured in a TACACS+ server group, a valid name must be configured for VRF by using the vrf definition command in global configuration mode.

▾ Configuring oob of a TACACS+ Server Group

- Optional. Configure oob if a device needs to send TACACS+ packets through a specified MGMT port.
- In server group configuration mode, specify routing for the communication of servers in the group.

Command	ip oob via <i>mgmt_name</i>
Parameter Description	<i>mgmt-name</i> : Indicates the name of a management port.
Defaults	No oob is specified by default.
Command Mode	TACACS+ server group configuration mode
Usage Guide	Before configuring this command, you must run the aaa group server tacacs+ command to enter the TACACS+ server group configuration mode. If no MGMT port is specified, the MGMT0 port is used by default.

Verification

Configure the AAA method list that specifies to conduct authentication, authorization, and accounting on users by using TACACS+.

- Enable a device to interact with TACACS+ servers. Conduct packet capture, check that the authentication, authorization, and accounting packets are interacted with different servers, and check the source addresses in packets.

Configuration Example

➤ **Configuring Different TACACS+ Server Groups for Separately Processing Authentication, Authorization, and Accounting**

<p>Scenario Figure 3- 5</p>	
<p>Remarks</p>	<ul style="list-style-type: none"> ● A is a client that initiates TACACS+ requests. ● B is a server that processes TACACS+ authentication requests. ● C is a server that processes TACACS+ authorization requests. ● D is a server that processes TACACS+ accounting requests.
<p>Configuration Steps</p>	<ul style="list-style-type: none"> ● Enable AAA. ● Configure the TACACS+ server information. ● Configure TACACS+ server groups. ● Add servers to TACACS+ server groups. ● Configure the method of using TACACS+ for authentication. ● Configure the method of using TACACS+ for authorization. ● Configure the method of using TACACS+ for accounting. ● Apply the configured authentication method on an interface. ● Apply the configured authorization method on an interface. ● Apply the configured accounting method on an interface.
	<pre> FS# configure terminal FS(FS(config)# aaa new-model FS(config)# tacacs-server host 192.168.5.22 FS(config)# tacacs-server host 192.168.5.34 FS(config)# tacacs-server host 192.168.5.44 FS(config)# tacacs-server key aaa FS(config)# aaa group server tacacs+ tacgrp1 FS(config-gs-tacacs)# server 192.168.5.22 FS(config-gs-tacacs)# exit FS(config)# aaa group server tacacs+ tacgrp2 FS(config-gs-tacacs)# server 192.168.5.34 </pre>

	<pre> FS(config-gs-tacacs)# exit FS(config)# aaa group server tacacs+ tacgrp3 FS(config-gs-tacacs)# server 192.168.5.44 FS(config-gs-tacacs)# exit FS(config)# aaa authentication login test1 group tacacs+ FS(config)# aaa authentication enable default group tacgrp1 FS(config)# aaa authorization exec test2 group tacgrp2 FS(config)# aaa accounting commands 15 test3 start-stop group tacgrp3 FS(config)# line vty 0 4 FS(config-line)# login authentication test1 FS(config-line)#authorization exec test2 FS(config-line)# accounting commands 15 test3 </pre>
Verification	<p>Telnet to a device from a PC. The screen requesting the user name and password is displayed. Enter the correct user name and password to log in to the device. Enter the enable command and enter the correct enable password to initiate enable authentication. Enter the privilege EXEC mode after passing the authentication. Perform operations on the device and then exit the device.</p> <p>View the authentication log of the user on the server with the IP address of 192.168.5.22.</p> <p>View the enable authentication log of the user on the server with the IP address of 192.168.5.22.</p> <p>View the exec authorization log of the user on the server with the IP address of 192.168.5.34.</p> <p>View the command accounting log of the user on the server with the IP address of 192.168.5.44.</p>

Common Errors

- The AAA security service is disabled.
- The key configured on the device is inconsistent with the key configured on the server.
- Undefined servers are added to a server group.
- No method list is configured.

3.5 Monitoring

Displaying

Description	Command
Displays interaction with each TACACS+ server.	show tacacs

Debugging

System resources are occupied when debugging information is output. Therefore, disable debugging immediately after use.

Description	Command
Debugs TACACS+.	debug tacacs+

4 Configuring SCC

4.1 Overview

The Security Control Center (SCC) provides common configuration methods and policy integration for various access control and network security services, so that these access control and network security services can coexist on one device to meet diversified access and security control requirements in various scenarios.

The network security services include Access Control List (ACL), Network Foundation Protection Policy (NFPP), and anti-ARP gateway spoofing. When two or more access control or network security services are simultaneously enabled on the device, or when both access control and network security services are simultaneously enabled on the device, the SCC coordinates the coexistence of these services according to relevant policies.

i For details about the access control and network security services, see the related configuration guide. This document describes the SCC only.

Protocol and Standards

N/A

4.2 Application

Typical Application	Scenario
Access Control of Extended Layer 2 Campus Networks	Students on a campus network can access the Internet based on dot1x client authentication or Web authentication. ARP spoofing between the students should be prevented. In addition, terminal devices in some departments (such as the headmaster's office) can access the Internet without authentication.

4.2.1 Access Control of Extended Layer 2 Campus Networks

Scenario

Students on a campus network of a university usually need to be authenticated through the dot1x client or Web before accessing the Internet, so as to facilitate accounting and guarantee the benefits of the university.

- The students can access the Internet through dot1x client authentication or Web authentication.
- ARP spoofing between the students is prevented, so as to guarantee the stability of the network.
- Terminal devices in some departments (such as the headmaster's office) can access the Internet without authentication.

Figure 4-1

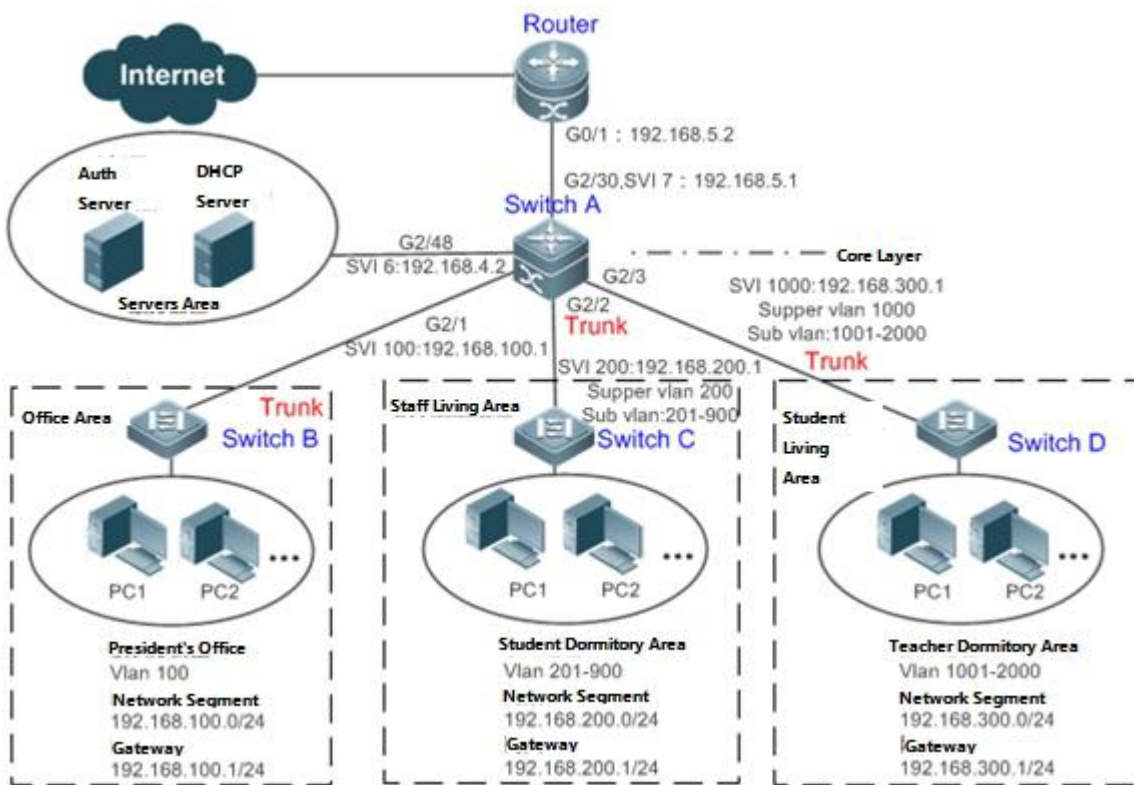

Remarks	<p>A traditional campus network is hierarchically designed, which consists of an access layer, a convergence layer and a core layer, where the access layer performs user access control. On an extended Layer 2 campus network, however, user access control is performed by a core switch, below which access switches exist without involving any convergence device in between. The ports between the core switch and the access switches (such as switches B, C, and D in Figure 1-1) are all trunk ports.</p> <p>The user access switches B, C, and D connect to PCs in various departments via access ports, and VLANs correspond to sub VLANs configured on the downlink ports of the core switch, so that access users are in different VLANs to prevent ARP spoofing.</p> <p>The core switch A connects to various servers, such as the authentication server and the DHCP server. Super VLANs and sub VLANs are configured on the downlink ports. One super VLAN correspond to multiple sub VLANs, and each sub VLAN represents an access user.</p>
----------------	--

Deployment

On the core switch, different access users are identified by VLAN and port numbers. Each access user (or a group of access users) corresponds to one VLAN. The ports on each access switch that connect to downstream users are configured as access ports, and one user VLAN is assigned to each access user according to VLAN planning. The core switch does not forward ARP requests. The core switch replies to the ARP requests from authenticated users only, so as to prevent ARP spoofing. On the core switch A, user VLANs are regarded as sub VLANs, super VLANs are configured, and SVIs corresponding to the super VLANs are configured as user gateways.

- On the downlink ports of the core switch (switch A in this example) that connect to the teachers' living area and the students' living area, both dot1x authentication and Web authentication are enabled, so that users can freely select either authentication mode for Internet access.

- Any special department (such as the headmaster's office in this example) can be allocated to a particular VLAN, and this VLAN can be configured as an authentication-exemption VLAN so that users in this department can access the Internet without authentication.

4.3 Features

Basic Concepts

📌 Authorization Mode

There are two authentication modes: access authentication and gateway authentication. On a traditional hierarchical network, access authentication is usually performed by access switches. On an extended Layer 2 network, the access function moves forward to a core switch while the access devices need only to support basic VLAN and Layer 2 forwarding functions. As the access authentication is performed by access switches on a traditional hierarchical network while performed by a core switch on a de-layered extended Layer 2 network, some extrinsic functions and behaviors will differ accordingly with the two different authentication modes. Therefore, the authentication mode falls into gateway authentication and access authentication. If the access authentication moves to the core switch, the core switch needs to be enabled with the gateway authentication mode to support a large number of user entries, typically including a large-capacity MAC address table, ARP table and routing table. Otherwise, the supported user capacity is subject to hardware ACL entry restrictions. In general, the capacity of hardware ACL entries is limited and cannot support a large user capacity. The access authentication mode is generally applicable only in scenarios where the access authentication is deployed on access switches.

📌 Authentication-Exemption VLAN

Some special departments may be allocated to authentication-exemption VLANs to simplify network management, so that users in these departments can access network resources without authentication. For example, the headmaster's office can be divided into the authentication-exemption VLANs on the campus network, so that users in the headmaster's office can access the Internet without authentication.

📌 IPv4 User Capacity

The number of IPv4 access users can be restricted to protect the access stability of online users on the Internet and improve the operational stability of the device.

 The number of IPv4 access users is not restricted by default; that is, a large number of users can get online after being authenticated, till reaching the maximum hardware capacity of the device.

 IPv4 access users include IP users (such as IP authenticated users) based on dot1x authentication, users based on Web authentication, and IP users manually bound (using IP source guard, ARP check, or other means).

📌 Authenticated-User Migration

Online-user migration means that an online user can get authenticated again from different physical locations to access the network. On the campus network, however, for ease of management, students are usually requested to get authenticated from a specified location before accessing the Internet, but cannot get authenticated on other access ports. This means that the users cannot migrate. In another case, some users have the mobile office requirement and can get authenticated from different access locations. Then the users can migrate.

📌 User Online-Status Detection

For a chargeable user, accounting starts immediately after the user passes the authentication and gets online. The accounting process does not end until the user actively gets offline. Some users, however, forget to get offline when leaving their PCs, or cannot get offline because of terminal problems. Then the users suffer certain economical losses as the accounting process continues. To more precisely determine whether a user is really online, we can preset a traffic value, so that the user is considered as not accessing the Internet and therefore directly brought offline when the user's traffic is lower than the preset value in a period of time or there is no traffic of the user at all in a period of time.

Overview

Feature	Function
Authentication Mode	This feature determines whether access control is deployed on access switches or core switches depending on network deployment needs.
Authentication-Exemption VLAN	Users in a specified VLAN can be configured as authentication-exemption users.
IPv4 User Capacity	The IPv4 user capacity of a specified interface can be restricted to guarantee the access stability of users on the Internet.
Authenticated-User Migration	You can specify whether the authenticated can migrate.
User Online-Status Detection	You can specify whether to detect the traffic of online users, so that a user is forced offline when the traffic of the user is lower than a preset value in a period of time.

4.3.1 Authentication Mode

There are two authentication modes: access authentication and gateway authentication. In access authentication mode, access control such as dot1x or Web authentication is enabled on access switches. In gateway authentication mode, access control is enabled on core switches. On a large-scale network such as a campus network, there are hundreds of access switches. Compared with the access authentication mode, the gateway authentication mode simplifies the routine maintenance and management on the access switches, because the access switches need only to support basic VLAN and Layer 2 forwarding functions. Therefore, the gateway authentication mode is recommended.

Working Principle

The authentication mode on a device depends on the network layer where the access control device works. If access control is deployed on core switches (for example, on an extended Layer 2 network), gateway authentication mode on core switches is required. If access control is deployed on access switches, the authentication mode should be set to access authentication on the access switches.

 The access authentication mode applies by default. In addition, only the N18000 switches support authentication mode switching.





 Restart the device after the authentication mode is changed, so that the new authentication mode takes effect. Save the current configuration before restarting the device.

4.3.2 Authentication-Exemption VLAN

Authentication-exemption VLANs are used to accommodate departments with special access requirements, so that users in these departments can access the Internet without authentication such as dot1x or Web authentication.

Working Principle

Suppose the authentication-exemption VLAN feature is enabled on a device. When the device detects that a packet comes from an authentication-exemption VLAN, access control is not performed. In this way, users in the authentication-exemption VLAN can access the Internet without authentication. The authentication-exemption VLAN feature can be regarded as a kind of applications of secure channels.



-  A maximum of 100 authentication-exemption VLANs can be configured.
-  The authentication-exemption VLANs occupy hardware entries. When access control such as authentication is disabled, configuring authentication-exemption VLANs has the same effect as the case where no authentication-exemption VLANs are configured. Therefore, it is recommended that authentication-exemption VLANs be configured for users who need to access the Internet without authentication, only when the access control function has been enabled.
-  Although packets from authentication-exemption VLANs are exempt from access control, they still need to be checked by a security ACL. If the packets of the users in an authentication-exemption VLAN are denied according to the security ACL, the users still cannot access the Internet.
-  In gateway authentication mode, the device does not initiate any ARP request to a user in an authentication-exemption VLAN, and the ARP proxy will not work. Therefore, in gateway authentication mode, users in different authentication-exemption VLANs cannot access each other unless the users have been authenticated.

4.3.3 IPv4 User Capacity

To improve the operational stability of the device and guard against brutal force impacts from unauthorized users, you can restrict the total number of IPv4 access users on a certain port of the device.

Working Principle

If the total number of IPv4 access users is restricted, new users going beyond the total number cannot access the Internet.

-  Only the switches support the restriction on the number of IPv4 access users.
-  The number of IPv4 access users is not restricted on the device by default, but depends on the hardware capacity of the device.
-  The number of IPv4 access users includes IPv4 users based on various binding functions. Because the number of IPv4 access users is configured in interface configuration mode, the restriction includes both the number of IPv4 users generated on the port and IPv4 users globally generated. For example, you can set the maximum number of IPv4 access users on the Gi 0/1 port to 2, run commands to bind an IPv4 user to the port, and then run commands to bind a global IPv4 user to the port. Actually there are already two access users on the port. If you attempt to bind another IPv4 user or another global IPv4 user to the port, the binding operation fails.





4.3.4 Authenticated-User Migration

On an actual network, users do not necessarily access the Internet from a fixed place. Instead, users may be transferred to another department or office after getting authenticated at one place. They do not actively get offline but remove network cables and carry their mobile terminals to the new office to access the network. Then this brings about an issue about authenticated-user migration. If

authenticated-user migration is not configured, a user who gets online at one place cannot get online at another place without getting offline first.

Working Principle

When authenticated-user migration is enabled, the dot1x or Web authentication module of the device detects that the port number or VLAN corresponding to a user's MAC address has changed. Then the user is forced offline and needs to be authenticated again before getting online.

-  Only the switches or wireless devices support authenticated-user migration. In addition, cross-switch migration is not supported. For example, authentication and migration are enabled on two N18000, and a user gets online after being authenticated on one of the two N18000. If the user attempts to migrate to the other N18000, the migration fails.
-  The authenticated-user migration function requires a check of users' MAC addresses, and is invalid for users who have IP addresses only.
-  The authenticated-user migration function enables a user who gets online at one place to get online at another place without getting offline first. If the user gets online at one place and then gets offline at that place, or if the user does not get online before moving to another place, the situation is beyond the control range of authenticated-user migration.
-  During migration, the system checks whether the VLAN ID or port number that corresponds to a user's MAC address has changed, so as to determine whether the user has migrated. If the VLAN ID or port number is the same, it indicates that the user does not migrate; otherwise, it indicates that the user has migrated. According to the preceding principle, if another user on the network uses the MAC address of an online user, the system will wrongly disconnect the online user unless extra judgment is made. To prevent such a problem, the dot1x or Web authentication will check whether a user has actually migrated. For a user who gets online through Web authentication or dot1x authentication with IP authorization, the dot1x or Web authentication sends an ARP request to the original place of the user if detecting that the same MAC address is online in another VLAN or on another port. If no response is received within the specified time, it indicates that the user's location has indeed changed and then the migration is allowed. If a response is received within the specified time, it indicates that the user actually does not migrate and a fraudulent user may exist on the network. In the latter case, the migration is not performed. The ARP request is sent once every second by default, and sent for a total of five times. This means that the migration cannot be confirmed until five seconds later. Timeout-related parameters, including the probe interval and probe times, can be changed using the **arp retry times times** and **arp retry interval interval** commands. For details about the specific configuration, see *ARP-SCG.doc*. It should be noted that the migration check requires the configuration of IP authorization for users based on dot1x authentication. In addition, the ARP probe is triggered only for user migration in gateway authentication mode but not triggered for user migration in access authentication mode.

4.3.5 User Online-Status Detection

After a user accesses the Internet, the user may forget to get offline or cannot actively get offline due to terminal faults. In this case, the user will keep being charged and therefore will suffer a certain economical loss. To protect the benefits of users on the Internet, the device provides a function to detect whether the users are really online. If the device considers that a user is not online, the device actively disconnects the user.

Working Principle

A specific detection interval is preset on the device. If a user's traffic is lower than a certain value in this interval, the device considers that the user is not using the network and therefore directly disconnects the user.

-  Only the switches and wireless devices support the user online-status detection function.

- The user online-status detection function applies to only users who get online through dot1x or Web authentication.
- Currently, the N18000 supports zero-traffic detection only.
- Currently, due to hardware chip restrictions of the N18000, the time to disconnect a user without any traffic relates to the configured MAC address aging time. If the traffic detection interval is set to m minutes and the MAC address aging time is set to n minutes, the interval from the moment when an authenticated user leaves the network without actively getting offline to the moment when the user is disconnected upon detection of zero traffic is about [m, m+n] minutes. In other words, if an online user does not incur any Internet access traffic, the user is disconnected about [m, m+n] minutes later.

4.4 Configuration

Configuration Item	Suggestions and Related Commands	
Configuring the Authentication Mode	Optional configuration, which is used to configure the authentication mode for the device.	
	[no] auth-mode gateway	Configures the authentication mode.
Configuring Authentication-Exemption VLANs	Optional configuration, which is used to specify the users of which VLANs can access the Internet without authentication.	
	[no] direct-vlan	Configures authentication-exemption VLANs.
Configuring the IPv4 User Capacity	Optional configuration, which is used to specify the maximum number of users who are allowed to access a certain interface.	
	[no] nac-author-user maximum	Configures the number of IPv4 users who are allowed to access a certain interface.
Configuring Authenticated-User Migration	Optional configuration, which is used to specify whether online users with static MAC addresses can migrate.	
	[no] station-move permit	Configures whether authenticated users can migrate.
Configuring User Online-Status Detection	Optional configuration, which is used to specify whether to enable the user online-status detection function.	
	offline-detect interval threshold	Configures the parameters of the user online-status detection function.
	no offline-detect	Disables the user online-status detection function.
	default offline-detect	Restores the default user online-status detection mode.

4.4.1 Configuring the Authentication Mode

Configuration Effect

Perform this configuration or not perform this configuration, which shall depend on actual network deployment. On a hierarchical network, access switches perform access control and you do not need to specify the authentication mode but can simply keep the default configuration. On a de-layered extended Layer 2 network, the gateway device performs access control and then you need to

set the authentication mode to gateway authentication, so that users can be authenticated and get online after the access control service such as dot1x or Web authentication is enabled on the gateway device.

Precautions

- If access control is deployed on the core switch, you need to change the authentication mode on the core switch to gateway authentication. If access control is not deployed on the core switch, you do not need to configure the authentication mode.
- You need to restart the device after the authentication mode is changed, so that the new authentication mode takes effect. Save the current configuration before restarting the device.

Configuration Method

▾ Configuring the Authentication Mode

- Optional configuration. It determines the access position of the device on the actual network.
- Perform the configuration according to actual network deployment. If the core switch performs access control, set the authentication mode to gateway authentication on the core switch; otherwise, simply keep the default configuration.

Command	[no] auth-mode gateway
Parameter Description	<p>no: If the command carries this parameter, it indicates that the authentication mode is restored to access authentication; that is, the local device is only an access device and not a gateway device any longer.</p> <p>auth-mode gateway: If the command carries this parameter, it indicates that the authentication mode is set to gateway authentication; that is, the local device is both a gateway device and an access device.</p>
Defaults	Access authentication mode
Command Mode	Global configuration mode
Usage Guide	<p>Use this command to determine the access position of the device on the network. Perform this configuration or not perform this configuration, which depends on whether the access control function is deployed on access switches on the network or deployed on the gateway device.</p> <p>Use this command to change the authentication mode configured on the device from access authentication to gateway authentication. Use the no auth-mode gateway command to change the authentication mode configured on the device from gateway authentication back to access authentication.</p>

Verification

Check the configuration using the following method:

- Enable dot1x or Web authentication on one port of the device, and perform corresponding authentication on the client. After getting online, check whether you can access network resources. Then get offline, and check whether you cannot access specified network resources.

Configuration Examples

 The following configuration example describes SCC-related configuration only.

Setting the Authentication Mode to Gateway Authentication so that the Access Control Function Moves Up to the Core Gateway Device on a De-layered extended Layer 2 Network

<p>Scenario</p> <p>Figure 4- 1</p>	
<p>Configuration Steps</p>	<ul style="list-style-type: none"> On switch A (which is a core gateway device), set the authentication mode to gateway authentication.
<p>Switch A</p>	<pre>SwitchA(config)#auth-mode gateway Please save config and reload system. SwitchA(config)#exit *Nov 7 10:13:27: %SYS-5-CONFIG_I: Configured from console by console SwitchA#reload Reload system?(Y/N)y SwitchA#</pre>
<p>Verification</p>	<ul style="list-style-type: none"> Use the show running command to check whether the configuration has taken effect.
<p>Switch A</p>	<pre>SwitchA(config)#show running-config include auth-mode auth-mode gateway SwitchA(config)#</pre>

4.4.2 Configuring Authentication-Exemption VLANs

Configuration Effect

Configure authentication-exemption VLANs, so that users in these VLANs can access the Internet without experiencing dot1x or Web authentication.

Precautions

Authentication-exemption VLANs only mean that users in these VLANs do not need to experience a check related to access authentication, but still need to experience a check based on a security ACL. If specified users or VLANs are denied according to the security ACL, corresponding users still cannot access the Internet. Therefore, during ACL configuration, you need to ensure that specified VLANs or specified users in the authentication-exemption VLANs are not blocked if you hope that users in the authentication-exemption VLANs can access the Internet without being authenticated.

Configuration Method

📌 **Configuring Authentication-Exemption VLANs**

- Optional configuration. To spare all users in certain VLANs from dot1x or Web authentication, configure these VLANs as authentication-exemption VLANs.
- Perform this configuration on access, convergence, or core switches depending on user distribution.
- Authentication-exemption VLANs can be configured in interface configuration mode.

Command	[no] direct-vlan <i>vlanlist</i>
Parameter Description	no: If the command carries this parameter, it indicates that the authentication-exemption VLAN configuration will be deleted. <i>vlanlist:</i> This parameter indicates the list of authentication-exemption VLANs to be configured or deleted.
Defaults	No authentication-exemption VLAN has been configured.
Command Mode	Global configuration mode, or interface configuration mode
Usage Guide	Use this command to configure or delete authentication-exemption VLANs.

Verification

Check the authentication-exemption VLAN configuration using the following method:

- Enable dot1x authentication on downlink ports that connect to user terminals, add the downlink ports that connect to the user terminals to a specific VLAN, and configure the VLAN as an authentication-exemption VLAN. Then open the Internet Explorer, and enter a valid extranet address (such as www.google.com). If the users can open the corresponding webpage on the Internet, it indicates that the authentication-exemption VLAN is valid; otherwise, the authentication-exemption VLAN does not take effect.
- Use the **show direct-vlan** command to check the authentication-exemption VLAN configuration on the device.

Command	show direct-vlan
Parameter Description	-
Command	Privileged EXEC mode, global configuration mode, or interface configuration mode

Mode	
Usage Guide	Global configuration mode
Usage Example	<pre>FS#show direct-vlan direct-vlan 100 FS#show direct-vlan interface gi 0/1 Port direct-vlan ----- - Gi0/1 5,7,100</pre>

Configuration Examples

i The following configuration example describes SCC-related configuration only.

Configuring Authentication-exemption VLANs so that Specific Users Can Access the Internet without Being Authenticated

<p>Scenario</p> <p>Figure 4- 2</p>	<p>The diagram illustrates a network topology where a central Router connects to the Internet. The Router's G0/1 interface has IP 192.168.5.2, and its G2/20 interface is connected to Switch A (Core Layer) with SVI 7 having IP 192.168.5.1. Switch A (Core Layer) has SVI 100 (192.168.100.1) and SVI 200 (192.168.200.1). It is connected to three other switches via Trunk links: Switch B (Office Area), Switch C (Staff Living Area), and Switch D (Student Living Area). Each switch is connected to a group of PCs. The Office Area (Switch B) has VLAN 100 (192.168.100.0/24) with gateway 192.168.100.1/24. The Staff Living Area (Switch C) has VLAN 201-900 (192.168.200.0/24) with gateway 192.168.200.1/24. The Student Living Area (Switch D) has VLAN 1001-2000 (192.168.300.0/24) with gateway 192.168.300.1/24. The Core Layer (Switch A) has SVI 1000 (192.168.300.1) with Supper vlan 1000 and Sub vlan:1001-2000.</p>
<p>Configuration Steps</p>	<ul style="list-style-type: none"> On switch A (which is the core gateway device), set the GI 2/1 port as a trunk port, and enable dot1x authentication on this port. On switch A (which is the core gateway device), configure VLAN 100 to which the headmaster's office belongs as an authentication-exemption VLAN.
<p>Switch A</p>	<pre>SwitchA(config)#vlan 100</pre>

	<pre>SwitchA(config-vlan)#exit SwitchA(config)#direct-vlan 100 SwitchA(config)#int GigabitEthernet 0/1 SwitchA(config-if-GigabitEthernet 0/1)#switchport mode trunk SwitchA(config-if-GigabitEthernet 0/1)#dot1x port-control auto *Oct 17 16:06:45: %DOT1X-6-ENABLE_DOT1X: Able to receive EAPOL packet and DOT1X authentication enabled.</pre>
Verification	<ul style="list-style-type: none"> ● Open the Internet Explorer from any PC in the headmaster's office, enter a valid extranet address, and confirm that the corresponding webpage can be opened. ● Use the show direct-vlan command to check whether the authentication-exemption VLAN is valid.
Switch A	<pre>SwitchA(config)#show direct-vlan direct-vlan 100</pre>

4.4.3 Configuring the IPv4 User Capacity

Configuration Effect

Configure the IPv4 user capacity, so as to restrict the number of users who are allowed to access an access port.

Precautions

N/A

Configuration Method

🔽 Configuring the IPv4 User Capacity

- Optional configuration. To limit the maximum of users who are allowed to access an access port, configure the IPv4 user capacity. The access user capacity is not limited on an access port by default. Suppose the user capacity limit is configured on a specific interface. When the number of authenticated users on the interface reaches the maximum, new users cannot be authenticated on this interface and cannot get online, until existing authenticated users get offline on the interface.
- Perform this configuration on access switches, which may be access switches on the network edge or core gateway devices.

Command	<p>nac-author-user maximum <i>max-user-num</i></p> <p>no nac-author-user maximum</p>
Parameter Description	<p>no: If the command carries this parameter, it indicates that the limit on the IPv4 access user capacity will be removed from the port.</p> <p><i>max-user-num:</i> This parameter indicates the maximum number of IPv4 users who allowed to access the port. The value range is from 1 to 1024.</p>
Defaults	The number of IPv4 access users is not limited.
Command Mode	Interface configuration mode

Usage Guide	Use this command to limit the number of IPv4 access users on a specific access port.
--------------------	--

Verification

Check the IPv4 user capacity configuration on a port using the following method:

- dot1x authentication: When the number of users who get online based on 1x client authentication on the port reaches the specified user capacity, no any new user can get online from this port.
- Web authentication: When the number of users who get online based on Web authentication on the port reaches the specified user capacity, no any new user can get online from this port.
- Use the **show nac-author-user [interface interface-name]** command to check the IPv4 user capacity configured on the device.

Command	show nac-author-user [interface interface-name]
Parameter Description	interface-name: This parameter indicates the interface name.
Command Mode	Privileged EXEC mode, global configuration mode, or interface configuration mode
Usage Guide	Global configuration mode
Usage Example	<pre>FS#show nac-author-user interface GigabitEthernet 0/1 Port Cur_num Max_num ----- - Gi0/1 0 4</pre>

Configuration Examples

i The following configuration example describes SCC-related configuration only.

Restricting the Number of IP4 Users on a Port to Prevent Excessive Access Terminals from Impacting the Network

Scenario Figure 4-3	
Configuration	<ul style="list-style-type: none"> ● Assume that the dot1x authentication environment has been well configured on the access switch A, and

Steps	<p>dot1x authentication is enabled on the Gi 0/2 port.</p> <ul style="list-style-type: none"> Set the maximum number of IPv4 access users on the Gi 0/2 port to 4.
Switch A	<pre>SwitchA(config)#int GigabitEthernet 0/2 SwitchA(config-if-GigabitEthernet 0/2)#nac-author-user maximum 4</pre>
Verification	<ul style="list-style-type: none"> Perform dot1x authentication for all the four PCs in the dormitory, so that the PCs get online. Then take an additional terminal to access the network, and attempt to perform dot1x authentication for this terminal. Verify that the terminal cannot be successfully authenticated to get online. Use the show nac-author-user command to check whether the configuration has taken effect.
Switch A	<pre>SwitchA(config)#show nac-author-user Port Cur_num Max_num ----- - Gi0/1 0 4</pre>

4.4.4 Configuring Authenticated-User Migration

Configuration Effect

By default, when a user gets online after passing dot1x or Web authentication at a physical location (which is represented by a specific access port plus the VLAN number) and quickly moves to another physical location without getting offline, the user cannot get online through dot1x or Web authentication from the new physical location, unless the authenticated-user migration feature has been configured in advance.

Notes

- If the authenticated-user migration feature is not yet configured, an online user cannot get online from the new physical location after quickly moving from one physical location to another physical location without getting offline first. However, if the user gets offline before changing the physical location or gets offline during the location change, the user can still normally get online after being authenticated at the new physical location, even if the authenticated-user migration feature is not configured.

Configuration Method

📌 Configuring Authenticated-User Migration

- Optional configuration. To allow users to be authenticated and get online from different physical locations, enable the authenticated-user migration function.
- Perform this configuration on access, convergence, or core switches depending on user distribution.

Command	[no] station-move permit
Parameter Description	<p>no station-move permit: Indicates that authenticated-user migration is not permitted.</p> <p>station-move permit: Indicates that authenticated-user migration is permitted.</p>
Defaults	Authenticated-user migration is not permitted; that is, when a user getting online from one physical location on the

	network moves to another physical location and attempts to get online from the new physical location without getting offline first, the authentication fails and the user cannot get online from the new physical location.
Command Mode	Global configuration mode
Usage Guide	Use this command to configure authenticated-user migration.

Verification

Check the authenticated-user migration configuration using the following method:

- A PC is authenticated and gets online from a dot1x-based port of the device using dot1x SU client, and does not actively get offline. Move the PC to another port of the device on which dot1x authentication is enabled, and perform dot1x authentication again. Check whether the PC can successfully get online.

Configuration Examples

i The following configuration example describes SCC-related configuration only.

Configuring Online-User Migration so that an Online User Can Perform Authentication and Get Online from Different Ports without Getting Offline First

<p>Scenario</p> <p>Figure 4-4</p>	<p>The diagram illustrates a network setup for user migration. At the top, a cloud labeled 'Internet' is connected to 'Switch A'. To the left, an 'Authentication Server' is connected to Switch A via 'GigabitEthernet 0/1' and 'GigabitEthernet 0/2'. Below Switch A, two departments are shown: 'R&D Dept.' and 'Test Dept.'. Each department contains two PCs, 'PC1' and 'PC2', connected to Switch A via 'GigabitEthernet 0/2' and 'GigabitEthernet 0/3' respectively. Ellipses indicate additional PCs in each department.</p>
<p>Configuration Steps</p>	<ul style="list-style-type: none"> ● Enable dot1x authentication on access ports Gi 0/2 and Gi 0/3, and configure authentication parameters. The authentication is MAC-based. ● Configure online-user migration.
<p>Switch A</p>	<pre>sw1(config)#station-move permit</pre>

Verification	<ul style="list-style-type: none"> A lap-top PC in the R&D department performs authentication using dot1x SU client, and gets online. Remove the network cable from the PC, connect the PC to the LAN where the test department resides, and perform dot1x authentication for the PC again using dot1x SU client. Confirm that the PC can successfully get online.
Switch A	<pre>sw1(config)#show running-config include station station-move permit</pre>

4.4.5 Configuring User Online-Status Detection

Configuration Effect

After the user online-status detection function is enabled, if a user's traffic is lower than a certain threshold within the specified period of time, the device automatically disconnects the user, so as to avoid the economical loss incurred by constant charging to the user.

Precautions

It should be noted that if disconnecting zero-traffic users is configured, generally software such as 360 Security Guard will run on a user terminal by default. Then such software will send packets time and again, and the device will disconnect the user only when the user's terminal is powered off.

Configuration Method

📌 Configuring User Online-Status Detection

- Optional configuration. A user is disconnected if the user does not involve any traffic within eight hours by default.
- Perform this configuration on access, convergence, or core switches depending on user distribution. The configuration acts on only the configured device instead of other devices on the network.
- If the traffic threshold parameter `threshold` is set to 0, it indicates that zero-traffic detection will be performed.

Command	<p>offline-detect interval <i>interval</i> threshold <i>threshold</i></p> <p>no offline-detect</p> <p>default offline-detect</p>
Parameter Description	<p><i>interval</i>: This parameter indicates the offline-detection interval. The value range is from 6 to 65535 in minutes on a switch or from 1 to 65535 in minutes on a non-switch device. The default value is 8 hours, that is, 480 minutes.</p> <p><i>threshold</i>: This parameter indicates the traffic threshold. The value range is from 0 to 4294967294 in bytes. The default value is 0, indicating that the user is disconnected when no traffic of the user is detected.</p> <p>no offline-detect: Disables the user online-status detection function.</p> <p>default offline-detect: Restores the default value. In other words, an online user will be disconnected when the device detects that the user does not have any traffic within eight hours.</p>
Defaults	8 hours
Command Mode	Global configuration mode
Usage Guide	Use this command to configure user online-status detection, so that a user is disconnected when its traffic is lower

than a specific threshold within a specific period of time. Use the **no offline-detect** command to disable the user online-status detection function, or use the **default offline-detect** command to restore the default detection mode.

Verification

Check the user online-status detection configuration using the following method:

- After the user online-status detection function is enabled, power off the specified authenticated terminal after the corresponding user gets online. Then wait for the specified period of time, and run the online user query command associated with dot1x or Web authentication on the device to confirm that the user is already offline.

Configuration Examples

i The following configuration example describes SCC-related configuration only.

Configuring User Online-Status Detection so that a User Is Disconnected if the User Does Not Have Traffic Within Five Minutes

<p>Scenario</p> <p>Figure 4-5</p>	
<p>Configuration Steps</p>	<ul style="list-style-type: none"> ● Enable dot1x authentication on the access port Gi 0/2, and configure authentication parameters. The authentication is MAC-based. ● Configure user online-status detection so that a user is disconnected if the user does not have traffic within five minutes.
<p>Switch A</p>	<pre>sw1(config)# offline-detect interval 5 threshold 0</pre>
<p>Verification</p>	<ul style="list-style-type: none"> ● Perform dot1x authentication using dot1x SU client for a PC in the R&D department, so that the PC gets online. Then power off the PC, wait for 6 minutes, and run the online user query command available with dot1x authentication on switch 1 to confirm that the user of the PC is already offline.

Switch A	<pre>sw1(config)#show running-config include offline-detect offline-detect interval 5</pre>
-----------------	---

4.5 Monitoring

Displaying

Command	Function
show direct-vlan	Displays the authentication-exemption VLAN configuration.
show nac-author-user [interface <i>interface-name</i>]	Displays information about IPv4 user entries on a specific interface.

Debugging



System resources are occupied when debugging information is output. Therefore, close the debugging switch immediately after use.

Command	Function
debug scc event	Debugs the SCC running process.
debug scc user [mac author mac]	Debugs SCC user entries.
debug scc acl-show summary	Debugs ACLs stored in the current SCC and delivered by various services.
debug scc acl-show all	Debugs all ALCs stored in the current SCC.

5 Configuring Password Policy

5.1 Overview

The Password Policy is a password security function provided for local authentication of the device. It is configured to control users' login passwords and login states.



The following sections introduce password policy only.

5.2 Features

5.2.1 Basic Concepts

Minimum Password Length

Administrators can set a minimum length for user passwords according to system security requirements. If the password input by a user is shorter than the minimum password length, the system does not allow the user to set this password but displays a prompt, asking the user to specify another password of an appropriate length.

Strong Password Detection

The less complex a password is, the more likely it is to crack the password. For example, a password that is the same as the corresponding account or a simple password that contains only characters or digits may be easily cracked. For the sake of security,

administrators can enable the strong password detection function to ensure that the passwords set by users are highly complex. After the strong password detection function is enabled, a prompt will be displayed for the following types of passwords:

1. Passwords that are the same as corresponding accounts;
2. Simple passwords that contain characters or digits only.

Special Character Check

Special characters include ~`!@#\$%^&*()_+=={}|[]\:";'<>.,/ and space. The password only containing special characters is easy to be cracked. After enabling special character check, the password can not consist of only special characters. After enabling strong password check, a prompt will be displayed when the password only contains special characters.

Password Life Cycle

The password life cycle defines the validity time of a user password. When the service time of a password exceeds the life cycle, the user needs to change the password.

If the user inputs a password that has already expired during login, the system will give a prompt, indicating that the password has expired and the user needs to reset the password. If the new password input during password resetting does not meet system requirements or the new passwords consecutively input twice are not the same, the system will ask the user to input the new password once again.

Guard Against Repeated Use of Passwords

When changing the password, the user will set a new password while the old password will be recorded as the user's history records. If the new password input by the user has been used previously, the system gives an error prompt and asks the user to specify another password.

The maximum number of password history records per user can be configured. When the number of password history records of a user is greater than the maximum number configured for this user, the new password history record will overwrite the user's oldest password history record.

Storage of Encrypted Passwords

Administrators can enable the storage of encrypted passwords for security consideration. When administrators run the **show running-config** command to display configuration or run the **write** command to save configuration files, various user-set passwords are displayed in the cipher text format. If administrators disable the storage of encrypted passwords next time, the passwords already in cipher text format will not be restored to plaintext passwords.

5.3 Configuration

Configuration	Description and Command	
Configuring the Password Security Policy	 Optional configuration, which is used to configure a combination of parameters related to the password security policy.	
	password policy life-cycle	Configures the password life cycle.
	password policy min-size	Configures the minimum length of user passwords.
	password policy no-repeat-times	Sets the no-repeat times of latest password configuration, so that the passwords specified

		in these times of latest password configuration can no longer be used in future password configuration.
	password policy strong	Enables the strong password detection function.
	password policy printable-character-check	Enables special character check.
	service password-encryption	Sets the storage of encrypted passwords.

5.3.1 Configuring the Password Security Policy

Networking Requirements

- Provide a password security policy for local authentication of the device. Users can configure different password security policies to implement password security management.

Notes

- The configured password security policy is valid for global passwords (configured using the commands **enable password** and **enable secret**) and local user passwords (configured using the **username name password password** command). It is invalid for passwords in Line mode.

Configuration Steps

↘ Configuring the Password Life Cycle

- Optional
- Perform this configuration on each device that requires the configuration of a password life cycle unless otherwise stated.

↘ Configuring the Minimum Length of User Passwords

- Optional
- Perform this configuration on each device that requires a limit on the minimum length of user passwords unless otherwise stated.

↘ Setting the No-Repeat Times of Latest Password Configuration

- Optional
- Perform this configuration on each device that requires a limit on the no-repeat times of latest password configuration unless otherwise stated.

↘ Enabling the Strong Password Detection Function

- Optional
- Perform this configuration on each device that requires strong password detection unless otherwise stated.

↘ Enabling the Special Character Check

- Optional
- Perform this configuration on each device that requires strong password detection unless otherwise stated.

✚ Setting the Storage of Encrypted Passwords

- Optional
- Perform this configuration on each device that requires the storage of passwords in encrypted format unless otherwise stated.

Verification

Configure a local user on the device, and configure a valid password and an invalid password for the user.

- When you configure the valid password, the device correctly adds the password.
- When you configure the invalid password, the device displays a corresponding error log.

Related Commands

✚ Configuring the Password Life Cycle

Command Syntax	password policy life-cycle <i>days</i>
Parameter Description	life-cycle <i>days</i> : Indicates the password life cycle in the unit of days. The value range is from 1 to 65535.
Command Mode	Global configuration mode
Usage Guide	The password life cycle is used to define the validity period of user passwords. If the user logs in with a password whose service time already exceeds the life cycle, a prompt is given, asking the user to change the password.

✚ Configuring the Minimum Length of User Passwords

Command Syntax	password policy min-size <i>length</i>
Parameter Description	min-size <i>length</i> : Indicates the minimum length of passwords. The value range is from 1 to 31.
Command Mode	Global configuration mode
Usage Guide	This command is used to configure the minimum length of passwords. If the minimum length of passwords is not configured, users can input a password of any length.

✚ Setting the No-Repeat Times of Latest Password Configuration

Command Syntax	password policy no-repeat-times <i>times</i>
Parameter Description	no-repeat-times <i>times</i> : Indicates the no-repeat times of latest password configuration. The value range is from 1 to 31.
Command Mode	Global configuration mode
Usage Guide	After this function is enabled, all old passwords used in the several times of latest password configuration will be recorded as the user's password history records. If the new password input by the user has been used previously, the system gives an error prompt and the password modification fails. You can configure the maximum number of password history records per user. When the number of password

	history records of a user is greater than the maximum number configured for the user, the new password history record will overwrite the user's oldest password history record.
--	---

↘ Enabling the Strong Password Detection Function

Command Syntax	password policy strong
Parameter Description	-
Command Mode	Global configuration mode
Usage Guide	After the strong password detection function is enabled, a prompt is displayed for the following types of passwords: <ol style="list-style-type: none"> 1. Passwords that are the same as corresponding accounts; <p>Simple passwords that contain characters or digits only.</p>

↘ Enabling the Special Character Check

Command Syntax	password policy printable-character-check
Parameter Description	-
Command Mode	Global configuration mode
Usage Guide	After the special character check is enabled, a prompt is displayed for the password containing only special characters.

↘ Setting the Storage of Encrypted Passwords

Command Syntax	service password-encryption
Parameter Description	-
Command Mode	Global configuration mode
Usage Guide	Before the storage of encrypted passwords is set, all passwords used in the configuration process will be displayed and stored in plaintext format, unless the passwords are configured in cipher text format. You can enable the storage of encrypted passwords for security consideration. When you run the show running-config command to display configuration or run the write command to save configuration files, various user-set passwords are displayed in the cipher text format. If you disable the storage of encrypted passwords next time, the passwords already in cipher text format will not be restored to plaintext passwords.

↘ Checking User-Configured Password Security Policy Information

Command Syntax	show password policy
Parameter	-

Description	
Command	Privileged EXEC mode/ Global configuration mode/ Interface configuration mode
Mode	
Usage Guide	Use this command to display the password security policy configured on the device.

Configuration Examples

The following configuration example describes configuration related to a password security policy.

Configuring Password Security Check on the Device

Typical Application	<p>Assume that the following password security requirements arise in a network environment:</p> <ol style="list-style-type: none"> 1. The minimum length of passwords is 8 characters; 2. The password life cycle is 90 days; 3. Passwords are stored and transmitted in cipher text format; 4. The number of no-repeat times of password history records is 3; 5. Passwords shall not be the same as user names, and shall not contain simple characters or digits only.
Configuration Steps	<ul style="list-style-type: none"> ● Set the minimum length of passwords to 8. ● Set the password life cycle to 90 days. ● Enable the storage of encrypted passwords. ● Set the no-repeat times of password history records to 3. ● Enable the strong password detection function. <pre> FS# configure terminal FS(config)# password policy min-size 8 FS(config)# password policy life-cycle 90 FS(config)# service password-encryption FS(config)# password policy no-repeat-times 3 FS(config)# password policy strong </pre>
Verification	<p>When you create a user and the corresponding password after configuring the password security policy, the system will perform relevant detection according to the password security policy.</p> <ul style="list-style-type: none"> ● Run the show password policy command to display user-configured password security policy information. <pre> FS# show password policy Global password policy configurations: Password encryption: Enabled Password strong-check: Enabled </pre>

Password min-size:	Enabled (8 characters)
Password life-cycle:	Enabled (90 days)
Password no-repeat-times:	Enabled (max history record: 3)

Common Errors

- The time configured for giving a pre-warning notice about password expiry to the user is greater than the password life cycle.

5.4 Monitoring

Displaying the Running Status

Command	Function
show password policy	Displays user-configured password security policy information.

6 Configuring Storm Control

6.1 Overview

When a local area network (LAN) has excess broadcast data flows, multicast data flows, or unknown unicast data flows, the network speed will slow down and packet transmission will have an increased timeout probability. This situation is called a LAN storm. A storm may occur when topology protocol execution or network configuration is incorrect.

Storm control can be implemented to limit broadcast data flows, multicast data flows, or unknown unicast data flows. If the rate of data flows received by a device port is within the configured bandwidth threshold, packets-per-second threshold, or kilobits-per-second threshold, the data flows are permitted to pass through. If the rate exceeds the thresholds, excess data flows are discarded until the rate falls within the thresholds. This prevents flood data from entering the LAN causing a storm.

6.2 Applications

Application	Description
Network Attack Prevention	Enable storm control to prevent flooding.

6.2.1 Network Attack Prevention

Scenario

The application requirements of network attack prevention are described as follows:

- Protect devices from flooding of broadcast packets, multicast packets, or unknown unicast packets.

Figure 6-1

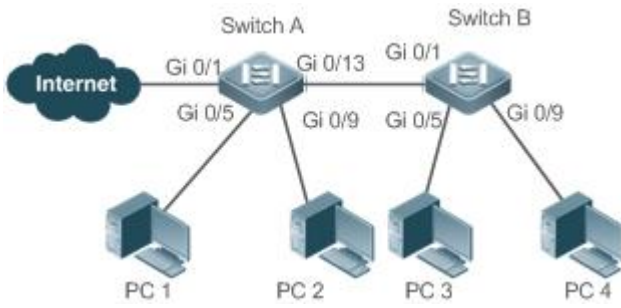

Remarks	Switch A and Switch B are access devices. PC 1, PC 2, PC 3, and PC 4 are desktop computers.
----------------	--

Deployment

- Enable storm control on the ports of all access devices (Switch A and Switch B).

6.3 Features

Basic Concepts

▾ **Storm Control**

If the rate of data flows (broadcast packets, multicast packets, or unknown unicast packets) received by a device port is within the configured bandwidth threshold, packets-per-second threshold, or kilobits-per-second threshold, the data flows are permitted to pass through. If the rate exceeds the thresholds, excess data flows are discarded until the rate falls within the thresholds.

▾ **Storm Control Based on the Bandwidth Threshold**

If the rate of data flows received by a device port is within the configured bandwidth threshold, the data flows are permitted to pass through. If the rate exceeds the threshold, excess data flows are discarded until the rate falls within the threshold.

▾ **Storm Control Based on the Packets-per-Second Threshold**

If the rate of data flows received by a device port is within the configured packets-per-second threshold, the data flows are permitted to pass through. If the rate exceeds the threshold, excess data flows are discarded until the rate falls within the threshold.

▾ **Storm Control Based on the Kilobits-per-Second Threshold**

If the rate of data flows received by a device port is within the configured kilobits-per-second threshold, the data flows are permitted to pass through. If the rate exceeds the threshold, excess data flows are discarded until the rate falls within the threshold.

Overview

Feature	Description
Unicast Packet Storm Control	Limits unknown unicast packets to prevent flooding.
Multicast Packet Storm Control	Limits multicast packets to prevent flooding.
Broadcast Packet Storm Control	Limits broadcast packets to prevent flooding.

6.3.1 Unicast Packet Storm Control

The unicast packet storm control feature monitors the rate of unknown unicast data flows received by a device port to limit LAN traffic and prevent flooding caused by excess data flows.

Working Principle

If the rate of unknown unicast data flows received by a device port is within the configured bandwidth threshold, packets-per-second threshold, or kilobits-per-second threshold, the data flows are permitted to pass through. If the rate exceeds the thresholds, excess data flows are discarded until the rate falls within the thresholds.

Related Configuration

▾ Enabling Unicast Packet Storm Control on Ports

By default, unicast packet storm control is disabled on ports.

Run the **storm-control unicast** [{ **level percent** | **pps packets** | **rate-bps** }] command to enable unicast packet storm control on ports.

Run the **no storm-control unicast** or **default storm-control unicast** command to disable unicast packet storm control on ports.

The default command parameters are determined by related products.

6.3.2 Multicast Packet Storm Control

The multicast packet storm control feature monitors the rate of multicast data flows received by a device port to limit LAN traffic and prevent flooding caused by excess data flows.

Working Principle

If the rate of multicast data flows received by a device port is within the configured bandwidth threshold, packets-per-second threshold, or kilobits-per-second threshold, the data flows are permitted to pass through. If the rate exceeds the thresholds, excess data flows are discarded until the rate falls within the thresholds.

Related Configuration

▾ Enabling Multicast Packet Storm Control on Ports

By default, multicast packet storm control is disabled on ports.

Run the **storm-control multicast** [{ **level percent** | **pps packets** | **rate-bps** }] command to enable multicast packet storm control on ports.

Run the **no storm-control multicast** or **default storm-control multicast** command to disable multicast packet storm control on ports.

The default command parameters are determined by related products.

6.3.3 Broadcast Packet Storm Control

The broadcast packet storm control feature monitors the rate of broadcast data flows received by a device port to limit LAN traffic and prevent flooding caused by excess data flows.

Working Principle

If the rate of broadcast data flows received by a device port is within the configured bandwidth threshold, packets-per-second threshold, or kilobits-per-second threshold, the data flows are permitted to pass through. If the rate exceeds the thresholds, excess data flows are discarded until the rate falls within the thresholds.

Related Configuration

↘ **Enabling Broadcast Packet Storm Control on Ports**

By default, broadcast packet storm control is disabled on ports.

Run the **storm-control broadcast** [{ **level percent** | **pps packets** | *rate-bps* }] command to enable broadcast packet storm control on ports.

Run the **no storm-control broadcast** or **default storm-control broadcast** command to disable broadcast packet storm control on ports.

The default command parameters are determined by related products.

6.4 Configuration

Configuration	Description and Command
Configuring Basic Functions of Storm Control	 (Mandatory) It is used to enable storm control.
	storm-control { broadcast multicast unicast } [{ level percent pps packets <i>rate-bps</i> }]

6.4.1 Configuring Basic Functions of Storm Control

Configuration Effect

- Prevent flooding caused by excess broadcast packets, multicast packets, and unknown unicast packets.

Notes

- When you run a command (for example, **storm-control unicast**) to enable storm control, if you do not set the parameters, the default values are used.

Configuration Steps

↘ **Enabling Unicast Packet Storm Control**

- Mandatory.
- Enable unicast packet storm control on every device unless otherwise specified.

↘ **Enabling Multicast Packet Storm Control**

- Mandatory.
- Enable multicast packet storm control on every device unless otherwise specified.

↘ **Enabling Broadcast Packet Storm Control**

- Mandatory.
- Enable broadcast packet storm control on every device unless otherwise specified.

Verification

- Run the **show storm-control** command to check whether the configuration is successful.

Related Commands

↘ **Enabling Unicast Packet Storm Control**

Command	storm-control unicast [{ <i>level percent</i> pps packets <i>rate-bps</i> }]
Parameter	level percent : Indicates the bandwidth percentage.
Description	pps packets : Indicates the number of packets per second. <i>rate-bps</i> : Indicates the packet rate.
Command Mode	Interface configuration mode
Usage Guide	Storm control can be enabled only on switch ports.

↘ **Enabling Multicast Packet Storm Control**

Command	storm-control multicast [{ <i>level percent</i> pps packets <i>rate-bps</i> }]
Parameter	level percent : Indicates the bandwidth percentage.
Description	pps packets : Indicates the number of packets per second. <i>rate-bps</i> : Indicates the packet rate.
Command Mode	Interface configuration mode
Usage Guide	Storm control can be enabled only on switch ports.

↘ **Enabling Broadcast Packet Storm Control**

Command	storm-control broadcast [{ <i>level percent</i> pps packets <i>rate-bps</i> }]
Parameter	level percent : Indicates the bandwidth percentage.
Description	pps packets : Indicates the number of packets per second. <i>rate-bps</i> : Indicates the packet rate.
Command Mode	Interface configuration mode
Usage Guide	Storm control can be enabled only on switch ports.

Configuration Example

↘ **Enabling Storm Control on Devices**

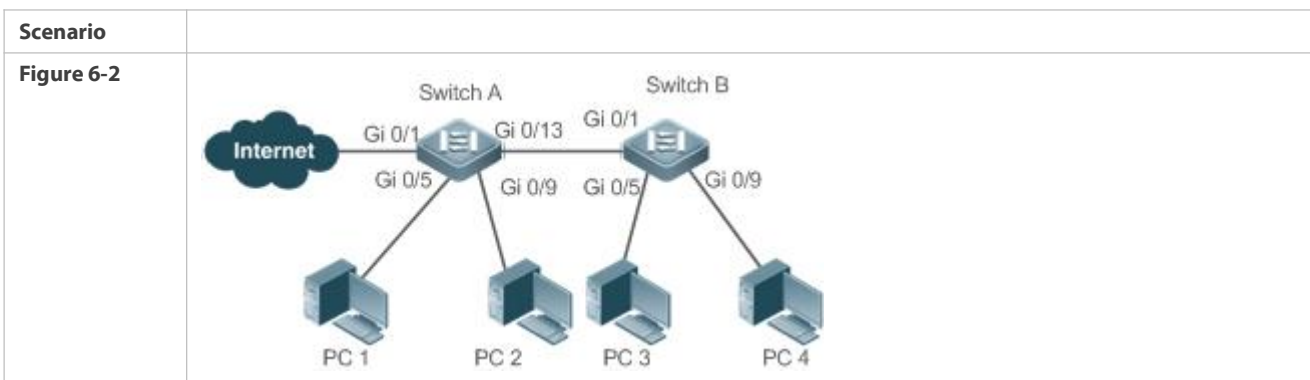

Configuration Step	<ul style="list-style-type: none"> Enable storm control on Switch A and Switch B. 																									
Switch A	<pre>FS(config)#interface range gigabitEthernet 0/5,0/9,0/13 FS(config-if-range)#storm-control broadcast FS(config-if-range)#storm-control multicast FS(config-if-range)#storm-control unicast</pre>																									
Switch B	<pre>FS(config)#interface range gigabitEthernet 0/1,0/5,0/9 FS(config-if-range)#storm-control broadcast FS(config-if-range)#storm-control multicast FS(config-if-range)#storm-control unicast</pre>																									
Verification	Check whether storm control is enabled on Switch A and Switch B.																									
Switch A	<pre>FS# sho storm-control</pre> <table border="1"> <thead> <tr> <th>Interface</th> <th>Broadcast Control</th> <th>Multicast Control</th> <th>Unicast Control</th> <th>Action</th> </tr> </thead> <tbody> <tr> <td>GigabitEthernet 0/1</td> <td>Disabled</td> <td>Disabled</td> <td>Disabled</td> <td>none</td> </tr> <tr> <td>GigabitEthernet 0/5</td> <td>default</td> <td>default</td> <td>default</td> <td>none</td> </tr> <tr> <td>GigabitEthernet 0/9</td> <td>default</td> <td>default</td> <td>default</td> <td>none</td> </tr> <tr> <td>GigabitEthernet 0/13</td> <td>default</td> <td>default</td> <td>default</td> <td>none</td> </tr> </tbody> </table>	Interface	Broadcast Control	Multicast Control	Unicast Control	Action	GigabitEthernet 0/1	Disabled	Disabled	Disabled	none	GigabitEthernet 0/5	default	default	default	none	GigabitEthernet 0/9	default	default	default	none	GigabitEthernet 0/13	default	default	default	none
Interface	Broadcast Control	Multicast Control	Unicast Control	Action																						
GigabitEthernet 0/1	Disabled	Disabled	Disabled	none																						
GigabitEthernet 0/5	default	default	default	none																						
GigabitEthernet 0/9	default	default	default	none																						
GigabitEthernet 0/13	default	default	default	none																						
Switch B	<pre>FS#sho storm-control</pre> <table border="1"> <thead> <tr> <th>Interface</th> <th>Broadcast Control</th> <th>Multicast Control</th> <th>Unicast Control</th> <th>Action</th> </tr> </thead> <tbody> <tr> <td>GigabitEthernet 0/1</td> <td>default</td> <td>default</td> <td>default</td> <td>none</td> </tr> <tr> <td>GigabitEthernet 0/5</td> <td>default</td> <td>default</td> <td>default</td> <td>none</td> </tr> <tr> <td>GigabitEthernet 0/9</td> <td>default</td> <td>default</td> <td>default</td> <td>none</td> </tr> </tbody> </table>	Interface	Broadcast Control	Multicast Control	Unicast Control	Action	GigabitEthernet 0/1	default	default	default	none	GigabitEthernet 0/5	default	default	default	none	GigabitEthernet 0/9	default	default	default	none					
Interface	Broadcast Control	Multicast Control	Unicast Control	Action																						
GigabitEthernet 0/1	default	default	default	none																						
GigabitEthernet 0/5	default	default	default	none																						
GigabitEthernet 0/9	default	default	default	none																						

6.5 Monitoring

Displaying



Description	Command
Displays storm control information.	show storm-control [<i>interface-type interface-number</i>]

7 Configuring SSH

7.1 Overview

Secure Shell (SSH) connection is similar to a Telnet connection except that all data transmitted over SSH is encrypted. When a user in an insecure network environment logs into a device remotely, SSH helps ensure information security and powerful authentication, protecting the device against attacks such as IP address spoofing and plain-text password interception.

An SSH-capable device can be connected to multiple SSH clients. In addition, the device can also function as an SSH client, and allows users to set up an SSH connection with a SSH-server device. In this way, the local device can safely log in to a remote device through SSH to implement management.

-  Currently, a device can work as either the SSH server or an SSH client, supporting SSHv1 and SSHv2 versions. FS SSH service supports both IPv4 and IPv6.
-  Unless otherwise specified, SSH in this document refers to SSHv2.

Protocols and Standards

- RFC 4251: The Secure Shell (SSH) Protocol Architecture
- RFC 4252: The Secure Shell (SSH) Authentication Protocol
- RFC 4253: The Secure Shell (SSH) Transport Layer Protocol
- RFC 4254: The Secure Shell (SSH) Connection Protocol
- RFC 4419: Diffie-Hellman Group Exchange for the Secure Shell (SSH) Transport Layer Protocol
- RFC 4716: The Secure Shell (SSH) Public Key File Format
- RFC 4819: Secure Shell Public Key Subsystem
- RFC 3526: More Modular Exponential (MODP) Diffie-Hellman groups for Internet Key Exchange (IKE)
- RFC 2409: The Internet Key Exchange (IKE)
- RFC 1950: ZLIB Compressed Data Format Specification version 3.3
- draft-ietf-secsh-filexfer-05: SSH File Transfer Protocol
- draft-ylonen-ssh-protocol-00: The version of the SSH Remote Login Protocol is 1.5. Comware implements the SSH server functions, but not the SSH client functions.

7.2 Applications

Application	Description
SSH Device Management	Use SSH to manage devices.
SSH Local Line Authentication	Use the local line password authentication for SSH user authentication.
<u>SSH</u> AAA Authentication	Use the authentication, authorization and accounting (AAA) mode for SSH user authentication.
<u>SSH</u> Public Key Authentication	Use the public key authentication for SSH user authentication.
SSH File Transfer	Use the Secure Copy (SCP) commands on the client to exchange data with the SSH server.
SSH Client Application	Use the SSH client to safely log in to a remote device for management.

7.2.1 SSH Device Management

Scenario

You can use SSH to manage devices on the precondition that the SSH server function is enabled. By default, this function is disabled. The Telnet component that comes with the Windows system does not support SSH. Therefore, a third-party client software must be used. Currently, well-compatible software includes PuTTY, Linux, and SecureCRT. The following takes the PuTTY as an example to introduce the configurations of the SSH client. Figure 7- 1 shows the network topology.

Figure 7- 1 Networking Topology of SSH Device Management



Deployment

Configure the SSH client as follows:

- Start the PuTTY software.
- On the **Session** option tab of PuTTY, type in the host IP address of the SSH server and SSH port number **22**, and select the connection type **SSH**.
- On the **SSH** option tab of PuTTY, select the preferred SSH protocol version **2**.
- On the **SSH authentication** option tab of PuTTY, select the authentication method **Attempt "keyboard-interactive" auth**.
- Click **Open** to connect to the SSH server.
- Type in the correct user name and password to enter the terminal login interface.

7.2.2 SSH Local Line Authentication

Scenario

SSH clients can use the local line password authentication mode, as shown in Figure 7-2. To ensure security of data exchange, PC 1 and PC 2 function as the SSH clients, and use the SSH protocol to log in to the network device where the SSH server function is enabled. The requirements are as follows:

- SSH users use the local line password authentication mode.
- Five lines, including Line 0 to Line 4, are activated concurrently. The login password is "passzero" for Line 0 and "pass" for the remaining lines. Any user name can be used.

Figure 7-2 Networking Topology of SSH Local Line Password Authentication

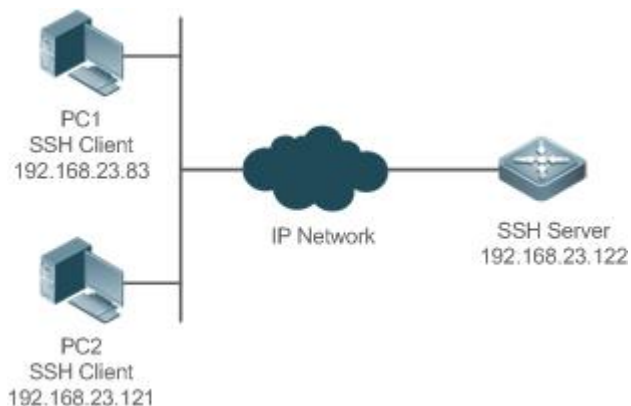

Deployment

- Configure the SSH server as follows:

1. Enable the SSH server function globally. By default, the SSH server supports two SSH versions: SSHv1 and SSHv2.
2. Configure the key. With this key, the SSH server decrypts the encrypted password received from the SSH clients, compares the decrypted plain text with the password stored on the server, and returns a message indicating the successful or unsuccessful authentication. SSHv1 uses an RSA key, whereas SSHv2 adopts an RSA or DSA key.
3. Configure the IP address of the FastEthernet 0/1 interface on the SSH server. The SSH client is connected to the SSH server using this IP address. The routes from the SSH clients to the SSH server are reachable.

- Configure the SSH client as follows:

Diversified SSH client software is available, including PuTTY, Linux, and OpenSSH. This document takes PuTTY as an example to explain the method for configuring the SSH clients.

1. Open the PuTTY connection tab, and select SSHv1 for authenticated login. (The method is similar if SSHv2 is selected.)
2. Set the IP address and connected port ID of the SSH server. As shown in the network topology, the IP address of the server is 192.168.23.122, and the port ID is 22. Click **Open** to start the connection. As the current authentication mode does not require a user name, you can type in any user name, but cannot be null. (In this example, the user name is "anyname".)

7.2.3 SSH AAA Authentication

Scenario

SSH users can use the AAA authentication mode for user authentication, as shown in Figure 7-3. To ensure security of data exchange, the PCs function as the SSH clients, and uses the SSH protocol to log in to the network device where the SSH server is enabled. To better perform security management, the AAA authentication mode is used for user login on the SSH clients. Two authentication methods, including Radius server authentication and local authentication, are provided in the AAA authentication method list to ensure reliability. The Radius server authentication method is preferred. If the Radius server does not respond, it turns to the local authentication.

Figure 7-3 Networking Topology of SSH AAA Authentication

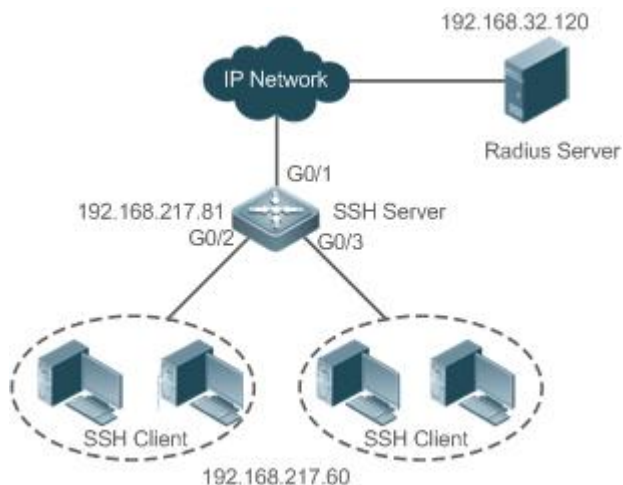

Deployment

- The routes from the SSH clients to the SSH server are reachable, and the route from the SSH server to the Radius server is also reachable.
- Configure the SSH server on the network device that functions as an SSH client.
- Configure the AAA parameters on the network device. When the AAA authentication mode is used, method lists are created to define the identity authentication and types, and applied to a specified service or interface.

7.2.4SSH Public Key Authentication

Scenario

SSH clients can use the public keys for authentication, and the public key algorithm can be RSA or DSA, as shown in Figure 7-4. SSH is configured on the client so that a secure connection is set up between the SSH client and the SSH server.

Figure 7-4 Network Topology for Public Key Authentication of SSH Users



Deployment

- To implement public key authentication for the client, generate a key pair (RSA or DSA) on the client, configure the public key on the SSH server, and select the public key authentication mode.
- After the key is generated on the client, the SSH server will copy the file of the public key from the client to the flash and associates the file with the SSH user name. Each user can be associated with one RSA public key and one DSA public key.

7.2.5SSH File Transfer

Scenario

The SCP service is enabled on the server, and SCP commands are used on the client to transfer data to the server, as shown in Figure 7-5.

Figure 7-5 Networking Topology of SSH File Transfer



Deployment

- Enable the SCP service on the server.
- On the client, use SCP commands to upload files to the server, or download files from the server.

7.2.6 SSH Client Application

Scenario

The SSH service is enabled on a remote SSH server, and the **ssh** command is used on the local client to set up an SSH connection with the server for secure data transmission, as shown in Figure 7-6.

Figure 7-6 Networking Topology of SSH Client Application



Deployment

- Enable the SSH service on the server.
- On the client, run the **ssh** command to set up an SSH connection with the server for secure data transmission.

7.3 Features

Basic Concepts

↘ User Authentication Mechanism

- Password authentication

During the password authentication, a client sends a user authentication request and encrypted user name and password to the server. The server decrypts the received information, compares the decrypted information with those stored on the server, and then returns a message indicating the successful or unsuccessful authentication.

- Public key authentication

During the public key authentication, digital signature algorithms, such as RSA and DSA, are used to authenticate a client. The client sends a public key authentication request to the server. This request contains information including the user name, public key, and public key algorithm. On receiving the request, the server checks whether the public key is correct. If wrong, the server directly sends an authentication failure message. If right, the server performs digital signature authentication on the client, and returns a message indicating the successful or unsuccessful authentication.

-  Public key authentication is applicable only to the SSHv2 clients.

↘ SSH Communication

To ensure secure communication, interaction between an SSH server and an SSH client undergoes the following seven stages:

- Connection setup

The server listens on Port 22 to the connection request from the client. After originating a socket initial connection request, the client sets up a TCP socket connection with the server.

- Version negotiation

If the connection is set up successfully, the server sends a version negotiation packet to the client. On receiving the packet, the client analyzes the packet and returns a selected protocol version to the server. The server analyzes the received information to determine whether version negotiation is successful.

- Key exchange and algorithm negotiation

If version negotiation is successful, key exchange and the algorithm negotiation are performed. The server and the client exchange the algorithm negotiation packet with each other, and determine the final algorithm based on their capacity. In addition, the server and the client work together to generate a session key and a session ID according to the key exchange algorithm and host key, which will be applied to subsequent user authentication, data encryption, and data decryption.

- User authentication

After the encrypted channel is set up, the client sends an authentication request to the server. The server repeatedly conducts authentication for the client until the authentication succeeds or the server shuts down the connection because the maximum number of authentication attempts is reached.

- Session request

After the successful authentication, the client sends a session request to the server. The server waits and processes the client request. After the session request is successfully processed, SSH enters the session interaction stage.

- Session interaction

After the session request is successfully processed, SSH enters the session interaction stage. Encrypted data can be transmitted and processed in both directions. The client sends a command to be executed to the client. The server decrypts, analyzes, and processes the received command, and then sends the encrypted execution result to the client. The client decrypts the execution result.

- Session ending

When the interaction between the server and the client is terminated, the socket connection disconnects, and the session ends.

Overview

Feature	Description
SSH Server	Enable the SSH server function on a network device, and you can set up a secure connection with the network device through the SSH client.
SCP Service	After the SCP service is enabled, you can directly download files from the network device and upload local files to the network device. In addition, all interactive data is encrypted, featuring authentication and security.
SSH Client	You can use the SSH client on the device to set up a secure connection with the SSH server on a network device.

7.3.1 SSH Server

Enable the SSH server function on a network device, and you can set up a secure connection with the network device through the SSH client. You can also shut down the SSH server function to disconnect from all SSH clients.

Working Principle

For details about the working principle of the SSH server, see the "SSH Communication" in "Basic Concepts." In practice, after enabling the SSH server function, you can configure the following parameters according to the application requirements:

- **Version:** Configure the SSH version as SSHv1 or SSHv2 to connect SSH clients.
- **Authentication timeout:** The SSH server starts the timer after receiving a user connection request. The SSH server is disconnected from the client either when the authentication succeeds or when the authentication timeout is reached.
- **Maximum number of authentication retries:** The SSH server starts authenticating the client after receiving its connection request. If authentication does not succeed when the maximum number of user authentication retries is reached, a message is sent, indicating the authentication failure.
- **Public key authentication:** The public key algorithm can be RSA or DSA. It provides a secure connection between the client and the server. The public key file on the client is associated with the user name. In addition, the public key authentication mode is configured on the client, and the corresponding private key file is specified. In this way, when the client attempts to log in to the server, public key authentication can be implemented to set up a secure connection.

Related Configuration

📄 Enabling the SSH Server

By default, the SSH server is disabled.

In global configuration mode, run the **[no] enable service ssh-server** command to enable or disable the SSH server.

To generate the SSH key, you also need to enable the SSH server.

📄 Specifying the SSH Version

By default, the SSH server supports both SSHv1 and SSHv2, connecting either SSHv1 clients or SSHv2 clients.

Run the **ip ssh version** command to configure the SSH version supported by the SSH server.

If only SSHv1 or SSHv2 is configured, only the SSH client of the configured version can be connected to the SSH server.

📄 Configuring the SSH Authentication Timeout

By default, the user authentication timeout is 120s.

Run the **ip ssh time-out** command to configure the user authentication timeout of the SSH server. Use the **no** form of the command to restore the default timeout. The SSH server starts the timer after receiving a user connection request. If authentication does not succeed before the timeout is reached, authentication times out and fails.

📄 Configuring the Maximum Number of SSH Authentication Retries

By default, the maximum number of user authentication retries is 3.

Run the **ip ssh authentication-retries** command to configure the maximum number of user authentication retries on the SSH server. Use the **no** form of the command to restore the default number of user authentication retries. If authentication still does not succeed when the maximum number of user authentication retries is reached, user authentication fails.

📄 Specifying the SSH Encryption Mode

By default, the encryption mode supported by the SSH server is Compatible, that is, supporting cipher block chaining (CBC), counter (CTR) and other encryption modes.

Run the **ip ssh cipher-mode** command to configure the encryption mode supported by the SSH server. Use the **no** form of the command to restore the default encryption mode supported by the SSH server.

▾ Specifying the SSH Message Authentication Algorithm

By default, the message authentication algorithms supported by the SSH server are as follows: (1) For the SSHv1, no algorithm is supported; (2) For the SSHv2, four algorithms, including MD5, SHA1, SHA1-96, and MD5-96, are supported.

Run the **ip ssh hmac-algorithm** command to configure the message authentication algorithm supported by the SSH server. Use the **no** form of the command to restore the default message authentication algorithm supported by the SSH server.

▾ Configuring Support for Diffie-Hellman(DH) Key Exchange Algorithm on the SSH Server

By default, FS's SSHv2 server supports `diffie-hellman-group-exchange-sha1`, `diffie-hellman-group14-sha1`, and `diffie-hellman-group1-sha1` for keyexchange while the SSHv1 server support none. Run the **ip ssh key-exchange** command to configure support for Diffie-Hellman on the SSH server. Use the **no ip ssh key-exchange** command to restore the default setting.

▾ Setting ACL Filtering of the SSH Server

By default, ACL filtering is not performed for all connections to the SSH server.

Run the **{ip | ipv6} ssh access-class** command to perform ACL filtering for all connections to the SSH server. Run **no {ip | ipv6} ssh access-class** to restore the default settings.

▾ Enabling the Public Key Authentication on the SSH Server

Run the **ip ssh peer** command to associate the public key file on the client with the user name. When the client is authenticated upon login, a public key file is specified based on the user name.

7.3.2SCP Service

The SSH server provides the SCP service to implement secure file transfer between the server and the client.

Working Principle

- SCP is a protocol that supports online file transfer. It runs on Port 22 based on the BSC RCP protocol, whereas RCP provides the encryption and authentication functions based on the SSH protocol. RCP implements file transfer, and SSH implements authentication and encryption.
- Assume that the SCP service is enabled on the server. When you use an SCP client to upload or download files, the SCP client first analyzes the command parameters, sets up a connection with a remote server, and starts another SCP process based on this connection. This process may run in source or sink mode. (The process running in source mode is the data provider. The process running in sink mode is the destination of data.) The process running in source mode reads and sends files to the peer end through the SSH connection. The process running in sink mode receives files through the SSH connection.

Related Configuration

▾ Enabling the SCP Server

By default, the SCP server function is disabled.

Run the **ip scp server enable** command to enable SCP server function on a network device.

7.3.3SSH Client

The SSH client is used to set up a secure connection with a remote network device on which the SSH server runs.

Working Principle

For details about the working principle of the SSH client, see the "SSH Communication" in "Basic Concepts."

Related Configuration

▾ Specifying the Source Interface of the SSH Client

By default, the source address of SSH packets is searched based on the destination address.

Run the **ip ssh source-interface** *interface-name* command to specify the source interface of the SSH client.

▾ Establishing a Session with the SSH Server

Run the **ssh** command to log in to a remote device that supports the SSH Server

▾ Recovering an Established SSH Session

- Run the **ssh-session** *session-id* command to recover an established SSH session.

▾ Disconnecting a Suspended SSH Session

- Run the **disconnect ssh-session** *session-id* command to disconnect a specified SSH session.

7.3.4SCP Client

The SCP client is used to support file transfer with the remote network device on which the SCP server is enabled.

Working Principle

SCP is a protocol that supports online file transfer. It runs on Port 22 based on BSD RCP, while RCP provides the encryption and authentication functions based on the SSH protocol. RCP implements file transfer, and SSH implements authentication and encryption.

When you use an SCP client to upload or download files, the SCP client first parses the command parameters, sets up a connection with a remote server, and starts another SCP process based on this connection. This process may run in source or sink mode. The process serves as a data provider in source mode and reads and sends files to the peer end through the SSH connection, while serving as the destination of data in sink mode and receives the files through the SSH connection.

Related Configuration

▾ Specifying Source Interface of SCP Client

By default, configure the IP address of the source interface as the source address in SSH packets.

Run the **ip scp client source-interface** *interface-name* command to specify the source interface of the SCP client.

▾ Establishing Connection with the SCP Server via SCP Client to Implement File Transfer

Run the **scp** command to implement file transfer with the SSH server.

7.4 Configuration

Configuration	Description and Command	
Configuring the SSH Server	It is mandatory to enable the SSH server.	
	enable service ssh-server	Enables the SSH server.
	disconnect ssh[<i>vtty</i>] <i>session-id</i>	Disconnects an established SSH session.
	crypto key generate {<i>rsa</i> <i>dsa</i>}	Generates an SSH key.
	ip ssh version {1 2}	Specifies the SSH version.
	ip ssh time-out <i>time</i>	Configures the SSH authentication timeout.
	ip ssh authentication-retries <i>retry times</i>	Configures the maximum number of SSH authentication retries.
	ip ssh cipher-mode{<i>cbc</i> <i>ctr</i> <i>others</i> }	Specifies the SSH encryption mode.
	ip ssh hmac-algorithm{<i>md5</i> <i>md5-96</i> <i>sha1</i> <i>sha1-96</i>}	Specifies the SSH message authentication algorithm.
	ip ssh key-exchange { <i>dh_group_exchange_sha1</i> <i>dh_group14_sha1</i> <i>dh_group1_sha1</i> }	Configures support for Diffie-Hellman on the SSH server.
{ip ipv6} ssh access-class { <i>access-list-number</i> <i>access-list-name</i> }	Enables ACL filtering of the SSH server.	
ip ssh peer <i>test</i> public-key <i>rsa</i> flash :<i>rsa.pub</i>	Associates an RSA public key file with a user.	
ip ssh peer <i>test</i> public-key <i>dsa</i> flash:<i>dsa.pub</i>	Associates a DSA public key file with a user.	
Configuring the SCP Service	Mandatory.	
	ip scp server enable	Enables the SCP server.
Configuring the SSH Client	(Optional)It is used to set up a secure connection with a remote network device that supports the SSH server.	
	ip ssh source-interface <i>interface-name</i>	Specifies the source interface of the SSH client.
	ssh [<i>oob</i>] [-v {1 2}][-c {<i>3des</i> <i>aes128-cbc</i> <i>aes192-cbc</i> <i>aes256-cbc</i> }] [-l <i>username</i>][-m {<i>hmac-md5-96</i> <i>hmac-md5-128</i> <i>hmac-sha1-96</i> <i>hmac-sha1-160</i> }] [-p <i>port-num</i>]{ <i>ip-addr</i> <i>hostname</i>}[<i>via</i> <i>mgmt-name</i>][/source {<i>ip</i>A.B.C.D <i>ipv6</i> X:X:X::X <i>interface</i> <i>interface-name</i>}] [/vrf <i>vrf-name</i>]	Establishes an encrypted session with a remote network device.

7.4.1 Configuring the SSH Server

Configuration Effect

- Enable the SSH server function on a network device so that you can set up a secure connection with a remote network device through the SSH client. All interactive data is encrypted before transmitted, featuring authentication and security.
- You can use diversified SSH user authentications modes, including local line password authentication, AAA authentication, and public key authentication.
- You can generate or delete an SSH key.

- You can specify the SSH version.
- You can configure the SSH authentication timeout.
- You can configure the maximum number of SSH authentication retries.
- You can specify the SSH encryption mode.
- You can specify the SSH message authentication algorithm.
- You can specify ACL filtering of the SSH server.

Notes

- The precondition of configuring a device as the SSH server is that communication is smooth on the network that the device resides, and the administrator can access the device management interface to configure related parameters.
- The **no crypto key generate** command does not exist. You need to run the **crypto key zeroize** command to delete a key.
- The SSH module does not support hot standby. Therefore, for products that supports hot standby on the supervisor modules, if no SSH key file exist on the new active module after failover, you must run the **crypto key generate** command to re-generate a key before using SSH.

Configuration Steps

▾ Enabling the SSH Server

- Mandatory.
- By default, the SSH server is disabled. In global configuration mode, enable the SSH server and generate an SSH key so that the SSH server state changes to ENABLE.

▾ Specifying the SSH Version

- Optional.
- By default, the SSH server supports SSHv1 and SSHv2, connecting either SSHv1 or SSHv2clients. If only SSHv1 or SSHv2 is configured, only the SSH client of the configured version can be connected to the SSH server.

▾ Configuring the SSH Authentication Timeout

- Optional.
- By default, the SSH authentication timeout is 120s. You can configure the user authentication timeout as required. The value ranges from 1 to 120. The unit is second.

▾ Configuring the Maximum Number of SSH Authentication Retries

- Optional.
- Configure the maximum number of SSH authentication retries to prevent illegal behaviors such as malicious guessing. By default, the maximum number of SSH authentication retries is 3, that is, a user is allowed to enter the user name and password three times for authentication. You can configure the maximum number of retries as required. The value ranges from 0 to 5.

▾ Specifying the SSH Encryption Mode

- Optional.

- Specify the encryption mode supported by the SSH server. By default, the encryption mode supported by the SSH server is Compatible, that is, supporting CBC, CTR and other encryption modes.

➤ **Specifying the SSH Message Authentication Algorithm**

- Optional.
- Specify the message authentication algorithm supported by the SSH server. By default, the message authentication algorithms supported by the SSH server are as follows: (1) For the SSHv1, no algorithm is supported; (2) For the SSHv2, four algorithms, including MD5, SHA1, SHA1-96, and MD5-96, are supported.

➤ **Setting ACL Filtering of the SSH Server**

- Optional.
- Set ACL filtering of the SSH server. By default, ACL filtering is not performed for all connections to the SSH server. According to needs, set ACL filtering to perform for all connections to the SSH server.

➤ **Enabling the Public Key Authentication for SSH Users**

- Optional.
- Only SSHv2 supports authentication based on the public key. This configuration associates a public key file on the client with a user name. When a client is authenticated upon login, a public key file is specified based on the user name.

Verification

- Run the **show ip ssh** command to display the current SSH version, authentication timeout, and maximum number of authentication retries of the SSH server.
- Run the **show crypto key mypubkey** command to display the public information of the public key to verify whether the key has been generated.
- Configure the public key authentication login mode on the SSH client and specify the private key file. Check whether you can successfully log in to the SSH server from the SSH client. If yes, the public key file on the client is successfully associated with the user name, and public key authentication succeeds.

Related Commands

➤ **Enabling the SSH Server**

Command	enable service ssh-server
Parameter	N/A
Description	
Command Mode	Global configuration mode
Usage Guide	To disable the SSH server, run the no enable service ssh-server command in global configuration mode. After this command is executed, the SSH server state changes to DISABLE.

➤ **Disconnecting an Established SSH Session**

Command	disconnect ssh[<i>vty</i>] <i>session-id</i>
Parameter	vty: Indicates an established virtual teletype terminal (VTY) session.
Description	session-id: Indicates the ID of the established SSH session. The value ranges from 0 to 35.

Command Mode	Privileged EXEC mode
Usage Guide	Specify an SSH session ID to disconnect the established SSH session. Alternatively, specify a VTY session ID to disconnect a specified SSH session. Only an SSH session can be disconnected.

Generating an SSH Key

Command	crypto key generate {rsa dsa}
Parameter Description	rsa: Generates an RSA key. dsa: Generates a DSA key.
Command Mode	Global configuration mode
Usage Guide	The no crypto key generate command does not exist. You need to run the crypto key zeroize command to delete a key. SSHv1 uses an RSA key, whereas SSHv2 uses an RSA or DSA key. If an RSA key is generated, both SSHv1 and SSHv2 are supported. If only a DSA key is generated, only SSHv2 can use the key.

Specifying the SSH Version

Command	ip ssh version {1 2}
Parameter Description	1: Indicates that the SSH server only receives the connection requests sent by SSHv1 clients. 2: Indicates that the SSH server only receives the connection requests sent by SSHv2 clients.
Command Mode	Global configuration mode
Usage Guide	Run the no ip ssh version command to restore the default settings. By default, the SSH server supports both SSHv1 and SSHv2.

Configuring the SSH Authentication Timeout

Command	ip ssh time-out time
Parameter Description	<i>time:</i> Indicates the SSH authentication timeout. The value ranges from 1 to 120. The unit is second.
Command Mode	Global configuration mode
Usage Guide	Run the no ip ssh time-out command to restore the default SSH authentication timeout, which is 120s.

Configuring the Maximum Number of SSH Authentication Retries

Command	ip ssh authentication-retries retry times
Parameter Description	<i>retry times:</i> Indicates the maximum number of user authentication retries. The value ranges from 0 to 5.
Command Mode	Global configuration mode
Usage Guide	Run the no ip ssh authentication-retries command to restore the default number of user authentication retries, which is 3.

Specifying the SSH Encryption Mode

Command	ip ssh cipher-mode {cbc ctr others }
Parameter Description	<p>cbc: Sets the encryption mode supported by the SSH server to the CBC mode. Corresponding algorithms include DES-CBC,3DES-CBC,AES-128-CBC,AES-192-CBC,AES-256-CBC, and Blowfish-CBC.</p> <p>ctr: Sets the encryption mode supported by the SSH server to the CTR mode. Corresponding algorithms include AES128-CTR, AES192-CTR, and AES256-CTR.</p> <p>others: Sets the encryption mode supported by the SSH server to others. The corresponding algorithm is RC4.</p>
Command Mode	Global configuration mode
Usage Guide	<p>This command is used to configure the encryption mode supported by the SSH server.</p> <p>On FS devices, the SSHv1 server supports the DES-CBC, 3DES-CBC, and Blowfish-CBC encryption algorithms; the SSHv2 server supports the AES128-CTR, AES192-CTR, AES256-CTR, DES-CBC, 3DES-CBC, AES-128-CBC, AES-192-CBC, AES-256-CBC, Blowfish-CBC, and RC4 encryption algorithms. These algorithms can be grouped into three encryption modes: CBC, CTR, and others.</p> <p>As the cryptography continuously develops, it is approved that encryption algorithms in the CBC and others modes can be decrypted in a limited period of time. Therefore, organizations or companies that have high security requirements can set the encryption mode supported by the SSH server to CTR to increase the security level of the SSH server.</p>

📌 Specifying the SSH Message Authentication Algorithm

Command	ip ssh hmac-algorithm {md5 md5-96 sha1 sha1-96}
Parameter Description	<p>md5: Indicates that the message authentication algorithm supported by the SSH server is MD5.</p> <p>md5-96: Indicates that the message authentication algorithm supported by the SSH server is MD5-96.</p> <p>sha1: Indicates that the message authentication algorithm supported by the SSH server is SHA1.</p> <p>sha1-96: Indicates that the message authentication algorithm supported by the SSH server is SHA1-96.</p>
Command Mode	Global configuration mode
Usage Guide	<p>This command is used to configure the message authentication algorithm supported by the SSH server.</p> <p>On FS devices, the SSHv1 server does support any message authentication algorithm; the SSHv2 server supports the MD5, SHA1, SHA1-96, and MD5-96 message authentication algorithms. You can select message authentication algorithms supported by the SSH server as required.</p>

📌 Configuring Support for DH Key Exchange Algorithm on the SSH Server

Command	ip ssh key-exchange { dh_group_exchange_sha1 dh_group14_sha1 dh_group1_sha1 }
Parameter Description	<p>dh_group_exchange_sha1: Indicates configuration of diffie-hellman-group-exchange-sha1 for keyexchange. The key has 2,048 bytes, which cannot be edited.</p> <p>dh_group14_sha1: Indicates configuration of diffie-hellman-group14-sha1 for keyexchange. The key has 2,048 bytes.</p> <p>dh_group1_sha1: Indicates configuration of diffie-hellman-group1-sha1 for keyexchange. The key has 1,024 bytes.</p>
Command Mode	Global configuration mode
Usage Guide	<p>Use this command to configure a DH key exchange method on the SSH.</p> <p>FS's SSHv1 server does not support DH key exchange method, while the SSHv2 server supports diffie-hellman-group-exchange-sha1, diffie-hellman-group14-sha1, and diffie-hellman-group1-sha1 for keyexchange.</p>

▾ Configuring ACL Filtering of the SSH Server

Command	<code>{ip ipv6} ssh access-class { access-list-number access-list-name }</code>
Parameter Description	<p><i>access-list-number</i>: Indicates the ACL number and the number range is configurable. The standard ACL number ranges are 1 to 99 and 1300 to 1999. The extended ACL number ranges are 100 to 199 and 2000 to 2699. Only IPv4 addresses are supported.</p> <p><i>access-list-name</i>: Indicates an ACL name. Both IPv4 and IPv6 addresses are supported.</p>
Command Mode	Global configuration mode
Usage Guide	Run this command to perform ACL filtering for all connections to the SSH server. In line mode, ACL filtering is performed only for specific lines. However, ACL filtering rules of the SSH are effective to all SSH connections.

▾ Configuring RSA Public Key Authentication

Command	<code>ip ssh peer test public-key rsaflash:rsa.pub</code>
Parameter Description	<p><i>test</i>: Indicates the user name.</p> <p>rsa: Indicates that the public key type is RSA.</p> <p><i>rsa.pub</i>: Indicates the name of a public key file.</p>
Command Mode	Global configuration mode
Usage Guide	<p>This command is used to configure the RSA public key file associated with user <i>test</i>.</p> <p>Only SSHv2 supports authentication based on the public key. This command associates the public key file on the client with the user name. When the client is authenticated upon login, a public key file is specified based on the user name.</p>

▾ Configuring DSA Public Key Authentication

Command	<code>ip ssh peer test public-key dsafash:dsa.pub</code>
Parameter Description	<p><i>test</i>: Indicates the user name.</p> <p>dsa: Indicates that the public key type is DSA.</p> <p><i>dsa.pub</i>: Indicates the name of a public key file.</p>
Command Mode	Global configuration mode
Usage Guide	<p>This command is used to configure the DSA key file associated with user test.</p> <p>Only SSHv2 supports authentication based on the public key. This command associates the public key file on the client with the user name. When the client is authenticated upon login, a public key file is specified based on the user name.</p>

Configuration Example

 The following configuration examples describe only configurations related to SSH.

▾ Generating a Public Key on the SSH Server

Configuration Steps	<ul style="list-style-type: none"> ● Run the <code>crypto key generate { rsa dsa }</code> command to generate a RSA public key for the server.
----------------------------	---

<p>SSH Server</p>	<pre>FS#configure terminal FS(config)# crypto key generate rsa Choose the size of the rsa key modulus in the range of 512 to 2048 and the size of the dsa key modulus in the range of 360 to 2048 for your Signature Keys. Choosing a key modulus greater than 512 may take a few minutes. How many bits in the modulus [512]:</pre> <ul style="list-style-type: none"> ● If the generation of the RSA key is successful, the following information is displayed: <pre>% Generating 512 bit RSA1 keys ...[ok] % Generating 512 bit RSA keys ...[ok]</pre> ● If the generation of the RSA key fails, the following information is displayed: <pre>% Generating 512 bit RSA1 keys ...[fail] % Generating 512 bit RSA keys ...[fail]</pre>
<p>Verification</p>	<ul style="list-style-type: none"> ● Run the show crypto key mypubkey rsa command to display the public information about the RSA key. If the public information about the RSA key exists, the RSA key has been generated.
<p>SSH Server</p>	<pre>FS(config)#show crypto key mypubkey rsa % Key pair was generated at: 1:49:47 UTC Jan 4 2013 Key name: RSA1 private Usage: SSH Purpose Key Key is not exportable. Key Data: AAAAAwEA AQAAAHJM 6izXt1pp rUSOEGZ/ UhFpRRrW nngP4BU7 mG836apf jajSYwcu 8O3LojHL ayJ8G4pG 7j4T4ZSf FKg09kfr 92JpRNHQ gbwaPc5/ 9UnTtX9t qFIKDj1j 0dKBcCfN tr0r/CT+ cs5tlGKV SOICGifz oB+pYaE= % Key pair was generated at: 1:49:47 UTC Jan 4 2013 Key name: RSA private Usage: SSH Purpose Key Key is not exportable. Key Data: AAAAAwEAAQAAAHJfLwKnzOgO F3RIKhTN /7PmQYoE v0a2VXTX 8ZCa7SII EghLDLJc w3T5JQXk Rr3iBD5s b1EeOL4b 21ykZt/u UetQ0Q80 sISglfZ9 8o5No3Zz MPM0LnQR</pre>

	G4c7/28+ GOHzYkTk 4liQuTIL HRgtbyEYXCfaaxU=
--	---

▾ **Specifying the SSH Version**

Configuration Steps	<ul style="list-style-type: none"> Run the ip ssh version { 1 2 } command to set the version supported by the SSH server to SSHv2.
SSH Server	<pre>FS#configure terminal FS(config)#ip ssh version 2</pre>
Verification	<ul style="list-style-type: none"> Run the show ip ssh command to display the SSH version currently supported by the SSH server.
SSH Server	<pre>FS(config)#show ip ssh SSH Enable - version 2.0 Authentication timeout: 120 secs Authentication retries: 3 SSH SCP Server: disabled</pre>

▾ **Configuring the SSH Authentication Timeout**

Configuration Steps	<ul style="list-style-type: none"> Run the ip ssh time-out <i>time</i> command to set the SSH authentication timeout to 100s.
SSH Server	<pre>FS#configure terminal FS(config)#ip ssh time-out 100</pre>
Verification	<ul style="list-style-type: none"> Run the show ip ssh command to display the configured SSH authentication timeout.
SSH Server	<pre>FS(config)#show ip ssh SSH Enable - version 2.0 Authentication timeout: 100 secs Authentication retries: 3 SSH SCP Server: disabled</pre>

▾ **Configuring the Maximum Number of SSH Authentication Retries**

Configuration Steps	<ul style="list-style-type: none"> Run the ip ssh authentication-retries <i>retry times</i> command to set the maximum number of user authentication retries on the SSH server to 2.
SSH Server	<pre>FS#configure terminal FS(config)#ip ssh authentication-retries 2</pre>

Verification	<ul style="list-style-type: none"> Run the show ip ssh command to display the configured maximum number of authentication retries.
SSH Server	<pre>FS(config)#show ip ssh SSH Enable - version 2.0 Authentication timeout: 100 secs Authentication retries: 3 SSH SCP Server: disabled</pre>

➤ **Specifying the SSH Encryption Mode**

Configuration Steps	<ul style="list-style-type: none"> Run the ip ssh cipher-mode {cbc ctr others }command to set the encryption mode supported by the SSH server to CTR.
SSH Server	<pre>FS#configure terminal FS(config)# ip ssh cipher-mode ctr</pre>
Verification	<ul style="list-style-type: none"> Select the CTR encryption mode on the SSH client, and verify whether you can successfully log in to the SSH server from the SSH client.

➤ **Specifying the SSH Message Authentication Algorithm**

Configuration Steps	<ul style="list-style-type: none"> Run the ip ssh hmac-algorithm {md5 md5-96 sha1 sha1-96 } command to set the message authentication algorithm supported by the SSH server to SHA1.
SSH Server	<pre>FS#configure terminal FS(config)# ip ssh hmac-algorithmsha1</pre>
Verification	<ul style="list-style-type: none"> Select the SHA1 message authentication algorithm on the SSH client, and verify whether you can successfully log in to the SSH server from the SSH client.

➤ **Configuring Support for DH Key Exchange Algorithm on the SSH Server**

Configuration Steps	<ul style="list-style-type: none"> Run the ip ssh key-exchange { dh_group_exchange_sha1 dh_group14_sha1 dh_group1_sha1 }command to configure a key exchange method on the SSH server.
SSH Server	<pre>FS# configure terminal FS(config)# ip ssh key-exchange dh_group14_sha1</pre>
Verification	<ul style="list-style-type: none"> Choose diffie-hellman-group14-sha1 on the client terminal and check if successful login is performed.

➤ **Configuring the Public Key Authentication**

Configuration Steps	<ul style="list-style-type: none"> Run the ip ssh peer username public-key { rsa dsa}filename command to associate a public key file of the client with a user name. When the client is authenticated upon login, a public key file (for example, RSA)is specified based on the user name.
SSH Server	<pre>FS#configure terminal</pre>

	FS(config)# ip ssh peer test public-key rsaflash:rsa.pub
Verification	<ul style="list-style-type: none"> Configure the public key authentication login mode on the SSH client and specify the private key file. Check whether you can successfully log in to the SSH server from the SSH client. If yes, the public key file on the client is successfully associated with the user name, and public key authentication succeeds.

📌 **Configuring SSH Device Management**

Scenario
Figure 7-7



You can use SSH to manage devices on the precondition that the SSH server function is enabled. By default, this function is disabled. The Telnet component that comes with the Windows does not support SSH. Therefore, a third-party client software must be used. Currently, well-compatible client software includes PuTTY, Linux, and SecureCRT. The following takes the PuTTY as an example to introduce the configurations of the SSH client.

- Configuration Steps**
- Start the PuTTY software.
 - On the **Session** option tab of PuTTY, type in the host IP address **192.168.23.122** and SSH port number **22**, and select the connection type **SSH**.
 - On the **SSH** option tab of PuTTY, select the preferred SSH protocol version **2**.
 - On the **SSH authentication** option tab of PuTTY, select the authentication method **Attempt "keyboard-interactive" auth**.
 - Click **Open** to connect to the SSH server.
 - Type in the correct user name and password to enter the terminal login interface.

SSH Client
Figure 7-8

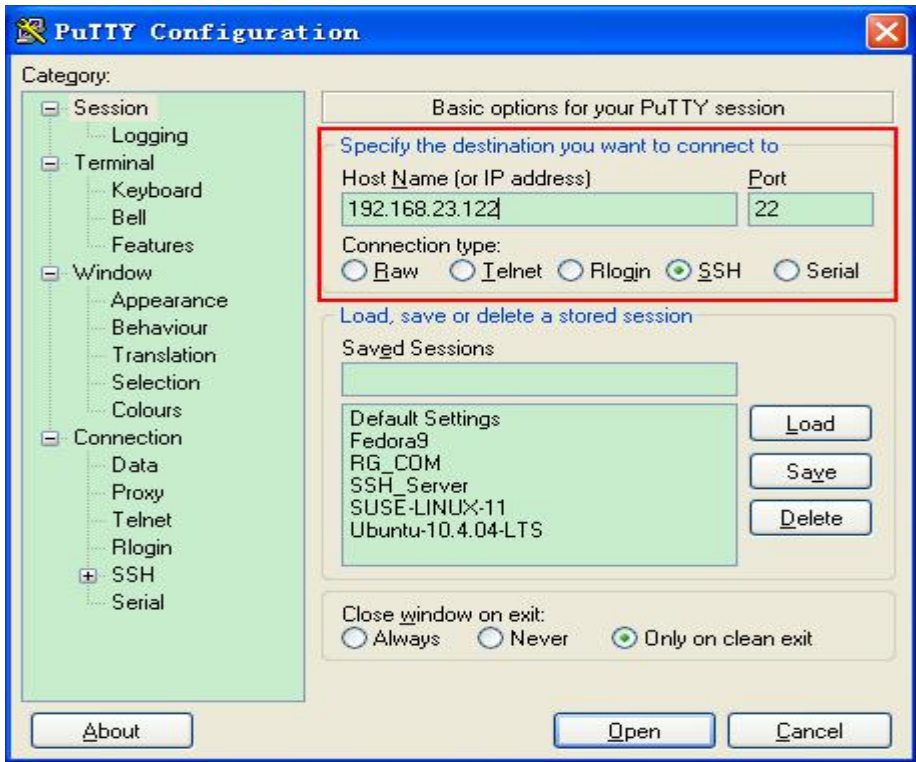

Host Name (or IP address) indicates the IP address of the host to be logged in. In this example, the IP address is **192.168.23.122**. **Port** indicates the port ID 22, that is, the default ID of the port listened by SSH. **Connection type** is **SSH**.

Figure 7-9

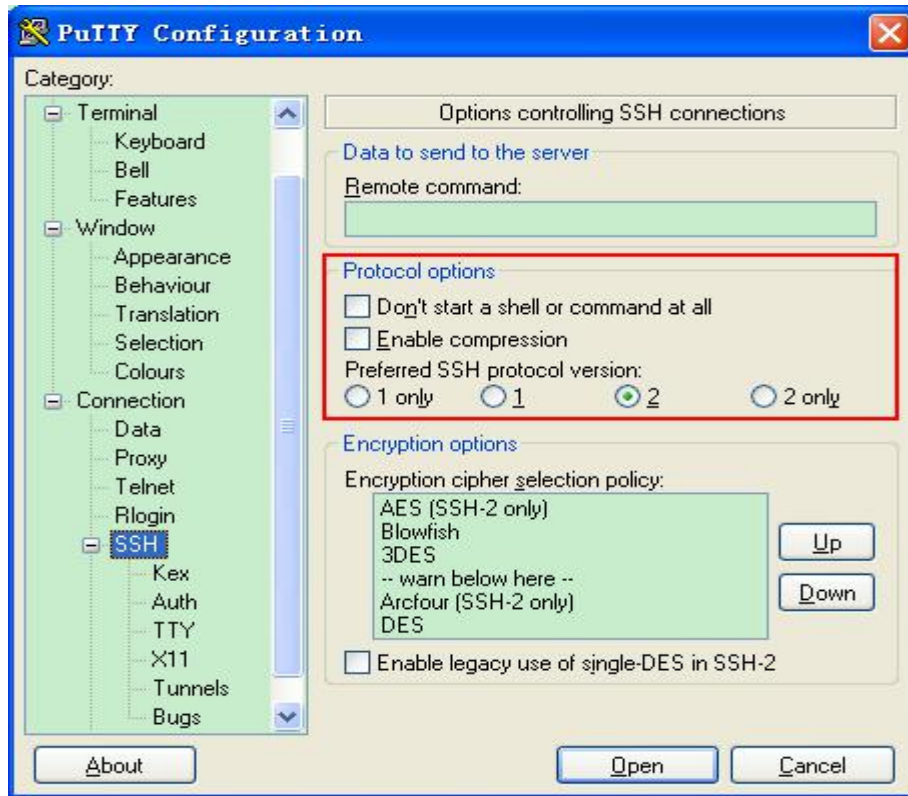

As shown in Figure 7-9, select **2** as the preferred SSH protocol version in the **Protocol options** pane because SSHv2 is used for login.

Figure 7-10

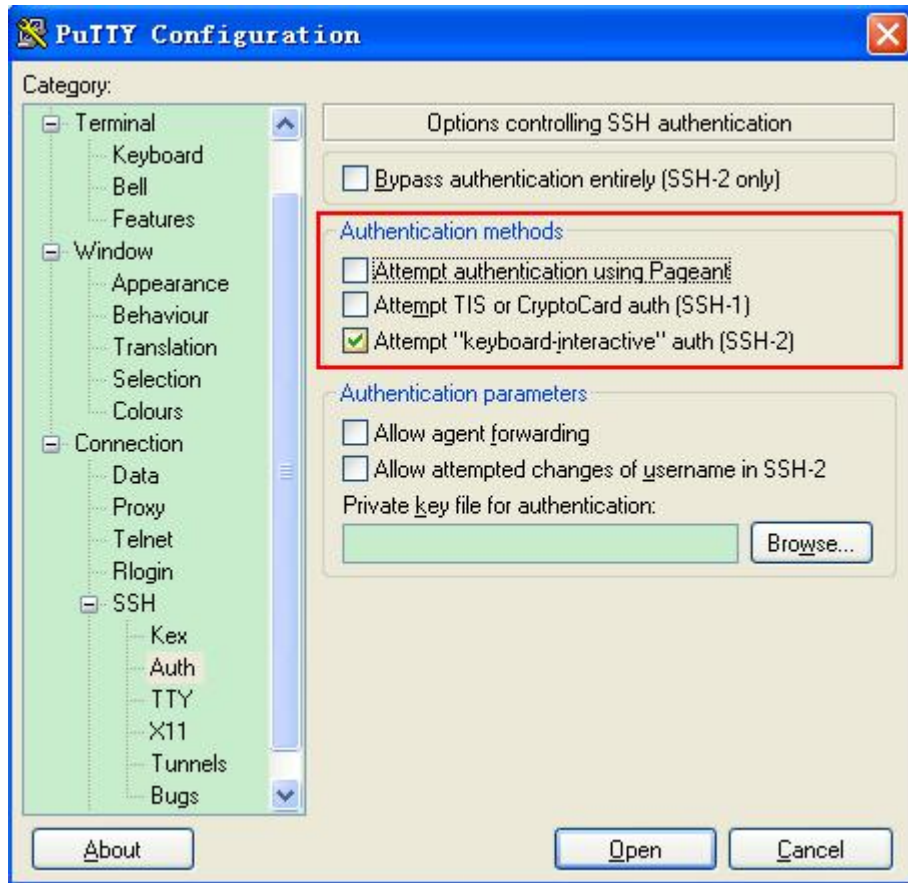

As shown in Figure 7-10, select **Attempt "keyboard-interactive" auth** as the authentication method to support authentication based on the user name and password.

Then, click **Open** to connect to the configured server host, as shown in Figure 7-11.

Figure 7-11

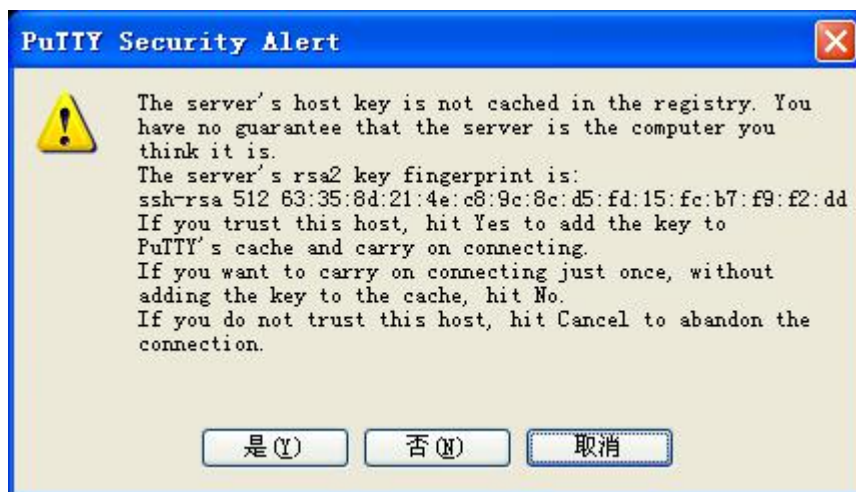

The **PuTTY Security Alert** box indicates that you are logging in to the client of the server 192.168.23.122, and asks you whether to receive the key sent from the server.

If you select **Yes**, a login dialog box is displayed, as shown in Figure 7-12.

Figure 7-12

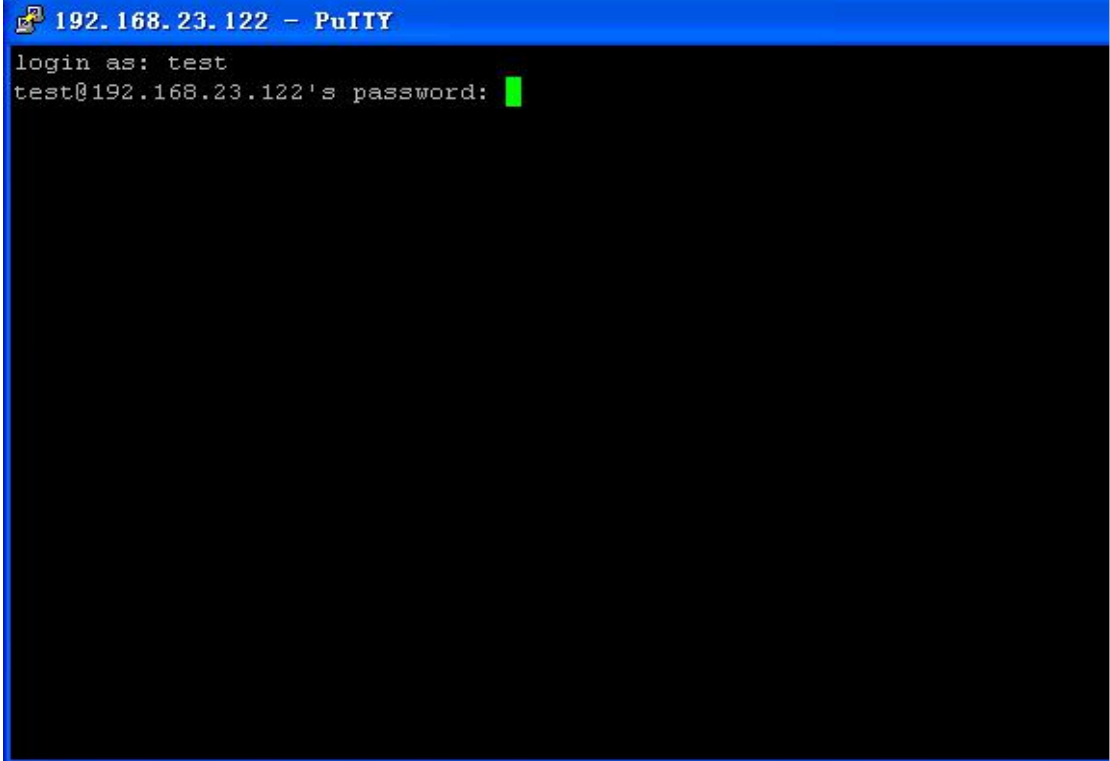

```
192.168.23.122 - PuTTY
login as: test
test@192.168.23.122's password: █
```

Type in the correct user name and password, and you can log in to the SSH terminal interface, as shown in Figure 7-13.

Figure 7-13

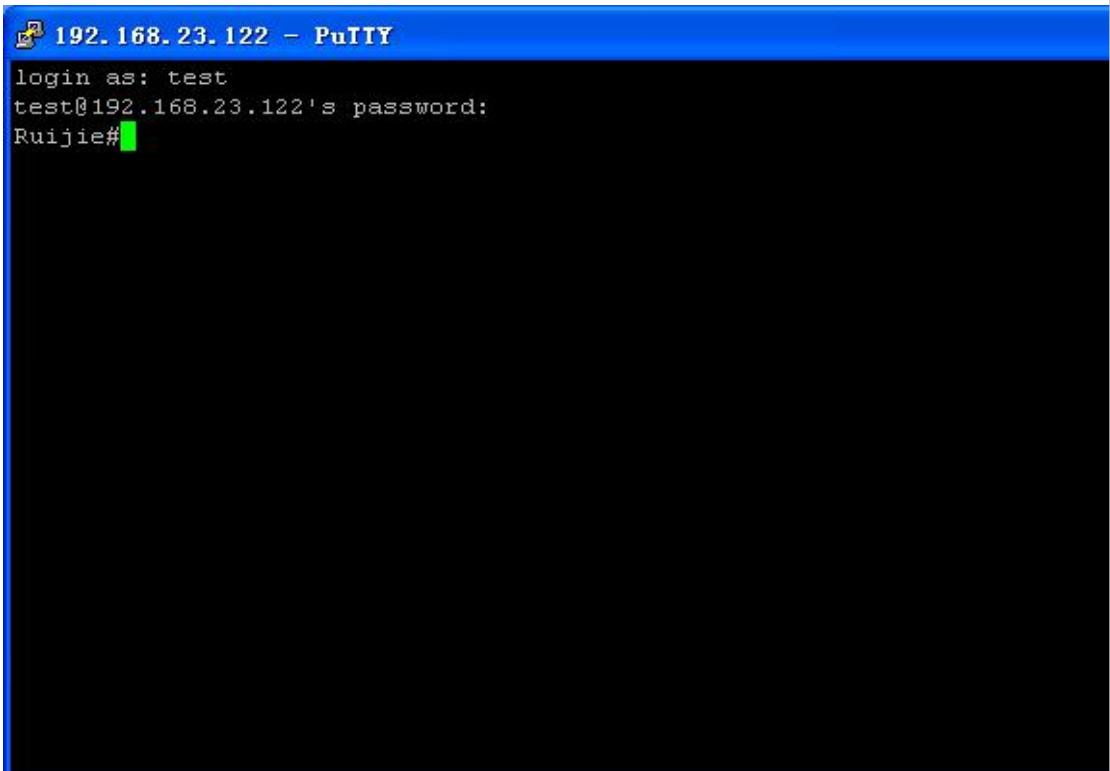

```
192.168.23.122 - PuTTY
login as: test
test@192.168.23.122's password:
Ruijie# █
```

Verification

- Run the **show ip ssh** command to display the configurations that are currently effective on the SSH server.

	<ul style="list-style-type: none"> ● Run the show ssh command to display information about every SSH connection that has been established.
	<pre> FS#show ip ssh SSH Enable - version 1.99 Authentication timeout: 120 secs Authentication retries: 3 FS#show ssh Connection Version Encryption Hmac State Username 0 2.0 aes256-cbc hmac-sha1 Session started test </pre>

➤ **Configuring SSH Local Line Authentication**

<p>Scenario Figure 7- 14</p>	<p>SSH users can use the local line password for user authentication, as shown in Figure 7- 14. To ensure security of data exchange, PC 1 and PC 2 function as the SSH clients, and use the SSH protocol to log in to the network device where the SSH server is enabled. The requirements are as follows:</p> <ul style="list-style-type: none"> ● SSH users use the local line password authentication mode. ● Five lines, including Line 0 to Line 4, are activated concurrently. The login password is "passzero" for Line 0 and "pass" for the remaining lines. Any user name can be used.
<p>Configuration Steps</p>	<p>Configure the SSH server as follows:</p> <ul style="list-style-type: none"> ● Enable the SSH server function globally. By default, the SSH server supports two SSH versions: SSHv1 and SSHv2. ● Configure the key. With this key, the SSH server decrypts the encrypted password received from the SSH client, compares the decrypted plain text with the password stored on the server, and returns a message indicating the successful or unsuccessful authentication. SSHv1 uses the RSA key, whereas SSHv2 uses the RSA or DSA key. ● Configure the IP address of the FastEthernet 0/1 interface on the SSH server. The SSH client is connected to the SSH server based on this IP address. The route from the SSH client to the SSH server is reachable. <p>Configure the SSH client as follows:</p> <ul style="list-style-type: none"> ● Diversified SSH client software is available, including PuTTY, Linux, and SecureCRT. This document takes PuTTY as an example to explain the method for configuring the SSH client. For details about the configuration method, see "Configuration Steps."
<p>SSH Server</p>	<p>Before configuring SSH-related function, ensure that the route from the SSH user to the network segment of the SSH server is reachable. The interface IP address configurations are shown in Figure 7- 15. The detailed procedures for</p>

	<p>configuring IP addresses and routes are omitted.</p> <pre> FS(config)# enable service ssh-server FS(config)#crypto key generate rsa % You already have RSA keys. % Do you really want to replace them? [yes/no]: Choose the size of the key modulus in the range of 360 to 2048 for your Signature Keys. Choosing a key modulus greater than 512 may take a few minutes. How many bits in the modulus [512]: % Generating 512 bit RSA1 keys ...[ok] % Generating 512 bit RSA keys ...[ok] FS(config)#interface fastEthernet0/1 FS(config-if-fastEthernet0/1)#ip address 192.168.23.122 255.255.255.0 FS(config-if-fastEthernet0/1)#exit FS(config)#line vty 0 FS(config-line)#password passzero FS(config-line)#privilege level 15 FS(config-line)#login FS(config-line)#exit FS(config)#line vty1 4 FS(config-line)#password pass FS(config-line)#privilege level 15 FS(config-line)#login FS(config-line)#exit </pre>
<p>SSH Client(PC1/ PC2)</p>	<p>Figure 7- 15</p>

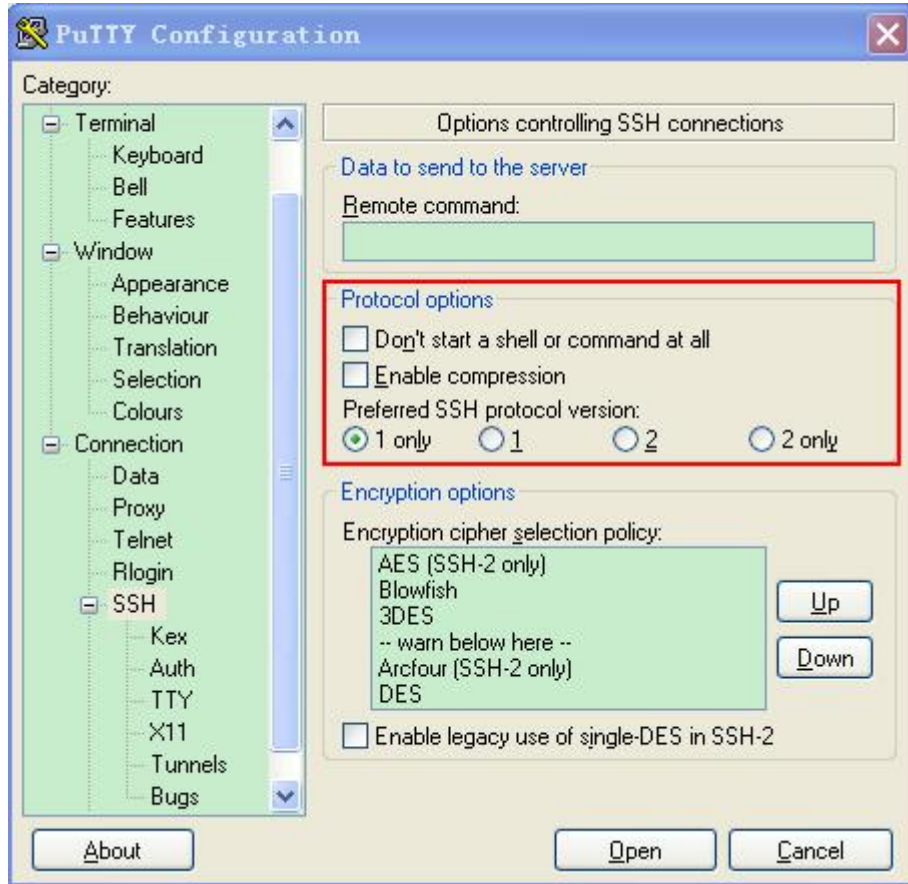

Set the IP address and port ID of the SSH server. As shown in the network topology, the IP address of the server is 192.168.23.122, and the port ID is 22 (For details about the configuration method, see "Configuring SSH Device Management."). Click **Open** to start the SSH server. As the current authentication mode does not require a user name, you can type in any user name, but cannot leave the user name unspecified. (In this example, the user name is "anyname".)

Verification

- Run the **show running-config** command to display the current configurations.
- Verify that the SSH client configurations are correct.

SSH Server

```
FS#show running-config
Building configuration...
!
enable secret 5 $1$eyy2$xs28FDw4s2q0tx97
enable service ssh-server
!
interface fastEthernet0/1
ip address 192.168.23.122 255.255.255.0
!
line vty 0
```

	<pre> privilege level 15 login password passzero line vty 1 4 privilege level 15 login password pass ! end </pre>																				
<p>SSH Client</p>	<p>Set up a connection, and enter the correct password. The login password is "passzero" for Line 0 and "pass" for the remaining lines. Then, the SSH server operation interface is displayed, as shown in Figure 7- 16.</p> <p>Figure 7- 16</p> <pre> FS#show users </pre> <table border="1"> <thead> <tr> <th>Line</th> <th>User</th> <th>Host(s)</th> <th>Idle</th> <th>Location</th> </tr> </thead> <tbody> <tr> <td>* 0 con 0</td> <td>---</td> <td>idle</td> <td>00:00:00</td> <td>---</td> </tr> <tr> <td>1 vty 0</td> <td>---</td> <td>idle</td> <td>00:08:02</td> <td>192.168.23.83</td> </tr> <tr> <td>2 vty 1</td> <td>---</td> <td>idle</td> <td>00:00:58</td> <td>192.168.23.121</td> </tr> </tbody> </table>	Line	User	Host(s)	Idle	Location	* 0 con 0	---	idle	00:00:00	---	1 vty 0	---	idle	00:08:02	192.168.23.83	2 vty 1	---	idle	00:00:58	192.168.23.121
Line	User	Host(s)	Idle	Location																	
* 0 con 0	---	idle	00:00:00	---																	
1 vty 0	---	idle	00:08:02	192.168.23.83																	
2 vty 1	---	idle	00:00:58	192.168.23.121																	

➤ **Configuring AAA Authentication of SSH Users**

Scenario
Figure 7- 17

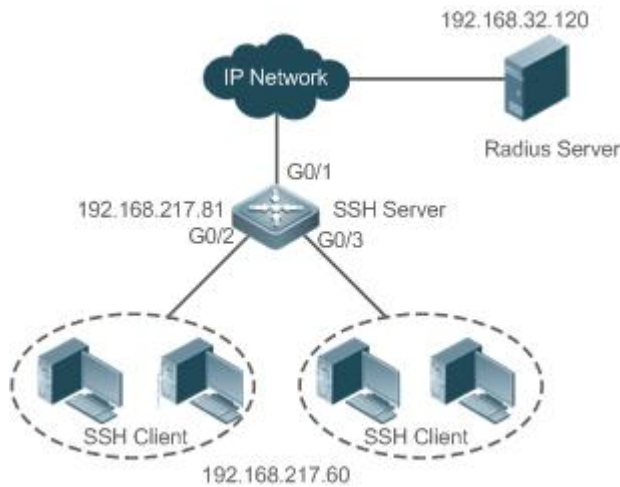

SSH users can use the AAA authentication mode for user authentication, as shown in Figure 7- 17. To ensure security of data exchange, the PC functions as the SSH client, and uses the SSH protocol to log in to the network device where the SSH server is enabled. To better perform security management, the AAA authentication mode is used on the user login interface of the SSH client. Two authentication methods, including Radius server authentication and local authentication, are provided in the AAA authentication method list to ensure reliability. The Radius server authentication method is preferred. If the Radius server does not respond, select the local authentication method.

Configuration Steps

- The route from the SSH client to the SSH server is reachable, and the route from the SSH server to the Radius server is also reachable.
- Configure the SSH server on the network device. The configuration method is already described in the previous example, and therefore omitted here.
- Configure the AAA parameters on the network device. When the AAA authentication mode is used, method lists are created to define the identity authentication and types, and applied to a specified service or interface.

SSH Server

```

FS(config)# enable service ssh-server
FS(config)#crypto key generate rsa
% You already have RSA keys.
% Do you really want to replace them? [yes/no]:
Choose the size of the key modulus in the range of 360 to 2048 for your
Signature Keys. Choosing a key modulus greater than 512 may take
a few minutes.
How many bits in the modulus [512]:
% Generating 512 bit RSA1 keys ...[ok]
% Generating 512 bit RSA keys ...[ok]
FS(config)#crypto key generate dsa
Choose the size of the key modulus in the range of 360 to 2048 for your
Signature Keys. Choosing a key modulus greater than 512 may take
a few minutes.
    
```

	<pre> How many bits in the modulus [512]: % Generating 512 bit DSA keys ...[ok] FS(config)#interface gigabitEthernet1/1 FS(config-if-gigabitEthernet1/1)#ip address 192.168.217.81 255.255.255.0 FS(config-if-gigabitEthernet1/1)#exit FS#configure terminal FS(config)#aaa new-model FS(config)#radius-server host 192.168.32.120 FS(config)#radius-server key aaaradius FS(config)#aaa authentication login methodgroup radius local FS(config)#line vty 0 4 FS(config-line)#login authentication method FS(config-line)#exit FS(config)#username user1 privilege 1 password 111 FS(config)#username user2 privilege 10 password 222 FS(config)#username user3 privilege 15 password 333 FS(config)#enable secret w </pre>
<p>Verification</p>	<ul style="list-style-type: none"> ● Run the show running-config command to display the current configurations. ● This example assumes that the SAM server is used. ● Set up a remote SSH connection on the PC. ● Check the login user.
	<pre> FS#show run aaa new-model ! aaa authentication login method group radius local ! username user1 password 111 username user2 password 222 username user2 privilege 10 username user3 password 333 username user3 privilege 15 no service password-encryption ! radius-server host 192.168.32.120 </pre>

```
radius-server key aaaradius
enable secret 5 $1$hbz$ArCsyqy6yyzpz03
enable service ssh-server
!
interface gigabitEthernet1/1
    no ip proxy-arp
ip address 192.168.217.81 255.255.255.0
!
ip route 0.0.0.0 0.0.0.0 192.168.217.1
!
line con 0
line vty 0 4
    login authentication method
!
End
```

On the SSH client, choose **System Management>Device Management**, and add the device IP address **192.168.217.81** and the device key **aaaradius**.

Choose **Security Management>Device Management Rights**, and set the rights of the login user.

Choose **Security Management>Device Administrator**, and add the user name **user** and password **pass**.

Configure the SSH client and set up a connection to the SSH server. For details, see the previous example.

Type in the user name **user** and password **pass**. Verify that you can log in to the SSH server successfully.

```
FS#show users

   Line      User      Host(s)      Idle      Location
-----
0 con 0
* 1 vty 0    user      idle         00:00:33  192.168.217.60
```

➤ **Configuring Public Key Authentication of SSH Users**

Scenario
Figure 7- 18



SSH users can use the public key for user authentication, and the public key algorithm is RSA or DSA, as shown in Figure 7- 18.SSH is configured on the client so that a secure connection is set up between the SSH client and the SSH server.

Configuration Steps

- To implement public key authentication on the client, generate a key pair (for example, RSA key) on the client, place the public key on the SSH server, and select the public key authentication mode.
- After the key pair is generated on the client, you must save and upload the public key file to the server and

complete the server-related settings before you can continue to configure the client and connect the client with the server.

- After the key is generated on the client, copy the public key file from the client to the flash of the SSH server, and associate the file with an SSH user name. A user can be associated with one RSA public key and one DSA public key.

SSH Client

Run the **puttygen.exe** software on the client. Select **SSH-2 RSA** in the **Parameters** pane, and click **Generate** to generate a key, as shown in Figure 7- 19.

Figure 7- 19



When a key is being generated, you need to constantly move the mouse over a blank area outside the green progress bar; otherwise, the progress bar does not move and key generation stops, as shown in Figure 7- 20.

Figure 7- 20



To ensure security of the RSA public key authentication, the length of the generated RSA key pair must be equal to or larger than 768 bits. In this example, the length is set to 1024 bits.

Figure 7- 21

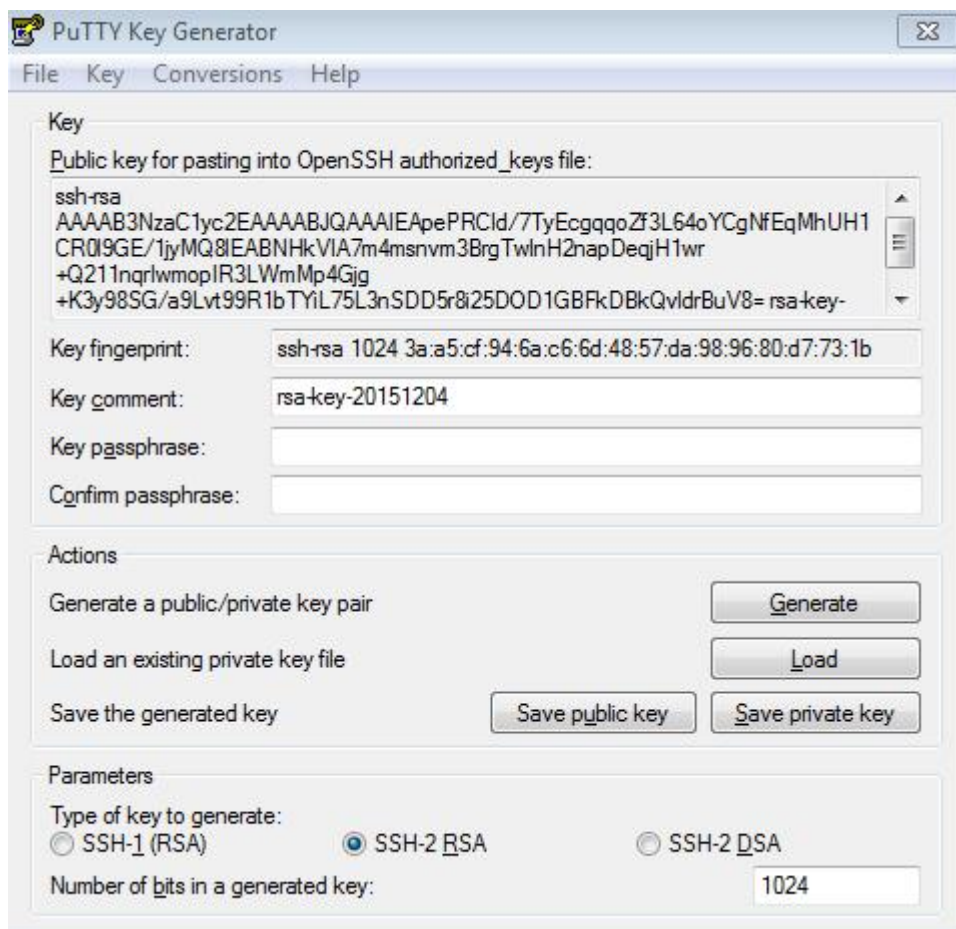

After the key pair is generated, click **Save public key**, type in the public key name **test_key.pub**, select the storage path, and click **Save**. Then click **Save private key**. The following prompt box is displayed. Select **Yes**, type in the public key name **test_private**, and click **Save**.

Figure 7- 22



You must select the OpenSSH key file; otherwise, the key file cannot be used. The **puttygen.exe** software can be used to generate a key file in OpenSSH format, but this file cannot be directly used by the PuTTY client. You must use **puttygen.exe** to convert the private key to the PuTTY format. Format conversion is not required for the public key file stored on the server, and the format of this file is still OpenSSH, as shown in Figure 7- 23.

Figure 7- 23

	<p>The screenshot shows the PuTTY Key Generator application. The 'Conversions' menu is open, showing options: 'Import key', 'Export OpenSSH key', and 'Export ssh.com key'. The main window displays a generated key pair with a public key starting with 'ssh-rsa AAAAB3CR0I9GE...' and a private key starting with '+Q211nqrlwmpIR3LWmMp4Gjg...'. The key fingerprint is 'ssh-rsa 1024 3a:a5:cf:94:6a:c6:6d:48:57:da:98:96:80:d7:73:1b'. The key comment is 'rsa-key-20151204'. The 'Actions' section has buttons for 'Generate', 'Load', 'Save public key', and 'Save private key'. The 'Parameters' section shows 'Type of key to generate' set to 'SSH-2 RSA' and 'Number of bits in a generated key' set to '1024'.</p>
<p>SSH Server</p>	<pre>FS#configure terminal FS(config)# ip ssh peer test public-key rsaflash:test_key.pub</pre>
<p>Verification</p>	<ul style="list-style-type: none"> After completing the basic configurations of the client and the server, specify the private key file test_private on the PuTTY client, and set the host IP address to 192.168.23.122 and port ID to 22 to set up a connection between the client and the server. In this way, the client can use the public key authentication mode to log in to the network device.
	<p>Figure 7- 24</p>

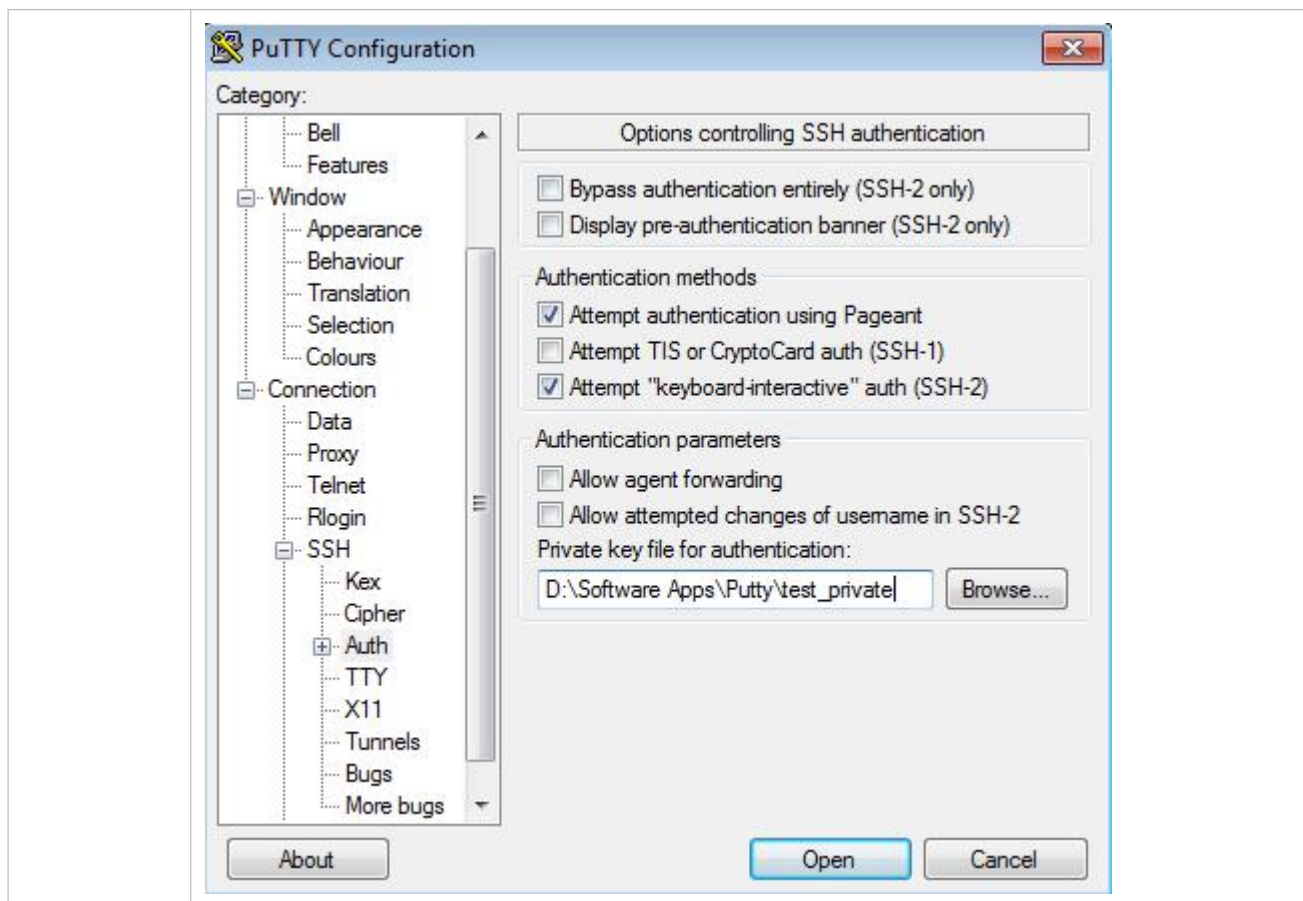

Common Errors

- The **no crypto key generate** command is used to delete a key.

7.4.2 Configuring the SCP Service

Configuration Effect

After the SCP function is enabled on a network device, you can directly download files from the network device and upload local files to the network device. In addition, all interactive data is encrypted, featuring authentication and security.

Notes

- The SSH server must be enabled in advance.

Configuration Steps

➤ Enabling the SCP Server

- Mandatory.
- By default, the SCP server function is disabled. Run the **ip scp server enable** command to enable the SCP server function in global configuration mode.

Verification

Run the **show ip ssh** command to check whether the SCP server function is enabled.

Related Commands

↘ **Enabling the SCP Server**

Command	ip scp server enable
Parameter	N/A
Description	
Command Mode	Global configuration mode
Usage Guide	This command is used to enable the SCP server. Run the no ip scp server enable command to disable the SCP server.

Configuration Example

↘ **Enabling the SCP Server**

Configuration Steps	<ul style="list-style-type: none"> Run the ip scp server enable command to enable the SCP server.
	<pre>FS#configure terminal FS(config)#ip scp server enable</pre>
Verification	<ul style="list-style-type: none"> Run the show ip ssh command to check whether the SCP server function is enabled.
	<pre>FS(config)#show ipssh SSH Enable - version 1.99 Authentication timeout: 120 secs Authentication retries: 3 SSH SCP Server: enabled</pre>

↘ **Configuring SSH File Transfer**

<p>Scenario Figure 7- 25</p>	<p>SSH Client 192.168.23.83</p> <p>IP Network</p> <p>SSH Server 192.168.23.122</p> <p>The SCP service is enabled on the server, and SCP commands are used on the client to transfer data to the server.</p>
Configuration Steps	<ul style="list-style-type: none"> Enable the SCP service on the server. <i>i</i> The SCP server uses SSH threading. When connecting to a network device for SCP transmission, the client occupies a VTY session (You can find out that the user type is SSH by running the show user command). On the client, use SCP commands to upload files to the server, or download files from the server. <p>Syntax of the SCP command:</p> <pre>scp [-1246BCpqrv] [-c cipher] [-F ssh_config] [-iidentity_file] [-l limit] [-o ssh_option] [-P port] [-S program]</pre>

	<pre>[[user@]host1:]file1 [...] [[user@]host2:]file2</pre> <p>Descriptions of some options:</p> <ul style="list-style-type: none"> -1: Uses SSHv1 (If not specified, SSHv2 is used by default); -2: Uses SSHv2 (by default); -C: Uses compressed transmission. -c: Specifies the encryption algorithm to be used. -r:Transmits the whole directory; -i: Specifies the key file to be used. -l: Limits the transmission speed (unit: Kbit/s). <p>For other parameters, see the filescp.0.</p>
<p>SSH Server</p>	<pre>FS#configure terminal FS(config)# ip scp server enable</pre>
<p>Verification</p>	<ul style="list-style-type: none"> ● File transmission example on the Ubuntu 7.10 system: <p>Set the username of a client to test and copy the config.text file from the network device with the IP address of 192.168.195.188 to the /root directory on the local device.</p>
	<pre>root@dhcpd:~#scp test@192.168.23.122:/config.text /root/config.text test@192.168.195.188's password: config.text 100% 1506 1.5KB/s 00:00 Read from remote host 192.168.195.188: Connection reset by peer</pre>

7.4.3Configuring the SSH Client

Configuration Effect

On the network device that supports the SSH server, enable the SSH server function, and specify the user authentication method and supported SSH versions. Then, you can use the built-in SSH client function of the device to set up a secure connection with the SSH server, implementing remote device management.

Notes

- The SSH server function must be configured in advance on the device that needs to remotely support the SSH server.
- The SSH client must communicate with the SSH server properly.

Configuration Steps

➤ Specifying the Source Interface of the SSH Client

- (Optional) This configuration must be performed on the SSH-client device.

➤ Establishing a Session with the SSH Server

- (Optional) Use the **ssh** command on the client to set up a connection with a remote server.
- Before using this command, enable the SSH server function and configure the SSH key and authentication mode on the server.

↘ **Recovering an Established SSH Session**

- (Optional) Run the related command to recover a session after temporary stop if necessary.

↘ **Disconnecting a Suspended SSH Session**

- (Optional) This configuration must be performed on the SSH client if you need to disconnect a specified SSH session.

Verification

Run the **show ssh-session** command to display information about every established SSH client session.

Related Commands

↘ **Specifying the Source Interface of the SSH Client**

Command	ip ssh source-interface <i>interface-name</i>
Parameter Description	<i>interface-name</i> : Specifies an interface, the IP address of which will be used as the source address of an SSH client session.
Command Mode	Global configuration mode
Usage Guide	This command is used to specify an interface, the IP address of which will be used as the global source address of an SSH client session. When the ssh command is used to connect to an SSH server, this global configuration will be used if a source interface or a source address is not specified for this connection. Run the no ip ssh source-interface command to restore the default setting.

↘ **Establishing a Session with the SSH Server**

Command	ssh [oob] [-v {1 2}][-c {3des aes128-cbc aes192-cbc aes256-cbc}] [-l <i>username</i>] [-m {hmac-md5-96 hmac-md5-128 hmac-sha1-96 hmac-sha1-160}] [-p <i>port-num</i>] [{ <i>ip-addr</i> <i>hostname</i> }] [via <i>mgmt-name</i>] [/source { ip <i>A.B.C.D</i> ipv6 <i>X:X:X::X</i> interface <i>interface-name</i> }] [/vrf <i>vrf-name</i>]
Parameter Description	N/A
Command Mode	User EXEC mode
Usage Guide	<p>The ssh command is used to set up a secure and encrypted connection from the local device (an SSH client) to another device (an SSH server) or any other server that supports SSHv1 or SSHv2. This connection provides a mechanism similar to the Telnet connection except that all data transmitted over this connection is encrypted. Based on authentication and encryption, the SSH client can set up a secure connection on an insecure network.</p> <ul style="list-style-type: none"> SSHv1 supports only the DES (56-bit key) and 3DES (168-bit key) encryption algorithms. SSHv2 supports the following Advanced Encryption Standards (AES):ASE128-CBC, AES192-CBC, AES256-CBC, AES128-CTR, AES192-CTR, and AES256-CTR. SSHv1 does not support the Hashed Message Authentication Code (HMAC). If you specify an unmatched encryption or authentication algorithm when selecting an SSH version, the unmatched algorithm will be ignored when a connection is set up.

↘ **Recovering an Established SSH Client Session**

Command	ssh-session <i>session-id</i>
Parameter Description	<i>session-id</i> : Indicates the ID of an established SSH client session.
Command Mode	User EXEC mode
Usage Guide	This command is used to restore the use of an established SSH client session. When the ssh command is used to initiate an SSH client session, you can press Ctrl+Shift+6+X to temporarily exit the session. To recover this session, run the ssh-session command. In addition, if the session is already established, you can run the show ssh-session command to display information about the established session.

↘ **Disconnecting a Suspended SSH Session**

Command	disconnect ssh-session <i>session-id</i>
Parameter Description	<i>session-id</i> : Indicates the ID of a suspended SSH client session.
Command Mode	User EXEC mode
Usage Guide	You can specify an SSH client session ID to disconnect the specified SSH client session.





Configuration Example

↘ **Specifying the Source Interface of the SSH Client**

Configuration Steps	<ul style="list-style-type: none"> Run the ip ssh source-interface <i>interface-name</i> command to specify an interface, the IP address of which will be used as the global source address of an SSH client session.
	<pre>FS#configure terminal FS(config)#ipsshsource-interface gigabitEthernet 0/1</pre>
Verification	N/A

↘ **Establishing a Session with the SSH Server**

Scenario Figure 7- 26	<p>The SSH server function is enabled on the server. The ssh command is used on the client to set up a secure connection with the server.</p>
Configuration Steps	<ul style="list-style-type: none"> Enable the SSH server function on the server. Configure the SSH key on the server. Configure the authentication mode of the SSH server, and use the local line authentication mode for Line 0 to Line 4. Configure the IP address of the Gi 0/1 interface of the SSH server. The client will use this address as the source address to connect to the SSH server.

	<ul style="list-style-type: none"> ● Configure the SSH client, and specify the source address of the SSH client. ●  By default, the SSH server supports two SSH versions: SSHv1 and SSHv2. ●  With this key, the SSH server decrypts the encrypted password received from the SSH client, compares the decrypted plain text with the password stored on the server, and returns a message indicating the successful or unsuccessful authentication. SSHv1 uses an RSA key, whereas SSHv2 uses an RSA or DSA key. ●  The authentication mode used by the SSH server is local line authentication. The local user name is admin, and the password is 123456. ●  The SSH client is connected to the SSH server based on this IP address. The routes from the SSH clients to the SSH server are reachable. ●  Configure the IP address of the Gi 0/1 interface of the SSH server. The client will use this address as the source address to connect to the SSH server.
<p>SSH Server</p>	<pre> FS#configure terminal FS(config)#enable service ssh-server FS(config)#crypto key generate rsa % You already have RSA keys. % Do you really want to replace them? [yes/no]: Choose the size of the key modulus in the range of 360 to 2048 for your Signature Keys. Choosing a key modulus greater than 512 may take a few minutes. How many bits in the modulus [512]: % Generating 512 bit RSA1 keys ...[ok] % Generating 512 bit RSA keys ...[ok] FS(config)#line vty 0 4 FS(config-line)#login local FS(config-line)#exit FS(config)#username admin password 123456 FS(config)#username admin privilege 15 FS(config-line)#exit FS(config)#interface gigabitEthernet0/1 FS(config-if-gigabitEthernet0/1)#ip address 192.168.23.122 255.255.255.0 FS(config-if-gigabitEthernet0/1)#exit </pre>
<p>SSH Client</p>	<pre> FS(config)#interface gigabitEthernet0/1 FS(config-if-gigabitEthernet0/1)#ip address 192.168.23.83 255.255.255.0 FS(config-if-gigabitEthernet0/1)#exit FS(config)#ipsshsource-interface gigabitEthernet 0/1 </pre>

<p>Verification</p>	<ul style="list-style-type: none"> ● Run the show running-config include username and show ip ssh commands to verify whether the SSH server configurations are correct. ● On the SSH client, set up a connection with a remote SSH server. After the connection is set up, type in the correct password 123456. The SSH server operation interface is displayed. Check the login user on the Console of the SSH client.
	<pre> FS(config)#sh running-config include username username admin password admin username admin privilege 15 FS(config)#sh running-config begin line line con 0 line vty 0 4 login local ! ! end </pre>
	<ul style="list-style-type: none"> ● Verify whether the SSH client configurations are correct.
	<pre> FS#ssh -l admin 192.168.23.122 %Trying 192.168.23.122, 22,...open admin@192.168.23.122's password: FS# FS#sh users Line User Host(s) Idle Location 0 con 0 idle 00:00:00 * 1 vty 0 admin idle 00:00:36 192.168.217.20 </pre>

7.4.4Configuring the SCP Client

Configuration Effect

On the network device that supports the SCP server, enable the SCP service so that users can directly download files from the network device and upload local files to the network device. In addition, all exchanged data is encrypted, featuring authentication and security.

Notes

- The SSH server function must be configured and the SCP service must be enabled on the device in order to remotely support the SCP server.
- The SCP client must communicate with the SCP server properly.

Configuration Steps

➤ **Specifying Source Interface of SCP Client**

- (Optional) Specify a source interface of the SCP client.

➤ **Implementing File Transfer with SCP Server via SCP Client**

- (Optional) Run the **scp** command to implement file transfer with the remote SCP server via the SCP client.
- Before running this command, enable the SSH server function, configure an SSH key and authentication mode, and enable the SCP server function.

Verification

Check whether file transfer is successful.

Related Commands

➤ **Specifying Source Interface of SCP Client**

Command	ip scp client source-interface <i>interface-name</i>
Parameter Description	<i>interface-name</i> : Indicates a source interface. Set the IP address of the interface to the source IP address of the SCP client.
Command Mode	Global configuration mode
Usage Guide	Run this command to specify the IP address of the designated interface as the global source address of the SCP client. During interaction with the remote SSH server via the scp command, global settings are used if no source interface or source address is specified. Run the no ip ssh source-interface command to restore the default settings.

➤ **Implementing File Transfer with SCP Server via SCP Client**

Command	scp [oob] [-v { 1 2 }] [-c { 3des aes128-cbc aes192-cbc aes256-cbc }] [-l <i>username</i>] [-m { hmac-md5-96 hmac-md5-128 hmac-sha1-96 hmac-sha1-160 }] [-p <i>port-num</i>] { <i>filename</i> <i>username@host:/filename</i> <i>username@host:/filename filename</i> } [via <i>mgmt-name</i>] [/source { ip <i>A.B.C.D</i> ipv6 <i>X:X:X::X</i> } interface <i>interface-name</i> }] [/vrf <i>vrf-name</i>]
Parameter Description	N/A
Command Mode	Common user mode
Usage Guide	Run the scp command to establish a secure and encrypted connection from the local device (SCP client) to another device (SCP server) to implement file transfer.

Configuration Example

➤ **Specifying Source Interface of SCP Client**

Configuration Steps	<ul style="list-style-type: none"> ● Run the ip scp client source-interface <i>interface-name</i> command to specify the IP address of the interface as the global source address of the SCP client.
----------------------------	--

	<pre>FS# configure terminal FS(config)# ip scp client source-interface gigabitEthernet 0/1</pre>
Verification	N/A

📌 **Implementing File Transfer with SCP Server via SCP Client**

<p>Scenario Figure 7- 27</p>	 <p>Enable the SSH server and SCP server functions on the server end, and run the scp command on the SCP client to implement file transfer with the server.</p>
<p>Configuration Steps</p>	<ul style="list-style-type: none"> ● Enable the SSH server function on the server end. ● Configure an SSH key on the server end. ● Configure an authentication mode for the SSH server, and configure the local authentication mode for lines 0 to 4. ● Enable the SCP server function. ● Configure the IP address of the Gi 0/1 interface of the SSH server, so that the client uses this address as the source address to connect to the SSH server. ● Configure the SSH client, and specify the source address of the SSH client. <p>i By default, the SSH server supports two SSH versions: SSHv1 and SSHv2.</p> <p>i With this key, the SSH server decrypts the encrypted password received from the SSH client, compares the decrypted plain text with the password stored on the server, and returns an authentication success or failure message. SSHv1 uses an RSA key, while SSHv2 uses an RSA or DSA key.</p> <p>i The SSH server uses the local authentication mode. The local username is admin, and the password is 123456.</p> <p>i The SSH client connects to the SSH server at this IP address. The route from the SSH client to the SSH server is reachable.</p> <p>i Configure the IP address of the Gi 0/1 interface of the SSH client, so that the client uses this address as the source address to connect to the SSH server.</p>
<p>SCP Server</p>	<pre>FS# configure terminal FS(config)#enable service ssh-server FS(config)#crypto key generate rsa % You already have RSA keys. % Do you really want to replace them? [yes/no]: Choose the size of the key modulus in the range of 360 to 2048 for your Signature Keys. Choosing a key modulus greater than 512 may take</pre>

	<pre>a few minutes. How many bits in the modulus [512]: % Generating 512 bit RSA1 keys ...[ok] % Generating 512 bit RSA keys ...[ok] FS(config)#line vty 0 4 FS(config-line)#login local FS(config-line)#exit FS(config)#username admin password 123456 FS(config)#username admin privilege 15 FS(config-line)#exit FS(config)#interface gigabitEthernet 0/1 FS(config-if-gigabitEthernet 0/1)#ip address 192.168.23.122 255.255.255.0 FS(config-if-gigabitEthernet 0/1)#exit</pre>
<p>SSH Client</p>	<pre>FS(config)#interface gigabitEthernet 0/1 FS(config-if-gigabitEthernet 0/1)#ip address 192.168.23.83 255.255.255.0 FS(config-if-gigabitEthernet 0/1)#exit FS(config)# ip scp server enable FS(config)#ip ssh source-interface gigabitEthernet 0/1</pre>
<p>Verification</p>	<ul style="list-style-type: none"> ● Run the show running-config include username and show ip ssh commands to verify the SSH server configuration. ● On the SSH client, set up a connection with the remote SSH server. After the connection is set up, enter the password 123456. The SSH server operation interface is displayed. Check the logged-in user on the console of the SSH client.
	<pre>FS(config)#sh running-config include username username admin password admin username admin privilege 15 FS(config)#sh running-config begin line line con 0 line vty 0 4 login local ! ! end</pre>
	<ul style="list-style-type: none"> ● Verify the SCP client configuration.

```
FS#scp config.text admin@192.168.23.122:/config.text
%Trying 192.168.23.122, 22,...open
admin@192.168.23.122's password:
FS#
```

7.5 Monitoring

Displaying

Description	Command
Displays the effective SSH server configurations.	show ipssh
Displays the established SSH connection.	show ssh
Displays the public information of the SSH public key.	show crypto key mypubkey
Displays the established SSH client session.	show ssh-session

Debugging



System resources are occupied when debugging information is output. Therefore, disable debugging immediately after use.

Description	Command
Debugs SSH sessions.	debug ssh
Debugs SSH client sessions.	debug ssh client

8 Configuring URPF

8.1 Overview

Unicast Reverse Path Forwarding (URPF) is a function that protects the network against source address spoofing.

URPF obtains the source address and inbound interface of a received packet, and searches a forwarding entry in the forwarding table based on the source address. If the entry does not exist, the packet is dropped. If the outbound interface of the forwarding entry does not match the inbound interface of the packet, the packet is also dropped. Otherwise, the packet is forwarded.

URPF is implemented in two modes:

- Strict mode: It is often deployed on a point-to-point (P2P) interface, and inbound and outbound data streams must go through the network of the P2P interface.
- Loose mode: It is applicable to the asymmetric routes or multihomed network that have the problem of asymmetric traffic.

Protocols and Standards

- RFC 2827: Network Ingress Filtering: DDOS Attacks which employ IP Source Address Spoofing
- RFC 3704: Ingress Filtering for Multi-homed Networks

8.2 Applications

Application	Description
-------------	-------------

Strict Mode	Block the packets with spoofed sourced addresses at the access layer or aggregation layer to prevent sending these packets from PCs to the core network.
Loose Mode	On a multihomed network, the user network is connected to multiple Internet service providers (ISPs), and the inbound and outbound traffic is not symmetric. Deploy the URPF loose mode on the outbound interface connected to ISPs to prevent invalid packets from attacking the user network.

8.2.1 Strict Mode

Scenario

An attacker initiates an attack by sending packets with the spoofed source address 11.0.0.1. As a result, the server sends a lot of SYN or ACK packets to the hosts that do not initiate the attack, and the host with the real source address 11.0.0.1 is also affected. Even worse, if the network administrator determines that this address initiates an attack to the network, and therefore blocks all data streams coming from this source address, the denial of service (DoS) of this source address occurs.

Figure 8- 1

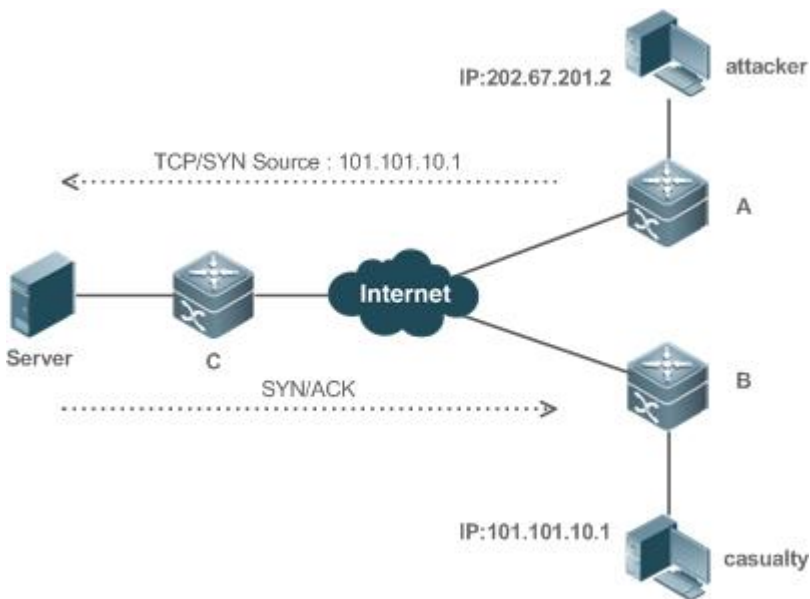

Remarks	The attacker sends spoofing packets using a spoofed address of the casualty.
----------------	--

Deployment

- Deploy the URPF strict mode on device A to protect the device against source address spoofing.

8.2.2 Loose Mode

Scenario

The asymmetric route is a common network application used to control the network traffic or to meet the routing policy requirements.

As shown in Figure 8- 2, if the URPF strict mode is enabled on the G1/1 interface of R 1, R1 receives a packet from the network segment 192.168.20.0/24 on the G1/1 interface, but the interface obtained through the URPF check is G1/2. Therefore, this packet fails in the URPF check and is dropped.

Figure 8-2

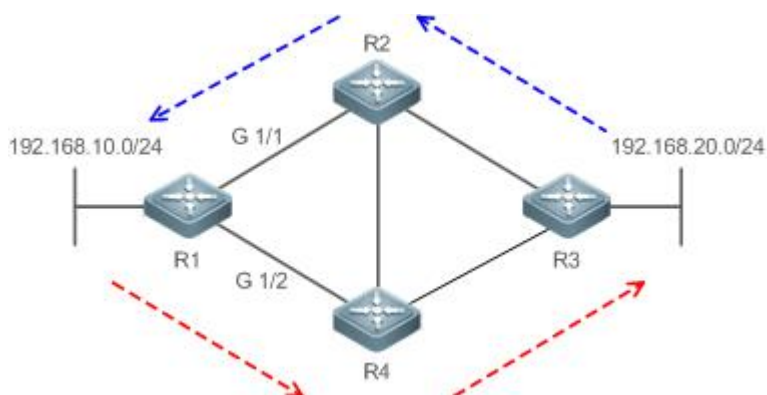

Deployment

- Reversely search a route based on the source IP address of a received packet. The purpose is to find a route, and it is not required that the outbound interface of the next hop on the route must be the inbound interface of the received packet.
- The URPF loose mode can resolve the asymmetric traffic problem of the asymmetric route and prevents access of invalid data streams.

8.3 Features

Basic Concepts

✎ URPF Strict Mode

Obtain the source address and inbound interface of a received packet, and search a forwarding entry in the forwarding table based on the source address. If the entry does not exist, the packet is dropped. If the outbound interface of the forwarding entry does not match the inbound interface of the packet, the packet is also dropped. The strict mode requires that the inbound interface of a received packet must be the outbound interface of the route entry to the source address of the packet.

✎ URPF Loose Mode

Reversely search a route based on the source IP address of a received packet. The purpose is to find a route, and it is not required that the outbound interface of the next hop on the route must be the inbound interface of the received packet. However, the route cannot be a route of a host on the local network.

✎ URPF Packet Loss Rate

The URPF packet loss rate is equal to the number of packets dropped due to the URPF check per second. The unit is packets/second, that is, pps.

✎ Calculation Interval of the URPF Packet Loss Rate

It is the interval from the previous time the packet loss rate is calculated to the current time the packet loss rate is calculated.

✎ Sampling Interval of the URPF Packet Loss Rate

It is the interval at which the number of lost packets is collected for calculating the packet loss rate. This interval must be equal to or longer than the calculation interval of the packet loss rate.

↘ **Threshold of the URPF Packet Loss Rate**

It refers to the maximum packet loss rate that is acceptable. When the packet loss rate exceeds the threshold, alarms can be sent to users through syslogs or trap messages. You can adjust the threshold of the packet loss rate based on the actual conditions of the network.

↘ **Alarm Interval of the URPF Packet Loss Rate**

It is the interval at which alarms are sent to users. You can adjust the alarm based on the actual conditions of the network to prevent frequently output of logs or trap messages.

↘ **Calculation of the URPS Packet Loss Rate**

Between the period of time from enabling of URPF to the time that the sampling interval arrives, the packet loss rate is equal to the number of lost packets measured within the sampling interval divided by the URPF enabling duration. After that, the packet loss rate is calculated as follows: Current packet loss rate = (Current number of lost packets measured at the calculation interval – Number of lost packets measured before the sampling interval)/Sampling interval

Overview

Feature	Description
Enabling URPF	Enable URPF to perform a URPF check,thus protecting the device against source address spoofing.
Notifying the URPF Packet Loss Rate	To facilitate monitoring of information about lost packets after URPF is enabled, FS devices support the use of syslogs and trap messages to proactively notify users of the packet loss information detected in the URPF check.

8.3.1 Enabling URPF

Enable URPF to perform a URPF check on IP packets, thus protecting the device against source address spoofing.

Working Principle

URPF can be applied to IP packets based on configurations, but the following packets are not checked by URPF:

1. After URPF is enabled, the source address of a packet is checked only if the destination address of the packet is an IPv4/IPv6 unicast address, and is not checked if the packet is a multicast packet or an IPv4 broadcast packet.
2. If the source IP address of a DHCP/BOOTP packet is 0.0.0.0 and the destination IP address is 255.255.255.255, the packet is not checked by URPF.
3. A loopback packet sent by the local device to itself is not checked by URPF.

↘ **URPF Configured in Interface configuration mode**

URPF is performed on packets received on the configured interface. Interface configuration mode and global configuration mode are mutually exclusive.

- By default, the default route is not used for the URPF check. You can configure data to use the default route for the URPF check if necessary.
- By default, packets that fail in the URPF check will be dropped. If the ACL (*acl-name*) is configured, the packet is matched against the ACL after it fails in the URPF check. If no ACL exists, or a packet matches a deny ACL entry (ACE), the packet will be dropped. If the packet matches a permit ACE, the packet will be forwarded.

A switch supports configuration of URPF on a routed port of L3 aggregate port (AP). Switches of some models also support this configuration on SVI. (For details, contact FS's technical staff.) The following constraints exist:

- URPF does not support association with the ACL option.
- After URPF is enabled on interfaces, a URPF check is performed on all packets received on physical ports corresponding to these interfaces, which increase the scope of packets checked by URPF. If a packet received on a tunnel port is also received on the preceding physical ports, the packet is also checked by URPF. In such a scenario, be cautious in enabling URPF.
- After URPF is enabled, the route forwarding capacity of the device will be reduced by half.
- After the URPF strict mode is enabled, if a packet received on an interface matches an equal-cost route during the URPF check, the packet will be processed according to the URPF loose mode.

Related Configuration

📌 Enabling URPF for a Specified Interface

By default, URPF is disabled for a specified interface.

Run the **ip verify unicast source reachable-via {rx | any} [allow-default] [acl-name]** command to enable or disable the IPv4 URPF function for a specified interface.

By default, the default route is not used for the URPF check. You can use the **allow-default** keyword to use the default route for the URPF check if necessary.

By default, packets that fail in the URPF check will be dropped. If the ACL (*acl-name*) is configured, the packet is matched against the ACL after it fails in the URPF check. If no ACL exists, or a packet matches a deny ACE, the packet will be dropped. If the packet matches a permit ACE, the packet will be forwarded.

8.3.2 Notifying the URPF Packet Loss Rate

To facilitate monitoring of information about lost packets after URPF is enabled, FS devices support the use of syslogs and trap messages to proactively notify users of the packet loss information detected in the URPF check.

Working Principle

Between the period of time from enabling of URPF to the time that the sampling interval arrives, the packet loss rate is equal to the number of lost packets measured within the sampling interval divided by the URPF enabling duration. After that, the packet loss rate is calculated as follows: Current packet loss rate = (Current number of lost packets measured at the calculation interval – Number of lost packets measured before the sampling interval)/Sampling interval

After the function of monitoring the URPF packet loss information is enabled, the device can proactively send syslogs or trap messages to notify users of the packet loss information detected in the URPF check so that users can monitor the network status conveniently.

Related Configuration

📌 Configuring the Calculation Interval of the URPF Packet Loss Rate

By default, the calculation interval of the URPF packet loss rate is 30s. If the calculation interval is found too short, run the **ip verify urpf drop-rate compute interval seconds** command to modify the calculation interval.

The calculation interval of the URPF packet loss rate ranges from 30 to 300.

📌 Configuring the Alarm Interval of the URPF Packet Loss Rate

By default, the alarm interval of the URPF packet loss rate is 300s. If the alarm interval is found inappropriate, run the **ip verify urpf drop-rate notify hold-down seconds** command to modify the alarm interval of the URPF packet loss rate.

The unit of the alarm interval is second. The value ranges from 30 to 300.

📌 Configuring the Function of Monitoring the URPF Packet Loss Information

By default, the function of monitoring the URPF packet loss information is disabled.



Run the **ip [ipv6] verify urpf drop-rate notify** command to enable or disable the function of monitoring the URPF packet loss information.

📌 Configuring the Threshold of the URPF Packet Loss Rate

By default, the threshold of the URPF packet loss rate is 1000 pps. If the threshold is found inappropriate, run the **ip [ipv6] verify urpf notification threshold rate-value** command to modify the threshold of the URPF packet loss rate.

The unit of the threshold is pps. The value ranges from 0 to 4,294,967,295.

8.4 Configuration

Configuration Item	Description and Command
Enabling URPF	 (Mandatory) It is used to enable URPF.
	ip verify unicast source reachable-via { rx any } [allow-default] [acl_name] (Interface configuration mode) Enables URPF for a specified interface.
Configuring the Function of Monitoring the URPF Packet Loss Information	 (Optional) It is used to enable the function of monitoring the URPF packet loss information.
	ip verify urpf drop-rate compute interval seconds Configures the calculation interval of the URPF packet loss rate.
	ip verify urpf drop-rate notify Configures the function of monitoring URPF packet loss information.
	ip verify urpf drop-rate notify hold-down seconds Configures the alarm interval of the URPF packet loss rate.
	ip erify urpf notification threshold rate-value Configures the threshold of the URPF packet loss rate.

8.4.1 Enabling URPF

Configuration Effect

- Enable URPF to perform a URPF check, thus protecting the device against source address spoofing.
- URPF enabled in interface configuration mode supports both the strict and loose modes.

Notes

- URPF is implemented with the help of the existing unicast routes on the network. Therefore, unicast routes must be configured on the network.

Configuration Steps

➤ **Enabling IPv4 URPF for a Specified Interface**

- Mandatory.

Verification

Enable URPF and check the source address as follows:

- If the strict mode is used, check whether a packet is forwarded only when the forwarding table contains the source address of the received IP packet and the outbound interface of the searched forwarding entry matches the inbound interface of the packet; otherwise, the packet is dropped.
- If the loose mode is used, check whether a packet is forwarded when a forwarding entry can be found in the forwarding table for the source address of the received IP packet; otherwise, the packet is dropped.

Related Commands

➤ **Enabling IPv4 URPF for a Specified Interface**

Command	ip verify unicast source reachable-via { rx any } [allow-default] [acl-id]
Parameter Description	<p>rx: Indicates that the URPF check is implemented in strict mode. The strict mode requires that the outbound interface of the forwarding entry found in the forwarding table based on the source address of a received IP packet must match the inbound interface of the packet.</p> <p>any: Indicates that the URPF check is implemented in loose mode. The loose mode only requires that a forwarding entry can be found in the forwarding table based on the source address of a received IP packet.</p> <p>allow-default: (Optional) Indicates that the default route can be used for the URPF check.</p> <p>acl-id: (Optional) Indicates the ID of the ACL. Values include 1 to 99 (IP standard access list), 100 to 199 (IP extended access list), 1300 to 1999 (IP standard access list, expanded range), and 2000 to 2699 (IP extended access list, expanded range).</p>
Command Mode	Interface configuration mode
Usage Guide	<p>Based on the source address of a received IP packet, URPF checks whether any route to the source address exists in the forwarding table and accordingly determines whether the packet is valid. If no forwarding entry is matched, the packet is determined as invalid.</p> <p>You can enable URPF in interface configuration mode to perform a URPF check on packets received on the interface. By default, the default route is not used for the URPF check. You can use the allow-default keyword to use the default route for the URPF check if necessary.</p> <p>By default, packets that fail in the URPF check will be dropped. If the ACL (<i>acl-name</i>) is configured, the packet is matched against the ACL after it fails in the URPF check. If no ACL exists, or a packet matches a deny ACE, the packet will be dropped. If the packet matches a permit ACE, the packet will be forwarded.</p> <p> A switch supports configuration of URPF on a routed port or L3 AP port. In addition, the following constraints exists:</p> <ol style="list-style-type: none"> 1. URPF does not support association with the ACL option. 2. After URPF is enabled on interfaces, a URPF check is performed on all packets received on physical ports corresponding to these interfaces, which increase the scope of packets checked by URPF. If a packet received on a tunnel port is also received on the preceding physical ports, the packet is also checked by URPF. In such a scenario, be cautious in enabling URPF. 3. After URPF is enabled, the route forwarding capacity of the device will be reduced by half.

	<p>4. After the URPF strict mode is enabled, if a packet received on an interface matches an equal-cost route during the URPF check, the packet will be processed according to the URPF loose mode.</p> <ul style="list-style-type: none"> i URPF configured in global configuration mode does not support URPF check using the default routing. i URPF configured in global configuration mode is mutually exclusive with URPF configured in interface configuration mode.
--	---

Configuration Example

Configuring the Strict Mode

	<p>Block the packets with spoofed sourced addresses at the access layer or aggregation layer to prevent sending these packets from PCs to the core network.</p> <p>To meet the preceding requirement, enable URPF in strict mode on the interface between the aggregation device and the access device.</p>
--	---

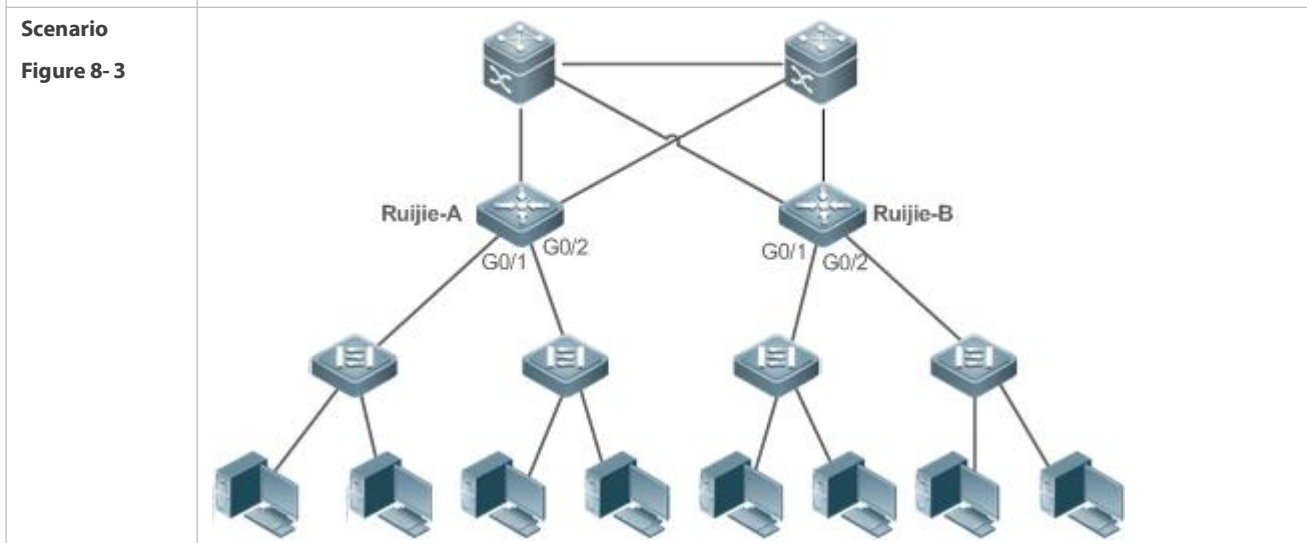

Verification	<p>As shown in Figure 8-3, enable URPF in strict mode on the aggregation devices, including FS A and FS B. The configurations are as follows:</p>
---------------------	--

FS-A	<pre> FS-A# configure terminal Enter configuration commands, one per line. End with CNTL/Z. FS-A (config)# interface gigabitEthernet0/1 FS-A (config-if-GigabitEthernet 0/1)#ip address 195.52.1.1 255.255.255.0 FS-A (config-if-GigabitEthernet 0/1)#ip verify unicast source reachable-via rx FS-A (config-if-GigabitEthernet 0/1)# ip verify urpf drop-rate notify FS-A (config-if-GigabitEthernet 0/1)#exit FS-A (config)# interface gigabitEthernet0/2 FS-A (config-if-GigabitEthernet 0/2)#ip address 195.52.2.1 255.255.255.0 FS-A (config-if-GigabitEthernet 0/2)#ip verify unicast source reachable-via rx FS-A (config-if-GigabitEthernet 0/2)# ip verify urpf drop-rate notify </pre>
-------------	--

	<pre>FS-A (config-if-GigabitEthernet 0/2)#exit</pre>
<p>FS-B</p>	<pre>FS-B# configure terminal Enter configuration commands, one per line. End with CNTL/Z. FS-B (config)# interface gigabitEthernet0/1 FS-B (config-if-GigabitEthernet 0/1)#ip address 195.52.3.1 255.255.255.0 FS-B (config-if-GigabitEthernet 0/1)#ip verify unicast source reachable-via rx FS-B (config-if-GigabitEthernet 0/1)# ip verify urpf drop-rate notify FS-B (config-if-GigabitEthernet 0/1)#exit FS-B (config)# interface gigabitEthernet0/2 FS-B (config-if-GigabitEthernet 0/2)#ip address 195.52.4.1 255.255.255.0 FS-B (config-if-GigabitEthernet 0/2)#ip verify unicast source reachable-via rx FS-B (config-if-GigabitEthernet 0/2)# ip verify urpf drop-rate notify FS-B (config-if-GigabitEthernet 0/2)#exit</pre>
<p>Verification</p>	<p>If source address spoofing exists on the network, run the show ip urpf command to display the number of spoofing packets dropped by URPF.</p>
<p>A</p>	<pre>FS-A#show ip urpf interface gigabitEthernet 0/1 IP verify source reachable-via RX IP verify URPF drop-rate notify enabled IP verify URPF notification threshold is 1000pps Number of drop packets in this interface is 124 Number of drop-rate notification counts in this interface is 0 FS-A#show ip urpf interface gigabitEthernet 0/2 IP verify source reachable-via RX IP verify URPF drop-rate notify enabled IP verify URPF notification threshold is 1000pps Number of drop packets in this interface is 133 Number of drop-rate notification counts in this interface is 0</pre>
<p>B</p>	<pre>FS-B#show ip urpf interface gigabitEthernet 0/1 IP verify source reachable-via RX IP verify URPF drop-rate notify enabled IP verify URPF notification threshold is 1000pps Number of drop packets in this interface is 124</pre>

<pre> Number of drop-rate notification counts in this interface is 0 FS-B#show ip urpf interface gigabitEthernet 0/2 IP verify source reachable-via RX IP verify URPF drop-rate notify enabled IP verify URPF notification threshold is 1000pps Number of drop packets in this interface is 250 Number of drop-rate notification counts in this interface is 0 </pre>

Configuring the Loose Mode

On the egress device FS A of user network A, to prevent invalid packets from attacking the user network, enable URPF in loose mode on the outbound interfaces G3/1 and G3/2 that connect to two ISPs.

Scenario
Figure 8-4



FS-A	<pre> FS-A# configure terminal Enter configuration commands, one per line. End with CNTL/Z. FS-A (config)# interface gigabitEthernet3/1 FS-A (config-if-GigabitEthernet 3/1)# ip address 195.52.1.2 255.255.255.252 FS-A (config-if-GigabitEthernet 3/1)# ip verify unicast source reachable-via any FS-A (config-if-GigabitEthernet 3/1)# ip verify urpf drop-rate notify FS-A (config-if-GigabitEthernet 3/1)# exit FS-A (config)# interface gigabitEthernet3/2 FS-A (config-if-GigabitEthernet 3/2)# ip address 152.95.1.2 255.255.255.252 FS-A (config-if-GigabitEthernet 3/2)# ip verify unicast source reachable-via any FS-A (config-if-GigabitEthernet 3/2)# ip verify urpf drop-rate notify FS-A (config-if-GigabitEthernet 3/2)# end </pre>
Verification	<p>If source address spoofing exists on the network, run the show ip urpf command to display the number of spoofing packets dropped by URPF.</p>
A	<pre> FS #show ip urpf IP verify URPF drop-rate compute interval is 300s </pre>

```

IP verify URPF drop-rate notify hold-down is 300s
Interface gigabitEthernet3/1
IP verify source reachable-via ANY
IP verify URPF drop-rate notify enabled
IP verify URPF notification threshold is 1000pps
Number of drop packets in this interface is 4121
Number of drop-rate notification counts in this interface is 2
Interface gigabitEthernet3/2
IP verify source reachable-via ANY
IP verify URPF drop-rate notify enabled
IP verify URPF notification threshold is 1000pps
Number of drop packets in this interface is 352
Number of drop-rate notification counts in this interface is 0

```

8.4.2 Configuring the Function of Monitoring the URPF Packet Loss Information

Configuration Effect

- After the function of monitoring the URPF packet loss information is enabled, the device can proactively send syslogs or trap messages to notify users of the packet loss information detected in the URPF check so that users can monitor the network status conveniently.

Notes

- URPF must be enabled.

Configuration Steps

▾ Configuring the Calculation Interval of the URPF Packet Loss Rate

- Optional.
- Global configuration mode

▾ Configuring the Alarm Interval of the URPF Packet Loss Rate

- Optional.
- Global configuration mode

▾ Configuring the Function of Monitoring the URPF Packet Loss Information

- Optional.
- Interface configuration mode

▾ Configuring the Threshold of the URPF Packet Loss Rate

- Optional.

- Interface configuration mode

Verification

Simulate a source address spoofing attack, enable URPF, and check as follows:

- Enable the alarm function. After the packet loss rate exceeds the threshold, check whether an alarm can be generated normally.

Related Commands

▾ Configuring the Calculation Interval of the URPF Packet Loss Rate

Command	ip verify urpf drop-rate compute interval <i>seconds</i>
Parameter Description	interval seconds: Indicates the calculation interval of the URPF packet loss rate. The unit is second. The value ranges from 30 to 300. The default value is 30s.
Command Mode	Global configuration mode
Usage Guide	The calculation interval of the URPF packet loss rate is configured in global configuration mode. The configuration is applied to the global and interface-based calculation of the URPF packet loss rate.

▾ Configuring the Alarm Interval of the URPF Packet Loss Rate

Command	ip verify urpf drop-rate notify hold-down <i>seconds</i>
Parameter Description	hold-down seconds: Indicates the alarm interval of the URPF packet loss rate. The unit is second. The value ranges from 30 to 300. The default value is 30s.
Command Mode	Global configuration mode
Usage Guide	The alarm interval of the URPF packet loss rate is configured in global configuration mode. The configuration is applied to the global and interface-based alarms of the URPF packet loss rate.

▾ Configuring the Function of Monitoring the IPv4 URPF Packet Loss Information

Command	ip verify urpf drop-rate notify
Parameter Description	N/A
Command Mode	Interface configuration mode
Usage Guide	After the function of monitoring the URPF packet loss information is enabled, the device can proactively send syslogs or trap messages to notify users of the packet loss information detected in the URPF check so that users can monitor the network status conveniently.

▾ Configuring the Threshold of the IPv4 URPF Packet Loss Rate

Command	ip verify urpf notification threshold <i>rate-value</i>
Parameter Description	threshold rate-value: Indicates the threshold of the URPF packet loss rate. The unit is pps. The value ranges from 0 to 4,294,967,295. The default value is 1,000 pps.
Command Mode	Interface configuration mode
Usage Guide	If the threshold is 0, a notification is sent for every packet that is dropped because it fails in the URPF check. You can adjust the threshold based on the actual situation of the network.

Configuration Example

Setting the Calculation Interval of the URPF Packet Loss Rate to 120s

Configuration Steps	Set the calculation interval of the URPF packet loss rate to 120s in global configuration mode.
	<pre>FS#configure terminal FS(config)# ip verify urpf drop-rate compute interval 120 FS(config)# end</pre>
Verification	Run the show ip urpf command to check whether the configuration takes effect.
	<pre>FS# show ip urpf IP verify URPF drop-rate compute interval is 120s</pre>

Setting the Alarm Interval of the URPF Packet Loss Rate to 120s

Configuration Steps	Set the alarm interval of the URPF packet loss rate to 120s in global configuration mode. The configuration takes effect on both IPv4 URPF and IPv6 URPF.
	<pre>FS#configure terminal FS(config)# ip verify urpf drop-rate notify hold-down 120 FS(config)# end</pre>
Verification	Run the show ip urpf command to check whether the configuration takes effect.
	<pre>FS# show ip urpf IP verify URPF drop-rate notify hold-down is 120s</pre>

8.5 Monitoring

Clearing

Running the **clear** commands may lose vital information and thus interrupt services.

Description	Command
Clears statistics of the number of packets dropped during the IPv4 URPF check.	clear ip urpf [interface interface-name]

Displaying

Description	Command
Displays the IPv4 URPF configuration and statistics.	show ip urpf [interface interface-name]

Debugging

System resources are occupied when debugging information is output. Therefore, disable debugging immediately after use.

Description	Command
Debugs the URPF events.	debug urpf event
Debugs the URPF timers.	debug urpf timer

9 Configuring CPP

9.1 Overview

The CPU Protect Policy (CPP) provides policies for protecting the CPU of a switch.

In network environments, various attack packets spread, which may cause high CPU usages of the switches, affect protocol running and even difficulty in switch management. To this end, switch CPUs must be protected, that is, traffic control and priority-based processing must be performed for various incoming packets to ensure the processing capabilities of the switch CPUs.

CPP can effectively prevent malicious attacks in the network and provide a clean environment for legitimate protocol packets.

CPP is enabled by default. It provides protection during the entire operation of switches.

9.2 Applications

Application	Description
Preventing Malicious Attacks	When various malicious attacks such as ARP attacks intrude in a network, CPP divides attack packets into queues of different priorities so that the attack packets will not affect other packets.
Preventing CPU Processing Bottlenecks	Even when no attacks exist, it would become a bottleneck for CPU to handle excessive normal traffic. CPP can limit the rate of packets being sent to the CPU to ensure normal operation of switches.

9.2.1 Preventing Malicious Attacks

Scenario

Network switches at all levels may be attacked by malicious packets, typically ARP attacks.

As shown in Figure 9-1, switch CPUs process three types of packets: forwarding-plane, control-plane and protocol-plane. Forwarding-plane packets are used for routing, including ARP packets and IP route disconnection packets. Control-plane packets are used to manage services on switches, including Telnet packets and HTTP packets. Protocol-plane packets serve for running protocols, including BPDUs and OSPF packets.

When an attacker initiates attacks by using ARP packets, the ARP packets will be sent to the CPU for processing. Since the CPU has limited processing capabilities, the ARP packets may force out other packets (which may be discarded) and consume many CPU resources (for processing ARP attack packets). Consequently, the CPU fails to work normally. In the scenario as shown in Figure 9-1, possible consequences include: common users fail to access the network; administrators fail to manage switches; the OSPF link between switch A and the neighbor B is disconnected and route learning fails.

Figure 9-1 Networking Topology of Switch Services and Attacks

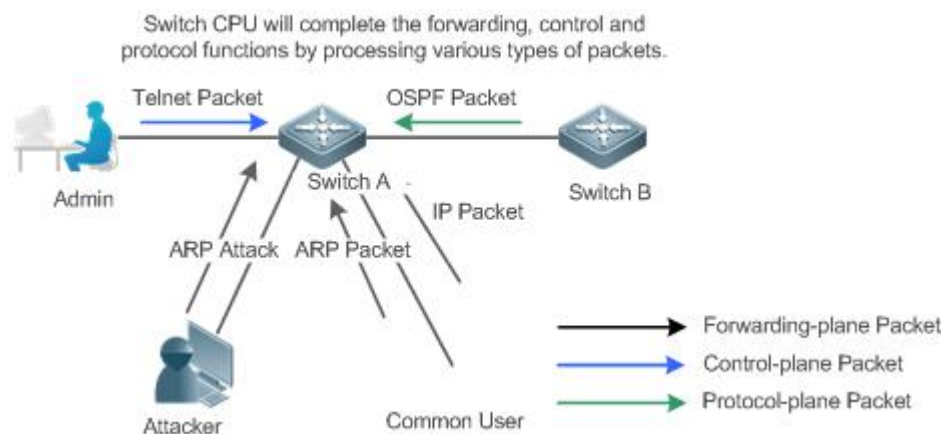

Deployment

- By default, CPP classifies ARP packets, Telnet packets, IP route disconnection packets, and OSPF packets into queues of different priorities. In this way, ARP packets will not affect other packets.
- By default, CPP limits the rates of ARP packets and the rates of the priority queue where the ARP packets reside to ensure that the attack packets do not occupy too many CPU resources.
- Packets in the same priority queue with ARP packets may be affected by ARP attack packets. You can divide the packets and the ARP packets into different priority queues by means of configuration.
- When ARP attack packets exist, CPP cannot prevent normal ARP packets from being affected. CPP can only differentiate the packet type but cannot distinguish attack packets from normal packets of the same type. In this case, the Network Foundation Protection Policy (NFPP) function can be used to provide higher-granularity attack prevention.

 For description of NFPP configurations, see the *Configuring NFPP*.

9.2.2 Preventing CPU Processing Bottlenecks

Scenario

Even though no attacks exist, many packets may need to be sent to the CPU for processing at an instant.

For example, the accesses to the core device of a campus network are counted in ten thousands. The traffic of normal ARP packets may reach dozens of thousands packets per second (PPS). If all packets are sent to the CPU for processing, the CPU resources cannot support the processing, which may cause protocol flapping and abnormal CPU running.

Deployment

- By default, the CPP function limits the rates of ARP packets and the rates of the priority queue where the APR packets reside to control the rate of ARP packets sent to the CPU and ensure that the CPU resource consumption is within a specified range and that the CPU can normally process other protocols.
- By default, the CPP function also limits the rates of other packets at the user level.

9.3 Features

Basic Concepts

📌 QoS, DiffServ

Quality of Service (QoS) is a network security mechanism, a technology used to solve the problems of network delay and congestion.

DiffServ refers to the differentiated service model, which is a typical model implemented by QoS for classifying service streams to provide differentiated services.

➤ **Bandwidth, Rate**

Bandwidth refers to the maximum allowable data rate, which refers to the rate threshold in this document. Packets whose rates exceed the threshold will be discarded.

The rate indicates an actual data rate. When the rate of packets exceeds the bandwidth, packets out of the limit will be discarded. The rate must be equal to or smaller than the bandwidth.

The bandwidth and rate units in this document are packets per second (pps).

➤ **L2, L3, L4**

The structure of packets is hierarchical based on the TCP/IP model.

L2 refers to layer-2 headers, namely, the Ethernet encapsulation part; L3 refers to layer-3 headers, namely, the IP encapsulation part; L4 refers to layer-4 headers, usually, the TCP/UDP encapsulation part.

➤ **Priority Queue, SP**

Packets are cached inside a switch and packets in the output direction are cached in queues. Priority queues are mapped to Strict Priorities (SPs). Queues are not equal but have different priorities.

The SP is a kind of QoS scheduling algorithm. When a higher priority queue has packets, the packets in this queue are scheduled first. Scheduling refers to selecting packets from queues for output and refers to selecting and sending the packets to the CPU in this document.

➤ **CPU interface**

Before sending packets to the CPU, a switch will cache the packets. The process of sending packets to the CPU is similar to the process of packet output. The CPU interface is a virtual interface. When packets are sent to the CPU, the packets will be output from this virtual interface. The priority queue and SP mentioned above are based on the CPU interface.

Overview

CPP protects the CPU by using the standard QoS DiffServ model.

Figure 9- 2 CPP Implementation Model

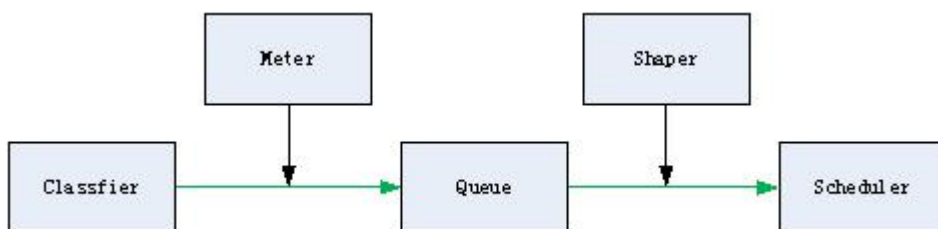

Feature	Description
Classifier	Classifies packet types and provides assurance for the subsequent implementation of QoS policies.
Meter	Limits rates based on packet types and controls the bandwidth for a specific packet type.
Queue	Queue packets to be sent to the CPU and select different queues based on packet types.
Scheduler	Selects and schedules queues to be sent to the CPU.

Shaper	Performs rate limit and bandwidth control on priority queues and the CPU interface.
--------	---

9.3.1 Classifier

Working Principle

The Classifier classifies all packets to be sent to the CPU based on the L2, L3 and L4 information of the packets. Classifying packets is the basis for implementing QoS policies. In subsequent actions, different policies are implemented based on the classification to provide differentiated services. A switch provides fixed classification. The management function classifies packet types based on the protocols supported by the switch, for example, STP BPDU packets and ICMP packets. Packet types cannot be customized.

9.3.2 Meter

Working Principle

The Meter limits the rates of different packets based on the preset rate thresholds. You can set different rate thresholds for different packet types. When the rate of a packet type exceeds the corresponding threshold, the packets out of the limit will be discarded.

By using the Meter, you can control the rate of a packet type sent to the CPU within a threshold to prevent specific attack packets from exerting large impacts on the CPU resources. This is the level-1 protection of the CPP.

Related Configuration

- By default, each packet type corresponds to a rate threshold (bandwidth) and Meter policies are implemented based on the rate threshold.
- In application, you can run the **cpu-protect type** *packet-type* **bandwidth** *bandwidth-value* command to set Meter policies for specified packet types.

9.3.3 Queue

Working Principle

Queues are used to classify packets at level 2. You can select the same queue for different packet types; meanwhile, queues cache packets inside switches and provide services for the Scheduler and Shaper.

CPP queues are SP queues. The SPs of the packets are determined based on the time when they are added to a queue. Packets with a larger queue number have a higher priority.

Related Configuration

- By default, each packet type is mapped to an SP queue.
- In application, you can run the **cpu-protect type** *packet-type* **traffic-class** *traffic-class-num* command to select SP queues for specific packet types.

9.3.4 Scheduler

Working Principle

The Scheduler schedules packets based on SPs of queues. That is, packets in a queue with a higher priority are scheduled first.

Before being scheduled, packets to be sent to the CPU are cached in queues. When being scheduled, the packets are sent to the CPU for processing.

i Only the SP scheduling policy is supported and cannot be modified.

9.3.5 Shaper

Working Principle

The Shaper is used to shape packets to be sent to the CPU, that is, when the actual rate of packets is greater than the shaping threshold, the packets must stay in the queue and cannot be scheduled. When packet rates fluctuate, the Shaper ensures that the rates of packets sent to the CPU are smooth (no more than the shaping threshold).

When the Shaper is available, packets in a queue with a lower priority may be scheduled before all packets in a queue with a higher priority are scheduled. If the rate of packets in a queue with certain priority exceeds the shaping threshold, scheduling of the packets in this queue may be stopped temporarily. Therefore, the Shaper can prevent packets in queues with lower priorities from starvation (which means that only packets in queues with higher priorities are scheduled and packets in queues with higher priorities are not scheduled).

Since the Shaper limits the scheduling rates of packets, it actually plays the rate limit function. The Shaper provides level-2 rate limit for priority queues and all packets sent to the CPU (CPU interface). The Shaper and Meter functions provide 3-level rate limit together and provide level-3 protection for the CPU.

Figure 9-3 3-Level Rate Limit of the CPP

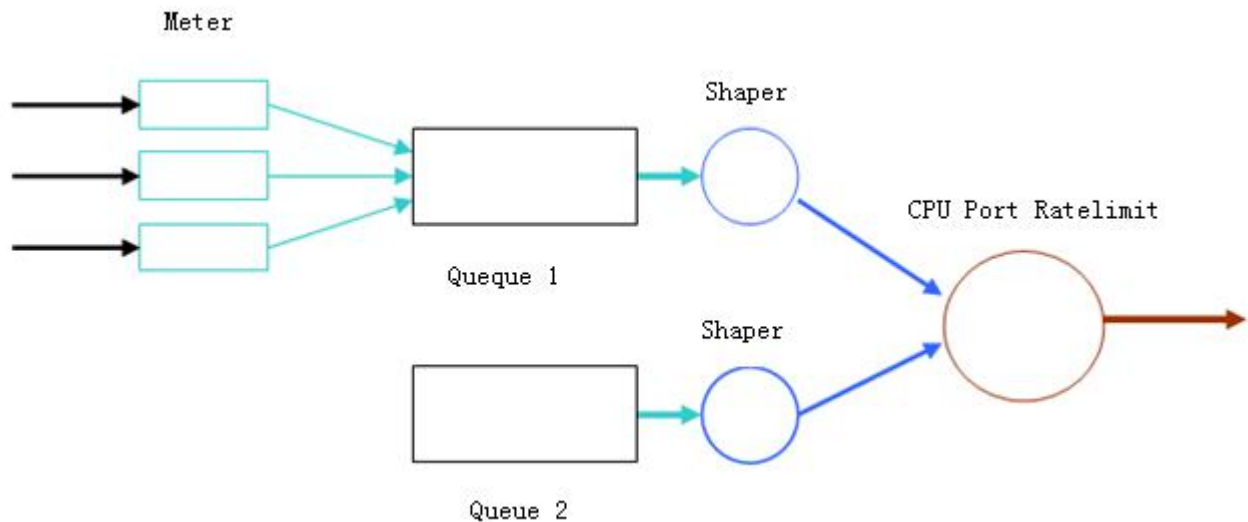

Related Configuration

▾ Configuring the Shaper for priority queues

- By default, each priority queue determines a shaping threshold (bandwidth).
- In application, you can run the **cpu-protect traffic-class** *traffic-class-num* **bandwidth** *bandwidth_value* command to perform Shaper configuration for a specific priority queue.

▾ Configuring the Shaper for the CPU Interface

- By default, the CPU interface determines a shaping threshold (bandwidth).
- Run the **cpu-protect cpu bandwidth** *bandwidth_value* command to perform Shaper configuration for the CPU interface.

9.4 Configuration

Configuration	Description and Command	
Configuring CPP	 (Optional and configured by default) It is used to adjust the configuration parameters of CPP.	
	cpu-protect type <i>packet-type</i> bandwidth	Configures the Meter for a packet type.
	cpu-protect type <i>packet-type</i> traffic-class	Configures the priority queue for a packet type.
	cpu-protect traffic-class <i>traffic-class-num</i> bandwidth	Configures the Shaper for a priority queue.
	cpu-protect cpu bandwidth	Configures the Shaper for the CPU interface.

9.4.1 Configuring CPP

Configuration Effect

- By configuring the Meter function, you can set the bandwidth and rate limit for a packet type. Packets out of the limit will be directly discarded.
- By configuring the Queue function, you can select a priority queue for a packet type. Packets in a queue with a higher priority will be scheduled first.
- By configuring the Shaper function, you can set the bandwidth and rate limit for a CPU interface and a priority queue. Packets out of the limit will be directly discarded.

Notes

- Pay special attention when the bandwidth of a packet type is set to a smaller value, which may affect the normal traffic of the same type. To provide per-user CPP, combine the NFPP function.
- When the Meter and Shaper functions are combined, 3-level protection will be provided. Any level protection fights alone may bring negative effects. For example, if you want to increase the Meter of a packet type, you also need to adjust the Shaper of the corresponding priority queue. Otherwise, the packets of this type may affect other types of packets in the same priority queue.

Configuration Steps

▾ Configuring the Meter for a packet type

- You can use or modify the default value but cannot disable it.
- You need to modify the configuration in the following cases: when packets of a type are not attackers but are discarded, you need to increase the Meter of this packet type. If attacks of a packet type cause abnormal CPU running, you need to decrease the Meter of this packet type.
- This configuration is available on all switches in a network environment.

▾ Configuring the priority queue for a packet type

- You can use or modify the default value but cannot disable it.
- You need to modify the configuration in the following cases: When attacks of a packet type cause abnormality of other packets in the same queue, you can put the packet type in an unused queue. If a packet type cannot be discarded but the packet type is in the same queue with other packet types in use, you can put this packet type in a queue with a higher priority.
- This configuration is available on all switches in a network environment.

✚ Configuring the Shaper for a priority queue

- You can use or modify the default value and cannot disable it.
- You need to modify the configuration in the following cases: If the Meter value of a packet type is greater which causes that other packets in the corresponding priority queue do not have sufficient bandwidth, you need to increase the Shaper for this priority queue. If attack packets are put in a priority queue and no other packets are in use, you need to increase the Shaper of this priority queue.
- This configuration is available on all switches in a network environment.

✚ Configuring the Shaper for the CPU interface

- You can use or modify the default value and cannot disable it.
- You are not advised to change the Shaper of the CPU interface.
- This configuration is available on all switches in a network environment.

Verification

- Modify the configurations when the system runs abnormally, and view the system running after the modification to check whether the configurations take effect.
- Check whether the configurations take effect by viewing corresponding configurations and statistic values. For details, see the following commands.

Related Commands

✚ Configuring the Meter for a packet type

Command	cpu-protect type <i>packet-type</i> bandwidth <i>bandwidth_value</i>
Parameter	<i>packet-type</i> : Specifies a packet type. Packet types are defined.
Description	<i>bandwidth_value</i> : Sets the bandwidth, in the unit of packets per second (pps).
Command Mode	Global configuration mode
Usage Guide	N/A

✚ Configuring the priority queue for a packet type

Command	cpu-protect type <i>packet-type</i> traffic-class <i>traffic-class-num</i>
Parameter	<i>packet-type</i> : Specifies a packet type. Packet types are defined.
Description	<i>traffic-class-num</i> : Specifies a priority queue.
Command Mode	Global configuration mode
Usage Guide	N/A

✚ Configuring the Shaper for a priority queue

Command	cpu-protect traffic-class <i>traffic-class-num</i> bandwidth <i>bandwidth_value</i>
Parameter	<i>traffic-class-num</i> : Specifies a priority queue.
Description	<i>bandwidth_value</i> : Sets the bandwidth, in the unit of pps.
Command	Global configuration mode

Mode	
Usage Guide	N/A

▾ **Configuring the Shaper for a CPU interface**

Command	cpu-protect cpu bandwidth <i>bandwidth_value</i>
Parameter Description	<i>bandwidth_value</i> : Sets the bandwidth, in the unit of pps.
Command Mode	Global configuration mode
Usage Guide	N/A

Configuration Example

▾ **Preventing packet attacks and network flapping by using CPP**

Scenario	<ul style="list-style-type: none"> ● ARP, IP, OSPF, dot1x, VRRP, Telnet and ICMP streams are available in the system. In the current configurations, ARP and 802.1X are in priority queue 2; IP, ICMP and Telnet streams are in priority queue 4; OSPF streams are in priority queue 3; VRRP streams are in priority queue 6. The Meter for each packet type is 10,000 pps; the shaper for each priority queue is 20,000 pps; the Shaper for the CPU interface is 100,000 pps. ● ARP attacks and IP scanning attacks exist in the system, which causes abnormal running of the system, authentication failure, Ping failure, management failure, and OSPF flapping.
Configuration Steps	<ul style="list-style-type: none"> ● Put ARP attack packets in priority queue 1 and limit the bandwidth for ARP packets or the corresponding priority queue. ● Put OSPF packets in priority queue 5. ● Put IP Ping failure attack packets in priority queue 3 and limit the bandwidth for IP packets or the corresponding priority queue.
	<pre> FS# configure terminal FS(config)# cpu-protect type arp traffic-class 1 FS(config)# cpu-protect type arp bandwidth 5000 FS(config)# cpu-protect type ospf traffic-class 5 FS(config)# cpu-protect type v4uc-route traffic-class 3 FS(config)# cpu-protect type traffic-class 3 bandwidth 5000 FS(config)# end </pre>
Verification	Run the show cpu-protect command to view the configuration and statistics.
	<pre> FS#show cpu-protect %cpu port bandwidth: 100000(pps) Traffic-class Bandwidth(pps) Rate(pps) Drop(pps) ----- 0 6000 0 0 1 6000 0 0 </pre>

	2	6000	0	0		
	3	6000	0	0		
	4	6000	0	0		
	5	6000	0	0		
	6	6000	0	0		
	7	6000	0	0		
Packet Type	Traffic-class	Bandwidth(pps)	Rate(pps)	Drop(pps)	Total	Total Drop
-----	-----	-----	-----	-----	-----	-----
bpdu	6	128	0	0	0	0
arp	1	3000	0	0	0	0
tpp	6	128	0	0	0	0
dot1x	2	1500	0	0	0	0
gvrp	5	128	0	0	0	0
rldp	5	128	0	0	0	0
lacp	5	256	0	0	0	0
rerp	5	128	0	0	0	0
reup	5	128	0	0	0	0
lldp	5	768	0	0	0	0
cdp	5	768	0	0	0	0
dhcps	2	1500	0	0	0	0
dhcps6	2	1500	0	0	0	0
dhcp6-client	2	1500	0	0	0	0
dhcp6-server	2	1500	0	0	0	0
dhcp-relay-c	2	1500	0	0	0	0
dhcp-relay-s	2	1500	0	0	0	0
option82	2	1500	0	0	0	0
tunnel-bpdu	2	128	0	0	0	0
tunnel-gvrp	2	128	0	0	0	0
unknown-v6mc	1	128	0	0	0	0
xgv6-ipmc	1	128	0	0	0	0
stargv6-ipmc	1	128	0	0	0	0
unknown-v4mc	1	128	0	0	0	0
xgv-ipmc	2	128	0	0	0	0
stargv-ipmc	2	128	0	0	0	0

udp-helper	1	128	0	0	0	0
dvmrp	4	128	0	0	0	0
igmp	2	1000	0	0	0	0
icmp	3	1600	0	0	0	0
ospf	4	2000	0	0	0	0
ospf3	4	2000	0	0	0	0
pim	4	1000	0	0	0	0
pimv6	4	1000	0	0	0	0
rip	4	128	0	0	0	0
ripng	4	128	0	0	0	0
vrrp	6	256	0	0	0	0
vrrpv6	6	256	0	0	0	0
ttl0	0	128	0	0	0	0
ttl1	0	2000	0	0	0	0
hop-limit	0	800	0	0	0	0
local-ipv4	3	4000	0	0	0	0
local-ipv6	3	4000	0	0	0	0
v4uc-route	1	800	0	0	0	0
v6uc-route	1	800	0	0	0	0
rt-host	4	3000	0	0	0	0
mld	2	1000	0	0	0	0
nd-snp-ns-na	1	3000	0	0	0	0
nd-snp-rs	1	1000	0	0	0	0
nd-snp-ra-redirect	1	1000	0	0	0	0
erps	5	128	0	0	0	0
mpls-ttl0	4	128	0	0	0	0
mpls-ttl1	4	128	0	0	0	0
mpls-ctrl	4	128	0	0	0	0
isis	4	2000	0	0	0	0
bgp	4	2000	0	0	0	0
cfm	5	512	0	0	0	0
web-auth	2	2000	0	0	0	0
fcoe-fip	4	1000	0	0	0	0
fcoe-local	4	1000	0	0	0	0

bfd	6	5120	0	0	0	0
micro-bfd	6	5120	0	0	0	0
micro-bfd-v6	6	5120	0	0	0	0
dldp	6	3200	0	0	0	0
other	0	4096	0	0	0	0
trill	4	1000	0	0	0	0
efm	5	1000	0	0	0	0
ipv6-all	0	2000	0	0	0	0
ip-option	0	800	0	0	0	0
mgmt	-	4000	4	0	4639	0
dns	2	200	0	0	0	0
sdn	0	5000	0	0	0	0
sdn_of_fetch	0	5000	0	0	0	0
sdn_of_copy	0	5000	0	0	0	0
sdn_of_trap	0	5000	0	0	0	0
vxlان-non-uc	1	512	0	0	0	0
local-telnet	3	1000	0	0	0	0
local-snmp	3	1000	0	0	0	0
local-ssh	3	1000	0	0	0	0

9.4.2 Configuring CPP Warning

Configuration Effect

- By configuring CPP warning, periodic detection is enabled to check whether protocol packets or packets in queues are lost.
- By configuring CPP warning of protocol packet loss, when protocol packets are lost, alarm logs are printed.
- By configuring CPP warning of packet loss in a queue, when packets in a queue are lost, alarm logs are printed.

Notes

N/A

Configuration Steps

▾ Enabling CPP Warning and Configuring Time Interval Between Two Detections of Packet Loss

- You can run the **cpp-warn warn-period value** command to enable CPP warning and configure time interval between two detections of packet loss.
- By default, CPP warning is disabled.

▾ Enabling CPP Warning of Protocol Packet Loss

- You can run the **cpp-warn type packet-type warn** command to enable CPP warning of protocol packet loss.
- By default, CPP warning of protocol packet loss is disabled.

➤ **Enabling CPP Warning of Packet Loss in a Queue**

- You can run the **cpp-warn traffic-class *traffic-class-num* warn** command to enable CPP warning of packet loss in a queue.
- By default, CPP warning of packet loss in a queue is disabled.

Related Commands

➤ **Configuring Time Interval Between Two Detections of Packet Loss**

Command	cpp-warn warn-period <i>value</i>
Parameter Description	<i>value</i> : Specifies the interval between two detections of packet loss in the unit of second. The default value is 0, which means this detection is disabled.
Command Mode	Global configuration mode
Usage Guide	N/A

➤ **Enabling CPP Warning of Protocol Packet Loss**

Command	cpp-warn type <i>packet-type</i> warn
Parameter Description	<i>packet-type</i> : Specifies a packet type. Packet types are defined.
Command Mode	Global configuration mode
Usage Guide	N/A

➤ **Enabling CPP Warning of Packet Loss in a Queue**

Command	cpp-warn traffic-class <i>traffic-class-num</i> warn
Parameter Description	<i>traffic-class-num</i> : Specifies a priority queue.
Command Mode	Global configuration mode
Usage Guide	N/A

Configuration Example

➤ **Configuring CPP Warning**

Configuration Steps	<ul style="list-style-type: none"> ● Detect whether protocol packets or packets in queues are lost every 10s. ● Print alarm logs if ARP packets are lost. ● Print alarm logs if packets in queue 1 are lost.
	<pre>FS# configure terminal FS(config)# cpp-warn warn-period 10 FS(config)# cpp-warn traffic-class 1 warn FS(config)# cpp-warn type arp warn</pre>
Verification	Run the show run command to view the configuration.
	<pre>FS# show run inc cpp cpp-warn warn-period 10 cpp-warn type arp warn</pre>

cpp-warn traffic-class 1 warn

9.5 Monitoring



Clearing

Description	Command
Clears the CPP statistics.	clear cpu-protect counters [device <i>device_num</i>]
Clears the CPP statistics on the master device.	clear cpu-protect counters mboard

Displaying

Description	Command
Displays the configuration and statistics of a packet type.	show cpu-protect type <i>packet-type</i> [device <i>device_num</i>]
Displays the configuration and statistics of a priority queue.	show cpu-protect traffic-class <i>traffic-class-num</i> [device <i>device_num</i>]
Displays the configuration on a CPU interface.	show cpu-protect cpu
Displays all configurations and statistics on the master device.	show cpu-protect { mboard summary }
Displays all configurations and statistics of CPP.	show cpu-protect [device <i>device_num</i>]
Displays CPP statistics of an interface.	show cpu-protect statistics [interface <i>interface-id</i>]
Displays a CPP statistics type.	show cpu-protect statistics type <i>packet-type</i>

Debugging

-  The preceding monitoring commands are available on both chassis and cassette devices in the standalone mode.
-  If the **device** value is not specified, the **clear** command is used to clear the statistics of all nodes in the system and the **show** command is used to display the configurations on the master device.
-  In the standalone mode, the parameter **device** is unavailable.

10 Configuring DHCP Snooping

10.1 Overview

DHCP Snooping: DHCP Snooping snoops DHCP interactive packets between clients and servers to record and monitor users' IP addresses and filter out illegal DHCP packets, including client request packets and server response packets. The legal user database generated from DHCP Snooping records may serve security applications like IP Source Guard.

Protocols and Standards

- RFC 2131: Dynamic Host Configuration Protocol
- RFC 2132: DHCP Options and BOOTP Vendor Extensions

10.2 Applications

Application	Description
Guarding against DHCP service spoofing	In a network with multiple DHCP servers, DHCP clients are allowed to obtain network configurations only from legal DHCP servers.
Guarding against DHCP packet flooding	Malicious network users may frequently send DHCP request packets.
Guarding against forged DHCP packets	Malicious network users may send forged DHCP request packets, for example, DHCP-RELEASE packets.
Guarding against IP/MAC spoofing	Malicious network users may send forged IP packets, for example, tampered source address fields of packets.
Preventing Lease of IP Addresses	Network users may lease IP addresses rather than obtaining them from a DHCP server.
Detecting ARP attack	Malicious users forge ARP response packets to intercept packets during normal users' communication.

10.2.1 Guarding Against DHCP Service Spoofing

Scenario

Multiple DHCP servers may exist in a network. It is essential to ensure that user PCs obtain network configurations only from the DHCP servers within a controlled area.

Take the following figure as an example. The DHCP client can only communicate with trusted DHCP servers.

- Request packets from the DHCP client can be transmitted only to trusted DHCP servers.
- Only the response packets from trusted DHCP servers can be transmitted to the client.

Figure 10- 1

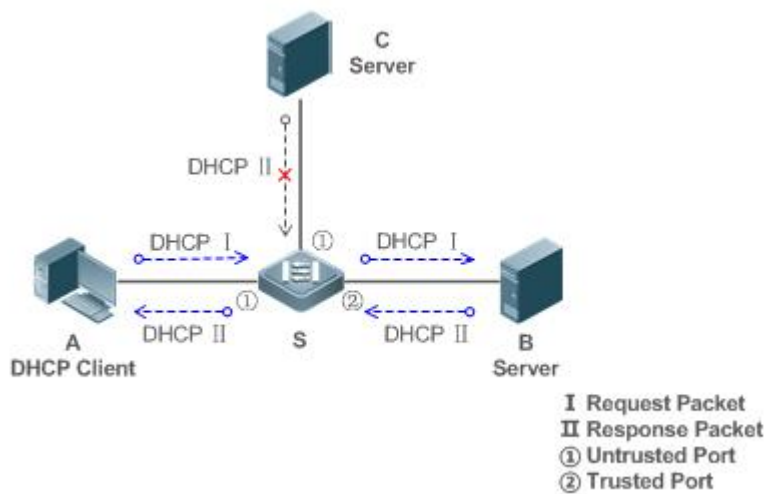

Remarks:	S is an access device. A is a user PC. B is a DHCP server within the controlled area. C is a DHCP server out of the controlled area.
-----------------	---

Deployment

- Enable DHCP Snooping on S to realize DHCP packet monitoring.
- Set the port on S connecting to B as trusted to transfer response packets.
- Set the rest of ports on S as untrusted to filter response packets.

10.2.2 Guarding Against DHCP Packet Flooding

Scenario

Potential malicious DHCP clients in a network may send high-rate DHCP packets. As a result, legitimate users cannot obtain IP addresses, and access devices are highly loaded or even break down. It is necessary to take actions to ensure network stability.

With the DHCP Snooping rate limit function for DHCP packets, a DHCP client can only send DHCP request packets at a rate below the limit.

- The request packets from a DHCP client are sent at a rate below the limit.
- Packets sent at rates beyond the limit will be discarded.

Deployment

- Enable DHCP Snooping on S to realize DHCP monitoring.
- Limit the rates of DHCP packets from the untrusted ports.

10.2.3 Guarding Against Forged DHCP Packets

Scenario

Potential malicious clients in a network may forge DHCP request packets, consuming applicable IP addresses from the servers and probably preempting legal users' IP addresses. Therefore, it is necessary to filter out illegal DHCP packets.

For example, as shown in the figure below, the DHCP request packets sent from DHCP clients will be checked.

- The source MAC address fields of the request packets from DHCP clients must match the **chaddr** fields of DHCP packets.
- The Release packets and Decline packets from clients must match the entries in the DHCP Snooping binding database.

Figure 10- 2

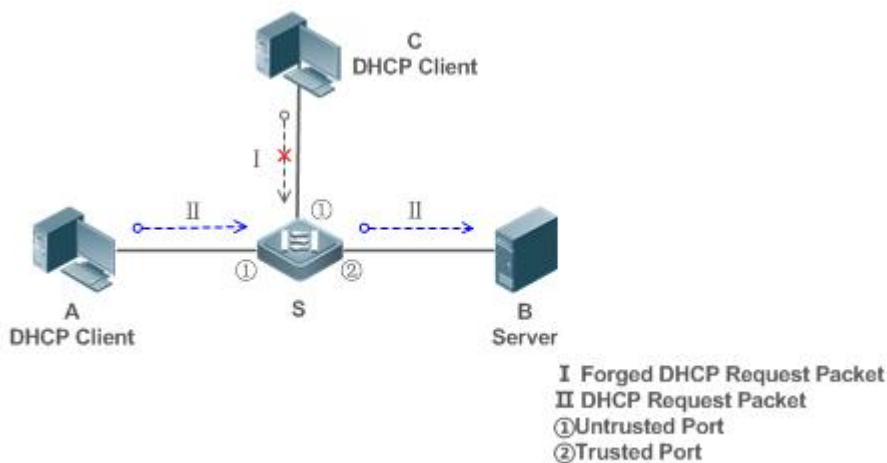

Remarks:	<p>S is an access device.</p> <p>A and C are user PCs.</p> <p>B is a DHCP server within the controlled area.</p>
-----------------	--

Deployment

- Enable DHCP Snooping on S to realize DHCP monitoring.
- Set the port on S connecting to B as trusted to transfer response packets.
- Set the rest of ports on S as untrusted to filter response packets.
- Enable DHCP Snooping Source MAC Verification on untrusted ports of S to filter out illegal packets.

10.2.4 Guarding Against IP/MAC Spoofing

Scenario

Check IP packets from untrusted ports to filter out forged IP packets based on IP or IP-MAC fields.

For example, in the following figure, the IP packets sent by DHCP clients are validated.

- The source IP address fields of IP packets must match the IP addresses assigned by DHCP.
- The source MAC address fields of layer-2 packets must match the **chaddr** fields in DHCP request packets from clients.

Figure 10-3

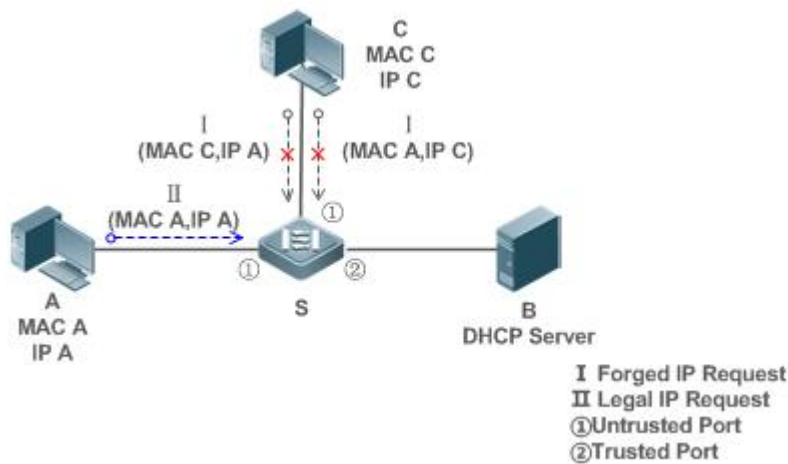

Remarks:	<p>S is an access device.</p> <p>A and C are user PCs.</p> <p>B is a DHCP server within the controlled area.</p>
-----------------	--

Deployment

- Enable DHCP Snooping on S to realize DHCP monitoring.
- Set all downlink ports on the S as DHCP Snooping untrusted.
- Enable IP Source Guard on S to filter IP packets.
- Enable IP Source Guard in IP-MAC based mode to check the source MAC and IP address fields of IP packets.

10.2.5 Preventing Lease of IP Addresses

Scenario

Validate the source addresses of IP packets from untrusted ports compared with DHCP-assigned addresses.

If the source addresses, connected ports, and layer-2 source MAC addresses of ports in IP packets do not match the assignments of the DHCP server, such packets will be discarded.

The networking topology scenario is the same as that shown in the previous figure.

Deployment

- The same as that in the section "Guarding Against IP/MAC Spoofing".

10.2.6 Detecting ARP Attacks

Scenario

Check the ARP packets from untrusted ports and filter out the ARP packets unmatched with the assignments of the DHCP server.

For example, in the following figure, the ARP packets sent from DHCP clients will be checked.

- The ports receiving ARP packets, the layer-2 MAC addresses, and the source MAC addresses of ARP packets senders shall be consistent with the DHCP Snooping histories.

Figure 10-4

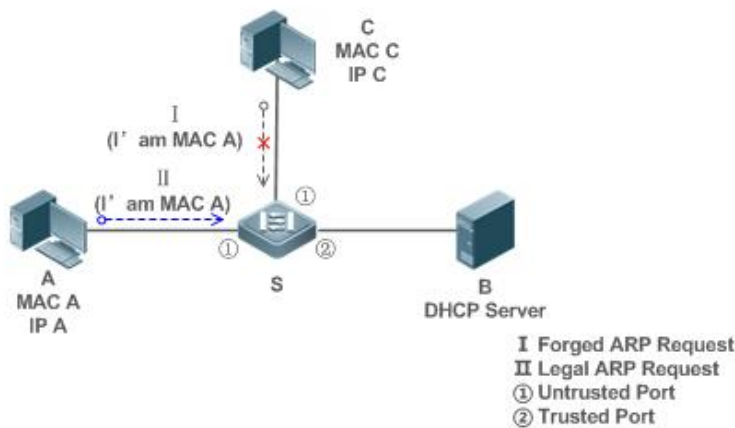

Remarks:	<p>S is an access device.</p> <p>A and C are user PCs.</p> <p>B is a DHCP server within the controlled area.</p>
-----------------	--

Deployment

- Enable DHCP Snooping on S to realize DHCP monitoring.
- Set all downlink ports on the S as untrusted.
- Enable IP Source Guard and ARP Check on all the untrusted ports on S to realize ARP packet filtering.

All the above security control functions are only effective to DHCP Snooping untrusted ports.

10.3 Features

Basic Concepts

↘ DHCP Request Packets

Request packets are sent from a DHCP client to a DHCP server, including DHCP-DISCOVER packets, DHCP-REQUEST packets, DHCP-DECLINE packets, DHCP-RELEASE packets and DHCP-INFORM packets.

↘ DHCP Response Packets

Response packets are sent from a DHCP server to a DHCP client, including DHCP-OFFER packets, DHCP-ACK packets and DHCP-NAK packets.

↘ DHCP Snooping Trusted Ports

IP address request interaction is complete via broadcast. Therefore, illegal DHCP services will influence normal clients' acquisition of IP addresses and lead to service spoofing and stealing. To prevent illegal DHCP services, DHCP Snooping ports are divided into two types: trusted ports and untrusted ports. The access devices only transmit DHCP response packets received on trusted ports, while such packets from untrusted ports are discarded. In this way, we may configure the ports connected to a legal DHCP Server as trusted and the other ports as untrusted to shield illegal DHCP Servers.

On switches, all switching ports or layer-2 aggregate ports are defaulted as untrusted, while trusted ports can be specified.

↘ DHCP Snooping Packet Suppression

To shield all the DHCP packets on a specific client, we can enable DHCP Snooping packet suppression on its untrusted ports.

↘ VLAN-based DHCP Snooping

DHCP Snooping can work on a VLAN basis. By default, when DHCP Snooping is enabled, it is effective to all the VLANs of the current client. Specify VLANs help control the effective range of DHCP Snooping flexibly.

↘ DHCP Snooping Binding Database

In a DHCP network, clients may set static IP addresses randomly. This increases not only the difficulty of network maintenance but also the possibility that legal clients with IP addresses assigned by the DHCP server may fail to use the network normally due to address conflict. Through snooping packets between clients and servers, DHCP Snooping summarizes the user entries including IP addresses, MAC address, VLAN ID (VID), ports and lease time to build the DHCP Snooping binding database. Combined with ARP detection and ARP check, DHCP Snooping controls the reliable assignment of IP addresses for legal clients.

↘ DHCP Snooping Rate Limit

DHCP Snooping rate limit function can be configured through the rate limit command of Network Foundation Protection Policy (NFPP). For NFPP configuration, see the *Configuring NFPP*.

↘ DHCP Option82

DHCP Option82, an option for DHCP packets, is also called DHCP Relay Agent Information Option. As the option number is 82, it is known as Option82. Option82 is developed to enhance the security of DHCP servers and improve the strategies of IP address assignment. The option is often configured for the DHCP relay services of a network access device like DHCP Relay and DHCP Snooping. This option is transparent to DHCP clients, and DHCP relay components realize the addition and deduction of the option.

➤ **Illegal DHCP Packets**

Through DHCP Snooping, validation is performed on the DHCP packets passing through a client. Illegal DHCP packets are discarded, user information is recorded into the DHCP Snooping binding database for further applications (for example, ARP detection). The following types of packets are considered illegal DHCP packets.

- The DHCP response packets received on untrusted ports, including DHCP-ACK, DHCP-NACK and DHCP-OFFER packets
- The DHCP request packets carrying gateway information **giaddr**, which are received on untrusted ports
- When MAC verification is enabled, packets with source MAC addresses different with the value of the **chaddr** field in DHCP packets
- DHCP-RELEASE packets with the entry in the DHCP Snooping binding database Snooping while with untrusted ports inconsistent with settings in this binding database
- DHCP packets in wrong formats, or incomplete

Overview

Feature	Description
Filtering DHCP packets	Perform legality check on DHCP packets and discard illegal packets (see the previous section for the introduction of illegal packets). Transfer requests packets received on trusted ports only.
Building the DHCP Snooping binding database	Snoop the interaction between DHCP clients and the server, and generate the DHCP Snooping binding database to provide basis for other filtering modules.

10.3.1 Filtering DHCP Packets

Perform validation on DHCP packets from untrusted ports. Filter out the illegal packets as introduced in the previous section "Basic Concepts".

Working Principle

During snooping, check the receiving ports and the packet fields of packets to realize packet filtering, and modify the destination ports of packets to realize control of transmit range of the packets.

➤ **Checking Ports**

In receipt of DHCP packets, a client first judges whether the packet receiving ports are DHCP Snooping trusted ports. If yes, legality check and binding entry addition are skipped, and packets are transferred directly. For not, both the check and addition are needed.

➤ **Checking Packet Encapsulation and Length**

A client checks whether packets are UDP packets and whether the destination port is 67 or 68. Check whether the packet length match the length field defined in protocols.

➤ **Checking Packet Fields and Types**

According to the types of illegal packet introduced in the section "Basic Concepts", check the fields **giaddr** and **chaddr** in packets and then check whether the restrictive conditions for the type of the packet are met.

Related Configuration

➤ **Enabling Global DHCP Snooping**

By default, DHCP Snooping is disabled.

It can be enabled on a device using the **ip dhcp snooping** command.

Global DHCP Snooping must be enabled before VLAN-based DHCP Snooping is applied.

↘ **Configuring VLAN-based DHCP Snooping**

By default, when global DHCP Snooping is effective, DHCP Snooping is effective to all VLANs.

Use the [**no**] **ip dhcp snooping vlan** command to enable DHCP Snooping on specified VLANs or delete VLANs from the specified VLANs. The value range of the command parameter is the actual range of VLAN numbers.

↘ **Configuring DHCP Snooping Source MAC Verification**

By default, the layer-2 MAC addresses of packets and the **chaddr** fields of DHCP packets are not verified.

When the **ip dhcp snooping verify mac-address** command is used, the source MAC addresses and the **chaddr** fields of the DHCP request packets sent from untrusted ports are verified. The DHCP request packets with different MAC addresses will be discarded.

10.3.2 Building the Binding Database

DHCP Snooping detects the interactive packets between DHCP clients and the DHCP server, and generate entries of the DHCP Snooping binding database according to the information of legal DHCP packets. All these legal entries are provided to other security modules of a client as the basis of filtering packets from network.

Working Principle

During snooping, the binding database is updated timely based on the types of DHCP packets.

↘ **Generating Binding Entries**

When a DHCP-ACK packet on a trusted port is snooped, the client's IP address, MAC address, and lease time field are extracted together with the port ID (a wired interface index) and VLAN ID. Then, a binding entry of it is generated.

↘ **Deleting Binding Entries**

When the recorded lease time of a binding entry is due, it will be deleted if a legal DHCP-RELEASE/DHCP-DECLINE packet sent by the client or a DHCP-NCK packet received on a trusted port is snooped, or the **clear** command is used.

Related Configuration

No configuration is needed except enabling DHCP Snooping.

10.4 Configuration

Configuration	Description and Command
Configuring basic functions of DHCP Snooping	 (Mandatory) It is used to enable DHCP Snooping.
	ip dhcp snooping Enables DHCP Snooping.
	ip dhcp snooping suppression Enables DHCP Snooping packet suppression.
	ip dhcp snooping vlan Enables VLAN-based DHCP Snooping.
	ip dhcp snooping verify mac-address Configures DHCP Snooping source MAC verification.

	ip dhcp snooping database write-delay	Writes the DHCP Snooping binding database to Flash periodically.
	ip dhcp snooping database write-to-flash	Writes the DHCP Snooping binding database to Flash manually.
	renew ip dhcp snooping database	Imports the backup file storage to the DHCP Snooping Binding database.
	ip dhcp snooping trust	Configures DHCP Snooping trusted ports.
	ip dhcp snooping bootp	Enables BOOTP support.
	ip dhcp snooping check-giaddr	Enables DHCP Snooping to support the function of processing Relay requests.
Configuring Option82	(Optional)It is used to optimize the address assignment by DHCP servers.	
	ip dhcp snooping information option	Adds Option82 functions to DHCP request packets.
	ip dhcp snooping information option format remote-id	Configures the sub-potion remote-id of Option82 as a user-defined character string.
	ip dhcp snooping vlan information option format-type circuit-id string	Configures the sub-option circuit-id of Option82 as a user-defined character string.

10.4.1 Configuring Basic Features

Configuration Effect

- Enable DHCP Snooping.
- Generate the DHCP Snooping binding database.
- Control the transmit range of DHCP packets.
- Filter out illegal DHCP packets.

Notes

- The ports on clients connecting a trusted DHCP server must be configured as trusted.
- DHCP Snooping is effective on the wired switching ports, layer-2 aggregate ports, and layer-2 encapsulation sub-interfaces. The configuration can be implemented in interface configuration mode.
- DHCP Snooping and DHCP Relay are mutually exclusive in VRF scenarios.

Configuration Steps

▾ Enabling Global DHCP Snooping

- Mandatory.
- Unless otherwise noted, the feature should be configured on access devices.

▾ Enabling or Disabling VLAN-based DHCP Snooping

- DHCP Snooping can be disabled if not necessary for some VLANs.
- Unless otherwise noted, the feature should be configured on access devices.

➤ **Configuring DHCP Snooping Trusted Ports**

- Mandatory.
- Configure the ports connecting a trusted DHCP server as trusted.

➤ **Enabling DHCP Snooping Source MAC Validation**

- This configuration is required if the **chaddr** fields of DHCP request packets match the layer-2 source MAC addresses of data packets.
- Unless otherwise noted, the feature should be enabled on all the untrusted ports of access devices.

➤ **Writing the DHCP Snooping Binding Database to Flash Periodically**

- Enable this feature to timely save the DHCP Snooping binding database information in case that client reboot.
- Unless otherwise noted, the feature should be configured on access devices.

➤ **Enabling BOOTP Support**

- Optional
- Unless otherwise noted, the feature should be configured on access devices.

➤ **Enabling DHCP Snooping to Process Relay Requests**

- Optional.
- Unless otherwise noted, the feature should be enabled on access devices.
-

Verification

Configure a client to obtain network configurations through the DHCP protocol.

- Check whether the DHCP Snooping Binding database is generated with entries on the client.

Related Commands

➤ **Enabling or Disabling DHCP Snooping**

Command	[no] ip dhcp snooping
Parameter	N/A
Description	
Command Mode	Global configuration mode
Usage Guide	After global DHCP Snooping is enabled, you can check DHCP Snooping using the show ip dhcp snooping command.

➤ **Configuring VLAN-based DHCP Snooping**

Command	[no] ip dhcp snooping vlan { vlan-rng {vlan-min [vlan-max] }
Parameter	<i>vlan-rng</i> : Indicates the range of VLANs
Description	<i>vlan-min</i> : The minimum VLAN ID <i>vlan-max</i> : The maximum VLAN ID

Command Mode	Global configuration mode
Usage Guide	Use this command to enable or disable DHCP Snooping on specified VLANs. This feature is available only after global DHCP Snooping is enabled.

✚ Configuring DHCP Snooping Packet Suppression

Command	[no] ip dhcp snooping suppression
Parameter Description	N/A
Command Mode	Interface configuration mode
Usage Guide	Use this command to reject all DHCP request packets at the port, that is, to forbid all users under the port to apply for addresses via DHCP.

✚ Configuring DHCP Snooping Source MAC Verification

Command	[no] ip dhcp snooping verify mac-address
Parameter Description	N/A
Command Mode	Global configuration mode
Usage Guide	Through the source MAC address verification, the MAC addresses in link headers and the CLIENT MAC fields in the request packets sent by a DHCP CLIENT are checked for consistence. When the source MAC address verification fails, packets will be discarded.

✚ Writing DHCP Snooping Database to Flash Periodically

Command	[no] ip dhcp snooping database write-delay [time]
Parameter Description	<i>time</i> : Indicates the interval between two times of writing the DHCP Snooping database to the Flash.
Command Mode	Global configuration mode
Usage Guide	Use this command to write the DHCP Snooping database to FLASH document. This can avoid binding information loss which requires re-obtaining IP addresses to resume communication after the device restarts.

✚ Writing the DHCP Snooping Database to Flash Manually

Command	ip dhcp snooping database write-to-flash
Parameter Description	N/A
Command Mode	Global configuration mode
Usage Guide	Use this command to write the dynamic user information in the DHCP Snooping database in FLASH documents in real time. If a device is upgraded from a non-QinQ version to a QinQ version (or vice versa), binding entries cannot be restored from FLASH documents because of version differences between FLASH documents.

↘ Importing Flash Storage to the DHCP Snooping Binding Database

Command	renew ip dhcp snooping database
Parameter	N/A
Description	
Command Mode	Privileged configuration mode
Usage Guide	Use this command to import the information from backup file documents to the DHCP Snooping binding database.

↘ Configuring DHCP Snooping Trusted Ports

Command	[no] ip dhcp snooping trust
Parameter	N/A
Description	
Command Mode	Interface configuration mode
Usage Guide	Use this command to configure a port connected to a legal DHCP server as a trusted port. The DHCP response packets received by trusted ports are transferred, while those received by untrusted ports are discarded.

↘ Enabling or Disabling BOOTP Support

Command	[no] ip dhcp snooping bootp
Parameter	N/A
Description	
Command Mode	Global configuration mode
Usage Guide	Use this command to support the BOOTP protocol.

↘ Enabling DHCP Snooping to Process Relay Requests

Command	[no] ip dhcp snooping check-giaddr
Parameter	N/A
Description	
Command Mode	Global configuration mode
Usage Guide	<p>After the feature is enabled, services using DHCP Snooping binding entries generated based on Relay requests, such as IP Source Guard/802.1x authentication, cannot be deployed. Otherwise, users fail to access the Internet.</p> <p>After the feature is enabled, the ip dhcp snooping verify mac-address command cannot be used. Otherwise, DHCP Relay requests will be discarded and as a result, users fail to obtain addresses.</p>

Configuration Example

↘ DHCP Client Obtaining IP addresses Dynamically from a Legal DHCP Server

<p>Scenario</p> <p>Figure 10-5</p>	
<p>Configuration Steps</p>	<ul style="list-style-type: none"> ● Enable DHCP Snooping on an access device (Switch B in this case). ● Configure the uplink port (port Gi 0/1 in this case) as a trusted port.
<p>B</p>	<pre> B#configure terminal Enter configuration commands, one per line. End with CNTL/Z. B(config)#ip dhcp snooping B(config)#interface gigabitEthernet 0/1 B(config-if-GigabitEthernet 0/1)#ip dhcp snooping trust B(config-if-GigabitEthernet 0/1)#end </pre>
<p>Verification</p>	<p>Check the configuration on Switch B.</p> <ul style="list-style-type: none"> ● Check whether DHCP Snooping is enabled, and whether the configured DHCP Snooping trusted port is uplink. ● Check the DHCP Snooping configuration on Switch B, and especially whether the trusted port is correct.
<p>B</p>	<pre> B#show running-config ! ip dhcp snooping ! interface GigabitEthernet 0/1 B#show ip dhcp snooping Switch DHCP Snooping status : ENABLE DHCP Snooping Verification of hwaddr status : DISABLE DHCP Snooping database write-delay time : 0 seconds DHCP Snooping option 82 status : DISABLE DHCP Snooping Support BOOTP bind status : DISABLE Interface Trusted Rate limit (pps) ----- </pre>

GigabitEthernet 0/1	YES	unlimited			
B#show ip dhcp snooping binding					
Total number of bindings: 1					
MacAddress	IpAddress	Lease(sec)	Type	VLAN	Interface

0013.2049.9014	172.16.1.2	86207	dhcp-snooping 1		GigabitEthernet 0/11

Common Errors

- The uplink port is not configured as a DHCP trusted port.
- Another access security option is already configured for the uplink port, so that a DHCP trusted port cannot be configured.

10.4.2Configuring Option82

Configuration Effect

- Enable a DHCP server to obtain more information and assign addresses better.
- The Option82 function is client-oblivious.

Notes

- The Option82 functions for DHCP Snooping and DHCP Relay are mutually exclusive.

Configuration Steps

- To realize optimization of address allocation, implement the configuration.
- Unless otherwise noted, enable this function on access devices with DHCP Snooping enabled.

Verification

Check whether the DHCP Snooping configuration options are configured successfully.

Related Commands

➤ **Adding Option82 to DHCP Request Packets**

Command	[no] ip dhcp snooping information option [standard-format]
Parameter Description	standard-format : Indicates a standard format of the Option82 options
Command Mode	Global configuration mode
Usage Guide	Use this command to add Option82 to DHCP request packets so that a DHCP server assigns addresses according to such information.

➤ **Configuring Sub-option remote-id of Option82 as User-defined Character String**

Command	[no] ip dhcp snooping information option format remote-id { string ASCII-string hostname }
Parameter Description	string ASCII-string : Indicates the content of the extensible format, the Option82 option remote-id , is a user-defined character string

	hostname: Indicates the content of the extensible format, the Option82 option remote-id , is a host name.
Configuration mode	Global configuration mode
Usage Guide	Use this command to configure the sub-option remote-id of the Option82 as user-defined content, which is added to DHCP request packets. A DHCP server assigns addresses according to Option82 information.

➤ **Configuring Sub-Option circuit-id of Option82 as User-defined Character String**

Command	<code>[no] ip dhcp snooping vlan <i>vlan-id</i> information option format-type circuit-id string <i>ascii-string</i></code>
Parameter Description	<i>vlan-id</i> : Indicates the VLAN where a DHCP request packet is <i>ascii-string</i> : Indicates the user-defined string
Configuration mode	Interface configuration mode
Usage Guide	Use this command to configure the sub-option circuit-id of the Option82 as user-defined content, which is added to DHCP request packets. A DHCP server assigns addresses according to Option82 information.

Configuration Example

➤ **Configuring Option82 to DHCP Request Packets**

Configuration Steps	<ul style="list-style-type: none"> ● Configuring basic functions of DHCP Snooping. ● Configuring Option82.
B	<pre>FS# configure terminal FS(config)# ip dhcp snooping information option FS(config)# end</pre>
Verification	Check the DHCP Snooping configuration.
B	<pre>B#show ip dhcp snooping Switch DHCP Snooping status : ENABLE DHCP Snooping Verification of hwaddr status : DISABLE DHCP Snooping database write-delay time : 0 seconds DHCP Snooping option 82 status : ENABLE DHCP Snooping Support bootp bind status : DISABLE Interface Trusted Rate limit (pps) ----- GigabitEthernet 0/1 YES unlimited</pre>

Common Errors

- N/A

10.5 Monitoring

Clearing

 Running the clear commands may lose vital information and thus interrupt services.

Description	Command
Clears the DHCP Snooping binding database.	clear ip dhcp snooping binding [ip] [mac] [vlan vlan-id] [interface interface-id]

Displaying

Description	Command
Displays DHCP Snooping configuration.	show ip dhcp snooping
Displays the DHCP Snooping binding database.	show ip dhcp snooping binding

Debugging

 System resources are occupied when debugging information is output. Disable the debugging switch immediately after use.

Description	Command
Debugs DHCP Snooping events.	debug snooping ipv4 event
Disables debugging DHCP Snooping events.	no debug snooping ipv4 event
Debugs DHCP Snooping packets.	debug snooping ipv4 packet
Disables debugging DHCP Snooping packets.	no debug snooping ipv4 packet
Enables debugging MAC-based DHCP Snooping.	debug snooping ipv4 mac-address H.H.H
Disables debugging MAC-based DHCP Snooping.	no debug snooping ipv4 mac-address H.H.H
Enables debugging all DHCP Snooping	debug snooping ipv4 all
Disables debugging all DHCP Snooping	no debug snooping ipv4 all

11 Configuring NFPP

11.1 Overview

Network Foundation Protection Policy (NFPP) provides guards for switches.

Malicious attacks are always found in the network environment. These attacks bring heavy burdens to switches, resulting in high CPU usage and operational troubles. These attacks are as follows:

Denial of Service (DoS) attacks may consume lots of memory, entries, or other resources of a switch, which will cause system service termination.

Massive attack traffic is directed to the CPU, occupying the entire bandwidth of the CPU. In this case, normal protocol traffic and management traffic cannot be processed by the CPU, causing protocol flapping or management failure. The forwarding in the data plane will also be affected and the entire network will become abnormal.

A great number of attack packets directed to the CPU consume massive CPU resources, making the CPU highly loaded and thereby influencing device management and performance.

NFPP can effectively protect the system from these attacks. Facing attacks, NFPP maintains the proper running of various system services with a low CPU load, thereby ensuring the stability of the entire network.

11.2 Applications

Application	Description
Attack Rate Limiting	Due to various malicious attacks such as ARP attacks and IP scanning attacks in the network, the CPU cannot process normal protocol and management traffics, causing protocol flapping or management failure. The NFPP attack rate limiting function is used to limit the rate of attack traffic or isolate attack traffic to recover the network.
CentralizedBandwidth Allocation	If normal service traffics are too large, you need to classify and prioritize the traffics. When a large number of packets are directed to the CPU, the CPU will be highly loaded, thereby causing device management or device running failure. The centralized bandwidth distribution function is used to increase the priority of such traffics so that switches can run stably.

11.2.1 Attack Rate Limiting

Scenario

NFPP supports attack detection and rate limiting for various types of packets, including Address Resolution Protocol (ARP), Internet Control Message Protocol (ICMP), and Dynamic Host Configuration Protocol (DHCP) packets. It also allows users to define packet matching characteristics and corresponding attack detection and rate limiting policies. The attack rate limiting function takes effect based on types of packets. This section uses ARP packets as an example scenario to describe the application.

If an attacker floods ARP attack packets while CPU capability is insufficient, most of the CPU resources will be consumed for processing these ARP packets. If the rate of attacker's ARP packet rates exceeds the maximum ARP bandwidth specified in the CPU Protect Policy (CPP) of the switch, normal ARP packets may be dropped. As shown in Figure 11- 1, normal hosts will fail to access the network, and the switch will fail to send ARP replies to other devices.

Figure 11- 1

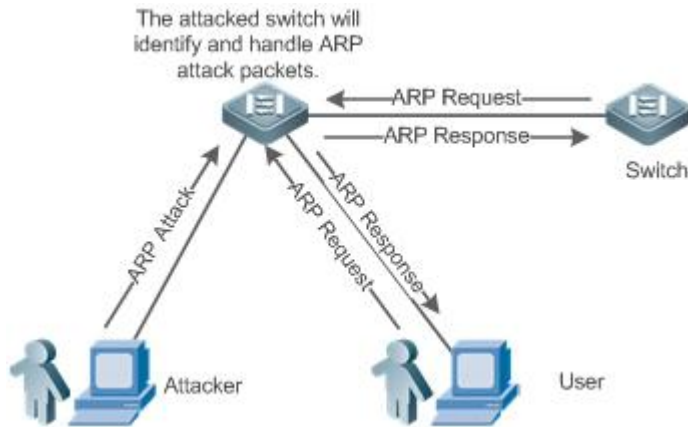

Deployment

- By default, the ARP attack detection and rate limiting function is enabled with corresponding policies configured. If the rate of an attacker's ARP packets exceeds the rate limit, the packets are discarded. If it exceeds the attack threshold, a monitoring user is generated and prompt information is exported.
- If the rate of an attacker's ARP packets exceeds the rate limit defined in CPP and affects normal ARP replies, you can enable attack isolation to discard ARP attack packets based on the hardware and recover the network.
- ℹ For details about CPP-related configurations, see the *Configuring CPU Protection*.
- ℹ To maximize the use of NFPP guard functions, modify the rate limits of various services in CPP based on the application environment or use the configurations recommended by the system. You can run the **show cpu-protect summary** command to display the configurations.

11.2.2 Centralized Bandwidth Allocation

Scenario

A switch classifies services defined in CPP into three types: Manage, Route, and Protocol. Each type of services has an independent bandwidth. Different types of services cannot share their bandwidths. Traffics with bandwidths exceeding the thresholds will be discarded. By such service classification, service packets are processed by orders of precedence.

As shown in Figure 11-2, the switch receives a large number of Telnet packets, OSPF packets, and ARP packets, causing CPU overload. In this case, the CPU cannot process all packets, and a large quantity of packets are backlogged in the queue, causing various problems such as frequent Telnet disconnection, OSPF protocol flapping, and ARP access failure on hosts.

Figure 11-2

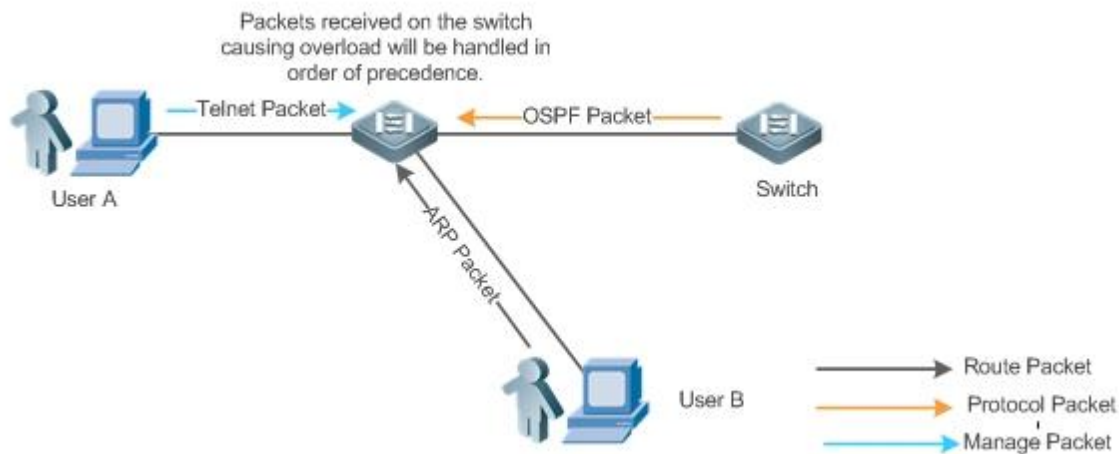

Deployment

- By default, CPU centralized bandwidth allocation is enabled to assign an independent bandwidth and bandwidth ratio to each type of services. At the time, the CPU first processes Telnet packets to ensure uninterrupted connection of Telnet service, and then processes OSPF packets to maintain OSPF protocol stability, and finally processes ARP packets.
- If the preceding problems still occur in default configurations, you can accordingly adjust the bandwidths and bandwidth ratios of various types of services.

11.3Features

Basic Concepts

➤ **ARP Guard**

In local area networks (LANs), IP addresses are mapped to MAC addresses through ARP, which has a significant role in safeguarding network security. ARP-based DoS attacks mean that a large number of unauthorized ARP packets are sent to the gateway through the network, causing the failure of the gateway to provide services for normal hosts. To prevent such attacks, limit the rate of ARP packets and identify and isolate the attack source.

➤ **IP Guard**

Many hacker attacks and network virus intrusions start from scanning active hosts in the network. Therefore, many scanning packets rapidly occupy the network bandwidth, causing network communication failure.

To solve this problem, FS Layer-3 switches provide IP guard function to prevent hacker scanning and Blaster Worm viruses and reduce the CPU load. Currently, there are mainly two types of IP attacks:

Scanning destination IP address changes: As the greatest threat to the network, this type of attacks not only consumes network bandwidth and increases device load but also is a prelude of most hacker attacks.

Sending IP packets to non-existing destination IP addresses at high rates: This type of attacks is mainly designed for consuming the CPU load. For a Layer-3 device, if the destination IP address exists, packets are directly forwarded by the switching chip without occupying CPU resources. If the destination IP address does not exist, IP packets are sent to the CPU, which then sends ARP requests to query the MAC address corresponding to the destination IP address. If too many packets are sent to the CPU, CPU resources will be consumed. This type of attack is less destructive than the former one.

To prevent the latter type of attack, limit the rate of IP packets and find and isolate the attack source.

➤ **ICMP Guard**

ICMP is a common approach to diagnose network failures. After receiving an ICMP echo request from a host, the router or switch returns an ICMP echo reply. The preceding process requires the CPU to process the packets, thereby definitely consuming part of CPU resources. If an attacker sends a large number of ICMP echo requests to the destination device, massive CPU resources on the device will be consumed heavily, and the device may even fail to work properly. This type of attacks is called ICMP flood. To prevent this type of attacks, limit the rate of ICMP packets and find and isolate the attack source.

➤ **DHCP Guard**

DHCP is widely used in LANs to dynamically assign IP addresses. It is significant to network security. Currently, the most common DHCP attack, also called DHCP exhaustion attack, uses faked MAC addresses to broadcast DHCP requests. Various attack tools on the Internet can easily complete this type of attack. A network attacker can send sufficient DHCP requests to use up the address space provided by the DHCP server within a period. In this case, authorized hosts will fail to request DHCP IP addresses and thereby fail to access the network. To prevent this type of attacks, limit the rate of DHCP packets and find and isolate the attack source.

➤ **DHCPv6 Guard**

DHCP version 6 (DHCPv6) is widely used in LANs to dynamically assign IPv6 addresses. Both DHCP version 4 (DHCPv4) and DHCPv6 have security problems. Attacks to DHCPv4 apply also to DHCPv6. A network attacker can send a large number of DHCPv6 requests to use up the address space provided by the DHCPv6 server within a period. In this case, authorized hosts will fail to request IPv6 addresses and thereby fail to access the network. To prevent this type of attacks, limit the rate of DHCPv6 packets and find the attack source.

➤ **ND Guard**

Neighbor Discovery (ND) is mainly used in IPv6 networks to perform address resolution, router discovery, prefix discovery, and redirection. ND uses five types of packets: Neighbor Solicitation (NS), Neighbor Advertisement (NA), Router Solicitation (RS), Router Advertisement (RA), and Redirect. These packets are called ND packets.

➤ **Self-Defined Guard**

There are various types of network protocols, including routing protocols such as Open Shortest Path First (OSPF), Border Gateway Protocol (BGP), and Routing Information Protocol (RIP). Various devices need to exchange packets through different protocols. These packets must be sent to the CPU and processed by appropriate protocols. Once the network device runs a protocol, it is like opening a window for attackers. If an attacker sends a large number of protocol packets to a network device, massive CPU resources will be consumed on the device, and what's worse, the device may fail to work properly.

Since various protocols are being continuously developed, protocols in use vary with the user environments. FS devices hereby provide self-defined guard. Users can customize and flexibly configure guard types to meet guard requirements in different user environments.

Overview

Feature	Description
Host-based Rate Limiting and Attack Identification	Limits the rate according to the host-based rate limit and identify host attacks in the network.
Port-based Rate Limiting and Attack Identification	Limits the rate according to the port-based rate limit and identify port attacks.
Monitoring Period	Monitors host attackers in a specified period.

Isolation_Period	Uses hardware to isolate host attackers or port attackers in a specified period.
Trusted Hosts	Trusts a host by not monitoring it.
Centralized BandwidthAllocation	Classifies and prioritizes packets.

11.3.1 Host-based Rate Limiting and Attack Identification

Limit the rate of attack packets of hosts and identify the attacks.

Identify ARP scanning.

Identify IP scanning.

Working Principle

Hosts can be identified in two ways: based on the source IP address, VLAN ID, and port and based on the link-layer source MAC address, VLAN ID, and port. Each host has a rate limit and an attack threshold (also called alarm threshold). The rate limit must be lower than the attack threshold. If the attack packet rate exceeds the rate limit of a host, the host discards the packets beyond the rate limit. If the attack packet rate exceeds the attack threshold of a host, the host identifies and logs the host attacks, and sends traps.

ARP scanning attack may have occurred if ARP packets beyond the scanning threshold received in the configured period meet either of the following conditions:

- The link-layer source MAC address is fixed but the source IP address changes.
- The link-layer source MAC address and source IP address are fixed but the destination IP address continuously changes.

Among IP packets beyond the scanning threshold received in the configured period, if the source IP address remains the same while the destination IP address continuously changes, IP scanning attack may have occurred.

 When NFPP detects a specific type of attack packets under a service, it sends a trap to the administrator. If the attack traffic persists, NFPP will not resend the alarm until 60 seconds later.

 To prevent CPU resource consumption caused by frequent log printing, NFPP writes attack detection logs to the buffer, obtains them from the buffer at a specified rate, and prints them. NFPP does not limit the rate of traps.

Related Configuration

Use ARP guard as an example:

📌 Configuring the Global Host-based Rate Limit, Attack Threshold, and Scanning Threshold

In NFPP configuration mode:

Run the **arp-guard rate-limit** {per-src-ip | per-src-mac} pps command to configure rate limits of hosts identified based on the source IP address, VLAN ID, and port and hosts identified based on the link-layer source MAC address, VLAN ID, and port.

Run the **arp-guard attack-threshold** {per-src-ip | per-src-mac} pps command to configure attack thresholds of hosts identified based on the source IP address, VLAN ID, and port and hosts identified based on the link-layer source MAC address, VLAN ID, and port.

Run the **arp-guard scan-threshold** pkt-cnt command to configure the ARP scanning threshold.

📌 Configuring Host-based Rate Limit and Attack Threshold, and Scanning Threshold on an Interface

In interface configuration mode:

Run the **nfpp arp-guard policy {per-src-ip | per-src-mac} rate-limit-pps attack-threshold-pps** command to configure rate limits and attack thresholds of hosts identified based on the source IP address, VLAN ID, and port and hosts identified based on the link-layer source MAC address, VLAN ID, and port on an interface.

Run the **nfpp arp-guard scan-threshold pkt-cnt** command to configure the scanning threshold on an interface.

 Only ARP guard and IP guard support anti-scanning at present.

11.3.2 Port-based Rate Limiting and Attack Identification

Working Principle

Each port has a rate limit and an attack threshold. The rate limit must be lower than the attack threshold. If the packet rate exceeds the rate limit on a port, the port discards the packets. If the packet rate exceeds the attack threshold on a port, the port logs the attacks and sends traps.

Related Configuration

Use ARP guard as an example:

➤ Configuring the Global Port-based Rate Limit and Attack Threshold

In NFPP configuration mode:

Run the **arp-guard rate-limit per-port pps** command to configure the rate limit of a port.

Run the **arp-guard attack-threshold per-port pps** command to configure the attack threshold of a port.

➤ Configuring Port-based Rate Limit and Attack Threshold on an Interface

In interface configuration mode:

Run the **nfpp arp-guard policy per-port rate-limit-pps attack-threshold-pps** command to configure the rate limit and attack threshold of a port.

11.3.3 Monitoring Period

Working Principle

The monitoring user provides information about attackers in the current system. If the isolation period is 0 (that is, not isolated), the guard module automatically performs software monitoring on attackers in the configured monitoring period. If the isolation period is set to a non-zero value, the guard module automatically isolates the hosts monitored by software and sets the timeout period as the isolation period. The monitoring period is valid only when the isolation period is 0.

Related Configuration

Use ARP guard as an example:

➤ Configuring the Global Monitoring Period

In NFPP configuration mode:

Run the **arp-guard monitor-period seconds** command to configure the monitoring period.

11.3.4 Isolation Period

Working Principle

Isolation is performed by the guard policies after attacks are detected. Isolation is implemented using the filter of the hardware to ensure that these attacks will not be sent to the CPU, thereby ensuring proper running of the device.

Hardware isolation supports two modes: host-based and port-based isolation. At present, only ARP or ND guard supports port-based hardware isolation.

A policy is configured in the hardware to isolate attackers. However, hardware resources are limited. When hardware resources are used up, the system prints logs to notify the administrator.

Related Configuration

Use ARP guard as an example:

➤ Configuring the Global Isolation Period

In NFPP configuration mode:

Run the **arp-guard isolate-period** [*seconds* | **permanent**] command to configure the isolation period. If the isolation period is set to 0, isolation is disabled. If it is set to a non-zero value, the value indicates the isolation period. If it is set to **permanent**, ARP attacks are permanently isolated.

➤ Configuring the Isolation Period on an Interface

In interface configuration mode:

Run the **nfpp arp-guard isolate-period** [*seconds* | **permanent**] command to configure the isolation period. If the isolation period is set to 0, isolation is disabled. If it is set to a non-zero value, the value indicates the isolation period. If it is set to **permanent**, ARP attacks are permanently isolated.

➤ Enabling Isolate Forwarding

In NFPP configuration mode:

Run the **arp-guard isolate-forwarding enable** command to enable isolate forwarding.

➤ Enabling Port-based Ratelimit Forwarding

In NFPP configuration mode:

Run the **arp-guard ratelimit-forwarding enable** command to enable port-based ratelimit forwarding.

 At present, only ARP guard supports the configuration of isolate forwarding and ratelimit forwarding.

11.3.5 Trusted Hosts

Working Principle

If you do not want to monitor a host, you can run related commands to trust the host. This trusted host will be allowed to send packets to the CPU.

Related Configuration

Use IP anti-scanning as an example:

➤ **Configuring Trusted Hosts**

In NFPP configuration mode:

Run the **ip-guard trusted-host** *ip mask* command to trust a host.

Run the **trusted-host** {*mac mac_mask* | *ip mask* | *IPv6/prefixlen*} command to trust a host for a self-defined guard.

11.3.6 Centralized Bandwidth Allocation

Working Principle

Services defined in CPP are classified into three types: Manage, Route, and Protocol. (For details, see the following table.) Each type of service has an independent bandwidth. Different types of services cannot share their bandwidths. Traffics exceeding the bandwidth thresholds are discarded. By such service classification, service packets are processed by orders of precedence.

NFPP allows the administrator to flexibly assign bandwidth for three types of packets based on the actual network environment so that Protocol and Manage packets can be first processed. Prior processing of Protocol packets ensures proper running of protocols, and prior processing of Manage packets ensures proper management for the administrator, thereby ensuring proper running of important device functions and improving the guard capability of the device.

After classified rate limiting, all types of packets are centralized in a queue. When one type of service is processed inefficiently, packets of this service will be backlogged in the queue and may finally use up resources of the queue. NFPP allows the administrator to configure the percentages of these three types of packets in the queue. When the queue length occupied by one type of packets exceeds the value of the total queue length multiplied by the percentage of this packet type, the excessive packets will be discarded. This efficiently prevents one type of packets from exclusively occupying queue resources.

Packet Type	Service Type Defined in CPP
Protocol	tp-guard, dot1x, rldp, rerp, slow-packet, bpdu, isis dhcps, gvrp, ripng, dvmrp, igmp, mpls, ospf, pim, pimv6, rip, vrrp, ospf3, dhcp-relay-s, dhcp-relay-c, option82, tunnel-bpdu, tunnel-gvrp
Route	unknown-ipmc, unknown-ipmcv6, ttl1, ttl0, udp-helper, ip4-packet-other, ip6-packet-other, non-ip-packet-other, arp
Manage	ip4-packet-local, ip6-packet-local

 For the definitions of service types, see the Configuring CPU Protection.

Related Configuration

➤ **Configuring the Maximum Bandwidth of Specified Packets**

In global configuration mode:

Run the **cpu-protect sub-interface** { **manage** | **protocol**|**route**} **pps** *pps_value* command to configure the maximum bandwidth of specified packets.

➤ **Configuring the Maximum Percentage of Specified Packets in the Queue**

In global configuration mode:

Run the **cpu-protect sub-interface** { **manage** | **protocol** | **route**} **percent** *percent_value* command to configure the maximum percentage of specified packets in the queue.

11.4 Configuration

Configuration	Description and Command	
Configuring ARP Guard	arp-guard enable	Enables ARP guard globally.
	arp-guard isolate-period	Configures the global ARP-guard isolation period.
	arp-guard isolate-forwarding enable	Enables ARP-guard isolate forwarding.
	arp-guard ratelimit-forwarding enable	Enables APR-guard ratelimit forwarding.
	arp-guard monitor-period	Configures the global ARP-guard monitoring period.
	arp-guard monitored-host-limit	Configures the maximum number of ARP-guard monitored hosts.
	arp-guard rate-limit	Configures the global ARP-guard rate limit.
	arp-guard attack-threshold	Configures the global ARP-guard attack threshold.
	arp-guard scan-threshold	Configures the global ARP-guard scanning threshold.
	nfpp arp-guard enable	Enables ARP guard on an interface.
	nfpp arp-guard policy	Configures the APR-guard rate limit and attack threshold on an interface.
	nfpp arp-guard scan-threshold	Configures the APR-guard scanning threshold on an interface.
	nfpp arp-guard isolate-period	Configures the APR-guard isolation period on an interface.
Configuring IP Guard	ip-guard enable	Enables IP guard globally.
	ip-guard isolate-period	Configures the global IP-guard isolation period.
	ip-guard monitor-period	Configures the global IP-guard monitoring period.
	ip-guard monitored-host-limit	Configures the maximum number of IP-guard monitored hosts.
	ip-guard rate-limit	Configures the global IP-guard rate limit.
	ip-guard attack-threshold	Configures the global IP-guard attack threshold.
	ip-guard scan-threshold	Configures the global IP-guard scanning threshold.
	ip-guard trusted-host	Configures IP-guard trusted hosts.
	nfpp ip-guard enable	Enables IP guard on an interface.
	nfpp ip-guard policy	Configures the IP-guard rate limit and attack threshold on an interface.
	nfpp ip-guard scan-threshold	Configures the IP-guard scanning threshold on an interface.
	nfpp ip-guard isolate-period	Configures the IP-guard isolation period on an interface.
Configuring ICMP Guard	icmp-guard enable	Enables ICMP guard globally.
	icmp-guard isolate-period	Configures the global ICMP-guard isolation period.
	icmp-guard monitor-period	Configures the global ICMP-guard monitoring period.
	icmp-guard monitored-host-limit	Configures the maximum number of ICMP-guard monitored hosts.
	icmp-guard rate-limit	Configures the global ICMP-guard rate limit.
	icmp-guard attack-threshold	Configures the global ICMP-guard attack threshold.

Configuration	Description and Command	
	icmp-guard trusted-host	Configures ICMP-guard trusted hosts.
	nfpp icmp-guard enable	Enables ICMP guard on an interface.
	nfpp icmp-guard policy	Configures the ICMP-guard rate limit and attack threshold on an interface.
	nfpp icmp-guard isolate-period	Configures the ICMP-guard isolation period on an interface.
Configuring DHCP Guard	dhcp-guard enable	Enables DHCP guard globally.
	dhcp-guard isolate-period	Configures the global DHCP-guard isolation period.
	dhcp-guard monitor-period	Configures the global DHCP-guard monitoring period.
	dhcp-guard monitored-host-limit	Configures the maximum number of DHCP-guard monitored hosts.
	dhcp-guard rate-limit	Configures the global DHCP-guard rate limit.
	dhcp-guard attack-threshold	Configures the global DHCP-guard attack threshold.
	nfpp dhcp-guard enable	Enables DHCP guard on an interface.
	nfpp dhcp-guard policy	Configures the DHCP-guard rate limit and attack threshold on an interface.
Configuring DHCPv6 Guard	dhcpv6-guard enable	Enables DHCPv6 guard globally.
	dhcpv6-guard monitor-period	Configures the global DHCPv6-guard monitoring period.
	dhcpv6-guard monitored-host-limit	Configures the maximum number of DHCPv6-guard monitored hosts.
	dhcpv6-guard rate-limit	Configures the global DHCPv6-guard rate limit.
	dhcpv6-guard attack-threshold <i>{ per-src-mac per-port} pps</i>	Configures the global DHCPv6-guard attack threshold.
	nfpp dhcpv6-guard enable	Enables DHCPv6 guard on an interface.
	nfpp dhcpv6-guard policy	Configures the DHCPv6-guard rate limit and attack threshold on an interface.
Configuring ND Guard	nd-guard enable	Enables ND guard globally.
	nd-guard ratelimit-forwarding enable	Enables ND-guard ratelimit forwarding.
	nd-guard rate-limit per-port	Configures the global ND-guard rate limit.
	nd-guard attack-threshold per-port	Configures the global ND-guard attack threshold.
	nfpp nd-guard enable	Enables ND guard on an interface.
	nfpp nd-guard policy per-port	Configures the ND-guard rate limit and attack threshold on an interface.
Configuring a Self-Defined Guard	define	Configures the name of a self-defined guard.
	match	Configures match fields of a self-defined guard.
	global-policy	Configures the global rate limit and attack threshold of a self-defined guard.
	monitor-period	Configures the global monitoring period of a self-defined guard.

Configuration	Description and Command	
	monitored-host-limit	Configures the maximum number of monitored hosts of a self-defined guard.
	trusted-host	Configures trusted hosts of a self-defined guard.
	define name enable	Enables a self-defined guard globally.
	nfpp define name enable	Enables a self-defined guard on an interface.
	nfpp define	Configures the rate limit and attack threshold of a self-defined guard on an interface.
Configuring NFPP Logging	log-buffer entries	Configures the log buffer size.
	log-buffer logs	Configures the log buffer rate.
	logging vlan	Configures VLAN-based logging filtering.
	logging interface	Configures interface-based logging filtering.
	logging enable	Enables log printing.

11.4.1 Configuring ARP Guard

Configuration Effect

- ARP attacks are identified based on hosts or ports. Host-based ARP attack identification supports two modes: identification based on the source IP address, VLAN ID, and port and identification based on the link-layer source MAC address, VLAN ID, and port. Each type of attack identification has a rate limit and an attack threshold. If the ARP packet rate exceeds the rate limit, the packets beyond the rate limit are discarded. If the ARP packet rate exceeds the attack threshold, the system prints alarm information and sends traps. In host-based attack identification, the system also isolates the attack source.
- ARP guard can also detect ARP scanning attacks. ARP scanning attacks indicate that the link-layer source MAC address is fixed but the source IP address changes, or that the link-layer source MAC address and source IP address are fixed but the destination IP address continuously changes. Due to the possibility of false positive, hosts possibly performing ARP scanning are not isolated and are provided for the administrator's reference only.
- Configure ARP-guard isolation to assign hardware-isolated entries against host attacks so that attack packets are neither sent to the CPU nor forwarded.

Notes

- For a command that is configured both in NFPP configuration mode and interface configuration mode, the configuration in interface configuration mode takes priority over that configured in NFPP configuration mode.
- Isolation is disabled by default. If isolation is enabled, attackers will occupy hardware entries of the security module.
- ARP guard prevents only ARP DoS attacks to the switch, but not ARP spoofing or ARP attacks in the network.
- For trusted ports configured for Dynamic ARP Inspection (DAI), ARP guard does not take effect, preventing false positive of ARP traffic over the trusted ports. For details about DAI trusted ports, see the Configuring Dynamic ARP Inspection.

Configuration Steps

📌 Enabling ARP Guard

- (Mandatory) ARP guard is enabled by default.
- This function can be enabled in NFPP configuration mode or interface configuration mode.
- If ARP guard is disabled, the system automatically clears monitored hosts, scanned hosts, and isolated entries on ports.

↘ **Configuring the ARP-Guard Isolation Period**

- (Optional) ARP-guard isolation is disabled by default.
- If the packet traffic of attackers exceeds the rate limit defined in CPP, you can configure the isolation period to discard packets and therefore to save bandwidth resources.
- The isolation period can be configured in NFPP configuration mode or interface configuration mode.
- If the isolation period is changed to 0, attackers under the corresponding port is deleted, instead of being monitored.

↘ **Enabling ARP-Guard Isolate Forwarding**

- (Optional) ARP-guard isolate forwarding is enabled by default.
- To make isolation valid only at the management plane instead of the forwarding plane, you can enable this function.
- This function can be enabled in NFPP configuration mode.

↘ **Enabling ARP-Guard Ratelimit Forwarding**

- (Optional) This function is enabled by default.
- If the port-based isolation entry takes effect, you can enable this function to pass some of the packets while not discarding all of them.
- This function can be enabled in NFPP configuration mode.

↘ **Configuring the ARP-Guard Monitoring Period**

- (Mandatory) The default ARP-guard monitoring period is 600 seconds.
- If the ARP-guard isolation period is configured, it is directly used as the monitoring period, and the configured monitoring period will lose effect.
- The monitoring period can be configured in NFPP configuration mode.

↘ **Configuring the Maximum Number of ARP-Guard Monitored Hosts**

- (Mandatory) The maximum number of ARP-guard monitored hosts is 20,000 by default.
- Set the maximum number of ARP-guard monitored hosts reasonably. As the number of monitored hosts increases, more CPU resources are used.
- The maximum number of ARP-guard monitored hosts can be configured in NFPP configuration mode.
- If the number of monitored hosts reaches 20,000 (default value) and the administrator sets the maximum number lower than 20,000, the system does not delete monitored hosts but prints the log "%ERROR: The value that you configured is smaller than current monitored hosts 20000, please clear a part of monitored hosts." This information notifies the administrator that the configuration does not take effect and that some monitored hosts need to be deleted.
- If the table of monitored hosts is full, the system prints the log "% NFPP_ARP_GUARD-4-SESSION_LIMIT: Attempt to exceed limit of 20000 monitored hosts." to notify the administrator.

↘ **Configuring the ARP-Guard Attack Threshold**

- Mandatory.

- To achieve the best ARP-guard effect, you are advised to configure the host-based rate limit and attack threshold based on the following order: Source IP address-based rate limit < Source IP address-based attack threshold < Source MAC address-based rate limit < Source MAC address-based attack threshold.
- The attack threshold can be configured in NFPP configuration mode or interface configuration mode.
- If the configured rate limit is greater than the attack threshold, the system prints the log "%ERROR: rate limit is higher than attack threshold 500pps." to notify the administrator.
- If the configured attack threshold is less than the rate limit, the system prints the log "%ERROR: attack threshold is smaller than rate limit 300pps." to notify the administrator.
- If the memory cannot be allocated to detected attackers, the system prints the log "%NFPP_ARP_GUARD-4-NO_MEMORY: Failed to alloc memory." to notify the administrator.
- Source MAC address-based rate limiting takes priority over source IP address-based rate limiting while the latter takes priority over port-based rate limiting.

➤ **Configuring the ARP-Guard Scanning Threshold**

- Mandatory.
- The scanning threshold can be configured in NFPP configuration mode or interface configuration mode.
- The ARP scanning table stores only the latest 256 records. When the ARP scanning table is full, the latest record will overwrite the earliest record.
- ARP scanning attack may have occurred if ARP packets received within 10 seconds meet either of the following conditions:
 - The link-layer source MAC address is fixed but the source IP address changes.
 - The link-layer source MAC address and source IP address are fixed but the destination IP address continuously changes, and the change times exceed the scanning threshold.

Verification

When a host in the network sends ARP attack packets to a switch configured with ARP guard, check whether these packets can be sent to the CPU.

- If the packets exceed the attack threshold or scanning threshold, an attack log is displayed.
- If an isolated entry is created for the attacker, an isolation log is displayed.

Related Commands

➤ **Enabling ARP Guard Globally**

Command	arp-guard enable
Parameter	N/A
Description	
Command Mode	NFPP configuration mode
Usage Guide	N/A

➤ **Configuring the Global ARP-Guard Isolation Period**

Command	arp-guard isolate-period [seconds permanent]
----------------	---

Parameter	<i>seconds</i> : Indicates the isolation period in the unit of second. It can be set to 0 or any value from 30 to 86,400.
Description	permanent : Indicates permanent isolation.
Command	NFPP configuration mode
Mode	
Usage Guide	N/A

↘ **Enabling ARP-Guard Isolate Forwarding**

Command	arp-guard isolate-forwarding enable
Parameter	N/A
Description	
Command	NFPP configuration mode
Mode	
Usage Guide	N/A

↘ **Enabling ARP-Guard Ratelimit Forwarding**

Command	arp-guard ratelimit-forwarding enable
Parameter	N/A
Description	
Command	NFPP configuration mode
Mode	
Usage Guide	N/A

↘ **Configuring the Global ARP-Guard Monitoring Period**

Command	arp-guard monitor-period <i>seconds</i>
Parameter	<i>seconds</i> : Indicates the monitoring period in the unit of second. The value ranges from 180 to 86,400.
Description	
Command	NFPP configuration mode
Mode	
Usage Guide	N/A

↘ **Configuring the Maximum Number of ARP-Guard Monitored Hosts**

Command	arp-guard monitored-host-limit <i>number</i>
Parameter	<i>number</i> : Indicates the maximum number of monitored hosts, ranging from 1 to 4,294,967,295.
Description	
Command	NFPP configuration mode
Mode	
Usage Guide	N/A

↘ **Configuring the Global ARP-Guard Rate Limit**

Command	arp-guard rate-limit { per-src-ip per-src-mac per-port } <i>pps</i>
Parameter	per-src-ip : Limits the rate of each source IP address.
Description	per-src-mac : Limits the rate of each source MAC address. per-port : Limits the rate of each port.

	<i>pps</i> : Indicates the rate limit, ranging from 1 to 19,999.
Command	NFPP configuration mode
Mode	
Usage Guide	N/A

↘ Configuring the Global ARP-Guard Attack Threshold

Command	arp-guard attack-threshold {per-src-ip per-src-mac per-port} pps
Parameter	per-src-ip : Configures the attack threshold of each source IP address.
Description	per-src-mac : Configures the attack threshold of each source MAC address. per-port : Configures the attack threshold of each port. <i>pps</i> : Indicates the attack threshold, ranging from 1 to 19,999. The unit is packets per second (pps).
Command	NFPP configuration mode
Mode	
Usage Guide	The attack threshold must be equal to or greater than the rate limit.

↘ Configuring the Global ARP-Guard Scanning Threshold

Command	arp-guard scan-threshold pkt-cnt
Parameter	<i>pkt-cnt</i> : Indicates the scanning threshold, ranging from 1 to 19,999.
Description	
Command	NFPP configuration mode
Mode	
Usage Guide	N/A

↘ Enabling ARP Guard on an Interface

Command	nfpp arp-guard enable
Parameter	N/A
Description	
Command	Interface configuration mode
Mode	
Usage Guide	ARP guard configured in interface configuration mode takes priority over that configured in NFPP configuration mode.

↘ Configuring the ARP-Guard Isolation Period on an Interface

Command	nfpp arp-guard isolate-period [seconds permanent]
Parameter	<i>seconds</i> : Indicates the isolation period in the unit of second. It can be set to 0 or any value from 30 to 86,400. The value 0 indicates no isolation.
Description	permanent : Indicates permanent isolation.
Command	Interface configuration mode
Mode	
Usage Guide	N/A

↘ Configuring the ARP-Guard Rate Limit and Attack Threshold on an Interface

Command	nfpp arp-guard policy {per-src-ip per-src-mac per-port} rate-limit-pps attack-threshold-pps
----------------	--

Parameter	per-src-ip: Configures the rate limit and attack threshold of each source IP address.
Description	<p>per-src-ip: Configures the rate limit and attack threshold of each source MAC address.</p> <p>per-port: Configures the rate limit and attack threshold of each port.</p> <p><i>rate-limit-pps:</i> Indicates the rate limit, ranging from 1 to 19,999.</p> <p><i>attack-threshold-pps:</i> Indicates the attack threshold, ranging from 1 to 19,999.</p>
Command	Interface configuration mode
Mode	
Usage Guide	The attack threshold must be equal to or greater than the rate limit.

📌 **Configuring the ARP-Guard Scanning Threshold on an Interface**

Command	nfpp arp-guard scan-threshold <i>pkt-cnt</i>
Parameter	<i>pkt-cnt:</i> Indicates the scanning threshold, ranging from 1 to 19,999.
Description	
Command	Interface configuration mode
Mode	
Usage Guide	N/A

Configuration Example

📌 **CPU Protection Based on ARP Guard**

Scenario	<ul style="list-style-type: none"> ● ARP host attacks exist in the system, and some hosts fail to properly establish ARP connection. ● ARP scanning exists in the system, causing a very high CPU utilization rate.
Configuration Steps	<ul style="list-style-type: none"> ● Set the host-based attack threshold to 5 pps. ● Set the ARP scanning threshold to 10 pps. ● Set the isolation period to 180 pps.
	<pre>FS# configure terminal FS(config)# nfpp FS (config-nfpp)#arp-guard rate-limit per-src-mac 5 FS (config-nfpp)#arp-guard attack-threshold per-src-mac 10 FS (config-nfpp)#arp-guard isolate-period 180</pre>
Verification	<ul style="list-style-type: none"> ● Run the show nfpp arp-guard summary command to display the configuration.
	<pre>(Format of column Rate-limit and Attack-threshold is per-src-ip/per-src-mac/per-port.) Interface Status Isolate-period Rate-limit Attack-threshold Scan-threshold Global Disable 180 4/5/100 8/10/200 15 Maximum count of monitored hosts: 1000 Monitor period: 600s</pre>
	<ul style="list-style-type: none"> ● Run the show nfpp arp-guard hosts command to display the monitored hosts.
	<pre>If col_filter 1 shows '*', it means "hardware do not isolate host".</pre>

VLAN	interface	IP address	MAC address	remain-time(s)
1	Gi0/43	5.5.5.16	-	175
Total: 1 host				

● Run the **show nfpp arp-guard scan** command to display the scanned hosts.

VLAN	interface	IP address	MAC address	timestamp
1	Gi0/5	-	001a.a9c2.4609	2013-4-30 23:50:32
1	Gi0/5	192.168.206.2	001a.a9c2.4609	2013-4-30 23:50:33
1	Gi0/5	-	001a.a9c2.4609	2013-4-30 23:51:33
1	Gi0/5	192.168.206.2	001a.a9c2.4609	2013-4-30 23:51:34
Total: 4 record(s)				

Common Errors

N/A

11.4.2Configuring IP Guard

Configuration Effect

- IP attacks are identified based on hosts or physical interfaces. In host-based IP attack identification, IP attacks are identified based on the source IP address, VLAN ID, and port. Each type of attack identification has a rate limit and an attack threshold. If the IP packet rate exceeds the rate limit, the packets beyond the rate limit are discarded. If the IP packet rate exceeds the attack threshold, the system prints alarm information and sends traps. In host-based attack identification, the system also isolates the attack source.
- IP guard can also detect IP scanning attacks. IP anti-scanning applies to IP packet attacks as follows: the destination IP address continuously changes but the source IP address remains the same, and the destination IP address is not the IP address of the local device.
- Configure IP guard isolation to assign hardware-isolated entries against host attacks so that attack packets are neither sent to the CPU nor forwarded.
- IP anti-scanning applies to IP packet attacks where the destination IP address is not the local IP address. The CPP limits the rate of IP packets where the destination IP address is the local IP address.

Notes

- For a command that is configured both in NFPP configuration mode and interface configuration mode, the configuration in interface configuration mode takes priority over that configured in NFPP configuration mode.
- Isolation is disabled by default. If isolation is enabled, attackers will occupy hardware entries of the security module.

Configuration Steps

➤ **Enabling IP Guard**

- (Mandatory) IP guard is enabled by default.
- This function can be enabled in NFPP configuration mode or interface configuration mode.
- If IP guard is disabled, the system automatically clears monitored hosts.

▾ **Configuring the IP-Guard Isolation Period**

- (Optional) IP-guard isolation is disabled by default.
- If the packet traffic of attackers exceeds the rate limit defined in CPP, you can configure the isolation period to discard packets and therefore to save bandwidth resources.
- The isolation period can be configured in NFPP configuration mode or interface configuration mode.
- If the isolation period is changed to 0, attackers under the corresponding port is deleted, instead of being monitored.

▾ **Configuring the IP-Guard Monitoring Period**

- (Mandatory) The default IP-guard monitoring period is 600 seconds.
- If the IP-guard isolation period is configured, it is directly used as the monitoring period, and the configured monitoring period will lose effect.
- The monitoring period can be configured in NFPP configuration mode.

▾ **Configuring the Maximum Number of IP-Guard Monitored Hosts**

- (Mandatory) The maximum number of IP-guard monitored hosts is 20,000 by default.
- Set the maximum number of IP-guard monitored hosts reasonably. As the number of monitored hosts increases, more CPU resources are used.
- The maximum number of IP-guard monitored hosts can be configured in NFPP configuration mode.
- If the number of monitored hosts reaches 20,000 (default value) and the administrator sets the maximum number lower than 20,000, the system does not delete monitored hosts but prints the log "%ERROR: The value that you configured is smaller than current monitored hosts 20,000, please clear a part of monitored hosts." This information notifies the administrator that the configuration does not take effect and that some monitored hosts need to be deleted.
- If the table of monitored hosts is full, the system prints the log "% NFPP_IP_GUARD-4-SESSION_LIMIT: Attempt to exceed limit of 20000 monitored hosts." to notify the administrator.

▾ **Configuring the IP-Guard Attack Threshold**

- Mandatory.
- The attack threshold can be configured in NFPP configuration mode or interface configuration mode.
- If the configured rate limit is greater than the attack threshold, the system prints the log "%ERROR: rate limit is higher than attack threshold 500pps." to notify the administrator.
- If the configured attack threshold is less than the rate limit, the system prints the log "%ERROR: attack threshold is smaller than rate limit 300pps." to notify the administrator.
- If the memory cannot be allocated to detected attackers, the system prints the log "%NFPP_IP_GUARD-4-NO_MEMORY: Failed to alloc memory." to notify the administrator.
- Source IP address-based rate limiting takes priority over port-based rate limiting.

➤ **Configuring the IP-Guard Scanning Threshold**

- Mandatory.
- The scanning threshold can be configured in NFPP configuration mode or interface configuration mode.
- ARP scanning attack may have occurred if ARP packets received within 10 seconds meet the following conditions:
 - The source IP address remains the same.
 - The destination IP address continuously changes and is not the local IP address, and the change times exceed the scanning threshold.

➤ **Configuring IP-Guard Trusted Hosts**

- (Optional) No IP-guard trusted host is configured by default.
- For IP guard, you can only configure a maximum of 500 IP addresses not to be monitored.
- Trusted hosts can be configured in NFPP configuration mode.
- If any entry matching a trusted host (IP addresses are the same) exists in the table of monitored hosts, the system automatically deletes this entry.
- If the table of trusted hosts is full, the system prints the log "%ERROR: Attempt to exceed limit of 500 trusted hosts." to notify the administrator.
- If a trusted host cannot be deleted, the system prints the log "%ERROR: Failed to delete trusted host 1.1.1.0 255.255.255.0." to notify the administrator.
- If a host cannot be trusted, the system prints the log "%ERROR: Failed to add trusted host 1.1.1.0 255.255.255.0." to notify the administrator.
- If the host to trust already exists, the system prints the log "%ERROR: Trusted host 1.1.1.0 255.255.255.0 has already been configured." to notify the administrator.
- If the host to delete from the trusted table does not exist, the system prints the log "%ERROR: Trusted host 1.1.1.0 255.255.255.0 is not found." to notify the administrator.
- If the memory cannot be allocated to a trusted host, the system prints the log "%ERROR: Failed to alloc memory." to notify the administrator.

Verification

When a host in the network sends IP attack packets to a switch configured with IP guard, check whether these packets can be sent to the CPU.

- If the rate of packets from untrusted hosts exceeds the attack threshold or scanning threshold, an attack log is displayed.
- If an isolated entry is created for the attacker, an isolation log is displayed.

Related Commands

➤ **Enabling IP Guard Globally**

Command	ip-guard enable
Parameter	N/A
Description	
Command	NFPP configuration mode

Mode	
Usage Guide	N/A

↘ Configuring the Global IP-Guard Isolation Period

Command	ip-guard isolate-period [<i>seconds</i> permanent]
Parameter	<i>seconds</i> : Indicates the isolation period in the unit of second. It can be set to 0 or any value from 30 to 86,400.
Description	permanent : Indicates permanent isolation.
Command	NFPP configuration mode
Mode	
Usage Guide	N/A

↘ Configuring the Global IP-Guard Monitoring Period

Command	ip-guard monitor-period <i>seconds</i>
Parameter	<i>seconds</i> : Indicates the monitoring period in the unit of second. The value ranges from 180 to 86,400.
Description	
Command	NFPP configuration mode
Mode	
Usage Guide	If the isolation period is changed to 0, attackers under the corresponding port is deleted, instead of being monitored.

↘ Configuring the Maximum Number of IP-Guard Monitored Hosts

Command	ip-guard monitored-host-limit <i>number</i>
Parameter	<i>number</i> : Indicates the maximum number of monitored hosts, ranging from 1 to 4,294,967,295.
Description	
Command	NFPP configuration mode
Mode	
Usage Guide	N/A

↘ Configuring the Global IP-Guard Rate Limit

Command	ip-guard rate-limit { per-src-ip per-port } <i>pps</i>
Parameter	per-src-ip : Limits the rate of each source IP address.
Description	per-port : Limits the rate of each port. <i>pps</i> : Indicates the rate limit, ranging from 1 to 19,999.
Command	NFPP configuration mode
Mode	
Usage Guide	N/A

↘ Configuring the Global IP-Guard Attack Threshold

Command	ip-guard attack-threshold { per-src-ip per-port } <i>pps</i>
Parameter	per-src-ip : Configures the attack threshold of each source IP address.
Description	per-port : Configures the attack threshold of each port. <i>pps</i> : Indicates the attack threshold, ranging from 1 to 19,999. The unit is pps.
Command	NFPP configuration mode

Mode	
Usage Guide	The attack threshold must be equal to or greater than the rate limit.

↘ Configuring the Global IP-Guard Scanning Threshold

Command	ip-guard scan-threshold <i>pkt-cnt</i>
Parameter Description	<i>pkt-cnt</i> : Indicates the scanning threshold, ranging from 1 to 19,999.
Command Mode	NFPP configuration mode
Usage Guide	N/A

↘ Configuring IP-Guard Trusted Hosts

Command	ip-guard trusted-host <i>ip mask</i>
Parameter Description	<i>ip</i> : Indicates the IP address. <i>mask</i> : Indicates the mask of an IP address. all : Used with no to delete all trusted hosts.
Command Mode	NFPP configuration mode
Usage Guide	If you do not want to monitor a host, you can run this command to trust the host. This trusted host can send IP packets to the CPU, without any rate limiting or alarm reporting.

↘ Enabling IP Guard on an Interface

Command	nfpp ip-guard enable
Parameter Description	N/A
Command Mode	Interface configuration mode
Usage Guide	IP guard configured in interface configuration mode takes priority over that configured in NFPP configuration mode.

↘ Configuring the IP-Guard Isolation Period on an Interface

Command	nfpp ip-guard isolate-period [<i>seconds</i> permanent]
Parameter Description	<i>seconds</i> : Indicates the isolation period in the unit of second. It can be set to 0 or any value from 30 to 86,400. The value 0 indicates no isolation. permanent : Indicates permanent isolation.
Command Mode	Interface configuration mode
Usage Guide	N/A

↘ Configuring the IP-Guard Rate Limit and Attack Threshold on an Interface

Command	nfpp ip-guard policy { per-src-ip per-port } <i>rate-limit-pps attack-threshold-pps</i>
Parameter Description	per-src-ip : Configures the attack threshold of each source IP address. per-port : Configures the attack threshold of each port. <i>rate-limit-pps</i> : Indicates the rate limit, ranging from 1 to 19,999.

	<i>attack-threshold-pps</i> : Indicates the attack threshold, ranging from 1 to 19,999.
Command	Interface configuration mode
Mode	
Usage Guide	The attack threshold must be equal to or greater than the rate limit.

📌 **Configuring the IP-Guard Scanning Threshold on an Interface**

Command	nfpp ip-guard scan-threshold <i>pkt-cnt</i>
Parameter	<i>pkt-cnt</i> : Indicates the scanning threshold, ranging from 1 to 19,999.
Description	
Command	Interface configuration mode
Mode	
Usage Guide	N/A

Configuration Example

📌 **CPU Protection Based on IP Guard**

Scenario	<ul style="list-style-type: none"> ● IP host attacks exist in the system, and packets of some hosts cannot be properly routed and forwarded. ● IP scanning exists in the system, causing a very high CPU utilization rate. ● Packet traffic of some hosts is very large in the system, and these packets need to pass through.
Configuration Steps	<ul style="list-style-type: none"> ● Configure the host-based attack threshold. ● Configure the IP scanning threshold. ● Set the isolation period to a non-zero value. ● Configure trusted hosts.
	<pre> FS# configure terminal FS(config)# nfpp FS (config-nfpp)#ip-guard rate-limit per-src-ip 20 FS (config-nfpp)#ip-guard attack-threshold per-src-ip 30 FS (config-nfpp)#ip-guard isolate-period 180 FS (config-nfpp)#ip-guard trusted-host 192.168.201.46 255.255.255.255 </pre>
Verification	<ul style="list-style-type: none"> ● Run the show nfpp ip-guard summary command to display the configuration.
	<pre> (Format of column Rate-limit and Attack-threshold is per-src-ip/per-src-mac/per-port.) Interface Status Isolate-period Rate-limit Attack-threshold Scan-threshold Global Disable 180 20/-/100 30/-/200 100 Maximum count of monitored hosts: 1000 Monitor period: 600s </pre>
	<ul style="list-style-type: none"> ● Run the show nfpp ip-guard hosts command to display the monitored hosts.
	<p>If <code>col_filter 1</code> shows <code>*</code>, it means "hardware do not isolate host".</p> <pre> VLAN interface IP address Reason remain-time(s) </pre>

<pre> ----- 1 Gi0/5 192.168.201.47 ATTACK 160 ----- Total: 1 host </pre>
<ul style="list-style-type: none"> Run the show nfpp ip-guard trusted-host command to display the trusted hosts.
<pre> IP address mask ----- 192.168.201.46 255.255.255.255 ----- Total: 1 record(s) </pre>

Common Errors

N/A

11.4.3 Configuring ICMP Guard

Configuration Effect

- ICMP attacks are identified based on hosts or ports. In host-based attack identification, ICMP attacks are identified based on the source IP address, VLAN ID, and port. Each type of attack identification has a rate limit and an attack threshold. If the ICMP packet rate exceeds the rate limit, the packets beyond the rate limit are discarded. If the ICMP packet rate exceeds the attack threshold, the system prints alarm information and sends traps. In host-based attack identification, the system also isolates the attack source.
- Configure ICMP guard isolation to assign hardware-isolated entries against host attacks so that attack packets are neither sent to the CPU nor forwarded.

Notes

- For a command that is configured both in NFPP configuration mode and interface configuration mode, the configuration in interface configuration mode takes priority over that configured in NFPP configuration mode.
- Isolation is disabled by default. If isolation is enabled, attackers will occupy hardware entries of the security module.

Configuration Steps

➤ Enabling ICMP Guard

- (Mandatory) ICMP guard is enabled by default.
- This function can be enabled in NFPP configuration mode or interface configuration mode.
- If ICMP guard is disabled, the system automatically clears monitored hosts.

➤ Configuring the ICMP-Guard Isolation Period

- (Optional) ICMP-guard isolation is disabled by default.
- If the packet traffic of attackers exceeds the rate limit defined in CPP, you can configure the isolation period to discard packets and therefore to save bandwidth resources.
- The isolation period can be configured in NFPP configuration mode or interface configuration mode.

- If the isolation period is changed to 0, attackers under the corresponding port is deleted, instead of being monitored.

↘ **Configuring the ICMP-Guard Monitoring Period**

- (Mandatory) The default ICMP-guard monitoring period is 600 seconds.
- If the ICMP-guard isolation period is configured, it is directly used as the monitoring period, and the configured monitoring period will lose effect.
- The monitoring period can be configured in NFPP configuration mode.

↘ **Configuring the Maximum Number of ICMP-Guard Monitored Hosts**

- (Mandatory) The maximum number of ICMP-guard monitored hosts is 20,000 by default.
- Set the maximum number of ICMP-guard monitored hosts reasonably. As the number of actually monitored hosts increases, more CPU resources are used.
- The maximum number of ICMP-guard monitored hosts can be configured in NFPP configuration mode.
- If the number of monitored hosts reaches 20,000 (default value) and the administrator sets the maximum number lower than 20,000, the system does not delete monitored hosts but prints the log "%ERROR: The value that you configured is smaller than current monitored hosts 20000, please clear a part of monitored hosts." This information notifies the administrator that the configuration does not take effect and that some monitored hosts need to be deleted.
- If the table of monitored hosts is full, the system prints the log "% NFPP_ICMP_GUARD-4-SESSION_LIMIT: Attempt to exceed limit of 20000 monitored hosts." to notify the administrator.

↘ **Configuring the ICMP-Guard Attack Threshold**

- Mandatory.
- The attack threshold can be configured in NFPP configuration mode or interface configuration mode.
- If the configured rate limit is greater than the attack threshold, the system prints the log "%ERROR: rate limit is higher than attack threshold 500pps." to notify the administrator.
- If the configured attack threshold is less than the rate limit, the system prints the log "%ERROR: attack threshold is smaller than rate limit 300pps." to notify the administrator.
- If the memory cannot be allocated to detected attackers, the system prints the log "%NFPP_ ICMP_GUARD-4-NO_MEMORY: Failed to alloc memory." to notify the administrator.
- Source IP address-based rate limiting takes priority over port-based rate limiting.

↘ **Configuring ICMP-Guard Trusted Hosts**

- (Optional) No ICMP-guard trusted host is configured by default.
- For ICMP guard, you can only configure a maximum of 500 IP addresses not to be monitored.
- Trusted hosts can be configured in NFPP configuration mode.
- If any entry matching a trusted host (IP addresses are the same) exists in the table of monitored hosts, the system automatically deletes this entry.
- If the table of trusted hosts is full, the system prints the log "%ERROR: Attempt to exceed limit of 500 trusted hosts." to notify the administrator.

- If a trusted host cannot be deleted, the system prints the log "%ERROR: Failed to delete trusted host 1.1.1.0 255.255.255.0." to notify the administrator.
- If a host cannot be trusted, the system prints the log "%ERROR: Failed to add trusted host 1.1.1.0 255.255.255.0." to notify the administrator.
- If the host to trust already exists, the system prints the log "%ERROR: Trusted host 1.1.1.0 255.255.255.0 has already been configured." to notify the administrator.
- If the host to delete from the trusted table does not exist, the system prints the log "%ERROR: Trusted host 1.1.1.0 255.255.255.0 is not found." to notify the administrator.
- If the memory cannot be allocated to a trusted host, the system prints the log "%ERROR: Failed to alloc memory." to notify the administrator.

Verification

When a host in the network sends ICMP attack packets to a switch configured with ICMP guard, check whether these packets can be sent to the CPU.

- If the rate of packets from an untrusted host exceeds the attack threshold, an attack log is displayed.
- If an isolated entry is created for the attacker, an isolation log is displayed.

Related Commands

▾ Enabling ICMP Guard Globally

Command	icmp-guard enable
Parameter	N/A
Description	
Command Mode	NFPP configuration mode
Usage Guide	N/A

▾ Configuring the Global ICMP-Guard Isolation Period

Command	icmp-guard isolate-period [<i>seconds</i> permanent]
Parameter Description	<i>seconds</i> : Indicates the isolation period in the unit of second. It can be set to 0 or any value from 30 to 86,400. The value 0 indicates no isolation. permanent : Indicates permanent isolation.
Command Mode	NFPP configuration mode
Usage Guide	The attacker isolation period falls into two types: global isolation period and port-based isolation period (local isolation period). For a port, if the port-based isolation period is not configured, the global isolation period is used; otherwise, the port-based isolation period is used.

▾ Configuring the Global ICMP-Guard Monitoring Period

Command	icmp-guard monitor-period <i>seconds</i>
Parameter Description	<i>seconds</i> : Indicates the monitoring period in the unit of second. The value ranges from 180 to 86,400.

Command Mode	NFPP configuration mode
Usage Guide	<p>If the isolation period is 0, the system performs software monitoring on detected attackers. The timeout period is the monitoring period. During software monitoring, if the isolation period is set to a non-zero value, the system automatically performs hardware isolation against monitored attackers and sets the timeout period as the monitoring period. The monitoring period is valid only when the isolation period is 0.</p> <p>If the isolation period is changed to 0, attackers under the corresponding port is deleted, instead of being monitored.</p>

✚ Configuring the Maximum Number of ICMP-Guard Monitored Hosts

Command	icmp-guard monitored-host-limit <i>number</i>
Parameter Description	<i>number</i> : Indicates the maximum number of monitored hosts, ranging from 1 to 4,294,967,295.
Command Mode	NFPP configuration mode
Usage Guide	<p>If the number of monitored hosts reaches 20,000 (default value) and the administrator sets the maximum number lower than 20,000, the system does not delete monitored hosts but prints the log "%ERROR: The value that you configured is smaller than current monitored hosts 20000, please clear a part of monitored hosts." This information notifies the administrator that the configuration does not take effect and that some monitored hosts need to be deleted.</p> <p>If the table of monitored hosts is full, the system prints the log "% NFPP_ICMP_GUARD-4-SESSION_LIMIT: Attempt to exceed limit of 20000 monitored hosts." to notify the administrator.</p>

✚ Configuring the Global ICMP-Guard Rate Limit

Command	icmp-guard rate-limit { per-src-ip per-port } <i>pps</i>
Parameter Description	<p>per-src-ip: Limits the rate of each source IP address.</p> <p>per-port: Limits the rate of each port.</p> <p><i>pps</i>: Indicates the rate limit, ranging from 1 to 19,999.</p>
Command Mode	NFPP configuration mode
Usage Guide	N/A

✚ Configuring the Global ICMP-Guard Attack Threshold

Command	icmp-guard attack-threshold { per-src-ip per-port } <i>pps</i>
Parameter Description	<p>per-src-ip: Configures the attack threshold of each source IP address.</p> <p>per-port: Configures the attack threshold of each port.</p> <p><i>pps</i>: Indicates the attack threshold, ranging from 1 to 19,999. The unit is pps.</p>
Command Mode	NFPP configuration mode
Usage Guide	N/A

✚ Configuring ICMP-Guard Trusted Hosts

Command	icmp-guard trusted-host <i>ip mask</i>
Parameter	<i>ip</i> : Indicates the IP address.

Description	<p><i>mask</i>: Indicates the mask of an IP address.</p> <p>all: Used with no to delete all trusted hosts.</p>
Command Mode	NFPP configuration mode
Usage Guide	<p>If you do not want to monitor a host, you can run this command to trust the host. This trusted host can send ICMP packets to the CPU, without any rate limiting or alarm reporting. You can configure the mask so that no host in one network segment is monitored.</p> <p>You can configure a maximum of 500 trusted hosts.</p>

▾ Enabling ICMP Guard on an Interface

Command	nfpp icmp-guard enable
Parameter Description	N/A
Command Mode	Interface configuration mode
Usage Guide	ICMP guard configured in interface configuration mode takes priority over that configured in NFPP configuration mode.

▾ Configuring the ICMP-Guard Isolation Period on an Interface

Command	nfpp icmp-guard isolate-period [<i>seconds</i> permanent]
Parameter Description	<p><i>seconds</i>: Indicates the isolation period in the unit of second. It can be set to 0 or any value from 30 to 86,400. The value 0 indicates no isolation.</p> <p>permanent: Indicates permanent isolation.</p>
Command Mode	Interface configuration mode
Usage Guide	N/A

▾ Configuring the ICMP-Guard Rate Limit and Attack Threshold on an Interface

Command	nfpp icmp-guard policy { per-src-ip per-port } <i>rate-limit-pps</i> <i>attack-threshold-pps</i>
Parameter Description	<p>per-src-ip: Configures the rate limit and attack threshold of each source IP address.</p> <p>per-port: Configures the rate limit and attack threshold of each port.</p> <p><i>rate-limit-pps</i>: Indicates the rate limit, ranging from 1 to 19,999.</p> <p><i>attack-threshold-pps</i>: Indicates the attack threshold, ranging from 1 to 19,999.</p>
Command Mode	Interface configuration mode
Usage Guide	The attack threshold must be equal to or greater than the rate limit.

Configuration Example

▾ CPU Protection Based on ICMP Guard

Scenario	<ul style="list-style-type: none"> ICMP host attacks exist in the system, and some hosts cannot successfully ping devices. Packet traffic of some hosts is very large in the system, and these packets need to pass through.
Configuration Steps	<ul style="list-style-type: none"> Configure the host-based attack threshold. Set the isolation period to a non-zero value.

	<ul style="list-style-type: none"> ● Configure trusted hosts.
	<pre>FS# configure terminal FS(config)# nfpp FS (config-nfpp)#icmp-guard rate-limit per-src-ip 20 FS (config-nfpp)#icmp-guard attack-threshold per-src-ip 30 FS (config-nfpp)#icmp-guard isolate-period 180 FS (config-nfpp)#icmp-guard trusted-host 192.168.201.46 255.255.255.255</pre>
Verification	<ul style="list-style-type: none"> ● Run the show nfpp icmp-guard summary command to display the configuration.
	<pre>(Format of column Rate-limit and Attack-threshold is per-src-ip/per-src-mac/per-port.) Interface Status Isolate-period Rate-limit Attack-threshold Global Disable 180 20/-/400 30/-/400 Maximum count of monitored hosts: 1000 Monitor period: 600s</pre>
	<ul style="list-style-type: none"> ● Run the show nfpp icmp-guard hosts command to display the monitored hosts.
	<pre>If col_filter 1 shows '*', it means "hardware do not isolate host". VLAN interface IP address remain-time(s) ----- - 1 Gi0/5 192.168.201.47 160 Total: 1 host</pre>
	<ul style="list-style-type: none"> ● Run the show nfpp icmp-guard trusted-host command to display the trusted hosts.
	<pre>IP address mask ----- 192.168.201.46 255.255.255.255 Total: 1 record(s)</pre>

Common Errors

N/A

11.4.4Configuring DHCP Guard

Configuration Effect

- DHCP attacks are identified based on hosts or ports. In host-based attack identification, DHCP attacks are identified based on the link-layer source IP address, VLAN ID, and port. Each type of attack identification has a rate limit and an attack threshold. If the DHCP packet rate exceeds the rate limit, the packets beyond the rate limit are discarded. If the DHCP packet rate exceeds the attack threshold, the system prints alarm information and sends traps. In host-based attack identification, the system also isolates the attack source.

- Configure DHCP guard isolation to assign hardware-isolated entries against host attacks so that attack packets are neither sent to the CPU nor forwarded.

Notes

- For a command that is configured both in NFPP configuration mode and interface configuration mode, the configuration in interface configuration mode takes priority over that configured in NFPP configuration mode.
- Isolation is disabled by default. If isolation is enabled, attackers will occupy hardware entries of the security module.
- For trusted ports configured for DHCP snooping, DHCP guard does not take effect, preventing false positive of DHCP traffic on the trusted ports. For details about trusted ports of DHCP snooping, see "Configuring Basic Functions of DHCP Snooping" in the Configuring DHCP Snooping.

Configuration Steps

↘ Enabling DHCP Guard

- (Mandatory) DHCP guard is enabled by default.
- This function can be enabled in NFPP configuration mode or interface configuration mode.
- If DHCP guard is disabled, the system automatically clears monitored hosts.

↘ Configuring the DHCP-Guard Isolation Period

- (Optional) DHCP-guard isolation is disabled by default.
- If the packet traffic of attackers exceeds the rate limit defined in CPP, you can configure the isolation period to discard packets and therefore to save bandwidth resources.
- The isolation period can be configured in NFPP configuration mode or interface configuration mode.
- If the isolation period is changed to 0, attackers under the corresponding port is deleted, instead of being monitored.

↘ Configuring the DHCP-Guard Monitoring Period

- (Mandatory) DHCP-guard monitoring is enabled by default.
- If the DHCP-guard isolation period is configured, it is directly used as the monitoring period, and the configured monitoring period will lose effect.
- The monitoring period can be configured in NFPP configuration mode.

↘ Configuring the Maximum Number of DHCP-Guard Monitored Hosts

- (Mandatory) The maximum number of DHCP-guard monitored hosts is 20,000 by default.
- Set the maximum number of DHCP-guard monitored hosts reasonably. As the number of monitored hosts increases, more CPU resources are used.
- The maximum number of DHCP-guard monitored hosts can be configured in NFPP configuration mode.
- If the number of monitored hosts reaches 20,000 (default value) and the administrator sets the maximum number lower than 20,000, the system does not delete monitored hosts but prints the log "%ERROR: The value that you configured is smaller than current monitored hosts 20000, please clear a part of monitored hosts." This information notifies the administrator that the configuration does not take effect and that some monitored hosts need to be deleted.

- If the table of monitored hosts is full, the system prints the log "% NFPP_DHCP_GUARD-4-SESSION_LIMIT: Attempt to exceed limit of 20000 monitored hosts." to notify the administrator.

➤ **Configuring the DHCP-Guard Attack Threshold**

- Mandatory.
- The attack threshold can be configured in NFPP configuration mode or interface configuration mode.
- If the configured rate limit is greater than the attack threshold, the system prints the log "%ERROR: rate limit is higher than attack threshold 500pps." to notify the administrator.
- If the configured attack threshold is less than the rate limit, the system prints the log "%ERROR: attack threshold is smaller than rate limit 300pps." to notify the administrator.
- If the memory cannot be allocated to detected attackers, the system prints the log "%NFPP_DHCP_GUARD-4-NO_MEMORY: Failed to alloc memory." to notify the administrator.
- Source MAC address-based rate limiting takes priority over port-based rate limiting.

Verification

When a host in the network sends DHCP attack packets to a switch configured with DHCP guard, check whether these packets can be sent to the CPU.

- If the parameter of the packets exceeds the attack threshold, an attack log is displayed.
- If an isolated entry is created for the attacker, an isolation log is displayed.

Related Commands

➤ **Enabling DHCP Guard Globally**

Command	dhcp-guard enable
Parameter	N/A
Description	
Command Mode	NFPP configuration mode
Usage Guide	N/A

➤ **Configuring the Global DHCP-Guard Isolation Period**

Command	dhcp-guard isolate-period [<i>seconds</i> permanent]
Parameter Description	<i>seconds</i> : Indicates the isolation period in the unit of second. It can be set to 0 or any value from 30 to 86,400. The value 0 indicates no isolation. permanent : Indicates permanent isolation.
Command Mode	NFPP configuration mode
Usage Guide	The attacker isolation period falls into two types: global isolation period and port-based isolation period (local isolation period). For a port, if the port-based isolation period is not configured, the global isolation period is used; otherwise, the port-based isolation period is used.

➤ **Configuring the Global DHCP-Guard Monitoring Period**

Command	dhcp-guard monitor-period <i>seconds</i>
Parameter Description	<i>seconds</i> : Indicates the monitoring period in the unit of second. The value ranges from 180 to 86,400.
Command Mode	NFPP configuration mode
Usage Guide	<p>If the isolation period is 0, the system performs software monitoring on detected attackers. The timeout period is the monitoring period. During software monitoring, if the isolation period is set to a non-zero value, the system automatically performs hardware isolation against monitored attackers and sets the timeout period as the monitoring period. The monitoring period is valid only when the isolation period is 0.</p> <p>If the isolation period is changed to 0, attackers under the corresponding port is deleted, instead of being monitored.</p>

⤵ Configuring the Maximum Number of DHCP-Guard Monitored Hosts

Command	dhcp-guard monitored-host-limit <i>number</i>
Parameter Description	<i>number</i> : Indicates the maximum number of monitored hosts, ranging from 1 to 4,294,967,295.
Command Mode	NFPP configuration mode
Usage Guide	<p>If the number of monitored hosts reaches 20,000 (default value) and the administrator sets the maximum number lower than 20,000, the system does not delete monitored hosts but prints the log "%ERROR: The value that you configured is smaller than current monitored hosts 20000, please clear a part of monitored hosts." This information notifies the administrator that the configuration does not take effect and that some monitored hosts need to be deleted.</p> <p>If the table of monitored hosts is full, the system prints the log "% NFPP_DHCP_GUARD-4-SESSION_LIMIT: Attempt to exceed limit of 20000 monitored hosts." to notify the administrator.</p>

⤵ Configuring the Global DHCP-Guard Rate Limit

Command	dhcp-guard rate-limit { per-src-mac per-port } <i>pps</i>
Parameter Description	<p>per-src-mac: Limits the rate of each source MAC address.</p> <p>per-port: Limits the rate of each port.</p> <p><i>pps</i>: Indicates the rate limit, ranging from 1 to 19,999.</p>
Command Mode	NFPP configuration mode
Usage Guide	N/A

⤵ Configuring the Global DHCP-Guard Attack Threshold

Command	dhcp-guard attack-threshold { per-src-mac per-port } <i>pps</i>
Parameter Description	<p>per-src-mac: Configures the attack threshold of each source MAC address.</p> <p>per-port: Configures the attack threshold of each port.</p> <p><i>pps</i>: Indicates the attack threshold, ranging from 1 to 19,999. The unit is pps.</p>
Command Mode	NFPP configuration mode
Usage Guide	N/A

➤ **Enabling DHCP Guard on an Interface**

Command	nfpp dhcp-guard enable
Parameter	N/A
Description	
Command Mode	Interface configuration mode
Usage Guide	DHCP guard configured in interface configuration mode takes priority over that configured in NFPP configuration mode.

➤ **Configuring the DHCP-Guard Isolation Period on an Interface**

Command	nfpp dhcp-guard isolate-period [<i>seconds</i> permanent]
Parameter Description	<i>seconds</i> : Indicates the isolation period in the unit of second. It can be set to 0 or any value from 30 to 86,400. The value 0 indicates no isolation. permanent : Indicates permanent isolation.
Command Mode	Interface configuration mode
Usage Guide	N/A

➤ **Configuring the DHCP-Guard Rate Limit and Attack Threshold on an Interface**

Command	nfpp dhcp-guard policy { per-src-mac per-port } <i>rate-limit-pps</i> <i>attack-threshold-pps</i>
Parameter Description	per-src-ip : Configures the rate limit and attack threshold of each source IP address. per-port : Configures the rate limit and attack threshold of each port. <i>rate-limit-pps</i> : Indicates the rate limit, ranging from 1 to 19,999. <i>attack-threshold-pps</i> : Indicates the attack threshold, ranging from 1 to 19,999.
Command Mode	Interface configuration mode
Usage Guide	The attack threshold must be equal to or greater than the rate limit.

Configuration Example

➤ **CPU Protection Based on DHCP Guard**

Scenario	<ul style="list-style-type: none"> DHCP host attacks exist in the system, and some hosts fail to request IP addresses.
Configuration Steps	<ul style="list-style-type: none"> Configure the host-based attack threshold. Set the isolation period to a non-zero value.
	<pre>FS# configure terminal FS(config)# nfpp FS (config-nfpp)#dhcp-guard rate-limit per-src-mac 8 FS (config-nfpp)#dhcp-guard attack-threshold per-src-mac 16 FS (config-nfpp)#dhcp-guard isolate-period 180</pre>
Verification	<ul style="list-style-type: none"> Run the show nfpp dhcp-guard summary command to display the configuration.
	(Format of column Rate-limit and Attack-threshold is per-src-ip/per-src-mac/per-port.)

<pre> Interface Status Isolate-period Rate-limit Attack-threshold Global Disable 180 -/8/150 -/16/300 Maximum count of monitored hosts: 1000 Monitor period: 600s </pre>
<ul style="list-style-type: none"> Run the show nfpp dhcp-guard hosts command to display the monitored hosts.
<pre> If col_filter 1 shows '*', it means "hardware do not isolate host". VLAN interface MAC address remain-time(s) ----- *1 Gi0/5 001a.a9c2.4609 160 Total: 1 host </pre>

Common Errors

N/A

11.4.5 Configuring DHCPv6 Guard

Configuration Effect

- DHCPv6 attacks are identified based on hosts or ports. In host-based attack identification, DHCPv6 attacks are identified based on the link-layer source IP address, VLAN ID, and port. Each type of attack identification has a rate limit and an attack threshold. If the DHCPv6 packet rate exceeds the rate limit, the packets beyond the rate limit are discarded. If the DHCPv6 packet rate exceeds the attack threshold, the system prints alarm information and sends traps.

Notes

- For a command that is configured both in NFPP configuration mode and interface configuration mode, the configuration in interface configuration mode takes priority over that configured in NFPP configuration mode.
- Isolation is disabled by default. If isolation is enabled, attackers will occupy hardware entries of the security module.
- For trusted ports configured for DHCPv6 snooping, DHCPv6 guard does not take effect, preventing false positive of DHCPv6 traffic on the trusted ports. For details about trusted ports of DHCPv6 snooping, see "Configuring Basic Functions of DHCPv6 Snooping" in the Configuring DHCPv6 Snooping.

Configuration Steps

➤ Enabling DHCPv6 Guard

- (Mandatory) DHCPv6 guard is enabled by default.
- DHCPv6 guard can be enabled in NFPP configuration mode or interface configuration mode.
- If DHCPv6 guard is disabled, the system automatically clears monitored hosts.

➤ Configuring the DHCPv6-Guard Monitoring Period

- (Mandatory) The default DHCPv6-guard monitoring period is 600 seconds.

- If the DHCPv6-guard isolation period is configured, it is directly used as the monitoring period, and the configured monitoring period does not take effect.
- The DHCPv6-guard monitoring period can be configured in NFPP configuration mode.

➤ **Configuring the Maximum Number of DHCPv6-Guard Monitored Hosts**

- (Mandatory) The maximum number of DHCPv6-guard monitored hosts is 20,000 by default.
- Set the maximum number of DHCPv6-guard monitored hosts reasonably. As the number of monitored hosts increases, more CPU resources are used.
- The maximum number of DHCPv6-guard monitored hosts can be configured in NFPP configuration mode.
- If the number of monitored hosts reaches 20,000 (default value) and the administrator sets the maximum number lower than 20,000, the system does not delete monitored hosts but prints the log "%ERROR: The value that you configured is smaller than current monitored hosts 20000, please clear a part of monitored hosts." This information notifies the administrator that the configuration does not take effect and that some monitored hosts need to be deleted.
- If the table of monitored hosts is full, the system prints the log "% NFPP_DHCPV6_GUARD-4-SESSION_LIMIT: Attempt to exceed limit of 20000 monitored hosts." to notify the administrator.

➤ **Configuring the DHCPv6-Guard Attack Threshold**

- Mandatory.
- The DHCPv6-guard attack threshold can be configured in NFPP configuration mode or interface configuration mode.
- If the configured rate limit is greater than the attack threshold, the system prints the log "%ERROR: rate limit is higher than attack threshold 500pps." to notify the administrator.
- If the configured attack threshold is less than the rate limit, the system prints the log "%ERROR: attack threshold is smaller than rate limit 300pps." to notify the administrator.
- If the memory cannot be allocated to detected attackers, the system prints the log "%NFPP_DHCPV6_GUARD-4-NO_MEMORY: Failed to alloc memory." to notify the administrator.
- Source MAC address-based rate limiting takes priority over port-based rate limiting.

Verification

When a host in the network sends DHCPv6 attack packets to a switch configured with DHCPv6 guard, check whether these packets can be sent to the CPU.

- If the parameter of the packets exceeds the attack threshold, an attack log is displayed.
- If an isolated entry is created for the attacker, an isolation log is displayed.

Related Commands

➤ **Enabling DHCPv6 Guard Globally**

Command	dhcpv6-guard enable
Parameter	N/A
Description	
Command Mode	NFPP configuration mode

Usage Guide	N/A
--------------------	-----

↘ Configuring the Global DHCPv6-Guard Monitoring Period

Command	dhcpv6-guard monitor-period <i>seconds</i>
Parameter Description	<i>seconds</i> : Indicates the monitoring period in the unit of second. The value ranges from 180 to 86,400.
Command Mode	NFPP configuration mode
Usage Guide	<p>If the isolation period is 0, the system performs software monitoring on detected attackers. The timeout period is the monitoring period. During software monitoring, if the isolation period is set to a non-zero value, the system automatically performs hardware isolation against monitored attackers and sets the timeout period as the monitoring period. The monitoring period is valid only when the isolation period is 0.</p> <p>If the isolation period is changed to 0, attackers under the corresponding port is deleted, instead of being monitored.</p>

↘ Configuring the Maximum Number of DHCPv6-Guard Monitored Hosts

Command	dhcpv6-guard monitored-host-limit <i>number</i>
Parameter Description	<i>number</i> : Indicates the maximum number of monitored hosts, ranging from 1 to 4,294,967,295.
Command Mode	NFPP configuration mode
Usage Guide	<p>If the number of monitored hosts reaches 20,000 (default value) and the administrator sets the maximum number lower than 20,000, the system does not delete monitored hosts but prints the log "%ERROR: The value that you configured is smaller than current monitored hosts 20000, please clear a part of monitored hosts." This information notifies the administrator that the configuration does not take effect and that some monitored hosts need to be deleted.</p> <p>If the table of monitored hosts is full, the system prints the log "% NFPP_DHCPV6_GUARD-4-SESSION_LIMIT: Attempt to exceed limit of 20000 monitored hosts." to notify the administrator.</p>

↘ Configuring the Global DHCPv6-Guard Rate Limit

Command	dhcpv6-guardrate-limit { per-src-mac per-port } <i>pps</i>
Parameter Description	<p>per-src-mac: Limits the rate of each source MAC address.</p> <p>per-port: Limits the rate of each port.</p> <p><i>pps</i>: Indicates the rate limit, ranging from 1 to 19,999.</p>
Command Mode	NFPP configuration mode
Usage Guide	N/A

↘ Configuring the Global DHCPv6-Guard Attack Threshold

Command	dhcpv6-guard attack-threshold { per-src-mac per-port } <i>pps</i>
Parameter Description	<p>per-src-mac: Configures the attack threshold of each source MAC address.</p> <p>per-port: Configures the attack threshold of each port.</p> <p><i>pps</i>: Indicates the attack threshold, ranging from 1 to 19,999. The unit is pps.</p>
Command	NFPP configuration mode

Mode	
Usage Guide	N/A

▾ **Enabling DHCPv6 Guard on an Interface**

Command	nfpp dhcpv6-guard enable
Parameter Description	N/A
Command Mode	Interface configuration mode
Usage Guide	DHCPv6 guard configured in interface configuration mode takes priority over that configured in NFPP configuration mode.

▾ **Configuring the DHCP-Guard Rate Limit and Attack Threshold on an Interface**

Command	nfpp dhcpv6-guard policy {per-src-mac per-port} rate-limit-pps attack-threshold-pps
Parameter Description	<p>per-src-ip: Configures the rate limit and attack threshold of each source IP address.</p> <p>per-port: Configures the rate limit and attack threshold of each port.</p> <p><i>rate-limit-pps:</i> Indicates the rate limit, ranging from 1 to 19,999.</p> <p><i>attack-threshold-pps:</i> Indicates the attack threshold, ranging from 1 to 19,999.</p>
Command Mode	Interface configuration mode
Usage Guide	The attack threshold must be equal to or greater than the rate limit.

Configuration Example

▾ **CPU Protection Based on DHCPv6 Guard**

Scenario	<ul style="list-style-type: none"> DHCPv6 host attacks exist in the system, and DHCPv6 neighbor discovery fails on some hosts.
Configuration Steps	<ul style="list-style-type: none"> Configure the host-based attack threshold. <pre> FS# configure terminal FS(config)# nfpp FS (config-nfpp)#dhcpv6-guard rate-limit per-src-mac 8 FS (config-nfpp)#dhcpv6-guard attack-threshold per-src-mac 16 </pre>
Verification	<ul style="list-style-type: none"> Run the show nfpp dhcpv6-guard summary command to display the configuration. <pre> (Formate of column Rate-limit and Attack-threshold is per-src-ip/per-src-mac/per-port.) Interface Status Rate-limit Attack-threshold Global Disable -/8/150 -/16/300 Maximum count of monitored hosts: 1000 Monitor period: 600s </pre>
	<ul style="list-style-type: none"> Run the show nfpp dhcpv6-guard hosts command to display the monitored hosts.

```

If col_filter 1 shows '*1', it means "hardware do not isolate host".
VLAN      interface   MAC address   remain-time(s)
-----
*1        Gi0/5       001a.a9c2.4609  160
Total: 1 host

```

Common Errors

N/A

11.4.6 Configuring ND Guard

Configuration Effect

- AR ND guard classifies ND packets into three types based on their purposes: 1. NS and NA; 2. RS; 3. RA and Redirect. Type 1 packets are used for address resolution. Type 2 packets are used by hosts to discover the gateway. Type 3 packets are related to routing: RAs are used to advertise the gateway and prefix while Redirect packets are used to advertise a better next hop.
- At present, only port-based ND packet attack identification is supported. You can configure the rate limits and attack thresholds for these three types of packets respectively. If the ND packet rate exceeds the rate limit, the packets beyond the rate limit are discarded. If the ND packet rate exceeds the attack threshold, the system prints logs and sends traps.

Notes

- For a command that is configured both in NFPP configuration mode and interface configuration mode, the configuration in interface configuration mode takes priority over that configured in NFPP configuration mode.

Configuration Steps

▾ Enabling ND Guard

- (Mandatory) ND guard is enabled by default.
- This function can be enabled in NFPP configuration mode or interface configuration mode.

▾ Enabling ND-Guard Ratelimit Forwarding

- (Optional) This function is enabled by default.
- If the port-based isolation entry takes effect, you can enable this function to pass some of the packets while not discarding all of them.
- This function can be enabled in NFPP configuration mode.

▾ Configuring the ND-Guard Attack Threshold

- Mandatory.
- The ND-guard attack threshold can be enabled in NFPP configuration mode or interface configuration mode.
- If the configured rate limit is greater than the attack threshold, the system prints the log "%ERROR: rate limit is higher than attack threshold 500pps." to notify the administrator.

- If the configured attack threshold is less than the rate limit, the system prints the log "%ERROR: attack threshold is smaller than rate limit 300pps." to notify the administrator.
- If memories cannot assigned to detected attackers, the system prints the log "%NFPP_ND_GUARD-4-NO_MEMORY: Failed to alloc memory." to notify the administrator.

Verification

When a host in the network sends ND attack packets to a switch configured with ND guard, check whether these packets can be sent to the CPU.

- If the parameter of the packets exceeds the attack threshold, an attack log is displayed.

Related Commands

↘ **Enabling ND Guard Globally**

Command	nd-guard enable
Parameter	N/A
Description	
Command Mode	NFPP configuration mode
Usage Guide	N/A

↘ **Enabling ND-Guard Ratelimit Forwarding**

Command	nd-guard ratelimit-forwarding enable
Parameter	N/A
Description	
Command Mode	NFPP configuration mode
Usage Guide	N/A

↘ **Configuring the Global ND-Guard Rate Limit**

Command	nd-guard rate-limit per-port [ns-na rs ra-redirect] pps
Parameter	ns-na: Indicates NSs and NAs.
Description	rs: Indicates RSs. ra-redirect: Indicates RAs and Redirect packets. pps: Indicates the rate limit, ranging from 1 to 19,999.
Command Mode	NFPP configuration mode
Usage Guide	N/A

↘ **Configuring the Global ND-Guard Attack Threshold**

Command	nd-guard attack-threshold per-port[ns-na rs ra-redirect] pps
Parameter	ns-na: Indicates NSs and NAs.
Description	rs: Indicates RSs. ra-redirect: Indicates RAs and Redirect packets. pps: Indicates the attack threshold, ranging from 1 to 19,999. The unit is pps.

Command	NFPP configuration mode
Mode	
Usage Guide	The attack threshold must be equal to or greater than the rate limit.

📌 **Enabling ND Guard on an Interface**

Command	nfpp nd-guard enable
Parameter	N/A
Description	
Command	Interface configuration mode
Mode	
Usage Guide	ND guard configured in interface configuration mode takes priority over that configured in NFPP configuration mode.

📌 **Configuring the ND-Guard Rate Limit and Attack Threshold on an Interface**

Command	nfpp nd-guard policy per-port [ns-na rs ra-redirect] rate-limit-pps attack-threshold-pps
Parameter	ns-na: Indicates NSs and NAs.
Description	rs: Indicates RSs. ra-redirect: Indicates RAs and Redirect packets. <i>rate-limit-pps:</i> Indicates the rate limit, ranging from 1 to 19,999. <i>attack-threshold-pps:</i> Indicates the attack threshold, ranging from 1 to 19,999.
Command	Interface configuration mode
Mode	
Usage Guide	The attack threshold must be equal to or greater than the rate limit.

Configuration Example

📌 **CPU Protection Based on ND Guard**

Scenario	<ul style="list-style-type: none"> ND host attacks exist in the system, and neighbor discovery fails on some hosts.
Configuration Steps	<ul style="list-style-type: none"> Configure the host-based attack threshold.
	<pre>FS# configure terminal FS(config)# nfpp FS (config-nfpp)# nd-guard rate-limit per-port ns-na 30 FS (config-nfpp)# nd-guard attack-threshold per-port ns-na 50</pre>
Verification	<ul style="list-style-type: none"> Run the show nfpp nd-guard summary command to display the configuration.
	<pre>(Format of column Rate-limit and Attack-threshold is NS-NA/RS/RA-REDIRECT.) Interface Status Rate-limit Attack-threshold Global Disable 30/15/15</pre>

Common Errors

N/A

11.4.7 Configuring a Self-Defined Guard

Configuration Effect

- Configure a self-defined guard to resolve network attack problems in special scenarios.

Notes

- For a command that is configured both in self-defined guard configuration mode and interface configuration mode, the configuration in interface configuration mode takes priority over that configured in self-defined guard configuration mode.
- A self-defined guard takes priority over basic guards. When configuring the match fields of self-defined guards, see the Configuration Guide.

Configuration Steps

▾ Configuring the Guard Name

- (Mandatory) Configure the name of a self-defined guard to create the self-defined guard.
- The guard name must be unique, and the match fields and values must be different from those of ARP, ICMP, DHCP, IP, and DHCPv6 guards. If the parameters you want to configure already exist, a message is displayed to indicate the configuration failure.

▾ Configuring the Match Fields

- Mandatory.
- Self-defined packets are classified based on the following fields: **etype** (Ethernet link-layer type), **smac** (source MAC address), **dmac** (destination MAC address), **protocol** (IPv4/IPv6 protocol number), **src-ip** (source IPv4/IPv6 address), **dip** (destination IPv4/IPv6 address), **sport** (source transport-layer port), and **dport** (destination transport-layer port).
- **protocol** is valid only when the value of **etype** is **ipv4** or **ipv6**. **src-ip** and **dst-ip** are valid only when the value of **etype** is **ipv4**. **src-ipv6** and **dst-ipv6** are valid only when the value of **etype** is **ipv6**. **src-port** and **dst-port** are valid only when the value of **protocol** is **tcp** or **udp**.
- If the **match** fields and values of a self-defined guard are totally the same as those of an existing guard, the system prints the log "%ERROR: the match type and value are the same with define name (name of an existing guard)." to notify the administrator of the configuration failure.
- If **protocol** is configured but **etype** is IPv4 or IPv6 in the **match** policy, the system prints the log "%ERROR: protocol is valid only when etype is IPv4(0x0800) or IPv6(0x86dd)."
- If **src-ip** and **dst-ip** are configured but **etype** is not IPv4 in the **match** policy, the system prints the log "%ERROR: IP address is valid only when etype is IPv4(0x0800)."
- If **src-ipv6** and **dst-ipv6** are configured but **etype** is not IPv6 in the **match** policy, the system prints the log "%ERROR: IPv6 address is valid only when etype is IPv6(0x86dd)."
- If **src-port** and **dst-port** are configured but **protocol** is not TCP or UDP in the **match** policy, the system prints the log "%ERROR: Port is valid only when protocol is TCP(6) or UDP(17)."
- The following table lists guard policies corresponding to some common network protocols. The rate limits and attack thresholds listed below can meet the requirements in most network scenarios and are for reference only. You can configure valid rate limits and attack thresholds based on actual scenarios.

Protocol	match	policy per-src-ip	policy per-src-mac	policy per-port
RIP	etype 0x0800 protocol 17 dst-port 520	rate-limit 100 attach-threshold 150	Not applicable to this policy	rate-limit 300 attach-threshold 500
RIPng	etype 0x86dd protocol 17 dst-port 521	rate-limit 100 attach-threshold 150	Not applicable to this policy	rate-limit 300 attach-threshold 500
BGP	etype 0x0800 protocol 6 dst-port 179	rate-limit 1000 attach-threshold 1200	Not applicable to this policy	rate-limit 2000 attach-threshold 3000
BPDU	dst-mac 0180.c200.0000	Not applicable to this policy	rate-limit 20 attach-threshold 40	rate-limit 100 attach-threshold 100
RERP	dst-mac 01d0.f800.0001	Not applicable to this policy	rate-limit 20 attach-threshold 40	rate-limit 100 attach-threshold 100
REUP	dst-mac 01d0.f800.0007	Not applicable to this policy	rate-limit 20 attach-threshold 40	rate-limit 100 attach-threshold 100
BGP	etype 0x0800 protocol 6 dst-port 179	Not applicable to this policy	Not applicable to this policy	Not applicable to this policy
OSPFv2	etype 0x0800 protocol 89	rate-limit 800 attach-threshold 1200	Not applicable to this policy	rate-limit 2000 attach-threshold 3000
OSPFv3	etype 0x86dd protocol 89	rate-limit 800 attach-threshold 1200	Not applicable to this policy	rate-limit 2000 attach-threshold 3000
VRRP	etype 0x0800 protocol 112	rate-limit 64 attach-threshold 100	Not applicable to this policy	rate-limit 1024 attach-threshold 1024
IPv6 VRRP	etype 0x86dd protocol 112	rate-limit 64 attach-threshold 100	Not applicable to this policy	rate-limit 1024 attach-threshold 1024
SNMP	etype 0x0800 protocol 17 dst-port 161	rate-limit 1000 attach-threshold 1200	Not applicable to this policy	rate-limit 2000 attach-threshold 3000
RSVP	etype 0x0800 protocol 46	rate-limit 800 attach-threshold 1200	Not applicable to this policy	rate-limit 1200 attach-threshold 1500
LDP (UDP hello)	etype 0x0800 protocol 17 dst-port 646	rate-limit 10 attach-threshold 15	Not applicable to this policy	rate-limit 100 attach-threshold 150

- To contain as many existing protocol types as possible and facilitate expansion of new protocol types, self-defined guards allow hosts to freely combine type fields of packets. If the configuration is inappropriate, the network may become abnormal. Therefore, the network administrator needs to have a good knowledge of network protocols. As a reference, the following table lists valid configurations of currently known protocols for common self-defined guard policies. For other protocols not listed in the table, configure them with caution.

📌 Configuring the Global Rate Limit and Attack Threshold

- (Mandatory) If these parameters are not configured, the self-defined guard cannot be enabled.

- You must configure one of the per-src-ip, per-src-mac, and per-port fields. Otherwise, the policy cannot take effect.
- per-src-ip is valid only when etype is IPv4 or IPv6.
- The rate limit configured based on the source MAC address, VLAN ID, and port takes priority over that configured based on the source IP address, VLAN ID, and port.
- The port-based host identification policy of a self-defined guard must be consistent with the global port-based host identification policy.
- If the **per-src-ip** policy is not configured globally but configured for a port, the system prints the log "%ERROR: name (name of a self-defined guard) has not per-src-ip policy." to notify the administrator of the configuration failure.
- If the **per-src-mac** policy is not configured globally but configured for a port, the system prints the log "%ERROR: name (name of a self-defined guard) has not per-src-mac policy." to notify the administrator of the configuration failure.
- If the memory cannot be allocated to detected attackers, the system prints the log "%NFPP_DEFINE_GUARD-4-NO_MEMORY: Failed to allocate memory." to notify the administrator.
- If the configured rate limit is greater than the attack threshold, the system prints the log "%ERROR: rate limit is higher than attack threshold 500pps." to notify the administrator.
- If the configured attack threshold is less than the rate limit, the system prints the log "%ERROR: attack threshold is smaller than rate limit 300pps." to notify the administrator.

▾ **Configuring the Global Monitoring Period**

- (Mandatory) The default monitoring period is 600 seconds.
- If the isolation period is configured, it is directly used as the monitoring period, and the configured monitoring period will lose effect.
- The monitoring period can be configured in self-defined guard configuration mode.
- If the isolation period is 0, the system performs software monitoring on detected attackers. The timeout period is the monitoring period. During software monitoring, if the isolation period is set to a non-zero value, the system automatically performs hardware isolation against monitored attackers and sets the timeout period as the monitoring period. The monitoring period is valid only when the isolation period is 0.
- If the isolation period is changed to 0, attackers under the corresponding port is deleted, instead of being monitored.

▾ **Configuring the Maximum Number of Monitored Hosts**

- (Mandatory) The maximum number of monitored hosts is 20,000 by default.
- Set the maximum number of monitored hosts reasonably. As the number of monitored hosts increases, more CPU resources are used.
- The maximum number of monitored hosts can be configured in self-defined guard configuration mode.
- If the number of monitored hosts reaches 20,000 (default value) and the administrator sets the maximum number lower than 20,000, the system does not delete monitored hosts but prints the log "%ERROR: The value that you configured is smaller than current monitored hosts 20000, please clear a part of monitored hosts." This information notifies the administrator that the configuration does not take effect and that some monitored hosts need to be deleted.
- If the table of monitored hosts is full, the system prints the log "% NFPP_DEFINE-4-SESSION_LIMIT: Attempt to exceed limit of name's 20000 monitored hosts." to notify the administrator.

↘ **Configuring Trusted Hosts**

- (Optional) No trusted host is configured by default.
- You can configure a maximum of 500 trusted IP address or MAC address for a self-defined guard.
- Trusted hosts can be configured in self-defined guard configuration mode.
- If you do not want to monitor a host, you can run the following commands to trust the host. This trusted host can send ICMP packets to the CPU, without any rate limiting or alarm reporting. You can configure the mask so that no host in one network segment is monitored.
- You must configure the **match** type before configuring trusted hosts. If the packet type is IPv4 in the **match** policy, you are not allowed to configure trusted IPv6 addresses. If the packet type is IPv6 in the match policy, you are not allowed to configure trusted IPv4 addresses.
- If the **match** type is not configured, the system prints the log "%ERROR: Please configure match rule first."
- If a trusted IPv4 host is added but **etype** is not IPv4 in the **match** policy, the system prints the log "%ERROR: Match type can't support IPv4 trusted host."
- If a trusted IPv6 host is added but **etype** is not IPv6 in the **match** policy, the system prints the log "%ERROR: Match type can't support IPv6 trusted host."
- If the table of trusted hosts is full, the system prints the log "%ERROR: Attempt to exceed limit of 500 trusted hosts." to notify the administrator.
- If any entry matching a trusted host (IP addresses are the same) exists in the table of monitored hosts, the system automatically deletes this entry.
- If a trusted host cannot be deleted, the system prints the log "%ERROR: Failed to delete trusted host 1.1.1.0 255.255.255.0." to notify the administrator.
- If a host cannot be trusted, the system prints the log "%ERROR: Failed to add trusted host 1.1.1.0 255.255.255.0." to notify the administrator.
- If the host to trust already exists, the system prints the log "%ERROR: Trusted host 1.1.1.0 255.255.255.0 has already been configured." to notify the administrator.
- If the host to delete from the trusted table does not exist, the system prints the log "%ERROR: Trusted host 1.1.1.0 255.255.255.0 is not found." to notify the administrator.
- If the memory cannot be allocated to a trusted host, the system prints the log "%ERROR: Failed to allocate memory." to notify the administrator.

↘ **Enabling a Self-Defined Guard**

- Mandatory.
- You have to configure at least one policy between host-based self-defined guard policy and port-based self-defined guard policy. Otherwise, the self-defined guard cannot be enabled.
- If a self-defined guard is disabled, the system automatically clears monitored hosts.
- Self-defined guards can be configured in self-defined guard configuration mode or interface configuration mode.
- If a self-defined guard policy is not completely configured, the self-defined guard cannot be enabled and a prompt is displayed to notify hosts of the missing policy configurations.

- If the name of a self-defined guard does not exist, the system prints the log "%ERROR: The name is not exist."
- If the match type is not configured for a self-defined guard, the system prints the log "%ERROR: name (name of the self-defined guard) doesn't match any type."
- If no policy is configured for a self-defined guard, the system prints the log "%ERROR: name (name of the self-defined guard) doesn't specify any policy."

Verification

When a host in the network sends packets to a switch configured with a self-defined NFPP guard, check whether these packets can be sent to the CPU.

- If the rate of packets from an untrusted host exceeds the attack threshold, an attack log is displayed.
- If an isolated entry is created for the attacker, an isolation log is displayed.

Related Commands

📌 **Configuring the Name of a Self-defined Guard**

Command	define <i>name</i>
Parameter Description	name: Indicates the name of a self-defined guard.
Command Mode	NFPP configuration mode
Usage Guide	N/A

📌 **Configuring Match Fields of a Self-defined Guard**

Command	match [<i>etype</i> <i>type</i>] [src-mac <i>smac</i> [src-mac-mask <i>smac_mask</i>]] [dst-mac <i>dmac</i> [dst-mac-mask <i>dst_mask</i>]] [protocol <i>protocol</i>] [src-ip <i>sip</i> [src-ip-mask <i>sip-mask</i>]] [src-ipv6 <i>sipv6</i> [src-ipv6-masklen <i>sipv6-masklen</i>]] [dst-ip <i>dip</i> [dst-ip-mask <i>dip-mask</i>]] [dst-ipv6 <i>dipv6</i> [dst-ipv6-masklen <i>dipv6-masklen</i>]] [src-ports <i>sport</i>] [dst-port <i>dport</i>]
Parameter Description	<i>type</i> : Indicates the type of Ethernet link-layer packets. <i>smac</i> : Indicates the source MAC address. <i>smac_mask</i> : Indicates the mask of the source MAC address. <i>dmac</i> : Indicates the destination MAC address. <i>dst_mask</i> : Indicates the mask of the destination MAC address. <i>protocol</i> : Indicates the protocol number of IPv4/IPv6 packets. <i>sip</i> : Indicates the source IPv4 address. <i>sip-mask</i> : Indicates the mask of the source IPv4 address. <i>sipv6</i> : Indicates the source IPv6 address. <i>sipv6-masklen</i> : Indicates the mask length of the source IPv6 address. <i>dip</i> : Indicates the destination IPv4 address. <i>dip-mask</i> : Indicates the mask of the destination IPv4 address. <i>dipv6</i> : Indicates the destination IPv6 address. <i>dipv6-masklen</i> : Indicates the mask length of the destination IPv6 address. <i>sport</i> : Indicates the ID of the source transport-layer port. <i>dport</i> : Indicates the ID of the destination transport-layer port.
Command	Self-defined guard configuration mode

Mode	
Usage Guide	Create a new self-defined guard and specify the packet fields matched by this guard.

✚ Configuring the Global Rate Limit and Attack Threshold of a Self-defined Guard

Command	global-policy { per-src-ip per-src-mac per-port } <i>rate-limit-pps attack-threshold-pps</i>
Parameter Description	<p>per-src-ip: Collects rate statistics for host identification based on the source IP address, VLAN ID, and port.</p> <p>per-src-mac: Collects rate statistics for host identification based on the source MAC address, VLAN ID, and port.</p> <p>per-port: Collects rate statistics based on each packet receiving port.</p> <p><i>rate-limit-pps</i>: Indicates the rate limit.</p> <p><i>attack-threshold-pps</i>: Indicates the attack threshold.</p>
Command Mode	Self-defined guard configuration mode
Usage Guide	Before creating a self-defined guard type, you must specify rate statistic classification rules for this type, namely, source IP address-based host identification, source MAC address-based host identification, host-based self-defined packet rate statistics, or port-based rate statistics, and specify the rate limits and attack thresholds for the specified rules.

✚ Configuring the Global Monitoring Period of a Self-defined Guard

Command	monitor-period <i>seconds</i>
Parameter Description	<i>seconds</i> : Indicates the monitoring period in the unit of second. The value ranges from 180 to 86,400.
Command Mode	Self-defined guard configuration mode
Usage Guide	N/A

✚ Configuring the Maximum Number of Monitored Hosts of a Self-defined Guard

Command	monitored-host-limit <i>number</i>
Parameter Description	<i>number</i> : Indicates the maximum number of monitored hosts, ranging from 1 to 4,294,967,295.
Command Mode	Self-defined guard configuration mode
Usage Guide	N/A

✚ Configuring Trusted Hosts of a Self-defined Guard

Command	trusted-host { <i>mac mac_mask</i> <i>ip mask</i> <i>IPv6/prefixlen</i> }
Parameter Description	<p><i>mac</i>: Indicates the MAC address.</p> <p><i>mac_mask</i>: Indicates the mask of an MAC address.</p> <p><i>ip</i>: Indicates the IP address.</p> <p><i>mask</i>: Indicates the mask of an IP address.</p> <p><i>IPv6/prefixlen</i>: Indicates the IPv6 address and its mask length.</p> <p>all: Used with no to delete all trusted hosts.</p>
Command Mode	Self-defined guard configuration mode

Usage Guide	N/A
--------------------	-----

▾ **Enabling a Self-Defined Guard Globally**

Command	define name enable
Parameter	<i>name</i> : Indicates the name of a self-defined guard.
Description	
Command Mode	NFPP configuration mode
Usage Guide	The configuration takes effect only after you have configured match , rate-count , rate-limit , and attack-threshold . Otherwise, the configuration fails.

▾ **Enabling a Self-defined Guard on an Interface**

Command	nfpp define name enable
Parameter	<i>name</i> : Indicates the name of a self-defined guard.
Description	
Command Mode	Interface configuration mode
Usage Guide	The self-defined name must exist. The configuration takes effect only after you have configured match , rate-count , rate-limit , and attack-threshold . Otherwise, the configuration fails.

▾ **Configuring the Rate Limit and Attack Threshold of a Self-defined Guard on an Interface**

Command	nfpp define name policy {per-src-ip per-src-mac per-port} rate-limit-pps attack-threshold-pps
Parameter	<i>name</i> : Indicates the name of a self-defined guard.
Description	<p>per-src-ip: Configures the rate limit and attack threshold of each source IP address.</p> <p>per-src-mac: Configures the rate limit and attack threshold of each source MAC address.</p> <p>per-port: Configures the rate limit and attack threshold of each port.</p> <p><i>rate-limit-pps</i>: Indicates the rate limit, ranging from 1 to 19,999.</p> <p><i>attack-threshold-pps</i>: Indicates the attack threshold, ranging from 1 to 19,999.</p>
Command Mode	Interface configuration mode
Usage Guide	The attack threshold must be equal to or greater than the rate limit.

Configuration Example

▾ **CPU Protection Based on a Self-Defined Guard**

Scenario	<ul style="list-style-type: none"> ● Basic guards cannot protect the system with RIP attacks.
Configuration Steps	<ul style="list-style-type: none"> ● Configure a self-defined guard, with the key fields matching RIP packets. ● Configure the rate limit. ● Configure trusted hosts.
	<pre>FS# configure terminal FS(config)# nfpp FS (config-nfpp)#define rip FS (config-nfpp-define)#match etype 0x0800 protocol 17 dst-port 520</pre>

	<pre>FS (config-nfpp-define)#global-policy per-src-ip 100 150 FS (config-nfpp-define)#trusted-host 192.168.201.46 255.255.255.255 FS (config-nfpp-define)#exit FS (config-nfpp)#define rip enable</pre>
Verification	<ul style="list-style-type: none"> ● Run the show nfpp define summary rip command to display the configuration.
	<pre>Define rip summary: match etype 0x800 protocol 17 dst-port 520 Maximum count of monitored hosts: 1000 Monitor period:600s (Format of column Rate-limit and Attack-threshold is per-src-ip/per-src-mac/per-port.) Interface Status Rate-limit Attack-threshold Global Enable 100/-/ 150/-/</pre>
	<ul style="list-style-type: none"> ● Run the show nfpp define trusted-host rip command to display the trusted hosts.
	<pre>Define rip: IP trusted host number is 1: IP address IP mask ----- 192.168.201.46 255.255.255.255 Total: 1 record(s)Global Enable 180 100/-/ 150/-/</pre>
	<ul style="list-style-type: none"> ● Run the show nfpp define hosts rip command to display the monitored hosts.
	<pre>If col_filter 1 shows '*', it means "hardware do not isolate host". VLAN interface IP address remain-time(s) --- 1 Gi0/5 192.168.201.47 160 Total: 1 host</pre>

Common Errors

N/A

11.4.8Configuring Centralized Bandwidth Allocation

Configuration Effect

- Configure centralized bandwidth allocation so that Manage and Protocol packets are first processed when the network is busy.

Notes

- The following condition must be met: Valid percentage range of a type of packets $\leq 100\%$ – Percentage of the sum of the other two types

Configuration Steps

➤ **Configuring the Maximum Bandwidth of Specified Packets**

- (Mandatory) Manage, Route, and Protocol packets share the same default bandwidth.

➤ **Configuring the Maximum Percentage of Specified Packets in the Queue**

- (Mandatory) By default, Manage packets occupy 30% of the bandwidth, Route packets occupy 25%, and Protocol packets occupy 45%.

Verification

Send a large number of protocol packets such as OSPF packets to a switch, causing high CPU utilization.

- When the host pings the switch, the pinging must be successful and no packet is lost.

Related Commands

➤ **Configuring the Maximum Bandwidth of Specified Packets**

Command	cpu-protect sub-interface { manage protocol route} pps <i>pps_value</i>
Parameter Description	<i>pps_value</i> : Indicates the rate limit, ranging from 1 to 100,000.
Command Mode	Global configuration mode
Usage Guide	N/A

➤ **Configuring the Maximum Percentage of Specified Packets in the Queue**

Command	cpu-protect sub-interface { manage protocol route} percent <i>percent_value</i>
Parameter Description	<i>percent_value</i> : Indicates the percentage of a type of packets in the queue, ranging from 1 to 100.
Command Mode	Global configuration mode
Usage Guide	The following condition must be met: Valid percentage range of a type of packets $\leq 100\%$ – Percentage of the sum of the other two types

Configuration Example

➤ **Prioritizing Packets Sent to the CPU Through Centralized Bandwidth Allocation**

Scenario	<ul style="list-style-type: none"> ● Various types of mass packets exist in the network and belong to different centralized types.
Configuration Steps	<ul style="list-style-type: none"> ● Configure the maximum bandwidth of specified packets. ● Configure the maximum percentage of specified packets in the queue.
	<pre>FS# configure terminal FS(config)# cpu-protect sub-interface manage pps 5000 FS(config)# cpu-protect sub-interface manage percent 25</pre>

Verification	N/A
---------------------	-----

Common Errors

N/A

11.4.9 Configuring NFPP Logging

Configuration Effect

- NFPP obtains a log from the dedicated log buffer at a certain rate, generates a system message, and clears this log from the dedicated log buffer.

Notes

- Logs are continuously printed in the log buffer, even if attacks have stopped.

Configuration Steps

↘ Configuring the Log Buffer Size

- Mandatory.
- If the log buffer is full, new logs replace the old ones.
- If the log buffer overflows, subsequent logs replace previous logs, and an entry with all attributes marked with a hyphen (-) is displayed in the log buffer. The administrator needs to increase the log buffer size or the system message generation rate.

↘ Configuring the Log Buffer Rate

- Mandatory.
- The log buffer rate depends on two parameters: the time period and the number of system messages generated in the time period.
- If both of the preceding two parameters are set to 0, system messages are immediately generated for logs but are not stored in the log buffer.

↘ Enabling Log Filtering

- (Optional) Log filtering is disabled by default.
- Logs can be filtered based on an interface or VLAN.
- If log filtering is enabled, logs not meeting the filtering rule are discarded.

↘ Enabling Log Printing

- (Mandatory) Logs are stored in the buffer by default.
- If you want to monitor attacks in real time, you can configure logs to be printed on the screen to export the log information in real time.

Verification

Check whether the configuration takes effect based on the log configuration and the number and interval of printed logs.

Related Commands

↘ Configuring the Log Buffer Size

Command	log-buffer entries <i>number</i>
Parameter	<i>number</i> : Indicates the buffer size in the unit of the number of logs, ranging from 0 to 1,024.
Description	
Command	NFPP configuration mode
Mode	
Usage Guide	N/A

↘ Configuring the Log Buffer Rate

Command	log-buffer logs <i>number_of_message interval length_in_seconds</i>
Parameter	<i>number_of_message</i> : Ranges from 0 to 1,024. The value 0 indicates that all logs are recorded in the log buffer and no system message is generated.
Description	<i>length_in_seconds</i> : Ranges from 0 to 86,400 (1 day). The value 0 indicates that logs are not recorded in the log buffer but system messages are instantly generated. This also applies to <i>number_of_message</i> and <i>length_in_seconds</i> . <i>number_of_message/length_in_second</i> indicates the system message generation rate.
Command	NFPP configuration mode
Mode	
Usage Guide	N/A

↘ Configuring VLAN-based Log Filtering

Command	logging vlan <i>vlan-range</i>
Parameter	<i>vlan-range</i> : Records logs in a specified VLAN range. The value format is 1-3,5 for example.
Description	
Command	NFPP configuration mode
Mode	
Usage Guide	Run this command to filter logs so that only logs in the specified VLAN range are recorded. Between interface-based log filtering and VLAN-based log filtering, if either rule is met, logs are recorded in the log buffer.

↘ Configuring Interface-based Log Filtering

Command	logging interface <i>interface-id</i>
Parameter	<i>interface-id</i> : Records logs of a specified interface.
Description	
Command	NFPP configuration mode
Mode	
Usage Guide	Run this command to filter logs so that only logs of the specified interface are recorded. Between interface-based log filtering and VLAN-based log filtering, if either rule is met, logs are recorded in the log buffer.

↘ Enabling Log Printing

Command	log-buffer enable
Parameter	N/A
Description	
Command	NFPP configuration mode
Mode	

Usage Guide	N/A
--------------------	-----

Configuration Example

▾ **Configuring NFPP Logging**

Scenario	<ul style="list-style-type: none"> ● If attackers are too many, log printing will affect the usage of user interfaces, which requires restriction.
Configuration Steps	<ul style="list-style-type: none"> ● Configure the log buffer size. ● Configure the log buffer rate. ● Configure VLAN-based log filtering.
	<pre>FS# configure terminal FS(config)# nfpp FS (config-nfpp)#log-buffer entries 1024 FS (config-nfpp)#log-buffer logs 3 interval 5 FS (config-nfpp)#logging interface vlan 1</pre>
Verification	<ul style="list-style-type: none"> ● Run the show nfpp log summary command to display the configuration.
	<pre>Total log buffer size : 1024 Syslog rate : 3 entry per 5 seconds Logging: VLAN 1</pre>
	<ul style="list-style-type: none"> ● Run the show nfpp log buffer command to display logs in the log buffer.
	<pre>Protocol VLAN Interface IP address MAC address Reason Timestamp ----- ARP 1 Gi0/5 192.168.206.2 001a.a9c2.4609 SCAN 2013-5-1 5:4:24</pre>

11.5 Monitoring

Clearing

Description	Command
Clears the ARP-guard scanning table.	clear nfpp arp-guard scan
Clears ARP-guard monitored hosts.	clear nfpp arp-guard hosts
Clears IP-guard monitored hosts.	clear nfpp ip-guard hosts
Clears ND-guard monitored hosts.	clear nfpp nd-guard hosts
Clears ICMP-guard monitored hosts.	clear nfpp icmp-guard hosts
Clears DHCP-guard monitored hosts.	clear nfpp dhcp-guard hosts
Clears DHCPv6-guard monitored hosts.	clear nfpp dhcpv6-guard hosts
Clears self-defined guard monitored hosts.	clear nfpp define <i>name</i> hosts
Clears NFPP logs.	clear nfpp log

Displaying

Description	Command
Displays ARP-guard configuration.	show nfpp arp-guard summary
Displays ARP-guard monitored hosts.	show nfpp arp-guard hosts
Displays the ARP-guard scanning table.	show nfpp arp-guard scan
Displays IP-guard configuration.	show nfpp ip-guard summary
Displays IP-guard monitored hosts.	show nfpp ip-guard hosts
Displays the IP-guard scanning table.	show nfpp ip-guard trusted-host
Displays ICMP-guard configuration.	show nfpp icmp-guard summary
Displays ICMP-guard monitored hosts.	show nfpp icmp-guard hosts
Displays the ICMP-guard scanning table.	show nfpp icmp-guard trusted-host
Displays DHCP-guard configuration.	show nfpp dhcp-guard summary
Displays DHCP-guard monitored hosts.	show nfpp dhcp-guard hosts
Displays DHCPv6-guard configuration.	show nfpp dhcpv6-guard summary
Displays DHCPv6-guard monitored hosts.	show nfpp dhcpv6-guard hosts
Displays ND-guard configuration.	show nfpp nd-guard summary
Displays self-defined guard configuration.	show nfpp define summary <i>[name]</i>
Displays the monitored hosts.	show nfpp define hosts <i>name</i>
Displays the trusted hosts.	show nfpp define trusted-host <i>name</i>
Displays NFPP logs.	show nfpp log summary
Displays the NFPP log buffer.	show nfpp log buffer <i>[statistics]</i>

12 Configuring Security Log

12.1 Overview

Security log is used to record the key operations on device so that each operation can be audited and traced afterwards, and to meet the national security standards.

Key operations include:

- 1) Adding/deleting an account
- 2) Editing authentication information
- 3) Changing configuration (DNS, IP, etc.)
- 4) User login/logout
- 5) Restarting/turning off a device
- 6) Uploading/downloading a file (when supported)
- 7) Editing user permissions (when supported)
- 8) Enabling/disabling log auditing, deleting log (when supported)

12.2 Applications

Application	Description
Enabling Security Log Auditing	Check recent key operations on devices; if any abnormal operation occurs, the admin can find out the operator, time and method.

12.2.1 Enabling Security Log Auditing

Scenario

After enabling the security log auditing, the device will record key operations including account management, log event, system event, configuration change and security log event. After logging in to the device, the admin can check which users have visited the device and what operation they performed.



Remarks	Admin logs in to the device and check the log of key operations.
---------	--

Deployment

- Enable the function to use.

12.3 Features

Basic Concepts

📌 Key Operation

After enabling the security log auditing, the device will record key operations including account management, log event, system event, configuration change and security log event. The record is stored for 180 days by default (the time can be customized).

Overview

Feature	Description
Enabling Security Log Auditing	Record the key operations on device.

12.3.1 Enabling Security Log Auditing

Enable to record key operation and store the log.

Working Principle

After enabling the security log auditing, related modules will record the time, username, IP, operation and results, etc. when the user performs key operations including account management, log event, restart, configuration change and security log event. The log will be stored in local database by log audit framework.

The log is stored for 180 days by default. At 3 am each day, the system will check and delete any log that expires.

At most 10,000 logs can be stored by default. After the log exceeds the storage limit, new logs will cover the old ones.

Related Configuration

📌 Enabling Security Log Auditing

By default, the security log auditing is enabled.

12.4 Configuration

Configuration Item	Description and Command
Configuring Security Log Auditing	Mandatory
	security-log audit-enable Enables log auditing.
Configuring Log Storage Time	Optional
	security-log data-store-days <i>day</i> Configures the local storage time of security log.
Configuring Aging Time of Security Log	Optional
	security-log auto-vacuum-time <i>hh:mm:ss</i> Configures the aging time of security log.
Configuring Local Storage Capacity of Security Log	Optional
	security-log data-store-items <i>num</i> Configures the local storage capacity of security log.

12.4.1 Configuring Security Log Auditing

Configuration Effect

After enabling the security log auditing, the device will record key operations including account management, log event, system event, configuration change and security log event.

Notes

N/A

Configuration Steps

▾ Enabling Security Log Auditing

- Mandatory
- Enabled on the device.

Verification

- Log in to the device, perform key operations, and check the log record.

Related Commands

▾ Enabling Security Log Auditing

Command	security-log audit-enable
Parameter Description	
Command Mode	Global configuration mode
Usage Guide	

Configuration Example

▾ Enabling Security Log Auditing

Configuration Steps	Enable security log auditing.
	<pre>FS# configure terminal FS(config)# security-log audit-enable</pre>
Verification	Log in to the device, perform key operations, and check the log record after 30 seconds.
SW1	<pre>FS# show security-log detail all time, username, peerinfo, hostname, log-type: content 2019-10-22 10:00:02, admin, vty0(192.168.111.111), FS, SEC_LOG: SECURITY_LOG deleted all security log successfully 2019-10-22 10:00:02, admin, vty0(192.168.111.111), FS, SEC_LOG: SECURITY_LOG disabled security log audit configuration unsuccessfully 2019-10-22 10:00:03, ---, console, FS, SEC_LOG: SECURITY_LOG enabled security log audit configuration successfully</pre>

12.4.2 Configuring Log Storage Time

Configuration Effect

Configure the log storage time. The log exceeds the time will be deleted.

Notes

N/A

Configuration Steps

▾ Configuring Log Storage Time

- Optional
- 180 days by default, range: 1-65535.

Verification

- Run the **show running-config** or **show security-log config** command to check configuration status.

Related Commands

▾ Configuring Log Storage Time

Command	security-log data-store-days <i>day</i>
Parameter	<i>day</i> : storage time, range: 1-65535. Default: 180 days.
Description	
Command Mode	Global configuration mode
Usage Guide	Run this command to configure the log storage time. The log exceeds the time will be deleted.

Configuration Example

▾ Configuring Log Storage Time

Configuration Steps	Configure the storage time as 300 days.
SW1	<pre>FS# configure terminal FS(config)# security-log data-store-days 300</pre>
Verification	Run the show running-config or show security-log config command to check configuration status.
SW1	<pre>FS# show running in security-log data-store-days security-log data-store-days 300 FS# show security-log config Security-log audit: enable Limit number: 10000 Store days: 300 Auto vacuum time: 03:00:00</pre>

12.4.3 Configuring Aging Time of Security Log

Configuration Effect

Configure the aging time of security log. The system will check and delete any log exceeding the storage time at the aging time (time error: 5 minutes).

Configuration Steps

▾ Configuring Aging Time of Security Log

- Optional
- 3 am every day by default.

Verification

- Run the **show running-config** or **show security-log config** command to check configuration status.

Related Commands

▾ Configuring Aging Time of Security Log

Command	security-log auto-vacuum-time <i>hh:mm:ss</i>
Parameter	<i>hh:mm:ss</i> : hour: minute: second. 03:00:00 by default.
Description	
Command Mode	Global configuration mode
Usage Guide	Run this command to configure the aging time of security log. The system will check and delete any log exceeding the storage time at the aging time (time error: 5 minutes).

Configuration Example

▾ Configuring Aging Time of Security Log

Configuration Steps	Configure the aging time as 5:05 am.
	<pre>FS# configure terminal FS(config)# security-log auto-vacuum-time 05:05:00</pre>
Verification	Run the show running-config or show security-log config command to check configuration status.
	<pre>FS# show running in security-log auto-vacuum-time security-log auto-vacuum-time 05:05:00 FS# show security-log config Security-log audit: enable Limit number: 10000 Store days: 300 Auto vacuum time: 05:05:00</pre>

12.4.4 Configuring Local Storage Capacity of Security Log

Configuration Effect

Configures the storage capacity of log. After the log exceeds the storage limit, new logs will cover the old ones.

Configuration Steps

▾ Configuring Local Storage Capacity of Security Log

- Optional
- The default value and max value vary with product capability (range: 500-10,000, default value: 10,000). The min value is 500.

Verification

- Run the **show running-config** or **show security-log config** command to check configuration status.

Related Commands

▾ Configuring Local Storage Capacity of Security Log

Command	security-log data-store-items num
Parameter Description	<i>Num</i> : local storage capacity. The default value and max value vary with product capability (range: 500-10,000, default value: 10,000). The min value is 500.
Command Mode	Global configuration mode
Usage Guide	If flash space is limited, run this command to decrease the storage capacity.

Configuration Example

▾ Configuring Local Storage Capacity of Security Log

Configuration Steps	Configure the local storage capacity of security log as 1000.
	<pre>FS# configure terminal FS(config)# security-log data-store-items 1000</pre>
Verification	Run the show running-config or show security-log config command to check configuration status.
	<pre>FS# show running in security-log data-store-items security-log data-store-items 1000 FS# show security-log config Security-log audit: enable Limit number: 1000 Store days: 300 Auto vacuum time: 05:05:00</pre>

12.5 Monitoring

Clearing

Description	Command
Deletes all logs	security-log delete all

Displaying

Description	Command
Displays all logs	show security-log
Displays the detailed log information which can be filtered by time, type, username, host name, etc.	show security-log detail { all { from yyyy mm dd hh:mm:ss to yyyy mm dd hh:mm:ss } } [log-type { SEC_LOG ACC_MNT LOGIN SYS CONFIG OTHER }] [user username] [hostname hostname] [peerinfo peerinfo] { [order-by [time log-type] { asc desc } [start-item integer1 end-item integer2]] }
Exports the detailed log information which can be filtered by time, type, username, host name, etc.	show security-log detail export { from yyyy mm dd hh:mm:ss to yyyy mm dd hh:mm:ss } [log-type { SEC_LOG ACC_MNT LOGIN SYS CONFIG OTHER }] [user username] [hostname hostname] [peername peername] [ip ip-address]
Displays the log statistics which can be filtered by time, type, username, host name, etc.	show security-log detail stat { all { from yyyy mm dd hh:mm:ss to yyyy mm dd hh:mm:ss } } [log-type { SEC_LOG ACC_MNT LOGIN SYS CONFIG OTHER }] [user username] [hostname hostname] [peerinfo peerinfo]
Displays the configuration information.	show security-log config
Displays the statistics information.	show security-log statistics
Displays the statistics information during log processing.	show security-log info

Debugging



System resources are occupied when debugging information is output. Therefore, disable debugging immediately after use.

Description	Command
Debugs the log auditing.	debug security-log errors
Debugs the received log.	debug security-log recv-info
Debugs the log database.	debug security-log sql-info

ACL & QoS Configuration

1. Configuring ACL
2. Configuring QoS
3. Configuring MMU

1 Configuring the ACL

1.1 Overview

Access control list (ACL) is also called access list or firewall. It is even called packet filtering in some documents. The ACL defines rules to determine whether to forward or drop data packets arriving at a network interface.

ACLs are classified by function into two types:

- Security ACLs: Used to control data flows that are allowed to pass through a network device.
- Quality of service (QoS) ACLs: Used to classify and process data flows by priority.

ACLs are configured for a lot of reasons. Major reasons include:

- Network access control: To ensure network security, rules are defined to limit access of users to some services (for example, only access to the WWW and email services is permitted, and access to other services such as Telnet is prohibited), or to allow users to access services in a specified period of time, or to allow only specified hosts to access the network.
- QoS: QoS ACLs are used to preferentially classify and process important data flows. For details about the use of QoS ACLs, see the configuration manual related to QoS.

1.2 Applications

Application	Description
Access Control of an Enterprise Network	On an enterprise network, the network access rights of each department, for example, access rights of servers and use permissions of chatting tools (such as QQ and MSN), must be controlled according to requirements.

1.2.1 Access Control of an Enterprise Network

Scenario

Internet viruses can be found everywhere. Therefore, it is necessary to block ports that are often used by viruses to ensure security of an enterprise network as follows:

- Allow only internal PCs to access the server.
- Prohibit PCs of a non-financial department from accessing PCs of the financial department, and prohibit PCs of a non-R&D department from accessing PCs of the R&D department.
- Prohibit the staff of the R&D department from using chatting tools (such as QQ and MSN) during working hours from 09:00 to 18:00.

Figure 1- 1

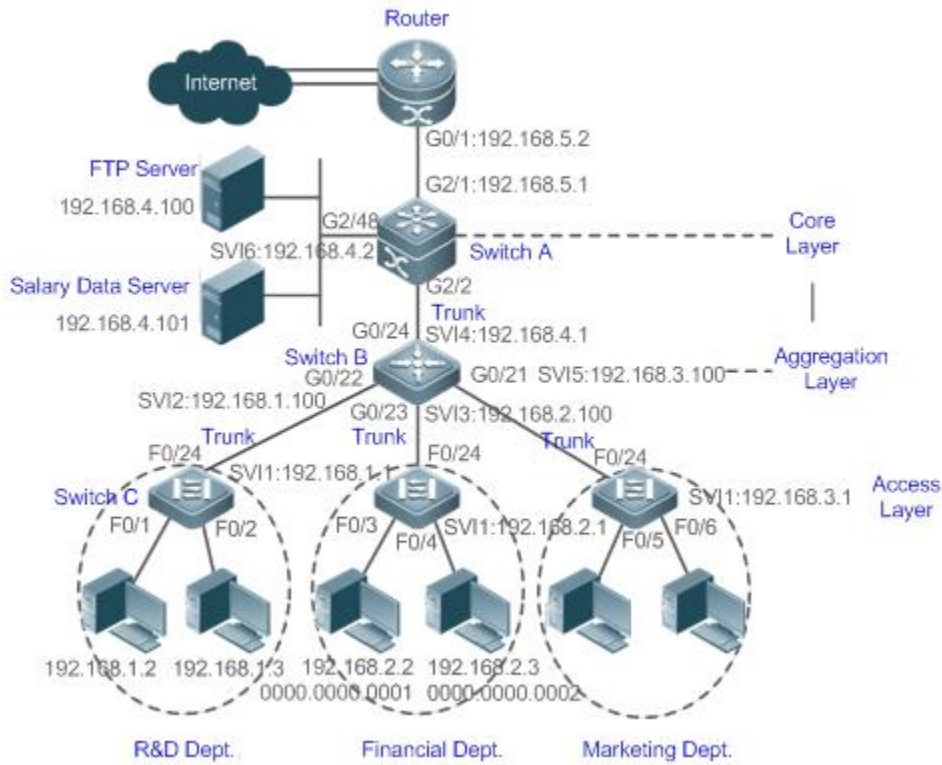

Remarks	<p>Switch C at the access layer:It is connected to PCs of each department and to Switch B at the aggregation layer through the gigabit optical fiber (trunk mode).</p> <p>Switch B at the aggregation layer:Multiple virtual local area networks (VLANs) are divided. One VLAN is defined for one department. These VLANs are connected to Switch A at the core layer through the 10-gigabit optical fiber (trunk mode).</p> <p>Switch A at the core layer:It is connected to various servers, such as the File Transfer Protocol (FTP) server and Hypertext Transfer Protocol (HTTP) server, and to the Internet through firewalls.</p>
----------------	--

Deployment

- Configure an extended ACL on the port G2/1 to filter data packets, thus protecting the network against the viruses. This port is located on a core-layer device (Switch A) and used to connect Switch A to the uplink port G2/1 of a router.
- Allow only internal PCs to access servers, and prohibit external PCs from accessing servers. Define and apply the extended IP ACLs on G2/2 or switch virtual interface (SVI) 2 that is used to connect Switch A to an aggregation layer device or server.
- Prohibit mutual access between specified departments. Define and apply the extended IP ACLs on G0/22 and G0/23 of Switch B.
- Configure and apply the time-based extended IP ACLs on SVI 2 of Switch B to prohibit the R&D department from using chatting tools (such as QQ and MSN) in a specified period of time.

1.3Features

Basic Concepts

➤ **ACL**

ACLs include basic ACLs and dynamic ACLs.

You can select basic or dynamic ACLs as required. Generally, basic ACLs can meet the security requirements. However, experienced hackers may use certain software to access the network by means of IP address spoofing. If dynamic ACLs are used, users are requested to pass identity authentication before accessing the network, which prevents hackers from intruding the network. Therefore, you can use dynamic ACLs in some sensitive areas to guarantee network security.

-  IP address spoofing is an inherent problem of all ACLs, including dynamic ACLs. Hackers may use forged IP addresses to access the network during the validity period of authenticated user identities. Two methods are available to resolve this problem. One is to set the idle time of user access to a smaller value, which increases the difficulty in intruding networks. The other is to encrypt network data using the IPSec protocol, which ensures that all data is encrypted when arriving at a device.

ACLs are generally configured on the following network devices:

- Devices between the internal network and the external network (such as the Internet)
- Devices on the border of two network segments
- Devices connected to controlled ports

ACL statements must be executed in strict compliance with their sequence in the ACL. Comparison starts from the first statement. Once the header of a data packet matches a statement in the ACL, the subsequent statements are ignored and no longer checked.

Input/Output ACLs, Filtering Field Template, and Rules

When receiving a packet on an interface, the device checks whether the packet matches any access control entry (ACE) in the input ACL of this interface. Before sending a packet through a interface, the device checks whether the packet matches any ACE in the output ACL of this interface.

When different filtering rules are defined, all or only some rules may be applied simultaneously. If a packet matches an ACE, this packet is processed according to the action policy (permit or deny) defined in this ACE. ACEs in an ACL identify Ethernet packets based on the following fields in the Ethernet packets:

Layer 2 (L2) fields:

- 48-bit source MAC address (containing all 48 bits)
- 48-bit destination MAC address (containing all 48 bits)
- 16-bit L2 type field

Layer 3 (L3) fields:

- Source IP address field (All source IP address values can be specified, or the subnet can be used to define a type of data flows.)
- Destination IP address field (All destination IP address values can be specified, or the subnet can be used to define a type of data flows.)
- Protocol type field

Layer 4 (L4) fields:

- Either a TCP source or destination port is specified, or both are specified, or the range of the source or destination port is specified.
- Either a UDP source or destination port is specified, or both are specified, or the range of the source or destination port is specified.

Filtering fields refer to the fields in packets that can be used to identify or classify packets when an ACE is generated. A filtering field template is a combination of these fields. For example, when an ACE is generated, packets are identified and classified based on the destination IP address field in each packet; when another ACE is generated, packets are identified and classified based on the source IP address field and UDP source port field in each packet. The two ACEs use different filtering field templates.

Rules refer to values of fields in the filtering field template of an ACE. For example, the content of an ACE is as follows:

```
permit tcp host 192.168.12.2 any eq telnet
```

In this ACE, the filtering field template is a combination of the following fields: source IP address field, IP protocol field, and TCP destination port field. The corresponding values (rules) are as follows: source IP address = Host 192.168.12.2; IP protocol = TCP; TCP destination port = Telnet.

Figure 1- 2 Analysis of the ACE: permit tcp host 192.168.12.2 any eq telnet

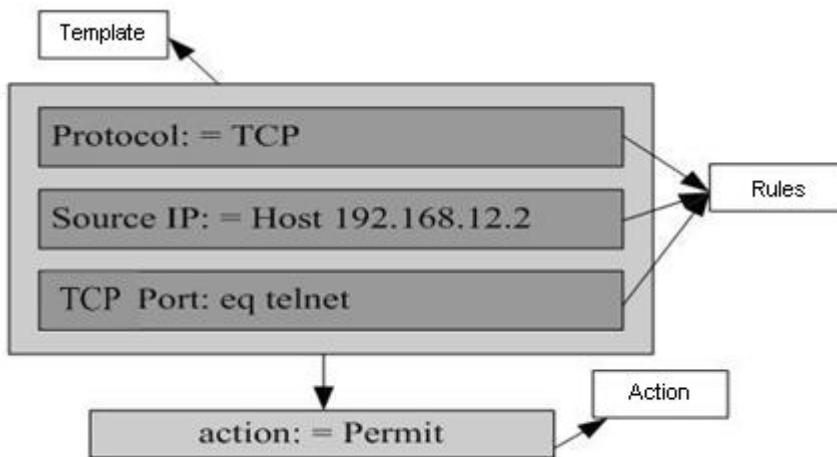

- i A filtering field template can be a combination of L3 and L4 fields, or a combination of multiple L2 fields. The filtering field template of a standard or an extended ACL, however, cannot be a combination of L2 and L3 fields, a combination of L2 and L4 fields, or a combination of L2, L3, and L4 fields. To use a combination of L2, L3, and L4 fields, you can use the expert ACLs.
- i An SVI associated with ACLs in the outgoing direction supports the IP standard, IP extended, MAC extended, and expert ACLs. If an MAC extended or expert ACL is configured to match the destination MAC address and is applied to the outgoing direction of the SVI, the related ACE can be configured but cannot take effect. If an IP extended or expert ACL is configured to match the destination IP address, but the destination IP address is not in the subnet IP address range of the associated SVI, the configured ACL cannot take effect. For example, assume that the address of VLAN 1 is **192.168.64.1 255.255.255.0**, an IP extended ACL is created, and the ACE is **deny udp any 192.168.65.1 0.0.0.255 eq 255**. If this ACL is applied to the outgoing interface of VLAN 1, the ACL cannot take effect because the destination IP address is not in the subnet IP address range of VLAN 1. If the ACE is **deny udp any 192.168.64.1 0.0.0.255 eq 255**, the ACL can take effect because the destination IP address is in the subnet IP address range of VLAN 1.

On a switch, if ACLs are applied to the outgoing direction of a physical port or an aggregate port (AP), the ACLs can filter only well-known packets (unicast or multicast packets), but not unknown unicast packets. That is, for unknown or broadcast packets, ACLs configured in the outgoing direction of a port does not take effect.

On a switch, if the input ACL and DOT1X, global IP+MAC binding, port security, and IP source guard are shared among all ports, the permit and default deny ACEs do not take effect, but other deny ACEs take effect.

On a switch, if the input ACL and QoS are shared, the permit ACEs do not take effect, other deny ACEs take effect, and the default deny ACE takes effect after the QoS ACE takes effect.

On a switch, you can run the **noFSOS-security compatible** command to make the permit and deny ACEs take effect at the same time when the port-based input ACL and DOT1X, global IP+MAC binding, port security, and IP source guard are shared.

If ACEs are added to an ACL and then the switch is restarted after an ACL is applied to the incoming direction of multiple SVIs, the ACL may fail to be configured on some SVIs due to the limited hardware capacity.

- i If an expert ACL is configured and applied to the outgoing direction of an interface, and some ACEs in this ACL contain the L3 matching information (e.g. the IP address and L4 port), non-IP packets sent to the device from this interface cannot be controlled by the permit and deny ACEs in this ACL.
- i If ACEs of an ACL (IP ACL or expert extended ACL) are configured to match non-L2 fields (such as SIP and DIP), the ACL does not take effect on tagged MPLS packets.

To allow users better learn the running status of ACLs on a device, you can determine whether to specify the ACL logging option as required when adding ACEs. If this option is specified, logs are output when packets matching ACEs are found. ACL logs are displayed based on ACEs. That is, the device periodically displays ACEs with matched packets and the number of matched packets. An example of the log is as follows:

```
*Sep  9 16:23:06: %ACL-6-MATCH: ACL 100 ACE 10 permit icmp any any, match 78 packets.
```

To control the amount of logs and output frequency, you can configure the log update interval respectively for the IPv4 ACL and the IPv6 ACL.

- ! An ACE containing the ACL logging option consumes more hardware resources. If all configured ACEs contain this option, the ACE capacity of a device will be reduced by half.
- i By default, the log update interval is 0, that is, no log is output. After the ACL logging option is specified in an ACE, you need to configure the log update interval to output related logs.
- i For an ACE containing the ACL logging option, if no packet is matched in the specified interval, no packet matching log related to this ACE will be output. If matched packets are found in the specified interval, packet matching logs related to this ACE will be output when the interval expires. The number of matched packets is the total number of packets that match the ACE during the specified interval, that is, the period from the previous log output to the current log output.
- i Only switches support the ACL logging function.

📌 ACL Packet Matching Counters

To implement network management, users may want to know whether an ACE has any matched packets and how many packets are matched. ACLs provide the ACE-based packet matching counters. You can enable or disable packet matching counters for all ACEs in an ACL, which can be an IP ACL, MAC ACL, expert ACL, or IPv6 ACL. In addition, you can run the **clear counters access-list [acl-id | acl-name]** command to reset ACL counters for a new round of statistics.

- ! Enabling ACL counters requires more hardware entries. In an extreme case, this will reduce by half the number of ACEs that can be configured on a device.
- i Only switches support the ACL packet matching counters.

Overview

Feature	Description
IP ACL	Control incoming or outgoing IPv4 packets of a device based on the L3 or L4 information in the IPv4 packet header.
MAC Extended ACL	Control incoming or outgoing L2 packets of a device based on the L2 information in the Ethernet packet header.

Feature	Description
Expert Extended ACL	Combine the IP ACL and MAC extended ACL into an expert extended ACL, which controls (permits or denies) incoming or outgoing packets of a device using the same rule based on the L2, L3, and L4 information in the packet header.
IPv6 ACL	Control incoming or outgoing IPv6 packets of a device based on the L3 or L4 information in the IPv6 packet header.
ACL80	Customize the matching fields and mask for scenarios where fixed matching fields cannot meet the requirements.
ACL Redirection	Redirect incoming packets of a device that match ACEs to a specified outgoing interface.
Global Security ACL	Make an ACL take effect in the incoming direction of all interfaces, instead of applying the ACL on every interface.
Security Channel	Allow packets to bypass the check of access control applications, such as DOT1X and Web authentication, to meet requirements of some special scenarios.
SVI Router ACL	Enable users in the same VLAN to communicate with each other.
ACL Logging	Output ACL packet matching logs at a specified interval according to requirements. The logs help users learn the packet matching result of a specified ACE.

1.3.1 IP ACL

The IP ACL implements refined control on incoming and outgoing IPv4 packets of a device. You can permit or deny the entry of specific IPv4 packets to a network according to actual requirements to control access of IP users to network resources.

Working Principle

Define a series of IP access rules in the IP ACL, and then apply the IP ACL either in the incoming or outgoing direction of an interface or globally. The device checks whether the incoming or outgoing IPv4 packets match the rules and accordingly forwards or blocks these packets.

To configure an IP ACL, you must specify a unique name or ID for the ACL of a protocol so that the protocol can uniquely identify each ACL. The following table lists the protocols that can use IDs to identify ACLs and the range of IDs.

Protocol	ID Range
Standard IP	1–99, 1300–1999
Extended IP	100–199, 2000–2699

Basic ACLs include the standard IP ACLs and extended IP ACLs. Typical rules defined in an ACL contain the following matching fields:

- Source IP address
- Destination IP address
- IP protocol number
- L4 source port ID or ICMP type
- L4 destination port ID or ICMP code

The standard IP ACL (ID range: 1–99, 1300–1999) is used to forward or block packets based on the source IP address, whereas the extended IP ACL (ID range: 100–199, 2000–2699) is used to forward or block packets based on a combination of the preceding matching fields.

For an individual ACL, multiple independent ACL statements can be used to define multiple rules. All statements reference the same ID or name so that these statements are bound with the same ACL. However, more statements mean that it is increasingly difficult to read and understand the ACL.

For routing products, the ICMP code matching field in an ACL rule is ineffective for ICMP packets whose ICMP type is 3. If the ICMP code of ICMP packets to be matched is configured in an ACL rule, the ACL matching result of incoming ICMP packets of a device whose ICMP type is 3 may be different from the expected result.

➤ Implicit "Deny All Traffic" Rule Statement

At the end of every IP ACL is an implicit "deny all traffic" rule statement. Therefore, if a packet does not match any rule, the packet will be denied.

For example:

```
access-list 1 permit host 192.168.4.12
```

This ACL permits only packets sent from the source host 192.168.4.12, and denies packets sent from all other hosts. This is because the following statement exists at the end of this ACL: **access-list 1 deny any**.

If the ACL contains only the following statement:

```
access-list 1 deny host 192.168.4.12
```

Packets sent from any host will be denied when passing through this port.

- ! When defining an ACL, you must consider the routing update packets. As the implicit "deny all traffic" statement exists at the end of an ACL, all routing update packets may be blocked.

➤ Input Sequence of Rule Statements

Every new rule is added to the end of an ACL and in front of the default rule statement. The input sequence of statements in an ACL is very important. It determines the priority of each statement in the ACL. When determining whether to forward or block packets, a device compares packets with rule statements based on the sequence that rule statements are created. After locating a matched rule statement, the device does not check any other rule statement.

If a rule statement is created and denies all traffic, all subsequent statements will not be checked.

For example:

```
access-list 101 deny ip any any
access-list 101 permit tcp 192.168.12.0 0.0.0.255 eq telnet any
```

The first rule statement denies all IP packets. Therefore, Telnet packets from the host on the network 192.168.12.0/24 will be denied. After the device finds that packets match the first rule statement, it does not check the subsequent rule statements any more.

Related Configuration

➤ Configuring an IP ACL

By default, no IP ACL is configured on a device.

Run the **ip access-list { standard | extended } {acl-name | acl-id}** command in global configuration mode to create a standard or an extended IP ACL and enter standard or extended IP ACL mode.

➤ Adding ACEs to an IP ACL

By default, a newly created IP ACL contains an implicit ACE that denies all IPv4 packets. This ACE is hidden from users, but takes effect when the ACL is applied to an interface. That is, all IPv4 packets will be discarded. Therefore, if you want the device to receive or send some specific IPv4 packets, add some ACEs to the ACL.

For a standard IP ACL, add ACEs as follows:

- No matter whether the standard IP ACL is a named or number ACL, you can run the following command in standard IP ACL mode to add an ACE:

```
[ sn ] { permit | deny } { host source | any | source source-wildcard } [ time-range time-range-name ] [ log ]
```

- For a numbered standard IP ACL, you can also run the following command in global configuration mode to add an ACE:

```
access-list acl-id { permit | deny } { host source | any | source source-wildcard } [ time-range tm-rng-name ] [ log ]
```

For an extended IP ACL, you can add ACEs as follows:

- No matter whether the extended IP ACL is a named or numbered ACL, you can run the following command in extended IP ACL mode to add an ACE:

```
[ sn ] { permit | deny } protocol { host source | any | source source-wildcard } { host destination | any | destination destination-wildcard } [ [ precedence precedence ] [ tos tos ] ] | [ dscp dscp ] [ ecn ecn ] ] [ udf udf-id header pos value mask ] [ fragment ] [ fragment-ipid fragment-ipid ] [ time-range time-range-name ] [ log ]
```

- For a numbered extended IP ACL, you can also run the following command in global configuration mode to add an ACE:

```
access-list acl-id { permit | deny } protocol { host source | any | source source-wildcard } { host destination | any | destination destination-wildcard } [ [ precedence precedence ] [ tos tos ] ] | [ dscp dscp ] [ ecn ecn ] ] [ fragment ] [ fragment-ipid fragment-ipid ] [ time-range time-range-name ] [ log ]
```

📌 Applying an IP ACL

By default, the IP ACL is not applied to any interface, that is, the IP ACL does not filter incoming or outgoing IP packets of the device.

Run the **ip access-group** { *acl-id* | *acl-name* } { **in** | **out** } [**reflect** | **counter-only** | **forward-plane** | **priority**] command in interface configuration mode to apply a standard or an extended IP ACL to a specified interface.

To collect statistics on packets with some features, run the **ip access-group** { *acl-id* | *acl-name* } { **in** | **out** } **counter-only** command on the interface. The count rule takes effect only to **permit** rules and does not take effect to **deny** rules in the ACL.

After an ACL is used as a counter-only ACL, the counter function cannot be globally enabled for the ACL, and the ACL cannot be applied globally or on interfaces as a common application ACL. That is, ACLs with the same ID or name cannot be used as a counter-only ACL and a common application ACL at the same time.

Configure **forward-plane** so that ACL is only applied to the forwarding plane.

Configure **priority** to set the priority of ACL applied to the SVI interface, so that this ACL can have the highest priority on the forwarding plane of SVI interface.

1.3.2 MAC Extended ACL

The MAC extended ACL implements refined control on incoming and outgoing packets based on the L2 header of packets. You can permit or deny the entry of specific L2 packets to a network, thus protecting network resources against attacks or control users' access to network resources.

Working Principle

Define a series of MAC access rules in the MAC extended ACL, and then apply the ACL to the incoming or outgoing direction of an interface. The device checks whether the incoming or outgoing packets match the rules and accordingly forwards or blocks these packets.

To configure an MAC extended ACL, you must specify a unique name or ID for this ACL to uniquely identify the ACL. The following table lists the range of IDs that identify MAC extended ACLs.

Protocol	ID Range
MAC extended ACL	700–799

Typical rules defined in an MAC extended ACL include:

- Source MAC address
- Destination MAC address
- Ethernet protocol type

The MAC extended ACL (ID range: 700–799) is used to filter packets based on the source or destination MAC address and the Ethernet type in the packets.

For an individual MAC extended ACL, multiple independent ACL statements can be used to define multiple rules. All statements reference the same ID or name so that these statements are bound with the same ACL. However, more statements mean that it is increasingly difficult to read and understand the ACL.

If ACEs in an MAC extended ACL are not defined specifically for IPv6 packets, that is, the Ethernet type is not specified or the value of the Ethernet type field is not 0x86dd, the MAC extended ACL does not filter IPv6 packets. If you want to filter IPv6 packets, use the IPv6 extended ACL.

⤵ Implicit "Deny All Traffic" Rule Statement

At the end of every MAC extended ACL is an implicit "deny all traffic" rule statement. Therefore, if a packet does not match any rule, the packet will be denied.

For example:

```
access-list 700 permit host 00d0.f800.0001 any
```

This ACL permits only packets from the host with the MAC address 00d0.f800.0001, and denies packets from all other hosts. This is because the following statement exists at the end of this ACL: **access-list 700 deny any any**.

Related Configuration

⤵ Configuring an MAC Extended ACL

By default, no MAC extended ACL is configured on a device.

Run the **mac access-list extended {acl-name | acl-id}** command in global configuration mode to create an MAC extended ACL and enter MAC extended ACL mode.

⤵ Adding ACEs to an MAC Extended ACL

By default, a newly created MAC extended ACL contains an implicit ACE that denies all L2 packets. This ACE is hidden from users, but takes effect when the ACL is applied to an interface. That is, all L2 packets will be discarded. Therefore, if you want the device to receive or send some specific L2 packets, add some ACEs to the ACL.

You can add ACEs to an MAC extended ACL as follows:

- No matter whether the MAC extended ACL is a named or numbered ACL, you can run the following command in MAC extended ACL mode to add an ACE:

```
[sn] { permit | deny } { any | host src-mac-addr | src-mac-addrmask } { any | host dst-mac-addr | dst-mac-addrmask } [ethernet-type] [coscos] [innercos] [time-range tm-rng-name]
```

- For a numbered MAC extended ACL, you can also run the following command in global configuration mode to add an ACE:

```
access-list acl-id { permit | deny } { any | host src-mac-addr | src-mac-addrmask } { any | host dst-mac-addr | dst-mac-addrmask } [ethernet-type] [coscos] [innercos] [time-range time-range-name]
```

📌 Applying an MAC Extended ACL

By default, the MAC extended ACL is not applied to any interface, that is, the created MAC extended ACL does not filter incoming or outgoing L2 packets of a device.

Run the **mac access-group** { *acl-id* | *acl-name* } { **in** | **out** } [**counter-only** | **forward-plane** | **priority**] command in interface configuration mode to apply an MAC extended ACL to a specified interface.

To collect statistics on packets with some features, run the **mac access-group** { *acl-id* | *acl-name* } { **in** | **out** } **counter-only** command on the interface. The count rule takes effect only to **permit** rules and does not take effect to **deny** rules in the ACL.

After an ACL is used as a counter-only ACL, the counter function cannot be globally enabled for the ACL, and the ACL cannot be applied globally or on interfaces as a common application ACL. That is, ACLs with the same ID or name cannot be used as a counter-only ACL and a common application ACL at the same time.

Configure **forward-plane** so that ACL is only applied to the forwarding plane.

Configure **priority** to set the priority of ACL applied to the SVI interface, so that this ACL can have the highest priority on the forwarding plane of SVI interface.

1.3.3 Expert Extended ACL

You can create an expert extended ACL to match the L2 and L3 information in packets using the same rule. The expert extended ACL can be treated as a combination and enhancement of the IP ACL and the MAC extended ACL because the expert extended ACL can contain ACEs in both the IP ACL and the MAC extended ACL. In addition, the VLAN ID can be specified in the expert extended ACL to filter packets.

Working Principle

Define a series of access rules in the expert extended ACL, and then apply the ACL in the incoming or outgoing direction of an interface. The device checks whether incoming or outgoing packets match the rules and accordingly forwards or blocks these packets.

To configure an expert extended ACL, you must specify a unique name or ID for this ACL so that the protocol can uniquely identify each ACL. The following table lists the ID range of the expert extended ACL.

Protocol	ID Range
Expert extended ACL	2700–2899

When an expert extended ACL is created, defined rules can be applied to all packets. The device determines whether to forward or block packets by checking whether packets match these rules.

Typical rules defined in an expert extended ACL include:

- All information in the basic ACL and MAC extended ACL
- VLAN ID

The expert extended ACL (ID range: 2700–2899) is a combination of the basic ACL and MAC extended ACL, and can filter packets based on the VLAN ID.

For an individual expert extended ACL, multiple independent statements can be used to define multiple rules. All statements reference the same ID or name so that these statements are bound with the same ACL.

If rules in an expert extended ACL are not defined specifically for IPv6 packets, that is, the Ethernet type is not specified or the value of the Ethernet type field is not 0x86dd, the expert extended ACL does not filter IPv6 packets. If you want to filter IPv6 packets, use the IPv6 extended ACL.

The Virtual Extensible LAN (VXLAN) field in the expert extended ACL of a data center product is mainly used to match the inner packets in the VXLAN. Therefore, you can use the expert extended ACL in VXLAN mode to match the inner IP address of the VXLAN.

The VXLAN field in the N18K-CMX expert extended ACL of a data center product cannot match the 5-tuple of the inner and external layer concurrently. However, FS RG-S6220-H only needs to match the tunnel start packets and tunnel termination packets. Therefore, with RG-S6220-H, you can only use a common 5-tuple field to match the original packets without applying the VXLAN field in the expert extended ACL.

When a device needs to match VXLAN packets, you can specify the destination port ID of the VXLAN protocol to confirm VXLAN packets. You can also specify whether matched VXLAN packets carry tags.

The UDF field in the expert extended ACL of a data center product is a customized field. Users should customize the protocol layer, offset, data and mask.

MPLS in the expert extended ACL of a data center product can provide the matching rules for the IP field in MPLS packets.

📌 Implicit "Deny All Traffic" Rule Statement

At the end of every expert extended ACL is an implicit "deny all traffic" rule statement. Therefore, if a packet does not match any rule, the packet will be denied.

For example:

```
access-list 2700 permit 0x0806 any any any any any
```

This ACL permits only ARP packets whose Ethernet type is 0x0806, and denies all other types of packets. This is because the following statement exists at the end of this ACL: **access-list 2700 deny any any any any**.

Related Configuration

📌 Configuring an Expert Extended ACL

By default, no expert extended ACL is configured on a device.

Run the **expert access-list extended {acl-name | acl-id}** command in global configuration mode to create an expert extended ACL and enter expert extended ACL mode.

📌 Adding ACEs to an Expert Extended ACL

By default, a newly created expert extended ACL contains an implicit ACE that denies all packets. This ACE is hidden from users, but takes effect when the ACL is applied to an interface. That is, all L2 packets will be discarded. Therefore, if you want the device to receive or send some specific L2 packets, add some ACEs to the ACL.

You can add ACEs to an expert extended ACL as follows:

- No matter whether the expert extended ACL is a named or numbered ACL, you can run the following command in expert extended ACL mode to add an ACE:

```
[sn]{ permit | deny } [protocol] [ ethernet-type ] [ cos [out] [inner in] ] [ [VID] [out][inner in] ] { source source-wildcard | host source | any } { host source-mac-address | any } { destination destination-wildcard | host destination | any } { host destination-mac-address | any } [ [precedence precedence ] [tos tos ] | [ dscp dscp ] [ ecn ecn ] ] [ fragment ] [ fragment-ipid fragment-ipid ] [ range lowerupper ] [ [ udf udf-id header pos value mask ] | [ int-flag ] ] [ time-range time-range-name ] ]
```

- When VXLAN packets need to match the inner 5-tuple, you can use the following command in expert ACL:

```
[sn]{ permit | deny } vxlan protocol { source source-wildcard | host source | any } { destination destination-wildcard | host destination | any } [ tagged ] [ udp-dport dport ] [ time-range time-range-name ] ]
```

This command is used to configure an ACE in the ACL. When *protocol* is set to **TCP** or **UDP**, you can configure a Layer-4 port ID to indicate the VXLAN inner port ID to be matched.

- For a numbered expert extended ACL, you can also run the following command in expert extended ACL mode to add an ACE:

```
access-list acl-id { permit | deny } [protocol] [ ethernet-type ] [ cos [out] [inner in] ] [ [VID] [out][inner in] ] { source source-wildcard | host source | any } { host source-mac-address | any } { destination destination-wildcard | host destination | any } { host destination-mac-address | any } [ [precedence precedence ] [tos tos ] | [ dscp dscp ] [ ecn ecn ] ] [ fragment ] [ fragment-ipid fragment-ipid ] [ range lowerupper ] [ [ udf udf-id header pos value mask ] | [ int-flag ] ] [ time-range time-range-name ] ]
```

📌 Applying an Expert Extended ACL

By default, the expert extended ACL is not applied to any interface, that is, the created expert extended ACL does not filter incoming or outgoing L2 or L3 packets of a device.

Run the **expert access-group** { *acl-id* | *acl-name* } { **in** | **out** } [**counter-only** | **forward-plane** | **priority**] command in interface configuration mode to apply an expert extended ACL to a specified interface.

To collect statistics on packets with some features, run the **expert access-group** { *acl-id* | *acl-name* } { **in** | **out** } **counter-only** command on the interface. The count rule takes effect only to **permit** rules and does not take effect to **deny** rules in the ACL.

After an ACL is used as a counter-only ACL, the counter function cannot be globally enabled for the ACL, and the ACL cannot be applied globally or on interfaces as a common application ACL. That is, ACLs with the same ID or name cannot be used as a counter-only ACL and a common application ACL at the same time.

Configure **forward-plane** so that ACL is only applied to the forwarding plane.

Configure **priority** to set the priority of ACL applied to the SVI interface, so that this ACL can have the highest priority on the forwarding plane of SVI interface.



1.3.4 IPv6 ACL

The IPv6 ACL implements refined control on incoming and outgoing IPv6 packets of a device. You can permit or deny the entry of specific IPv6 packets to a network according to actual requirements to control access of IPv6 users to network resources.

Working Principle

Define a series of IPv6 access rules in the IPv6 ACL, and then apply the ACL in the incoming or outgoing direction of an interface. The device checks whether the incoming or outgoing IPv6 packets match the rules and accordingly forwards or blocks these packets.

To configure an IPv6 ACL, you must specify a unique name for this ACL.

-  Unlike the IP ACL, MAC extended ACL, and expert extended ACL, you can specify only a name but not an ID for the IPv6 ACL created.
-  Only one IP ACL, or one MAC extended ACL, or one expert extended ACL can be applied to the incoming or outgoing direction of an interface. Besides, one more IPv6 ACL can be applied.

↳ **Implicit "Deny All Traffic" Rule Statement**

At the end of every IPv6 ACL is an implicit "deny all IPv6 traffic" rule statement. Therefore, if a packet does not match any rule, the packet will be denied.

For example:

```
ipv6 access-list ipv6_acl
10 permit ipv6 host 200::1 any
```

This ACL permits only IPv6 packets from the source host 200::1, and denies IPv6 packets from all other hosts. This is because the following statement exists at the end of this ACL: deny ipv6 any any.

-  Although the IPv6 ACL contains the implicit "deny all IPv6 traffic" rule statement by default, it does not filter ND packets.

↳ **Input Sequence of Rule Statements**

Every new rule is added to the end of an ACL and in front of the default rule statement. The input sequence of statements in an ACL is very important. It determines the priority of each statement in the ACL. When determining whether to forward or block packets, a device compares packets with rule statements based on the sequence that rule statements are created. After locating a matched rule statement, the device does not check any other rule statement.

If a rule statement is created and permits all IPv6 traffic, all subsequent statements will not be checked.

For example:

```
ipv6 access-list ipv6_acl
10 permit ipv6 any any
20 deny ipv6 host 200::1 any
```

As the first rule statement permits all IPv6 packets, all IPv6 packets sent from the host 200::1 does not match the subsequent deny rule with the serial number of 20, and therefore will not be denied. After the device finds that packets match the first rule statement, it does not check the subsequent rule statements any more.

Related Configuration

↳ **Configuring an IPv6 ACL**

By default, no IPv6 ACL is configured on a device.

Run the **ipv6 access-list *acl-name*** command in global configuration mode to create an IPv6 ACL and enter IPv6 ACL mode.

↳ **Adding ACEs to an IPv6 ACL**

By default, a newly created IPv6 ACL contains an implicit ACE that denies all IPv6 packets. This ACE is hidden from users, but takes effect when the ACL is applied to an interface. That is, all IPv6 packets will be discarded. Therefore, if you want the device to receive or send some specific IPv6 packets, add some ACEs to the ACL.

Run the following command in IPv6 ACL mode to add an ACE:

[sn] {**permit** | **deny**} protocol[src-ipv6-prefix/prefix-len|host src-ipv6-addr] **any**{dst-ipv6-pfix/pfix-len|host dst-ipv6-addr|**any**} [range lower upper] [**dscp** dscp][**flow-label**flow-label][**fragment**] [**udf** udf-id header pos value mask] [time-range tm-rng-name] [**log**]

📌 Applying an IPv6 ACL

By default, the IPv6 ACL is not applied to any interface, that is, the IPv6 ACL does not filter incoming or outgoing IPv6 packets of a device.

Run the **ipv6 traffic-filter acl-name { in| out } [counter-only | priority]** command in interface configuration mode to apply an IPv6 ACL to a specified interface.

Configure **priority** to set the priority of ACL applied to the SVI interface, so that this ACL can have the highest priority on the forwarding plane of SVI interface.

1.3.5ACL80

ACL80 refers to the expert advanced ACL, and is also called custom ACL. It filters packets based on the first 80 bytes of every packet. Among these 80 bytes, the SMAC, DMAC, SIP, DIP, and ETYPE fields in a packet are mandatory, and you can specify the remaining 16 bytes.

Working Principle

A packet consists of a number of bytes. ACL80 allows you to match the specified 16 bytes by bit in the first 80 bytes of a packet. Any bit of a 16-byte field can be set to a value (**0** or **1**), indicating whether the bit is compared. When any byte is filtered, three factors are considered: content of the matching field, mask of the matching field, and the start position for matching. Bits of the matching field content are in one-to-one mapping relationship with bits of the matching field mask. The filtering rule specifies the value of the field to be filtered. The filtering field template specifies whether the corresponding field in the filtering rule should be filtered. (**1** indicates that the bit specified in the filtering rule should be matched; **0** indicates that the bit specified in the filtering rule is not matched.) Therefore, when it is required to match a specific bit, you must set the corresponding bit to 1 in the filtering field template. For example, if the bit is set to **0** in the filtering field template, no bit is matched no matter which bit is specified in the filtering rule.

For example,

```
FS(config)#expert access-list advanced name
FS(config-exp-dacl)#permit 00d0f8123456 ffffffff 0
FS(config-exp-dacl)#deny 00d0f8654321 ffffffff 6
```

The custom ACL matches any byte of the first 80 bytes in a L2 data frame according to user' definition, and filters packets accordingly. To properly use a custom ACL, you must have an in-depth understanding about the structure of a L2 data frame. The following shows the first 64 bytes of a L3 data frame (every letter represents a hexadecimal number, and every two letters represent one byte):



```
AA AA AA AA AA AA BB BB BB BB BB BB CC CC DD DD
DD DD EE FF GG HH HH HH II II JJ KK LL LL MM MM
NN NN OO PP QQ QQ RR RR RR RR SS SS SS TT TT
UU UU VV VV VV VV WW WW WW WW XY ZZ aa aa bb bb
```

The following table describes the meaning and offset of each letter:

Letter	Meaning	Offset	Letter	Meaning	Offset
A	Destination MAC address	0	O	Time To Live (TTL) field	34
B	Source MAC address	6	P	Protocol number	35

Letter	Meaning	Offset	Letter	Meaning	Offset
C	VLAN tag field	12	Q	IP checksum	36
D	Data frame length	16	R	Source IP address	38
E	Destination service access point (DSAP) field	18	S	Destination IP address	42
F	Source service access point (SSAP) field	19	T	TCP source port	46
G	Cntl field	20	U	TCP destination port	48
H	Org Code field	21	V	Serial number	50
I	Encapsulated data type	24	W	Acknowledgment field	54
J	IP version number	26	XY	IP header length and reserved bit	58
K	TOS field	27	Z	Reserved bit and flags bit	59
L	IP packet length	28	a	Windows size field	60
M	ID	30	b	Miscellaneous	62
N	Flags field	32			

In the above table, the offset of each field is the offset of this field in the tagged 802.3 SNAP packet. In a custom ACL, you can use the rule mask and offset jointly to extract any byte from the first 80 bytes of a data frame, compare the byte with the rule customized in the ACL, and then filter matched data frames for further processing. Customized rules may be some fixed attributes of data. For example, to obtain all TCP packets, you can define the rule as "06", rule mask as "FF", and offset as "35". Then, the device can use the rule mask and offset jointly to extract the content of TCP protocol number field in a received data frame, and compare the extracted content with the rule to obtain all TCP packets.

-  Only switches support the ACL80.
-  The ACL80 supports filtering of the Ethernet, 803.3 SNAP, and 802.3 LLC packets. If the values of the fields from DSAP to cntl are set to AAAA03, the ACL is used to filter the 803.3 SNAP packets. If the values of the fields from DSAP to cntl are set to E0E003, the ACL is used to filter the 803.3 LLC packets. The value of the cntl field cannot be configured to filter Ethernet packets.
-  The ACL80 can be configured to compare packets with any of the 16 bytes. If the 16 bytes are already used, no ACE can be configured to compare packets with fields in any other bytes.

Related Configuration

📌 Configuring an Expert Advanced ACL

By default, no expert advanced ACL is configured on a device.

Run the **expert access-list advanced *acl-name*** command in global configuration mode to create an expert advanced ACL and enter expert advanced ACL mode.

📌 Adding ACEs to an Expert Advanced ACL

By default, a newly created expert advanced ACL contains an implicit ACE that denies all packets. This ACE is hidden from users, but takes effect when the ACL is applied to an interface. That is, all L2 packets will be discarded. Therefore, if you want the device to receive or send some specific L2 packets, add some ACEs to the ACL.

- Run the `[sn] { permit | deny } hex hex-mask offset` command in expert advanced ACL mode to add an ACE to the expert advanced ACL.

📌 Applying an Expert Advanced ACL

By default, the expert advanced ACL is not applied to any interface, that is, the created expert advanced ACL does not filter incoming or outgoing packets of a device.

Run the **expert access-group *acl-name* { in| out } [forward-plane|priority]** command in interface configuration mode to apply an expert advanced ACL to a specified interface.

Configure **forward-plane** so that ACL is only applied to the forwarding plane.



Configure **priority** to set the priority of ACL applied to the SVI interface, so that this ACL can have the highest priority on the forwarding plane of SVI interface.

1.3.6 ACL Redirection

ACL redirection allows a device to analyze received packets and redirect the packets to a specified port for forwarding. To analyze specific incoming packets of a device, you can configure the ACL redirection function to redirect packets meeting rules to a specified port and capture packets on this port for analysis.

Working Principle

Bind different ACL policy to an interface and specify an output destination interface for each policy. When receiving packets on this interface, the device searches ACL policies bound to this interface one by one. If packets match criteria described in a certain policy, the device forwards packets on the destination interface specified by the policy, thus redirecting packets based on traffic.

-  Only switches support the ACL redirection function.
-  ACL redirection takes effect only in the incoming direction of an interface.

Related Configuration

↳ Configuring an ACL

Before configuring ACL redirection, configure an ACL. For details about how to configure an ACL, see the earlier descriptions about ACL configuration.

↳ Adding ACEs to an ACL

For details about how to add ACEs to an ACL, see the earlier descriptions about the IP ACL, MAC extended ACL, expert extended ACL, or IPv6 ACL.

↳ Configuring ACL Redirection

By default, ACL redirection is not configured on a device.

Run the **redirect destinationinterface *interface-name* acl {*acl-id* | *acl-name* } in** command in interface configuration mode to configure ACL redirection.

-  You can configure the ACL redirection function only on an Ethernet interface or AP.





1.3.7 Global Security ACL

To meet the requirements of security deployment, the port-based ACL is often configured to filter out virus packets and obtain packets with certain characteristics, for example, packets that attack the TCP port. Various virus packets exist in a global network environment, and the identification features of virus packets under each port are identical or similar. Therefore, an ACL is generally created. After the deny ACE for matching virus signatures is added to the ACL, the port-based ACL is applied to each port on the switch to filter out virus packets.

For two reasons, it is not convenient to use the port-based ACLs in antivirus scenarios such as virus filtering. The first reason is that the port-based ACL must be configured on every port, which results in repeated configuration, poor operation performance, and over-consumption of ACL resources. The second reason is that the access control function of the ACL is weakened. As the port-based ACL is used for virus filtering, basic functions of the ACL, such as route update restriction and network access restriction, cannot be used properly. The global security ACL can be used for global antivirus deployment and defense without affecting the port-based ACL. By running only one command, you can make the global security ACL takes effect on all L2 interfaces. In contrast, the port-based ACL must be configured on every interface.

Working Principle

The global security ACL takes effect on all L2 interfaces. When both the global security ACL and the port-based ACL are configured, both take effect. Packets that match the global security ACL are directly filtered out as virus packets. Packets that do not match the global security ACL are still controlled by the port-based ACL. You can disable the global security ACL on some ports so that these ports are not controlled by the global security ACL.

-  The global security ACL is mainly used for virus filtering. Therefore, in an ACL associated with the global security ACL, only the deny ACEs take effect, and the permit ACEs do not take effect.
-  Unlike the secure ACL applied to a port, the global security ACL does not contain the default "deny all traffic" ACE, that is, all packets that do not match the ACL are permitted.
-  A global secure ACL can take effect either on a L2 port or a routed port. That is, it takes effect on all the following types of ports: access port, trunk port, hibird port, routed port, and AP (L2 or L3). The global secure ACL does not take effect on an SVI.
-  You can disable the global security ACL on an individual physical port or AP, but not on a member port of an AP.
-  The global secure ACL supports only the associated IP standard ACL, IP extended ACL, MAC extended ACL and expert extended ACL.

Related Configuration

↘ Configuring an ACL

Before configuring the global security ACL, configure an ACL. For details about how to configure an ACL, see the earlier descriptions about ACL configuration.

↘ Adding ACEs to an ACL

For details about how to add ACEs to an ACL, see the earlier descriptions about the IP ACL.

↘ Configuring a Global Security ACL

By default, no global security ACL is configured on a device.

Run the **{ip | mac | Expert } access-group acl-id { in | out }** command in global configuration mode to enable the global security ACL.

Run the **ipv6 traffic-filter acl-name { in | out }** command to enable the global ipv6 security ACL

↘ Configuring an Exclusive Interface of the Global Security ACL

By default, no exclusive interface is configured for the global security ACL on a device.







Run the **no global ip access-group** command in interface configuration to disable the global security ACL on a specified interface.

1.3.8 Security Channel

In some application scenarios, packets meeting some characteristics may need to bypass the checks of access control applications. For example, before DOT1X authentication, users are allowed to log in to a specified website to download the DOT1X authentication client. The security channel can be used for this purpose. When the security channel configuration command is executed to apply a secure ACL globally or to an interface, this ACL becomes a security channel.

Working Principle

The security channel is also an ACL, and can be configured globally or for a specified interface. When arriving at an interface, packets are checked on the security channel. If meeting the matching conditions of the security channel, packets directly enter a switch without undergoing the access control, such as port security, Web authentication, 802.1x, and IP+MAC binding check. A globally applied security channel takes effect on all interfaces except exclusive interfaces.

-  The deny ACEs in an ACL that is applied to a security channel do not take effect. In addition, this ACL does not contain an implicit "deny all traffic" rule statement at the end of the ACL. If packets do not meet matching conditions of the security channel, they are checked according to the access control rules in compliance with the relevant process.
-  You can configure up to eight exclusive interfaces for the global security channel. In addition, you cannot configure interface-based security channel on these exclusive interfaces.
-  If a security channel is applied to an interface while a global security channel exists, this global security channel does not take effect on this interface.
-  If both port-based migratable authentication mode and security channel are applied to an interface, the security channel does not take effect.
-  An IPv6 ACL cannot be configured as a security channel.
-  Only switches support the security channel.

Related Configuration

📄 Configuring an ACL

Before configuring the security channel, configure an ACL. For details about how to configure an ACL, see the earlier descriptions about ACL configuration.

📄 Adding ACEs to an ACL

For details about how to add ACEs to an ACL, see the earlier descriptions about the IP ACL, MAC extended ACL, or expert extended ACL.

📄 Configuring a Security Channel on an Interface

By default, no security channel is configured on an interface of a device.

Run the **security access-group** *{acl-id | acl-name }* command in interface configuration mode to configure the security channel on an interface.

📄 Configuring a Global Security Channel

By default, no global security channel is configured on a device.

Run the **security global access-group** *{acl-id | acl-name }* command in interface configuration mode to configure a global security channel.

➤ **Configuring an Exclusive Interface for the Global Security Channel**

By default, no exclusive interface is configured for the global security channel on a device.

Run the **security uplink enable** command in interface configuration mode to configure a specified interface as the exclusive interface of the global security channel.

1.3.9SVI Router ACL

By default, an ACL that is applied to an SVI also takes effect on L2 packets forwarded within a VLAN and L3 packets forwarded between VLANs. Consequently, users in the same VLAN may fail to communicate with each other. Therefore, a switchover method is provided so that the ACL that is applied to an SVI takes effect only on routing packets between VLANs.

Working Principle

By default, the SVI router ACL function is disabled, and an SVI ACL takes effect on L3 packets forwarded between VLANs and L2 packets forwarded within a VLAN. After the SVI router ACL function is enabled, the SVI ACL takes effect only on L3 packets forwarded between VLANs.

Only switches support the SVI router ACL.

Related Configuration

➤ **Configuring an ACL**

Before configuring the SVI router ACL, configure and apply an ACL. For details about how to configure an ACL, see the earlier descriptions about ACL configuration.

➤ **Adding ACEs to an ACL**

For details about how to add ACEs to an ACL, see the earlier descriptions about the IP ACL, MAC extended ACL, expert extended ACL, or IPv6 ACL.

➤ **Applying an ACL**

For details about how to apply an ACL, see the earlier descriptions about the IP ACL, MAC extended ACL, expert extended ACL, or IPv6 ACL. Apply the ACL in SVI configuration mode.

➤ **Configuring the SVI Router ACL**

Run the **svi router-acls enable** command in global configuration mode to enable the SVI router ACL so that the ACL that is applied to an SVI takes effect only on packets forwarded at L3, and not on packets forwarded at L2 within a VLAN.

1.3.10ACL Logging



ACL logging is used to monitor the running status of ACEs in an ACL and provide essential information for routine network maintenance and optimization.

Working Principle

To better learn the running status of ACLs on a device, you can determine whether to specify the ACL logging option as required when adding ACEs. If this option is specified, logs are output when packets matching ACEs are found. ACL logs are displayed based on ACEs. That is, the device periodically displays ACEs with matched packets and the number of matched packets. An example of the log is as follows:

```
*Sep  9 16:23:06: %ACL-6-MATCH: ACL 100 ACE 10 permit icmp any any, match 78 packets.
```

To control the amount of logs and output frequency, you can configure the log update interval.

-  An ACE containing the ACL logging option consumes more hardware resources. If all configured ACEs contain this option, the ACE capacity of a device will be reduced by half.
-  By default, the log update interval is 0, that is, no log is output. After the ACL logging option is specified in an ACE, you need to configure the log update interval to output related logs; otherwise, logs are not output.
-  For an ACE containing the ACL logging option, if no packet is matched in the specified interval, no packet matching log related to this ACE will be output. If matched packets are found in the specified interval, packet matching logs related to this ACE will be output when the interval expires. The number of matched packets is the total number of packets that match the ACE during the specified interval, that is, the period from the previous log output to the current log output.

Only switches support the ACL logging function.

You can configure the ACL logging option only for an IP ACL or an IPv6 ACL.

Related Configuration

↘ **Configuring an ACL**

Configure an ACL before configuring ACEs containing the ACL logging option. For details about how to configure an ACL, see the earlier descriptions about ACL configuration.

↘ **Adding ACEs to an ACL**

For details about how to add ACEs to an ACL, see the earlier descriptions about the IP ACL and IPv6 ACL. Note that the ACL logging option must be configured.

↘ **Configuring the Log Update Interval**

Run the **{ip | ipv6} access-list log-update interval *time*** command in the configuration mode to configure the interval at which the ACL logs are output.

↘ **Applying an ACL**

For details about how to apply an ACL, see the earlier descriptions about the IP ACL and IPv6 ACL.

1.3.11 Packet Matching Counters

In addition to ACL logs, packet matching counters provide another choice for routine network maintenance and optimization.

Working Principle

To implement network management, users may want to know whether an ACE has any matched packets and how many packets are matched. ACLs provide the ACE-based packet matching counters. You can enable or disable packet matching counters for all ACEs in an ACL. When a packet matches the ACE, the corresponding counter increments by 1. You can run the **clear counters access-list [*acl-id* | *acl-name*]** command to reset counters of all ACEs in an ACL for a new round of statistics.

-  Enabling ACL counters requires more hardware entries. In an extreme case, this will reduce by half the number of ACEs that can be configured on a device.

You can enable packet matching counters on an IP ACL, MAC ACL, expert ACL, or IPv6 ACL.

Only switches support the ACL packet matching counters.

Related Configuration

➤ Configuring an ACL

Configure an ACL before configuring ACEs containing the ACL logging option. For details about how to configure an ACL, see the earlier descriptions about ACL configuration.

➤ Adding ACEs to an ACL

For details about how to add ACEs to an ACL, see the earlier descriptions about the ACL. Note that the ACL logging option must be configured.

➤ Enabling Packet Matching Counters

To enable packet matching counters on an IP ACL, MAC ACL, or expert ACL, run the **{mac | expert | ip} access-list counter {acl-id | acl-name}** command in global configuration mode.

To enable packet matching counters on an IPv6 ACL, run the **ipv6 access-list counter acl-name** command in global configuration mode.

➤ Applying an ACL

For details about how to apply an ACL, see the earlier descriptions about the IP ACL, MAC extended ACL, expert extended ACL, or IPv6 ACL.

➤ Clearing Packet Matching Counters

Run the **clear counters access-list [acl-id | acl-name]** command in privileged EXEC mode to reset packet matching counters.

1.3.12 Fragmented Packet Matching Mode

In fragmented packet matching mode, an ACL can implement more refined control on fragmented packets.

Working Principle

IP packets may be fragmented when transmitted on the network. When fragmentation occurs, only the first fragment of the packet contains the L4 information, such as the TCP/UDP port number, ICMP type, and ICMP code, and other fragmented packets do not contain the L4 information. By default, if an ACE contains the fragment flag, fragmented packets except the first fragments are filtered. If an ACE does not contain the fragment flag, all fragmented packets (including the first fragments) are filtered. In addition to this default fragmented packet matching mode, a new fragmented packet matching mode is provided. You can switch between the two fragmented packet matching modes as required on a specified ACL. In the new fragmented packet matching mode, if an ACE does not contain the fragment flag and packets are fragmented, the first fragments are compared with all the matching fields (including L3 and L4 information) defined in the ACE, and other fragmented packets are compared with only the non-L4 information defined in the ACE.

❗ In the new fragmented packet matching mode, if an ACE does not contain the fragment flag and the action is Permit, this type of ACE occupies more hardware entries. In an extreme case, this will reduce by half the number of hardware entries. If Established is configured for filter the TCP flag in an ACE, more hardware entries will be occupied.

❗ The ACL will be temporarily ineffective during switchover of the fragmented packet matching mode.

In the new fragmented packet matching mode, if an ACE does not contain the fragment flag, the L4 information of packets needs to be compared, and the action is Permit, the ACE checks the L3 and L4 information of the first fragments of packets, and checks

only the L3 information of other fragmented packets. If the action is Deny, the ACE checks only the first fragments of packets, and ignores other fragmented packets.

In the new fragmented packet matching mode, if an ACE contains the fragment flag, the ACE checks only fragmented packets but not the first fragments of packets no matter whether the action in the ACE is Permit or Deny.

Only the IP extended ACL and the expert extended ACL support switching between the two fragmented packet matching modes.

Only switches support filtering of fragmented packets.

Related Configuration

↘ Configuring an ACL

For details about how to configure an ACL, see the earlier descriptions about the IP ACL and expert extended ACL.

↘ Adding ACEs to an ACL

For details about how to add ACEs to an ACL, see the earlier descriptions about the IP ACL and expert extended ACL. Note that the fragment option must be added.

↘ Switching the Fragmented Packet Matching Mode

Run the `[no] { ip | expert } access-list new-fragment-mode { acl-id | acl-name }` command in global configuration mode to switch the fragmented packet matching mode.

↘ Applying an ACL

For details about how to apply an ACL, see the earlier descriptions about the IP ACL and expert extended ACL.

1.4 Limitations



On the S6500/S6250 series products, the ACL applied to the inbound direction does not support "NEQ" matching on layer-4 ports for TCP and UDP packets, and the ACL applied to the outbound direction supports only "EQ" matching on layer-4 ports for TCP and UDP packets.



IPv6 ACLs configured on the S6500/S6250 series products support matching by the following fields: **protocol**, **sip**, **I4_src**, **dip**, **I4_dst**, **dscp**, and **flow_label**. An IPv6 ACL supports matching only based on the following two field groups:

- protocol, sip, I4_src, I4_dst, dscp, flow_label, range
- protocol, dip, I4_src, I4_dst, dscp, flow_label, range
- An ACL cannot use all the fields for matching. In addition, IPv6 ACLs do not support matching by fragment nor matching by flow label in the outbound direction.
- When only high-order 64 bits (the mask length is less than or equal to 64) need to be matched for the source IP address and destination IP address, matching by the IPv6 5-tuple is supported.



On the S6500/S6250 series products, security ACLs applied to an SVI are effective to both intra-VLAN packets forwarded by bridges and inter-VLAN routing packets. As a result, users in the VLAN cannot perform communication.



The S6500/S6250 series products cannot identify the fragment flag field in IPv6 packets. If an IPv6 ACL contains the fragment flag, the fragment flag is ignored during packet matching. This is equivalent to absence of the fragment flag in ACLs, and matching is performed on all packets, including the first-fragment packets and non-first-fragment packets.









The S6500/S6250 series products support the switching of the fragment packet matching mode when IP extended ACLs or expert extended ACLs are applied.



On the S6500/S6250 series products, ACL 80 supports only the following common fields: destination MAC address, source MAC address, VID, ETYPE, IP protocol number, source IPv4 address, destination IPv4 address, destination port ID, source port ID, ICMP type, and ICMP code.

1.5 Configuration

Configuration Item	Description and Command	
Configuring an IP ACL	(Optional) It is used to filter IPv4 packets.	
	ip access-list standard	Configures a standard IP ACL.
	ip access-list extended	Configures an extended IP ACL.
	permit host any time-range log	Adds a permit ACE to a standard IP ACL.
	deny host any time-range log	Adds a deny ACE to a standard IP ACL.
	permit host any host any tos dscp precedence fragment fragment-ipid fragment-ipid time-range log	Adds a permit ACE to an extended IP ACL.
	deny host any host any tos dscp precedence fragment fragment-ipid fragment-ipid time-range log	Adds a deny ACE to an extended IP ACL.
	ip access-group in out	Applies a standard or an extended IP ACL.
Configuring an MAC Extended ACL	(Optional) It is used to filter L2 packets.	
	mac access-list extended	Configures an MAC extended ACL.
	permit any host any host cos inner time-range	Adds a permit ACE to an MAC extended ACL.
	deny any host any host cos inner time-range	Adds a deny ACE to an MAC extended ACL.
	mac access-group in out	Applies an MAC extended ACL.
Configuring an Expert Extended ACL	(Optional) It is used to filter L2 and L3 packets.	
	expert access-list extended	Configures an expert extended ACL.
	permit cos inner VID inner host any host any host any precedence tos fragment fragment-ipid range time-range	Adds a permit ACE to an expert extended ACL.
	deny cos inner VID inner host any host any host any precedence tos fragment fragment-ipid range time-range	Adds a deny ACE to an expert extended ACL.

Configuration Item	Description and Command	
	expert access-group in out	Applies an expert extended ACL.
Configuring an IPv6 Extended ACL	 (Optional) It is used to filter IPv6 packets.	
	ipv6 access-list	Configures an IPv6 ACL.
	permit host any host any range dscp flow-label fragment time-range log	Adds a permit ACE to an IPv6 ACL.
	deny host any host any range dscp flow-label fragment time-rangelog	Adds a deny ACE to an IPv6 ACL.
	ipv6 traffic-filter in out	Applies an IPv6 ACL.
Configuring an ACL80	 (Optional) It is used to customize the fields for filter L2 and L3 packets.	
	expert access-list advanced	Configures an expert advanced ACL.
	permit	Adds a permit ACE to an expert advanced ACL.
	deny	Adds a deny ACE to an expert advanced ACL.
	expert access-group in out	Applies an expert advanced ACL
Configuring ACL Redirection	 (Optional) It is used to redirect packets meeting the rules to a specified interface.	
	redirect destination interface acl in	Configures ACL redirection.
Configuring a Global Security ACL	 (Optional) It is used to make an ACL take effect globally.	
	ip access-group in out	Applies a global security ACL in global configuration mode.
	no global ip access-group	Configures an interface as the exclusive interface of the global security ACL in interface configuration mode.
Configuring a Security Channel	 (Optional) It is used to enable packets meeting some characteristics to bypass the checks of access control applications, such as the DOT1X and Web authentication.	
	security access-group	Enables the security channel in interface configuration mode.
	security global access-group	Enables the security channel in global configuration mode.
	security uplink enable	Configures an interface as the exclusive interface of the global security channel in interface configuration mode.
Configuring Comments for ACLs	 (Optional) It is used to configure comments for an ACL or ACE so that users can easily identify the functions of the ACL or ACE.	
	list-remark	Configures a comment for an ACL in ACL configuration mode.
	access-list list-remark	Configures a comment for an ACL in global configuration mode.
	remark	Configures a comment for an ACE in ACL configuration mode.

Configuration Item	Description and Command	
Global Forwarding Plane Security ACL	 (Optional) It is used to apply the ACL to only hardware packets.	
	ip access-group in forward-plane	Configures global forwarding plane security ACL in global configuration mode.

1.5.1 Configuring an IP ACL

Configuration Effect

Configure and apply an IP ACL to an interface to control all incoming and outgoing IPv4 packets of this interface. You can permit or deny the entry of specific IPv4 packets to a network to control access of IP users to network resources.

Notes

N/A

Configuration Steps

➤ Configuring an IP ACL

- (Mandatory) Configure an IP ACL if you want to control access of IPv4 users to network resources.
- You can configure this ACL on an access, an aggregate, or a core device based on the distribution of users. The IP ACL takes effect only on the local device, and does not affect other devices on the network.

➤ Adding ACEs to an IP ACL

- (Optional) An ACL may contain zero or multiple ACEs. If no ACE is configured, all incoming IPv4 packets of the device are denied by default.

➤ Applying an IP ACL

- (Mandatory) Apply an IP ACL to a specified interface if you want this ACL take effect.
- You can apply an IP ACL on a specified interface of an access, an aggregate, or a core device based on the distribution of users.

Verification

- Use the following methods to verify the configuration effects of the IP ACL:
- Run the **ping** command to verify that the IP ACL takes effect on the specified interface. For example, if an IP ACL is configured to prohibit a host with a specified IP address or hosts in a specified IP address range from accessing the network, run the **ping** command to verify that the host(s) cannot be successfully pinged.
- Access related network resources to verify that the IP ACL takes effect on the specified interface. For example, access the Internet or access the FTP resources on the network through FTP.

Related Commands

➤ Configuring an IP ACL

Command	ip access-list { standard extended } {acl-name acl-id }
Parameter	standard: Indicates that a standard IP ACL is created.
Description	extended: Indicates that an extended IP ACL is created.

	<p><i>acl-name</i>: Indicates the name of a standard or an extended IP ACL. If this option is configured, a named ACL is created. The name is a string of 1 to 99 characters. The ACL name cannot start with numbers (0–9), "in", or "out".</p> <p><i>acl-id</i>: Indicates the ID that uniquely identifies a standard or extended IP ACL. If this option is configured, a numbered ACL is created. If a standard IP ACL is created, the value range of <i>acl-id</i> is 1–99 and 1300–1999. If an extended IP ACL is created, the value range of <i>acl-id</i> is 100–199 and 2000–2699.</p>
Command Mode	Global configuration mode
Usage Guide	Run this command to configure a standard or an extended IP ACL and enter standard or extended IP ACL configuration mode. If you want to control access of users to network resources by checking the source IP address of each packet, configure a standard IP ACL. If you want to control access of users to network resources by checking the source or destination IP address, protocol number, and TCP/UDP source or destination port, configure an extended IP ACL.

➤ **Adding ACEs to an IP ACL**

- Add ACEs to a standard IP ACL.

Use either of the following methods to add ACEs to a standard IP ACL:

Command	[<i>sn</i>] { permit deny } { host <i>source</i> any <i>source source-wildcard</i> } [time-range <i>time-range-name</i>] [log]
Parameter Description	<p><i>sn</i>: Indicates the sequence number of an ACE. The value ranges from 1 to 2,147,483,647. This sequence number determines the priority of this ACE in the ACL. A smaller sequence number indicates a higher priority. An ACE with a higher priority will be preferentially used to match packets. If you do not specify the sequence number when adding an ACE, the system automatically allocates a sequence number, which is equal to an increment (10 by default) plus the sequence number of the last ACE in the current ACL. For example, if the sequence number of the last ACE is 100, the sequence number of a newly-added ACE will be 110 by default. You can adjust the increment using a command.</p> <p>permit: Indicates that the ACE is a permit ACE.</p> <p>deny: Indicates that the ACE is a deny ACE.</p> <p>host source: Indicates that IP packets sent from a host with the specified source IP address are filtered.</p> <p>any: Indicates that IP packets sent from any host are filtered.</p> <p><i>source source-wildcard</i>: Indicates that IP packets sent from hosts in the specified IP network segment are filtered.</p> <p>time-range time-range-name: Indicates that this ACE is associated with a time range. The ACE takes effect only within this time range. For details about the time range, see the configuration manual of the time range.</p> <p>log: Indicates that logs will be periodically output if packets matching the ACEs are found. For details about logs, see "ACL Logging" in this document.</p>
Command Mode	Standard IP ACL configuration mode
Usage Guide	Run this command to add ACEs in standard IP ACL configuration mode. The ACL can be a named or numbered ACL.

Command	access-list <i>acl-id</i> { permit deny } { host <i>source</i> any <i>source source-wildcard</i> } [time-range <i>tm-rng-name</i>] [log]
Parameter Description	<p><i>acl-id</i>: Indicates the ID of a numbered ACL. It uniquely identifies an ACL. The value range of <i>acl-id</i> is 100–199 and 1300–1999.</p> <p>permit: Indicates that the ACE is a permit ACE.</p> <p>deny: Indicates that the ACE is a deny ACE.</p> <p>host source: Indicates that IP packets sent from a host with the specified source IP address are filtered.</p> <p>any: Indicates that IP packets sent from any host are filtered.</p>

	<p><i>source source-wildcard</i>: Indicates that IP packets sent from hosts in the specified IP network segment are filtered.</p> <p>time-range <i>time-range-name</i>: Indicates that this ACE is associated with a time range. The ACE takes effect only within this time range. For details about the time range, see the configuration manual of the time range.</p> <p>log: Indicates that logs will be periodically output if packets matching the ACEs are found. For details about logs, see "ACL Logging" in this document.</p>
Command Mode	Standard IP ACL configuration mode
Usage Guide	Run this command to add ACEs to a numbered IP ACL in global configuration mode. It cannot be used to add ACEs to a named IP ACL.

- Add ACEs to an extended IP ACL.

Use either of the following methods to add ACEs to an extended IP ACL:

Command	<p>[<i>sn</i>] { permit deny } <i>protocol</i> { host <i>source</i> any <i>source source-wildcard</i> } { host <i>destination</i> any <i>destination destination-wildcard</i> } [[precedence <i>precedence</i> [tos <i>tos</i>]] dscp <i>dscp</i>] [fragment] [fragment-ipid <i>fragment-ipid</i>] [time-range <i>time-range-name</i>] [log]</p>
Parameter Description	<p><i>sn</i>: Indicates the sequence number of an ACE. The value ranges from 1 to 2,147,483,647. This sequence number determines the priority of this ACE in the ACL. A smaller sequence number indicates a higher priority. An ACE with a higher priority will be preferentially used to match packets. If you do not specify the sequence number when adding an ACE, the system automatically allocates a sequence number, which is equal to an increment (10 by default) plus the sequence number of the last ACE in the current ACL. For example, if the sequence number of the last ACE is 100, the sequence number of a newly-added ACE will be 110 by default. You can adjust the increment using a command.</p> <p>permit: Indicates that the ACE is a permit ACE.</p> <p>deny: Indicates that the ACE is a deny ACE.</p> <p><i>protocol</i>: Indicates the IP protocol number. The value ranges from 0 to 255. To facilitate the use, the system provides frequently-used abbreviations to replace the specific IP protocol numbers, including eigrp, gre, icmp, igmp, ip, ipinip, nos, ospf, tcp, and udp.</p> <p>host source: Indicates that IP packets sent from a host with the specified source IP address are filtered.</p> <p><i>source source-wildcard</i>: Indicates that IP packets sent from hosts in the specified IP network segment are filtered.</p> <p>host destination: Indicates that IP packets sent to a host with the specified destination IP address are filtered. If the any keyword is configured, IP packets sent to any host are filtered.</p> <p><i>destination destination-wildcard</i>: Indicates that IP packets sent to hosts in a specified IP network segment are filtered.</p> <p>any: Indicates that IP packets sent to or from any host are filtered.</p> <p>precedence <i>precedence</i>: Indicates that IP packets with the specified precedence field in the header are filtered.</p> <p>tos <i>tos</i>: Indicates that IP packets with the specified the type of service (TOS) field in the header are filtered.</p> <p>dscp <i>dscp</i>: Indicates that IP packets with the specified the dscp field in the header are filtered.</p> <p>ecn <i>ecn</i>: Indicates that IP packets with the specified ecn field in the header are filtered.</p> <p>fragment: Indicates that only fragmented IP packets except the first fragments are filtered.</p> <p>fragment-ipid <i>fragment-ipid</i>: Indicates that packets with the specified fragment ID field in the header are filtered.</p> <p>time-range <i>time-range-name</i>: Indicates that this ACE is associated with a time range. The ACE takes effect only within this time range. For details about the time range, see the configuration manual of the time range.</p> <p>log: Indicates that logs will be periodically output if packets matching the ACEs are found. For details about logs, see "ACL Logging" in this document.</p>
Command Mode	Extended IP ACL configuration mode

Usage Guide	Run this command to add ACEs in extended IP ACL configuration mode. The ACL can be a named or numbered ACL.
--------------------	---

Command	access-list <i>acl-id</i> { permit deny } <i>protocol</i> { host <i>source</i> any <i>source source-wildcard</i> } { host <i>destination</i> any <i>destination destination-wildcard</i> } [[precedence <i>precedence</i> [tos <i>tos</i>]] dscp <i>dscp</i>] [fragment] [fragment-ipid <i>fragment-ipid</i>] [time-range <i>time-range-name</i>] [log]
Parameter Description	<p><i>acl-id</i>: Indicates the ID of a numbered ACL. It uniquely identifies an ACL. The value range of <i>acl-id</i> is 100–199 and 2000–1999.</p> <p><i>sn</i>: Indicates the sequence number of an ACE. The value ranges from 1 to 2,147,483,647. This sequence number determines the priority of this ACE in the ACL. A smaller sequence number indicates a higher priority. An ACE with a higher priority will be preferentially used to match packets. If you do not specify the sequence number when adding an ACE, the system automatically allocates a sequence number, which is equal to an increment (10 by default) plus the sequence number of the last ACE in the current ACL. For example, if the sequence number of the last ACE is 100, the sequence number of a newly-added ACE will be 110 by default. You can adjust the increment using a command.</p> <p>permit: Indicates that the ACE is a permit ACE.</p> <p>deny: Indicates that the ACE is a deny ACE.</p> <p><i>protocol</i>: Indicates the IP protocol number. The value ranges from 0 to 255. To facilitate the use, the system provides frequently-used abbreviations to replace the specific IP protocol numbers, including eigrp, gre, icmp, igmp, ip, ipinip, nos, ospf, tcp, and udp.</p> <p>host source: Indicates that IP packets sent from a host with the specified source IP address are filtered.</p> <p><i>source source-wildcard</i>: Indicates that IP packets sent from hosts in the specified IP network segment are filtered.</p> <p>host destination: Indicates that IP packets sent to a host with the specified destination IP address are filtered. If the any keyword is configured, IP packets sent to any host are filtered.</p> <p><i>destination destination-wildcard</i>: Indicates that IP packets sent to hosts in a specified IP network segment are filtered.</p> <p>any: Indicates that IP packets sent to or from any host are filtered.</p> <p>precedence precedence: Indicates that IP packets with the specified precedence field in the header are filtered.</p> <p>tos tos: Indicates that IP packets with the specified the type of service (TOS) field in the header are filtered.</p> <p>dscp dscp: Indicates that IP packets with the specified the dscp field in the header are filtered.</p> <p>ecn ecn: Indicates that IP packets with the specified ecn field in the header are filtered.</p> <p>fragment: Indicates that only fragmented IP packets except the first fragments are filtered.</p> <p>fragment-ipid fragment-ipid: Indicates that packets with the specified fragment ID field in the header are filtered.</p> <p>time-range time-range-name: Indicates that this ACE is associated with a time range. The ACE takes effect only within this time range. For details about the time range, see the configuration manual of the time range.</p> <p>log: Indicates that logs will be periodically output if packets matching the ACEs are found. For details about logs, see "ACL Logging" in this document.</p>
Command Mode	Extended IP ACL configuration mode
Usage Guide	Run this command to add ACEs to a numbered IP ACL in extended IP ACL configuration mode. It cannot be used to add ACEs to a named extended IP ACL.

📌 **Applying an IP ACL**

Command	ip access-group { <i>acl-id</i> <i>acl-name</i> } { in out } [counter-only] [forward-plane priority]
Parameter Description	<i>acl-id</i> : Indicates that a numbered standard or extended IP ACL will be applied to the interface.

	<p>acl-name: Indicates that a named standard or extended IP ACL will be applied to the interface.</p> <p>in: Indicates that this ACL controls incoming IP packets of the interface.</p> <p>out: Indicates that this ACL controls outgoing IP packets of the interface.</p> <p>counter-only: Indicates that the counter ACL is enabled.</p> <p>forward-plane: Indicates that ACL is only applied to the forwarding plane.</p> <p>priority: Sets the highest priority for the ACL on the forwarding plane of SVI interface.</p>
Command Mode	Interface configuration mode
Usage Guide	This command makes an IP ACL take effect on the incoming or outgoing packets of a specified interface. The counter-only ACL only counts the number of matching packets and does not filter packets. In addition, the count only takes effect only to permit rules and does not take effect to deny rules in the ACL.

Configuration Example

i The following configuration example describes only ACL-related configurations.

Configuring an IP ACL to Prohibit Departments Except the Financial Department from Accessing the Financial Data Server

<p>Scenario Figure 1-3</p>	
<p>Configuration Steps</p>	<ul style="list-style-type: none"> ● Configure an IP ACL. ● Add ACEs to the IP ACL. ● Apply the IP ACL to the outgoing direction of the interface connecting the financial data server.
<p>SW1</p>	<pre>sw1(config)#ip access-list standard 1 sw1(config-std-nacl)#permit 10.1.1.0 0.0.0.255 sw1(config-std-nacl)#deny 11.1.1.1 0.0.0.255 sw1(config-std-nacl)#exit sw1(config)#int gigabitEthernet 0/3 sw1(config-if-GigabitEthernet 0/3)#ip access-group 1 out</pre>
<p>Verification</p>	<ul style="list-style-type: none"> ● On a PC of the R&D department, ping the financial data server. Verify that the ping operation fails.

SW1	<ul style="list-style-type: none"> ● On a PC of the financial department, ping the financial data server. Verify that the ping operation succeeds. <pre> sw1(config)#show access-lists ip access-list standard 1 10 permit 10.1.1.0 0.0.0.255 20 deny 11.1.1.0 0.0.0.255 sw1(config)#show access-group ip access-group 1 out Applied On interface GigabitEthernet 0/3 </pre>
------------	---

1.5.2 Configuring an MAC Extended ACL

Configuration Effect

Configure and apply an MAC extended ACL to an interface to control all incoming and outgoing IPv4 packets of this interface. You can permit or deny the entry of specific L2 packets to a network to control access of users to network resources based on L2 packets.

Notes

N/A

Configuration Steps

➤ Configuring an MAC Extended ACL

- (Mandatory) Configure an MAC extended ACL if you want to control users' access to network resources based on the L2 packet header, for example, the MAC address of each user's PC.
- You can configure this ACL on an access, an aggregate, or a core device based on the distribution of users. The MAC extended ACL takes effect only on the local device, and does not affect other devices on the network.

➤ Adding ACEs to an MAC Extended ACL

- (Optional) An ACL may contain zero or multiple ACEs. If no ACE is configured, all incoming L2 Ethernet packets of the device are denied by default.

➤ Applying an MAC extended ACL

- (Mandatory) Apply an MAC extended ACL to a specified interface if you want this ACL take effect.
- You can apply an MAC extended ACL on a specified interface of an access, an aggregate, or a core device based on the distribution of users.

Verification

- Use the following methods to verify the configuration effects of the MAC extended ACL:

- If an MAC extended ACL is configured to permit or deny some IP packets, run the **ping** command to check whether ACEs of this ACL takes effect on the specified interface. For example, an MAC extended ACL is configured to prevent a device interface from receiving IP packets (Ethernet type is 0x0800), run the **ping** command for verification.
- If an MAC extended ACL is configured to permit or deny some non-IP packets (e.g. ARP packets), also run the **ping** command to check whether ACEs of this ACL takes effect on the specified interface. For example, to filter out ARP packets, run the **ping** command for verification.
- You can also construct L2 packets meeting some specified characteristics to check whether the MAC extended ACL takes effect. Typically, prepare two PCs, construct and send L2 packets on one PC, enable packet capturing on another PC, and check whether packets are forwarded as expected (forwarded or blocked) according to the action specified in the ACEs.

Related Commands

↘ **Configuring an MAC Extended ACL**

Command	mac access-list extended { <i>acl-name</i> <i>acl-id</i> }
Parameter Description	<i>acl-name</i> : Indicates the name of an MAC extended ACL. If this option is configured, a named ACL is created. The name is a string of 1 to 99 characters. The ACL name cannot start with numbers (0–9), "in", or "out". <i>acl-id</i> : Indicates the ID that uniquely identifies an MAC extended ACL. If this option is configured, a numbered ACL is created. The value range of <i>acl-id</i> is 700–799.
Command Mode	Global configuration mode
Usage Guide	Run this command to configure an MAC extended ACL and enter MAC extended ACL configuration mode. You can configure an MAC extended ACL to control users' access to network resources by checking the L2 information of Ethernet packets.

↘ **Adding ACEs to an MAC Extended ACL**

Use either of the following methods to add ACEs to an MAC extended ACL:

- Add ACEs in MAC extended ACL configuration mode.

Command	[<i>sn</i>] { permit deny } { any host <i>src-mac-addr</i> } { any host <i>dst-mac-addr</i> } [<i>ethernet-type</i>] [cos <i>cos</i> [inner <i>cos</i>]] [time-range <i>tm-rng-name</i>]
Parameter Description	<i>sn</i> : Indicates the sequence number of an ACE. The value ranges from 1 to 2,147,483,647. This sequence number determines the priority of this ACE in the ACL. A smaller sequence number indicates a higher priority. An ACE with a higher priority will be preferentially used to match packets. If you do not specify the sequence number when adding an ACE, the system automatically allocates a sequence number, which is equal to an increment (10 by default) plus the sequence number of the last ACE in the current ACL. For example, if the sequence number of the last ACE is 100, the sequence number of a newly-added ACE will be 110 by default. You can adjust the increment using a command. permit : Indicates that the ACE is a permit ACE. deny : Indicates that the ACE is a deny ACE. any : Indicates that L2 packets sent from any host are filtered. host <i>src-mac-addr</i> : Indicates that IP packets sent from a host with the specified source MAC address are filtered. any : Indicates that L2 packets sent to any host are filtered. host <i>dst-mac-addr</i> : Indicates that IP packets sent to a host with the specified destination MAC address are filtered. <i>ethernet-type</i> : Indicates that L2 packets of the specified Ethernet type are filtered. cos <i>cos</i> : Indicates that L2 packets with the specified class of service (cos) field in the outer tag are filtered.

	<p>inner cos: Indicates that L2 packets with the specified cos field in the inner tag are filtered.</p> <p>time-range <i>time-range-name</i>: Indicates that this ACE is associated with a time range. The ACE takes effect only within this time range. For details about the time range, see the configuration manual of the time range.</p>
Command	MAC extended ACL configuration mode
Mode	
Usage Guide	Run this command to add ACEs in MAC extended ACL configuration mode. The ACL can be a named or numbered ACL.

- Add ACEs to an MAC extended ACL in global configuration mode.

Command	access-list <i>acl-id</i> { permit deny } { any host <i>src-mac-addr</i> } { any host <i>dst-mac-addr</i> } [<i>ethernet-type</i>] [cos <i>cos</i> [inner cos]] [time-range <i>tm-rng-name</i>]
Parameter Description	<p><i>acl-id</i>: Indicates the ID of a numbered ACL. It uniquely identifies an ACL. The value range of <i>acl-id</i> is 700–799.</p> <p>permit: Indicates that the ACE is a permit ACE.</p> <p>deny: Indicates that the ACE is a deny ACE.</p> <p>host <i>src-mac-addr</i>: Indicates that IP packets sent from a host with the specified source MAC address are filtered.</p> <p>hostsource: Indicates that IP packets sent from a host with the specified source MAC address are filtered.</p> <p>any: Indicates that L2 packets sent to any host are filtered.</p> <p>host <i>dst-mac-addr</i>: Indicates that IP packets sent to a host with the specified destination MAC address are filtered.</p> <p><i>ethernet-type</i>: Indicates that L2 packets of the specified Ethernet type are filtered.</p> <p>cos <i>cos</i>: Indicates that L2 packets with the specified cos field in the outer tag are filtered.</p> <p>inner cos: Indicates that L2 packets with the specified cos field in the inner tag are filtered.</p> <p>time-range <i>time-range-name</i>: Indicates that this ACE is associated with a time range. The ACE takes effect only within this time range. For details about the time range, see the configuration manual of the time range.</p>
Command Mode	Global configuration mode
Usage Guide	Run this command to add ACEs to a numbered MAC extended ACL in global configuration mode. It cannot be used to add ACEs to a named MAC extended ACL.

📌 Applying an MAC Extended ACL

Command	mac access-group { <i>acl-id</i> <i>acl-name</i> } { in out } [counter-only priority]
Parameter Description	<p><i>acl-id</i>: Indicates that a numbered MAC extended IP ACL will be applied to the interface.</p> <p><i>acl-name</i>: Indicates that a named MAC extended IP ACL will be applied to the interface.</p> <p>in: Indicates that this ACL controls incoming L2 packets of the interface.</p> <p>out: Indicates that this ACL controls outgoing L2 packets of the interface.</p> <p>counter-only: Indicates that the counter ACL is enabled.</p> <p>priority: Sets the highest priority for the ACL on the forwarding plane of SVI interface.</p>
Command Mode	Interface configuration mode
Usage Guide	<p>This command makes an MAC extended ACL take effect on the incoming or outgoing packets of a specified interface.</p> <p>The counter-only ACL only counts the number of matching packets and does not filter packets. In addition, the count only takes effect only to permit rules and does not take effect to deny rules in the ACL.</p>

Configuration Example

i The following configuration example describes only ACL-related configurations.

Configuring an MAC Extended ACL to Restrict Resources Accessible by Visitors

<p>Scenario Figure 1-4</p>	<p>The diagram shows a central switch SW1 with four interfaces: Gi 0/1, Gi 0/2, Gi 0/3, and Gi 0/4. Gi 0/1 connects to a group of PCs labeled 'Employees'. Gi 0/2 connects to a group of PCs labeled 'Visitors'. Gi 0/3 connects to a group of servers labeled 'Servers', which includes a 'Financial Data Server' (MAC: 00e0.f800.000d) and a 'Public Server' (MAC: 00e0.f800.000c). Gi 0/4 connects to the 'Internet' cloud.</p>
<p>Configuration Steps</p>	<ul style="list-style-type: none"> ● Configure an MAC extended ACL. ● Add ACEs to the MAC extended ACL. ● Apply the MAC extended ACL to the outgoing direction of the interface connected to the visitor area so that visitors are allowed to access Internet and the public server of the company, but prohibited from accessing the financial data server of the company. That is, visitors cannot access the server with the MAC address 00e0.f800.000d.
<p>SW1</p>	<pre>sw1(config)#mac access-list extended 700 sw1(config-mac-nacl)#deny any host 00e0.f800.000d sw1(config-mac-nacl)#permit any any sw1(config-mac-nacl)#exit sw1(config)#int gigabitEthernet 0/2 sw1(config-if-GigabitEthernet 0/2)#mac access-group 700 in</pre>
<p>Verification</p>	<ul style="list-style-type: none"> ● On a visitor's PC, ping the financial data server. Verify that the ping operation fails. ● On a visitor's PC, ping the public resource server. Verify that the ping operation succeeds. ● On a visitor's PC, access the Internet, for example, visit the Baidu website. Verify that the webpage can be opened.
<p>SW1</p>	<pre>sw1(config)#show access-lists mac access-list extended 700 10 deny any host 00e0.f800.000d etype-any 20 permit any any etype-any sw1(config)#show access-group mac access-group 700 in</pre>

Applied On interface GigabitEthernet 0/2
--

1.5.3 Configuring an Expert Extended ACL

Configuration Effect

Configure and apply an expert extended ACL to an interface to control incoming and outgoing packets of the interface based on the L2 and L3 information, and allow or prohibit the entry of specific packets to the network. In addition, you can configure an expert extended ACL to control all L2 packets based on the VLAN to permit or deny the access of users in some network segments to network resources. Generally, you can use an expert extended ACL if you want to incorporate ACEs of the IP ACL and MAC extended ACL into one ACL.

Configuration Steps

➤ Configuring an Expert Extended ACL

- (Mandatory) Configure an expert extended ACL if you want to control users' access to network resources based on the L2 packet header, for example, the VLAN ID.
- You can configure this ACL on an access, an aggregate, or a core device based on the distribution of users. The expert extended ACL takes effect only on the local device, and does not affect other devices on the network.

➤ Adding ACEs to an Expert Extended ACL

- (Optional) An ACL may contain zero or multiple ACEs. If no ACE is configured, all incoming packets of the device are denied by default.

➤ Applying an Expert Extended ACL

- (Mandatory) Apply an expert extended ACL to a specified interface if you want this ACL take effect.
- You can apply an expert extended ACL in the incoming or outgoing direction of a specified interface of an access, an aggregate, or a core device based on the distribution of users.

Verification

- Use the following methods to verify the configuration effects of the expert extended ACL:
- If IP-based access rules are configured in an expert extended ACL to permit or deny some IP packets, run the **ping** command to verify whether these rules take effect.
- If MAC-based access rules are configured in an expert extended ACL to permit or deny some L2 packets (e.g. ARP packets), also run the **ping** command to check whether ACEs of this ACL takes effect on the specified interface. For example, to filter out ARP packets, run the **ping** command for verification.
- If VLAN ID-based access rules are configured in an expert extended ACL to permit or deny some L2 packets in some network segments (e.g., to prevent communication between VLAN 1 users and VLAN 2 users), ping PCs of VLAN 2 on a PC of VLAN 1. If the ping operation fails, the rules take effect.

Related Commands

➤ Configuring an Expert Extended ACL

Command	expert access-list extended {acl-name acl-id }
---------	---

Parameter Description	<p><i>acl-name</i>: Indicates the name of an expert extended ACL. If this option is configured, a named ACL is created. The name is a string of 1 to 99 characters. The ACL name cannot start with numbers (0–9), "in", or "out".</p> <p><i>acl-id</i>: Indicates the ID of an expert extended ACL. If this option is configured, a numbered ACL is created. The value range of <i>acl-id</i> is 2700-2899.</p>
Command Mode	Global configuration mode
Usage Guide	Run this command to configure an expert extended ACL and enter expert extended ACL configuration mode.

➤ **Adding ACEs to an Expert Extended ACL**

Use either of the following methods to add ACEs to an expert extended ACL:

- Add ACEs in expert extended ACL configuration mode.

Command	<pre>[sn] { permit deny } [protocol] [ethernet-type] [cos[out] [inner in]] [[VID [out] [inner in]]] {source <i>source-wildcard</i> host <i>source</i> any} {host <i>source-mac-address</i> any } {<i>destination destination-wildcard</i> host <i>destination</i> any} {host <i>destination-mac-address</i> any} [[precedence <i>precedence</i>][tos <i>tos</i>] [dscp <i>dscp</i>] [ecn <i>ecn</i>]] [fragment] [fragment-ipid <i>fragment-ipid</i>] [range <i>lowerupper</i>] [[<i>udf udf-id header pos value mask</i>] [<i>int-flag-a</i>] [<i>int-flag-b</i>]] [time-range <i>time-range-name</i>]]</pre>
Parameter Description	<p><i>sn</i>: Indicates the sequence number of an ACE. The value ranges from 1 to 2,147,483,647. This sequence number determines the priority of this ACE in the ACL. A smaller sequence number indicates a higher priority. An ACE with a higher priority will be preferentially used to match packets. If you do not specify the sequence number when adding an ACE, the system automatically allocates a sequence number, which is equal to an increment (10 by default) plus the sequence number of the last ACE in the current ACL. For example, if the sequence number of the last ACE is 100, the sequence number of a newly-added ACE will be 110 by default. You can adjust the increment using a command.</p> <p>permit: Indicates that the ACE is a permit ACE.</p> <p>deny: Indicates that the ACE is a deny ACE.</p> <p><i>protocol</i>: Indicates the IP protocol number. The value ranges from 0 to 255. To facilitate the use, the system provides frequently-used abbreviations to replace the specific IP protocol numbers, including eigrp, gre, icmp, igmp, ip, ipinip, nos, ospf, tcp, and udp.</p> <p><i>ethernet-type</i>: Indicates that L2 packets of the specified Ethernet type are filtered.</p> <p>cos out: Indicates that L2 packets with the specified cos field in the outer tag are filtered.</p> <p>cos inner in: Indicates that L2 packets with the specified cos field in the inner tag are filtered.</p> <p>VID out: Indicates that L2 packets with the specified VLAN ID field in the outer tag are filtered.</p> <p>VID inner in: Indicates that L2 packets with the specified VLAN ID field in the inner tag are filtered.</p> <p><i>source source-wildcard</i>: Indicates that IP packets sent from hosts in the specified IP network segment are filtered.</p> <p>host source: Indicates that IP packets sent from a host with the specified source IP address are filtered.</p> <p>any: Indicates that IP packets sent from any host are filtered.</p> <p>host source-mac-address: Indicates that IP packets sent from a host with the specified source MAC address are filtered.</p> <p>any: Indicates that L2 packets sent to any host are filtered.</p> <p><i>destination destination-wildcard</i>: Indicates that IP packets sent to hosts in a specified IP network segment are filtered.</p> <p>host destination: Indicates that IP packets sent to a host with the specified destination IP address are filtered.</p> <p>any: Indicates that IP packets sent to any host are filtered.</p> <p>host destination-mac-address: Indicates that IP packets sent to a host with the specified destination MAC address are filtered.</p>

	<p>any: Indicates that L2 packets sent to any host are filtered.</p> <p>precedence precedence: Indicates that IP packets with the specified precedence field in the header are filtered.</p> <p>tos tos: Indicates that IP packets with the specified the TOS field in the header are filtered.</p> <p>dscp dscp: Indicates that IP packets with the specified the dscp field in the header are filtered.</p> <p>ecn ecn: Indicates that IP packets with the specified ecn field in the header are filtered.</p> <p>fragment: Indicates that only fragmented IP packets except the first fragments are filtered.</p> <p>fragment-ipid fragment-ipid: Indicates that packets with the specified fragment ID field in the header are filtered.</p> <p>udf udf-id header pos value mask: Indicates the customized fields.</p> <p>int-flag: Indicates that the int flag field of the packets is filtered.</p> <p>time-range time-range-name: Indicates that this ACE is associated with a time range. The ACE takes effect only within this time range. For details about the time range, see the configuration manual of the time range.</p>
Command	Expert extended ACL configuration mode
Mode	
Usage Guide	Run this command to add ACEs in expert extended ACL configuration mode. The ACL can be a named or numbered ACL.

- Add ACEs to an expert extended ACL in global configuration mode.

Command	<p>access-list <i>acl-id</i> { permit deny } { <i>protocol</i> } [<i>ethernet-type</i>] [cos <i>out</i>] [inner <i>in</i>]] [[VID <i>out</i>] [inner <i>in</i>]] { <i>source source-wildcard</i> host <i>source</i> any } { host <i>source-mac-address</i> any } { <i>destination destination-wildcard</i> host <i>destination</i> any } { host <i>destination-mac-address</i> any } [[precedence <i>precedence</i>] [tos <i>tos</i>] [dscp <i>dscp</i>] [ecn <i>ecn</i>]] [fragment] [fragment-ipid <i>fragment-ipid</i>] [range <i>lowerupper</i>] [[udf <i>udf-id header pos value mask</i>] [int-flag-a] [int-flag-b]] [time-range <i>time-range-name</i>]]</p>
Parameter Description	<p>acl-id: Indicates the ID of a numbered ACL. It uniquely identifies an ACL. The value range of <i>acl-id</i> is 2700-2899.</p> <p>permit: Indicates that the ACE is a permit ACE.</p> <p>deny: Indicates that the ACE is a deny ACE.</p> <p>protocol: Indicates the IP protocol number. The value ranges from 0 to 255. To facilitate the use, the system provides frequently-used abbreviations to replace the specific IP protocol numbers, including eigrp, gre, icmp, igmp, ip, ipinip, nos, ospf, tcp, and udp.</p> <p>ethernet-type: Indicates that L2 packets of the specified Ethernet type are filtered.</p> <p>cos out: Indicates that L2 packets with the specified cos field in the outer tag are filtered.</p> <p>cos inner in: Indicates that L2 packets with the specified cos field in the inner tag are filtered.</p> <p>VID out: Indicates that L2 packets with the specified VLAN ID field in the outer tag are filtered.</p> <p>VID inner in: Indicates that L2 packets with the specified VLAN ID field in the inner tag are filtered.</p> <p>source source-wildcard: Indicates that IP packets sent from hosts in the specified IP network segment are filtered.</p> <p>host source: Indicates that IP packets sent from a host with the specified source IP address are filtered.</p> <p>any: Indicates that IP packets sent from any host are filtered.</p> <p>host source-mac-address: Indicates that IP packets sent from a host with the specified source MAC address are filtered.</p> <p>any: Indicates that L2 packets sent to any host are filtered.</p> <p>destination destination-wildcard: Indicates that IP packets sent to hosts in a specified IP network segment are filtered.</p> <p>host destination: Indicates that IP packets sent to a host with the specified destination IP address are filtered.</p> <p>any: Indicates that IP packets sent to any host are filtered.</p> <p>host destination-mac-address: Indicates that IP packets sent to a host with the specified destination MAC address are filtered.</p>

	<p>any: Indicates that L2 packets sent to any host are filtered.</p> <p>precedence precedence: Indicates that IP packets with the specified precedence field in the header are filtered.</p> <p>tos tos: Indicates that IP packets with the specified the TOS field in the header are filtered.</p> <p>dscp dscp: Indicates that IP packets with the specified the dscp field in the header are filtered.</p> <p>ecn ecn: Indicates that IP packets with the specified ecn field in the header are filtered.</p> <p>fragment: Indicates that only fragmented IP packets except the first fragments are filtered.</p> <p>fragment-ipid fragment-ipid: Indicates that packets with the specified fragment ID field in the header are filtered.</p> <p>udf udf-id header pos value mask: Indicates the customized fields.</p> <p>int-flag: Indicates that the int flag field of the packets is filtered.</p> <p>time-range time-range-name: Indicates that this ACE is associated with a time range. The ACE takes effect only within this time range. For details about the time range, see the configuration manual of the time range.</p>
Command	Global configuration mode
Mode	
Usage Guide	Run this command to add ACEs to a numbered expert extended ACL in global configuration mode. It cannot be used to add ACEs to a named expert extended ACL.

- Add VXLAN inner 5-tuple ACEs in expert extended ACL mode.

Command	[sn] { permit deny } vxlan protocol {source source-wildcard host source any } {destination destination-wildcard host destination any } [tagged] [udp-dport dport] [time-range time-range-name]
Parameter Description	<p>permit: Indicates that an ACE is a permit ACE.</p> <p>deny: Indicates that an ACE is a deny ACE.</p> <p>protocol: Indicates the VXLAN inner IP protocol to be matched. The value range is [0, 255]. For the sake of convenience, the system provides abbreviations for the frequently used IP protocols to replace the specific IP protocols, including eigrp, gre, icmp, igmp, ip, ipinip, nos, ospf, tcp, and udp.</p> <p>source source-wildcard: Indicates that VXLAN packets need to match the inner source IP network segment.</p> <p>host source: Indicates that VXLAN packets need to match the inner source IP address of a host.</p> <p>any: Indicates that VXLAN packets can match any inner source IP address.</p> <p>tagged: Indicates that VXLAN packets need to match the inner tag field. VXLAN packets do not need to match the tag field by default.</p> <p>udp-dport dport: Indicates that VXLAN packets need to match the destination port ID. If this parameter is not set, VXLAN packets need to match the default destination port ID, that is, 4798.</p> <p>time-range time-range-name: Indicates that the ACE is associated with a time range. This ACE takes effect only within the specified time range. For more details about the time range, see the time range configuration manual.</p>
Command Mode	Expert extended ACL list mode
Usage Guide	This command is used to configure ACEs of VXLAN packets in an ACL in expert ACL mode. This ACL can be a named ACL or numbered ACL.

📌 Applying an Expert Extended ACL

Command	expert access-group { acl-id acl-name } { in out } [counter-only forward-plane priority]
Parameter Description	<p>acl-id: Indicates that a numbered expert extended ACL will be applied to the interface.</p> <p>acl-name: Indicates that a named expert extended ACL will be applied to the interface.</p> <p>in: Indicates that this ACL controls incoming L2 packets of the interface.</p>

	<p>out: Indicates that this ACL controls outgoing L2 packets of the interface.</p> <p>counter-only: Indicates that the counter ACL is enabled.</p> <p>forward-plane: Indicates that ACL is only applied to the forwarding plane.</p> <p>priority: Sets the highest priority for the ACL on the forwarding plane of SVI interface.</p>
Command Mode	Interface configuration mode
Usage Guide	<p>This command makes an expert extended ACL take effect on the incoming or outgoing packets of a specified interface.</p> <p>The counter-only ACL only counts the number of matching packets and does not filter packets. In addition, the count only takes effect only to permit rules and does not take effect to deny rules in the ACL.</p>

Configuration Example

The following configuration example describes only ACL-related configurations.

Configuring an Expert Extended ACL to Restrict Resources Accessible by Visitors (It is required that visitors and employees cannot communicate with each other, visitors can access the public resource server but not the financial data server of the company.)

<p>Scenario Figure 1-5</p>	
<p>Configuration Steps</p>	<ul style="list-style-type: none"> ● Configure an expert extended ACL. ● Add an ACE to deny packets sent from PCs in the visitor area (VLAN 3) to employee PCs in VLAN 2. ● Add an ACE to prevent visitors from accessing the financial data server of the company. ● Add an ACE to permit all packets. ● Apply the ACL to the incoming direction of the interface of the switch that connects to the visitor area.
<p>SW1</p>	<pre>sw1(config)#expert access-list extended 2700 sw1(config-exp-nacl)#deny ip any any 192.168.1.0 0.0.0.255 any sw1(config-exp-nacl)#deny ip any any host 10.1.1.1 any</pre>

	<pre>sw1(config-exp-nacl)#permit any any any any sw1(config-exp-nacl)#exit sw1(config)#int gigabitEthernet 0/2 sw1(config-if-GigabitEthernet 0/2)#expert access-group 2700 in</pre>
<p>Verification</p>	<ul style="list-style-type: none"> ● On a visitor's PC, ping the financial data server. Verify that the ping operation fails. ● On a visitor's PC, ping the public resource server. Verify that the ping operation succeeds. ● On a visitor's PC, ping the gateway address 192.168.1.1 of an employee. Verify that the ping operation fails. ● On a visitor's PC, access the Internet, for example, visit the Baidu website. Verify that the webpage can be opened.
<p>SW1</p>	<pre>sw1(config)#show access-lists expert access-list extended 2700 10 deny ip any any 192.168.1.0 0.0.0.255 any 20 deny ip any any host 10.1.1.1 any 30 permit ip any any any any sw1(config)#show access-group expert access-group 2700 in Applied On interface GigabitEthernet 0/2</pre>

1.5.4 Configuring an IPv6 Extended ACL

Configuration Effect

Configure and apply an IPv6 ACL to an interface to control all incoming and outgoing IPv5 packets of this interface. You can permit or deny the entry of specific IPv6 packets to a network to control access of IPv6 users to network resources.

Configuration Steps

➤ Configuring an IPv6 ACL

- (Mandatory) Configure an IP ACL if you want to access of IPv4 users to network resources.
- You can configure this ACL on an access, an aggregate, or a core device based on the distribution of users. The IPv6 ACL takes effect only on the local device, and does not affect other devices on the network.

➤ Adding ACEs to an IPv6 ACL

- (Optional) An ACL may contain zero or multiple ACEs. If no ACE is configured, all incoming IPv6 packets of the device are denied by default.

➤ Applying an IPv6 ACL

- (Mandatory) Apply an IPv6 ACL to a specified interface on a device if you want this ACL take effect.

- You can apply an IPv6 ACL on a specified interface of an access, an aggregate, or a core device based on the distribution of users.

Verification

- Use the following methods to verify the configuration effects of the IPv6 ACL:
- Run the **ping** command to verify that the IPv6 ACL takes effect on the specified interface. For example, if an IPv6 ACL is configured to prohibit a host with a specified IP address or hosts in a specified IPv6 address range from accessing the network, run the **ping** command to verify that the host(s) cannot be successfully pinged.
- Access network resources, for example, visit an IPv6 website, to check whether the IPv6 ACL takes effect on the specified interface.

Related Commands

➤ **Configuring an IPv6 ACL**

Command	ipv6 access-list <i>acl-name</i>
Parameter Description	<i>acl-name</i> : Indicates the name of a standard or an extended IP ACL. The name is a string of 1 to 99 characters. The ACL name cannot start with numbers (0–9), "in", or "out".
Command Mode	Global configuration mode
Usage Guide	Run this command to configure an IPv6 ACL and enter IPv6 configuration mode.

➤ **Adding ACEs to an IPv6 ACL**

- To filter TCP or UDP packets, add ACEs to an IPv6 ACL as follows:

Command	<i>[sn]</i> {permit deny} <i>protocol</i> <i>{src-ipv6-prefix/prefix-len host src-ipv6-addr any}</i> <i>{dst-ipv6-pfx/pfx-len host dst-ipv6-addr any}</i> <i>[op dstport range lower upper]</i> [dscp dscp] [flow-label flow-label] [fragment] [time-range tm-rng-name] [log]
Parameter Description	<p><i>sn</i>: Indicates the sequence number of an ACE. The value ranges from 1 to 2,147,483,647. This sequence number determines the priority of this ACE in the ACL. A smaller sequence number indicates a higher priority. An ACE with a higher priority will be preferentially used to match packets. If you do not specify the sequence number when adding an ACE, the system automatically allocates a sequence number, which is equal to an increment (10 by default) plus the sequence number of the last ACE in the current ACL. For example, if the sequence number of the last ACE is 100, the sequence number of a newly-added ACE will be 110 by default. You can adjust the increment using a command.</p> <p>permit: Indicates that the ACE is a permit ACE.</p> <p>deny: Indicates that the ACE is a deny ACE.</p> <p><i>protocol</i>: Indicates the IPv6 protocol number. The value ranges from 0 to 255. To facilitate the use, the system provides frequently-used abbreviations of IPv6 protocol numbers to replace the specific IP protocol numbers, including icmp, ipv6, tcp, and udp.</p> <p><i>src-ipv6-prefix/prefix-len</i>: Indicates that IP packets sent from hosts in the specified IPv6 network segment are filtered.</p> <p>host src-ipv6-addr: Indicates that IPv6 packets sent from a host with the specified source IP address are filtered.</p> <p>any: Indicates that IPv6 packets sent from any host are filtered.</p> <p><i>dst-ipv6-pfx/pfx-len</i>: Indicates that IPv6 packets sent from hosts in the specified IPv6 network segment are filtered.</p> <p>host dst-ipv6-addr: Indicates that IPv6 packets sent to a host with the specified destination IP address are filtered.</p> <p>any: Indicates that IPv6 packets sent to any host are filtered.</p> <p><i>op dstport</i>: Indicates that TCP or UDP packets are filtered based on the L4 destination port number. The value of the</p>

	<p>op parameter can be eq (equal to), neq (not equal to), gt (greater than), or lt (smaller than).</p> <p>range <i>lower upper</i>: Indicates that TCP or UDP packets with the L4 destination port number in the specified range are filtered.</p> <p>dscp <i>dscp</i>: Indicates that IPv6 packets with the specified the dscp field in the header are filtered.</p> <p>flow-label <i>flow-label</i>: Indicates that IPv6 packets with the specified the flow label field in the header are filtered.</p> <p>fragment: Indicates that only fragmented IPv6 packets except the first fragments are filtered.</p> <p>time-range <i>time-range-name</i>: Indicates that this ACE is associated with a time range. The ACE takes effect only within this time range. For details about the time range, see the configuration manual of the time range.</p> <p>log: Indicates that logs will be periodically output if packets matching the ACEs are found. For details about logs, see "ACL Logging" in this document.</p>
Command	IPv6 ACL configuration mode
Mode	
Usage Guide	Run this command to add ACEs in IPv6 ACL configuration mode.

- To filter IPv6 packets except for the TCP or UDP packets, add ACEs to an IPv6 ACL as follows:

Command	[<i>sn</i>] { permit deny } <i>protocol</i> { <i>src-ipv6-prefix/prefix-len</i> host <i>src-ipv6-addr</i> any } { <i>dst-ipv6-pfix/pfix-len</i> host <i>dst-ipv6-addr</i> any } [dscp <i>dscp</i>] [flow-label <i>flow-label</i>] [fragment] [time-range <i>tm-rng-name</i>] [log]
Parameter Description	<p><i>sn</i>: Indicates the sequence number of an ACE. The value ranges from 1 to 2,147,483,647. This sequence number determines the priority of this ACE in the ACL. A smaller sequence number indicates a higher priority. An ACE with a higher priority will be preferentially used to match packets. If you do not specify the sequence number when adding an ACE, the system automatically allocates a sequence number, which is equal to an increment (10 by default) plus the sequence number of the last ACE in the current ACL. For example, if the sequence number of the last ACE is 100, the sequence number of a newly-added ACE will be 110 by default. You can adjust the increment using a command.</p> <p>permit: Indicates that the ACE is a permit ACE.</p> <p>deny: Indicates that the ACE is a deny ACE.</p> <p><i>protocol</i>: Indicates the IPv6 protocol number. The value ranges from 0 to 255. To facilitate the use, the system provides frequently-used abbreviations of IPv6 protocol numbers to replace the specific IP protocol numbers, including icmp, ipv6, tcp, and udp.</p> <p><i>src-ipv6-prefix/prefix-len</i>: Indicates that IP packets sent from hosts in the specified IPv6 network segment are filtered.</p> <p>host <i>src-ipv6-addr</i>: Indicates that IPv6 packets sent from a host with the specified source IP address are filtered.</p> <p>any: Indicates that IPv6 packets sent from any host are filtered.</p> <p><i>dst-ipv6-pfix/pfix-len</i>: Indicates that IPv6 packets sent from hosts in the specified IPv6 network segment are filtered.</p> <p>host <i>dst-ipv6-addr</i>: Indicates that IPv6 packets sent to a host with the specified destination IP address are filtered.</p> <p>any: Indicates that IPv6 packets sent to any host are filtered.</p> <p>dscp <i>dscp</i>: Indicates that IPv6 packets with the specified the dscp field in the header are filtered.</p> <p>flow-label <i>flow-label</i>: Indicates that IPv6 packets with the specified the flow label field in the header are filtered.</p> <p>fragment: Indicates that only fragmented IPv6 packets except the first fragments are filtered.</p> <p>time-range <i>time-range-name</i>: Indicates that this ACE is associated with a time range. The ACE takes effect only within this time range. For details about the time range, see the configuration manual of the time range.</p> <p>log: Indicates that logs will be periodically output if packets matching the ACEs are found. For details about logs, see "ACL Logging" in this document.</p>
Command	IPv6 ACL configuration mode
Mode	
Usage Guide	Run this command to add ACEs in IPv6 ACL configuration mode.

➤ **Applying an IPv6 ACL**

Command	ipv6 traffic-filter <i>acl-name</i> { in out }[counter-only forward-plane priority]
Parameter	<i>acl-name</i> : Indicates the name of an IPv6 ACL.
Description	in : Indicates that this ACL controls incoming IPv6 packets of the interface. out : Indicates that this ACL controls outgoing IPv6 packets of the interface. forward-plane : Indicates that ACL is only applied to the forwarding plane. priority : Sets the highest priority for the ACL on the forwarding plane of SVI interface.
Command Mode	Interface configuration mode
Usage Guide	This command makes an IPv6 ACL take effect on the incoming or outgoing packets of the specified interface.

Configuration Example

➤ **Configuring an IPv6 ACL to Prohibit the R&D Department from Accessing the Video Server**

Scenario Figure 1-6	
Configuration Steps	<ul style="list-style-type: none"> ● Configure an IPv6 ACL. ● Add an ACE to the IPv6 ACL to prevent access to the video server. ● Add an ACE to the IPv6 ACL to permit all IPv6 packets. ● Apply the IPv6 ACL to the incoming direction of the interface connected to the R&D department.
SW1	<pre>sw1(config)#ipv6 access-list dev_deny_ipv6video sw1(config-ipv6-nacl)#deny ipv6 any host 200::1 sw1(config-ipv6-nacl)#permit ipv6 any any sw1(config-ipv6-nacl)#exit sw1(config)#int gigabitEthernet 0/2 sw1(config-if-GigabitEthernet 0/2)# ipv6 traffic-filter dev_deny_ipv6video in</pre>
Verification	<ul style="list-style-type: none"> ● On a PC of the R&D department, ping the video server. Verify that the ping operation fails.
SW1	<pre>sw1(config)#show access-lists ipv6 access-list dev_deny_ipv6video</pre>

```

10 deny ipv6 any host 200::1
20 permit ipv6 any any

sw1(config)#show access-group
ipv6 traffic-filter dev_deny_ipv6video in
Applied On interface GigabitEthernet 0/2
    
```

1.5.5 Configuring an ACL80

Configuration Effect

When the IP ACL, MAC extended ACL, expert extended ACL, and IPv6 ACL with fixed matching fields cannot meet requirements, configure the ACL80 to customize the packet fields that need to be matched.

Configuration Steps

➤ Configuring an Expert Advanced ACL

- (Mandatory) Configure an expert advanced ACL if you want to implement the ACL80 function. For details about how to configure the expert advanced ACL, see the related descriptions.
- You can configure this ACL on an access, an aggregate, or a core device based on the distribution of users. The expert advanced ACL takes effect only on the local device, and does not affect other devices on the network.

➤ Adding ACEs to an Expert Advanced ACL

- (Mandatory) Add ACEs to an expert advanced ACL to customize matching fields. If no ACE is added to the expert advanced ACL, the deny ACEs will drop all packets by default. For details about how to add an ACE to an expert advanced ACL, see the related descriptions.

➤ Applying an Expert Advanced ACL

- (Mandatory) Apply an expert advanced ACL to a specified interface if you want this ACL take effect.
- You can apply an expert advanced ACL on a specified interface of an access, an aggregate, or a core device based on the distribution of users.

Verification

- Use the following methods to verify the configuration effects of the expert advanced ACL:
- Run the **ping** command to check whether the configurations take effect.
- Construct packets matching the ACEs to check whether ACEs take effect.

Related Commands

➤ Configuring an Expert Advanced ACL

Command	expert access-list advanced <i>acl-name</i>
----------------	--

Parameter Description	<i>acl-name</i> : Indicates the name of an expert advanced ACL. The name is a string of 1 to 99 characters. The ACL name cannot start with numbers (0–9), "in", or "out".
Command Mode	Global configuration mode
Usage Guide	Run this command to configure an expert advanced ACL and enter expert advanced ACL configuration mode.

✚ Adding ACEs to an Expert Advanced ACL

Command	<code>[sn] { permit deny } hex hex-mask offset</code>
Parameter Description	<p><i>sn</i>: Indicates the sequence number of an ACE. The value ranges from 1 to 2,147,483,647. This sequence number determines the priority of this ACE in the ACL. A smaller sequence number indicates a higher priority. An ACE with a higher priority will be preferentially used to match packets. If you do not specify the sequence number when adding an ACE, the system automatically allocates a sequence number, which is equal to an increment (10 by default) plus the sequence number of the last ACE in the current ACL. For example, if the sequence number of the last ACE is 100, the sequence number of a newly-added ACE will be 110 by default. You can adjust the increment using a command.</p> <p>permit: Indicates that the ACE is a permit ACE.</p> <p>deny: Indicates that the ACE is a deny ACE.</p> <p><i>hex</i>: Indicates the customized matching rule expressed in hexadecimal format, for example, 00d0f800.</p> <p><i>hex-mask</i>: Indicates the matching mask.</p> <p><i>offset</i>: Indicates the start position of matching. For example, if the matching content is 00d0f800, the matching mask is 00ff0000, and start position is 6, the destination MAC address of each packet is compared. All packets whose second byte of the destination MAC address is d0 match this ACE.</p>
Command Mode	Expert advanced ACL configuration mode
Usage Guide	Run this command to add ACEs in expert advanced ACL configuration mode.

✚ Applying an Expert Advanced ACL

Command	<code>expert access-group acl-n { in out } [[forward-plane]] [priority]</code>
Parameter Description	<p><i>acl-id</i>: Indicates that a numbered expert advanced ACL will be applied to the interface.</p> <p><i>acl-name</i>: Indicates that a named expert advanced ACL will be applied to the interface.</p> <p>in: Indicates that this ACL controls incoming L2 packets of the interface.</p> <p>out: Indicates that this ACL controls outgoing L2 packets of the interface.</p> <p>forward-plane: Indicates that ACL is only applied to the forwarding plane.</p> <p>priority: Sets the highest priority for the ACL on the forwarding plane of SVI interface.</p>
Command Mode	Interface configuration mode
Usage Guide	This command makes an expert advanced ACL take effect on the incoming or outgoing packets of a specified interface.

Configuration Example

 The following configuration example describes only ACL-related configurations.

➤ **Configuring an ACL80 to Restrict Resources Accessible by Visitors (It is required that visitors and employees cannot communicate with each other, visitors can access the public resource server but not the financial data server of the company.)**

<p>Scenario Figure 1-7</p>	
<p>Configuration Steps</p>	<ul style="list-style-type: none"> ● Configure an expert advanced ACL. ● Add an ACE to deny packets sent from PCs in the visitor area (VLAN 3) to employee PCs in VLAN 2. ● Add an ACE to prevent visitors from accessing the financial data server of the company. ● Add an ACE to permit all packets. ● Apply the ACL to the incoming direction of the interface of the switch that connects to the visitor area.
<p>SW1</p>	<pre>sw1(config)#expert access-list advanced acl80-guest sw1(config-exp-dacl)#deny C0A801 FFFFFFFF 42 sw1(config-exp-dacl)#deny 0A010101 FFFFFFFF 42 sw1(config-exp-dacl)#permit 0806 FFFF 24 sw1(config-exp-dacl)#permit 0800 FFFF 24 sw1(config-exp-dacl)#exit sw1(config)#int gigabitEthernet 0/2 sw1(config-if-GigabitEthernet 0/2)#expert access-group acl80-guest in</pre>
<p>Verification</p>	<ul style="list-style-type: none"> ● On a visitor's PC, ping the financial data server. Verify that the ping operation fails. ● On a visitor's PC, ping the public resource server. Verify that the ping operation succeeds. ● On a visitor's PC, ping the gateway address 192.168.1.1 of an employee. Verify that the ping operation fails. ● On a visitor's PC, access the Internet, for example, visit the Baidu website. Verify that the webpage can be opened.
<p>SW1</p>	<pre>sw1(config)#show access-lists expert access-list advanced sss</pre>

```

10 deny C0A801 FFFFFFF 42
20 deny 0A010101 FFFFFFFF 42
30 permit 0806 FFFF 24
40 permit 0800 FFFF 24

expert access-group acl80-guest in
Applied On interface GigabitEthernet 0/2

```

1.5.6 Configuring ACL Redirection

Configuration Effect

Configure the ACL redirection function on a specified interface to directly redirect specified packets on the interface or all interfaces to a specified port for further forwarding.

Configuration Steps

➤ Configuring an ACL

- (Mandatory) To implement ACL redirection, you must first configure an ACL, for example, an IP, MAC extended, or expert extended ACL. For details about how to configure an ACL, see the related descriptions.
- You can configure this ACL on an access, an aggregate, or a core device based on the distribution of users. The IPv6 ACL takes effect only on the local device, and does not affect other devices on the network.

➤ Adding ACEs to an ACL

- (Optional) An ACL may contain zero or multiple ACEs. If no ACE is configured, the ACL redirection function is not available. For details about how to add an ACE to an ACL, see the related descriptions.

➤ Configuring ACL Redirection

- (Mandatory) Enable ACL redirection on a specified interface if you want to implement ACL redirection.
- You can configure the ACL redirection function on a specified interface of an access, an aggregate, or a core device based on the distribution of users.

Verification

Send packets matching ACEs on the port where ACL redirection is enabled, and then use the packet capturing software on the destination port to check whether the ACL redirection function takes effect.

Related Commands

➤ Configuring an ACL

For details about how to configure an ACL, see the earlier descriptions about the IP ACL, MAC extended ACL, expert extended ACL, or IPv6 ACL.

➤ Adding ACEs to an ACL

For details about how to add ACEs to an ACL, see the earlier descriptions about the IP ACL, MAC extended ACL, expert extended ACL, or IPv6 ACL.

📌 **Configuring ACL Redirection on Interface**

Command	redirect destination interface <i>interface-name</i> acl { <i>acl-id</i> <i>acl-name</i> } in
Parameter Description	<p>interface <i>interface-name</i>: Indicates the name of the destination port for redirection.</p> <p><i>acl-id</i>: Indicates the ID of an ACL.</p> <p><i>acl-name</i>: Indicates the name of an ACL.</p> <p>in: Indicates that incoming packets of the interface are redirected.</p>
Command Mode	Interface configuration mode
Usage Guide	Run this command to redirect incoming packets of the interface that match ACEs to the destination port for further forwarding.

Configuration Example

i The following configuration example describes only ACL-related configurations.

📌 **Enabling ACL Redirection to Redirect Packets Sent from the Host 10.1.1.1 to the Packet Capturing Device for Analysis**

Scenario Figure 1-8	
Configuration Steps	<ul style="list-style-type: none"> Configures an IP ACL. Add an ACE to the IP ACL to permit packets sent from the host 10.1.1.1. Enable ACL redirection on the port Gi 0/1, and set the destination port to Gi 0/2.
SW1	<pre>sw1(config)#ip access-list standard 1 sw1 (config-std-nacl)#permit host 10.1.1.1 sw1(config-std-nacl)#exit sw1(config)#int gigabitEthernet 0/1 sw1(config-if-GigabitEthernet 0/1)# redirect destination interface gigabitEthernet 0/2 acl 1</pre>
Verification	<ul style="list-style-type: none"> Capture packets on PC 2. Ping the video server on PC 1. Verify that ICMP requests sent from PC 1 are captured on PC 2.

SW1	<pre>sw1#show access-lists ip access-list standard 1 10 permit host 10.1.1.1 sw1#show redirect interface gigabitEthernet 0/1 acl redirect configuration on interface gigabitEthernet 0/1 redirect destination interface gigabitEthernet 0/2 acl 1 in</pre>
------------	--

1.5.7 Configuring a Global Security ACL

Configuration Effect

Configure a global security ACL to prevent internal PCs of a company from accessing illegal websites or prevent virus from attacking the company's internal network. You can also configure exclusive interfaces to allow specified departments of the company to access external websites.

Configuration Steps

➤ Configuring an ACL

- (Mandatory) Configure an IP ACL if you want to protect the internal network globally. For details about the configuration method, see the earlier descriptions about the ACL.
- You can configure this ACL on an access, an aggregate, or a core device based on the distribution of users. The configurations take effect only on the local device, and do not affect other devices on the network.

➤ Adding ACEs to an ACL

- (Optional) An ACL may contain zero or multiple ACEs. If no ACE is configured, it is equivalent that the global security ACL does not exist. For details about how to add an ACE to an ACL, see the related descriptions.

➤ Configuring a Global Security ACL

- (Mandatory) Enable the global security function if you want to make the global security ACL take effect.
- You can configure a global security ACL on an access, an aggregate, or a core device based on the distribution of users.

Verification

On the internal network protected by the global security ACL, ping the website or device that are denied by ACEs to check whether the global security ACL takes effect.

Related Commands

➤ Configuring an ACL

For details about the configuration method, see the earlier descriptions about the ACL.

➤ Adding ACEs to an ACL

For details about the configuration method, see the earlier descriptions about the ACL.

➤ Configuring a Global Security ACL

Command	{ ip mac expert } access-group <i>acl-id</i> { in out }
Parameter Description	<i>acl-id</i> : Indicates the ID of an IP ACL. in : Filters the incoming packets of the device. out : Filters the outgoing packets of the device.
Command Mode	Global configuration mode
Usage Guide	Run this command to enable the global security ACL so that the ACL takes effect on all L2 interfaces of the device.

📌 **Configuring an Exclusive Interface of the Global Security ACL**

Command	no global ip access-group
Parameter Description	N/A
Command Mode	Interface configuration mode
Usage Guide	Run this command to invalidate a global security ACL on a specified interface.

Configuration Example

i The following configuration example describes only ACL-related configurations.

📌 **Configuring a Global Security ACL to Prevent the R&D Department From Accessing the Server of the Sales Department but Allow the Sales Department to Access This Server**

<p>Scenario Figure 1-9</p>	
<p>Configuration Steps</p>	<ul style="list-style-type: none"> ● Configure an extended IP ACL "ip_ext_deny_dst_sale_server". ● Add the ACE that prevents the device to forward packets to the destination host 10.1.1.3/24. ● Configure the ACL "ip_ext_deny_dst_sale_server" as a global security ACL. ● Configure the interface directly connected to the sales department as the exclusive interface of the global security ACL.
<p>SW1</p>	<pre>sw1(config)#ip access-list extended ip_ext_deny_dst_sale_server sw1(config-ext-nacl)# deny ip any host 10.1.1.3</pre>

	<pre>sw1(config-ext-nacl)#exit sw1(config)#ip access-group ip_ext_deny_dst_sale_server in sw1(config)#int gigabitEthernet 0/1 sw1(config-if-GigabitEthernet 0/1)# no global ip access-group</pre>
Verification	<ul style="list-style-type: none"> ● On a PC of the sales department, ping the server of the sales department. Verify that the ping operation succeeds. ● On the PCs of R&D department 1 and R&D department 2, ping the server of the sales department. Verify that the ping operations fail.
	<pre>sw1#show access-lists ip access-list extended ip_ext_deny_dst_sale_server 10 deny ip any host 10.1.1.3 sw1#show running ! ip access-group ip_ext_deny_dst_sale_server in ! ! ! ! ! ! ! ! ! ! ! interface GigabitEthernet 0/1 no global ip access-group !</pre>

1.5.8Configuring a Security Channel

Configuration Effect

Configure a security channel to enable packets meeting the security channel rules to bypass the checks of access control applications. Configure the security channel if an access control application (such as DOT1X) is enabled on an uplink interface of a user, but the user should be allowed to log in to a website to download some resources (for example, downloading the FS SU client) before the DOT1X authentication.

Configuration Steps

➤ **Configuring an ACL**

- (Mandatory) Configure an ACL before configuring the security channel. For details about the configuration method, see the earlier descriptions.
- You can configure this ACL on an access, an aggregate, or a core device based on the distribution of users. The configurations take effect only on the local device, and do not affect other devices on the network.

➤ **Adding ACEs to an ACL**

- (Optional) An ACL may contain zero or multiple ACEs. If no ACE is configured for an ACL, it is equivalent that the security channel does not take effect. For details about how to add an ACE to an ACL, see the related descriptions.

➤ **Configuring a Security Channel on a Specified Interface or Globally**

- Configure a security channel on an interface if you want this security channel take effect on the interface. Configure a global security channel if you want this security channel take effect globally. You must configure either the interface-based security channel or the global security channel.
- You can configure a security channel on an access, an aggregate, or a core device based on the distribution of users.

➤ **Configuring an Exclusive Interface for the Global Security Channel**

- (Optional) Configure an interface as the exclusive interface for the global security channel if you do not want the global security channel to take effect on this interface.

➤ **Configuring an Access Control Application**

- (Optional) You can enable the DOT1X or Web authentication function to verify the security channel function.
- You can configure the access control function on an access, an aggregate, or a core device based on the distribution of users.

Verification

On a PC that is subject to the control of an access control application, ping the resources (devices or servers) that are allowed to bypass the check of the access control application to verify the configuration of the security channel.

Related Commands

➤ **Configuring an ACL**

For details about how to configure an ACL, see the earlier descriptions about the IP ACL, MAC extended ACL, expert extended ACL, or IPv6 ACL.

➤ **Adding ACEs to an ACL**

For details about how to add ACEs to an ACL, see the earlier descriptions about the IP ACL, MAC extended ACL, expert extended ACL, or IPv6 ACL.

➤ **Configuring a Security Channel on an Interface**

Command	<code>security access-group {acl-id acl-name }</code>
Parameter	<i>acl-id</i> : Indicates that ID of the ACL that is configured as the security channel.
Description	<i>acl-name</i> : Indicates that name of the ACL that is configured as the security channel.

Command	Interface configuration mode
Mode	
Usage Guide	Run this command to configure a specified ACL as the security channel on the specified interface.

📌 **Configuring a Global Security Channel**

Command	security global access-group {acl-id acl-name }
Parameter Description	<p><i>acl-id</i>: Indicates that ID of the ACL that is configured as the security channel.</p> <p><i>acl-name</i>: Indicates that name of the ACL that is configured as the security channel.</p>
Command	Global configuration mode
Mode	
Usage Guide	Run this command to configure the specified ACL as the global security channel.

📌 **Configuring an Exclusive Interface for the Global Security Channel**

Command	security uplink enable
Parameter Description	N/A
Command	Interface configuration mode
Mode	
Usage Guide	Run this command to configure the specified interface as the exclusive interface of the global security channel.

Configuration Example

i The following configuration example describes only ACL-related configurations.

📌 **Enabling DOT1X Authentication and Configuring a Security Channel to Allow Users to Download the SU Software From the Server Before Authentication**

<p>Scenario</p> <p>Figure 1- 10</p>	<p>Software Server 10.1.1.2/24 Gateway:10.1.1.1</p> <p>SVI:10.1.1.1 Gi 0/4 SW1</p> <p>SVI:11.1.1.1 Gi 0/1</p> <p>PC1 PC2 ...</p> <p>Dot1x- enabled Devices: VLAN 1 IP Segment : 11.1.1.0/24 Gateway:11.1.1.1/24</p>
<p>Configuration Steps</p>	<ul style="list-style-type: none"> ● Configure an expert extended ACL "exp_ext_esc". ● Add an ACE to allow forwarding packets to the destination host 10.1.1.2. ● Add an ACE to permit the DHCP packets. ● Add an ACE to permit the ARP packets.

	<ul style="list-style-type: none"> On the interface where DOT1X authentication is enabled, configure the ACL "exp_ext_esc" as the security channel.
<p>SW1</p>	<pre>sw1(config)#expert access-list extended exp_ext_esc sw1(config-exp-nacl)# permit ip any any host 10.1.1.2 any sw1(config-exp-nacl)# permit 0x0806 any any any any any sw1(config-exp-nacl)# permit tcp any any any any eq 67 sw1(config-exp-nacl)# permit tcp any any any any eq 68 sw1(config)#int gigabitEthernet 0/1 sw1(config-if-GigabitEthernet 0/1)# security access-group exp_ext_esc</pre>
<p>Verification</p>	<ul style="list-style-type: none"> On a PC of the sales department, ping the server of the sales department. Verify that the ping operation succeeds. On the PCs of R&D department 1 and R&D department 2, ping the server of the sales department. Verify that the ping operations fail.
	<pre>sw1#show access-lists expert access-list extended exp_ext_esc 10 permit ip any any host 10.1.1.2 any 20 permit arp any any any any any 30 permit tcp any any any any eq 67 40 permit tcp any any any any eq 68..... sw1#show running-config interface gigabitEthernet 0/1 Building configuration... Current configuration : 59 bytes interface GigabitEthernet 0/1 security access-group exp_ext_esc</pre>

1.5.9Configuring the Time Range-Based ACEs

Configuration Effect

Configure the time range-based ACEs if you want some ACEs to take effect or to become invalid in a specified period of time, for example, in some time ranges during a week.

Configuration Steps

➤ Configuring an ACL

- (Mandatory) Configure an ACL if you want ACEs to take effect in the specified time range. For details about the configuration method, see the earlier descriptions.
- You can configure this ACL on an access, an aggregate, or a core device based on the distribution of users. The configurations take effect only on the local device, and do not affect other devices on the network.

▾ Adding an ACE with the Time Range Specified

- (Mandatory) Specify the time range when adding an ACE. For details about how to configure the time range, see the configuration manual related to the time range.

▾ Applying an ACL

- (Mandatory) Apply the ACL to a specified interface if you want to make ACEs take effect in the specified time range.
- You can apply an IP ACL on a specified interface of an access, an aggregate, or a core device based on the distribution of users.

Verification

In the time range that the configured ACE takes effect or becomes invalid, run the **ping** command or construct packets matching the ACE to check whether the ACE takes effect or becomes invalid.

Related Commands

▾ Configuring an ACL

For details about the ACL configuration commands, see the earlier descriptions about the IP ACL, MAC extended ACL, expert extended ACL, or IPv6 ACL.

▾ Adding an ACE with the Time Range Specified

For details about the ACE configuration commands, see the earlier descriptions about the IP ACL, MAC extended ACL, expert extended ACL, or IPv6 ACL.

▾ Applying an ACL

For details about the command for applying an ACL, see the earlier descriptions about the IP ACL, MAC extended ACL, expert extended ACL, or IPv6 ACL.

Configuration Example

 The following configuration example describes only ACL-related configurations.

▾ Adding an ACE With the Time Range Specified to Allow the R&D Department to Access the Internet Between 12:00 and 13:30 Every Day

<p>Scenario Figure 1- 11</p>	<p>R&D Dept.: VLAN 1 IP Segment: 10.1.1.0/24 Gateway: 10.1.1.1</p>
<p>Configuration Steps</p>	<ul style="list-style-type: none"> ● Configure a time range named "access-internet", and add an entry of the time range between 12:00 and 13:30 every day. ● Configure an IP ACL "ip_std_internet_acl". ● Add an ACE to allow packets with the source IP address in the network segment 10.1.1.0/24, and associate this ACE with the time zone "access-internet". ● Add an ACE to deny packets with the source IP address the network segment 10.1.1.0/24. Access to the Internet is not allowed except in the specified time range. ● Add an ACE to permit all packets. ● Apply the ACL to the outgoing direction of the interface connected to the breakout gateway.
<p>SW1</p>	<pre> FS(config)# time-range access-internet FS(config-time-range)# periodic daily 12:00 to 13:30 FS(config-time-range)# exit sw1(config)# ip access-list standard ip_std_internet_acl sw1(config-std-nacl)# permit 10.1.1.0 0.0.0.255 time-range access-internet sw1(config-std-nacl)# deny 10.1.1.0 0.0.0.255 sw1(config-std-nacl)# permit any sw1(config-std-nacl)# exit sw1(config)# int gigabitEthernet 0/2 sw1(config-if-GigabitEthernet 0/2)# ip access-group ip_std_internet_acl out </pre>
<p>Verification</p>	<ul style="list-style-type: none"> ● Within the time range between 12:00 and 13:30, visit the Baidu website on a PC of the R&D department. Verify that the website can be opened normally. ● Beyond the time range between 12:00 and 13:30, visit the Baidu website on a PC of the R&D department. Verify that the website cannot be opened.
<p>SW1</p>	<pre> sw1#show time-range </pre>

```

time-range entry: access-internet (inactive)
  periodic Daily 12:00 to 13:30

sw1#show access-lists

ip access-list standard ip_std_internet_acl
  10 permit 10.1.1.0 0.0.0.255 time-range access-internet (inactive)
  20 deny 10.1.1.0 0.0.0.255
  30 permit any

sw1#show access-group
ip access-group ip_std_internet_acl out
Applied On interface GigabitEthernet 0/2

```

1.5.10 Configuring Comments for ACLs

Configuration Effect

During network maintenance, if a lot of ACLs are configured without any comments, it is difficult to distinguish these ACLs later on. You can configure comments for ACLs to better understand the intended use of ACLs.

Configuration Steps

✚ Configuring an ACL

- (Mandatory) Configure an ACL before configuring the security channel. For details about the configuration method, see the earlier descriptions.
- You can configure this ACL on an access, an aggregate, or a core device based on the distribution of users. The configurations take effect only on the local device, and do not affect other devices on the network.

✚ Configuring Comments for ACLs

- (Optional) Configure comments for ACLs so that it is easy to manage and understand the configured ACLs.

✚ Adding ACEs to an ACL

- (Optional) An ACL may contain zero or multiple ACEs. If no ACE is configured, it is equivalent that the security channel does not take effect. For details about how to add an ACE to an ACL, see the related descriptions.

✚ Configuring Comments for ACEs

- (Optional) To facilitate understanding of a configured ACL, you can configure comments for ACEs in addition to comments for the ACL.

Verification

Run the **show access-lists** command on the device to display the comments configured for ACLs.

Related Commands

↘ Configuring an ACL

For details about how to configure an ACL, see the earlier descriptions about the IP ACL, MAC extended ACL, expert extended ACL, or IPv6 ACL.

↘ Configuring a Comment for an ACL

Use either of the following two methods to configure a comment for a specified ACE in the ACL:

Command	[sn] remark <i>comment</i>
Parameter Description	comment: Indicates the comment. The value is a string of 1 to 100 characters. A comment longer than 100 characters will be truncated to 100 characters. sn: Indicates the ID of ACE
Command Mode	ACL configuration mode
Usage Guide	Run this command to configure the comment for a specified ACE in the ACL. If sn is not configured, the comment is configured for the last ACE.

Command	access-list <i>acl-id</i> sn-remark <i>comment</i>
Parameter Description	acl-id: Indicates the ID of an ACL. comment: Indicates the comment. The value is a string of 1 to 100 characters. A comment longer than 100 characters will be truncated to 100 characters. sn: Indicates the ID of ACE
Command Mode	Configuration mode
Usage Guide	Run this command to configure the comment for a specified ACE in the ACL. If sn is not configured, the comment is configured for the last ACE.

↘ Adding ACEs to an ACL

For details about how to add ACEs to an ACL, see the earlier descriptions about the IP ACL, MAC extended ACL, expert extended ACL, or IPv6 ACL.

↘ Configuring Comments for ACEs

Use either of the following two methods to configure a comment for an ACE:

Command	Remark <i>comment</i>
Parameter Description	comment: Indicates the comment. The value is a string of 1 to 100 characters. A comment longer than 100 characters will be truncated to 100 characters.
Command Mode	ACL configuration mode
Usage Guide	Run this command to configure the comment for a specified ACE.

Command	access-list <i>acl-id</i> remark <i>comment</i>
Parameter Description	acl-id: Indicates the ID of an ACL. comment: Indicates the comment. The value is a string of 1 to 100 characters. A comment longer than 100 characters will be truncated to 100 characters.
Command Mode	Global configuration mode
Usage Guide	Run this command to configure the comment for a specified ACE.

1.5.11 Configuring Global Forwarding Plane Security ACL

Configuration Effect

Configure the global forwarding plane security ACL to filter only hardware packets.

Configuration Steps

↘ Configuring an ACL

- (Mandatory) Configure an ACL first to apply the ACL to only hardware packets. For details about how to configure an ACL, see the descriptions about ACL configuration.
- You can configure the ACL on an access, aggregate, or core device based on the distribution of users. The ACL takes effect only on the local device, and does not affect other devices on the network.

↘ Configuring an ACE

- (Optional) An ACL may contain no rules. If no rule is configured, all IP packets of global software are filtered. For details about how to configure an ACE, see the descriptions about ACE configuration.

↘ Configuring a Global Forwarding Plane Security ACL

- (Mandatory) Enable the global forwarding plane security ACL function first so that the global forwarding plane security ACL takes effect only on hardware packets.
- You can configure the global forwarding plane security ACL function on an access, aggregate, or core device based on the distribution of users.

Verification

Test whether the ACL takes effect on the forwarding plane but not on the control plane.

Related Commands

↘ Configuring an ACL

For details about how to configure an ACL, see the descriptions about ACL configuration.

↘ Configuring an ACE

For details about how to configure an ACE, see the descriptions about ACE configuration.

↘ Configuring a Global Forwarding Plane Security ACL

Command	ip access-group <i>acl-id</i> { in out } forward-plane
Parameter Description	<i>acl-id</i> : Indicates the ID of an ACL.
Command Mode	Global configuration mode.
Usage Guide	Run this command to enable the global forwarding plane security ACL function, so that the ACL takes effect only on hardware.

Configuration Example

🔽 **Configuring a Global Forwarding Plane Security ACL to Implement Global ACL on Forwarding Plane**

Configuration Steps	<ul style="list-style-type: none"> ● Configure an IP ACL 1. ● Add a rule to the IP ACL to prevent destination host 10.1.1.3/24 from accessing the network. ● Add a rule to the IP ACL to allow all host addresses to access the network. ● Configure the IP ACL 1 as the global forwarding plane security ACL.
SW1	<pre>sw1(config)#ip access-list standard 1 sw1(config-ext-nacl)# denyhost 10.1.1.3 sw1(config-ext-nacl)#permit any sw1(config-ext-nacl)#exit sw1(config)#ip access-group 1 in forward-plane</pre>
Verification	<ul style="list-style-type: none"> ● Ping SW 1 from the PC at the IP address 10.1.1.3. Verify that the PC cannot ping SW 1 but can ping other IP addresses whose packets are forwarded by SW 1.
	<pre>sw1#show access-lists ip access-list standard 1 10 deny host 10.1.1.3 20 permit any sw1#show running ! ip access-group 1 in forward-plane!</pre>

1.6 Monitoring

Clearing

Description	Command
Clears the ACL packet matching counters.	clear counters access-list [<i>acl-id</i> <i>acl-name</i>]

Clears the counters of packets matching the deny ACEs.	clear access-list counters [<i>acl-id</i> <i>acl-name</i>]
--	---

Displaying

Description	Command
Displays the basic ACLs.	show access-lists [<i>acl-id</i> <i>acl-name</i>] [summary]
Displays the redirection ACEs bound to a specified interface. If the interface is not specified, redirection ACEs bound to all interfaces are displayed.	show redirect [interface <i>interface-name</i>]
Displays the ACL configurations applied to an interface.	show access-group [interface <i>interface-name</i>]
Displays the IP ACL configurations applied to an interface.	show ip access-group [interface <i>interface-name</i>]
Displays the MAC extended ACL configurations applied to an interface.	show mac access-group [interface <i>interface-name</i>]
Displays the expert extended ACL configurations applied to an interface.	show expert access-group [interface <i>interface-name</i>]
Displays the IPv6 ACL configurations applied to an interface.	show ipv6 traffic-filter [interface <i>interface-name</i>]
Displays the TCAM information or the specified TCAM information.	show acl res [dev <i>dev-num</i> [slot <i>slot-num</i>]]

Debugging



System resources are occupied when debugging information is output. Therefore, disable debugging immediately after use.

Description	Command
Debugs the ACL running process.	debug acl acld event
Debugs the ACL clients.	debug acl acld client-show
Debugs the ACLs created by all ACL clients.	debug acl acld acl-show

2 Configuring QoS

2.1 Overview

Quality of Service (QoS) indicates that a network can provide a good service capability for specified network communication by using various infrastructure technologies.

When the network bandwidth is sufficient, all data streams can be properly processed; when network congestion occurs, all data streams may be discarded. To meet users' requirements for different applications and different levels of service quality, a network must be able to allocate and schedule resources based on users' requirements and provide different levels of service quality for different data streams. To be specific, the network can process real-time and important data packets in higher priorities, and process non-real-time and common data packets in lower priorities and even discard the data packets upon network congestion.

The "doing the best" forwarding mechanism used by traditional networks cannot meet the requirements any longer and then QoS comes into being. QoS-enabled devices provide transmission QoS quality service. A transmission priority can be assigned to data streams of a type to identify the importance of the data streams. Then, the devices provide forwarding policies for different priorities, congestion mitigation and other mechanisms to provide special transmission services for these data streams. A network environment configured with QoS can provide predictability for network performance, effectively allocate network bandwidth, and reasonably utilize network resources.

2.2 Applications

Application	Description
Interface Rate Limit + Priority Relabeling	Based on different service requirements for a campus network, provide rate control and priority-based processing for outgoing traffic of the teaching building, laboratories and dormitory building.
Priority Relabeling + Queue Scheduling	Provide priority-based processing and bandwidth control for traffic of internal access to servers of an enterprise.

2.2.1 Interface Rate Limit + Priority Relabeling

Scenario

To meet the service requirements of normal teaching, a school puts forwards the following requirements:

- Control the Internet access traffic under 100M and discard packets out of control.
- Control the outgoing traffic of the dormitory building under 50M and discard packets out of control.
- Control the rate of packets with DSCP priority 7 sent from laboratories under 20M, and change the DSCP priorities of these packets whose rates exceed 20M to 16.
- Control the outgoing traffic of the teaching building under 30M and discard packets out of control.

Figure 2-1

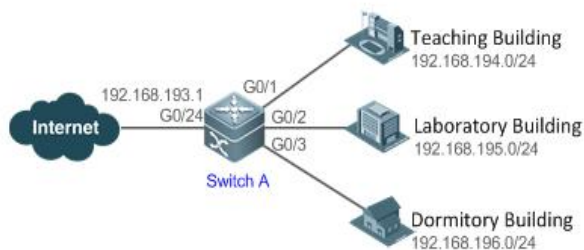

Remarks	A school connects GigabitEthernet 0/24 of Switch A to the Internet in the uplink and connects GigabitEthernet 0/1, GigabitEthernet 0/2 and GigabitEthernet 0/3 of Switch A to the teaching building, laboratory (192.168.195.0) and dormitory building (192.168.196.0) in the downlink respectively.
----------------	--

Deployment

- Configure the QoS interface rate limit for the interface G0/24 of Switch A for connecting the Internet. Configure the QoS rate limit for packets sent from the dormitory building on Switch A.
- Set the rate limit for packets with the DSCP priority 7 sent from the laboratory to 20M and relabel the DSCP priority of packets out of the rate limit to 16.
- Configure the QoS rate limit for packets sent from the teaching building on Switch A.

2.2.2 Priority Relabeling + Queue Scheduling

Scenario

Configure priority relabeling and queue scheduling to meet the following requirements:

- When the R&D department and market department access servers, the priorities of the server packets are as follows: mail server > file server > salary query server.
- No matter when the HR management department accesses the Internet or servers, the switch processes the corresponding packets in the highest priority.
- Since network congestion often occurs in switch running, in order to ensure smooth business operation, WRR queue scheduling must be used to schedule IP packets for the R&D and market departments to access the mail database, file database, and salary query database based on the ratio of 6:2:1.

Figure 2-2

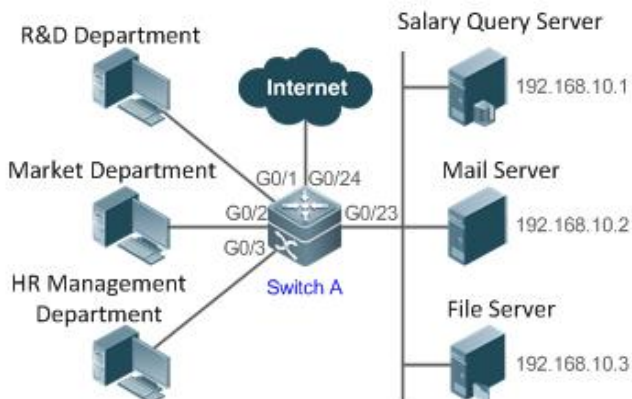

Remarks	The R&D, market and HR management departments access the interfaces GigabitEthernet 0/1, GigabitEthernet 0/2 and GigabitEthernet 0/3 of Switch A respectively. The salary query server, mail server and file server are connected to GigabitEthernet 0/23 of Switch A.
----------------	--

Deployment

- Configure the CoS values of data streams for accessing different servers to ensure that the switch processes packets for different servers in different priorities.
- Set the default CoS value of the interface to a specific value to ensure that the switch processes packets sent by the HR management department in the highest priority.
- Configure WRR queue scheduling to ensure that data packets are transmitted in a specific quantity ratio.

2.3 Features

Basic Concept

↳ DiffServ

The Differentiated Services (DiffServ) Mode is an IETF system based on which QoS is implemented in FS products. The DiffServ system classifies all packets transmitted in a network into different types. The classification information is included in layer-2/3 packet headers, including 802.1P, IP and IP DSCP priorities.

In a DiffServ-compliant network, all devices apply the same transmission service policy to packets containing the same classification information and apply different transmission service policies to packets containing different classification information. Classification information of packets is either assigned by hosts or other devices in the network or assigned based on different application policies or different packet contents. Based on the classification information carried by packets, a device may provide different transmission priorities for different packet streams, reserve bandwidth for a kind of packet streams, discard certain packets with lower priorities, or take some other actions.

↳ 802.1P(PRI) priority

The 802.1 P priority is located at the header of a layer-2 packet with the 802.1Q header, and is used in scenarios where layer-3 headers do not need to be analyzed and QoS needs to be implemented at layer 2. Figure 2-3 shows the structure of a layer-2 packet.

Figure 2-3

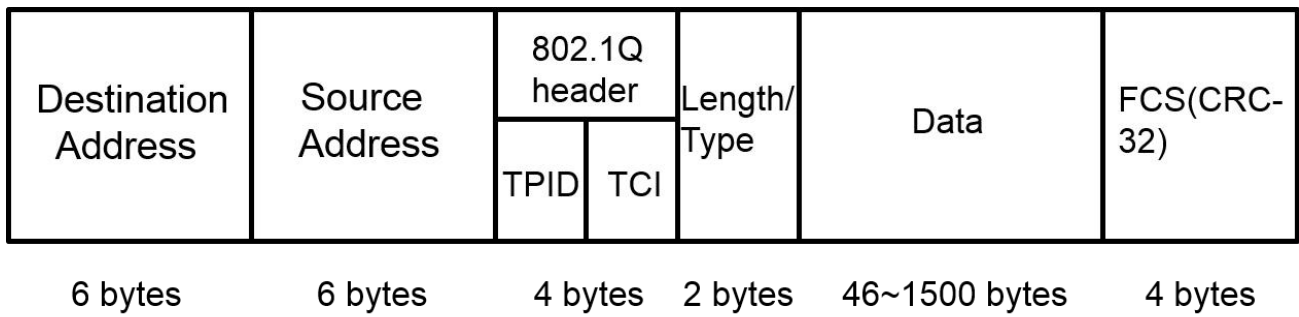

As shown in Figure 1-3, the 4-byte 802.1Q header contains 2-byte Tag Protocol Identifier (TPID) whose value is 0x8100 and 2-byte Tag Control Information (TCI). The first three bits of the TCI indicate the 802.1P priority.

➤ **IP priority (IP PRE) and DSCP priority**

The priorities of IP packets are identified by the IP PRE and DSCP priority. The Type Of Service (ToS) field of the IPv4 header comprises 8 bits; where the first three bits indicate the IP precedence (IP PRE), ranging from 0 to 7. RFC 2474 redefines the ToS field of the IPv4 header, which is called the Differentiated Services (DS) field. The Differentiated Services Code Point (DSCP) priority is identified by the first 6 bits (bits 0 to 5) of the DS field, and by the first 6 bits of the Traffic Class field in the IPv6 header. Figure 2-4 shows the locations of the IP PRE and DSCP priorities in IPv4/IPv6 packets.

Figure 2-4

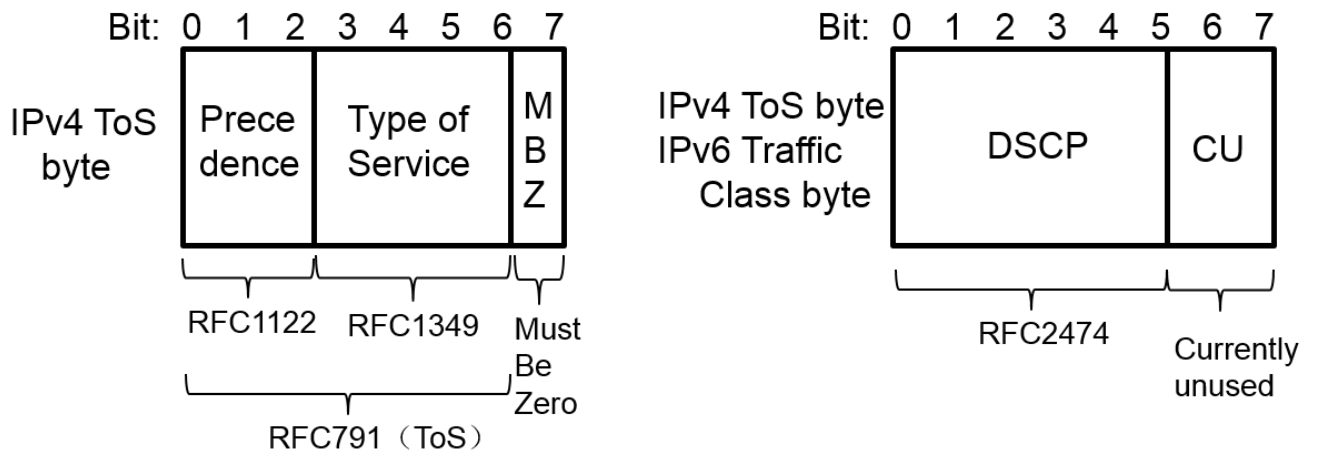

➤ **CoS**

Class of Service (CoS). FS products convert packet priorities into CoS values to identify the local priorities of the packets and determine the input queue ID when packets are sent from the output interface.

Overview

Feature	Description
Stream Classification	Stream classification uses certain rules to identify packets with same characteristics and is the prerequisite and basis for distinguishing network services.
Priority Labeling and Mapping	Label packet priorities with specified values and map the values to corresponding CoS values.
Traffic Supervision	Supervise the specification of traffic flowing into a network, limit the traffic within a reasonable range, and

	discard the traffic out of the limit or modify the priority of the traffic.
Congestion Management	Determine the sequence of data packets sent from an interface based on the priorities of the data packets and ensure that key services can be processed in time when congestion occurs.
Congestion Mitigation	Monitor the usage of the output interface queue and reduce the network load by actively discarding packets and adjusting the network traffic when network congestion occurs.

2.3.1 Stream Classification

Stream classification uses certain rules to identify packets with same characteristics and is the prerequisite and basis for distinguishing network services. Stream classification rules are used to distinguish different packets in the network and specify different QoS parameters for packets at different service levels.

Working Principle

Stream classification rules can be matching the PRE or DSCP priorities of IP packets or classifying packets by identifying packet content through an ACL. You can define the binding between multiple streams and stream behaviors by using commands to form policies which can be applied to interfaces for stream classification and processing.

➤ QoS policy

A QoS policy comprises three elements: class, stream behavior and policy.

- Class

A class identifies streams and comprises the class name and class rules. You can define the class rules by using commands to classify packets.
- Stream behavior

Stream behaviors define the QoS actions taken for packets, including priority labeling and traffic supervision for packets.
- Policy

A policy binds a specific class and specific stream behaviors and comprises the policy name, names of the classes bound, and stream behaviors. You can bind a specified class and stream behaviors by using a QoS policy and apply the policy to one or more interfaces.

➤ QoS logical interface group

You can specify a series of interfaces as a QoS logical interface group (including both APs and Ethernet interfaces) and associate policies with the logical interface group for QoS processing. Take rate limit for stream behaviors for example. For packets that meet the rate limit conditions, all interfaces in the same logical interface group share the bandwidth specified by the policy.

Related Configuration

➤ Creating a class

No class is defined by default.

You can run the **class-map** command to create a class and enter the class configuration mode.

➤ Matching an ACL

No rules are defined for a class by default.

In the class configuration mode, you can run the **match access-group** command to define a class rule as matching an ACL. You need to create ACL rules first.

➤ **Creating a policy**

No policy is defined by default.

You can run the **policy-map** command to create a policy and enter the policy configuration mode.

➤ **Associating a class**

A policy is not associated with any class by default.

In the policy configuration mode, you can run the **class** command to associate a class and enter the policy-class configuration mode.

➤ **Binding a stream behavior**

A class is not bound to any stream behavior by default.

In the policy-class configuration mode, you can run the **set** command to modify the CoS, DSCP or VID values of a specified stream; where, the CoS value ranges from 0 to 7, the DSCP value ranges from 0 to 63 and the VID value ranges from 1 to 4094. You can run the **police** command to limit the bandwidth and process streams out of the limit for specified streams. The bandwidth limit ranges are determined by products. Run the **apply acl** command to apply the ACL associated with the class.

➤ **Configuring a logical interface group**

No logical interface group is defined and an interface is not added to any logical interface group by default.

In the global configuration mode, you can run the **virtual-group** command to create a logical interface group. In the interface configuration mode, you can run the **virtual-group** command to add an interface to a logical interface group. If this logical interface group is not created, you can create the logical interface group and add the interface to the group. You can create 128 logical interface groups, ranging from 1 to 128.

➤ **Applying a policy to an interface**

No policy is applied to an interface by default.

In the interface configuration mode, you can run the **service-policy** command to apply a policy in the input/output directions of the interface. In the global configuration mode, you can run the **service-policy** command to apply a policy in the input/output directions of all interfaces.

2.3.2 Priority Labeling and Mapping

Priorities are used to label the scheduling weights of packets or the priorities of the packets in forwarding. Different packet types have different priority types including 802.1P(PRI), IP PRE and DSCP priorities. Priority labeling and mapping refer to labeling packet priorities with specified values and mapping the values to corresponding CoS values.

Working Principle

After data streams of packets enter a device interface, the device assigns priorities to the packets based on the trust mode configured for the interface. The following describes several trust modes:

- When the interface trust mode is untrust, which means not trusting the priority information carried in packets:

Modify the CoS value according to the default CoS value (0, which is configurable), COS-DSCP mapping table and DSCP-COS mapping table of the interface and put the packets into queues based on the final CoS value. For output packets carrying the 802.1Q tag, the packet priority will be modified to the corresponding CoS value.

- When the interface trust mode is trusting CoS:

For packets carrying the 802.1Q tag, modify the CoS value according to the PRI value, CoS-DSCP mapping table, and DSCP-CO mapping table, and put the packets into queues based on the final CoS value. For output packets carrying the 802.1Q tag, the packet priority will be modified to the corresponding CoS value.

For packets not carrying the 802.1Q tag, modify the CoS value according to the default CoS value (0, which is configurable), COS-DSCP mapping table and DSCP-COS mapping table of the interface, and put the packets into queues based on the final CoS value. For output packets carrying the 802.1Q tag, the packet priority will be modified to the corresponding CoS value.

- When the interface trust mode is trusting DSCP:

For non-IP packets, the processing is the same as that for trusting CoS.

For IP packets, modify the CoS value according to the DSCP value of the packets and the DSCP-CoS mapping table and put the packets into queues based on the final CoS value.

- When the interface trust mode is trusting IP PRE:

For non-IPv4 packets, the processing is the same as that for trusting CoS.

For IPv4 packets, obtain and modify the DSCP priority of the packets according to the IP PRE value of the packets and the IP-PRE-DSCP mapping table, obtain the CoS value according to the DSCP-CoS mapping table, and then put the packets into queues based on the final CoS value.

- When the trust mode and the applied policy of an interface work together:

When the trust mode and the applied policy of an interface work together, the trust mode has a lower priority than the policy and the CoS priority can be obtained according to the DSCP-CoS mapping table.

If a policy is applied to the interface but the policy does not has a configuration for modifying the DSCP and CoS values, the processing will be performed based on the trust mode of the interface.

Related Configuration

↘ Configuring the trust mode of an interface

The default trust mode of an interface is untrust.

In the interface configuration mode, run the **mls qos trust** command to modify the trust mode. The trust mode can be trusting CoS, trusting DSCP or trusting IP PRE.

↘ Configuring the default CoS value of an interface

The default CoS value of an interface is 0.

In the interface configuration mode, run the **mls qos cos** command to modify the default CoS value of the interface, which ranges from 0 to 7.

↘ Labeling the priority of streams

The priorities of streams are not relabeled by default.

In the policy-class configuration mode, run the **set** command to modify the CoS, DSCP and VID values of streams. The CoS value ranges from 0 to 7, the DSCP value ranges from 0 to 63, and the VID value ranges from 1 to 4094.

📌 **Configuring CoS-to-DSCP Map**

By default, the CoS values 0, 1, 2, 3, 4, 5, 6 and 7 are mapped to the DSCP values 0, 8, 16, 24, 32, 40, 48 and 56 respectively.

Run the **mls qos map cos-dscp** command to configure the CoS-DSCP mapping. The DSCP value ranges from 0 to 63.

📌 **Configuring DSCP-to-CoS Map**

By default, DSCP 0 to 7 are mapped to CoS 0, DSCP 8 to 15 mapped to CoS 1, DSCP 16 to 23 mapped to CoS2, DSCP 24 to 31 mapped to CoS 3, DSCP 32 to 39 mapped to CoS 4, DSCP 40 to 47 mapped to CoS 5, DSCP 48 to 55 mapped to CoS 6, and DSCP 56 to 63 mapped to CoS 7.

Run the **mls qos map dscp-cos** command to configure the DSCP-CoS mapping. The CoS value ranges from 0 to 7 and the DSCP value ranges from 0 to 63.

2.3.3 Traffic Supervision

Supervise the specification of traffic flowing into a network, limit the traffic within a reasonable range, and discard the traffic out of the limit or modify the priority of packets. In addition, the total traffic of an interface can be monitored and the traffic out of the limit will be discarded.

Working Principle

Traffic supervision is used to monitor the specification of traffic flowing into a network and conduct preset supervision actions based on different assessment results. These actions can be:

- Forwarding: Normally forward packets within the traffic limit.
- Discarding: discard packets out of the traffic limit.
- Changing the priority and forwarding: modify the priorities of packets out of the traffic limit and then forward the packets.

Directly discard packets out of the total traffic limit of an interface.

Related Configuration

📌 **Configuring the action to be conducted for traffic out of limit**

No action to be conducted for traffic out of limit is configured by default.

In the policy-class configuration mode, run the **police** command to configure the action to be conducted for traffic out of limit to discarding traffic out of limit, or modifying the CoS value or DSCP value. The traffic limit range is determined by products. When the traffic is out of the limit, you can modify the CoS value in the range of 0 to 7 and the DSCP value in the range of 0 to 63.

📌 **Configuring the total traffic limit for an interface**

The total traffic limit for an interface is not configured by default.

In the interface configuration mode, run the **rate-limit** command to configure the total traffic limit for an interface in the input and output directions. The traffic limit range is determined by products.

2.3.4 Congestion Management

When the receiving rate of packets exceeds the sending rate of packets, congestion will occur on the sending interface. If no sufficient buffer is provided to store these packets, the packets may be lost. The congestion management mechanism determines the sequence of data packets to be sent from an interface based on the priorities of the data packets. The congestion management function allows for congestion control by increasing the priorities of important data packets. When congestion occurs, the important data packets are sent in higher priorities to ensure that key services are implemented in time.

Working Principle

A queue scheduling mechanism is used for congestion management and the process is as follows:

- After each packet passes all QoS processing in a switch, the packet will obtain a CoS value finally.
- At the output interface, the device classifies the packets into corresponding sending queues based on the CoS values.
- The output interface selects packets in a queue for sending based on various scheduling policies (SP, WRR, DRR, WFQ, SP+WRR, SP+DRR, SP+WFQ).

↳ Scheduling policy

The queue scheduling policies include SP, WRR, DRR, WFQ, SP+WRR, SP+DRR and SP+WFQ.

- Strict-Priority (SP) scheduling means scheduling packets strictly following queue IDs. Before sending packets each time, check whether a queue with the first priority has packets to be sent. If yes, the packets in this queue are sent first. If not, check whether a queue with the second priority has packets. Follow the same rules for packets in other queues.
- Weighted Round Robin (WRR) scheduling means scheduling queues in turn to ensure that all queues have certain service time. For example, a 1000 Mbps interface has 8 output queues. The WRR configures a weighted value (5, 5, 10, 20, 20, 10, 20 and 10, which indicate the proportions of obtained resources) for each queue. This scheduling method ensures that a queue with the lowest priority is assigned with at least 50 Mbps bandwidth, which avoids that packets in the queue with the lowest priority are not served for long time when the SP scheduling method is used.
- Deficit Round Robin (DRR) scheduling is similar to the WRR, but applies weight values based on bytes, but not based on time slices.
- Weighted Fair Queueing (WFQ) scheduling provides dynamic and fair queuing and applies weighted values based on bytes, similar to the DRR. When encountering an empty queue, the DRR will shift to the next queue for transmission immediately. If a queue misses its transmission time, the queue must wait for the next time, which is the difference between the WFQ and DRR; therefore, the WFQ is more suitable for processing data packets with variable lengths than the DRR.
- SP+WRR scheduling means configuring the SP scheduling for one or more sending queues and configuring the WRR scheduling for the other queues. Among SP queues, only after all packets in the SP queue with the first priority are sent, the packets in the SP queue with the second priority can be sent. Among SP and WRR queues, only after the packets in all SP queues are sent, the packets in WRR queues can be sent.
- SP+WFQ scheduling means configuring the SP scheduling for one or more sending queues and configuring the WFQ scheduling for the other queues. Among SP queues, only after all packets in the SP queue with the first priority are sent, the packets in the SP queue with the second priority can be sent. Among SP and WFQ queues, only after the packets in all SP queues are sent, the packets in WFQ queues can be sent.
- SP+WFQ scheduling means configuring the SP scheduling for one or more sending queues and configuring the WFQ scheduling for the other queues. Among SP queues, only after all packets in the SP queue with the first priority are sent, the

packets in the SP queue with the second priority can be sent. Among SP and WFQ queues, only after the packets in all SP queues are sent, the packets in WFQ queues can be sent.

↘ QoS multicast queue

On some products, interface queues are classified into unicast queues and multicast queues. There are 8 unicast queues. All known unicast packets enter corresponding unicast queues for forwarding based on their priorities. There are 1 to 8 multicast queues (depending on products. Certain products do not support multicast queues). Except for known unicast packets, all packets (such as broadcast packets, multicast packets, unknown unicast packets, and mirroring packets) enter corresponding multicast queues for forwarding based on their priorities. Similar to unicast queues, you can configure priority mappings and scheduling algorithms for multicast queues. The **Cos-to-Mc-Queue** command can be used to configure mapping from priorities to multicast queues. At present, multicast queues support the SP, WRR and SP+WRR scheduling algorithms.

↘ Scheduling policy and round robin weight for output queues on an interface



The scheduling policies and round robin weight for output queues are based on global configurations. Some products support both global configurations and interface-based configurations. Interface-based configurations have higher priorities than global configurations. The global scheduling policy works with the corresponding global round robin weight whereas the interface scheduling policy works with the interface round robin weight. If only the global scheduling policy or interface scheduling policy is configured but no corresponding round robin weights are configured, the default round robin weights will work with the scheduling policy.

↘ Queue bandwidth

Some products allow for configuring the guaranteed minimum bandwidth and the limited maximum bandwidth for a queue. A queue configured with the guaranteed minimum bandwidth ensures that the bandwidth for this queue is not smaller than the configured value. A queue configured with the limited maximum bandwidth ensures that the bandwidth for this queue is not greater than the configured value and packets out of the bandwidth limit will be discarded. The bandwidth limits for unicast and multicast queues are configured together on some products whereas configured separately on some other products. In addition, some products allow for configuring bandwidth only for unicast queues.

↘ Queue ECN

With the combination of the WERD technology and explicit congestion notification (ECN) technology, a terminal device can perceive network congestion and notify the source device of the congestion. Upon receiving the notification, the source device reduces the packet sending rate to prevent aggravated congestion.

-  Both the ECN and WRED functions must be configured to enable the queue ECN function.
-  After the queue ECN function is enabled (namely, the ECN field in packets is set to **01** or **10**), when queue congestion occurs, the device changes the ECN field to **CE (11)**, instead of discarding packets randomly according to the WRED template.
-  After the queue ECN function is enabled, the device sets the ECN field to **CE** only when the packet rate reaches the lower discarding threshold specified in the WRED template.

Related Configuration

↘ Configuring CoS-to-Queue Map

By default, the CoS values 0, 1, 2, 3, 4, 5, 6 and 7 are mapped to the queues 1, 2, 3, 4, 5, 6, 7 and 8 respectively.

Run the **priority-queue cos-map** command to configure the CoS-to-queue mapping. The CoS value ranges from 0 to 7 and the queue value ranges from 1 to 8.

📌 **Configuring the scheduling policy for an output queue**

By default, the scheduling policy for a global output queue is WRR and no scheduling policy is configured for an interface.

Run the **mls qos scheduler** command to configure the output scheduling policy for a queue. Configurable scheduling policies include SP, WRR and DRR. You can also run the **priority-queue** command to configure the scheduling policy as SP.

📌 **Configuring the round robin weight corresponding to the WRR scheduling policy for an output queue**

By default, the weight of a global or interface-based queue is 1:1:1:1:1:1:1:1.

Run the **wrr-queue bandwidth** command to configure the round robin weight corresponding to the WRR scheduling policy for an output queue. The configurable weight range is determined by products.

A higher weight means longer output time.

📌 **Configuring the round robin weight corresponding to the DRR scheduling policy for an output queue**

By default, the weight of a global or interface-based queue is 1:1:1:1:1:1:1:1.

Run the **drr-queue bandwidth** command to configure the round robin weight corresponding to the DRR scheduling policy for an output queue. The configurable weight range is determined by products.

A higher weight means more packet bytes that can be sent.

📌 **Configuring the round robin weight corresponding to the WFQ scheduling policy for an output queue**

By default, the weight of a global or interface-based queue is 1:1:1:1:1:1:1:1.

Run the **wfq-queue bandwidth** command to configure the round robin weight corresponding to the WFQ scheduling policy for an output queue. The configurable weight range is determined by products.

A higher weight means more packet bytes that can be sent.

📌 **Configuring the bandwidth for a queue**

Run the **qos queue** command to configure the guaranteed minimum bandwidth and the limited maximum bandwidth for each queue. The queue value ranges from 1 to 8 and the guaranteed minimum bandwidth and limited maximum bandwidth value ranges are determined by products. Supported queue types are determined by products.

📌 **Configuring the Queue ENC**

Run the **qos queue queue_num enc** command to enable ECN on all queues. (Queue range: 1 to 8)

2.3.5 Congestion Mitigation

Monitor the usage of the output interface queue and reduce the network load by actively discarding packets and adjusting the network traffic when network congestion occurs.

Working Principle

Mitigate congestion by effectively monitoring the network traffic and forecasting occurrence of congestion. Packets need to be discarded to mitigate congestion. Discarding policies include Tail-Drop, Random Early Detection (RED), and Weighted Random Early Detection (WRED).

➤ Tail-Drop

Traditional packet loss policies include Tail-Drop. Tail-Drop is effective for all traffic and cannot distinguish service levels. When congestion occurs, data packets at the tail of a queue will be discarded until the congestion is removed.

➤ RED and WRED

Hosts running TCP will decrease the rate of sending packets to respond to massive packet loss. After congestion is removed, the hosts increase the rate of sending packets. In this way, Tail-Drop may cause TCP Global Synchronization. When a queue discards multiple TCP packets simultaneously, multiple TCP connections enter the congestion mitigation and slow startup state simultaneously, and the traffic is reduced and adjusted. When congestion is removed, traffic peaks may appear. The process repeats constantly, the network traffic goes up and down suddenly, and the line traffic always fluctuates between the lowest quantity and the highest quantity. When TCP global synchronization occurs, the connection bandwidth cannot be adequately used, which causes bandwidth waste.

To avoid this circumstance, you can use the RED/WRED packet discarding policy. This policy provides a mechanism for discarding packets in random, which avoids TCP global synchronization. When packets of a TCP connection are discarded and sent at a lower rate, packets of other TCP connections are still sent at higher rates. In this way, there are always some TCP connections whose packets are sent at higher rates, which increases the utilization of line bandwidth.

When WRED is used, you can set the lower threshold value and maximum discarding probability for a queue. When the queue length is smaller than the lower threshold value, WRED does not discard packets. When the queue length is between the higher and lower threshold values, WRED discards packets in random (the longer the queue length, the higher probability of packet discarding. There is a maximum discarding probability). When the queue length is greater than the higher threshold value, WRED discards packets at the maximum discarding probability.

Different from RED, WRED uses priorities to distinguish discarding policies. RED is a special example of WRED. When all CoS values of an interface are mapped to the same lower and higher threshold values, WRED becomes RED.

Related Configuration

➤ Enabling the WRED function

The default packet discarding policy is Tail-Drop.

You can run the **queueing wred** command to enable the WRED function.

➤ Configuring the lower threshold

When 2 groups of lower thresholds in the unit of percentage are supported, the default values are 100 and 80 (the number of threshold groups are determined by products). Some products support configuration in the unit of cell (the default value is determined by products).

In the interface configuration mode, you can run the **wrr-queue random-detect min-threshold** command to configure the lower thresholds in the unit of percentage for packets discarded by WRED in each queue. The queue value ranges from 1 to 8. The lower threshold ranges from 1 to 100.

In the interface configuration mode, you can run the **wrr-queue random-detect min-threshold cell** command to configure the lower thresholds in the unit of cell for packets discarded by WRED in each queue. The queue value range varies from products.

➤ Configuring the higher threshold

When 2 groups of lower thresholds in the unit of percentage are supported, the default values are 100 and 100 (the number of threshold groups are determined by products). Some products support configuration in the unit of cell (the default value is determined by products).

In the interface configuration mode, you can run the **wrr-queue random-detect max-threshold** command to configure the higher thresholds in the unit of percentage for packets discarded by WRED in each queue. The queue value ranges from 1 to 8. The higher threshold ranges from the minimum value of lower threshold to the maximum value of higher threshold.

In the interface configuration mode, you can run the **wrr-queue random-detect max-threshold cell** command to configure the higher thresholds in the unit of cell for packets discarded by WRED in each queue. The queue value ranges from 1 to 8. The higher threshold ranges from the minimum value of lower threshold to the maximum value of higher threshold.

When the queue length is smaller than the lower threshold, WRED does not discard packets. When the queue length is between the lower and higher thresholds, WRED discards packets in random.

↘ **Configuring the maximum discarding probability**

When 2 groups of maximum discarding probabilities are supported, the default values are 100 and 80 (the number of threshold value groups are determined by products).

In the interface configuration mode, you can run the **wrr-queue random-detect probability** command to configure the maximum discarding probabilities for packets discarded by WRED in each queue. The queue value ranges from 1 to 8. The maximum discarding probability ranges from 1 to 100.

↘ **Adjusting the average queue length for discarding probability**

When packets are forwarded, WRED determines the discarding probability based on the average queue length of the output queue.

When the queue length is between the lower threshold and higher threshold, WRED starts to discard packets randomly. A longer queue leads to a higher discarding probability that is less than the maximum discarding probability. When the queue length is greater than the higher threshold, packets are discarded at the maximum discarding probability.

By default, the average queue length is determined by products. You can configure the sampling interval and weight of to-be-discarded packets to affect the calculation result of the average queue length.

The sampling weight indicates the weight factor of sampled data updates. A larger sampling weight indicates a longer update interval of the average queue length and a larger average queue length. In interface configuration mode, you can run the **wrr-queue random-detect sample-weight** command to configure the sampling weight factor of each queue. The value range is determined by products.

↘ **Configuring the CoS-to-threshold mapping**

By default, all CoS values are mapped to the first group of threshold values (the number of threshold groups is determined by products).

In the interface configuration mode, you can run the **wrr-queue cos-map** command to configure the CoS-to-threshold group mapping. The CoS value ranges from 0 to 7 and the number of threshold groups is determined by products. Multiple groups of lower threshold values and maximum discarding probabilities can be configured. By configuring the CoS-to-threshold group mapping, you can select the effective threshold group mapped to a CoS value, for example, CoS 0 mapped to the first threshold group, and CoS 1 mapped to the second threshold group. If the packets of CoS 0 and 1 are added to queue 1 for scheduling, the packets of CoS 0 are processed based on the lower threshold values and maximum discarding probabilities in the first group and the packets of CoS 1 are processed based on the lower threshold values and maximum discarding probabilities of the second group.

When all CoS values of an interface are mapped to the same group of threshold values, the enabled WRED becomes RED.

2.3.6 Queue Display and Configuration

By default, the display and configuration mode of all queues on the device is 1–8.

✚ Changing the queue display and configuration mode

In global configuration mode, you can run the **qos-queue compatible enable** command to change the queue display and configuration mode of all queues on the device to 0–7.

2.3.7 Packet Priority Modification

By default, the priority of a packet is changed to that configured on a device when the packet is sent out from the device. For example, an L2 packet whose priority is 4 is sent. The ingress direction is associated with the policy-map. If the packet matches the policy, the CoS value in the packet is set to 2. When the packet is captured in the egress, the packet priority is 2.

✚ Disabling packet priority modification

In global configuration mode, run the **mls qos remark disable** command to disable packet priority modification, that is, when a packet is sent out from a device, the priority of the packet is the same as that when the packet is sent to the device.

2.4 Limitations



- The QoS trust mode cannot be configured on SVIs.



- For the S6500/S6250 series products, members of a logical port group must be on the same device.
- Members to be added to a logical port group must be physical ports or Aggregate Ports (APs).



The deny entry in an ACL matching a class-map does not take effect.



- The S6500/S6250 series products do not support VID modification.



- When QoS is applied to the outbound direction, the S6500/S6250 series products change the DSCP value of packets whose bandwidth exceeds the limit but keep the CoS value unchanged. When QoS is applied to the inbound direction, the S6500/S6250 series products change the DSCP value and CoS value of packets whose bandwidth exceeds the limit.
- The S6500/S6250 series products change both the DSCP value while changing the CoS value of packets whose bandwidth exceeds the limit. After **none-tos** is set, the S6500/S6250 series products do not change the DSCP value when changing the CoS value.
- The S6500/S6250 series products do not support the **none-tos** option when CoS is configured.
- On the S6500/S6250 series products, bandwidth limit is based on the actual bandwidth, including the load generated by the preamble and interframe gap. The preamble and interframe gap carried in each packet occupy 20 bytes.
- The S6500/S6250 series products support the minimum rate limit granularity of 8 Kbps. The rate limit granularity varies with the rate limit settings. The following table lists the relationships between rate limits and granularities.

Rate Limit Range	64 Kbps to 2 Gbps	2 Gbps to 4 Gbps	4 Gbps to 8 Gbps
Granularity	8 Kbps	16 Kbps	32 Kbps
Rate Limit Range	8 Gbps to 16 Gbps	16 Gbps to 32 Gbps	32 Gbps to 40 Gbps
Granularity	64 Kbps	128 Kbps	256 Kbps

- For the second parameter (burst traffic) in the QoS rate-limit policy, if the parameter value is excessively small, the actual rate may be excessively small in the case of burst traffic. If the parameter value is excessively large, the actual rate may be excessively large. You can use the following recommended configuration as required:
 - (1) If the configured rate limit is smaller than 1024 Kbps, the recommended burst-size value is 1024 KBytes.
 - (2) If the configured rate limit is smaller than 10240 Kbps, it is recommended to set the burst-size value to be the same as the rate limit or use the maximum value (the allowable burst-size value of the products may be smaller than 10240 KBytes).
 - (3) If the configured rate limit is greater than 10240 Kbps, it is recommended to set the burst-size value to the allowable maximum value of the device.
- For the second parameter in the QoS rate-limit policy, when the rate limit is relatively large, the second parameter needs to be adjusted accordingly. Otherwise, the rate limit may be inaccurate.

For 10G or 40G ports, it is recommended to set the burst-size to 32 or a larger value.



- The S6500/S6250 series products support applying the policy map to the outbound direction.

When a policy is applied to an AP of the S6500/S6250 series products, member ports of the AP must meet the following condition so that the configured bandwidth limit is the bandwidth shared by all member ports of the AP: Member ports of the AP must belong to the same S6500/S6250 device.

- On the S6500/S6250 series products, a class-map needs to be associated with an ACL, and therefore all restrictions configured in an ACL are available to the QoS function. For details, see the ACL configuration guide.
- Policy maps cannot be applied to SVIs.
- Policy maps can be configured in the output direction but cannot be configured on APs.
- Policy maps configured in the output direction do not support re-marking the CoS value of packets. The CoS value of packets is not re-marked when the DSCP value of the packets is re-marked.
- QoS is not supported on logical port groups in the output direction.



- The Virtual Switching Link (VSL) ports of the S6500/S6250 series products adopt the Strict Priority (SP) + Deficit Round Robin (DRR) scheduling algorithm by default. Queue 7 adopts the SP scheduling and the weights of other queues are all 1, which cannot be modified by users.



When the QoS egress rate limit is configured on the S6500/S6250 series products, the first 32 ports do not share the rate limit with subsequent ports. As a result, QoS is applied to the SVIs. If a SVI contains the first 32 ports and subsequent ports, the egress rate limit is doubled for packets that are transmitted by the first 32 ports and subsequent ports.

For example, member ports of VLAN 1 contain Gi0/1, Gi/2, Gi0/33, and Gi0/34, and the QoS rate limit of 10 Mbps is applied to VLAN 1. The actual rate limit of packets that are transmitted by Gi0/1, Gi/2, Gi0/33, and Gi0/34 is actually 20 Mbps. Gi0/1 and Gi/2 share the rate limit of 10 Mbps while Gi0/33 and Gi0/34 share the rate limit of another 10 Mbps.



You can run only the **show run** command to check whether the WRED function is enabled globally.



- The lower threshold and maximum drop probability of a queue form one WRED configuration group. The number of supported WRED configuration groups varies with the limit. The S6500/S6250 series products support a maximum of 120 WRED configuration groups.

It is not recommended that the configured number of WRED configuration groups exceed 120. The extra WRED configuration groups may result in improper running.





- If the lower threshold is 100%, the WRED function is disabled.



- The S6500/S6250 series products support mapping configuration on physical ports.
- Administrators can configure the DSCP-CoS and CoS-threshold mappings to implement the DSCP-threshold mapping.
- Administrators can configure the CoS-threshold and CoS-queue mappings to implement the queue-threshold mapping.

2.5 Configuration

Configuration	Description and Command	
Configuring Stream Classification	(Optional) It is used to create stream classification information.	
	class-map	Creates a class.
	match access-group	Matches ACL rules.
	policy-map	Creates a policy.
	class	Associates a class.
	police	Binds the bandwidth limit for streams and the action for processing packets out of the limit.
	set	Binds the behaviors for modifying the CoS, DSCP and VID values of streams.
	apply acl	Applies the ACL
	virtual-group	Creates a logical interface group and adds interfaces to the logical interface group.
Configuring Priority Labeling and Mapping for Packets	(Optional) It is used to configure the trust mode, default CoS value and various mappings for an interface.	
	mls qos trust	Modifies the trust mode of an interface.
	mls qos cos	Modifies the default CoS value of the interface.
	mls qos map cos-dscp	Configures the CoS-to-DSCP mapping.
	mls qos map dscp-cos	Configures the DSCP-to-CoS mapping.
Configuring Interface Rate Limit	(Optional) It is used to configure the rate limit for an interface.	
	rate-limit	Configures the traffic limit for an interface.

Configuration	Description and Command	
Configuring Congestion Management	 (Optional) It is used to configure the CoS-to-queue mapping, queue scheduling policies and round robin weight.	
	priority-queue cos-map	Configures the CoS-to-queue mapping.
	priority-queue	Configures the output scheduling policy for a queue to SP.
	mls qos scheduler	Configures the output scheduling policy for a queue.
	wrr-queue bandwidth	Configures the round robin weight corresponding to the WRR scheduling policy for an output queue.
	drr-queue bandwidth	Configures the round robin weight corresponding to the DRR scheduling policy for an output queue.
	wfq-queue bandwidth	Configures the round robin weight corresponding to the WFQ scheduling policy for an output queue.
	qos queue	Configures the guaranteed minimum bandwidth and limited maximum bandwidth for a queue.
Configuring Congestion Mitigation	 (Optional) It is used to prevent network congestion by setting packet discarding.	
	queueing wred	Enables the WRED function.
	wrr-queue random-detect sample-weight	Configure the sampling weight of packets to be discarded by WRED.
	wrr-queue random-detect min-threshold	Configures the lower threshold value for packets discarded by WRED.
	wrr-queue random-detect max-threshold	Configures the higher threshold for packets discarded by WRED (in the unit of percentage).
	wrr-queue random-detect min-threshold cell	Configures the lower threshold for packets discarded by WRED (in the unit of cell).
	wrr-queue random-detect max-threshold cell	Configures the higher threshold for packets discarded by WRED (in the unit of cell).
	wrr-queue random-detect probability	Configures the maximum discarding probability for packets discarded by WRED.
	wrr-queue cos-map	Configures the threshold-to-CoS mapping.
Configuring Queue Display and Configuration Mode	 (Optional) It is used to set the queue display and configuration mode of all queues on the device to 0–7.	
	qos-queue compatible enable	Enables the queue display and configuration mode of all queues on the device to 0–7.
Disabling Packet Priority	 (Optional) It is used to disable packet priority modification.	

Configuration	Description and Command	
Modification	mls qos remark disable	Disables packet priority modification.

2.5.1 Configuring Stream Classification

Configuration Effect

- Create a class and match classification rules.
- Create a policy, bind a class and stream behaviors, and associate with an interface.

Notes

- The class and policy names cannot comprise more than 31 characters.
- Interface configurations allow for only AP and Ethernet interface configurations. Certain products support policies applied to SVI interfaces through the **service-policy** command. When both physical interfaces and SVI interfaces are configured with policies, the priority of the physical interfaces is higher than that of the SVI interfaces.
- If run the **service-policy** command in global configuration mode, policies will be applied to all interfaces which can be configured with policies.

Configuration Steps

↘ Creating a class and matching ACL rules

- Optional.
- Create a class. In the class configuration mode, match ACL, IP PRE or DSCP.

↘ Creating a policy

- Optional.
- Create a policy. In the policy configuration mode, bind the class and stream behaviors.

↘ Creating a logical interface group and adding interfaces to the logical interface group

- Optional.
- Create a logical interface group and add interfaces to the logical interface group.

↘ Applying a policy to an interface

- Optional.
- Associate a configured policy with a specified interface or logical interface group.

Verification

- Run the **show class-map** command to check whether the class is successfully created and whether rules are successfully matched.
- Run the **show policy-map** command to check whether the policy is successfully created and whether the class and stream behaviors are successfully bound.
- Run the **show mls qos interface** command to check whether the interface is associated with the policy.
- Run the **show virtual-group** command to check the interfaces in the logical interface group.

- Run the **show mls qos virtual-group** command to check whether the logical interface group is associated with the policy.

Related Commands

↘ Creating a class

Command	class-map <i>class-map-name</i>
Parameter Description	<i>class-map-name</i> : Indicates the name of a class to be created. The name cannot comprise more than 31 characters.
Command Mode	Global configuration mode
Usage Guide	-

↘ Matching an ACL

Command	match access-group <i>access-list-number</i>
Parameter Description	<i>access-list-number</i> : Indicates the number of the ACL to be matched.
Command Mode	Class configuration mode
Usage Guide	-

↘ Creating a policy

Command	policy-map <i>policy-map-name</i>
Parameter Description	<i>policy-map-name</i> : Indicates the name of a policy to be created. The name cannot comprise more than 31 characters.
Command Mode	Global configuration mode
Usage Guide	-

↘ Associating a class

Command	class <i>class-map-name</i>
Parameter Description	<i>class-map-name</i> : Indicates the name of a class to be associated.
Command Mode	Policy configuration mode
Usage Guide	-

↘ Binding the behaviors for modifying the CoS, DSCP and VID values of streams

Command	set { ip dscp <i>new-dscp</i> [with cos <i>new-cos</i> priority] cos <i>new-cos</i> [priority none-tos] vid <i>new-vid</i> }
Parameter Description	<p>ip dscp <i>new-dscp</i>: Changes the DSCP value of streams to <i>new-dscp</i>, ranging from 0 to 63.</p> <p>with cos <i>new-cos</i> priority: Configures the queue priority (same as priority).</p> <p>cos <i>new-cos</i>: Changes the CoS value of streams to <i>new-cos</i>, ranging from 0 to 7.</p> <p>Priority: Configures the queue priority but not the CoS value.</p> <p>none-tos: Does not change the DSCP value of packets when changing the CoS value of the packets.</p> <p>vid <i>new-vid</i>: Changes the VLAN ID of streams to <i>new-vid</i>, ranging from 1 to 4094.</p>

Command Mode	Class configuration mode
Usage Guide	The availability of command set ip dscp new-dscp with cos new-cos priority varies with the chip capability of products.

↘ Applying ACL

Command	apply acl
Parameter Description	
Command Mode	Class configuration mode
Usage Guide	Only one ACL can be applied in one policy, and the behavior takes effect according to the ACL.

↘ Binding the bandwidth limit for streams and the action for processing packets out of the limit

Command	police rate-bps burst-byte [exceed-action { drop dscp new-dscp cos new-cos [none-tos] }]
Parameter Description	<p>rate-bps: Indicates the bandwidth limit per second (KBits). The value range is determined by products.</p> <p>burst-byte: Indicates the burst traffic limit (Kbytes). The value range is determined by products.</p> <p>drop: Discards packets out of the bandwidth limit.</p> <p>dscp new-dscp: Changes the DSCP value of packets out of the bandwidth limit to new-dscp, ranging from 0 to 63.</p> <p>cos new-cos: Changes the CoS value of packets out of the bandwidth limit to new-cos, ranging from 0 to 7.</p> <p>none-tos: Does not change the DSCP value of packets when changing the CoS value of the packets.</p>
Command Mode	Class configuration mode
Usage Guide	-

↘ Creating a logical interface group and adding interfaces to the logical interface group

Command	virtual-group virtual-group-number
Parameter Description	virtual-group-number: Indicates the logical interface group number, ranging from 1 to 128.
Command Mode	Create the logical interface group in the global configuration mode, add the interface to the logical interface group in the interface configuration mode. If no logical interface group exists, you need to create a logical interface group first and then add interfaces to the logical interface group.
Usage Guide	-

↘ Applying a policy to an interface

Command	service-policy { input output } policy-map-name
Parameter Description	<p>input: Indicates the input direction of the interface.</p> <p>output: Indicates the output direction of the interface.</p> <p>policy-map-name: Indicates the name of the policy applied to the interface.</p>
Command Mode	Interface configuration mode/Global configuration mode/Logical port group mode
Usage Guide	-

Configuration Example

➤ **Creating four stream classes and matching ACL, IP PRE and DSCP**

Configuration Steps	<ul style="list-style-type: none"> ● Create ACL rules. ● Create four stream classes and match ACL, IP PRE and DSCP.
	<pre>FS# configure terminal FS(config)# access-list 11 permit host 192.168.23.61</pre>
	<pre>FS(config)# class-map cmap1 FS(config-cmap)# match access-group 11 FS(config-cmap)# exit</pre>
Verification	<ul style="list-style-type: none"> ● Check whether the created ACL rules and stream class rules are successful.
	<pre>FS# show access-lists ip access-list standard 11 10 permit host 192.168.23.61</pre>
	<pre>FS# show class-map Class Map cmap1 Match access-group 11</pre>

2.5.2 Configuring Priority Labeling and Mapping for Packets

Configuration Effect

- Configure the trust mode and default CoS value of an interface.
- Configure the CoS-to-DSCP and DSCP-to-CoS mappings.

Notes

- Interface configurations allow for only AP and Ethernet interface configurations.

Configuration Steps

➤ **Configuring the trust mode and default CoS value of an interface**

- Optional.
- In the interface configuration mode, configure the trust mode and default CoS value of an interface.

➤ **Configuring the CoS-to-DSCP and DSCP-to-CoS mappings**

- Optional.
- Configure various mappings.

Verification

- Run the **show mls qos interface** command to display the trust mode and default CoS value of the interface.

- Run the **show mls qos maps** command to display the CoS-to-DSCP and DSCP-to-CoS mappings.

Related Commands

➤ **Configuring the trust mode of an interface**

Command	mls qos trust { cos ip-precedence dscp }
Parameter Description	cos: Configures the trust mode of an interface to CoS. ip-precedence: Configures the trust mode of an interface to IP PRE. dscp: Configures the trust mode of an interface to DSCP.
Command Mode	Interface configuration mode
Usage Guide	-

➤ **Configuring the default CoS value of an interface**

Command	mls qos cos default-cos
Parameter Description	<i>default-cos:</i> Configures the default CoS value, ranging from 0 to 7. The default value is 0.
Command Mode	Interface configuration mode
Usage Guide	-

➤ **Configuring CoS-to-DSCP MAP**

Command	mls qos map cos-dscp dscp1...dscp8
Parameter Description	<i>dscp1...dscp8:</i> Indicates the DSCP values mapped to the CoS values. The default CoS values 0~7 are mapped to DSCP 0, 8, 16, 24, 32, 40, 48 and 56 respectively. The DSCP value ranges from 0 to 63.
Command Mode	Global configuration mode
Usage Guide	-

➤ **Configuring DSCP-to-CoS MAP**

Command	mls qos map dscp-cos dscp-list to cos
Parameter Description	<i>dscp-list:</i> Indicates the DSCP list mapped to the CoS values. The default DSCP 0~7 are mapped to CoS 0, DSCP 8~15 mapped to CoS 1, DSCP 16~23 mapped to CoS 2, DSCP 24~31 mapped to CoS 3, DSCP 32~39 mapped to CoS 4, DSCP 40~47 mapped to CoS 5, DSCP 48~55 mapped to CoS 6, and DSCP 56~63 mapped to CoS 7. The DSCP value ranges from 0 to 63. <i>cos:</i> Indicates the CoS values mapped to the dscp-list, ranging from 0 to 7.
Command Mode	Global configuration mode
Usage Guide	-

Configuration Example

➤ **Configuring the trust mode and default CoS value of an interface**

Configuration Steps	<ul style="list-style-type: none"> ● Modify the trust mode of the interface gigabitEthernet 0/0 to DSCP.
----------------------------	---

	<ul style="list-style-type: none"> ● Change the default CoS value of the interface gigabitEthernet 0/1 to 7.
	<pre> FS# configure terminal FS(config)# interface gigabitEthernet 0/0 FS(config-if-GigabitEthernet 0/0)# mls qos trust dscp FS(config-if-GigabitEthernet 0/0)# exit FS(config)# interface gigabitEthernet 0/1 FS(config-if-GigabitEthernet 0/1)# mls qos cos 7 FS(config-if-GigabitEthernet 0/1)# exit </pre>
Verification	<ul style="list-style-type: none"> ● Check whether the trust mode and default CoS value are successfully configured for the interface.
	<pre> FS# show mls qos interface gigabitEthernet 0/0 Interface: GigabitEthernet 0/0 Ratelimit input: Ratelimit output: Attached input policy-map: Attached output policy-map: Default trust: dscp Default cos: 0 FS# show mls qos interface gigabitEthernet 0/1 Interface: GigabitEthernet 0/1 Ratelimit input: Ratelimit output: Attached input policy-map: Attached output policy-map: Default trust: none Default cos: 7 </pre>

📌 **Configuring the CoS-to-DSCP and DSCP-to-CoS mappings**

Configuration Steps	<ul style="list-style-type: none"> ● Configure CoS-to-DSCP to map CoS 0, 1, 2, 3, 4, 5, 6, and 7 to DSCP 7, 14, 21, 28, 35, 42, 49, and 56 respectively. ● Configure DSCP-to-CoS to map DSCP 0, 1, 2, 3, and 4 to CoS 4 and DSCP 11, 12, 13 and 14 to CoS 7.
	<pre> FS# configure terminal FS(config)# mls qos map cos-dscp 7 14 21 28 35 42 49 56 </pre>
	<pre> FS(config)# mls qos map dscp-cos 0 1 2 3 4 to 4 FS(config)# mls qos map dscp-cos 11 12 13 14 to 7 </pre>

Verification	<ul style="list-style-type: none"> ● Check whether all mappings are successfully configured.
	<pre> FS# show mls qos maps cos-dscp cos dscp ----- 0 7 1 14 2 21 3 28 4 35 5 42 6 49 7 56 </pre>
	<pre> FS# show mls qos maps dscp-cos dscp cos dscp cos dscp cos dscp cos ----- 0 4 1 4 2 4 3 4 4 4 5 0 6 0 7 0 8 1 9 1 10 1 11 7 12 7 13 7 14 7 15 1 16 2 17 2 18 2 19 2 20 2 21 2 22 2 23 2 24 3 25 3 26 3 27 3 28 3 29 3 30 3 31 3 32 4 33 4 34 4 35 4 36 4 37 4 38 4 39 4 40 5 41 5 42 5 43 5 44 5 45 5 46 5 47 5 48 6 49 6 50 6 51 6 52 6 53 6 54 6 55 6 56 7 57 7 58 7 59 7 60 7 61 7 62 7 63 7 </pre>

2.5.3 Configuring Interface Rate Limit

Configuration Effect

- Configure the traffic limit for an interface.

Notes

- The configuration is supported only by Ethernet interfaces.

Configuration Steps

➤ **Configuring the traffic limit for an interface**

- Optional.
- Configure the limit on the traffic and burst traffic for an interface.

Verification

- Run the **show mls qos rate-limit** command to display the rate limit information about the interface.

Related Commands

➤ **Configuring the traffic limit for an interface**

Command	rate-limit { input output } bps burst-size
Parameter Description	<p>input: Indicates the input direction of the interface.</p> <p>output: Indicates the output direction of the interface.</p> <p><i>bps:</i> Indicates the bandwidth limit per second (Kbits). The value range is determined by products.</p> <p><i>burst-size:</i> Indicates the burst traffic limit (Kbytes). The value range is determined by products.</p>
Command Mode	Interface configuration mode
Usage Guide	-

Configuration Example

➤ **Typical application – Interface rate limit + priority relabeling**

Configuration Steps	<ul style="list-style-type: none"> ● For Internet access by using the output interface, configure the output traffic limit on the interface G0/24, and set the bandwidth limit to 102,400 Kbits per second and burst traffic limit to 256 Kbytes per second. ● For the dormitory building, configure the input traffic limit on the interface G0/3, and set the bandwidth limit to 51,200 Kbits per second and burst traffic limit to 256 Kbytes per second. ● For the teaching building, configure the input traffic limit on the interface G0/1, and set the bandwidth limit to 30,720 Kbits per second and burst traffic limit to 256 Kbytes per second. ● For the laboratory, create the class <code>cmap_dscp7</code> to match DSCP priority 7, create the policy <code>pmap_shiyan</code> to associate with <code>cmap_dscp7</code>, bind the stream behavior of changing the DSCP value for packets whose rates exceed 20M to 16, apply <code>pmap_shiyan</code> to the interface G0/2, and configure the interface to trusting DSCP.
	<pre> FS# configure terminal FS(config)# interface gigabitEthernet 0/24 FS(config-if-GigabitEthernet 0/24# rate-limit output 102400 256 FS(config-if-GigabitEthernet 0/24)# exit FS(config)# interface gigabitEthernet 0/3 </pre>

	<pre> FS(config-if-GigabitEthernet 0/3# rate-limit input 51200 256 FS(config-if-GigabitEthernet 0/3)# exit FS(config)# interface gigabitEthernet 0/1 FS(config-if-GigabitEthernet 0/1# rate-limit input 30720 256 FS(config-if-GigabitEthernet 0/1)# exit </pre>
	<pre> FS(config)# class-map cmap_dscp7 FS(config-cmap)# match ip dscp 7 FS(config-cmap)# exit FS(config)# policy-map pmap_shiyan FS(config-pmap)# class cmap_dscp7 FS(config-pmap-c)# police 20480 128 exceed-action dscp 16 FS(config-pmap-c)# exit FS(config-pmap)# exit FS(config)# interface gigabitEthernet 0/2 FS(config-if-GigabitEthernet 0/2# service-policy input pmap_shiyan FS(config-if-GigabitEthernet 0/2)# mls qos trust dscp FS(config-if-GigabitEthernet 0/2)# exit </pre>
<p>Verification</p>	<ul style="list-style-type: none"> ● Check whether the interface rate limit is successfully configured. ● Check whether the class and policy are successfully created and successfully applied to the interface.
	<pre> FS# show mls qos rate-limit Interface: GigabitEthernet 0/1 rate limit input Kbps = 30720 burst = 256 Interface: GigabitEthernet 0/3 rate limit input Kbps = 51200 burst = 256 Interface: GigabitEthernet 0/24 rate limit output Kbps = 102400 burst = 256 </pre>
	<pre> FS# show class-map cmap_dscp7 Class Map cmap_dscp7 Match ip dscp 7 FS# show policy-map pmap_shiyan Policy Map pmap_shiyan </pre>

```

Class cmap_dscp7
    police 20480 128 exceed-action dscp 16
FS# show mls qos interface gigabitEthernet 0/2
Interface: GigabitEthernet 0/2
Ratelimit input:
Ratelimit output:
Attached input  policy-map: pmap_shiyan
Attached output policy-map:
Default trust: dscp
Default cos: 0

```

2.5.4 Configuring Congestion Management

Configuration Effect

- Configure the CoS-to-queue mapping.
- Configure the scheduling policy and round robin weight for an output queue.
- Configure the guaranteed minimum bandwidth and limited maximum bandwidth for a queue.
- Enables the queue ECN function.

Notes

- Interface configurations allow for only AP and Ethernet interface configurations.
- Both the ECN and WRED functions must be configured to enable the queue ECN function.

Configuration Steps

▾ Configuring the CoS-to-unicast and CoS-to-multicast mappings

- Optional.
- Configure the CoS-to-queue mappings. On products supporting multicast queues, you can configure the CoS-to-multicast queue mapping.

▾ Configuring the scheduling policies and round robin weight for unicast and multicast output queues

- Optional.
- Configure the scheduling policy for an output queue and modify the round robin weight. On products supporting multicast queues, you can configure the scheduling policies and round robin weights for multicast queues.

▾ Configuring the guaranteed minimum bandwidth and limited maximum bandwidth for a queue

- Optional.
- Configure the guaranteed minimum bandwidth and limited maximum bandwidth for a queue.
- Support global configuration mode and interface configuration mode. Function that these two modes support is different.

▾ Enabling the queue ECN

- Optional.
- Enable the queue ECN function.

Verification

- Run the **show mls qos queueing** command to display the output queue information.
- Run the **show mls qos scheduler** command to display the scheduling policy for the output queue.
- Run the **show qos bandwidth** command to display the queue bandwidth.

Related Commands

▾ Configuring CoS-to-Queue MAP

Command	priority-queue cos-map <i>qid</i> <i>cos0</i> [<i>cos1</i> [<i>cos2</i> [<i>cos3</i> [<i>cos4</i> [<i>cos5</i> [<i>cos6</i> [<i>cos7</i>]]]]]]]]]
Parameter	<i>qid</i> : Indicates the queue ID to be mapped, ranging from 1 to 8.
Description	<i>cos0~cos7</i> : Indicates the CoS values to be mapped to the <i>qid</i> . The default CoS values 0~7 are mapped to queues 1~8. The value range is 0 to 7.
Command Mode	Global configuration mode
Usage Guide	-

▾ Configuring the scheduling policy for an output queue to SP

Command	priority-queue
Parameter	-
Description	
Command Mode	Global configuration mode
Usage Guide	-

▾ Configuring the scheduling policy for an output queue

Command	mls qos scheduler { sp rr wrr drr wfq }
Parameter	sp : Sets the scheduling algorithm for an output queue to SP.
Description	rr : Sets the scheduling algorithm for an output queue to RR. wrr : Sets the scheduling algorithm for an output queue to WRR. drr : Sets the scheduling algorithm for an output queue to DRR. wfq : Sets the scheduling algorithm for an output queue to WFQ.
Command Mode	Global/Interface configuration mode
Usage Guide	-

▾ Configuring the scheduling policy and round robin weight for an output queue

Command	{ drr-queue wrr-queue wfq-queue } bandwidth <i>weight1...weight8</i>
Parameter	drr-queue : Configures the round robin weight corresponding to the DRR scheduling policy for an output queue.
Description	wrr-queue : Configures the round robin weight corresponding to the WRR scheduling policy for an output queue.

	wfq-queue: Configures the round robin weight corresponding to the WFQ scheduling policy for an output queue. <i>weight1...weight8:</i> Indicates the weight of queues 1 to 8. The value range is determined by products. The value 0 indicates that the queue uses the SP scheduling algorithm. The default weight for global/interface queues is 1:1.
Command Mode	Global/Interface configuration mode
Usage Guide	-

📌 **Configuring the guaranteed minimum bandwidth and limited maximum bandwidth for a queue**

Command	qos queue [ucast mcast] queue-id bandwidth { minimum maximum } bandwidth
Parameter Description	queue [ucast mcast]: queue ucast configures the guaranteed minimum bandwidth or limited maximum bandwidth for devices that allow for configuring the unicast queue bandwidth limit; queue mcast configures the guaranteed minimum bandwidth or limited maximum bandwidth for devices that allow for configuring the multicast queue bandwidth limit; queue configures the guaranteed minimum bandwidth or limited maximum bandwidth for devices that allow for configuring both the unicast and multicast queue bandwidth limits. <i>queue-id:</i> Indicates the queue ID to be configured, ranging from 1 to 8. minimum bandwidth: Indicates the guaranteed minimum bandwidth Kbps. The value range is determined by products. It is not configured by default. maximum bandwidth: Indicates the limited maximum bandwidth Kbps. The value range is determined by products. It is not configured by default.
Command Mode	Interface/Global configuration mode
Usage Guide	-

📌 **Enabling the queue ECN**

Command	qos queue queue-id ecn
Parameter Description	<i>queue-id:</i> ID of the queue. Range: 1 to 8.
Command Mode	Interface configuration mode
Usage Guide	Both the ECN and WRED functions must be configured to enable the queue ECN function.

Configuration Example

📌 **Configuring the CoS-to-queue mapping and modifying the scheduling policy and its round robin weight**

Configuration Steps	<ul style="list-style-type: none"> ● Configure the CoS-to-queue mapping to the mapping from the CoS values 0, 1, 2, 3, 4, 5, 6, and 7 to queues 1, 2, 5, 5, 5, 5, 7, and 8. ● Configure the output scheduling policy for a queue to DRR and the round robin weight to 2:1:1:1:6:6:6:8.
	<pre> FS# configure terminal FS(config)# priority-queue cos-map 1 2 5 5 5 5 7 8 FS(config)# mls qos scheduler drr FS(config)# drr-queue bandwidth 2 1 1 1 6 6 6 8 </pre>

<p>Verification</p>	<ul style="list-style-type: none"> ● Check whether the CoS-to-queue mapping is successfully created, and whether the output scheduling policy and round robin weight are successfully configured for the queue.
	<pre> FS# show mls qos scheduler Global Multi-Layer Switching scheduling Deficit Round Robin FS# show mls qos queueing CoS-to-queue map: cos qid ----- 0 1 1 2 2 5 3 5 4 5 5 5 6 7 7 8 wrr bandwidth weights: qid weights ----- 1 1 2 1 3 1 4 1 5 1 6 1 7 1 8 1 drr bandwidth weights: qid weights ----- 1 2 </pre>

```

2  1
3  1
4  1
5  6
6  6
7  6
8  8

wfq bandwidth weights:
qid weights
-----
1  1
2  1
3  1
4  1
5  1
6  1
7  1
8  1
    
```

📌 **Enabling the queue ECN**

Configuration Steps	<ul style="list-style-type: none"> Enables ECN on queue 1 of interface gigabitEthernet 0/1.
	<pre> FS# configure terminal FS(config)# queueing wred FS(config)# interface gigabitEthernet 0/1 FS(config-if-GigabitEthernet 0/1)# qos queue 1 ecn FS(config-if-GigabitEthernet 0/1)# exit </pre>
Verification	<ul style="list-style-type: none"> Run the show run command to check the result.

📌 **Typical application – Priority relabeling + queue scheduling**

Configuration Steps	<ul style="list-style-type: none"> Create ACLs for accessing various servers and create classes for matching these ACLs. Create policies for associating with the classes and specify new CoS values for packets accessing various
----------------------------	--

	<p>servers. Associate the CoS values with the input interfaces for the R&D and market departments and configure the interfaces to trusting CoS.</p> <ul style="list-style-type: none"> ● Configure the default CoS value for the HR management department interface to the highest priority 7 to ensure that packets from the HR management department are sent in the highest priority. ● Configure the output scheduling policy to WR and the round robin weight to 1:1:1:2:6:1:1:0 for the queues. This means that the SP scheduling algorithm is used for packets of the HR management department, and the packets of the R&D and market departments for accessing the mail database, file database and salary query database are scheduled based on the ratio of 6:2:1.
	<pre> FS# configure terminal FS(config)# ip access-list extended salary FS(config-ext-nacl)# permit ip any host 192.168.10.1 FS(config-ext-nacl)# exit FS(config)# ip access-list extended mail FS(config-ext-nacl)# permit ip any host 192.168.10.2 FS(config-ext-nacl)# exit FS(config)# ip access-list extended file FS(config-ext-nacl)# permit ip any host 192.168.10.3 FS(config-ext-nacl)# exit </pre>
	<pre> FS(config)# class-map salary FS(config-cmap)# match access-group salary FS(config-cmap)# exit FS(config)# class-map mail FS(config-cmap)# match access-group mail FS(config-cmap)# exit FS(config)# class-map file FS(config-cmap)# match access-group file </pre>
	<pre> FS(config)# policy-map toserver FS(config-pmap)# class mail FS(config-pmap-c)# set cos 4 FS(config-pmap-c)# exit FS(config-pmap)# class file FS(config-pmap-c)# set cos 3 FS(config-pmap-c)# exit FS(config-pmap)# class salary FS(config-pmap-c)# set cos 2 </pre>

	<pre>FS(config-pmap-c)# end</pre>
	<pre>FS(config)# interface gigabitEthernet 0/1 FS(config-if-GigabitEthernet 0/1)# service-policy input toserver FS(config-if-GigabitEthernet 0/1)# mls qos trust cos FS(config-if-GigabitEthernet 0/1)# exit FS(config)# interface gigabitEthernet 0/2 FS(config-if-GigabitEthernet 0/2)# service-policy input toserver FS(config-if-GigabitEthernet 0/2)# mls qos trust cos FS(config-if-GigabitEthernet 0/2)# exit</pre>
	<pre>FS(config)# interface gigabitEthernet 0/3 FS(config-if-GigabitEthernet 0/3)# mls qos cos 7</pre>
	<pre>FS(config)#wrr-queue bandwidth 1 1 1 2 6 1 1 0 FS(config)#mls qos scheduler wrr</pre>
Verification	<ul style="list-style-type: none"> ● Check whether the ACLs are successfully created and whether the classes are successfully associated with the ACLs. ● Check whether the policies are successfully created, whether the classes and stream behaviors are successfully bound, and whether policies are successfully applied to the interfaces. ● Check whether the default CoS value is successfully configured for the interface and whether the scheduling policy and the round robin weight are successfully configured.
	<pre>FS# show access-lists ip access-list extended file 10 permit ip any host 192.168.10.3 ip access-list extended mail 10 permit ip any host 192.168.10.2 ip access-list extended salary 10 permit ip any host 192.168.10.1</pre>
	<pre>FS# show class-map Class Map salary Match access-group salary</pre>

	<pre> Class Map mail Match access-group mail Class Map file Match access-group file </pre>
	<pre> FS# show policy-map Policy Map toserver Class mail set cos 4 Class file set cos 3 Class salary set cos 2 </pre>
	<pre> FS# show mls qos interface gigabitEthernet 0/1 Interface: GigabitEthernet 0/1 Ratelimit input: Ratelimit output: Attached input policy-map: toserver Attached output policy-map: Default trust: cos Default cos: 0 FS# show mls qos interface gigabitEthernet 0/2 Interface: GigabitEthernet 0/2 Ratelimit input: Ratelimit output: Attached input policy-map: toserver Attached output policy-map: Default trust: cos Default cos: 0 </pre>
	<pre> FS# show mls qos interface gigabitEthernet 0/3 Interface: GigabitEthernet 0/2 Ratelimit input: Ratelimit output: </pre>

	<p>Attached input policy-map:</p> <p>Attached output policy-map:</p> <p>Default trust: none</p> <p>Default cos: 7</p>
	<pre> FS# show mls qos scheduler Global Multi-Layer Switching scheduling Weighted Round Robin FS# FS#show mls qos queueing CoS-to-queue map: cos qid ----- 0 1 1 2 2 3 3 4 4 5 5 6 6 7 7 8 wrr bandwidth weights: qid weights ----- 1 1 2 1 3 1 4 2 5 6 6 1 7 1 8 0 drr bandwidth weights: qid weights </pre>

```
-----  
1 1  
2 1  
3 1  
4 1  
5 1  
6 1  
7 1  
8 1  
  
wfq bandwidth weights:  
qid weights  
-----  
1 1  
2 1  
3 1  
4 1  
5 1  
6 1  
7 1  
8 1
```

2.5.5 Configuring Congestion Mitigation

Configuration Effect

- Configure the lower and higher threshold value for WRED. When the length of packets in a queue is smaller than the lower threshold value, WRED does not discard packets.
- Configure the maximum discarding probability. When the length of packets in the queue is between the lower and higher threshold values, WRED discards packets in random. The maximum probability for discarding packets is configured.
- Configure the CoS-to-threshold mapping.

Notes

- Interface configurations allow for only AP and Ethernet interface configurations.

Configuration Steps

➤ Enabling the WRED function

- Optional.
 - Enable the WRED function if necessary.
- ↘ **Configuring the lower threshold value**
- Optional.
 - Configure the lower threshold value if necessary.

- ↘ **Configuring the higher threshold**
- Optional.
 - Configure the higher threshold if necessary.

- ↘ **Configuring the maximum discarding probability**
- Optional.
 - Configure the maximum discarding probability if necessary.

- ↘ **Adjusting the average queue length for discarding probability**
- Optional.
 - Configure the sampling interval and weight of the average queue length if necessary.

- ↘ **Configuring the CoS-to-threshold mapping**
- Optional.
 - Configure the CoS-to-threshold mapping if necessary.

Verification

- Run the **show queueing wred interface** command to display the WRED configuration.
- Run the **show qos wred-ecn statistics** command to display the statistics of packets discarded by WRED and packets marked by ECN.

Related Commands

↘ **Enabling the WRED function**

Command	queueing wred
Parameter	-
Description	
Command	Global configuration mode
Mode	
Usage Guide	-

↘ **Configuring the lower threshold (in the unit of percentage)**

Command	wrr-queue random-detect min-threshold <i>queue_id</i> <i>thr1</i> [<i>thr2</i>]
Parameter	<i>queue_id</i> : Indicates the queue ID for an interface, ranging from 1 to 8.
Description	<i>thrN</i> : Supports 2 groups of lower thresholds, ranging from 1 to the specified higher threshold.

Command Mode	Interface configuration mode
Usage Guide	<p>Because the maximum value of the configuration range is equal to the current higher threshold, you need to pay attention to the setting of the higher threshold when configuring the lower threshold.</p> <p>The threshold for packets to be discarded by WRED can be configured in the unit of percentage or cell. The latter configured mode prevails.</p>

↘ Configuring the higher threshold (in the unit of percentage)

Command	wrr-queue random-detect max-threshold <i>queue_id</i> <i>thr1</i> [<i>thr2</i>]
Parameter Description	<p><i>queue_id</i>: Indicates the ID of a queue on an interface, ranging from 1 to 8.</p> <p><i>thrN</i>: Supports 2 groups of higher thresholds, ranging from the specified lower threshold to 100.</p>
Command Mode	Interface configuration mode
Usage Guide	<p>Because the minimum value of the configured range is equal to the current lower threshold, you need to consider the lower threshold when configuring the higher threshold.</p> <p>The threshold for packets to be discarded by WRED can be configured in the unit of percentage or cell. The latter configured mode prevails.</p>

↘ Configuring the lower threshold (in the unit of cell)

Command	wrr-queue random-detect cell min-threshold <i>queue_id</i> <i>thr1</i> [<i>thr2</i>]
Parameter Description	<p><i>queue_id</i>: Indicates the ID of a queue on an interface, ranging from 1 to 8.</p> <p><i>thrN</i>: Supports 2 groups of lower thresholds, ranging from 1 to the specified higher threshold.</p> <p>The default value is determined by products.</p>
Command Mode	Interface configuration mode
Usage Guide	<p>Whether this command is available is determined by products.</p> <p>Because the maximum value of the configuration range is equal to the current higher threshold, you need to pay attention to the setting of the higher threshold when configuring the lower threshold.</p> <p>The threshold for packets to be discarded by WRED can be configured in the unit of percentage or cell. The latter configured mode prevails.</p>

↘ Configuring the higher threshold (in the unit of cell)

Command	wrr-queue random-detect cell max-threshold <i>queue_id</i> <i>thr1</i> [<i>thr2</i>]
Parameter Description	<p><i>queue_id</i>: Indicates the ID of a queue on an interface, ranging from 1 to 8.</p> <p><i>thrN</i>: Supports 2 groups of higher thresholds, ranging from the set lower threshold to the maximum higher threshold.</p> <p>The default value is determined by products.</p>
Command Mode	Interface configuration mode

	<ul style="list-style-type: none"> ● Configure the maximum discarding probabilities for queue 2 of the interface gigabitEthernet 0/2 to 60 and 80. ● Configure the CoS values 0, 1, 2, and 3 on the interface gigabitEthernet 0/2 to use the threshold group 2.
	<pre> FS# configure terminal FS(config)# queueing wred FS(config)# interface gigabitEthernet 0/2 FS(config-if-GigabitEthernet 0/2)# wrr-queue random-detect min-threshold 2 10 20 FS(config-if-GigabitEthernet 0/2)#wrr-queue random-detect max-threshold 2 60 90 FS(config-if-GigabitEthernet 0/2)# wrr-queue random-detect probability 2 60 80 FS(config-if-GigabitEthernet 0/2)# wrr-queue random-detect probability 2 60 80 FS(config-if-GigabitEthernet 0/2)# wrr-queue cos-map 2 0 1 2 3 </pre>
Verification	<ul style="list-style-type: none"> ● Check whether the WRED function is enabled, whether the threshold values are successfully configured, and whether the CoS-to-threshold mapping is successfully configured.
	<pre> FS# show running-config Building configuration... Current configuration : 1654 bytes version 11.0(1C2B1)(09/11/13 00:16:26 CST -ngcf78) queueing wred FS# show queueing wred interface gigabitEthernet 0/2 ----- qid max_cell_1 min_cell 1 max_1 min_1 prob_1 max_cell_2 min_cell 2 max_2 min_2 prob_2 ----- 1 120000 120000 0 0 0 120000 120000 1 1 1 2 120000 120000 60 10 60 120000 120000 90 20 80 3 120000 120000 0 0 0 120000 120000 1 1 1 4 120000 120000 0 0 0 120000 120000 1 1 1 5 120000 120000 0 0 0 120000 120000 1 1 1 6 120000 120000 0 0 0 120000 120000 1 1 1 7 120000 120000 0 0 0 120000 120000 1 1 1 8 120000 120000 0 0 0 120000 120000 1 1 1 </pre>

<pre> ----- cos qid threshold_id ----- 0 1 2 1 2 2 2 5 2 3 5 2 4 5 1 5 5 1 6 7 1 7 8 1 </pre>	<ul style="list-style-type: none"> ● Check the packets discarded by WRED and packets marked by ECN. <p>Products do not support port queue statistics display:</p> <pre> FS#show qos wred-ecn statistics Wred ecn stats result: Port WredDropped EcnSended ----- TFGigabitEthernet 0/1 0 0 TFGigabitEthernet 0/2 0 0 TFGigabitEthernet 0/3 0 0 TFGigabitEthernet 0/4 0 0 TFGigabitEthernet 0/5 0 0 TFGigabitEthernet 0/6 0 0 TFGigabitEthernet 0/7 0 0 TFGigabitEthernet 0/8 0 0 TFGigabitEthernet 0/9 0 0 TFGigabitEthernet 0/10 0 0 TFGigabitEthernet 0/11 0 0 TFGigabitEthernet 0/12 0 0 </pre> <p>Products support port queue statistics display:</p> <pre> FS#show qos wred-ecn statistics Wred ecn stats result: </pre>
---	---

port	WredDropped	EcnSended

GigabitEthernet 0/3	10	15
Queue 1:	1	2
Queue 2:	1	2
Queue 3:	1	2
Queue 4:	1	2
Queue 5:	1	2
Queue 6:	1	2
Queue 7:	1	2
Queue 8:	3	1
TenGigabitEthernet 0/32	10	15
Queue 1:	1	2
Queue 2:	1	2
Queue 3:	1	2
Queue 4:	1	2
Queue 5:	1	2
Queue 6:	1	2
Queue 7:	1	2
Queue 8:	3	1

2.5.6 Configuring Queue Display and Configuration Mode

Configuration Effect

- Configure the queue display and configuration mode to change the display and configuration mode of all queues on the device from 1–8 to 0–7.

Notes

- After the queue display and configuration mode is configured, the configured queue-related commands change automatically.

Configuration Steps

📌 Setting the queue display and configuration mode to 0–7

- Optional.
- Set the queue display and configuration mode to 0–7 if necessary.

Verification

- Run the **show running-config** command to display the configurations.

Related Commands

▾ **Setting the queue display and configuration mode to 0-7**

Command	qos-queue compatible enable
Parameter	N/A
Description	
Command Mode	Global configuration mode
Usage Guide	N/A

Configuration Example

▾ **Setting the queue display and configuration mode to 0-7**

Configuration Steps	<ul style="list-style-type: none"> ● Enable global QOS.
	<pre>FS# configure terminal FS(config)# qos-queue compatible enable</pre>
Verification	<ul style="list-style-type: none"> ● Check whether the the configuration succeeded.
	<pre>FS# show running-config Building configuration... Current configuration : 1654 bytes version 11.0(1C2B1)(09/11/13 00:16:26 CST -ngcf78)</pre>

2.5.7 Disabling Packet Priority Modification

Configuration Effect

- After packet priority modification is disabled, the priority of a packet when it is sent out from a device is the same as that when the packet is sent to the device.

Notes

Configuration Steps

▾ **Disabling packet priority modification**

- Optional.

- To ensure that the priority of a packet when it is sent out from a device is the same as that when it is sent to the device, disable packet priority modification.

Verification

- Run the **show running-config** command to display the configurations.

Related Commands

↘ **Disabling packet priority modification**

Command	mls qos remark disable
Parameter	N/A
Description	
Command Mode	Global configuration mode
Usage Guide	N/A

Configuration Example

↘ **Disabling packet priority modification**

Configuration Steps	<ul style="list-style-type: none"> ● Disable packet priority modification.
	<pre>FS#configure terminal FS(config)#mls qos remark disable</pre>

2.6 Monitoring

Clearing

Description	Command
Clear the statistics of packets discarded by WRED and packets marked by ECN.	<p>clear qos wred-ecn statistics [interfaces interface-id]</p> <p> For some products not supporting this command, run the clear queue-counter [interfaces interface-id] command.</p>

Displaying

Description	Command
Displays stream classification information.	show class-map [class-map-name]
Displays QoS policy information.	show policy-map [policy-map-name [class class-map-name]]
Displays the policy applied to an interface.	show policy-map interface interface-id
Displays logical interface group information.	show virtual-group [virtual-group-number summary]
Displays the policy applied to a logical	show mls qos virtual-group [virtual-group-number policers]

Description	Command
interface group.	
Displays various mappings.	show mls qos maps [cos-dscp dscp-cos ip-prec-dscp]
Displays interface rate limit information.	show mls qos rate-limit [interface <i>interface-id</i>]
Displays the QoS queue, scheduling policy and round robin weight information.	show mls qos queueing [interface <i>interface-id</i>]
Displays the scheduling information of an output queue.	show mls qos scheduler [interface <i>interface-id</i>]
Displays the configurations of WRED.	show queueing wred interface <i>interface-id</i>
Displays the QoS information of an interface.	show mls qos interface <i>interface-id</i> [policers]
Displays the bandwidth information of an interface.	show qos bandwidth [interfaces <i>interface-id</i>]
Display the statistics of packets discarded by WRED and packets marked by ECN.	show qos wred-ecn statistics [interfaces <i>interface-id</i>]

Debugging



System resources are occupied when debugging information is output. Therefore, disable debugging immediately after use.

Description	Command
Debugs the QoS library.	debug qos lib [event message]
Debugs the QoS communication server.	debug qos server [event message]
Debugs QoS user command processing.	debug qos mls
Debugs VMSUP configurations.	debug qos vmsup

3Configuring MMU

3.1Overview

The Memory Management Unit (MMU) means that the chip buffer is distributed reasonably so that the switching equipment can better deal with all kinds of burst flows.

Flows not steady all the time and various burst flows exist on the network. When the network flow is steady and the bandwidth is sufficient, all the data flows are processed better; when burst flows exist on the network, data flows may be discarded even if the average flow rate does not exceed the bandwidth.

Data packets that enter the switching equipment are stored in the buffer of switching equipment before being forwarded. Normally, data packets stay for a short period of time in the buffer and will be forwarded in microseconds; when there is a burst flow, if the instantaneous rate of burst flow exceeds the processing capacity of the switching equipment, the data packets that cannot be processed in time will be piled up in the switching equipment and packet loss will take place once the buffer is insufficient. In this case, the MMU can be used to reasonably configure the buffer and allocate different buffer sizes to respective services, with a view to optimizing the network.

3.2Applications

Application	Description
Configuring Large Buffer Application Based on Egress Queue	An enterprise needs a buffer large enough in the SkyDrive service to avoid packet loss for the service flow.
Configuring Large Buffer Application Based on Ingress PG	An enterprise needs to ensure no package loss in RDMA scenario. When the buffer reaches the threshold, PAUSE frame based on PFC mechanism should be generated to ensure no package loss.

3.2.1Configuring Large Buffer Application Based on Egress Queue

Scenario

An enterprise needs a buffer large enough in the SkyDrive service to avoid packet loss for the service flow.

As shown in the following figure, equipment A is connected to 5 clients and 35 service servers, where 15 service servers virtualize 15 front end servers.

The main service flow is as follows:

- The client server sends a request packet to the front end server.
- The front end server sends the received request packet to the service server.
- After receiving the request packet, the service server sends a response packet to the front end server.
- After receiving the response packet, the front end server sends it to the client server.
- After receiving the response packet, the client indicates that a session is created successfully.

A many-to-one flow transmission mode exists under this service model:

- The request flows of multiple clients are sent to one front end server.
- The request flows of multiple front end servers are sent to one service server.

- The response flows of multiple service servers are sent to one front end server.
- The response flows of multiple front end servers are sent to one client.

These flows are transmitted through equipment A basically, easily leading to network congestion. Such a problem can be fixed by configuring a large buffer on the equipment.

Figure 3-1

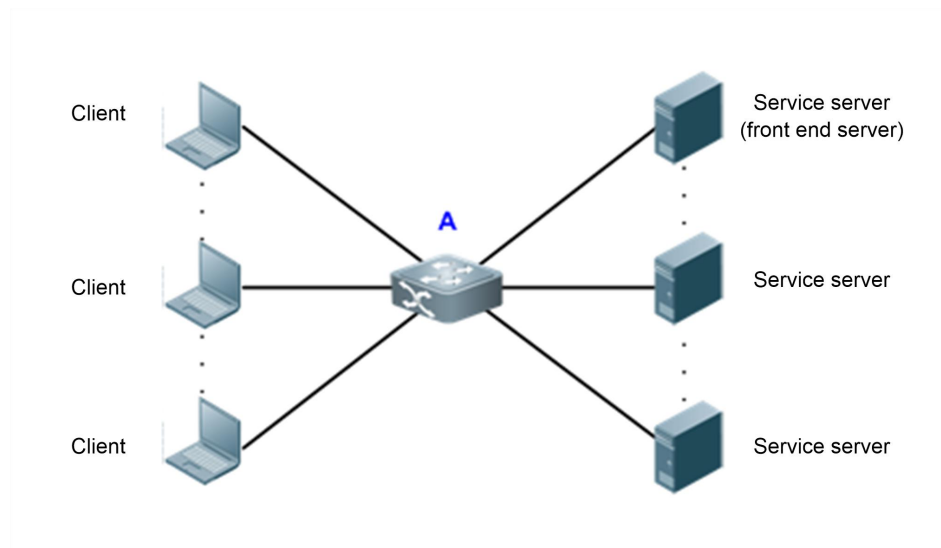

Deployment

- In all the service ports (namely, the ports connecting clients to servers), configure the shared buffer of the queue where the service is as 100%.
- In all the service ports, configure the minimum value for the guaranteed buffer of the queue not in use.
- In all the ports not in use, configure the minimum value for the guaranteed buffers of all the queues.
- For the specific configuration, see the configuration examples in "Configuration".

3.2.2 Configuring Large Buffer Application Based on Ingress PG

Scenario

A large enterprise needs to ensure no package loss in the data center. There are three kinds of flow in the data center:

- Storage flow: no package loss.
- High-performance computing flow: low delay.
- Ethernet flow: package loss and delay are allowed.

The traditional data center implements three networks for different flows, as shown below:

Figure 3- 1

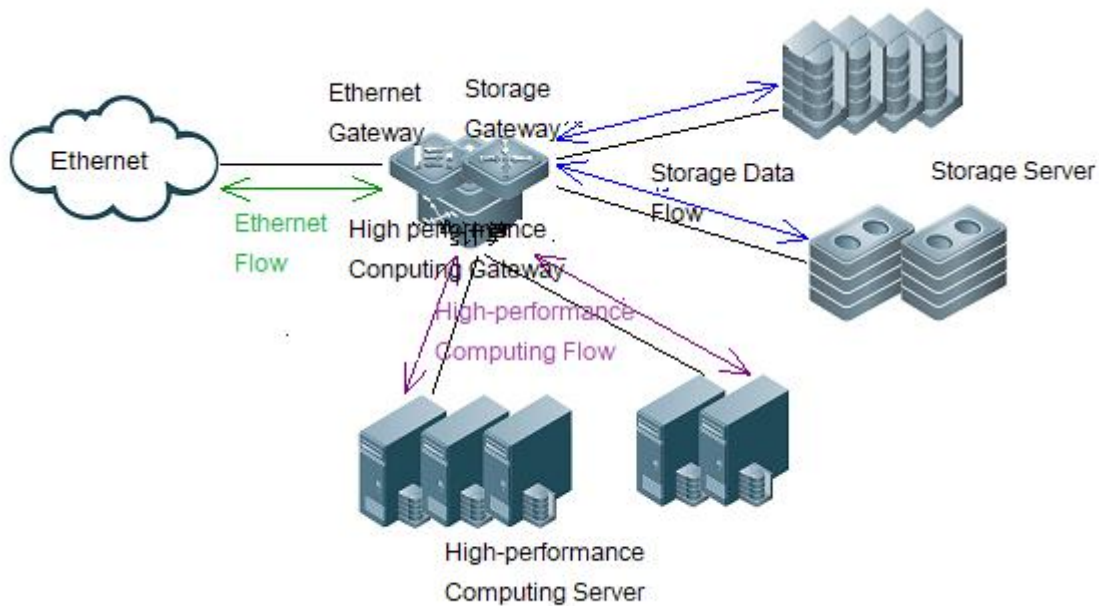

As the center scale expands, Ethernet is applied to take three kinds of flow and more mechanism is added so that it can meet different requirements, and storage package will not lose and have no effect on other 2 flows based on PFC (Priority-based Flow Control) of ingress PG.

Deployment

- Map RDMA flow to a PG.
- Enable PFC on the PG to ensure no package loss of the flow.
- Configure xon/xoff threshold on the PG to generate flow control frame.
- For the PG not enabling PFC, the PG shared threshold should be higher than the egress threshold to ensure no packet loses on the ingress.
- For the PG enabling PFC, PG XOFF buffer threshold should be lower than the egress threshold to perform PFC function.
-  For more specific configuration, see Configuration Examples in Configuration.

3.3 Features

Basic Concepts

➤ Cell

Cell is a buffer unit, i.e., the minimum unit for the switching equipment to store packets. The size of each cell varies with the product. One packet can use multiple cells, while one cell can be used by only one packet.

➤ Priority group (PG)

For the sake of better buffer management, BCM chip offers 8 PGs on the ingress direction for independent buffer management. Packets with different priorities (0-7) can be mapped to different PGs or one PG, so as to provide different buffer allocation scheme for packets with different priorities.

➤ Egress queue

Port egress queues are classified into unicast queues and multicast queues. Logically the switching chip is divided into the ingress (incoming direction) and egress (outgoing direction). The egress queue is in the egress direction. Before packets go out of the egress, the enqueue operation needs to be performed for them at the egress queue. Some of our products implement buffer management based on the egress queue.\

Figure 3-2

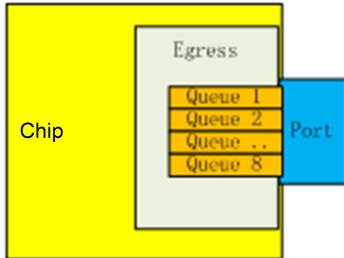

Currently there are three types of egress queue models:

- There are 8 unicast queues and 8 multicast queues at the egress. The well-known unicast packets follow the unicast queue, and all the other packets follow the multicast queue.
- There are 8 unicast queues and 4 multicast queues at the egress. The well-known unicast packets follow the unicast queue, and all the other packets follow the multicast queue.
- There are only 8 queues at the egress, without differentiating unicast and multicast.

Overview

Feature	Description
Buffer Adjustment	The buffer is adjusted based on the queue, PG and service pool. It is the foundation of MMU.
Status Monitoring	Status monitoring actually means monitoring the buffer use, and the number and rate of packets forwarded/discarded by the queue, which facilitates buffer adjustment.
Exception Alarm	Exception alarm analyses the device buffer and forwarding status, and displays the alarm when an exception occurs.

3.3.1 Configuring Buffer Adjustment

Buffer adjustment means that the queue of each service has different buffer sizes through some adjustment of the queue buffer so that each service is treated differently and services at different priorities are served differently.

Working Principle

Working mechanism of caching in hardware

Buffer adjustment means that the queue of each service has different buffer availability through some adjustment of the chip buffer so that each service is treated differently and services at different priorities are served differently.

Figure 3-3

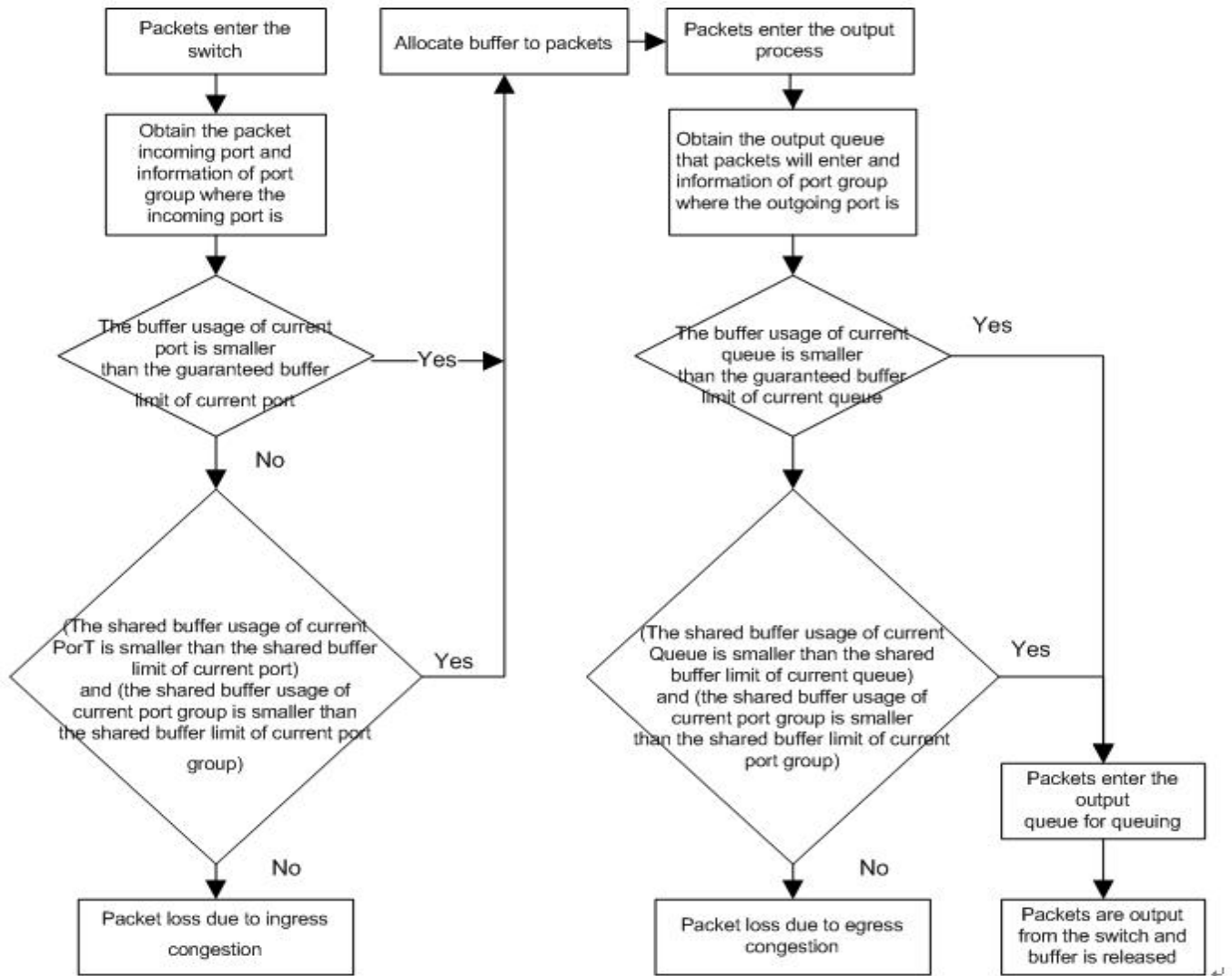

During buffer management, the input direction is adjusted to the maximum value to prevent packet loss in the input direction and make packet loss take place in the output direction. Therefore, adjustment is not opened for the buffer in the input direction, and CLI provides buffer adjustment in the output direction only, including the queue guaranteed buffer and queue shared buffer. Buffer adjustment configures the guaranteed buffer threshold and shared buffer threshold of queues to allocate different buffer sizes to queues.

➤ **Guaranteed buffer**

Guaranteed buffer is also called exclusive buffer. This part of buffer is distributed based on each queue. The guaranteed buffer of a queue can be used by this queue only. A fixed guaranteed buffer is allocated to each queue by default. This part of queue enables this queue to forward packets at the normal line rate under the stable flow.

➤ **Shared buffer**

In the total buffer of port group, the remaining part is the total shared buffer after the global guaranteed buffer and global headroom are deducted. The shared buffer can be allocated to one or several service pools. There is only one service pool (SP0) by default. On the input/output, a new shared service pool can be established by dividing room from SP0, and the mapping relationship between the input PG/output queue and the shared service pool can be configured respectively. A shared queue threshold can be set for each queue or PG. This threshold restricts the maximum shared buffer quantity that can be used by this queue. When the shared buffer

sum configured for each queue in the port group exceeds the total shared queue of port group, the "First Come First Served" buffer occupancy mechanism is adopted.

↘ **Headroom buffer**

Headroom is the buffer on the ingress direction. PG that is enabled with flow control function will enter XOFF status after the guarantee and shared buffer runs out. To receive packets, it needs to use headroom buffer. Headroom is used to ensure no packet loss during the buffer flow control packet is sent and the rate decreases.

3.3.2 Configuring Status Monitoring

Status monitoring implements monitoring on the buffer use and the packet forwarding of each PG/queue, with a view to providing data support for network optimization and reasonable buffer configuration.

Working Principle

Status monitoring adopts the polling mode to read the buffer use amount and the number of packets forwarded/discarded by the queue, so as to display the equipment situation in real time.

↘ **Buffer Occupancy on Ingress**

Collect the information of use of PG guaranteed/shared/headroom buffer on the ingress direction and the buffer occupancy of service pool at the fixed time, which can be checked by CLI, MIB or other methods.

↘ **Buffer Occupancy on Egress**

Collect the information of use of PG guaranteed/shared/headroom buffer on the egress direction and the buffer occupancy of service pool at the fixed time, which can be checked by CLI, MIB or other methods.

↘ **Packet Forwarding/Discarding of Egress Queue**

Collect the information of the number and byte of packets forwarded/discarded by the egress queue, and calculate the forwarding rate at the fixed time, which can be checked by CLI, MIB or other methods.

↘ **Buffer monitoring data sampling interval**

Buffered monitoring data is sampled at a certain interval, and the interval can be configured based on user requirements.

↘ **Slice ID Numbering Mode of MMU Buffer**

Configure the numbering mode of slice ID (start from 1 or 0), and switch the numbering mode of CLI/MIB.

3.3.3 Configuring Exception Alarm

Exception alarm monitors the packet forwarding and discarding of each queue, and displays alarms when the buffer exceeds threshold or packet loses.

Working Principle

The queue adopts the polling mode to read buffer occupancy and forwarding number of queue, and offers alarms by syslog based on the current configuration.

↘ Queue packet loss alarm

The device analyzes statistics on discarded packets to judge whether packet loss occurs on a queue. After packet loss occurs on a queue, the device displays a packet loss alarm according to the packet loss alarm configuration.

↘ Queue packet loss alarm frequency

Only N packet loss alarms can be displayed within a certain period of T . You can configure the period (T) and number of alarms (N) to adjust the display of packet loss alarms.

↘ PG buffer utilization alarm threshold

When the buffer utilization of PG exceeds this threshold, syslog will be printed to remind the user.

↘ Queue buffer utilization alarm threshold

When the buffer utilization of queue exceeds this threshold, syslog will be printed to remind the user.

↘ MMU-HA buffer crash detection

The buffer management unit of chip may crash unexpectedly at runtime. MMU-HA analyzes buffer occupancy, queue forwarding, scheduling mode etc. to judge whether crash occurs. If crash occurs, it will display an alarm by syslog and the device will automatically restart.

3.4 Limitations



The cell size varies with products.

Card Type	Cell Size (Byte)
S6510	256
S6520	208
S6250	256



Products cache and manage packets based on the queue type. See the table below.

Card Type	Queue Type for Cache Management
S6510	Outbound direction: output unicast/multicast; inbound direction: priority group
S6520	Outbound direction: output unicast/multicast; inbound direction: priority group
S6250	Outbound direction: output unicast/multicast; inbound direction: priority group



The default value of guaranteed cache varies with products. See the table below.

Card Type	Output Unicast	Output Multicast	Priority Group
S6510	8	8	8
S6520	8	8	8
S6250	8	8	8



The default value of shared cache varies with products. See the table below.

Card Type	Output Unicast	Output Multicast	Priority Group
S6510	100%	15%	100%
S6520	100%	15%	100%
S6250	100%	15%	100%





An error exists between the value of the configured shared cache and the actually available shared cache on the hardware due to chip mechanism differences. See the table below.

The table below lists the error range of the S60 series devices.

Configured Range (%)	Actually Available Size on the Hardware (%)
1-3	1.53
4-5	3.03
6-11	5.88
12-19	11.11
20-33	20.00
34-49	33.33
50-66	50.00
67-79	66.66
80-88	80.00
89-100	88.88

3.5 Configuration

Configuration	Description and Command	
Buffer Adjustment	(Optional) It is used to configure buffer.	
	mmu queue-guarantee	Configures guaranteed buffer.
	mmu queue-threshold	Configures shared buffer.
	mmu buffer-mode	Configures buffer mode.
	mmu ingress-threshold	Configures ingress PG shared buffer.
	mmu xoff-threshold	Configures ingress PG flow control threshold.
	mmu xon-threshold-offset	Configures ingress PG flow control restoration threshold.
	mmu headroom-threshold	Configures the PG-based headroom buffer size.
	mmu pg-headroom	Configures the global headroom buffer size.
	mmu guarantee-limit	Configures the global guaranteed buffer size.
	mmu {ingress egress} service-pool	Configures the ingress/egress SP size.
	mmu {priority-group unicast-queue multicast-queue } {id1[id2[idN]]} attach	Configures the mapping relation between ingress PG/egress unicast/egress multicast and SP.
mmu cut-through	Configures cut-through transmission mode	

Status Monitoring	 (Optional) It is used to configure monitoring function.	
	mmu sample-period	Configures the buffer monitoring data sampling interval.
	mmu slice-id compatible	Configures the numbering mode of slice ID
Exception Alarm	 (Optional) It is used to detect exception.	
	mmu usage-warn-limit	Configures the buffer utilization alarm threshold.
	mmu queue-loss-warn {unicast multicast}	Configures the queue packet loss alarm.
	mmu queue-loss-warn frequency	Configures the packet loss alarm frequency.
	mmu ha	Configures MMU-HA function/reset
	mmu tcb-enable	Configures the MMU-TCB function.

3.5.1 Configuring Buffer Adjustment

Configuration Effect

- Configure guaranteed buffer so that the PG/queue can use this part of buffer exclusively.
- Configure shared buffer so as to control the shared buffer use amount of the PG/queue.
- Configure PG headroom buffer so as to control the headroom buffer use amount of PG.
- Configure global guaranteed buffer so as to control the guaranteed buffer amount reserved for PG/queue.
- Configure global headroom buffer so as to control the headroom buffer amount reserved for PG.
- Configure the size of ingress/egress service pool to control the buffer amount allocated to the service pool.
- Configure the mapping relationships between PG/queue and service pool to allocate buffer from the specific pool.
- Configure the cut-through transmission mode to control whether the flow has MMU buffer allocation.

Notes

- Configuration in the interface mode can be made on the physical port only.

Configuration Steps

⚡ Configuring egress queue guaranteed buffer

- Optional.
- In interface configuration mode, use the **mmu queue-guarantee** command to configure guaranteed buffer for each queue and ensure that the buffer configuration range varies with the product.
- Use the **no** or **default** command of this command to restore the default value of buffer.

Command	mmu queue-guarantee output { unicast multicast } [queue-id1 [queue-id2 [queue-idN]] set value
Parameter	output: performs buffer management on the egress queue
Description	unicast: performs buffer management on the egress unicast queue multicast: performs buffer management on the egress multicast queue <i>queue-id:</i> queue ID, in the range from 1 to 8 <i>value:</i> number of guaranteed buffers, in cells; range: 1-100.
Defaults	8 cells

Command	Interface configuration mode
Mode	
Usage Guide	The guaranteed buffer of all queues can not exceed the global guaranteed buffer.

↘ **Configuring egress queue shared buffer**

- Optional.
- Use the **no** or **default** command of this command to restore the default value of buffer.

Command	mmu queue-threshold output { unicast multicast } [<i>queue-id1</i> [<i>queue-id2</i> [<i>queue-idN</i>]] set { <i>thr%</i> cell value }
Parameter	output: performs buffer management on the egress queue
Description	unicast: performs buffer management on the egress unicast queue multicast: performs buffer management on the egress multicast queue <i>queue-id:</i> queue ID, in the range from 1 to 8 <i>thr%:</i> percentage, in the range from 1 to 100 <i>cell:</i> configures the queue buffer as a static threshold of cell <i>value:</i> the quantity of cells
Defaults	100%
Command	Interface configuration mode
Mode	
Usage Guide	

↘ **Configuring ingress PG guarantee buffer**

- Optional.
- Use the **no** or **default** form of the command to restore the default value of buffer.

Command	mmu pg-guarantee pg { <i>priority-id1</i> [<i>priority-id2</i> [<i>priority-idN</i>]] set value
Parameter	<i>priority-idN:</i> ingress PG ID, range: 0-7
Description	<i>Value:</i> guarantee buffer configuration value, range: 1-100.
Defaults	The default value depends on the product.
Command	Interface configuration mode
Mode	
Usage Guide	The guaranteed buffer of all PGs can not exceed the global guaranteed buffer.

↘ **Configuring ingress PG shared buffer**

- Optional.
- Use the **no** or **default** form of the command to restore the default value of buffer.

Command	mmu ingress-threshold pg [<i>pg-id0</i> [<i>pg-id1</i> [<i>pg-id N</i>]] set thr%
Parameter	<i>pg-idN:</i> priority group ID, range: 0-7.
Description	<i>thr%:</i> Total shared buffer x Threshold percentage = Maximum available buffer for the queue, range: 1-100
Defaults	100%
Command	Interface configuration mode
Mode	
Usage Guide	1. The effective way of this command varies with the product. 2. The configuration takes effect only when flow control/Priority-based Flow Control (PFC) is not enabled.

	3. The user-configured value is displayed when the show running-config command is executed, even if the user-configured value is the default value.
--	--

↘ Configuring ingress PG headroom buffer

- Optional.
- Use the **no** or **default** form of the command to restore the default value of buffer.

Command	mmu headroom-threshold pg [pg-id0 [pg-id1 [pg-id N]] set value
Parameter	pg-idN: priority group ID, range: 0-7.
Description	Value: headroom threshold value, in the unit of cell, range: 1-2000.
Defaults	The default value depends on the product.
Command Mode	Interface configuration mode
Usage Guide	<ol style="list-style-type: none"> 1. The effective way of this command varies with the product. 2. The configuration takes effect only when flow control/Priority-based Flow Control (PFC) is not enabled. 3. The user-configured value is displayed when the show running-config command is executed, even if the user-configured value is the default value.

↘ Configuring flow control threshold

- Optional.
- Use the **no** or **default** form of the command to restore the default value of buffer.

Command	mmu xoff-threshold pg [pg-id0 [pg-id1 [pg-id N]] set thr%
Parameter	pg-idN: priority group ID, range: 0-7.
Description	thr: ingress PG XOFF threshold in the form of percentage, range: 1-100
Defaults	15%
Command Mode	Interface configuration mode
Usage Guide	<ol style="list-style-type: none"> 1. The effective way of this command varies with the product. 2. The configuration takes effect only when flow control/PFC is enabled. 3. If flow control/PFC is not enabled, the shared buffer threshold of the PG is according to the value of ingress-threshold. 4. The user-configured value is displayed when the show running-config command is executed, even if the user-configured value is the default value.

↘ Configuring flow control restoration threshold

- Optional.
- Use the **no** or **default** form of the command to restore the default value of buffer.

Command	mmu xon-threshold-offset pg [pg-id0 [pg-id1 [pg-id N]] set value
Parameter	pg-idN: priority group ID, range: 0-7.
Description	Value: ingress PG XON threshold in the unit of cell, range: 1-500
Defaults	8 cells
Command Mode	Interface configuration mode

Usage Guide	<ol style="list-style-type: none"> 1. The effective way of this command varies with the product. 2. The configuration takes effect only when flow control/PFC is enabled. 3. The user-configured value is displayed when the show running-config command is executed, even if the user-configured value is the default value.
--------------------	---

↘ **Configuring global headroom threshold**

- Optional.
- Use the **no** or **default** form of the command to restore the default value of buffer.

Command	mmu pg-headroom set <i>value</i>
Parameter Description	<i>Value</i> : headroom threshold value, in the unit of cell, range: 1-20000.
Defaults	The default value depends on the product.
Command Mode	Interface configuration mode
Usage Guide	<ol style="list-style-type: none"> 1. The effective way of this command varies with the product. 2. The configuration takes effect only when flow control/PFC is enabled. 3. The user-configured value is displayed when the show running-config command is executed, even if the user-configured value is the default value.

↘ **Configuring size of global guaranteed buffer threshold**

- Optional.
- Use the **no** or **default** form of the command to restore the default value of buffer.

Command	mmu guarantee-limit set <i>value</i>
Parameter Description	<i>value</i> : limit of global guaranteed buffer, in the unit of cell.
Defaults	The default value depends on the product.
Command Mode	Global configuration mode
Usage Guide	The effective way of this command varies with the product.

↘ **Configuring size of shared service pool on the ingress/egress**

- Optional.
- Use the **no** or **default** form of the command to restore the default value of buffer.

Command	mmu {ingress egress} service-pool <i>sp-id</i> [name <i>sp-name</i>] set <i>cell</i>
Parameter Description	Ingress: configure the shared service pool on the input egress: configure the shared service pool on the output sp-id: ID of the shared service pool, range: 0-3 cell: cell quantity of the shared service pool
Defaults	By default, all shared buffer space is allocated to SP0, and the size of SP1/2/3 is 0.
Command Mode	Global configuration mode

Usage Guide	The effective way of this command varies with the product. It is recommended to set the same size for shared service pools on the input/output for the same traffic, or packet loss may occur.
--------------------	---

📌 **Configuring mapping relationship between input PG/output queue and shared service pool**

- Optional.
- Use the **no** or **default** form of the command to restore the default value of buffer.

Command	mmu {priority-group unicast-queue multicast-queue} [id1 [id2 [idN]] attach sp-id
Parameter Description	priority-group unicast-queue multicast-queue: configures the mapping relationship of input PG or output unicast/multicast queue <i>idN</i> : ID of the priority group (range: 0-7) or queue (range: 1-8) <i>sp-id</i> : ID of the shared service pool, range: 0-3
Defaults	All PG/queue is mapped to SP0.
Command Mode	Global configuration mode
Usage Guide	It is recommended to map the corresponding PG/queue to the same service pool to avoid abnormal packet loss.

Verification

- Run the **show running-config** command to check the MMU configuration
- Run the **show queue-buffer** command to check the effect.

Configuration Examples

📌 **Configuring guaranteed buffer of egress queue**

Configuration Steps	<ul style="list-style-type: none"> Configure 50 cells for the guaranteed buffer of unicast queue 1 in the interface mode. Configure 30 cells for the guaranteed buffer of multicast queue 1 in the interface mode.
	<pre> FS#config FS(config)# interface TFGigabitEthernet 0/1 FS(config-if-TFGigabitEthernet 0/1)# mmu queue-guarantee output unicast 1 set 50 FS(config-if-TFGigabitEthernet 0/1)# mmu queue-guarantee output multicast 1 set 30 FS(config-if-TFGigabitEthernet 0/1)# end FS# </pre>
Verification	<ul style="list-style-type: none"> Run the show this command
	<pre> FS(config-if-TFGigabitEthernet 0/1)#show this Building configuration... ! mmu queue-guarantee output unicast 1 set 50 mmu queue-guarantee output multicast 1 set 30 </pre>

```
!
end
FS(config-if-TFGigabitEthernet 0/1)#
```

📌 **Configuring shared buffer of egress queue**

Configuration Steps	<ul style="list-style-type: none"> ● Configure 80% of the dynamic threshold for the shared buffer of unicast queue 1 in the interface mode. ● Configure the static threshold as 50000 cells for the shared buffer of unicast queue 2 in the interface mode.
	<pre>FS#config FS(config)# interface TFGigabitEthernet 0/1 FS(config-if-TFGigabitEthernet 0/1)# mmu queue-threshold output unicast 1 set 80 FS(config-if-TFGigabitEthernet 0/1)# mmu queue-threshold output unicast 2 set cell 50000 FS(config-if-TFGigabitEthernet 0/1)# end FS#</pre>
Verification	<ul style="list-style-type: none"> ● Run the show this command
	<pre>FS(config-if-TFGigabitEthernet 0/1)#show this Building configuration... ! mmu queue-threshold output unicast 1 set 80 mmu queue-threshold output unicast 2 set cell 50000 ! end FS(config-if-TFGigabitEthernet 0/1)#</pre>

📌 **Configuring PG guaranteed buffer of ingress queue**

Configuration Steps	<ul style="list-style-type: none"> ● Configure 80 cells for the guaranteed buffer of PG 1 in the interface mode.
	<pre>FS#config FS(config)# interface TFGigabitEthernet 0/1 FS(config-if-TFGigabitEthernet 0/1)# mmu pg-guarantee pg 1 set 80 FS(config-if-TFGigabitEthernet 0/1)# end FS#</pre>
Verification	<ul style="list-style-type: none"> ● Run the show this command
	<pre>FS(config-if-TFGigabitEthernet 0/1)#show this</pre>

```
Building configuration...
!
mmu pg-guarantee pg 1 set 80
!
end
FS(config-if-TFGigabitEthernet 0/1)#
```

➤ **Configuring PG shared buffer on ingress queue**

<p>Configuration Steps</p>	<ul style="list-style-type: none"> ● Configure 80% of the dynamic threshold for the shared buffer of PG 1 in the interface mode.
	<pre>FS#config FS(config)# interface TFGigabitEthernet 0/1 FS(config-if-TFGigabitEthernet 0/1)# mmu ingress-threshold pg 1 set 80 FS(config-if-TFGigabitEthernet 0/1)# end FS#</pre>
<p>Verification</p>	<ul style="list-style-type: none"> ● Run the show this command
	<pre>FS(config-if-TFGigabitEthernet 0/1)#show this Building configuration... ! mmu ingress-threshold pg 1 set 80 ! end FS(config-if-TFGigabitEthernet 0/1)#</pre>

➤ **Configuring PG headroom buffer on ingress queue**

<p>Configuration Steps</p>	<ul style="list-style-type: none"> ● Configure 500 cells for the headroom buffer of PG 1 in the interface mode.
	<pre>FS#config FS(config)# interface TFGigabitEthernet 0/1 FS(config-if-TFGigabitEthernet 0/1)# mmu headroom-threshold pg 1 set 500 FS(config-if-TFGigabitEthernet 0/1)# end FS#</pre>
<p>Verification</p>	<ul style="list-style-type: none"> ● Run the show this command
	<pre>FS(config-if-TFGigabitEthernet 0/1)#show this</pre>

```

Building configuration...
!
mmu headroom-threshold pg 1 set 500
!
end
FS(config-if-TFGigabitEthernet 0/1)#
    
```

➤ **Configuring flow control threshold**

<p>Configuration Steps</p>	<ul style="list-style-type: none"> ● Configure 30% of the dynamic threshold for the flow control threshold of PG1 in the interface mode.
	<pre> FS#config FS(config)# interface TFGigabitEthernet 0/1 FS(config-if-TFGigabitEthernet 0/1)# mmu xoff-threshold pg 1 set 30 FS(config-if-TFGigabitEthernet 0/1)# end FS# </pre>
<p>Verification</p>	<ul style="list-style-type: none"> ● Run the show this command
	<pre> FS(config-if-TFGigabitEthernet 0/1)#show this Building configuration... ! mmu xoff-threshold pg 1 set 30 ! end FS(config-if-TFGigabitEthernet 0/1)# </pre>

➤ **Configuring flow control restoration threshold**

<p>Configuration Steps</p>	<ul style="list-style-type: none"> ● Configure 300 cells for the flow control restoration threshold of PG1 in the interface mode.
	<pre> FS#config FS(config)# interface TFGigabitEthernet 0/1 FS(config-if-TFGigabitEthernet 0/1)# mmu xon-threshold-offset pg 1 set 300 FS(config-if-TFGigabitEthernet 0/1)# end FS# </pre>
<p>Verification</p>	<ul style="list-style-type: none"> ● Run the show this command

```

FS(config-if-TFGigabitEthernet 0/1)#show this

Building configuration...

!
mmu xon-threshold-offset pg 1 set 300
!
end
FS(config-if-TFGigabitEthernet 0/1)#
    
```

↘ **Configuring headroom threshold**

Configuration Steps	<ul style="list-style-type: none"> ● Configure 10000 cells for the headroom threshold in the global configuration mode.
	<pre> FS#config FS(config)# mmu pg-headroom set 10000 FS(config)# exit FS# </pre>
Verification	<ul style="list-style-type: none"> ● Run the show running-config command
	<pre> FS#show running-config include mmu mmu pg-headroom set 10000 FS# </pre>

↘ **Configuring global guaranteed buffer threshold**

Configuration Steps	<ul style="list-style-type: none"> ● Configure 10000 cells for the global guaranteed buffer in the global configuration mode
	<pre> FS#config FS(config)# mmu guarantee-limit set 10000 FS(config)#exit FS# </pre>
Verification	<ul style="list-style-type: none"> ● Run the show running-config command to check the configuration.
	<pre> FS# show run running-config include mmu mmu guarantee-limit set 10000 FS# </pre>

↘ **Configuring size of shared service pool on the input/output**

Configuration	<ul style="list-style-type: none"> ● In the global configuration mode, configure the size of input and output SP1 as 10000 cells.
----------------------	--

Steps	
	<pre>FS# configure FS(config)# mmu ingress service-pool 1 set 10000 FS(config)# mmu egress service-pool 1 set 10000</pre>
Verification	<ul style="list-style-type: none"> ● Run the show running-config command to check the configuration.
	<pre>FS#show run mmu ingress service-pool 1 set 10000 mmu egress service-pool 1 set 10000 FS#</pre>

↘ **Configuring mapping relationship between input PG/output queue and shared service pool**

Configuration Steps	<ul style="list-style-type: none"> ● Configure 10000 cells for the SP1 on the ingress/egress directions in the global configuration mode ● Map ingress PG1 to ingress SP1, and map egress unicast/multicast queue 1 to the egress SP1 in the global configuration mode
	<pre>FS# configure FS(config)# mmu ingress service-pool 1 set 10000 FS(config)# mmu egress service-pool 1 set 10000 FS(config)# mmu priority-group 1 attach service-pool 1 FS(config)# mmu unicast-queue 1 attach service-pool 1 FS(config)# mmu multicast-queue 1 attach service-pool 1 FS(config)#exit FS#</pre>
Verification	<ul style="list-style-type: none"> ● Run the show running-config command to check the configuration.
	<pre>FS#show running-config include mmu mmu ingress service-pool 1 set 10000 mmu egress service-pool 1 set 10000 mmu priority-group 1 attach service-pool 1 mmu unicast-queue 1 attach service-pool 1 mmu multicast-queue 1 attach service-pool 1 FS#</pre>

3.5.2Configuring Buffer Monitoring

Configuration Effect

- Configure the buffer utilization alarm threshold of port group. The log alarm will be printed when the buffer utilization of port group exceeds this configured value.
- Configure the buffer utilization alarm threshold of queue. The log alarm will be printed when the buffer utilization of queue exceeds this configured value.
- Configure the monitoring data sampling interval. The bottom layer samples and reports data according to the configured interval.

- Configure the numbering mode of slice ID starting from 1 or 0

Notes

- Configuration on the interface can be made on the physical port only.

Configuration Steps

➤ **Configuring the port group buffer utilization alarm threshold**

- Optional.
- In global configuration mode, use the **mmu usage-warn-limit** command to configure the buffer utilization alarm threshold for the port group.
- Use the **no** or **default** command of this command to restore the default setting.

Command	mmu usage-warn-limit set value
Parameter	<i>value</i> : percentage, range: 1-100
Description	
Defaults	The default value is 0, indicating that no alarm is reported.
Command Mode	Global configuration mode
Usage Guide	This configuration takes effect for all the port groups.

➤ **Configuring the service pool buffer utilization alarm threshold**

- Optional.
- In the interface configuration mode, use the **mmu usage-warn-limit {ingress-service-pool | egress-service-pool}** command to configure the buffer utilization alarm threshold for service pool.
- Use the **no** or **default** command of this command to restore the default settings.

Command	mmu usage-warn-limit {ingress-service-pool egress-service-pool} sp-id set value
Parameter	ingress-service-pool : ingress shared service pool
Description	egress-service-pool : egress shared service pool <i>sp-id</i> : ID of shared pool <i>value</i> : percentage, range: 1-100
Defaults	The default value is 0, indicating that no alarm is reported.
Command Mode	Global configuration mode
Usage Guide	N/A

➤ **Configuring the priority group/queue buffer utilization alarm threshold**

- Optional.
- In the interface configuration mode, use the **mmu usage-warn-limit {pg-headroom | priority-group [unicast | multicast] [id1 [id2 [idN]]] set value** command to configure the buffer utilization alarm threshold for each priority group or queue.
- Use the **no** or **default** command of this command to restore the default settings.

Command	mmu usage-warn-limit { pg-headroom priority-group [unicast multicast] [id1 [id2 [idN]]] set value
Parameter	priority-group : priority group

Description	<p>pg-headroom: priority group headroom</p> <p>unicast: performs buffer management on the egress unicast queue</p> <p>multicast: performs buffer management on the egress multicast queue</p> <p><i>idN:</i> priority group/queue ID</p> <p><i>value:</i> percentage, range: 1-100</p>
Defaults	The default value is 0, indicating that no alarm is reported.
Command	Interface configuration mode
Mode	
Usage Guide	N/A

↘ **Configuring the monitoring data sampling interval**

- Optional.
- In global configuration mode, use the **mmu sample-period { buffer-counter | queue-counter } value** command to configure the monitoring data sampling interval for each queue.
- Use the **no** or **default** form of the command to restore the default setting.

Command	mmu sample-period { buffer-counter queue-counter } value
Parameter	buffer-counter: count of occupied buffer
Description	<p>queue-counter: count of sent and discarded records in a queue</p> <p><i>value:</i> sampling interval in the unit of seconds, range: 1-10</p>
Defaults	The sampling interval is 5 seconds by default.
Command	Global configuration mode
Mode	
Usage Guide	N/A

Verification

- Use the **show running-config** command to check whether the MMU under the corresponding interface is configured successfully.
- Use the **show queue-buffer** command to check whether the configuration succeeds.

↘ **Configuring the numbering mode of slice ID**

- Optional.
- In global configuration mode, use the **mmu slice-id compatible** command to configure the numbering mode of slice ID and switch the numbering mode of CLI/MIB.
- Use the **no** or **default** form of the command to restore the default setting.

Command	mmu slice-id compatible
Parameter	
Description	
Defaults	By default, the number of slice ID starts from 1; run the command to start ID from 0.
Command	Global configuration mode
Mode	
Usage Guide	N/A

Verification

- Run the **show run** command to display the current numbering mode.
- Run the **show queue-buffer** command to display the range of current numbering mode.

Configuration Examples

▾ **Configuring the buffer utilization alarm limit based on port group**

Configuration Steps	<ul style="list-style-type: none"> ● On the switch, configure the buffer utilization alarm threshold of port group as 80%.
	<pre>FS# configure terminal FS(config)# mmu usage-warn-limit set 80 FS(config)#</pre>
Verification	<ul style="list-style-type: none"> ● Check whether the buffer utilization alarm threshold has been configured successfully.
	<pre>FS# show run running-config include mmu mmu usage-warn-limit set 80</pre>

▾ **Configuring the buffer utilization alarm limit based on egress queue**

Configuration Steps	<ul style="list-style-type: none"> ● Configure the buffer utilization alarm threshold as 70% at the unicast queues 6 and 8 of port 1/1 on the switch.
	<pre>FS# configure terminal FS(config)# int te1 interface TFGigabitEthernet 0/1 FS(config-if-TFGigabitEthernet 0/1)#mmu usage-warn-limit unicast 6 8 set 70</pre>
Verification	<ul style="list-style-type: none"> ● Check whether the buffer utilization alarm threshold has been configured successfully.
	<pre>FS# configure terminal FS(config)# interface TFGigabitEthernet 0/1 FS(config-if-TFGigabitEthernet 0/1)#show this Building configuration... ! mmu usage-warn-limit unicast 6 set 70 mmu usage-warn-limit unicast 8 set 70 ! end FS(config-if-TFGigabitEthernet 0/1)# show queue-buffer interface TFGigabitEthernet 0/1 Interface TFGigabitEthernet 0/1: Slice 1: Type Queue Used cells Available cells Usage Usage warn limit Usage warn count Peaked cells Service pool Unicast 1 0 97849 0% 0% 0 0 0(SP-0) Unicast 2 0 97849 0% 0% 0 0</pre>

0(SP-0)								
Unicast	3	0	97849	0%	0%	0	0	
0(SP-0)								
Unicast	4	0	97849	0%	0%	0	0	
0(SP-0)								
Unicast	5	0	97849	0%	0%	0	0	
0(SP-0)								
Unicast	6	0	97849	0%	70%	0	0	
0(SP-0)								
Unicast	7	0	97849	0%	0%	0	0	
0(SP-0)								
Unicast	8	0	97849	0%	70%	0	0	
0(SP-0)								
Multicast	1	0	12238	0%	0%	0	0	
0(SP-0)								
Multicast	2	0	12238	0%	0%	0	0	
0(SP-0)								
Multicast	3	0	12238	0%	0%	0	0	
0(SP-0)								
Multicast	4	0	12238	0%	0%	0	0	
0(SP-0)								
Multicast	5	0	12238	0%	0%	0	0	
0(SP-0)								
Multicast	6	0	12238	0%	0%	0	0	
0(SP-0)								
Multicast	7	0	12238	0%	0%	0	0	
0(SP-0)								
Multicast	8	0	12238	0%	0%	0	0	
0(SP-0)								
Service pool	Global shared cells		Usage	Usage warn limit	Usage warn count	Used cells	Peaked cells	
0(SP-0)	110072		0%	0%	0	0	0	
1(SP-1)	0		0%	0%	0	0	0	
2(SP-2)	0		0%	0%	0	0	0	
3(SP-3)	0		0%	0%	0	0	0	
Slot	Slice	PortGroup	Total cells	Total usage	Usage warn limit	Static used cells	Global shared cells	
Available shared cells								
0	1	1	131072	0%	100%	0	110072	
110072								

📌 **Configuring the monitoring data sampling interval**

- | | |
|----------------------|---|
| Configuration | <ul style="list-style-type: none"> Configure the monitoring data sampling interval in global configuration mode. |
|----------------------|---|

Steps	<pre>FS# configure terminal FS(config)# mmu sample-period buffer-counter 8 FS(config)# mmu sample-period queue-counter 10</pre>
Verification	<ul style="list-style-type: none"> ● Check whether the sampling interval has been configured successfully. <pre>FS# show running-config include mmu mmu sample-period buffer-counter 8 mmu sample-period queue-counter 10</pre>

↘ **Configuring the shared buffer pool buffer utilization alarm limit**

Configuration Steps	<ul style="list-style-type: none"> ● Configure the alarm limit in global configuration mode.
	<pre>FS# configure terminal FS(config)# mmu usage-warn-limit ingress-service-pool 1 set 10 FS(config)# mmu usage-warn-limit egress-service-pool 2 set 20</pre>
Verification	<ul style="list-style-type: none"> ● Check whether the alarm limit has been configured successfully. <pre>FS# show run running-config include mmu mmu usage-warn-limit ingress-service-pool 1 set 10 mmu usage-warn-limit egress-service-pool 2 set 20</pre>

↘ **Configuring the numbering mode of slice ID**

Configuration Steps	<ul style="list-style-type: none"> ● Configure in global configuration mode.
	<pre>FS# configure terminal FS(config)# mmu slice-id compatible</pre>
Verification	<ul style="list-style-type: none"> ● Check whether the numbering mode has been configured successfully. <pre>FS# show running-config include mmu mmu slice-id compatible FS# sh queue-buffer in hu0/1 Interface HundredGigabitEthernet 0/1: Slice 0: Type Queue Used cells Available cells Usage Usage warn limit Usage warn count Peaked cells Service pool Unicast 1 0 35481 0% 0% 0 0 0(SP-0) Unicast 2 0 35481 0% 0% 0 0 0(SP-0) Unicast 3 0 35481 0% 0% 0 0 0(SP-0) Unicast 4 0 35481 0% 0% 0 0 0(SP-0) Unicast 5 0 35481 0% 0% 0 0</pre>

0(SP-0)							
Unicast 6 0 35481 0% 0% 0 0							
0(SP-0)							
Unicast 7 0 35481 0% 0% 0 0							
0(SP-0)							
Unicast 8 0 35481 0% 0% 0 0							
0(SP-0)							
Multicast 1 0 4442 0% 0% 0 0							
0(SP-0)							
Multicast 2 0 4442 0% 0% 0 0							
0(SP-0)							
Multicast 3 0 4442 0% 0% 0 0							
0(SP-0)							
Multicast 4 0 4442 0% 0% 0 0							
0(SP-0)							
Multicast 5 0 4442 0% 0% 0 0							
0(SP-0)							
Multicast 6 0 4442 0% 0% 0 0							
0(SP-0)							
Multicast 7 0 4442 0% 0% 0 0							
0(SP-0)							
Multicast 8 0 4442 0% 0% 0 0							
0(SP-0)							
Service pool	Global shared cells	Usage	Usage warn limit	Usage warn count	Used cells	Peaked cells	
0(SP-0)	39908	0%	0%	0	0	1537	
1(SP-1)	0	0%	0%	0	0	0	
2(SP-2)	0	0%	0%	0	0	0	
3(SP-3)	0	0%	0%	0	0	0	
Slice 2:							
Type	Queue	Used cells	Available cells	Usage	Usage warn limit	Usage warn count	Peaked cells
Service pool							
Unicast 1 0 35481 0% 0% 0 0							
0(SP-0)							
Unicast 2 0 35481 0% 0% 0 0							
0(SP-0)							
Unicast 3 0 35481 0% 0% 0 0							
0(SP-0)							
Unicast 4 0 35481 0% 0% 0 0							
0(SP-0)							
Unicast 5 0 35481 0% 0% 0 0							
0(SP-0)							
Unicast 6 0 35481 0% 0% 0 0							
0(SP-0)							

Unicast	7	0	35481	0%	0%	0	0	
0(SP-0)								
Unicast	8	0	35481	0%	0%	0	0	
0(SP-0)								
Multicast	1	0	4442	0%	0%	0	0	
0(SP-0)								
Multicast	2	0	4442	0%	0%	0	0	
0(SP-0)								
Multicast	3	0	4442	0%	0%	0	0	
0(SP-0)								
Multicast	4	0	4442	0%	0%	0	0	
0(SP-0)								
Multicast	5	0	4442	0%	0%	0	0	
0(SP-0)								
Multicast	6	0	4442	0%	0%	0	0	
0(SP-0)								
Multicast	7	0	4442	0%	0%	0	0	
0(SP-0)								
Multicast	8	0	4442	0%	0%	0	0	
0(SP-0)								
Service pool	Global shared cells		Usage	Usage warn limit	Usage warn count	Used cells	Peaked cells	
0(SP-0)	39908		0%	0%	0	0	0	
1(SP-1)	0		0%	0%	0	0	0	
2(SP-2)	0		0%	0%	0	0	0	
3(SP-3)	0		0%	0%	0	0	0	
Slot	Slice	PortGroup	Total cells	Total usage	Usage warn limit	Static used cells	Global shared cells	Available shared cells
0	0	1	53248	0%	20%	0	39908	39908
0	1	1	53248	0%	20%	0	39908	39908
0	2	1	53248	0%	20%	0	39908	39908
0	3	1	53248	0%	20%	0	39908	39908

3.5.3 Configuring the Queue Packet Loss Detection

Configuration Effect

- Enable/Disable the global queue packet loss alarm of all interface queues.
- Enable/Disable the queue packet loss alarm on an interface. The priority of this configuration is higher than the global configuration.
- Configure the packet loss alarm frequency so that only *N* packet loss alarms are displayed in the period of *T*.

Notes

- This function can be configured in global configuration mode and interface configuration mode.

Configuration Steps

↘ **Configuring the packet loss alarm**

- Optional.
- In global or interface configuration mode, run the **mmu queue-loss-warn {unicast | multicast} [qid1 [qid2 [qidN]]] {on | off}** command to enable/disable the packet loss alarm function on queues.
- Use the **no** or **default** form of this command to restore default configuration. The packet loss alarm function is disabled by default.

Command	[no] mmu queue-loss-warn {unicast multicast } [qid1 [qid2 [qidN]]] {on off}
Parameter Description	<p>unicast: Indicates a unicast queue.</p> <p>multicast: Indicates a multicast queue.</p> <p><i>qid:</i> Indicates the queue ID, range: 1-8.</p> <p>on: Enables the packet loss alarm.</p> <p>off: Disables the packet loss alarm.</p>
Defaults	The packet loss alarm function is disabled by default.
Command Mode	Global configuration mode and interface configuration mode.
Usage Guide	The priority of interface configuration is higher than the global configuration.

↘ **Configuring the Packet Loss Alarm Frequency**

- Optional.
- In global configuration mode, run the **mmu queue-loss-warn frequency cycle value1 times value2** command to configure the packet loss alarm frequency.
- Use the **no** or **default** form of the command to restore the default configuration.

Command	[no] mmu queue-loss-warn frequency cycle value1 times value2
Parameter Description	<p><i>value1:</i> Indicates the displaying period of the packet loss alarm.</p> <p><i>value2:</i> Indicates the number of packet loss alarms that can be displayed in a period.</p>
Defaults	Up to 30 packet loss alarms can be displayed within 60s by default.
Command Mode	Global configuration mode
Usage Guide	

Verification

- Use the **show running-config** command to check whether the configuration takes effect.

Configuration Examples

↘ **Configuring the queue packet loss alarm**

Configuration	<ul style="list-style-type: none"> ● Enable the packet loss alarm for the unicast queue 5 in the global configuration mode.
----------------------	--

Steps	<ul style="list-style-type: none"> ● Enable the packet loss alarm for the unicast queue 7 in the interface configuration mode.
	<pre>FS# configure terminal FS(config)#mmu queue-loss-warn unicast 5 on FS(config)#interface TFGigabitEthernet 0/1 FS(config-if-TFGigabitEthernet 0/1)#mmu queue-loss-warn unicast 7 on</pre>
Verification	<ul style="list-style-type: none"> ● Check whether the alarm is enabled.
	<pre>FS# show running-config ... mmu queue-loss-warn unicast 5 on ... FS#show running-config interface TFGigabitEthernet 0/1 Building configuration... Current configuration : 68 bytes interface TFGigabitEthernet 0/1 mmu queue-loss-warn unicast 7 on FS#</pre>

📌 **Configuring the frequency of queue packet loss alarm**

Configuration Steps	<ul style="list-style-type: none"> ● Configure at most 100 alarm syslogs can be printed during 100s in the global configuration mode.
	<pre>FS# configure terminal FS(config)# mmu queue-loss-warn frequency cycle 100 times 100 FS(config)#</pre>
Verification	<ul style="list-style-type: none"> ● Check whether the frequency is configured.
	<pre>FS# show running-config include mmu mmu queue-loss-warn frequency cycle 100 times 100</pre>

3.5.4Configuring the Cut-through Mode

Configuration Effect

- Enable the cut-through function to reduce the packet forwarding delay.

Notes

- The cut-through function can be configured only on physical ports.

Configuration Steps

➤ Configuring cut-through mode

- Optional.
- In interface configuration mode, run the **mmu cut-through** command to enable the cut-through function on the interface.
- Use the **no** or **default** form of the command to restore the default setting.

Command	mmu cut-through
Parameter	N/A
Description	
Defaults	The cut-through mode is disabled by default.
Command Mode	Interface configuration mode
Usage Guide	The mode can not take effect in the case of interface congestion.

Verification

- Use the **show running-config** command to check whether the configuration takes effect.

Configuration Examples

➤ Configuring the cut-through mode

Configuration Steps	<ul style="list-style-type: none"> ● Enable the cut-through mode in the global configuration mode.
	<pre>FS# configure terminal FS(config)#mmu cut-through</pre>
Verification	<ul style="list-style-type: none"> ● Check whether the cut-through mode is configured.
	<pre>FS# show running-config include mmu mmu cut-through</pre>

3.5.5Configuring MMU-HA

Configuration Effect

- Disable the MMU-HA function
- Disable the MMU-HA reset function but keep the MMU buffer crash detection

Notes

- This function can be configured on the physical port in global configuration mode.

Configuration Steps

➤ Disabling MMU-HA

- Optional.
- In global configuration mode, run the **mmu ha disable** command to disable the function.

- Use the **no** or **default** form of this command to restore default configuration.

Command	mmu ha disable
Parameter Description	
Defaults	The MMU-HA function is enabled by default.
Command Mode	Global configuration mode
Usage Guide	

↘ **Disabling MMU-HA reset function**

- Optional
- In the global configuration mode, use the **mmu ha reset disable** command to disable MMU-HA reset function
- Use the **no** form of this command to restore the default settings

Command	mmu ha reset disable
Parameter Description	N/A
Defaults	MMU-HA reset is enabled by default.
Command Mode	Global configuration mode
Usage Guide	N/A

Verification

- Use the **show running-config** command to check whether the configuration takes effect.

Configuration Examples

↘ **Disabling MMU-HA function**

Configuration Steps	<ul style="list-style-type: none"> ● Configure in the global configuration mode. <pre>FS# configure terminal FS(config)# mmu ha disable</pre>
Verification	<ul style="list-style-type: none"> ● Check whether the configuration takes effect. <pre>FS# show running-config mmu ha disable</pre>

↘ **Disabling MMU-HA reset function**

Configuration Steps	<ul style="list-style-type: none"> ● Configure in the global configuration mode. <pre>FS# configure terminal FS(config)# mmu ha reset disable</pre>
----------------------------	--

Verification	<ul style="list-style-type: none"> ● Check whether the configuration takes effect.
	<pre>FS# show running-config include mmu mmu ha reset disable</pre>

3.5.6 Configuring MMU-TCB

Configuration Effect

- Enable MMU-TCB to monitor the TCP/UDP packet loss of the unicast queue. When the packet loss occurs, the five-element tuple of packet will be collected and reported to the GRPC server.

Notes

- This function can be configured in global configuration mode.

Configuration Steps

↘ Configuring the packet loss monitoring

- Optional.
- In global configuration mode, run the **mmu tcb-enable** command to enable/disable the packet loss monitoring function.
- Use the **no** or **default** form of this command to restore default configuration. The packet loss monitoring function is disabled by default.

Command	[no] mmu tcb-enable
Parameter Description	
Defaults	The packet loss monitoring function is disabled by default.
Command Mode	Global configuration mode
Usage Guide	Only devices using TD3/TH2 support this function. The monitoring data collected by TCB is reported to the server by GRPC.

Verification

- Use the **show running-config** command to check whether the configuration takes effect.

Configuration Examples

↘ Enabling MMU-TCB function

Configuration Steps	<ul style="list-style-type: none"> ● Configure in the global configuration mode.
	<pre>FS# configure terminal FS(config)# mmu tcb-enable</pre>
Verification	<ul style="list-style-type: none"> ● Check whether the configuration takes effect.
	FS# show running-config

mmu tcb-enable

3.6 Monitoring

Clearing



Running the **clear** command during operation of the equipment may lead to service interruption due to loss of important information.

Description	Command
Clears the queue counter value.	clear queue-counter
Clears the historical peak value of the egress queue buffer	clear mmu queue-buffer peaked
Clears the historical peak value of the ingress PG buffer	clear mmu pg-buffer peaked
Clears the number of times that the occupied buffer exceeds the warning threshold	clear mmu usage-warn-count

Displaying

Description	Command
Displays the buffer use information of panel interface.	show queue-buffer interface
Displays the queue counter information of panel interface.	show queue-counter interface
Displays the buffer use information of the ingress PG	show pg-buffer interface

Reliability Configuration

1. Configuring REUP
2. Configuring RLDP
3. Configuring DLDP
4. Configuring VRRP
5. Configuring VRRP Plus
6. Configuring BFD
7. Configuring IP Event Dampening
8. Configuring VSU
9. Configuring RNS
10. Configuring PCAP
11. Configuring HAM
12. Configuring VAP

1 Configuring REUP

1.1 Overview

The Rapid Ethernet Uplink Protection Protocol (REUP) provides a rapid uplink protection function.

In the dual uplink networking, REUP is used to ensure normal communication between links, block redundant links, avoid link loops, and implement fast backup.

The upstream interfaces of REUP are configured in pairs. If both interfaces are normal, an interface works in the backup state. The interface in the backup state does not forward data packets. When the interface in the forward state is faulty, the backup interface switches to the forward state immediately, and provides data transmission. In addition, REUP also sends address update packets to upstream devices so that the upstream devices can update their MAC addresses immediately. This function of REUP ensures that layer-2 data streams can be restored within 50 ms after a link is faulty.

REUP is mutually exclusive with the Spanning Tree Protocol (STP) based on interfaces. In this case, a device runs STP downward and runs REUP upward to implement backup and fault protection for the upstream link. REUP ensures that basic link redundancy is provided when STP is disabled and that millisecond-level fault recovery faster than STP is also provided.

Protocols and Standards

- REUP is a proprietary protocol of FS Network, and there is no standard and protocol for reference.

1.2 Applications

Application	Description
Communication in Dual Uplink Networking	Forward packets in the dual-uplink networking.

1.2.1 Communication in Dual Uplink Networking

Scenario

For communication in dual uplink networking, the access switch has two uplink paths, as shown in Figure 1-1.

Figure 1-1 Dual uplink networking

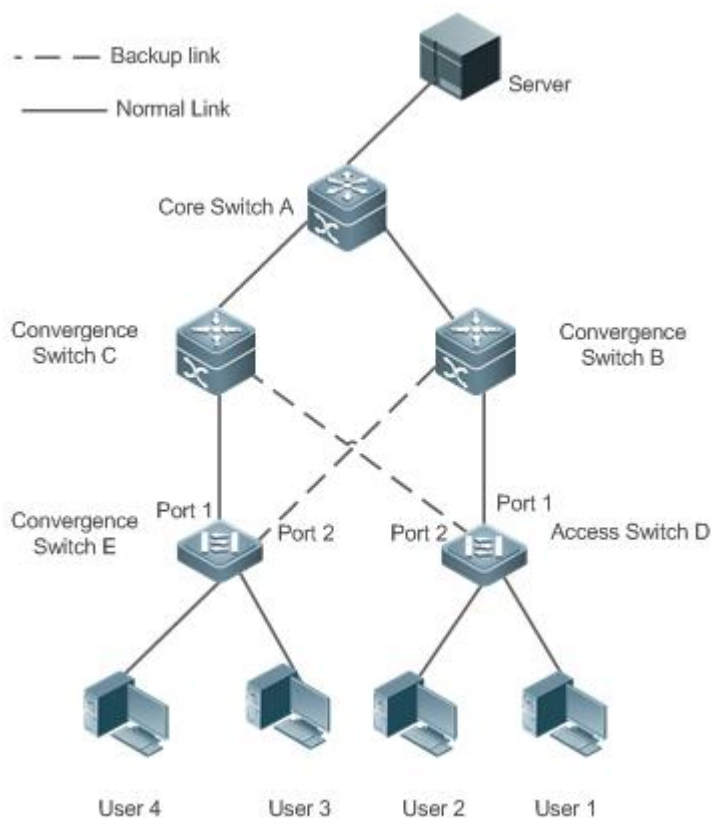

Deployment

- Enable REUP on interface1 and interface2 of the access switch D/E to implement fast switching when a link is faulty.
- Enable MAC address update message receiving of REUP on the interfaces connected to switches A/B/C to rapidly clear the MAC addresses on the interfaces when a link is faulty.

1.3 Features

Basic Concepts

➤ **REUP Pair**

Specify an interface as the backup interface of another interface to configure an REUP pair. One interface is the active interface and the other interface is the backup interface. When the two interfaces are normal, an interface is configured as the forward interface whereas the other interface is configured as the backup interface. You can determine the interface to be configured as the backup interface. See the related information in the section "Configuring the Preemption Mode and Delay Time of REUP".

➤ **MAC Address Update Message**

MAC address update messages refer to FLUSH packets sent by FS Network to uplink devices through private multicast. When an uplink device of FS Network enables the function for receiving MAC address update messages and receives MAC address update messages, the device updates the MAC addresses of corresponding interfaces.

➤ **MAC Address Update Group**

Multiple interfaces are added to a group. If one interface in the group receives a MAC address update message, the MAC addresses of other interfaces in the group will be updated. In this case, the group is called MAC address update group.

➤ **MAC Address Update Packet**

Packets sent to update MAC addresses in order to support uplink devices are called MAC address update packets.

➤ **Link Tracking Group**

The uplink and downstream interfaces of a device are added to a group. If all upstream interfaces in the group are down, all downstream interfaces in this group are forced down. In this case, this group is called a link tracing group.

Overview

Feature	Description
Dual Link Backup of REUP	When a link is faulty, the other link can rapidly switch to the forward state.
Preemption Mode and Delay Time of REUP	When both links are normal, the preemption mode can be used to determine the link that is used for forwarding data and the delay time that is used to determine the waiting time before switching.
MAC Address Update	During link switching, the MAC address of an interface is updated to make packet convergence faster.
VLAN Load Balance	When the two links are normal, the utilization of link bandwidth can be maximized.
Link State Tracking	When the upstream link is faulty, the downstream link is switched.

1.3.1 Dual Link Backup of REUP

When an active link is faulty, the link in the backup state will rapidly switch to the forward state and start forwarding data, minimizing the service interruption caused by link failure.

Working Principle

Specify an interface as the backup interface of another interface to configure an REUP pair. When the two interfaces are normal, a link is in the forward state (forwarding data packets) and the other link is in the backup state (not forwarding data). When the active link is faulty, the link in the backup state rapidly switches to the forward state and starts forwarding data. When the faulty link is recovered, the link enters the backup state and does not forward data packets. Of course, you can configure the preemption mode to specify whether a link recovered from failure preempts the link that is in the forward state currently.

Figure 1-2 A topology with two normal links

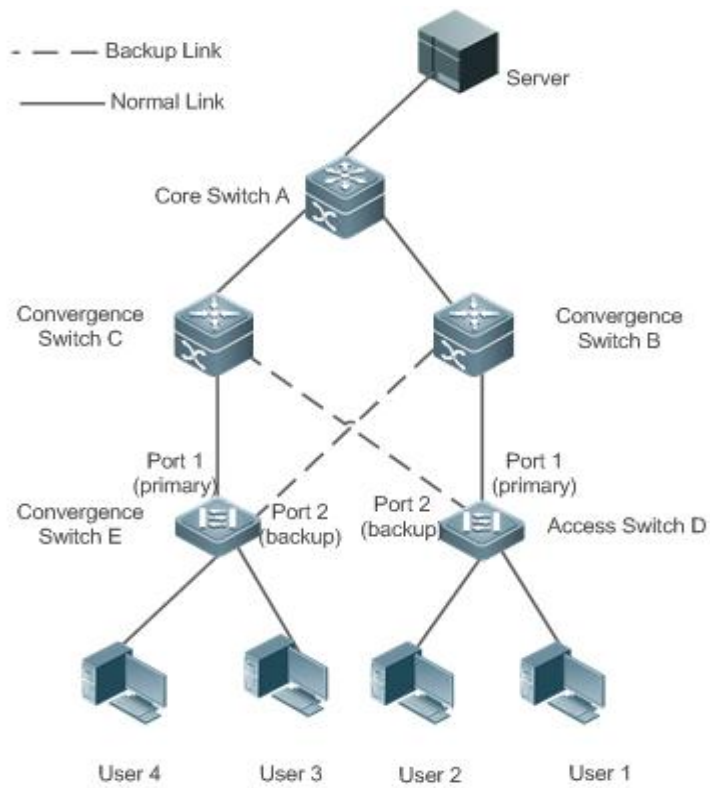

As shown in Figure 1-2, connect interfaces 1 and 2 of switch D (E) to the uplink switches B and C (C and B) and configure REUP on interfaces 1 and 2. When the links are normal, interface 1 is in the forward state and forwards data packets and interface 2 is in the backup state and does not forward data packets.

Figure 1-3 A topology with interface 1 of switch D (E) faulty

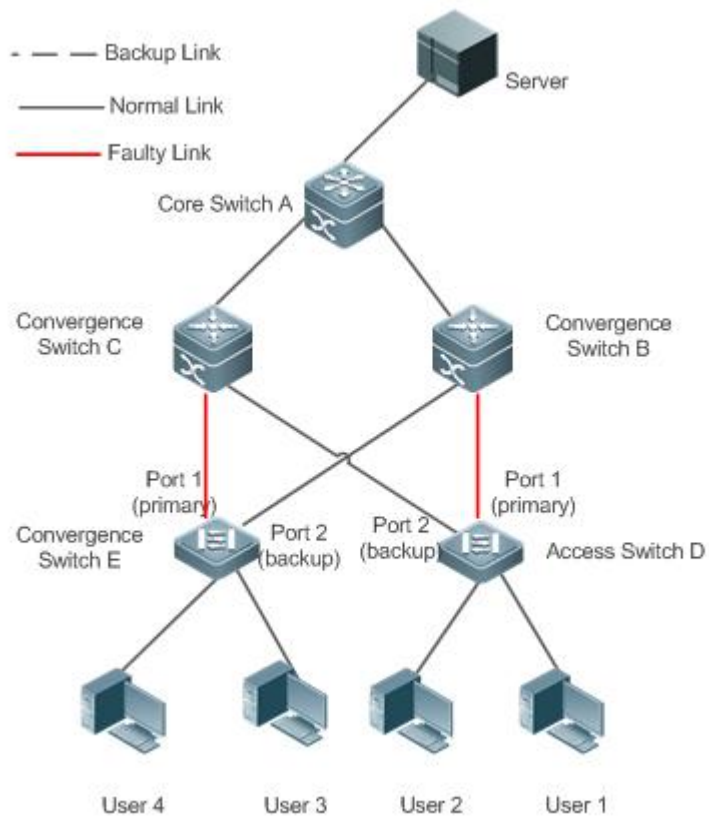

Once interface 1 is faulty, interface 2 immediately starts forwarding data packets and recovers the uplink transmission of the switch. In the non-preemption mode, when the link of interface 1 is recovered, interface 1 is in the backup state and does not forward data packets whereas interface 2 continues forwarding data packets.

Related Configuration

📌 Enabling Dual Link Backup on an interface

By default, dual link backup on an interface is disabled.

You can run the **switchport backup interface** command to configure a layer-2 physical interface (or layer-2 AP interface) as a backup interface and enable the dual link backup function of REUP.

You must enable the dual link backup function of REUP on an interface. The function involves the link switching of REUP only when an interface is faulty.

- ❗ REUP, ERPS, and RERP do not share interfaces.
- ❗ Devices enabled with REUP must disable the storm control function of all layer-2 interfaces.

1.3.2Preemption Mode and Delay Time of REUP

Working Principle

You can determine which link should be used first by configuring the preemption mode of REUP. If the preemption mode is set to bandwidth first, REUP selects a link with a high bandwidth first. You can also set the preemption mode to forced to select a stable and reliable link first forcibly.

To avoid frequent active/backup link switching caused by abnormal faults, REUP provides a preemption delay function. When the two links are recovered, link switching is performed when the faulty link becomes stable after a delay (35s by default).

Related Configuration

📄 Configuring the Preemption Mode and Delay Time of REUP

By default, the preemption mode is disabled and the delay time is 35s.

You can run the **switchport backup interface preemption mode** command to configure the preemption mode.

You can run the **switchport backup interface preemption delay** command to configure the delay time.

A smaller delay means more frequent preemption switching after the faulty link is recovered.

- i REUP uses the value of the **Bandwidth** attribute for an AP interface as the actual bandwidth of the AP interface, which is equal to the value of the **Speed** attribute (the number of link up member interfaces x the number of member interfaces).
- i When an uplink enables STP, the preemption delay time of REUP is greater than 35s.

1.3.3 MAC Address Update

During link switching, the MAC address of an interface is updated to make packet convergence faster.

Working Principle

As shown in Figure 1-2, interface 1 and interface 2 of switch D (E) are enabled with dual link backup of REUP. Interface 1 works as the active interface. During normal communication, switch A learns the MAC addresses of users 1 and 2 (users 3 and 4) from the interfaces connecting to switch B (C).

When interface 1 of switch D (E) is faulty, interface 2 rapidly switches to the forward state and starts forwarding data packets. In this case, switch A does not learn the MAC addresses of users 1 and 2 (users 3 and 4) on the interfaces connecting to switch B (C). The data packets sent by the server to users 1 and 2 (users 3 and 4) are forwarded to switch C (B) by switch A, causing that the packets from the server to users 1 and 2 (users 3 and 4) are lost.

To avoid the preceding problems, you can enable the MAC address update function on switch D (E). When interface 2 starts forwarding packets, switch D (E) sends a MAC address update message to interface 2. After receiving the MAC address update message, switch A updates the MAC address on the interface of switch A. In this way, switch A forwards the packets sent by the server to the users to the interfaces of switch B (C) to make packet convergence faster.

In addition, import the setting of a MAC address update group, that is, classify multiple interfaces into the same group. When an interface in this group receives a MAC address update message, the MAC addresses on other interfaces in the group are updated to reduce the side effect of flooding caused by MAC address update.

To be compatible with upstream devices not supporting MAC address update messages, switch D (E) will send MAC address update packets for users 1 and 2 (users 3 and 4) upward when interface 2

switches to the forward state. In this way, switch A can update the MAC addresses of users 1 and 2 (users 3 and 4) to the corresponding interfaces and recover the downlink data transmission of switch A.

Related Configuration

↳ Enabling Sending of MAC Address Update Messages on an interface

By default, sending of MAC address update messages is disabled on an interface.

You can run the **mac-address-table move update transit** command to enable sending of MAC address updates on all interfaces of a device.

If sending of MAC address update messages is not enabled, MAC address update messages will not be sent when dual link backup switching of REUP is performed.

↳ Enabling Receiving of MAC Address Update Messages on an interface

By default, receiving of MAC address update messages is disabled on an interface.

You can run the **mac-address-table move update receive** command to enable receiving of MAC address updates on all interfaces of a device.

If receiving of MAC address update messages is not enabled, a device cannot receive MAC address update messages from downlink devices during dual link backup switching of REUP and will not update the MAC addresses.

↳ Configuring a VLAN for Sending MAC Address Update Messages

By default, a VLAN for sending MAC address update messages is the default VLAN to which an interface belongs.

You can run the **mac-address-table move update transit vlan** command to configure the VLAN in which interfaces send MAC address update messages.

If the VLAN in which interfaces send MAC address update messages is configured, the messages are sent in the configured VLAN; otherwise, the messages are sent in the default VLAN to which the interface belongs.

↳ Configuring a VLAN for Receiving MAC Address Update Messages

By default, MAC address update messages are received in all VLANs.

You can run the **no mac-address-table move update receive vlan** command to configure a VLAN in which interfaces do not receive MAC address update messages. MAC address update messages are received in remaining VLANs.

If no VLAN in which interfaces receive MAC address update messages is configured, MAC address update messages are received in all the configured VLANs; otherwise, MAC address update messages are received in the remaining VLANs.

↳ Configuring a MAC Address Update Group

By default, there is no MAC address update group.

You can run the **mac-address-table update group** command to add an interface to the MAC address update group. The interface is added to the first update group by default.

If no MAC address update group is configured, MAC address update will not be performed when MAC address update packets are received.

▾ **Configuring the Maximum Number of MAC Address Update Packets Sent Per Second**

By default, the maximum number of MAC address update packets sent per second is 150.

You can run the **mac-address-table move updatemax-update-rate** command to configure the maximum number of MAC address update packets sent per second.

The larger the number of packets, the more CPU time used for sending the packets, and the fewer downlink packets are lost.

1.3.4VLAN Load Balance

Working Principle

The VLAN load balance function allows REUP to forward data packets of mutually exclusive VLANs for two interfaces to make full use of the link bandwidth.

As shown in Figure 1-4, configure dual link backup of REUP and enable VLAN load balance of REUP on interface 1 and interface 2 of switch D, and map VLAN 1 to instance 1 and VLAN 2 to instance 2. Data of VLAN 1 (instance 1) is transmitted through interface 1 and all the other data of VLAN 2 (instance 2) is transmitted through interface 2. Perform the same processing on switch E.

When an interface is faulty, the other interface takes over the transmission of all VLANs. When the faulty interface is recovered and does not become faulty within the preemption delay, the transmission of VLANs is switched back to the recovered interface.

Figure 1-4 A topology with two normal links of load balance

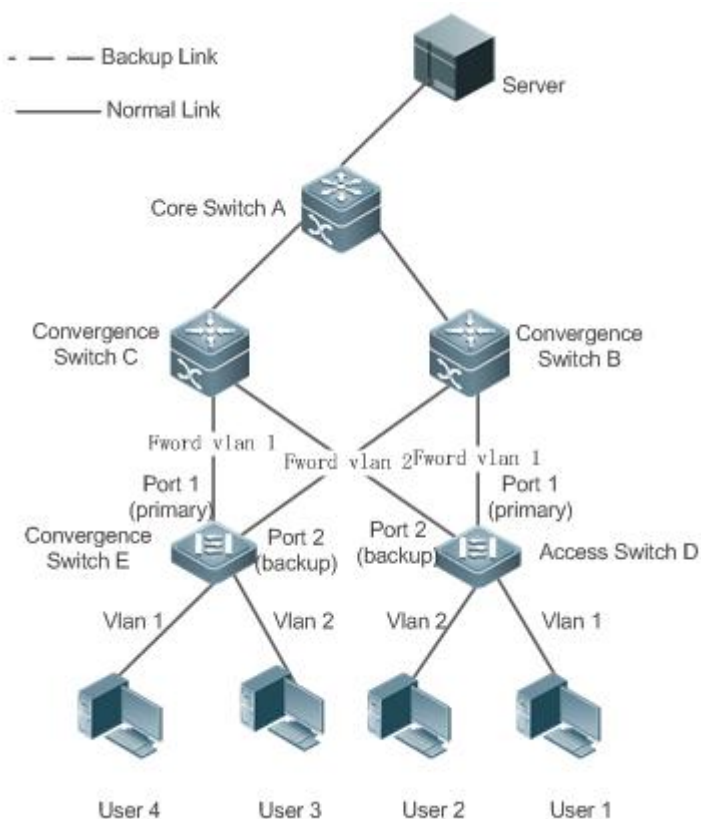

Related Configuration

➤ **Enabling VLAN Load Balance on an interface**

By default, the VLAN load balance function on an interface is disabled.

You can run the **switchport backup interface prefer instance** command to enable the VLAN load balance function.

If this function is not enabled, the link bandwidth cannot be fully used when packets are forwarded when the two links are normal. You must enable the VLAN load balance function on a port so that the interface can be involved in VLAN load balance.

i The instance mapping of REUP VLAN load balance is controlled by the MSTP module in a unified manner. For details about how to configure the instances, see the description in the *Configuring MSTP*.

! The VLAN load balance function can be configured only on trunk, uplink or hybrid interfaces.

1.3.5 Link State Tracking

Link tracking means that when the upstream link is faulty, services are switched to the downstream link so that the backup interface can continue forwarding packets.

Working Principle

Link state tracking provides the function of notifying downlink devices for link switching when the upstream link is faulty. You can configure the uplink and downstream interfaces of a link state tracking group and bind the link status of multiple downstream interfaces to the interfaces of multiple upstream links to implement link status synchronization. When all upstream links in a tracking group are faulty, the interfaces of the downstream links are shut down forcibly to ensure that the transmission of the downstream links is switched from the active link to the backup link.

As shown in Figure 1-5, when the upstream link of switch B is faulty, link state tracking rapidly shuts down the downstream interface of switch B so that the uplink transmission of switch D is switched to switch C.

Figure 1-5 A topology where the upstream link of the active link is faulty

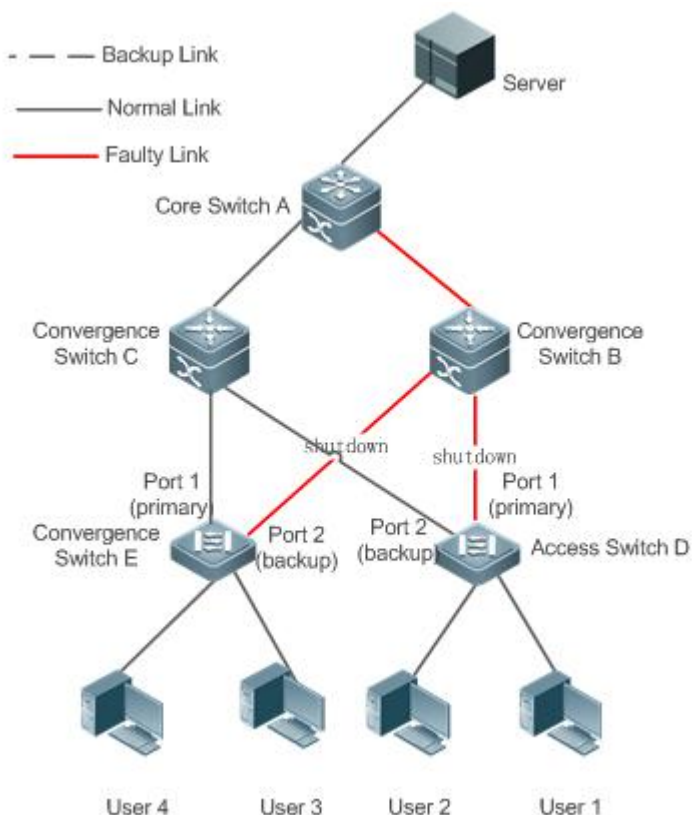

Related Configuration

➤ **Enabling Link Tracking**

Link tracking is disabled by default.

You can run the **link state track** [number] command to enable a link tracking group. The value of **number** ranges from 1 to 2. The first link tracking group is enabled by default (the default value of **number** is 1).

If link tracking is not enabled, the status of a corresponding upstream interface cannot be detected and packet forwarding switching cannot be implemented in time.

➤ **Enabling the Downlink Delay Up Function for a Link Tracking Group**

By default, the downlink delay for link tracking is 0s.

You can run the **link state track number up-delay timer** command to enable a link tracking group. The value of **number** ranges from 1 to 2. The first link tracking group is enabled by default (the default value of **number** is 1). The value of **timer** ranges from 0 to 300s, which is 0s by default.

By enabling the downlink delay up function, you can avoid frequent downlink switching caused by uplink flapping in a link tracking group. That is, when the upstream link becomes up, the downstream link becomes up after a delay.



➤ Adding an interface to a Link Tracking Group

By default, an interface is not added to a link tracking group.

You can run the **link state group [number] {upstream | downstream}** command to set upstream interfaces and downstream interfaces of the link tracking group. The value of **number** ranges from 1 to 2. An interface is added to the first link tracking group by default (the default value of number is 1).

If an interface is not added to a tracking group, the status of a corresponding upstream interface cannot be detected and packet forwarding switching cannot be implemented in time.

1.4 Configuration

Configuration	Description and Command	
Configuring Basic Functions of REUP	 (Mandatory) It is used to enable dual link backup of REUP.	
	switchport backup interface	Enables dual link backup of REUP.
Configuring the Preemption Mode and Delay Function of REUP	 (Optional) It is used to determine the preemption mode and delay time. The default values are used if they are not configured.	
	switchport backup interface preemption mode	Sets the preemption mode.
	switchport backup interface preemption delay	Sets the delay time for preemption.
Configuring MAC Address	 (Optional) It is used to enable rapid update of MAC addresses.	

Configuration	Description and Command	
<u>Update</u>	mac-address-table update group	Sets the MAC address update group ID of a switch.
	mac-address-table move update transit	Enables sending of MAC address update messages.
	mac-address-table move update transit vlan	Enables sending of the VLAN ID of MAC address update messages.
	mac-address-table move update	Configures the maximum number of MAC address update packets sent per second. The value ranges from 0 to 32000. The default value is 150.
	mac-address-table move update receive	Enables receiving of MAC address update messages.
	mac-address-table move update receive vlan	Configures the VLAN range for processing MAC address update messages.
<u>Configuring VLAN Load Balance</u>	(Optional) It is used to enable VLAN load balance.	
	switchport backup interface prefer instance	Configures the link VLAN load balance of REUP.
<u>Configuring Link Tracking</u>	(Optional) It is used to enable link tracking.	
	link state track up-delay	Enables the downlink delay up for a link state tracking group.
	link state track	Enables a link state tracking group.
	link state group	Add an interface as an upstream interface or a downstream interface of a specified link state tracking group.

1.4.1 Configuring Basic Functions of REUP

Configuration Effect

- When a link is faulty, the other normal link is switched to the forward state immediately for forwarding packets.

Notes

- An interface belongs to only one REUP pair. Each active link has only one backup link. A backup link can be used as the backup link of only one active link. The active and backup links must use different interfaces.
- REUP supports layer-2 physical interfaces and AP interfaces, but does not support AP member interfaces.
- The active and backup interfaces may be of different types and have different rates. For example, an AP interface can be used as the active interface whereas a physical interface is configured as the backup interface.
- Interfaces configured with REUP are not involved in STP calculation.
- Each device can be configured with a maximum of 16 REUP pairs.
- Interfaces successfully configured with REUP cannot change interfaces to layer-3 interfaces or be added to an AP.

Configuration Steps

➤ **Enabling Dual Link Backup of REUP**

- Mandatory.
- If there is no special requirement, dual link backup of REUP should be enabled on an interface of the receiving switch.

Verification

Run the **show interfaces switchport backup [detail]** command to check whether dual link backup of REUP is configured.

Related Commands

➤ **Enabling Dual Link Backup of REUP**

Command	switchport backup interface <i>interface-id</i>
Parameter Description	<i>interface-id</i> : Indicates the backup interface ID.
Command Mode	Interface configuration mode
Usage Guide	If the interface where the mode resides is the active interface, the interface corresponding to the interface-id parameter is the backup interface. When the active link is faulty, rapidly recover the transmission of the backup link.

Configuration Example

➤ **Enabling Dual Link Backup of REUP**

<p>Scenario</p> <p>Figure 1-6</p> <p>Dual uplink networking</p>	<p>As shown in Figure 1-6, there are two upstream links from switch D to switch A, which are switch D > switch B > switch A and switch D > switch C > switch A. There are two upstream links from switch E to switch A, which are switch E > switch B > switch A and switch E > switch C > switch A.</p>
<p>Configuration Steps</p>	<ul style="list-style-type: none"> ● Configure dual link backup (the interface Gi0/1 is the active interface and Gi0/2 is the backup interface) of REUP on the access switch D (E).
<p>D</p>	<pre>SwitchD> enable SwitchD# configure terminal</pre>

	<pre>SwitchD(config)# interface GigabitEthernet 0/1 SwitchD(config-if-GigabitEthernet 0/1)# switchport mode trunk SwitchD(config-if-GigabitEthernet 0/1)#switchport backup interface GigabitEthernet 0/2 SwitchD(config-if-GigabitEthernet 0/1)# exit</pre>
<p>E</p>	<pre>SwitchE> enable SwitchE# configure terminal SwitchE(config)# interface GigabitEthernet 0/1 SwitchE(config-if-GigabitEthernet 0/1)# switchport mode trunk SwitchE(config-if-GigabitEthernet 0/1)#switchport backup interface GigabitEthernet 0/2 SwitchD(config-if-GigabitEthernet 0/1)# exit</pre>
<p>Verification</p>	<ul style="list-style-type: none"> ● Check the dual link backup information configured for switch D (E).
<p>D</p>	<pre>SwitchD#show interfaces switchport backup detail Switch Backup Interface Pairs: Active Interface Backup Interface State ----- Gi0/1 Gi0/2 Active Up/Backup Standby Interface Pair : Gi0/1, Gi0/2 Preemption Mode : off Preemption Delay : 35 seconds Bandwidth : Gi0/1(100000 Mbits), Gi0/2(100000 Mbits)</pre>
<p>E</p>	<pre>SwitchE#show interfaces switchport backup detail Switch Backup Interface Pairs: Active Interface Backup Interface State ----- Gi0/1 Gi0/2 Active Up/Backup Standby Interface Pair : Gi0/1, Gi0/2 Preemption Mode : off Preemption Delay : 35 seconds Bandwidth : Gi0/1(100000 Mbits), Gi0/2(100000 Mbits)</pre>

Common Errors

- Other REUP pairs are configured on a configured interface.
- A configured interface is not a layer-2 physical interface or AP interface.

1.4.2 Configuring the Preemption Mode and Delay Function of REUP

Configuration Effect

- Restrict the preemption mode and preemption delay time for REUP link switching.

Notes

- Dual link backup of REUP must be configured.

Configuration Steps

- Optional.
- If the active link needs to always forward packets or the link bandwidth needs to be used to determine the link for forwarding packets, the corresponding preemption mode and delay time must be configured.

Verification

Run the **show interfaces switchover backup [detail]** command to check whether the preemption mode and delay time are consistent with the configurations.

Related Commands

⌵ Configuring the Preemption Mode of REUP

Command	switchover backup interface <i>interface-id</i> preemption mode {forced bandwidth off}
Parameter	<i>interface-id</i> : Indicates the backup interface ID.
Description	mode : Sets the preemption mode: forced : Indicates the forced mode. bandwidth : Indicates the bandwidth mode. off : Indicates that the preemption mode is off.
Command Mode	Interface configuration mode
Usage Guide	The preemption modes include forced, bandwidth and off. In the bandwidth mode, an interface with a high bandwidth is selected first to transmit data; in the forced mode, the active interface is selected first to transmit data; in the off mode, no preemption is performed. The default mode is off.

⌵ Configuring the Delay Time of REUP

Command	switchover backup interface <i>interface-id</i> preemption delay <i>delay-time</i>
Parameter	<i>interface-id</i> : Indicates the backup interface ID.
Description	<i>delay-time</i> : Indicates the delay time.
Command Mode	Interface configuration mode
Usage Guide	Preemption delay indicates the delay time after a faulty link is recovered to the time when link switching is

	performed again.
--	------------------

Configuration Example

▾ **Configuring the Preemption Mode and Delay Time of REUP**

Scenario	As shown in Figure 1-6, there are two upstream links from switch D to switch A, which are switch D > switch B > switch A and switch D > switch C > switch A. There are two upstream links from switch E to switch A, which are switch E > switch B > switch A and switch E > switch C > switch A.
Configuration Steps	<ul style="list-style-type: none"> Configure the preemption mode to bandwidth on the access switch D (E) and the delay time to 40s.
D	<pre>SwitchD> enable SwitchD# configure terminal SwitchD(config)# interface GigabitEthernet 0/1 SwitchD(config-if-GigabitEthernet 0/1)#switchport backup interface gi 0/2 preemption mode bandwidth SwitchD(config-if-GigabitEthernet 0/1)#switchport backup interface gi 0/2 preemption delay 40 SwitchD(config-if-GigabitEthernet 0/1)# exit</pre>
E	<pre>SwitchE> enable SwitchE# configure terminal SwitchD(config)# interface GigabitEthernet 0/1 SwitchD(config-if-GigabitEthernet 0/1)#switchport backup interface gi 0/2 preemption mode bandwidth SwitchD(config-if-GigabitEthernet 0/1)#switchport backup interface gi 0/2 preemption delay 40 SwitchD(config-if-GigabitEthernet 0/1)# exit</pre>
Verification	<ul style="list-style-type: none"> Check the dual link backup information configured for switch D (E).
D	<pre>SwitchD#show interfaces switchport backup detail Switch Backup Interface Pairs: Active Interface Backup Interface State ----- Gi0/1 Gi0/2 Active Up/Backup Standby Interface Pair : Gi0/1, Gi0/2 Preemption Mode : bandwidth Preemption Delay : 40 seconds Bandwidth : Gi0/1(100000 Mbits), Gi0/2(100000 Mbits)</pre>

```

E
SwitchE#show interfaces switchport backup detail

Switch Backup Interface Pairs:

Active Interface      Backup Interface      State
-----
Gi0/1                 Gi0/2                 Active Up/Backup Standby

Interface Pair : Gi0/1, Gi0/2

Preemption Mode : bandwidth

Preemption Delay : 40 seconds

Bandwidth : Gi0/1(100000 Mbits), Gi0/2(100000 Mbits)
    
```

Common Errors

- A configured interface is not a layer-2 physical interface or AP interface.

1.4.3Configuring MAC Address Update

Configuration Effect

- Rapidly delete and update MAC addresses of an interface during link switching to make packet convergence faster.

Notes

- Dual link backup of REUP must be configured.
- Each device can be configured with a maximum of 8 address update groups. Each address update group can have a maximum of 8 member interfaces and an interface can belong to multiple address update groups.

Configuration Steps

- Mandatory.
- If there is no special requirement, the MAC address update function should be configured.

Verification

Run the **show mac-address-table update group [detail]** command to view the update group configuration.

Related Commands

📌 **Configuring the MAC Address Update Group ID of a Switch**

Command	mac-address-table update group [group-num]
Parameter	group-num: Indicates the MAC address update group ID.
Description	
Command	Interface configuration mode

Mode	
Usage Guide	In order to reduce large flooding caused by MAC address update which may affect normal data transmission of the switch, we add a setting of a MAC address update group. Only after all interfaces on a switching path are added to the same MAC address update group, transmission of downlink data can be rapidly recovered.

✚ Enabling Sending of MAC Address Update Messages

Command	mac-address-table move update transit
Parameter Description	-
Command Mode	Command Mode
Usage Guide	To reduce link switching and loss of downlink data streams, you need to enable sending of MAC address update messages on a switch that performs switching.

✚ Enabling Sending of the VLAN ID of MAC Address Update Messages

Command	mac-address-table move update transit vlanvid
Parameter Description	<i>vid</i> : Indicates the VLAN ID for sending MAC address update messages.
Command Mode	Interface configuration mode
Usage Guide	After sending of MAC address update messages is enabled, MAC address update messages can be sent to uplink devices during link switching.

Configure the maximum number of MAC address update packets sent per second.

✚ Configuring the Maximum Number of MAC Address Update Packets Sent Per Second

Command	mac-address-table move update max-update-rate <i>pkts-per-second</i>
Parameter Description	<i>pkts-per-second</i> : Indicates the maximum number of MAC address update packets sent per second. The value ranges from 0 to 32000. The default value is 150.
Command Mode	Configuration mode
Usage Guide	During link switching, REUP sends MAC address update packets of a specified quantity to uplink devices per second to recover the downlink data transmission of the uplink device.

✚ Enabling Receiving of MAC Address Update Messages

Command	mac-address-table move update receive
Parameter Description	-
Command Mode	Configuration mode
Usage Guide	During switching of dual link backup, downlink data streams may be lost since the MAC address table of the uplink switch is not updated in real time. In order to reduce loss of layer-2 data streams, you need to update the MAC address table of the uplink switch. In this case, you need to enable receiving of MAC address update messages on the uplink switch.

➤ **Configuring the VLAN Range for Processing MAC Address Update Messages**

Command	mac-address-table move update receive vlan <i>vlan-range</i>
Parameter Description	<i>vlan-range</i> : Indicates the VLAN range for processing MAC address update messages.
Command Mode	Configuration mode
Usage Guide	This command is used to disable the function for processing MAC address update messages on certain VLANs. For a VLAN disabled with the function for processing MAC address update messages, MAC address update packets can be used to recover the downlink transmission of uplink devices; however, the convergence performance for link faults will be decreased.

Configuration Example

➤ **Configuring MAC Address Update**

Scenario	As shown in Figure 1-6, there are two upstream links from switch D to switch A, which are switch D > switch B > switch A and switch D > switch C > switch A. There are two upstream links from switch E to switch A, which are switch E > switch B > switch A and switch E > switch C > switch A.
Configuration Steps	<ul style="list-style-type: none"> ● Enable sending of MAC address update messages on the access switch D (E). ● Enable receiving of MAC address update packets on switch B (C). ● Add all interfaces on the REUP switching path to the same MAC address update group. ● In the environment, Gi0/1 and Gi0/3 of switch B are the interfaces on the switching path of switch D's uplink, and Gi0/3 and Gi0/2 are the interfaces on the switching path of switch E's uplink. You can add interfaces Gi0/1, Gi0/2 and Gi0/3 to the same address update group. Similarly, you can obtain the configuration of switch C. ● Enable receiving of MAC address update packets on switch A. ● Add all interfaces on the REUP switching path of switch A to the same MAC address update group.
D	<pre>SwitchD> enable SwitchD# configure terminal SwitchD(config)# mac-address-table move update transit SwitchD(config)# exit</pre>
E	<pre>SwitchE> enable SwitchE# configure terminal SwitchE((config)# mac-address-table move update transit SwitchE(config)# exit</pre>

<p>B</p>	<pre>SwitchB# configure terminal SwitchB(config)# mac-address-table move update receive SwitchB(config)# interface range gigabitEthernet 0/1 -3 SwitchB(config-if-range)#switchport mode trunk SwitchB(config-if-range)# mac-address-table update group 1 SwitchB(config-if-range)# end</pre>
<p>C</p>	<pre>SwitchB# configure terminal SwitchB(config)# mac-address-table move update receive SwitchB(config)# interface range gigabitEthernet 0/1 -3 SwitchB(config-if-range)#switchport mode trunk SwitchB(config-if-range)# mac-address-table update group 1 SwitchB(config-if-range)# end</pre>
<p>A</p>	<pre>SwitchA# configure terminal SwitchA(config)# mac-address-table move update receive SwitchA(config)# interface range gigabitEthernet 0/1 -2 SwitchA(config-if-range)# switchport mode trunk SwitchA(config-if-range)# mac-address-table update group 1 SwitchA(config-if-range)# end</pre>
<p>Verification</p>	<p>Check the information about the address update groups on switches D, E, C, B and A.</p>
<p>D</p>	<pre>SwitchD# show run incl mac-ad mac-address-table move update transit</pre>
<p>E</p>	<pre>SwitchE# show run incl mac-ad mac-address-table move update transit</pre>
<p>B</p>	<pre>SwitchB# show mac-address-table update group detail show mac-address-table update group detailMac-address-table Update Group:1 Received mac-address-table update message count:0 Group member Receive Count Last Receive Switch-ID Receive Time ----- Gi0/1 0 0000.0000.0000</pre>

	<pre> Gi0/2 0 0000.0000.0000 Gi0/3 0 0000.0000.0000 </pre>
C	<pre> SwitchC# show mac-address-table update group detail Mac-address-table Update Group:1 Received mac-address-table update message count:0 Group member Receive Count Last Receive Switch-ID Receive Time ----- Gi0/1 0 0000.0000.0000 Gi0/2 0 0000.0000.0000 Gi0/3 0 0000.0000.0000 </pre>
A	<pre> SwitchA# show mac-address-table update group detail Mac-address-table Update Group:1 Received mac-address-table update message count:0 Group member Receive Count Last Receive Switch-ID Receive Time ----- Gi0/1 0 0000.0000.0000 Gi0/2 0 0000.0000.0000 </pre>

Common Errors

- A configured interface is not a layer-2 physical interface or AP interface.

1.4.4Configuring VLAN Load Balance

Configuration Effect

- Maximize the utilization of link bandwidth.

Notes

- Dual link backup of REUP must be configured.
- The Access interface cannot be shared by VLAN load balance and STP.
- For interfaces successfully configured with VLAN load balance, you cannot modify the attributes of the interfaces but can modify the VLAN attributes of the interfaces.

Configuration Steps

- If maximizing bandwidth utilization is not required, this configuration is optional.
- If there is a requirement for VLAN load balance, corresponding configuration must be performed.

Verification

Run the **show interfaces switchport backup [detail]** command to check whether VLAN load balance is configured.

Related Commands

📄 **Configuring VLAN Load Balance**

Command	switchport backup interface <i>interface-id</i> prefer instance <i>instance-range</i>
Parameter	<i>interface-id</i> : Indicates the backup interface ID.
Description	<i>instance-range</i> : Indicates the load instance range of the backup interface.
Command Mode	Interface configuration mode
Usage Guide	You can modify the mapping between instances and VLANs by using the instance mapping function of MSTP.

Configuration Example

📄 **Configuring VLAN Load Balance**

Scenario	As shown in Figure 1-6, there are two upstream links from switch D to switch A, which are switch D > switch B > switch A and switch D > switch C > switch A. There are two upstream links from switch E to switch A, which are switch E > switch B > switch A and switch E > switch C > switch A.
Configuration Steps	<ul style="list-style-type: none"> ● Configure instance mappings on switch D (E) to map VLAN 1 to instance 1, VLAN 2 to instance 2, VLAN 3 to instance 3, and VLAN 4 to instance 4. For details, see the <i>MSTP Configuration Guide</i>. ● Configure the VLAN load balance function on switch D (E).
D	<pre>SwitchD> enable SwitchD# configure terminal SwitchD(config)# interface GigabitEthernet 0/1 SwitchD(config-if-GigabitEthernet 0/1)# switchport mode trunk SwitchD(config-if-GigabitEthernet 0/1)#switchport backup interface gi0/2 prefer instance 2 SwitchD(config-if-GigabitEthernet 0/1)# exit</pre>
E	<pre>SwitchE> enable SwitchE# configure terminal SwitchE(config)# interface GigabitEthernet 0/1 SwitchE(config-if-GigabitEthernet 0/1)# switchport mode trunk SwitchD(config-if-GigabitEthernet 0/1)#switchport backup interface gi0/2 prefer instance 4 SwitchD(config-if-GigabitEthernet 0/1)# exit</pre>
Verification	<ul style="list-style-type: none"> ● Check the dual link backup information configured for switch D (E).
D	<pre>SwitchD#show interfaces switchport backup detail</pre>

	<pre> Switch Backup Interface Pairs: Active Interface Backup Interface State ----- Gi0/1 Gi0/2 Active Up/Backup Up Instances Preferred on Active Interface: Instance 0-1,3-64 Mapping VLAN 1,3-4094 Instances Preferred on Backup Interface: Instance 2 Mapping VLAN 2 Interface Pair : Gi0/1, Gi0/2 Preemption Mode : balance Preemption Delay : 35 seconds Bandwidth : Gi0/1(800 kbits), Gi0/2(100000 kbits) </pre>
<p>E</p>	<pre> SwitchE#show interfaces switchport backup detail Switch Backup Interface Pairs: Active Interface Backup Interface State ----- Gi0/1 Gi0/2 Active Up/Backup Up Instances Preferred on Active Interface: Instance 0-3,5-64 Mapping VLAN 1-3,5-4094 Instances Preferred on Backup Interface: Instance 4 Mapping VLAN 4 Interface Pair : Gi0/1, Gi0/2 Preemption Mode : balance Preemption Delay : 35 seconds Bandwidth : Gi0/1(800 kbits), Gi0/2(100000 kbits) </pre>

Common Errors

- The mappings between VLAN IDs and instances are not configured.

1.4.5 Configuring Link Tracking

Configuration Effect

- After detecting that the upstream link is disconnected, forcibly disconnect the downstream link so that link switching can be performed.

Notes

- Dual link backup of REUP must be configured.
- For the link state tracking function, each interface belongs to only one link state tracking group and each device can be configured with up to 2 link state tracking groups. Each link state tracking group can have 8 upstream interfaces and 256 downstream interfaces.

Configuration Steps

- Mandatory.
- If there is no special requirement, the uplink tracking function should be configured.

Verification

Run the **show link state group** command to view the configured link tracking information.

Related Commands

↘ Enabling a Link State Tracking Group

Command	link state track [<i>num</i>]
Parameter	<i>num</i> : Indicates the ID of a link state tracking group.
Description	
Command	Configuration mode
Mode	
Usage Guide	You can create a link tracking group and then add an interface to the specified tracking group.

↘ Enabling the Downlink Delay Up for a Link State Tracking Group

Command	link state track <i>num</i> up-delay <i>timer</i>
Parameter	<i>num</i> : Indicates the ID of a link state tracking group.
Description	<i>timer</i> : Indicates the downlink delay up time, which is 0s by default.
Command	Global configuration mode
Mode	
Usage Guide	You must enable the delay function so that the downstream link can be up after the delay.

↘ Adding an interface to a Link Tracking Group

Command	ink stategroup <i>num</i> { upstream downstream }
Parameter	<i>num</i> : Indicates the ID of a link state tracking group.
Description	upstream : Adds the interface as an upstream interface of the tracking group. downstream : Adds the interface as a downstream interface of the tracking group.

Command	Interface configuration mode
Mode	
Usage Guide	You can create a link tracking group and then add an interface to the specified tracking group.

Configuration Example

Configuring a Link Tracking Group

Scenario	As shown in Figure 1-6, there are two upstream links from switch D to switch A, which are switch D > switch B > switch A and switch D > switch C > switch A. There are two upstream links from switch E to switch A, which are switch E > switch B > switch A and switch E > switch C > switch A.
Configuration Steps	<ul style="list-style-type: none"> ● Create link tracking group 1 on switch B (C). ● On switch B (C), add the interfaces Gi0/1 and Gi0/2 as downstream interfaces of the link tracking group and add the interface Gi0/3 as an upstream interface of the link tracking group.
B	<pre>SwitchB> enable SwitchB# configure terminal SwitchB(config)# link state track 1 SwitchB(config)# interface GigabitEthernet 0/1 SwitchB(config-if-GigabitEthernet 0/1)#link state group 1 downstreamSwitchB(config-if-GigabitEthernet 0/1)#exit SwitchB(config)# interface GigabitEthernet 0/2 SwitchB(config-if-GigabitEthernet 0/2)# link state group 1 downstream SwitchB(config-if-GigabitEthernet 0/2)#exit SwitchB(config)# interface GigabitEthernet 0/3 SwitchB(config-if-GigabitEthernet 0/3)#link state group 1 upstream SwitchB(config-if-GigabitEthernet 0/3)#exit</pre>
C	<pre>SwitchC> enable SwitchC# configure terminal SwitchC(config)# link state track 1 SwitchC(config)# interface GigabitEthernet 0/1 SwitchC(config-if-GigabitEthernet 0/1)#link state group 1 downstreamSwitchC(config-if-GigabitEthernet 0/1)#exit SwitchC(config)# interface GigabitEthernet 0/2 SwitchC(config-if-GigabitEthernet 0/2)# link state group 1 downstream SwitchC(config-if-GigabitEthernet 0/2)#exit SwitchC(config)# interface GigabitEthernet 0/3 SwitchC(config-if-GigabitEthernet 0/3)#link state group 1 upstream SwitchC(config-if-GigabitEthernet 0/3)#exit</pre>

Verification	Check the link tracking group information configured for switch B (C).
B	<pre>SwitchB#show link state group Link State Group:1 Status: enabled, Down Upstream Interfaces :Gi0/3(Down) Downstream Interfaces : Gi0/2(Down)</pre>

Common Errors

- Interfaces are added to a link tracking group when the link tracking group is not enabled.

1.5 Monitoring

Displaying

Description	Command
Displays the dual link backup information of REUP.	show interfaces[<i>interface-id</i>]switchport backup [detail]
Displays the configurations of an MAC address update group.	show mac-address-table update group [detail]
Displays the REUP statistics about sent MAC address update messages.	show mac-address-table move update
Displays the information about a link state tracking group.	show link state group

Debugging

System resources are occupied when debugging information is output. Therefore, disable debugging immediately after use.

Description	Command
Enables all REUP debugging.	debug reup all
Debugs the normal running process of REUP.	debug reup process
Debugs MAC address update messages of REUP.	debug reup packet
Debugs MAC address update packets of REUP.	debug reup macupdt
Debugs hot backup.	debug reup ha
Debugs errors occurring in REUP running.	debug reup error
Debugs received events.	debug reup evnet
Debugs statistics when show operations are performed.	debug reup status

2 Configuring RLDP

2.1 Overview

The Rapid Link Detection Protocol (RLDP) achieves rapid detection of unidirectional link failures, directional forwarding failures and downlink loop failures of an Ethernet. When a failure is found, relevant ports will be closed automatically according to failure treatment configuration or the user will be notified to manually close the ports to avoid wrong flow forwarding or an Ethernet layer-2 loop.

2.2 Applications

Application	Description
<u>Unidirectional Link Detection</u>	Detect a unidirectional link failure.
<u>Bidirectional Forwarding Detection</u>	Detect a bidirectional link failure.
<u>Downlink Loop Detection</u>	Detect a link loop.

2.2.1 Unidirectional Link Detection

Scenario

As shown in the following figure, A is connected to B via optical fiber. The two lines are the Tx and Rx lines of optical fiber. Unidirectional link detection is enabled on A and B. If any of the Tx of Port A, Rx of Port B, Tx of Port B and Rx of Port A fails, a unidirectional failure will be detected and treated under the RLDP. If the failure is eliminated, the administrator may manually restore the RLDP on A and B and resume detection.

Figure 2-1

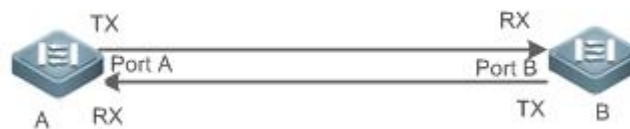

Remarks	<p>A and B are layer-2 or layer-3 switches.</p> <p>The Tx of Port A of A is connected to the Rx of Port B of B.</p> <p>The Rx of Port A of A is connected to the Tx of Port B of B.</p>
----------------	---

Deployment

- Global RLDP is enabled.
- Configure unidirectional link detection under Port A and Port B and define a method for failure treatment.

2.2.2 Bidirectional Forwarding Detection

Scenario

As shown in the following figure, A is connected to B via optical fiber, and the two lines are Tx and Rx lines of optical fiber. Unidirectional link detection is enabled on A and B. If the Tx of Port A, Rx of Port B, Rx of Port A and Tx of Port B all fail, a bidirectional failure will be detected and treated under the RLDP. If the failure is eliminated, the administrator may manually restore the RLDP on A and B and resume detection.

Figure 2-2



Remarks	A and B are layer-2 or layer-3 switches. The Tx of Port A of A is connected to the Rx of Port B of B. The Rx of Port A of A is connected to the Tx of Port B of B.
----------------	--

Deployment

- Global RLDP is enabled.
- Configure BFD under Port A and Port B and define a method for failure treatment.

2.2.3 Downlink Loop Detection

Scenario

As shown in the following figure, A, B and C are connect into a loop. Downlink loop detection is enabled on A, and a loop is detected and treated.

Figure 2-3

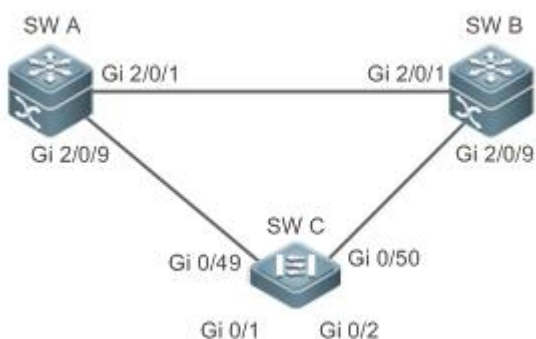

Remarks	A, B and C are layer-2 or layer-3 switches. A, B and C are interconnected via exchange ports.
----------------	--

Deployment

- Global RLDP is enabled on A.
- Configure downlink loop detection on the Gi 2/0/1 and Gi 2/0/9 ports of A, and define a method for failure treatment.

2.3 Features

Most Ethernet link detection mechanisms detect link connectivity through automatic physical-layer negotiation. However, in some cases devices are connected on the physical layer and operate normally but layer-2 link communication is disabled or abnormal. The RLDP recognizes a neighbor device and detects a link failure through exchanging Prob packets, Echo packets or Loop packets with the device.

Basic Concepts

↘ Unidirectional Link Failure

A unidirectional link failure occurs in case of a cross-connected optical fiber, a disconnected optical fiber, an open-circuit optical fiber, one open-circuit line in a twisted-pair cable, or unidirectional open circuit of an intermediate device between two devices. In such cases, one end of a link is connected and the other disconnected so that flow is forwarded wrongly or a loop guard protocol (for example, the STP) fails.

↘ Bidirectional Link Failure

A bidirectional link failure occurs in case of two optical fibers, two open-circuit lines in a twisted-pair cable, or bidirectional open circuit of an intermediate device between two devices. In such cases, the both ends of a link are disconnected so that flow is forwarded wrongly.

↘ Loop Failure

A downlink device is wrongly connected to form a loop, resulting in a broadcast storm.

↘ RLDP Packet

The RLDP defines three types of packets: Prob packets, Echo packets and Loop packets.

- Prob packets are layer-2 multicast packets for neighbor negotiation, and unidirectional or bidirectional link detection. The default encapsulation format is SNAP, which changes automatically to EthernetII if a neighbor sends EthernetII packets.
- Echo packets are layer-2 unicast packets as response to Prob packets and used for unidirectional or bidirectional link detection. The default encapsulation format is SNAP, which changes automatically to EthernetII if a neighbor sends EthernetII packets.
- Loop packets are layer-2 multicast packets for downlink loop detection. They can only be received. The default encapsulation format is SNAP.

↘ RLDP Detection Interval and Maximum Detection Times

A detection interval and the maximum detection times can be configured for the RLDP. A detection interval determines the period of sending Prob packets and Loop packets. When a device receives a Prob packet, it replies with an Echo packet immediately. A detection interval and the maximum detection times determine the maximum detection time (equal to a detection interval × the maximum detection times + 1) for unidirectional or bidirectional link detection. If neither Prob nor Echo packet from a neighbor can be received within the maximum detection time, the treatment of unidirectional or bidirectional failure will be triggered.

↘ RLDP Neighbor Negotiation

When configured with unidirectional or bidirectional link detection, a port can learn a peer-end device as its neighbor. One port may learn one neighbor, which is variable. If negotiation is enabled, unidirectional or bidirectional link detection starts after a port finds a neighbor through negotiation, which succeeds when a port receives a Prob packet from the neighbor. However, if the RLDP is enabled under a failure, the port cannot learn a neighbor so that detection cannot start. In this case, recover the link state before enabling the RLDP.

➤ **Treatment for Failed Port under RLDP**

- Warning: Only print Syslog to indicate a failed port and a failure type.
- Shutdown SVI: Print Syslog, and then inquire an SVI according to the Access VLAN or Native VLAN of a port and shut down the SVI if the port is a physical exchange port or layer-2 AP member port.
- Port violation: Print Syslog, and configure a failed port as in violation state, and the port will enter Linkdown state physically.
- Block: Print Syslog, and configure the forward state of a port as Block, and the port will not forward packets.
- Monitor: Print Syslog, and monitor the port state in real time, and notify other modules of the port state.

➤ **Recovery of Failed Port under RLDP**

- Manual reset: Manually reset all failed ports to initialized state and restart link detection.
- Manual or automatic errdisable recovery: Recover all failed ports to initialized state manually or regularly (30s by default and configurable) and restart link detection.
- Automatic recovery: Under unidirectional or bidirectional link detection, if the treatment for failed ports is not specified as port violation, recover ports to initialized state based on Prob packets and restart link detection.
- Automatic **rldp error-recover interval**: Enable the device to recover all failed ports to initialized state regularly (Configurable) and restart link detection.

➤ **Port State under RLDP**

- normal: Indicates the state of a port after link detection is enabled.
- error: Indicates the state of a port after a unidirectional or bidirectional link failure or a loop failure is detected.

➤ **Overview**

Feature	Description
Deploying RLDP Detection	Enable unidirectional or bidirectional link detection or downlink loop detection for failures and implement treatment.

2.3.1 Deploying RLDP Detection

The RLDP provides unidirectional link detection, bidirectional forwarding detection and downlink loop detection.

Working Principle

➤ **Unidirectional Link Detection**

When this function is enabled, a port sends Prob packets and receives Echo packets from a neighbor regularly as well as receiving Prob packets from a neighbor and replying with Echo packets. Within the maximum detection time, if the port receives Prob packets but no Echo packets, or none of them, treatment for a unidirectional failure will be triggered and detection will stop.

➤ **Bidirectional Forwarding Detection**

When this function is enabled, a port sends Prob packets and receives Echo packets from a neighbor regularly as well as receiving Prob packets from a neighbor and replying with Echo packets. Within the maximum detection time, if the port receives neither Prob packets nor Echo packets from a neighbor, treatment for a bidirectional failure will be triggered and detection will stop.

➤ **Downlink Loop Detection**

When this function is enabled, a port sends Loop packets regularly. In the following cases, a loop failure will be triggered after the same port or a different port receives the packets: in one case, the egress and ingress ports are the same routed port or layer-3 AP member port; in another case, the egress and ingress ports are exchange ports or layer-2 AP member ports in a same default VLAN and in Forward state. Treatment for the failure will be implemented and detection will stop.

Related Configuration



- **Configuring RLDP Detection**

By default, RLDP detection is disabled.

You may run the global command **rldp enable** or the interface command **rldp port** to enable RLDP detection and specify a detection type and treatment.

You may run the **rldp neighbor-negotiation** command to neighbor negotiation, the **rldp detect-interval** to specify a detection interval, the **rldp detect-max** to specify detection times, the **rldp error-recover interval** to recover failed ports regularly, or the **rldp reset** to recover a failed port.

2.4 Configuration

Configuration	Description and Command
Configuring Basic RLDP Functions	 (Mandatory) It is used to enable RLDP detection under global configuration mode.
	rldp enable Enables global RLDP detection on all ports.
	 (Mandatory) It is used to specify under interface configuration mode a detection type and failure treatment for an interface.
	rldp port Enables RLDP detection on a port and specifies a detection type and failure treatment.
	 (Optional) It is used to configure a detection interval, detection times and neighbor negotiation under global configuration mode.
	rldp detect-interval Modifies global RLDP parameters on all ports, such as the detection interval, maximum
	rldp detect-max such as the detection interval, maximum
rldp neighbor-negotiation detection times and neighbor negotiation.	

	rldp error-recover interval	Configures the time interval for recovering failed ports. This function is disabled by default.
	 (Optional) It is used under privileged mode.	
	rldp reset	Recovers all ports.

2.4.1 Configuring Basic RLDP Functions

Configuration Effect

- Enable RLDP unidirectional link detection, bidirectional forwarding detection, or downlink loop detection to discover failures.

Notes

- Loop detection is effective to all member ports of an AP when configured on one of the ports. Unidirectional link detection and bidirectional forwarding detection are effective only on an AP member port.
- The loop detection on a physical port added to an AP shall be configured the same as that of the other member ports. There are three cases. First, if loop detection is not configured on a newly-added port but on the existing member ports, the new port adopts the configuration and detection results of the existing ports. Second, if a newly-added port and the existing member ports have different loop detection configuration, the new port adopts the configuration and detection results of the existing ports.
- When configuring the RLDP on an AP port, you may configure failure treatment only as "shutdown-port", to which other configurations will be modified.
- When "shutdown-port" is configured on a port, RLDP detection cannot be restored in case of a failure. After troubleshooting, you may run the **rldp reset** or **errdisable recovery** command to restore the port and resume detection. For configuration of the **errdisable recovery** command, please refer to the *SWITCH-INTF-SCG.doc*.

Configuration Steps

↘ Enabling RLDP

- Mandatory.
- Enable RLDP detection on all ports under global configuration mode.

↘ Enabling Neighbor Negotiation

- Optional.
- Enable the function under global configuration mode, and port detection will be started under successful neighbor negotiation.

↘ Configuring Detection Interval

- Optional.
- Specify a detection interval under global configuration mode.

↘ Configuring Maximum Detection Times

- Optional.
- Specify the maximum detection times under global configuration mode.

↘ **Configuring a Time Interval for Recovering Failed Ports**

- Optional.
- Configure the time interval for recovering the failed port under global configuration mode.

↘ **Configuring Detection under Port**

- Mandatory.
- Configure unidirectional RLDP detection, bidirectional RLDP detection or downlink loop detection under interface configuration mode, and specify failure treatment.

↘ **Restoring All Failed Ports**

- Optional.
- Enable this function under privileged mode to restore all failed ports and resume detection.

Verification

- Display the information of global RLDP, port and neighbor.

Related Commands

↘ **Modifying Global RLDP Detection Parameters**

Command	rldp { detect-interval <i>interval</i> detect-max <i>num</i> neighbor-negotiation }
Parameter Description	detect-interval <i>interval</i> : Indicates a detection interval. detect-max <i>num</i> : Indicates detection times. neighbor-negotiation : Indicates neighbor negotiation.
Command Mode	Global configuration mode
Usage Guide	Modify all RLDP parameters on all ports when necessary.

↘ **Configuring A Time Interval for Recovering Failed Ports**

Command	rldp error-recover interval <i>interval</i>
Parameter Description	<i>interval</i> : Indicates a recovery interval. The unit is second. The range is from 30 to 86400. This function is disabled by default.
Command Mode	Global configuration mode
Usage Guide	This command is used to configure a time interval for recovering the state (Error state) of failed ports. If the loop is eliminated, the topology environment will be automatically recovered.

↘ **Enabling RLDP Detection on Interface**

Command	rldp port { unidirection-detect bidirection-detect loop-detect } { warning shutdown-svi shutdown-port
----------------	--

	block monitor }
Parameter Description	<p>unidirection-detect: Indicates unidirectional link detection.</p> <p>bidirection-detect: Indicates bidirectional forwarding detection.</p> <p>loop-detect: Indicates downlink loop detection.</p> <p>warning: Indicate the failure treatment is warning.</p> <p>shutdown-svi: Indicate the failure treatment is closing the SVI that the interface is on.</p> <p>shutdown-port: Indicates the failure treatment is port violation.</p> <p>block: Indicates the failure treatment is disabling learning and forwarding of a port.</p> <p>monitor: Indicates the failure treatment is monitoring the port state.</p>
Command Mode	Interface configuration mode
Usage Guide	<p>The interfaces include layer-2 switch ports, layer-3 routed ports, layer-2 AP member ports, and layer-3 AP member ports.</p> <p>Ports on which RLDP is enabled to handle downlink loop failures are random. For example, RLDP downlink loop detection is configured on both downlink ports A and B, and the configured failure handling mode of port A is warning while that of port B is shutdown-port. When there is a downlink loop between port A and port B, port A may detect the downlink loop failure prior to port B. After port A completes failure handling according to the configuration, it no longer sends packets to detect the downlink loop status. Port B fails to detect the downlink loop failure because it does not receive a loop detection packet from port A, but the downlink loop actually persists. If a detected downlink loop needs to be actually removed in application scenarios, downlink ports in the same loop must be restricted to use a consistent loop failure handling mode and the loop failure handling mode cannot be warning.</p> <p>The monitor policy can be configured for the unidirectional link detection in order to correlate with ERPS (Ethernet Ring Protection Switching).</p>

📌 **Modifying Global RLDP Detection Parameters**

Command	rldp {detect-interval <i>interval</i> detect-max <i>num</i> neighbor-negotiation }
Parameter Description	<p>detect-interval <i>interval</i>: Indicates a detection interval.</p> <p>detect-max <i>num</i>: Indicates detection times.</p> <p>neighbor-negotiation: Indicates neighbor negotiation.</p>
Command Mode	Global configuration mode
Usage Guide	Modify all RLDP parameters on all ports when necessary.

📌 **Recovering Failed Port**

Command	rldp reset
Parameter Description	N/A
Command Mode	Privileged mode
Usage Guide	Recover all failed ports to initialized state and resume detection.

📌 **Displaying RLDP State Information**

Command	<code>show rldp [interface interface-name]</code>
Parameter	<i>interface-name</i> : Indicates the interface to display information of.
Description	
Command Mode	Privileged mode, global configuration mode, or interface configuration mode
Usage Guide	Display RLDP state information.

Configuration Example

📌 **Enabling RLDP Detection in Ring Topology**

As shown in the following figure, the aggregation and access sections are in a ring topology. The STP is enabled on all devices to prevent loop and provide redundancy protection. To avoid a unidirectional or bidirectional link failure resulting in STP failure, RLDP unidirectional and bidirectional link detection is enabled between aggregation devices as well as between an aggregation device and the access device. To avoid loop due to wrong downlink connection of the aggregation devices, enable RLDP downlink loop detection on the downlink ports of the aggregation devices and of the access device. To avoid loop due to wrong downlink connection of the access device, enable RLDP downlink loop detection on the downlink ports of the access device.

Figure 2-4

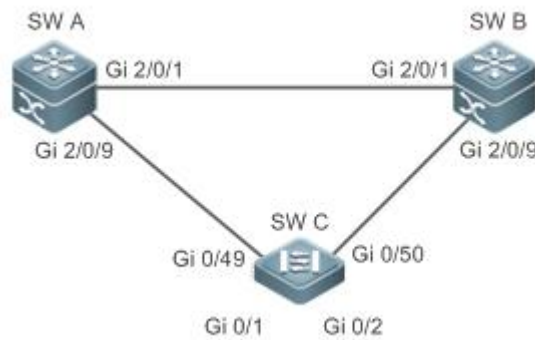

Configuration Steps

- SW A and SW B are aggregation devices, and SW C is an access device. Users connected to SW C. SW A, SW B and SW C are structured in a ring topology, and the STP is enabled on each of them. For STP configuration, refer to relevant configuration guide.
- Enable the RLDP on SW A, enable unidirectional and bidirectional link detection on the two ports, and enable loop detection on the downlink port.
- Enable the RLDP on SW B, enable unidirectional and bidirectional link detection on the two ports, and enable loop detection on the downlink port.
- Enable the RLDP on SW C, enable unidirectional and bidirectional link detection on the two uplink ports, and enable loop detection on the two downlink ports.

A

```
A#configure terminal
A(config)#rldp enable
A(config)#interface GigabitEthernet 2/0/1
A(config-if-GigabitEthernet 2/0/1)#rldp port unidirection-detect shutdown-port
A(config-if-GigabitEthernet 2/0/1)#rldp port bidirection-detect shutdown-port
A(config-if-GigabitEthernet 2/0/1)# exit
```

	<pre>A(config)#interface GigabitEthernet 2/0/9 A(config-if-GigabitEthernet 2/0/1)#rldp port unidirection-detect shutdown-port A(config-if-GigabitEthernet 2/0/1)#rldp port bidirection-detect shutdown-port A(config-if-GigabitEthernet 2/0/1)#rldp port loop-detect shutdown-port A(config-if-GigabitEthernet 2/0/1)#exit</pre>
B	<p>Apply the configuration on SW A.</p>
C	<pre>C#configure terminal C(config)#rldp enable C(config)#interface GigabitEthernet 0/49 C(config-if-GigabitEthernet 0/49)#rldp port unidirection-detect shutdown-port C(config-if-GigabitEthernet 0/49)#rldp port bidirection-detect shutdown-port C(config-if-GigabitEthernet 0/49)# exit C(config)#interface GigabitEthernet 0/50 C(config-if-GigabitEthernet 0/50)#rldp port unidirection-detect shutdown-port C(config-if-GigabitEthernet 0/50)#rldp port bidirection-detect shutdown-port C(config-if-GigabitEthernet 0/50)#exit C(config)#interface GigabitEthernet 0/1 C(config-if-GigabitEthernet 0/1)# rldp port loop-detect shutdown-port C(config-if-GigabitEthernet 0/1)#exit C(config)#interface GigabitEthernet 0/2 C(config-if-GigabitEthernet 0/2)# rldp port loop-detect shutdown-port C(config-if-GigabitEthernet 0/2)#exit</pre>
Verification	<ul style="list-style-type: none"> ● Check the RLDP information on SW A, SW B and SW C. Take SW A for example.
A	<pre>A#show rldp rldp state : enable rldp hello interval: 3 rldp max hello : 2 rldp local bridge : 00d0.f822.33aa ----- Interface GigabitEthernet 2/0/1 port state : normal neighbor bridge : 00d0.f800.51b1 neighbor port : GigabitEthernet 2/0/1</pre>

```

unidirection detect information:
    action: shutdown-port
    state : normal
bidirection detect information:
    action: shutdown-port
    state : normal

Interface GigabitEthernet 2/0/9
port state      : normal
neighbor bridge : 00d0.f800.41b0
neighbor port   : GigabitEthernet 0/49

unidirection detect information:
    action: shutdown-port
    state : normal
bidirection detect information:
    action: shutdown-port
    state : normal

loop detect information:
    action: shutdown-port
    state : normal
    
```

Common Errors

- RLDP functions and private multicast address authentication or TPP are enabled at the same time.
- Neighbor negotiation is not enabled when configuring unidirectional or bidirectional link detection. The RLDP should be enabled on a neighbor device, or otherwise a unidirectional or bidirectional failure will be detected.
- If RLDP detection is configured to be implemented after neighbor negotiation while configuring unidirectional or bidirectional link detection, detection cannot be implemented as no neighbor can be learned due to a link failure. In this situation, you are suggested to recover the link state first.
- You are suggested not to specify the failure treatment as Shutdown SVI under a routed port.
- You are suggested not to specify the failure treatment as Block for a port, on which a loop protection protocol is enabled, for example, the STP.

2.5 Monitoring

Displaying

Description	Command
-------------	---------

Displays RLDLP state.	<code>show rldp [interface interface-name]</code>
-----------------------	---

3 Configuring DLDP

3.1 Overview

The Data Link Detection Protocol (DLDP) is a protocol used to quickly detect faulty Ethernet links.

A typical Ethernet link detection mechanism detects physical link connectivity through autonegotiation at the physical layer. Such a mechanism has limitations when detecting Layer-3 data communication exceptions despite normal physical connections.

DLDP provides reliable Layer-3 link detection information. After detecting a faulty link, DLDP shuts down the logical state of Layer-3 ports to realize fast Layer-3 protocol convergence.

3.2 Applications

Application	Description
<u>Intra-Network Segment DLDP Detection</u>	The source IP address of the detected port and the detected IP address are in the same network segment.
<u>Inter-Network Segment DLDP Detection</u>	The source IP address of the detected port and the detected IP address are in different network segments.

3.2.1 Intra-Network Segment DLDP Detection

Scenario

This section describes the basic DLDP application scenario where the source IP address of the detected port and the detected IP address are in the same network segment.

In Figure 3-1, the Gi 0/1 Layer-3 port on Switch A and the Gi 0/2 Layer-3 port on Switch C are in the same network segment. To detect the Layer-3 link connectivity from Gi 0/1 to Gi 0/2, enable DLDP on Gi 0/1 or Gi 0/2.

Figure 3-1



Remarks	Device A and Device C are switches. Gi 0/1 and Gi 0/2 are Layer-3 ports in the same network segment. B is a network in the same network segment as Gi 0/1 and Gi 0/2.
----------------	---

Deployment

- Enable DLDP on Gi 0/1 or Gi 0/2.

3.2.2 Inter-Network Segment DLDP Detection

Scenario

This section describes the DLDP application scenario where the source IP address of the detected port and the detected IP address are in different network segments.

In Figure 3-2 the Gi 0/1 Layer-3 port on Switch A and the Gi 0/4 Layer-3 port on Switch D are in different network segments. To detect the Layer-3 link connectivity from Gi 0/1 to Gi 0/4, enable DLDP on Gi 0/1 and configure the DLDP next-hop IP address (IP address of the Gi 0/2 port on Switch B).

Figure 3-2



Remarks	Device A, Device B, and Device D are switches. Gi 0/1 and Gi 0/4 are Layer-3 ports in different network segments.
----------------	--

Deployment

- Enable DLDP on Gi 0/1 and configure the DLDP next-hop IP address.

3.3 Features

Basic Concepts

DLDP Detection Interval and Retransmission Times

Detection interval: Indicates the interval at which DLDP detection packets (ICMP echo) are transmitted.

Retransmission times: Indicate the maximum times DLDP detection packets can be retransmitted in the case of a DLDP detection failure.

When a network device does not receive a reply packet from the peer end within the period of the detection interval multiplied by the retransmission times, the device determines that a Layer-3 link failure occurs and shuts down the logical state of its Layer-3 port (despite the normal physical link connection). When Layer-3 link connectivity is recovered, the device restores its Layer-3 port to Up logical state.

DLDP Detection Modes

Active mode and passive mode are two DLDP detection modes.

Active mode (default): ICMP detection packets are sent actively.

Passive mode: ICMP detection packets are received passively.

↘ DLDP Next Hop

Next hop: Indicates the next node connected to the detected IP address in inter-network segment DLDP detection.

In some cases, DLDP needs to detect IP reachability in non-directly connected network segments. You need to configure the next-hop IP address for the detected port to allow DLDP to obtain the next-hop MAC address through an ARP packet before sending a correct ICMP packet.

In this situation, you need to avoid the return of the reply packet from another link; otherwise, DLDP will misjudge that the detected port does not receive an ICMP reply.

↘ DLDP Recovery Times

Recovery times: Indicate the times DLDP needs to receive consecutive reply packets (ICMP reply) before it can determine link failure recovery.

In some cases, link detection may be unstable. For example, a link is only intermittently pingable. In this case, DLDP repeatedly changes the link status between Up and Down, which may further destabilize the ring network.

Recovery times indicate the times DLDP needs to receive consecutive reply packets before DLDP can set the link in Down state to Up. The default recovery times are three times, indicating that the link needs to be successfully pinged three times before it is set to Up. The recovery times setting reduces link detection sensitivity but increases stability. Related parameters are adjustable according to the network condition.

↘ DLDP Bound MAC Address

Bound MAC address: Indicates the MAC address bound to the detected IP address.

In a complex network environment, DLDP may obtain an invalid MAC address if the detected link has abnormal ARP packets transmitted (causing ARP spoofing), which will make DLDP detection abnormal.

To address this problem, you can bind the detected IP address (or next-hop IP address) to a static MAC address to avoid a DLDP failure in the case of ARP spoofing.

Overview

Feature	Description
DLDP Detection	Detects Layer-3 link connectivity. When a Layer-3 link is abnormal, DLDP shuts down the Layer-3 port.
MAC Address Binding	Binds the detected IP address to the MAC address of the detected device to avoid DLDP exceptions otherwise caused by ARP spoofing.
Passive DLDP Detection	When both ends of the detected link are enabled with DLDP, you can configure one end in passive mode to save bandwidth and CPU resources.

3.3.1 DLDP Detection

DLDP detects Layer-3 link connectivity. When a Layer-3 link is abnormal, DLDP shuts down the corresponding Layer-3 port.

Working Principle

After DLDP detection is enabled, DLDP sends an ARP packet to obtain the MAC address and outbound port of the detected device or the next-hop device. Then DLDP periodically sends IPv4 ICMP echo packets to the MAC address and outbound port to detect link connectivity. If DLDP does not receive an IPv4 ICMP reply packet from the detected device within a specific period, DLDP determines that the link is abnormal and sets the Layer-3 port to Down.

Related Configuration

- Enabling DLDP Detection

By default, DLDP detection is disabled on ports.

Run the **lldp** command with the detected IP address specified to enable DLDP detection.

You can configure the next-hop IP address, MAC address of the detected device, transmission interval, retransmission times, and recovery times based on the actual environment.

3.3.2 MAC Address Binding

The MAC address binding feature is used to bind the detected IP address (or next-hop IP address) to the MAC address of the detected device (or next-hop device) to avoid DLDP exceptions otherwise caused by ARP spoofing

Working Principle

You can bind the detected IP address (or next-hop IP address) to a static MAC address to avoid a DLDP failure in the case of ARP spoofing.

Related Configuration

By default, no MAC address is bound in DLDP detection.

Bind the MAC address of the detected device when you run the **lldp** command to enable DLDP detection. If the next-hop IP address is specified, bind the MAC address of the next-hop device.

After DLDP detection is enabled, DLDP sends ARP packets and ICMP packets with a fixed destination IP address and a fixed destination MAC address. If the source IP address and MAC address in the received packet do not match the bound IP address and MAC address, DLDP will not process the packet.

3.3.3 Passive DLDP Detection

When both ends of the detected link are enabled with DLDP, you can configure one end in passive mode to save bandwidth and CPU resources.

Working Principle

After the device at the local end sends an ICMP echo packet, the peer device determines link connectivity according to the packet reception time by using specific detection parameters, which are the same as those at the local end, thus saving bandwidth and CPU resources.



Related Configuration

By default, passive DLDP detection is disabled.

Run the **lldp passive** command to enable passive DLDP detection.

After passive DLDP detection is enabled, DLDP will return an ICMP reply packet upon receiving an ICMP echo packet, instead of actively sending ICMP echo packets to the peer end. If DLDP does not receive an ICMP echo packet within a specific period, it determines that the link to the peer port is abnormal.

3.4 Configuration

Configuration	Description and Command
Enabling DLDP Detection	 (Mandatory) It is used to enable DLDP detection in interface configuration mode.
	dldp Enables DLDP detection.
	 (Mandatory) It is used to enable passive DLDP detection in interface configuration mode.
	dldp passive Enables passive DLDP detection.
	 (Optional) It is used to configure the detection interval, retransmission times, and recovery times of DLDP detection in global configuration mode.
	dldp interval Modifies the DLDP parameters globally to apply
	dldp retry the modifications to DLDP detection on all
dldp resume ports.	

3.4.1 Enabling DLDP Detection

Configuration Effect

- Detect Layer-3 link connectivity. When a Layer-3 link is abnormal, DLDP shuts down the Layer-3 port.

Notes

- DLDP supports the configuration of multiple IP addresses on a Layer-3 port. DLDP sets the port to Down when none of the IP addresses receives an ICMP reply. If one IP address resumes communication, DLDP sets the port to Up again.
- DLDP uses the first IP address of the Layer-3 port as the source IP address of detection packets.

Configuration Steps

▾ Enabling DLDP Detection

- Mandatory.
- When you enable DLDP detection in interface configuration mode, you can configure the next-hop IP address, MAC address, transmission interval, retransmission times, and recovery times based on the actual environment.

▾ Configuring a DLDP Detection Mode

- Optional.
- You can configure active or passive DLDP detection in interface configuration mode based on the actual environment.
- If DLDP detection needs to be enabled at both ends of a Layer-3 link, you can configure passive DLDP detection at one end to save bandwidth and CPU resources.

➤ **Configuring DLDP Parameters Globally**

- Optional.
- You can modify the parameters of DLDP detection on all ports in global configuration mode based on requirements. The parameters include the packet transmission interval, packet retransmission times, and recovery times.

Verification

- Display the device DLDP information, including the status and statistics of DLDP detection on all ports.

Related Commands

➤ **Enabling DLDP Detection**

Command	dldp <i>ip-address</i> [<i>next-hop-ip</i>] [mac-address <i>mac-addr</i>] [interval <i>tick</i>] [retry <i>retry-num</i>] [resume <i>resume-num</i>]
Parameter	<i>ip-address</i> : Indicates the detected IP address.
Description	<i>next-hop-ip</i> : Indicates the next-hop IP address. <i>mac-addr</i> : Indicates the MAC address of the detected device to be bound. If the next-hop IP address is specified, bind the MAC address of the next-hop device. <i>tick</i> : Indicates the interval at which detection packets are transmitted. The value ranges from 5 to 6,000 ticks (1 tick = 10 ms). The default value is 100 ticks (1s). <i>retry-num</i> : The value ranges from 1 to 3,600. The default value is 4. <i>resume-num</i> : Indicates the recovery times. The value ranges from 1 to 200. The default value is 3.
Command Mode	Interface configuration mode
Usage Guide	The port to be enabled with DLDP detection must be a Layer-3 port, such as a router port, L3AP port, and SVI port.

➤ **Configuring a DLDP Detection Mode**

Command	dldp passive
Parameter	N/A
Description	
Command Mode	Interface configuration mode
Usage Guide	You need to enable DLDP detection before configuring a DLDP detection mode.

➤ **Modifying DLDP Detection Parameters Globally**

Command	dldp { interval <i>tick</i> retry <i>retry-num</i> resume <i>resume-num</i> }
Parameter	<i>tick</i> : Indicates the interval at which detection packets are transmitted. The value ranges from 5 to 6,000 ticks (1 tick = 10 ms). The default value is 100 ticks (1s).
Description	<i>retry-num</i> : Indicates the interval at which detection packets are retransmitted. The value ranges from 1 to 3,600. The default value is 4. <i>resume-num</i> : Indicates the recovery times. The value ranges from 1 to 200. The default value is 3.
Command Mode	Global configuration mode
Usage Guide	Use this command to quickly modify the parameters of DLDP detection on all ports when the actual environment is

	changed.
--	----------

📌 **Displaying the DLDP Status**

Command	show dldp statistic [interface interface-name]
Parameter Description	<i>interface-name</i> : Indicates the Layer-3 port on which the DLDP status will be displayed.
Command Mode	Privileged mode, global configuration mode, and interface configuration mode
Usage Guide	Use this command to display the DLDP status on a specific port. You can also use this command to display the DLDP status on all ports.

Configuration Example

📌 **Enabling DLDP Detection on Layer-3 Ports on Device A and Device B in a Layer-3 Network**

Scenario Figure 3-3	
Verification	<ul style="list-style-type: none"> ● Enable DLDP detection on the Gi 0/1 and Gi 0/2 router ports on Device A to detect the Layer-3 link connectivity between Device A and Device B and that between Device A and Device D. ● To control the Gi 0/2 router port of Device B, enable passive DLDP detection on the port.
A	<pre>A#configure terminal A(config)#interface GigabitEthernet 0/1 A(config-if-GigabitEthernet 0/1)#dldp 192.168.1.2 A(config-if-GigabitEthernet 0/1)# exit A(config)#interface GigabitEthernet 0/2 A(config-if-GigabitEthernet 0/1)#dldp 192.168.3.4 192.168.2.3</pre>
B	<pre>B#configure terminal B(config)#interface GigabitEthernet 0/2 B(config-if-GigabitEthernet 0/1)#dldp 192.168.1.1 B(config-if-GigabitEthernet 0/1)#dldp passive</pre>
Verification	<ul style="list-style-type: none"> ● Display the DLDP status on Device A and Device B to check whether DLDP detection is enabled and works normally.
A	<pre>A# show dldp</pre>

	Interface	Type	Ip	Next-hop	Interval	Retry	Resume	State
	Gi0/1	Active	192.168.1.2		100	4	3	Up
	Gi0/1	Active	192.168.3.4	192.168.2.3	100	4	3	Up
B	B# show dldp							
	Interface	Type	Ip	Next-hop	Interval	Retry	Resume	State
	Gi0/2	Passive	192.168.1.1		100	4	3	Up

Common Errors

- An unreachable IPv4 unicast route is misjudged as a DLDP detection failure.
- DLDP detection fails because the peer device does not support ARP/ICMP replies.
- No next-hop IP address is configured in inter-network segment DLDP detection.

3.5 Monitoring

Clearing

Description	Command
Clears DLDP statistics.	clear dldp [interface <i>interface-name</i> [<i>ip-address</i>]]

Displaying

Description	Command
Displays the DLDP status.	show dldp [interface <i>interface-name</i>]
Displays the DLDP statistics on the Up/Down port sates.	show dldp statistic

4 Configuring VRRP

4.1 Overview

Virtual Router Redundancy Protocol (VRRP) is a fault-tolerant routing protocol.

VRRP adopts the master-backup design to ensure migration of functions from a Master router to a Backup one when the Master failed, without influencing internal and external data communication or modifying Local Area Network (LAN) configuration. A VRRP group maps multiple routers into a virtual router. VRRP ensures only one router at a moment on behalf of a virtual router transfers packets, which is the elected Master. If the Master fails, one of the Backup routers will replace it. Under VRRP, it seems that a host in a LAN uses only one router, and the routing remains functional even when the first-hop router fails.

- VRRP is applicable to LAN scenarios which require the redundancy of routing egresses.

Protocols and Standards

- RFC2338: Virtual Router Redundancy Protocol
- RFC3768: Virtual Router Redundancy Protocol (VRRP)
- RFC5798: Virtual Router Redundancy Protocol (VRRP) Version 3 for IPv4 and IPv6

4.2 Applications

Application	Description
<u>Routing Redundancy</u>	Configure routers in a LAN as one VRRP group to achieve simple routing redundancy.
<u>Load Balancing</u>	Configure routers in a LAN as multiple VRRP groups to achieve traffic load balancing.

4.2.1 Routing Redundancy

Scenario

Configure routers in a LAN as one VRRP group, where hosts take the virtual IP address of this group as the default gateway address.

- Packets from Host 1, Host 2 and Host 3 to other networks are forwarded by the elected Master router (Router A in Figure 4-1).
- If Router A fails, the Master will be re-elected between Router B and Router C to forward packets, achieving simple routing redundancy.

Figure 4-1

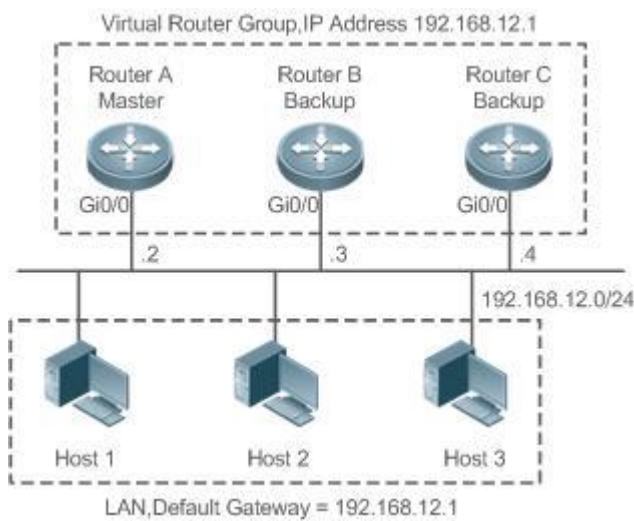

Deployment

- Router A, Router B and Router C are connected to the LAN via Ethernet interfaces.
- On Router A, Router B and Router C, VRRP is configured on the Ethernet interfaces connected to the LAN.
- These Ethernet interfaces are in the same VRRP group whose virtual IP address is 192.168.12.1.
- The gateway address for Host 1, Host 2 and Host 3 is the IP address of the VRRP group, namely 192.168.12.1.

4.2.2 Load Balancing

Scenario

Configure routers in a LAN as multiple VRRP groups. Hosts in the LAN take virtual IP addresses of the groups as their gateways, and each router backs up for other routers in different group.

- Packets from Host 1 and Host 2 to other networks with the default gateway address as the virtual IP address of virtual router 1 are forwarded by the Master of virtual router 1 (Router A in Figure 4-2).
- Packets from Host 3 and Host 4 to other networks with the default gateway address as the virtual IP address of virtual router 2 are forwarded by the Master of virtual router 2 (Router B in Figure 4-2).
- Routing redundancy is achieved on Router A and Router B, and the LAN traffic is shared to achieve load balancing.

Figure 4-2

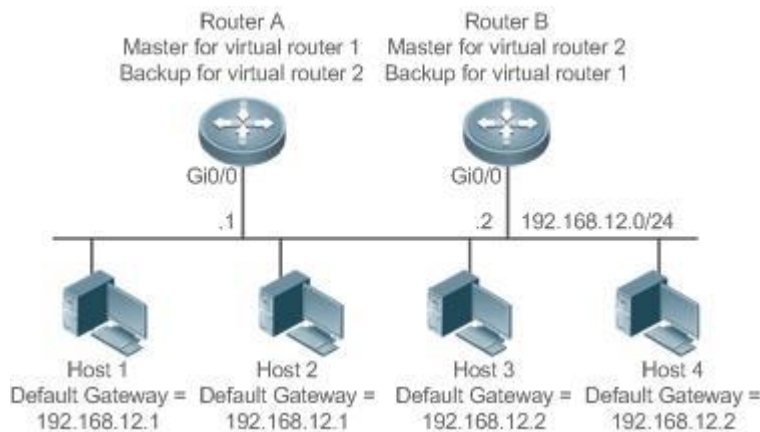

Deployment

- Router A and Router B are connected to the LAN via Ethernet interfaces.
- On Router A and Router B, two virtual routers are configured on the Ethernet interfaces connected to the LAN.
Router A takes the IP address 192.168.12.1 of Ethernet interface Gi0/0 as the IP address of virtual router 1. Thus for virtual router 1, Router A becomes the Master and Router B becomes the Backup.
- Router B takes the IP address 192.168.12.2 of Ethernet interface Gi0/0 as the IP address of virtual router 2. Thus for virtual router 2, Router B becomes the Master and Router A becomes the Backup.
- In the LAN, Host 1 and Host 2 take the IP address 192.168.12.1 of virtual router 1 as the default gateway address, while Host 3 and Host 4 take the IP address 192.168.12.2 of virtual router 2 as the default gateway address.

4.3 Features

Basic Concepts

Virtual Router

A virtual router, also called a VRRP group, is regarded as a default gateway for hosts in a LAN. A VRRP group contains a Virtual Router Identifier (VRID) and a set of virtual IP addresses.

Virtual IP Address

Indicates the IP address of a virtual router. A virtual router can be configured with one or multiple IP addresses.

➤ **IP Address Owner**

If a VRRP group has the virtual IP address as that of an Ethernet interface on one real router, the router is regarded as the virtual IP address owner. In such case, the router priority is 255. If the owned Ethernet interface is available, the VRRP group will be in Master state automatically. The IP address owner receives and processes the packets with the destination IP address as that of the virtual router.

➤ **Virtual MAC Address**

The virtual MAC address of a VRRP group is an IEEE 802 MAC address, formatted as **00-00-5E-00-01-{VRID}** with the first five octets assigned and the last two as a group VRID. A VRRP group responds to an Address Resolution Protocol (ARP) request with its virtual MAC address instead of a real MAC address.

➤ **Master Router**

In a VRRP group, only the Master router answers ARP requests and forwards IP packets. If a real router is the IP Address Owner, it becomes the Master router.

➤ **Backup Router**

In a VRRP group, Backup routers only monitor the state of the Master but do not respond to ARP requests or forward IP packets. When the Master fails, Backup routers will take the chance to compete for the position.

➤ **Preemption Mode**

If a VRRP group runs in Preemption mode, a higher priority Backup router will replace the lower priority Master router.

Overview

Feature	Description
VRRP	VRRP achieves redundancy for the default gateways of terminals on a multi-access media (for example, Ethernet). It enables a Backup router to forward packets when the Master router is down, providing transparent routing switch and promoting network service quality.

4.3.1 VRRP

In case that the Master router is faulty, VRRP achieves migration of functions from the Master router to a Backup one without influencing internal and external data communication or modifying LAN configuration.

Working Principle

Figure 4-3 Working Principle of VRRP

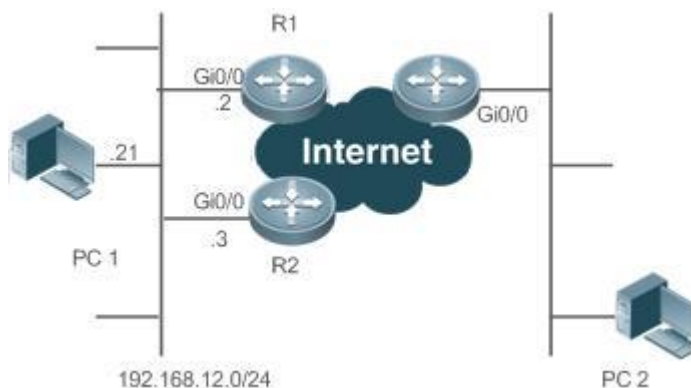

Working Mode of VRRP

The RFC2338, RFC3768 and RFC5798 protocols define the format and operating mechanism of VRRP packets. Multicast VRRP packets are sent periodically with specified destination addresses by the Master router to advertise normal operation or for Master election. VRRP allows a router in a LAN to automatically replace the Master who forwards IP packets when the latter fails. This helps achieve hot backup and fault tolerance of IP-based routing as well as ensure communication continuity and reliability for hosts in the LAN. A VRRP group achieves redundancy through multiple real routers. However, only one router acts as the Master to forward packets while the others are Backup routers. Router switching in a VRRP group is completely transparent to hosts in a LAN.

Master Election Process

The RFC standards stipulate the master election process as follows:

- VRRP provides a simple mechanism for Master election. First, compare the VRRP priorities configured on the interfaces of the routers in a VRRP group. The router with the highest priority is elected as the Master. If these priorities are equal, compare the primary IP addresses of these routers. The router with the biggest IP address is elected as the Master.
- After the Master router is elected, the other routers become Backup routers (and enter the **Backup** state) and monitor the state of the master router through the VRRP packets the master router sends. If the master router is operational, it regularly sends VRRP multicast packets known as Advertisement packets to notify the Backup routers of its status. If the Backup routers do not receive such packets within a set period, all of them will enter the Master state. In such case, the previous step of Master election is repeated. In this way, a router with the highest priority will be elected as a new master, achieving VRRP backup.

Once the Master router of a VRRP group is elected, it is responsible to forward packets for hosts in a LAN.

Communication Process

The VRRP communication process can be explained by Figure 4-3. The routers R1 and R2 are connected to the LAN segment 192.168.12.0/24 via the VRRP-enabled Ethernet interfaces Gi0/0. Hosts in the LAN take the virtual IP address of the VRRP group as the default gateway address. Only the virtual router is recognized by the hosts. The Master router in the group, however, is unknown. For example, when PC 1 plan to communicate with PC 2, PC 1 sends packets to the default gateway with the virtual IP address; The Master router in the group receives the packets and forwards them to PC 2. In this process, PC 1 only senses the virtual router instead of R1 or R2. The Master router in the group is elected between R1 and R2. When the Master fails, it will be replaced automatically by the other router.

Related Configuration

↘ Enabling VRRP

By default, VRRP is disabled on an interface.

In the interface configuration mode, run the **vrrp group ip ipaddress [secondary]** or **vrrp group ipv6 ipv6-address** command to set the VRID and virtual IP address to enable VRRP.

VRRP must be enabled on an interface.

↘ Configuring the IPv4 VRRP Authentication String

By default, VRRP is in non-authentication mode.

Run the **vrrp group authentication string** command to set an authentication string in MD5 authentication mode or a plain text password in plain text mode for an IPv4 VRRP group. In the plain text authentication mode, a password contains 8 bytes at most.

Members of a VRRP group can communicate with each other only when they are in the same authentication mode. In the plain text authentication mode, all routers in a VRRP group should have the same authentication password. The plain text authentication password cannot guarantee security but only prevents/prompts wrong VRRP configurations.

↘ Configuring the VRRP Advertisement Interval

By default, the advertisement interval of the Master router is 1 second.

Run the **vrrp [ipv6] group timers advertise { advertise-interval | csec centisecond-interval }** command to change the interval.

When VRRP learning timer is not configured, the same advertisement interval should be set for a VRRP group, otherwise routers in **Backup** state will discard received VRRP packets.

↘ Configuring the VRRP Preemption Mode

By default, a VRRP group operates in the Preemption mode.

To enable the Preemption mode for a VRRP group, run the **vrrp [ipv6] group preempt [delay seconds]** command. The optional parameter **delay seconds** is 0 by default.

If a VRRP group operates in the Preemption mode, a router will become the Master of the group when it finds that its priority is higher than that of the current Master. If a VRRP group operates in Non-preemption mode, a router will not become the Master even when it finds that its priority is higher than that of the current Master. It makes little sense to configure the Preemption mode when the VRRP group uses the IP address of an Ethernet interface, in which case the group has the highest priority and automatically becomes the Master in the group. The optional parameter **Delay Seconds** defines the delay before a backup VRRP router declares its Master identity.

↘ Enabling the IPv6 VRRP Accept Mode

By default, the Accept mode is disabled for an IPv6 VRRP group.

To enable the Accept mode, run the **vrrp ipv6 group accept_mode** command.

After the Accept mode is enabled, an IPv6 VRRP virtual router in **Master** state receives and processes packets with the virtual router IP address as the destination; when the Accept mode is disabled, the virtual router discards such packets except Neighbor Advertisement (NA) packets and Neighbor

Solicitation (NS) packets. Besides, an IPv6 VRRP master virtual router in **Owner** state receives and processes packets with the virtual router IP address as the destination by default no matter whether the Accept mode is configured or not.

↘ **Configuring the VRRP Router Priority**

By default, the router priorities in a VRRP group are all 100.

To adjust the priority, run the **vrrp [ipv6] group priority level** command.

If a router in the Preemption mode owns the group's virtual IP address and the highest priority, it becomes the group Master, while the other routers with lower priorities in the group become Backup (or monitoring) routers.

↘ **Configuring the VRRP Tracked Interface**

By default, no interface is tracked by a VRRP group.

To configure such an interface, run the **vrrp group track { interface-type interface-number | bfd interface-type interface-number ipv4-address } [priority]** or **vrrp ipv6 group track interface-type interface-number [priority]** command.

After an interface is configured for a VRRP group to monitor, the router priority will be adjusted dynamically based on the interface state. Once the interface becomes unavailable, the priority of the router in the group will be reduced by a set value, and another functional and higher priority router in this group will become the Master.

↘ **Configuring the VRRP Tracked IP Address**

By default, no IP address is tracked by a VRRP group.

To configure such an address, run the **vrrp group track ip-address [interval interval-value] [timeout timeout-value] [retry retry-value] [priority]** or **vrrp ipv6 group track { ipv6-global-address | { ipv6-linklocal-address interface-type interface-number } } [interval interval-value] [timeout timeout-value] [retry retry-value] [priority]** command.

After an IP address is configured for a VRRP group to monitor, the router priority will be adjusted dynamically based on the address accessibility. Once the address is inaccessible (the **ping** command fails), the priority of the router in the group will be reduced by a set value, and another higher priority router in this group will become the Master.

↘ **Configuring the VRRP Learning Timer**

By default, the learning timer is disabled for a VRRP group.

To enable it, run the **vrrp [ipv6] group timers learn** command.

After the learning timer is configured, a VRRP Backup router learns the advertisement interval of NA packets from the Master. Based on this instead of a locally set interval, the Backup router calculates the interval for determining a failure of the Master. This command achieves the synchronization of advertisement intervals between Backup routers and the Master.

↘ **Configuring the VRRP Group Description**

By default, no description is configured for a VRRP group.

To configure such a string, run the **vrrp [ipv6] group description text** command.

A VRRP description helps distinguishing VRRP groups. A description has 80 bytes at most, otherwise wrong configuration is prompted.

➤ **Configuring the VRRP Delay**

By default, no delay is configured for a VRRP group.

To enable it, run the **vrrp delay { minimum min-seconds | reload reload-seconds }** command. The two types of delay range from 0 to 60 seconds.

The command configures the delay of starting a VRRP group on an interface. There are two types of VRRP delay: the delay after system startup and the delay after an interface resumes. You may configure them respectively or simultaneously. After the delay is configured for a VRRP group on an interface, the VRRP group starts after the delay instead of immediately upon system startup or the interface's resumption, ensuring non-preemption. If the interface receives a VRRP packet during the delay, the delay will be canceled and the VRRP will be started immediately. This configuration will be effective for both IPv4 and IPv6 VRRP groups of an interface.

➤ **Configuring the IPv4 VRRP Version**

By default, IPv4 adopts the VRRPv2 standard.

To specify the version for IPv4 VRRP, run the **vrrp group version { 2 | 3 }** command.

When the parameter value is set to 2, VRRPv2 is adopted; when the parameter value is set to 3, VRRPv3 is adopted.

➤ **Specifying a Sub VLAN of a Super VLAN to Receive the IPv4 VRRP Packets**

By default, IPv4 VRRP packets are sent to the first **Up** Sub VLAN interface of a Super VLAN.

To specify the first Sub VLAN in Up state of a Super VLAN to receive IPv4 VRRP packets, run the **vrrp detection-vlan first-subvlan** command; to specify a Sub VLAN, run the **vrrp detection-vlan subvlan-id** command. If VRRP and VRRP Plus are enabled simultaneously on a Super VLAN interface, VRRP packets are sent to all Up interfaces of the Sub VLANs under the Super VLAN.

Both the above configurations reduce VRRP packets and avoids influencing router performance and occupying network bandwidth. Yet the routers constituting an IPv4 VRRP group should be interconnected within the first UP Sub VLAN interface or a specified Sub VLAN of the Super VLAN.

➤ **Configuring the BFD Support for IPv4 VRRP on an Interface**

By default, the Bidirectional Forwarding Detection (BFD) protocol support for VRRP is not enabled on an interface.

To enable it, run the **vrrp group bfd ip-address** command.

For a Backup router, run this command to correlate an IPv4 VRRP group with BFD without caring the configured IP address. For the Master, as the primary IP address of a Backup router is not known, the router IP address can only be specified by the administrator.

To enable the BFD support, make sure that IP and BFD session parameters are configured on the target interface.

After the BFD support is enabled for a specified IPv4 VRRP group, when the Master fails, a Backup router may detect it within one second.

➤ **Configuring Global IPv4 VRRP BFD**

By default, the VRRP does not adopt the global IPv4 VRRP BFD mode in detecting the state of the Master.



To enable global IPv4 VRRP BFD, run the **vrrp bfd interface-type interface-number ip-address** command.

After global IPv4 VRRP BFD is enabled, multiple IPv4 VRRP groups may share BFD sessions, achieving fast detection and master-backup failover.

To enable the BFD support, make sure that IP and BFD session parameters are configured on the target interface.

4.4 Configuration

Configuration	Description and Command
<u>Configuring IPv4 VRRP</u>	(Mandatory) It is used to enable IPv4 VRRP.
	vrrp group ip ipaddress [secondary] Enables IPv4 VRRP.
	(Optional) It is used to configure IPv4 VRRP parameters.
	vrrp group authentication string Configures the IPv4 VRRP authentication string.
	vrrp group timers advertise { advertise-interval csec centisecond-interval } Configures the IPv4 VRRP advertisement interval.
	vrrp group preempt [delay seconds] Configures the IPv4 VRRP Preemption mode.
	vrrp group priority level Configures the IPv4 VRRP router priority.
	vrrp group track { interface-type interface-number bfd interface-type interface-number ipv4-address } [priority] Configures the IPv4 VRRP tracked interface.
	vrrp group track ip-address [interval interval-value] [timeout timeout-value] [retry retry-value] [priority] Configures the IPv4 VRRP tracked IP address.
	vrrp group timers learn Configures the IPv4 VRRP learning timer.
	vrrp group description text Configures the IPv4 VRRP group description.
	vrrp delay { minimum min-seconds reload reload-seconds } Configures the IPv4 VRRP delay.
	vrrp group version { 2 3 } Configures the IPv4 VRRP version.
	vrrp detection-vlan { first-subvlan subvlan-id } Specifies a sub VLAN of a super VLAN to receive the IPv4 VRRP packets.
	vrrp group bfd ip-address Configures the BFD support for IPv4 VRRP on an Interface.
vrrp bfd interface-type interface-number ip-address Configures global IPv4 VRRP BFD.	
<u>Configuring IPv6 VRRP</u>	(Mandatory) It is used to enable IPv6 VRRP.
	vrrp group ipv6 ipv6-address Enables IPv6 VRRP on the interface.

Configuration	Description and Command
	 (Optional) It is used to configure IPv6 VRRP parameters.
	vrrp ipv6 group timers advertise { <i>advertise-interval</i> csec <i>centisecond-interval</i> } Configures the IPv6 advertisement interval.
	vrrp ipv6 group preempt [delay seconds] Configures the IPv6 VRRP Preemption mode.
	vrrp ipv6 group accept_mode Enables the Accept mode for an IPv6 VRRP group.
	vrrp ipv6 group priority level Configures the IPv6 VRRP router priority.
	vrrp ipv6 group track interface-type <i>interface-number</i> [<i>interface-priority</i>] Configures the IPv6 VRRP tracked interface.
	vrrp ipv6 group track { <i>ipv6-global-address</i> { <i>ipv6-linklocal-address</i> <i>interface-type</i> <i>interface-number</i> } } [interval <i>interval-value</i>] [timeout <i>timeout-value</i>] [retry <i>retry-value</i>] [<i>priority</i>] Configures the IPv6 VRRP tracked IP address.
	vrrp ipv6 group timers learn Configures the IPv6 VRRP learning timer.
	vrrp ipv6 group description text Configures the IPv6 VRRP group description.
	vrrp delay { minimum <i>min-seconds</i> reload <i>reload-seconds</i> } Configures the IPv6 VRRP delay.
Configuring VRRP-MSTP	 The configuration is the same as IPv4 VRRP configuration.

4.4.1 Configuring IPv4 VRRP

Configuration Effect

- Configure a VRRP group on an interface of a specific LAN segment by setting the VRID and virtual IP address.
- Configure multiple VRRP groups on an interface to achieve load balancing and offer more stable and reliable network services.
- Configure the VRRP tracked interfaces to monitor real-time failures, change interface priorities and realize master-backup failover dynamically.

Notes

- To achieve VRRP, the routers in a VRRP group should be configured with the same virtual IPv4 address.
- To achieve mutual backup between multiple IPv4 VRRP groups, configure multiple IPv4 VRRP groups with identical VRRP configuration on different interface and configure different priorities for them so that they act as the master and backup groups mutually.
- Enable VRRP on Layer-3 interfaces.

Configuration Steps

➤ Enabling IPv4 VRRP

- By default, IPv4 VRRP is disabled on an interface. You can enable it based on your demand.

➤ Configuring the IPv4 VRRP Authentication String

- By default, VRRP is in non-authentication mode. You can enable plain text authentication mode based on your demand.

↘ **Configuring the IPv4 VRRP Advertisement Interval**

- By default, the Master router sends advertisement packets every one second. You can modify the interval based on your demand.

↘ **Configuring the IPv4 VRRP Preemption Mode**

- By default, a VRRP group operates in Preemption mode with a zero-second delay.

↘ **Configuring the IPv4 VRRP Router Priority**

- The default router priority for a VRRP group is 100. You can modify the priority based on your demand.

↘ **Configuring the IPv4 VRRP Tracked Interface**

- By default, an IPv4 VRRP group monitors no interface and the value of priority change is 10. To achieve fault monitoring through interface monitoring, please configure this item.

↘ **Configuring the IPv4 VRRP Learning Timer**

- By default, the learning timer is disabled for a VRRP group. Enable this function if the Backup routers need to learn the Master's advertisement interval.

↘ **Configuring the IPv4 VRRP Group Description**

- By default, no description is configured for a VRRP group. To distinguish VRRP groups clearly, configure descriptions.

↘ **Configuring the IPv4 VRRP Delay**

- By default, the IPv6 VRRP delay is not configured. To guarantee an effective non-preemption mode, configure the delay.

↘ **Configuring the IPv4 VRRP Version**

- By default, IPv4 adopts the VRRPv2 standard. To change it, use the corresponding command.

↘ **Specifying a Sub VLAN of a Super VLAN to Receive the IPv4 VRRP Packets**

- By default, IPv4 VRRP packets are only sent to the first **UP** Sub VLAN interface of a Super VLAN, but you may configure a specific Sub VLAN.

↘ **Configuring the BFD Support for IPv4 VRRP on an Interface**

- By default, the BFD support is not configured on an interface. To configure it, use the corresponding command.

↘ **Configuring Global IPv4 VRRP BFD**

- By default, global IPv4 VRRP BFD is not enabled. To implement it, use the corresponding command.

Verification

- Run the **show vrrp** command to verify the configuration.

Related Commands

↘ **Enabling IPv4 VRRP**

Command	vrrp group ip <i>ipaddress</i> [secondary]
Parameter	<i>group</i> : Indicates the VRID of a VRRP group, the range of which varies with product models.
Description	<i>ipaddress</i> : Indicates the IP address of a VRRP group. secondary : Indicates the secondary IP address of a VRRP group.
Command Mode	Interface configuration mode
Usage Guide	If no virtual IP address is specified, routers cannot join a VRRP group. If no secondary IP address is applied, the configured IP address will be the primary IP address of a VRRP group.

📌 Configuring the IPv4 VRRP Authentication String

Command	vrrp group authentication <i>string</i>
Parameter	<i>group</i> : Indicates the VRID of a VRRP group.
Description	<i>string</i> : Indicates the authentication string of a VRRP group (a plain text password consists of 8 bytes at most).
Command Mode	Interface configuration mode
Usage Guide	In a VRRP group, the same authentication password should be configured for routers. The plain text authentication password cannot guarantee security but only prevents/prompts wrong VRRP configurations. This command is only applicable to VRRPv2 instead of VRRPv3. Authentication is abolished for VRRPv3 (IPv4 VRRP and IPv6 VRRP) packets. If VRRPv2 is chosen for an IPv4 VRRP group, the command is effective; if VRRPv3 is chosen, the command is ineffective.

📌 Configuring the IPv4 VRRP Advertisement Interval

Command	vrrp group timers advertise { <i>advertise-interval</i> csec <i>centisecond-interval</i> }
Parameter	<i>group</i> : Indicates the VRID of a VRRP group.
Description	<i>advertise-interval</i> : Indicates the advertisement interval of a VRRP group (unit: second). csec centisecond-interval : An interval for a master router in a backup group to send VRRP packets. It is an integer from 50 to 99. The unit is centisecond. No default value is provided. The command is only effective for VRRPv3 packets. If it is configured for VRRPv2 packets, the default interval is one second.
Command Mode	Interface configuration mode
Usage Guide	If a router is elected as the Master in a VRRP group, it sends VRRP advertisement packets at the set interval to announce its VRRP state, priority and other information. According to the RFC standards, if an IPv4 VRRP group adopts VRRPv3 for sending multicast packets, the maximum advertisement interval is 40 seconds. Therefore, if the interval is set longer than 40 seconds, this maximum interval will be applied, though the configuration is effective.

📌 Configuring the IPv4 VRRP Preemption Mode

Command	vrrp group preempt [delay <i>seconds</i>]
Parameter	<i>group</i> : Indicates the VRID of a VRRP group.
Description	delay seconds : Indicates the preemption delay for the Master router to claim its status. The default value is 0 second.
Command Mode	Interface configuration mode
Usage Guide	If a VRRP group runs in Preemption mode, a higher priority router will take the place of the lower priority Master. If a

	VRRP group runs in Non-preemption mode, a router with the priority higher than that of the Master remains Backup. It makes little sense to configure the Preemption mode when the VRRP group uses the IP address of an Ethernet interface, in which case the group has the highest priority and automatically becomes the Master in the group.
--	--

📌 Configuring the IPv4 VRRP Router Priority

Command	vrrp group priority level
Parameter	<i>group</i> : Indicates the VRID of a VRRP group.
Description	<i>level</i> : Indicates the priority of an interface in a VRRP group.
Command Mode	Interface configuration mode
Usage Guide	This command is used to manually configure the VRRP router priority.

📌 Configuring the IPv4 VRRP Tracked Interface

Command	vrrp group track { interface-type interface-number bfd interface-type interface-number ipv4-address } [priority]
Parameter	<i>group</i> : Indicates the VRID of a VRRP group.
Description	<i>interface-type interface-number</i> : Indicates the interface to be tracked. bfd interface-type interface-number ipv4-address : A specified adjacent IP address tracked through BFD. <i>priority</i> : Indicates the scale of VRRP priority change when the state of a monitored interface changes. The default value is 10.
Command Mode	Interface configuration mode
Usage Guide	A tracked interface must be a routable Layer-3 logic interface (for example, a Routed port, an SVI interface, a Loopback interface, or a Tunnel interface). The priority of the router owns the virtual IP address associated with a VRRP group must be 255, and no tracked interface can be configured on it.

📌 Configuring the IPv4 VRRP Tracked IP Address

Command	vrrp group track ipv4-address [interval interval-value] [timeout timeout-value] [retry retry-value] [priority]
Parameter	<i>group</i> : Indicates the VRID of a VRRP group.
Description	<i>ipv4-address</i> : Indicates the IPv4 address to be tracked. interval interval-value : Indicates the probe interval. The unit is second. Unless configured manually, the value is 3 seconds by default. timeout timeout-value : Indicates the probe timeout of waiting for responses. If no response is received when the timeout is up, it is regarded that the destination is inaccessible. The unit is second. Unless configured manually, the value is 1 second by default. retry retry-value : Indicates the probe retries. If the probe packet is sent continually for retry-value times but no response is received, it is regarded that the destination is inaccessible. The unit is times. Unless configured, the value is 3 times by default. <i>priority</i> : Indicates the scale of VRRP priority change when the state of a monitored interface changes. The default value is 10.
Command Mode	Interface configuration mode
Usage Guide	To monitor a host, specify its IPv4 address for an IPv4 VRRP group. If a VRRP group owns the actual IP address of an Ethernet interface, the group priority is 255, and no monitored IP

	address can be configured.
--	----------------------------

↘ Configuring the IPv4 VRRP Learning Timer

Command	vrrp group timers learn
Parameter	<i>group</i> : Indicates the VRID of a VRRP group.
Description	
Command Mode	Interface configuration mode
Usage Guide	Once the learning timer is enabled on a VRRP router, a Backup router learns the advertisement interval of the Master during the timer. Based on this, the Backup router calculates the interval for determining the Master router as failed instead of using the locally configured advertisement interval. This command achieves synchronization with the learning timer between the Master and Backup routers.

↘ Configuring the IPv4 VRRP Group Description

Command	vrrp group description text
Parameter	<i>group</i> : Indicates the VRID of a VRRP group.
Description	<i>text</i> : Indicates the description of a VRRP group.
Command Mode	Interface configuration mode
Usage Guide	A VRRP description helps distinguishing VRRP groups. A description has 80 bytes at most, otherwise wrong configuration is prompted.

↘ Configuring the IPv4 VRRP Delay

Command	vrrp delay { minimum <i>min-seconds</i> reload <i>reload-seconds</i> }
Parameter	minimum <i>min-seconds</i> : Indicates the VRRP delay after an interface state changes.
Description	reload <i>reload-seconds</i> : Indicates the VRRP delay after the system starts.
Command Mode	Interface configuration mode
Usage Guide	After the delay is configured for a VRRP group on an interface, the VRRP group starts after the delay instead of immediately upon system startup or the interface's resumption, ensuring non-preemption. If the interface receives a VRRP packet during the delay, the delay will be canceled and the VRRP will be started immediately. The two types of delay share a value range of 0 to 60 seconds. This configuration will be effective for both IPv4 and IPv6 VRRP groups of an interface.

↘ Configuring the IPv4 VRRP Version

Command	vrrp group version { 2 3 }
Parameter	2 : Indicates VRRPv2.
Description	3 : Indicates VRRPv3.
Command Mode	Interface configuration mode
Usage Guide	Considering the compatibility between VRRPv2 and VRRPv3, specify a standard for IPv4 VRRP based on the actual network condition. VRRPv2 is developed in RFC3768, while VRRPv3 is described in RFC5798. This command is only applicable to IPv4 VRRP.

➤ Specifying a Sub VLAN of a Super VLAN to Receive the IPv4 VRRP Packets

Command	vrrp detection-vlan { first-subvlan <i>subvlan-id</i> }
Parameter	first-subvlan : Sends IPv4 VRRP packets only to the first UP Sub VLAN interface in a Super VLAN.
Description	<i>subvlan-id</i> : Sends IPv4 VRRP packets to a specified Sub VLAN.
Command Mode	Interface configuration mode
Usage Guide	<p>This command is used to specify a Sub VLAN of a Super VLAN to receive the IPv4 VRRP packets. IPv4 VRRP packets are sent in a Super VLAN using the following three methods. Packets are sent to the first UP Sub VLAN interface in a Super VLAN, or to a specified Sub VLAN interface in a Super VLAN, or to all the Sub VLAN interfaces in a Super VLAN. If VRRP and VRRP Plus are enabled simultaneously on a Super VLAN interface, VRRP packets are sent to all Up interfaces of the Sub VLANs under the Super VLAN.</p> <p>This command is configured on a VLAN interface and effective only to Super VLAN interfaces.</p>

➤ Configuring the BFD Support for IPv4 VRRP on an Interface

Command	vrrp group bfd <i>ip-address</i>
Parameter	<i>group</i> : Indicates the VRID of a VRRP group.
Description	<i>ip-address</i> : Indicates the interface IP address.
Command Mode	Interface configuration mode
Usage Guide	<p>For a Backup router, run this command to correlate an IPv4 VRRP group with BFD without caring the configured IP address. For the Master, as the primary IP address of a Backup router is not known, the router IP address can only be specified by the administrator.</p> <p>If global IPv4 VRRP BFD is configured, this configuration cannot be performed.</p> <p>To enable the BFD support, make sure that IP and BFD session parameters are configured on the target interface.</p>

➤ Configuring Global IPv4 VRRP BFD

Command	vrrp bfd <i>interface-type interface-number ip-address</i>
Parameter	<i>interface-type interface-number</i> : Indicates interface type and ID.
Description	<i>ip-address</i> : Indicates the interface IP address..
Command Mode	Global configuration mode
Usage Guide	<p>If global IPv4 VRRP BFD is configured, the configured BFD support will be deleted.</p> <p>To enable the BFD support, make sure that IP and BFD session parameters are configured on the target interface.</p> <p>A global IPv4 VRRP BFD session is only applicable to an IPv4 VRRP group consisting of two routers.</p>

Configuration Example

➤ Configuring an IPv4 VRRP Group and Tracked Interface

<p>Scenario Figure 4-4</p>	<p>The diagram illustrates a network topology with three routers (R1, R2, R3) and three workstations (A, B, C). R1 and R2 are connected to a common bus, which is also connected to WorkStation A and WorkStation C. R3 is connected to another common bus, which is also connected to WorkStation B. The Internet cloud is connected to all three routers. The IP addresses and interface names are as follows:</p> <ul style="list-style-type: none"> R1: Gi0/0 (192.168.201.217/24), Gi0/0 (192.168.201.0/24), Gi 2/1 (202.101.90.63/24) R2: Gi0/0 (192.168.201.213/24), Gi 1/1 (60.154.101.3/24) R3: Gi0/0 (192.168.12.217/24), Gi 1/1 (60.154.101.5/24), Gi0/0 (192.168.12.0/24) WorkStation A: 192.168.201.221/24 WorkStation B: 192.168.12.216/24 WorkStation C: 192.168.201.227/24
<p>Configuration Steps</p>	<ul style="list-style-type: none"> ● The cluster of Work Station A and Work Station B (192.168.201.0/24) uses the virtual IP address 192.168.201.1 of the VRRP group constituted by the routers R1 and R2 as the gateway address to communicate with Work Station B (192.168.12.0 /24). ● GigabitEthernet 2/1 on R1 is configured as the tracked interface. ● No VRRP but an ordinary routing function is configured on R3.
<p>R3</p>	<pre> R3#configure terminal R3(config)#interface GigabitEthernet 0/0 //The command "no switchport" is only required for a switch. R3(config-if-GigabitEthernet 0/0)#no switchport R3(config-if-GigabitEthernet 0/0)#ip address 192.168.12.217 255.255.255.0 R3(config-if-GigabitEthernet 0/0)#exit R3(config)#interface GigabitEthernet 1/1 //The command "no switchport" is only required for a switch. R3(config-if-GigabitEthernet 1/1)#no switchport R3(config-if-GigabitEthernet 1/1)#ip address 60.154.101.5 255.255.255.0 R3(config-if-GigabitEthernet 1/1)#exit R3(config)#interface GigabitEthernet 2/1 //The command "no switchport" is only required for a switch. R3(config-if-GigabitEthernet 2/1)#no switchport R3(config-if-GigabitEthernet 2/1)#ip address 202.101.90.61 255.255.255.0 R3(config-if-GigabitEthernet 2/1)#exit </pre>

	<pre>R3(config)#router ospf R3(config-router)#network 202.101.90.0 0.0.0.255 area 10 R3(config-router)#network 192.168.12.0 0.0.0.255 area 10 R3(config-router)#network 60.154.101.0 0.0.0.255 area 10</pre>
<p>R1</p>	<pre>R1#configure terminal R1(config)#interface GigabitEthernet 0/0 R1(config-if-GigabitEthernet 0/0)#ip address 192.168.201.217 255.255.255.0 R1(config-if-GigabitEthernet 0/0)#vrrp 1 priority 120 R1(config-if-GigabitEthernet 0/0)#vrrp 1 timers advertise 3 R1(config-if-GigabitEthernet 0/0)#vrrp 1 ip 192.168.201.1 R1(config-if-GigabitEthernet 0/0)#vrrp 1 track GigabitEthernet 2/1 30 R1(config-if-GigabitEthernet 0/0)#exit R1(config)#interface GigabitEthernet 2/1 R1(config-if-GigabitEthernet 2/1)#ip address 202.101.90.63 255.255.255.0 R1(config-if-GigabitEthernet 2/1)#exit R1(config)#router ospf R1(config-router)#network 202.101.90.0 0.0.0.255 area 10 R1(config-router)#network 192.168.201.0 0.0.0.255 area 10</pre>
<p>R2</p>	<pre>R2#configure terminal R2(config)#interface GigabitEthernet 0/0 R2(config-if-GigabitEthernet 0/0)#ip address 192.168.201.213 255.255.255.0 R2(config-if-GigabitEthernet 0/0)#vrrp 1 ip 192.168.201.1 R2(config-if-GigabitEthernet 0/0)#vrrp 1 timers advertise 3 R2(config-if-GigabitEthernet 0/0)#exit R2(config)#interface GigabitEthernet 1/1 // The command "no switchport" is only required for a switch. R2(config-if-GigabitEthernet 1/1)#no switchport R2(config-if-GigabitEthernet 1/1)#ip address 60.154.101.3 255.255.255.0 R2(config-if-GigabitEthernet 1/1)#exit R2(config)#router ospf R2(config-router)#network 60.154.101.0 0.0.0.255 area 10 R2(config-router)#network 192.168.201.0 0.0.0.255 area 10</pre>
<p>Verification</p>	<p>Run the show vrrp command to verify the configuration.</p>

	<ul style="list-style-type: none"> ● Check whether R1, which acts as the Master, reduces its VRRP priority from 120 to 90 when GigabitEthernet2/1 connected to the Wide Area Network (WAN) is unavailable. If yes, R2 becomes the Master. ● Check whether R1 resumes its VRRP priority from 30 to 120 when GigabitEthernet 2/1 connected to the WAN recovers. If yes, R1 is re-elected as the Master.
<p>R1</p>	<pre> R1#show vrrp GigabitEthernet 0/0 - Group 1 State is Master Virtual IP address is 192.168.201.1 configured Virtual MAC address is 0000.5e00.0101 Advertisement interval is 3 sec Preemption is enabled min delay is 0 sec Priority is 120 Master Router is 192.168.201.217 (local), priority is 120 Master Down interval is 10.59 sec Tracking state of 1 interface, 1 up: up GigabitEthernet 2/1 priority decrement=30 </pre>
<p>R2</p>	<pre> R2#show vrrp GigabitEthernet 0/0 - Group 1 State is Backup Virtual IP address is 192.168.201.1 configured Virtual MAC address is 0000.5e00.0101 Advertisement interval is 3 sec Preemption is enabled min delay is 0 sec Priority is 100 Master Router is 192.168.201.217 , priority is 120 Master Advertisement interval is 3 sec Master Down interval is 10.82 sec </pre>

Common Errors

- Different virtual IP addresses are configured on the routers in a VRRP group, resulting in multiple Master routers in the group.
- Different VRRP advertisement intervals are configured on the routers in a VRRP group and the learning timer is not configured, resulting in multiple Master routers in the group.
- Different VRRP versions are configured on the routers in a VRRP group, resulting in multiple Master routers in the group.

- For VRRPv2, the Ethernet interfaces of the routers in a VRRP group are all in plain text authentication mode but inconsistent in authentication strings, resulting in multiple Master routers in the group.

Configuration Example

Configuring Multiple IPv4 VRRP Groups

<p>Scenario Figure 4-5</p>	
<p>Configuration Steps</p>	<ul style="list-style-type: none"> ● The user workstation cluster (192.168.201.0/24) uses the backup group constituted by the routers R1 and R2. The gateway for partial workstations (A for example) points to the virtual IP address 192.168.201.1 of the backup group 1, while that for other partial workstations (C for example) points to the virtual IP address 192.168.201.2 of the backup group 2. IPv4 multicast routing is enabled on all the routers. ● R1 acts as the master router in the group 2 and as a backup router in the group 1. ● R2 acts as a backup router in the group 2 and as a master router in the group 1.
<p>R3</p>	<pre> R3#configure terminal R3(config)#interface GigabitEthernet 0/0 //The command "no switchport" is only required for a switch. R3(config-if-GigabitEthernet 0/0)#no switchport R3(config-if-GigabitEthernet 0/0)#ip address 192.168.12.217 255.255.255.0 R3(config-if-GigabitEthernet 0/0)#exit R3(config)#interface GigabitEthernet 1/1 //The command "no switchport" is only required for a switch. R3(config-if-GigabitEthernet 1/1)#no switchport </pre>

	<pre> R3(config-if-GigabitEthernet 1/1)#ip address 60.154.101.5 255.255.255.0 R3(config-if-GigabitEthernet 1/1)#exit R3(config)#interface GigabitEthernet 2/1 // The command "no switchport" is only required for a switch. R3(config-if-GigabitEthernet 2/1)#no switchport R3(config-if-GigabitEthernet 2/1)#ip address 202.101.90.61 255.255.255.0 R3(config-if-GigabitEthernet 2/1)#exit R3(config)#router ospf R3(config-router)#network 202.101.90.0 0.0.0.255 area 10 R3(config-router)#network 192.168.12.0 0.0.0.255 area 10 R3(config-router)#network 60.154.101.0 0.0.0.255 area 10 </pre>
R1	<pre> R1#configure terminal R1(config)#interface GigabitEthernet 0/0 R1(config-if-GigabitEthernet 0/0)#ip address 192.168.201.217 255.255.255.0 R1(config-if-GigabitEthernet 0/0)#vrrp 1 timers advertise 3 R1(config-if-GigabitEthernet 0/0)#vrrp 1 ip 192.168.201.1 R1(config-if-GigabitEthernet 0/0)#vrrp 2 priority 120 R1(config-if-GigabitEthernet 0/0)#vrrp 2 timers advertise 3 R1(config-if-GigabitEthernet 0/0)#vrrp 2 ip 192.168.201.2 R1(config-if-GigabitEthernet 0/0)#vrrp 2 track GigabitEthernet 2/1 30 R1(config-if-GigabitEthernet 0/0)#exit R1(config)#interface GigabitEthernet 2/1 R1(config-if-GigabitEthernet 2/1)#ip address 202.101.90.63 255.255.255.0 R1(config-if-GigabitEthernet 2/1)#exit R1(config)#router ospf R1(config-router)#network 202.101.90.0 0.0.0.255 area 10 R1(config-router)#network 192.168.201.0 0.0.0.255 area 10 </pre>
R2	<pre> R2#configure terminal R2(config)#interface GigabitEthernet 0/0 R2(config-if-GigabitEthernet 0/0)#ip address 192.168.201.213 255.255.255.0 R2(config-if-GigabitEthernet 0/0)#vrrp 1 ip 192.168.201.1 R2(config-if-GigabitEthernet 0/0)#vrrp 1 timers advertise 3 R2(config-if-GigabitEthernet 0/0)#vrrp 1 priority 120 </pre>

	<pre>R2(config-if-GigabitEthernet 0/0)#vrrp 2 ip 192.168.201.2 R2(config-if-GigabitEthernet 0/0)#vrrp 2 timers advertise 3 R2(config-if-GigabitEthernet 0/0)#exit R2(config)#interface GigabitEthernet 1/1 R2(config-if-GigabitEthernet 1/1)#ip address 60.154.101.3 255.255.255.0 R2(config-if-GigabitEthernet 1/1)#exit R2(config)#router ospf R2(config-router)#network 60.154.101.0 0.0.0.255 area 10 R2(config-router)#network 192.168.201.0 0.0.0.255 area 10</pre>
<p>Verification</p>	<p>Run the show vrrp command to verify the configuration.</p> <ul style="list-style-type: none"> ● Check whether R1, which acts as a master router in the group 2, reduces its VRRP group priority from 30 to 90 when it finds that the interface GigabitEthernet 2/1 connected to a WAN is unavailable. If yes, R2 in the group 2 becomes a master router. ● Check whether R1 increases its VRRP group priority from 30 to 120 when it finds the interface GigabitEthernet 2/1 connected to a WAN becomes available again. If yes, R1 becomes a master router again in the group 2.
<p>R1</p>	<pre>R1#show vrrp GigabitEthernet 0/0 - Group 1 State is Backup Virtual IP address is 192.168.201.1 configured Virtual MAC address is 0000.5e00.0101 Advertisement interval is 3 sec Preemption is enabled min delay is 0 sec Priority is 100 Master Router is 192.168.201.213 , priority is 120 Master Advertisement interval is 3 sec Master Down interval is 10.82 sec GigabitEthernet 0/0 - Group 2 State is Master Virtual IP address is 192.168.201.2 configured Virtual MAC address is 0000.5e00.0102 Advertisement interval is 3 sec Preemption is enabled min delay is 0 sec</pre>

	<p>Priority is 120</p> <p>Master Router is 192.168.201.217 (local), priority is 120</p> <p>Master Advertisement interval is 3 sec</p> <p>Master Down interval is 10.59 sec</p> <p>Tracking state of 1 interface, 1 up:</p> <p> up GigabitEthernet 2/1 priority decrement=30</p>
<p>R2</p>	<pre>R2#show vrrp GigabitEthernet 0/0 - Group 1 State is Master Virtual IP address is 192.168.201.1 configured Virtual MAC address is 0000.5e00.0101 Advertisement interval is 3 sec Preemption is enabled min delay is 0 sec Priority is 120 Master Router is 192.168.201.213 (local), priority is 120 Master Advertisement interval is 3 sec Master Down interval is 10.59 sec GigabitEthernet 0/0 - Group 2 State is Backup Virtual IP address is 192.168.201.2 configured Virtual MAC address is 0000.5e00.0102 Advertisement interval is 3 sec Preemption is enabled min delay is 0 sec Priority is 100 Master Router is 192.168.201.217 , priority is 120 Master Advertisement interval is 3 sec Master Down interval is 10.82 sec</pre>

4.4.2Configuring IPv6 VRRP

Configuration Effect

- Configure an IPv6 VRRP group on an interface of a specific LAN segment by setting the VRID and virtual IPv6 address.

- Configure multiple IPv6 VRRP groups on an interface to achieve load balance and achieve more stable and reliable network services.
- Configure the VRRP tracked interfaces to monitor real-time failures, change interface priorities and realize master-backup failover dynamically.

Notes

- To achieve VRRP, the routers in a VRRP group should be configured with the same virtual IPv6 address.
- To achieve mutual backup for multiple IPv6 VRRP backup groups, you need to configure multiple IPv6 VRRP groups with identical VRRP configuration on an interface and configure different priorities for them to make routers master and backup mutually.
- VRRP must be enabled on Layer-3 interfaces.

Configuration Steps

↘ Enabling IPv6 VRRP

- By default, IPv6 VRRP is not enabled on an interface. You can enable it based on your demand.

↘ Configuring the IPv6 VRRP Advertisement Interval

- By default, the Master router sends advertisement packets every one second. You can modify the interval based on your demand.

↘ Configuring the IPv6 VRRP Preemption Mode

- By default, a VRRP group operates in Preemption mode with a zero-second delay.

↘ Enabling the Accept Mode for an IPv6 VRRP Group

- By default, the Accept mode is disabled for an IPv6 VRRP group. To require an IPv6 VRRP VRRP group in Master state to receive and process packets with the destination IP address as that of the virtual router, enable Accept mode.

↘ Configuring the IPv6 VRRP Router Priority

- The default router priority for a VRRP group is 100. You can modify the priority based on your demand.

↘ Configuring the IPv6 VRRP Tracked Interface

- By default, no tracked interface is configured. You can modify the interval based on your demand.

↘ Configuring the IPv6 VRRP Tracked IP Address

- By default, no tracked IPv6 address is configured and the value of priority change is 10. You can configure this function based on your demand.

↘ Configures the IPv6 VRRP Learning Timer

- By default, the learning timer is disabled for a VRRP group. Enable this function if the Backup routers need to learn the Master's advertisement interval.

↘ Configuring the IPv6 VRRP Group Description

- By default, no description is configured for a VRRP group. To distinguish VRRP groups clearly, configure descriptions.

✚ Configuring the IPv4 VRRP Delay

- By default, the IPv4 VRRP delay is not configured. To guarantee an effective non-preemption mode, configure the delay.

Verification

- Run the **show vrrp** command to verify the configuration.

Related Commands

✚ Enabling IPv6 VRRP

Command	vrrp group ipv6 <i>ipv6-address</i>
Parameter	<i>group</i> : Indicates the VRID of a VRRP group, the range of which varies with product models.
Description	<i>ipv6-address</i> : Indicates the IPv6 address of a VRRP group.
Command Mode	Interface configuration mode
Usage Guide	IPv6 VRRP groups and IPv4 VRRP groups share a VRID range from 1 to 255. One VRID is applicable to an IPv4 VRRP group and an IPv6 VRRP group at the same time. The first configured address should be a link-local address, which can be deleted only after other virtual addresses.

✚ Configuring the IPv6 VRRP Advertisement Interval

Command	vrrp ipv6 group timers advertise { <i>advertise-interval</i> csec <i>centisecond-interval</i> }
Parameter	<i>group</i> : Indicates the VRID of a VRRP group.
Description	<i>advertise-interval</i> : Indicates the advertisement interval of a VRRP group (unit: second). csec centisecond-interval : An interval for a master router in a backup group to send VRRP packets. It is an integer from 50 to 99. The unit is centisecond. No default value is provided. The command is only effective for VRRPv3 packets. If it is configured for VRRPv2 packets, the default interval is one second.
Command Mode	Interface configuration mode
Usage Guide	If a router is elected as the Master in a VRRP group, it sends VRRP advertisement packets at the set interval to announce its VRRP state, priority and other information. According to the RFC standards, if an IPv6 VRRP group adopts VRRPv3 for sending multicast packets, the maximum advertisement interval is 40 seconds. Therefore, if the interval is set longer than 40 seconds, this maximum interval will be applied, though the configuration is effective.

✚ Configuring the Preemption Mode

Command	vrrp ipv6 group preempt [delay <i>seconds</i>]
Parameter	<i>group</i> : Indicates the VRID of a VRRP group.
Description	delay seconds : Indicates the preemption delay for the Master router to claim its status. The default value is 0 second.
Command Mode	Interface configuration mode
Usage Guide	If a VRRP group runs in Preemption mode, a higher priority router will take the place of the lower priority Master. If a VRRP group runs in Non-preemption mode, a router with the priority higher than that of the Master remains Backup. It makes little sense to configure the Preemption mode when the VRRP group uses the IP address of an Ethernet interface, in which case the group has the highest priority and automatically becomes the Master in the group.

✚ Enabling the Accept Mode for an IPv6 VRRP Group

Command	vrrp ipv6 group accept_mode
Parameter	<i>group</i> : Indicates the VRID of a VRRP group.
Description	
Command Mode	Interface configuration mode
Usage Guide	By default, an IPv6 VRRP group in Master state is not permitted to receive packets with the destination IPv6 address as that of the VRRP group. However, it receives NA and NS packets no matter whether Accept mode is configured. Besides, the IP Address Owner in Master state receives and processes the packets with the destination IPv6 address as that of the VRRP group no matter whether Accept mode is configured or not.

✚ Configuring the IPv6 VRRP Router Priority

Command	vrrp ipv6 group priority level
Parameter	<i>group</i> : Indicates the VRID of a VRRP group.
Description	<i>level</i> : Indicates the priority of a VRRP router.
Command Mode	Interface configuration mode
Usage Guide	This command is used to manually configure the VRRP router priority.

✚ Configuring the IPv6 VRRP Tracked Interface

Command	vrrp ipv6 group track interface-type interface-number [priority]
Parameter	<i>group</i> : Indicates the VRID of a VRRP group.
Description	<i>interface-type interface-number</i> : Indicates the interface to be tracked. <i>priority</i> : Indicates the scale of VRRP priority change when the state of a monitored interface changes. The default value is 10.
Command Mode	Interface configuration mode
Usage Guide	A tracked interface must be a routable Layer-3 logic interface (for example, a Routed port, an SVI interface, a Loopback interface, or a Tunnel interface). The priority of the router owns the virtual IP address associated with a VRRP group must be 255, and no tracked interface can be configured on it.

✚ Configuring the IPv6 VRRP Tracked IP Address

Command	vrrp ipv6 group track { ipv6-global-address ipv6-linklocal-address interface-type interface-number } [interval interval-value] [timeout timeout-value] [retry retry-value] [priority]
Parameter	<i>group</i> : Indicates the VRID of a VRRP group.
Description	<i>ipv6-global-address</i> : Indicates the IPv6 global unicast address. <i>ipv6-linklocal-address</i> : Indicates the IPv6 link-local address. <i>interface-type interface-number</i> : Indicates the interface to be tracked. interval interval-value : Indicates the probe interval. The unit is second. Unless configured manually, the value is 3 seconds by default. timeout timeout-value : Indicates the probe timeout of waiting for responses. If no response is received when the timeout is up, it is regarded that the destination is inaccessible. The unit is second. Unless configured manually, the

	<p>value is 1 second by default.</p> <p>retry <i>retry-value</i>: Indicates the probe retries. If the probe packet is sent continually for <i>retry-value</i> times but no response is received, it is regarded that the destination is inaccessible. The unit is times. Unless configured, the value is 3 times by default.</p> <p><i>priority</i>: Indicates the scale of VRRP priority change when the state of a monitored interface changes. The default value is 10.</p>
Command	Interface configuration mode
Mode	
Usage Guide	<p>To monitor a host, specify its IPv6 address for an IPv6 VRRP group.</p> <p>If the host IP address being tracked is a link-local address, specify a network interface.</p> <p>If a VRRP group owns the actual IP address of an Ethernet interface, the group priority is 255, and no monitored IP address can be configured.</p>

↘ **Configures the IPv6 VRRP Learning Timer**

Command	vrrp ipv6 group timers learn
Parameter	<i>group</i> : Indicates the VRID of a VRRP group.
Description	
Command	Interface configuration mode
Mode	
Usage Guide	Once the learning timer is enabled on a VRRP router, a Backup router learns the advertisement interval of the Master during the timer. Based on this, the Backup router calculates the interval for determining the Master router as failed instead of using the locally configured advertisement interval. This command achieves synchronization with the learning timer between the Master and Backup routers.

↘ **Configuring the IPv6 VRRP Group Description**

Command	vrrp ipv6 group description text
Parameter	<i>group</i> : Indicates the VRID of a VRRP group.
Description	<i>text</i> : Indicates the description of a VRRP group.
Command	Interface configuration mode
Mode	
Usage Guide	A VRRP description helps distinguishing VRRP groups. A description has 80 bytes at most, otherwise wrong configuration is prompted.

↘ **Configuring the IPv4 VRRP Delay**

Command	vrrp delay { minimum <i>min-seconds</i> reload <i>reload-seconds</i> }
Parameter	minimum <i>min-seconds</i> : Indicates the VRRP delay after an interface state changes.
Description	reload <i>reload-seconds</i> : Indicates the VRRP delay after the system starts.
Command	Interface configuration mode
Mode	
Usage Guide	After the delay is configured for a VRRP group on an interface, the VRRP group starts after the delay instead of immediately upon system startup or the interface's resumption, ensuring non-preemption. If the interface receives a VRRP packet during the delay, the delay will be canceled and the VRRP will be started immediately. The two types of delay share a value range of 0 to 60 seconds. This configuration will be effective for both IPv4 and IPv6 VRRP groups of an interface.

Configuration Example

▾ **Configuring an IPv6 VRRP Group and Tracked Interface**

<p>Scenario Figure 4-6</p>	
<p>Configuration Steps</p>	<ul style="list-style-type: none"> ● Host A and Host B access the Internet resources through the default gateway 2000::1/64. ● FS A and FS B belong to the IPv6 VRRP group 1, and their virtual addresses are 2000::1/64 and FE80::1 respectively. ● FS A tracks the interface GigabitEthernet 0/2 connected to the Internet. When GigabitEthernet 0/2 is unavailable, FS A reduces its priority and FS B acts as a gateway.
<p>FSA</p>	<pre> FSA#configure terminal FSA(config)#interface GigabitEthernet 0/1 FSA(config-if-GigabitEthernet 0/1)#no switchport FSA(config-if-GigabitEthernet 0/1)#ipv6 address 2000::2/64 FSA(config-if-GigabitEthernet 0/1)#vrrp 1 ipv6 FE80::1 FSA(config-if-GigabitEthernet 0/1)#vrrp 1 ipv6 2000::1 FSA(config-if-GigabitEthernet 0/1)#vrrp ipv6 1 priority 120 FSA(config-if-GigabitEthernet 0/1)#vrrp ipv6 1 timers advertise 3 FSA(config-if-GigabitEthernet 0/1)#vrrp ipv6 1 track GigabitEthernet 0/2 50 FSA(config-if-GigabitEthernet 0/1)#vrrp ipv6 1 accept_mode </pre>
<p>FSB</p>	<pre> FSB#configure terminal FSB(config)#interface GigabitEthernet 0/1 FSB(config-if-GigabitEthernet 0/1)#no switchport FSB(config-if-GigabitEthernet 0/1)#ipv6 address 2000::3/64 FSB(config-if-GigabitEthernet 0/1)#vrrp 1 ipv6 FE80::1 FSB(config-if-GigabitEthernet 0/1)#vrrp 1 ipv6 2000::1 FSB(config-if-GigabitEthernet 0/1)#vrrp ipv6 1 priority 100 FSB(config-if-GigabitEthernet 0/1)#vrrp ipv6 1 timers advertise 3 FSB(config-if-GigabitEthernet 0/1)#vrrp ipv6 1 accept_mode </pre>

<p>Verification</p>	<p>Run the show vrrp command to verify the configuration.</p> <ul style="list-style-type: none"> ● Check whether FS A, which acts as the Master router, reduces its VRRP group priority from 120 to 70 when it finds that the interface GigabitEthernet 0/2 connected to WAN is unavailable. If yes, FS B becomes the Master. ● Check whether FS A increases its VRRP group priority from 50 to 120 when it finds the interface GigabitEthernet 0/2 connected to WAN becomes available again. If yes, FS A becomes the Master again.
<p>FSA</p>	<pre> FSA#show ipv6 vrrp 1 GigabitEthernet 0/1 - Group 1 State is Master Virtual IPv6 address is as follows: FE80::1 2000::1 Virtual MAC address is 0000.5e00.0201 Advertisement interval is 3 sec Accept_Mode is enabled Preemption is enabled min delay is 0 sec Priority is 120 Master Router is FE80::1234 (local), priority is 120 Master Advertisement interval is 3 sec Master Down interval is 10.59 sec Tracking state of 1 interface, 1 up: up GigabitEthernet 0/2 priority decrement=50 </pre>
<p>FSB</p>	<pre> FSB#show ipv6 vrrp 1 GigabitEthernet 0/1 - Group 1 State is Backup Virtual IPv6 address is as follow: FE80::1 2000::1 Virtual MAC address is 0000.5e00.0201 Advertisement interval is 3 sec Accept_Mode is enabled Preemption is enabled min delay is 0 sec Priority is 100 </pre>

<p>Master Router is FE80::1234, priority is 120</p> <p>Master Advertisement interval is 3 sec</p> <p>Master Down interval is 10.82 sec</p>
--

Configuration Example

Multiple VRRP Backup Groups (under IPv6)

<p>Scenario Figure 4-7</p>	
<p>Configuration Steps</p>	<ul style="list-style-type: none"> Host A and Host B access the Internet resources through the gateways 2000::1/64 and 2000::100/64 respectively. FS A and FS B belong to the IPv6 VRRP group 1, and their virtual addresses are 2000::1/64 and FE80::1 respectively. FS A and FS B belong to the backup group 2 of a virtual IPv6 router, and their virtual addresses are 2000::100/64 and FE80::100 respectively. FS A and FS B act as gateways and forward flows, being a backup router to each other.
<p>FSA</p>	<pre> FSA#configure terminal FSA(config)#interface GigabitEthernet 0/1 FSA(config-if-GigabitEthernet 0/1)#no switchport FSA(config-if-GigabitEthernet 0/1)#ipv6 address 2000::2/64 FSA(config-if-GigabitEthernet 0/1)#vrrp 1 ipv6 FE80::1 FSA(config-if-GigabitEthernet 0/1)#vrrp 1 ipv6 2000::1 FSA(config-if-GigabitEthernet 0/1)#vrrp ipv6 1 priority 120 FSA(config-if-GigabitEthernet 0/1)#vrrp ipv6 1 timers advertise 3 FSA(config-if-GigabitEthernet 0/1)#vrrp ipv6 1 accept_mode FSA(config-if-GigabitEthernet 0/1)#vrrp 2 ipv6 FE80::100 FSA(config-if-GigabitEthernet 0/1)# vrrp 2 ipv6 2000::100 FSA(config-if-GigabitEthernet 0/1)#vrrp ipv6 2 priority 100 </pre>

	<pre>FSA(config-if-GigabitEthernet 0/1)#vrrp ipv6 2 timers advertise 3 FSA(config-if-GigabitEthernet 0/1)#vrrp ipv6 2 accept_mode</pre>
<p>FSB</p>	<pre>FSB#configure terminal FSB(config)#interface GigabitEthernet 0/1 FSB(config-if-GigabitEthernet 0/1)#no switchport FSB(config-if-GigabitEthernet 0/1)#ipv6 address 2000::3/64 FSB(config-if-GigabitEthernet 0/1)#vrrp 1 ipv6 FE80::1 FSB(config-if-GigabitEthernet 0/1)#vrrp 1 ipv6 2000::1 FSB(config-if-GigabitEthernet 0/1)#vrrp ipv6 1 priority 100 FSB(config-if-GigabitEthernet 0/1)#vrrp ipv6 1 timers advertise 3 FSB(config-if-GigabitEthernet 0/1)#vrrp ipv6 1 accept_mode FSB(config-if-GigabitEthernet 0/1)#vrrp 2 ipv6 FE80::100 FSB(config-if-GigabitEthernet 0/1)# vrrp 2 ipv6 2000::100 FSB(config-if-GigabitEthernet 0/1)#vrrp ipv6 2 priority 120 FSB(config-if-GigabitEthernet 0/1)#vrrp ipv6 2 timers advertise 3 FSB(config-if-GigabitEthernet 0/1)#vrrp ipv6 2 accept_mode</pre>
<p>Verification</p>	<p>Run the show vrrp command to verify the configuration.</p>
<p>FSA</p>	<pre>FSA#show ipv6 vrrp GigabitEthernet 0/1 - Group 1 State is Master Virtual IPv6 address is as follows: FE80::1 2000::1 Virtual MAC address is 0000.5e00.0201 Advertisement interval is 3 sec Accept_Mode is enabled Preemption is enabled min delay is 0 sec Priority is 120 Master Router is FE80::1234 (local), priority is 120 Master Advertisement interval is 3 sec Master Down interval is 10.59 sec GigabitEthernet 0/1 - Group 2</pre>

	<p>State is Backup</p> <p>Virtual IPv6 address is as follows:</p> <p style="padding-left: 20px;">FE80::100</p> <p style="padding-left: 20px;">2000::100</p> <p>Virtual MAC address is 0000.5e00.0202</p> <p>Advertisement interval is 3 sec</p> <p>Accept_Mode is enabled</p> <p>Preemption is enabled</p> <p style="padding-left: 20px;">min delay is 0 sec</p> <p>Priority is 100</p> <p>Master Router is FE80::5678, priority is 120</p> <p>Master Advertisement interval is 3 sec</p> <p>Master Down interval is 10.82 sec</p>
<p>FSB</p>	<pre>FSB#show ipv6 vrrp GigabitEthernet 0/1 - Group 1 State is Backup Virtual IPv6 address is as follow: FE80::1 2000::1 Virtual MAC address is 0000.5e00.0201 Advertisement interval is 3 sec Accept_Mode is enabled Preemption is enabled min delay is 0 sec Priority is 100 Master Router is FE80::1234, priority is 120 Master Advertisement interval is 3 sec Master Down interval is 10.82 sec GigabitEthernet 0/1 - Group 2 State is Master Virtual IPv6 address is as follows: FE80::100 2000::100 Virtual MAC address is 0000.5e00.0202</pre>

```

Advertisement interval is 3 sec
Accept_Mode is enabled
Preemption is enabled
    min delay is 0 sec
Priority is 120
Master Router is FE80::5678(local), priority is 120
Master Advertisement interval is 3 sec
Master Down interval is 10.59 sec

```

4.4.3 Configuring VRRP-MSTP

Configuration Effect

- Link-level and gateway-level backup are achieved and network robustness is improved greatly when MSTP and VRRP are applied simultaneously.

Notes

- configure the routers in a VRRP backup group with the same virtual IPv4 address.
- Enabled VRRP on a Layer 3 interface.

Configuration Steps

▾ Enabling IPv4 VRRP

- By default, IPv4 VRRP is not enabled on an interface. To enable IPv4 VRRP, please configure this item.

▾ Configuring the IPv4 VRRP Authentication String

- By default, VRRP is in a non-authentication mode. To enable plain text password authentication for VRRP, please configure this item.

▾ Configuring the IPv4 VRRP Advertisement Interval

- By default, a master router sends VRRP GWADV packets at an interface of one second. To manually set a value, please configure this item.

▾ Configuring the IPv4 VRRP Preemption Mode

- By default, VRRP groups work in the preemption mode with zero-second delay.

▾ Configuring the IPv4 VRRP Router Priority

- The default router priority for a VRRP group is 100. You can modify the priority based on your demand.

▾ Configuring the IPv4 VRRP Tracked Interface

- By default, an IPv4 VRRP group monitors no interface. To achieve fault monitoring through monitoring an interface, please configure this item.

▾ Configuring the IPv4 VRRP Learning Timer

- By default, timed learning is not enabled for a VRRP backup group. To enable backup routers to learn the VRRP GWADV packets from a master router, please configure this item.

↘ **Configuring the IPv4 VRRP Group Description**

- By default, no description is configured for a VRRP group. To distinguish VRRP groups conveniently, please configure this item.

↘ **Configuring the IPv4 VRRP Delay**

- By default, the VRRP delay for a VRRP group is not configured. Configure the delay to guarantee a stable transition from Non-preemption mode to Preemption mode.

↘ **Configuring the IPv4 VRRP Version**

- By default, the VRRPv2 standard is adopted for IPv4 VRRP packets. To modify it manually, please configure this item.

↘ **Specifying a Sub VLAN of a Super VLAN to Receive the IPv4 VRRP Packets**

- By default, IPv4 VRRP packets are only sent to the first UP Sub VLAN interface in a Super VLAN, but you may configure a specific Sub VLAN interface to send such packets.

↘ **Configuring the BFD Support for IPv4 VRRP on an Interface**

- By default, the linkage between an IPv4 VRRP and BFD is not configured on an interface. To enable such linkage, please configure this item.

↘ **Configuring Global IPv4 VRRP BFD**

- By default, global IPv4 VRRP BFD is not used to detect whether a master router is active. To enable this, please configure this item.

Verification

- Run the **show vrrp** command to verify the configuration.

Related Commands

↘ **Enabling IPv4 VRRP**

Command	vrrp group ip <i>ipaddress</i> [secondary]
Parameter	<i>group</i> : Indicates the VRID of a VRRP group, the range of which varies with product models.
Description	<i>ipaddress</i> : The IP address of a VRRP group. secondary : Indicates the secondary IP address of a VRRP group.
Command Mode	Interface configuration mode
Usage Guide	If no virtual IP address is specified, routers cannot join a VRRP group. If no secondary IP address is applied, the configured IP address will be the primary IP address of a VRRP group.

↘ **Configuring the IPv4 VRRP Authentication String**

Command	vrrp group authentication <i>string</i>
Parameter	<i>group</i> : Indicates the VRID of a VRRP group.
Description	<i>string</i> : Indicates the authentication string of a VRRP group (a plain text password consists of 8 bytes at most).

Command Mode	Interface configuration mode
Usage Guide	<p>In a VRRP group, the same authentication password should be configured for routers. The plain text authentication password cannot guarantee security but only prevents/prompts wrong VRRP configurations. This command is only applicable to VRRPv2 instead of VRRPv3.</p> <p>Authentication is abolished for VRRPv3 packets. If VRRPv2 is chosen for an IPv4 VRRP group, the command is effective; if VRRPv3 is chosen, the command is ineffective.</p>

📌 Configuring the IPv4 VRRP Advertisement Interval

Command	vrrp group timers advertise { <i>advertise-interval</i> csec <i>centisecond-interval</i> }
Parameter Description	<p><i>group</i>: Indicates the VRID of a VRRP group.</p> <p><i>advertise-interval</i>: Indicates the advertisement interval of a VRRP group (unit: second).</p> <p>csec <i>centisecond-interval</i>: An interval for a master router in a backup group to send VRRP packets. It is an integer from 50 to 99. The unit is centisecond. No default value is provided. The command is only effective for VRRPv3 packets. If it is configured for VRRPv2 packets, the default interval is one second.</p>
Command Mode	Interface configuration mode
Usage Guide	<p>If a router is elected as the Master in a VRRP group, it sends VRRP advertisement packets at the set interval to announce its VRRP state, priority and other information.</p> <p>According to the RFC standards, if an IPv4 VRRP group adopts VRRPv3 for sending multicast packets, the maximum advertisement interval is 40 seconds. Therefore, if the interval is set longer than 40 seconds, this maximum interval will be applied, though the configuration is effective.</p>

📌 Configuring the IPv4 VRRP Preemption Mode

Command	vrrp group preempt [delay <i>seconds</i>]
Parameter Description	<p><i>group</i>: Indicates the VRID of a VRRP group.</p> <p>delay <i>seconds</i>: Indicates the preemption delay for the Master router to claim its status. The default value is 0 second.</p>
Command Mode	Interface configuration mode
Usage Guide	<p>If a VRRP group runs in Preemption mode, a higher priority router will take the place of the lower priority Master. If a VRRP group runs in Non-preemption mode, a router with the priority higher than that of the Master remains Backup. It makes little sense to configure the Preemption mode when the VRRP group uses the IP address of an Ethernet interface, in which case the group has the highest priority and automatically becomes the Master in the group.</p>

📌 Configuring the IPv4 VRRP Router Priority

Command	vrrp <i>group</i> priority <i>level</i>
Parameter Description	<p><i>group</i>: Indicates the VRID of a VRRP group.</p> <p><i>level</i>: Indicates the priority of an interface in a VRRP group.</p>
Command Mode	Interface configuration mode
Usage Guide	This command is used to manually configure the priority of a VRRP group.

📌 Configuring the IPv4 VRRP Tracked Interface

Command	vrrp group track { <i>interface-type interface-number</i> bfd <i>interface-type interface-number ipv4-address</i> } [<i>priority</i>]
Parameter	<i>group</i> : Indicates the VRID of a VRRP group.
Description	<i>interface-type interface-number</i> : Indicates the interface to be tracked. bfd <i>interface-type interface-number ipv4-address</i> : A specified adjacent IP address tracked through BFD. <i>priority</i> : Indicates the scale of VRRP priority change when the state of a monitored interface changes. The default value is 10.
Command Mode	Interface configuration mode
Usage Guide	A tracked interface must be a routable Layer-3 logic interface (for example, a Routed port, an SVI interface, a Loopback interface, or a Tunnel interface). The priority of the router owns the virtual IP address associated with a VRRP group must be 255, and no tracked interface can be configured on it.

📌 Configuring the IPv4 VRRP Tracked IP Address

Command	vrrp group track <i>ipv4-address</i> [interval <i>interval-value</i>] [timeout <i>timeout-value</i>] [retry <i>retry-value</i>] [<i>priority</i>]
Parameter	<i>group</i> : Indicates the VRID of a VRRP group.
Description	<i>ipv4-address</i> : Indicates the IPv4 address to be tracked. interval <i>interval-value</i> : Indicates the probe interval. The unit is second. Unless configured manually, the value is 3 seconds by default. timeout <i>timeout-value</i> : Indicates the probe timeout of waiting for responses. If no response is received when the timeout is up, it is regarded that the destination is inaccessible. The unit is second. Unless configured manually, the value is 1 second by default. retry <i>retry-value</i> : Indicates the probe retries. If the probe packet is sent continually for <i>retry-value</i> times but no response is received, it is regarded that the destination is inaccessible. The unit is times. Unless configured, the value is 3 times by default. <i>priority</i> : Indicates the scale of VRRP priority change when the state of a monitored interface changes. The default value is 10.
Command Mode	Interface configuration mode
Usage Guide	To monitor a host, specify its IPv4 address for an IPv4 VRRP group. If a VRRP group owns the actual IP address of an Ethernet interface, the group priority is 255, and no monitored IP address can be configured.

📌 Configuring the IPv4 VRRP Learning Timer

Command	vrrp group timers learn
Parameter	<i>group</i> : Indicates the VRID of a VRRP group.
Description	
Command Mode	Interface configuration mode
Usage Guide	Once the learning timer is enabled on a VRRP router, a Backup router learns the advertisement interval of the Master during the timer. Based on this, the Backup router calculates the interval for determining the Master router as failed instead of using the locally configured advertisement interval. This command achieves synchronization with the learning timer between the Master and Backup routers.

▾ Configuring the IPv4 VRRP Group Description

Command	vrrp group description text
Parameter	<i>group</i> : Indicates the VRID of a VRRP group.
Description	<i>text</i> : Indicates the description of a VRRP group.
Command Mode	Interface configuration mode
Usage Guide	A VRRP description helps distinguishing VRRP groups. A description has 80 bytes at most, otherwise wrong configuration is prompted.

▾ Configuring the IPv4 VRRP Delay

Command	vrrp delay { minimum <i>min-seconds</i> reload <i>reload-seconds</i> }
Parameter	minimum <i>min-seconds</i> : Indicates the VRRP delay after an interface state changes.
Description	reload <i>reload-seconds</i> : Indicates the VRRP delay after the system starts.
Command Mode	Interface configuration mode
Usage Guide	After the delay is configured for a VRRP group on an interface, the VRRP group starts after the delay instead of immediately upon system startup or the interface's resumption, ensuring non-preemption. If the interface receives a VRRP packet during the delay, the delay will be canceled and the VRRP will be started immediately. The two types of delay share a value range of 0 to 60 seconds. This configuration will be effective for both IPv4 and IPv6 VRRP groups of an interface.

▾ Configuring the IPv4 VRRP Version

Command	vrrp group version { 2 3 }
Parameter	2 : Indicates VRRPv2.
Description	3 : Indicates VRRPv3.
Command Mode	Interface configuration mode
Usage Guide	Considering the compatibility between VRRPv2 and VRRPv3, specify a standard for IPv4 VRRP based on the actual network condition. VRRPv2 is developed in RFC3768, while VRRPv3 is described in RFC5798. This command is only applicable to IPv4 VRRP.

▾ Specifying a Sub VLAN of a Super VLAN to Receive the IPv4 VRRP Packets

Command	vrrp detection-vlan {first-subvlan <i>subvlan-id</i>}
Parameter	first-subvlan : Sends IPv4 VRRP packets only to the first UP Sub VLAN interface in a Super VLAN.
Description	<i>subvlan-id</i> : Sends IPv4 VRRP packets to a specified Sub VLAN.
Command Mode	Interface configuration mode
Usage Guide	This command is used to specify a Sub VLAN of a Super VLAN to receive the IPv4 VRRP packets. IPv4 VRRP packets are sent in a Super VLAN using the following three methods. Packets are sent to the first UP Sub VLAN interface in a Super VLAN, or to a specified Sub VLAN interface in a Super VLAN, or to all the Sub VLAN interfaces in a Super VLAN. If both VRRP and VRRP PLUS are enabled on a Super VLAN interface, VRRP packets are sent to all the UP Sub VLAN interfaces of the Super VLAN interface. This command is configured on a VLAN interface and effective only to Super VLAN interfaces.

➤ **Configuring the BFD Support for IPv4 VRRP on an Interface**

Command	<code>vrrp group bfd ip-address</code>
Parameter	<i>group</i> : Indicates the VRID of a VRRP group.
Description	<i>ip-address</i> : Indicates the interface IP address.
Command Mode	Interface configuration mode
Usage Guide	<p>For a Backup router, run this command to correlate an IPv4 VRRP group with BFD without caring the configured IP address. For the Master, as the primary IP address of a Backup router is not known, the router IP address can only be specified by the administrator.</p> <p>If global IPv4 VRRP BFD is configured, this configuration cannot be performed.</p> <p>To enable the BFD support, make sure that IP and BFD session parameters are configured on the target interface.</p>

➤ **Configuring Global IPv4 VRRP BFD**

Command	<code>vrrp bfd interface-type interface-number ip-address</code>
Parameter	<i>interface-type interface-number</i> : Indicates interface type and ID.
Description	<i>ip-address</i> : Indicates the interface IP address.
Command Mode	Global configuration mode
Usage Guide	<p>If global IPv4 VRRP BFD is configured, the configured BFD support will be deleted.</p> <p>To enable the BFD support, make sure that IP and BFD session parameters are configured on the target interface.</p> <p>A global IPv4 VRRP BFD session is only applicable to an IPv4 VRRP group consisting of two routers.</p>

Configuration Example

➤ **Configuring VRRP+MSTP**

<p>Scenario Figure 4-8</p>	
<p>Configuration Steps</p>	<ul style="list-style-type: none"> ● Enable MSTP on routers (switches A, B, C, D, E and F in this example). Configure VLAN-Instance mapping (mapping VLAN 10 and VLAN 20 to Instance 1, VLAN 30 and VLAN 40 to Instance 2, and the rest VLANs to Instance 0), and configure gateways (Switch A and Switch B in this example) as the root bridges of corresponding instances. ● Add the SVIs of all VLANs to corresponding VRRP backup groups, and configure gateways as the master and

backup routers for corresponding backup groups See configuration details in the following table.

Gateway	VLAN ID	SVI	Backup Group	Virtual IP Address	State
Switch A	10	192.168.10.2	VRRP 10	192.168.10.1	Master
Switch B		192.168.10.3			Backup
Switch A	20	192.168.20.2	VRRP 20	192.168.20.1	Master
Switch B		192.168.20.3			Backup
Switch A	30	192.168.30.2	VRRP 30	192.168.30.1	Backup
Switch B		192.168.30.3			Master
Switch A	40	192.168.40.2	VRRP 40	192.168.40.1	Backup
Switch B		192.168.40.3			Master

- Configure the uplink port (port Gi 0/1 of Switch A and Switch B) of master routers as a monitored interface of master router.
- Step 1: Create VLAN. Create VLAN 10, VLAN 20, VLAN 30 and VLAN 40 respectively on Switch A and Switch B.
- Step 2: Configure MST regions. Map VLAN 10 and VLAN 20 to Instance 1, VLAN 30 and VLAN 40 to Instance 2, and the rest VLANs to Instance 0.
- Step 3: Configure Switch A as the root bridge for MST 0 and MST 1, and Switch B as the root bridge for MST 2.
- Step 4: Enable MSTP.
- Step 5: Configure SVIs of all the VLANs, add the SVIs to corresponding backup groups, and configure virtual IP addresses for the groups. See configuration in the above table.
- Step 6: Configure master routers and backup routers for all the groups.
- Step 7: Configure the uplink ports of master routers as monitored ports of VRRP groups. Caution: Monitored ports should be Layer 3 ports.

Step 8: Configure the Internet interfaces of the core routers as AP interfaces.

SwitchA

```
//Create VLAN 10, VLAN 20, VLAN 30 and VLAN 40 on Switch A.
SwitchA#configure terminal
Enter configuration commands, one per line. End with CNTL/Z.
SwitchA(config)#vlan range 10,20,30,40
SwitchA(config-vlan-range)#exit
//Map VLAN 10 and VLAN 20 to Instance 1, VLAN 30 and VLAN 40 to Instance 2, and the rest VLANs to Instance 0.
SwitchA(config)#spanning-tree mst configuration
SwitchA(config-mst)#instance 1 vlan 10,20
%Warning:you must create vlans before configuring instance-vlan relationship
SwitchA(config-mst)#instance 2 vlan 30,40
%Warning:you must create vlans before configuring instance-vlan relationship
```

```
SwitchA(config-mst)#exit
//On Switch A, configure the priority of MST 0 and MST 1 as 4096, and that of MST 2 as 8192.
SwitchA(config)#spanning-tree mst 0 priority 4096
SwitchA(config)#spanning-tree mst 1 priority 4096
SwitchA(config)#spanning-tree mst 2 priority 8192
//Enabling MSTP
SwitchA(config)#spanning-tree
Enable spanning-tree.
//Configure SVIs of all the VLANs, add the SVIs to corresponding backup groups, and configure virtual IP addresses
for the groups.
SwitchA(config)#interface vlan 10
SwitchA(config-if-VLAN 10)#ip address 192.168.10.2 255.255.255.0
SwitchA(config-if-VLAN 10)#vrrp 10 ip 192.168.10.1
SwitchA(config-if-VLAN 10)#exit
SwitchA(config)#interface vlan 20
SwitchA(config-if-VLAN 20)#ip address 192.168.20.2 255.255.255.0
SwitchA(config-if-VLAN 20)#vrrp 20 ip 192.168.20.1
SwitchA(config-if-VLAN 20)#exit
SwitchA(config)#interface vlan 30
SwitchA(config-if-VLAN 30)#ip address 192.168.30.2 255.255.255.0
SwitchA(config-if-VLAN 30)#vrrp 30 ip 192.168.30.1
SwitchA(config-if-VLAN 30)#exit
SwitchA(config)#interface vlan 40
SwitchA(config-if-VLAN 40)#ip address 192.168.40.2 255.255.255.0
SwitchA(config-if-VLAN 40)#vrrp 40 ip 192.168.40.1
SwitchA(config-if-VLAN 40)#exit
//Increase the priority of the VRRP 10 and VRRP 20 of Switch A to 120.
SwitchA(config)#interface vlan 10
SwitchA(config-if-VLAN 10)#vrrp 10 priority 120
SwitchA(config-if-VLAN 10)#exit
SwitchA(config)#interface vlan 20
SwitchA(config-if-VLAN 20)#vrrp 20 priority 120
SwitchA(config-if-VLAN 20)#exit
//Configure the Gi 0/1 port of Switch A as Route Port and its IP address as 10.10.1.1/24.
```

	<pre> SwitchA(config)#interface gigabitEthernet 0/1 SwitchA(config-if-GigabitEthernet 0/1)#no switchport SwitchA(config-if-GigabitEthernet 0/1)#ip address 10.10.1.1 255.255.255.0 SwitchA(config-if-GigabitEthernet 0/1)#exit //Configure the Gi 0/1 port of Switch A as a monitored port for VRRP 10 and VRRP 20, and a Priority decrement of 30. SwitchA(config)#interface vlan 10 SwitchA(config-if-VLAN 10)#vrrp 10 track gigabitEthernet 0/1 30 SwitchA(config-if-VLAN 10)#exit SwitchA(config)#interface vlan 20 SwitchA(config-if-VLAN 20)#vrrp 20 track gigabitEthernet 0/1 30 SwitchA(config-if-VLAN 20)#exit //Configure ports Gi 0/2 and Gi 0/3 as AP ports, which are Trunk ports. SwitchA#configure terminal Enter configuration commands, one per line. End with CNTL/Z. SwitchA(config)#interface range gigabitEthernet 0/2-3 SwitchA(config-if-range)#port-group 1 SwitchA(config)#interface aggregateport 1 SwitchA(config-if-AggregatePort 1)#switchport mode trunk </pre>
SwitchB	<pre> //Create VLAN 10, VLAN 20, VLAN 30 and VLAN 40 on Switch B. SwitchB#configure terminal Enter configuration commands, one per line. End with CNTL/Z. SwitchB(config)#vlan range 10,20,30,40 SwitchB(config-vlan-range)#exit //Map VLAN 10 and VLAN 20 to Instance 1, VLAN 30 and VLAN 40 to Instance 2, and the rest VLANs to Instance 0. SwitchB(config)#spanning-tree mst configuration SwitchB(config-mst)#instance 1 vlan 10,20 %Warning:you must create vlans before configuring instance-vlan relationship SwitchB(config-mst)#instance 2 vlan 30,40 %Warning:you must create vlans before configuring instance-vlan relationship SwitchB(config-mst)#exit //On Switch B, configure the priority of MST 2 as 4096, and that of MST 0 and MST 1 as 8192. SwitchB(config)#spanning-tree mst 2 priority 4096 SwitchB(config)#spanning-tree mst 0 priority 8192 SwitchB(config)#spanning-tree mst 1 priority 8192 </pre>

```
//Enabling MSTP

SwitchB(config)#spanning-tree

Enable spanning-tree.

//Configure SVIs of all the VLANs, add the SVIs to corresponding backup groups, and configure virtual IP addresses
for the groups.

SwitchB(config)#interface vlan 10

SwitchB(config-if-VLAN 10)#ip address 192.168.10.3 255.255.255.0

SwitchB(config-if-VLAN 10)#vrrp 10 ip 192.168.10.1

SwitchB(config-if-VLAN 10)#exit

SwitchB(config)#interface vlan 20

SwitchB(config-if-VLAN 20)#ip address 192.168.20.3 255.255.255.0

SwitchB(config-if-VLAN 20)#vrrp 20 ip 192.168.20.1

SwitchB(config-if-VLAN 20)#exit

SwitchB(config)#interface vlan 30

SwitchB(config-if-VLAN 30)#ip address 192.168.30.3 255.255.255.0

SwitchB(config-if-VLAN 30)#vrrp 30 ip 192.168.30.1

SwitchB(config-if-VLAN 30)#exit

SwitchB(config)#interface vlan 40

SwitchB(config-if-VLAN 40)#ip address 192.168.40.3 255.255.255.0

SwitchB(config-if-VLAN 40)#vrrp 40 ip 192.168.40.1

SwitchB(config-if-VLAN 40)#exit

//Increase the priority of VRRP 30 and VRRP 40 of Switch B to 120.

SwitchB(config)#interface vlan 30

SwitchB(config-if-VLAN 30)#vrrp 30 priority 120

SwitchB(config-if-VLAN 30)#exit

SwitchB(config)#interface vlan 40

SwitchB(config-if-VLAN 40)#vrrp 40 priority 120

SwitchB(config-if-VLAN 40)#exit

//Configure the Gi 0/1 port of Switch B as Route Port and its IP address as 10.10.1.1/24.

SwitchB(config)#interface gigabitEthernet 0/1

SwitchB(config-if-GigabitEthernet 0/1)#no switchport

SwitchB(config-if-GigabitEthernet 0/1)#ip address 10.10.2.1 255.255.255.0

SwitchB(config-if-GigabitEthernet 0/1)#exit

//Configure the Gi 0/1 port of Switch B as a monitored port for VRRP 30 and VRRP 40, and the Interface-Priority as 30.
```

	<pre>SwitchB(config)#interface vlan 30 SwitchB(config-if-VLAN 30)#vrrp 30 track gigabitEthernet 0/1 30 SwitchB(config-if-VLAN 30)#exit SwitchB(config)#interface vlan 40 SwitchB(config-if-VLAN 40)#vrrp 40 track gigabitEthernet 0/1 30 SwitchB(config-if-VLAN 40)#exit //Configure ports Gi 0/2 and Gi 0/3 as AP ports, which are Trunk ports. SwitchB #configure terminal Enter configuration commands, one per line. End with CNTL/Z. SwitchB (config)#interface range gigabitEthernet 0/2-3 SwitchB (config-if-range)#port-group 1 SwitchB (config)#interface aggregateport 1 SwitchB (config-if-AggregatePort 1)#switchport mode trunk</pre>
Verification	
Switch A	<pre>Check the configuration. SwitchA#show running-config ! vlan 10 ! vlan 20 ! vlan 30 ! vlan 40 ! spanning-tree spanning-tree mst configuration instance 0 vlan 1-9, 11-19, 21-29, 31-39, 41-4094 instance 1 vlan 10, 20 instance 2 vlan 30, 40 spanning-tree mst 0 priority 4096 spanning-tree mst 1 priority 4096 spanning-tree mst 2 priority 8192 interface GigabitEthernet 0/1</pre>

```
no switchport
no ip proxy-arp
ip address 10.10.1.1 255.255.255.0
!
interface GigabitEthernet 0/2
port-group 1
!
interface GigabitEthernet 0/3
port-group 1
!
interface AggregatePort 1
switchport mode trunk
!
interface VLAN 10
no ip proxy-arp
ip address 192.168.10.2 255.255.255.0
vrrp 10 priority 120
vrrp 10 ip 192.168.10.1
vrrp 10 track GigabitEthernet 0/1 30
!
interface VLAN 20
no ip proxy-arp
ip address 192.168.20.2 255.255.255.0
vrrp 20 priority 120
vrrp 20 ip 192.168.20.1
vrrp 20 track GigabitEthernet 0/1 30
!
interface VLAN 30
no ip proxy-arp
ip address 192.168.30.2 255.255.255.0
vrrp 30 ip 192.168.30.1
!
interface VLAN 40
no ip proxy-arp
```

	<pre> ip address 192.168.40.2 255.255.255.0 vrrp 40 ip 192.168.40.1 //Check VRRP status. SwitchA#show vrrp brief Interface Grp Pri timer Own Pre State Master addr Group addr VLAN 10 10 120 3 - P Master 192.168.10.2 192.168.10.1 VLAN 20 20 120 3 - P Master 192.168.20.2 192.168.20.1 VLAN 30 30 100 3 - P Backup 192.168.30.3 192.168.30.1 VLAN 40 40 100 3 - P Backup 192.168.40.3 192.168.40.1 //Disconnect the uplink of Switch A, and check VRRP status. SwitchA#show vrrp brief Interface Grp Pri timer Own Pre State Master addr Group addr VLAN 10 10 90 3 - P Backup 192.168.10.3 192.168.10.1 VLAN 20 20 90 3 - P Backup 192.168.20.3 192.168.20.1 VLAN 30 30 100 3 - P Backup 192.168.30.3 192.168.30.1 VLAN 40 40 100 3 - P Backup 192.168.40.3 192.168.40.1 </pre>
Switch B	<pre> //Check the configuration. SwitchB#show running-config ! vlan 10 ! vlan 20 ! vlan 30 ! vlan 40 ! spanning-tree spanning-tree mst configuration instance 0 vlan 1-9, 11-19, 21-29, 31-39, 41-4094 instance 1 vlan 10, 20 instance 2 vlan 30, 40 </pre>

```
spanning-tree mst 0 priority 8192
spanning-tree mst 1 priority 8192
spanning-tree mst 2 priority 4096
interface GigabitEthernet 0/1
  no switchport
  no ip proxy-arp
  ip address 10.10.2.1 255.255.255.0
!
interface GigabitEthernet 0/2
  port-group 1!
interface GigabitEthernet 0/3
  port-group 1
!
interface AggregatePort 1
  switchport mode trunk
!
interface VLAN 10
  no ip proxy-arp
  ip address 192.168.10.3 255.255.255.0
  vrrp 10 ip 192.168.10.1
!
interface VLAN 20
  no ip proxy-arp
  ip address 192.168.20.3 255.255.255.0
  vrrp 20 ip 192.168.20.1
!
interface VLAN 30
  no ip proxy-arp
  ip address 192.168.30.3 255.255.255.0
  vrrp 30 priority 120
  vrrp 30 ip 192.168.30.1
  vrrp 30 track GigabitEthernet 0/1 30
!
interface VLAN 40
```

```

no ip proxy-arp

ip address 192.168.40.3 255.255.255.0

vrrp 40 priority 120

vrrp 40 ip 192.168.40.1

vrrp 40 track GigabitEthernet 0/1 30

//Check VRRP status.

SwitchB#show vrrp brief

Interface  Grp  Pri  timer  Own  Pre  State  Master addr  Group addr
VLAN 10    10   100  3      -    P    Backup  192.168.10.2  192.168.10.1
VLAN 20    20   100  3      -    P    Backup  192.168.20.2  192.168.20.1
VLAN 30    30   120  3      -    P    Master  192.168.30.3  192.168.30.1
VLAN 40    40   120  3      -    P    Master  192.168.40.3  192.168.40.1

//Disconnect the uplink of Switch B, and check VRRP status.

SwitchB#show vrrp brief

Interface  Grp  Pri  timer  Own  Pre  State  Master addr  Group addr
VLAN 10    10   100  3      -    P    Master  192.168.10.3  192.168.10.1
VLAN 20    20   100  3      -    P    Master  192.168.20.3  192.168.20.1
VLAN 30    30   120  3      -    P    Master  192.168.30.3  192.168.30.1
VLAN 40    40   120  3      -    P    Master  192.168.40.3  192.168.40.1
    
```

4.5 Monitoring

Displaying

Description	Command
Displays the brief or detailed information of IPv4/IPv6 VRRP.	show [ipv6] vrrp [brief group]
Displays the information of an IPv4/IPv6 VRRP group on a specified interface.	show [ipv6] vrrp interface type number [brief]
Displays the statistics of VRRP packets.	show vrrp packet statistics [interface-type interface-number]

Debugging



System resources are occupied when debugging information is output. Therefore, disable debugging immediately after use.

Description	Command
Debugs VRRP errors, events, packets and status.	debug [ipv6] vrrp
Debugs VRRP errors.	debug [ipv6] vrrp errors

Debugs VRRP events.	debug [ipv6] vrrp events
Debugs VRRP packets.	debug vrrp packets [acl acl-id [icmp protocol] interface type number [group]] debug ipv6 vrrp packets [acl acl-name [icmp protocol] interface type number [group]]
Debugs VRRP status.	debug [ipv6] vrrp state

5 Configuring VRRP Plus

5.1 Overview

Virtual Router Redundancy Protocol Plus (VRRP Plus) is an extension of VRRP. It uses VRRP to implement gateway backup and load balancing in the IEEE 802.3 local area network (LAN).

A disadvantage of VRRP is that the router in backup state cannot forward packets. To use VRRP to implement load balancing, you need to manually configure multiple VRRP groups and set the gateway addresses of hosts in the LAN to virtual IP addresses of different VRRP groups. This increases the workload of the network administrator. VRRP Plus is designed to address this issue.

With VRRP Plus, load balancing is automatically implemented. That is, traffic of different hosts is automatically distributed to members of the VRRP Plus group, and it is unnecessary to configure multiple VRRP groups or set the gateway addresses of hosts in the LAN to virtual IP addresses of different VRRP groups. This greatly reduces the workload of the network administrator.

5.2 Applications

Application	Description
Enabling Load Balancing Within a VRRP Group	Implement load balancing within a VRRP group without configuring multiple groups or configuring different default gateways for hosts.

5.2.1 Enabling Load Balancing Within a VRRP Group

Scenario

Enable load balancing within a VRRP group without configuring without configuring multiple VRRP groups or configuring different default gateways for hosts.

As shown in Figure 5-1, configure data as follows:

- Configure a VRRP group that consists of Router A and Router B, and enable the VRRP Plus function.
- Configure the default gateway of each host as the master virtual IP address of the VRRP group.

Figure 5-1 Application topology of IPv4 VRRP Plus

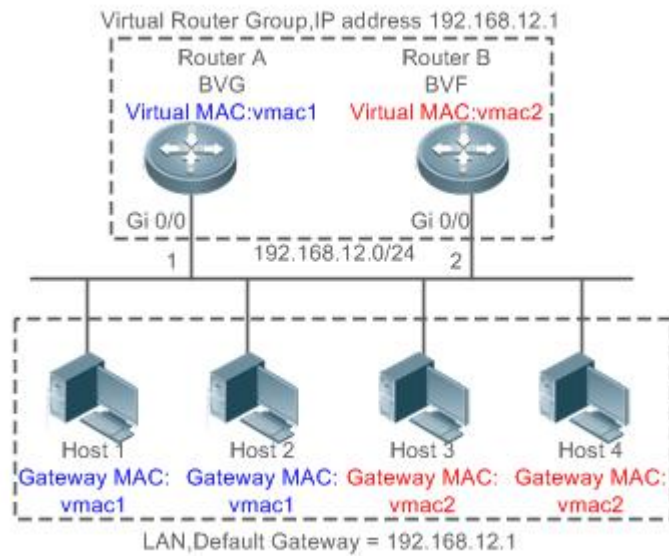

- 58. Two layer-3 (L3) devices, Router A and Router B, form a VRRP Plus group, and the virtual IP address of the group is 192.168.12.1. Router A is the master device of VRRP and functions as a balancing virtual gateway (BVG). Router B is the backup device of VRRP and functions as a balancing virtual forwarder (BVF).
- 59. Host 1 to Host 4 are hosts in the LAN with the network segment 192.168.12.0/24. Their default gateway addresses are set to the virtual IP address 192.168.12.1 of the VRRP Plus group.
- 60. The load balancing policy is configured on the device to respond to the ARP requests sent from different hosts. For example, when Host 1 and Host 2 request the gateway ARP, the MAC address 0000.5e00.0101 is returned to Host 1 and Host 2. When Host 3 and Host 4 request the gateway ARP, the MAC address 001A.A916.0201 is returned to Host 3 and Host 4. In this way, packets exchanged between Host 1/Host 2 and the external network are sent to Router A, and packets exchanged between Host 3/Host 4 and the external network are sent to Router B, thereby implementing load balancing.

Figure 5-2 Application topology of IPv6 VRRP Plus

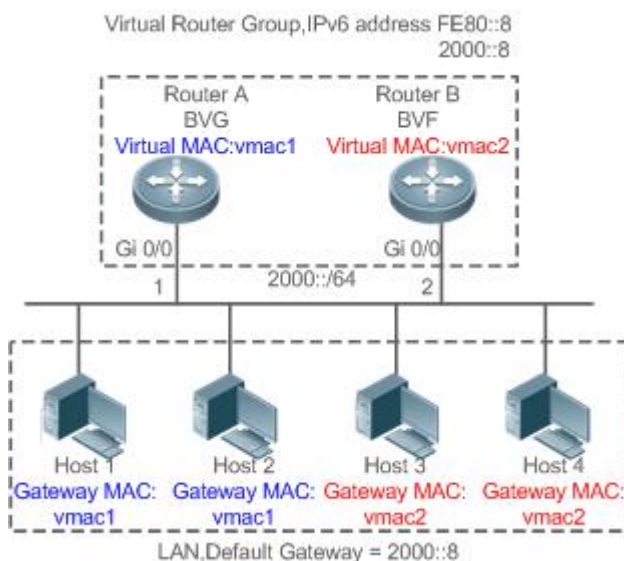

Remarks	<p>61. Two L3 devices, Router A and Router B, form an IPv6 VRRP Plus group, and the virtual IPv6 addresses are fe80::8 and 2000::8. Router A is the master device of IPv6 VRRP and functions as a BVG. Router B is the backup device of IPv6 VRRP and functions as a BVF.</p> <p>62. Host 1 to Host 4 are hosts in the LAN, and all their IPv6 gateway addresses are set to 2000::8.</p> <p>63. When Host 1 and Host 2 request the neighbor discovery (ND) of the gateway, the MAC address 0000.5e00.0201 is returned to Host 1 and Host 2. When Host 3 and Host 4 request the ND of the gateway, the MAC address 1414.4B72.7701 is returned to Host 3 and Host 4. In this way, packets exchanged between Host 1/Host 2 and the external network are sent to Router A, and packets exchanged between Host 3/Host 4 and the external network are sent to Router B, thereby implementing load balancing.</p>
----------------	--

Deployment

- Deploy VRRP Plus on Router A and Router B to implement load balancing on the local host.

5.3 Features

Basic Concepts

↘ **BVG**

The BVG allocates virtual MAC addresses to members of the VRRP Plus group. It responds to the gateway ARP/ND requests in the LAN, and forwards packets of hosts in the LAN.

↘ **BVF**

The BVF forwards packets of hosts in the LAN. If a virtual MAC address is allocated to a BVF, the BVF participates in packet forwarding; otherwise, the BVF does not participate in packet forwarding.

Overview

Feature	Description
VRRP Plus	Extend VRRP and use VRRP to implement gateway backup and load balancing in the IEEE 802.3 LAN.

5.3.1 VRRP Plus

With VRRP Plus, load balancing is automatically implemented. That is, traffic of different hosts is automatically distributed to members of the VRRP Plus group, and it is unnecessary to configure multiple VRRP groups or set the gateway addresses of hosts in the LAN to the virtual IP addresses of different VRRP groups.

Basic Principles

Hosts in a LAN use the unified gateway IP address (that is, virtual IP address of the VRRP group). When different hosts request the gateway ARP, the BVG responds with different virtual MAC addresses. In this way, traffic of different hosts are distributed to different members of the VRRP Plus group, thereby implementing load balancing.

↘ **Relationship Between VRRP Plus and VRRP**

VRRP Plus relies on VRRP, and runs in the following way:

A master device in VRRP corresponds to a BVG in VRRP Plus, and a backup device in VRRP corresponds to a BVF in VRRP Plus. Gateway addresses of hosts in the LAN are set to the virtual IP address of VRRP.

➤ **MAC Address Allocation Rules of the BVG and BVF**

The BVG allocates virtual MAC addresses to BVFs. For an IPv4 VRRP Plus group, the BVG directly uses the virtual MAC address of VRRP to ensure compatibility between IPv4 VRRP Plus and VRRP. That is, the virtual MAC address used by the BVG is 00-00-5E-00-01-{VRID}, where VRID is the VRRP group number. The virtual MAC address used by a BVF is 00-1A-A9-16-{MemberID}-{VRID}, where MemberID is the member ID of the BVF in the VRRP Plus group. Currently, a VRRP Plus group can have up to four members. The BVG uses the member ID 01, and the other BVFs use the member IDs 02 to 04. For an IPv6 VRRP Plus group, the BVG directly uses the virtual MAC address of IPv6 VRRP to ensure compatibility between IPv6 VRRP Plus and VRRP. That is, the virtual MAC address used by the BVG is 00-00-5E-00-02-{VRID}, where VRID is the IPv6 VRRP group number. The virtual MAC address used by a BVF is 14-14-4B-72-{76 + MemberID}-{VRID}, where MemberID ranges from 01 to 03.

➤ **Load Balancing Policy of VRRP Plus**

The BVG responds to the gateway ARP/NS requests sent from hosts in a LAN. Based on the specific load balancing policy, the BVG responds hosts with different virtual MAC addresses. There are three types of load balancing policies:

- Host-dependent policy: A specified virtual MAC address is used to respond to the requests sent by a specified host.
- Round-robin policy: Virtual MAC addresses in the backup group are used in a cyclic manner to respond to the gateway ARP/NS requests sent by hosts.
- Weighted policy: The ARP/NA requests are responded based on the forwarding capability of each device.

If the load balancing mode is changed, load balancing is always implemented in the new load balancing mode. For example, if the polling response mode is previously used, and later the weighted mode is used, load balancing is implemented in weighted mode regardless of the earlier responses of the device. If the weighted policy is used, and the total weight of virtual routers in a VRRP Plus group is 0, the ARP/NS requests are not responded.

➤ **Proxy of the Virtual MAC Address**

When a device with a virtual MAC address becomes faulty in the backup group, traffic of hosts that use this virtual MAC address as the gateway MAC address will be interrupted.

The BVG in the VRRP Plus backup group can quickly detect the fault, and automatically allocates the virtual MAC address of the faulty BVF to another device in the backup group. The new device acts as the proxy of the faulty device to forward packets of the virtual MAC address. In addition, this proxy device takes over traffic of original hosts to prevent traffic interruption. The virtual MAC address allocated to a device in the backup group can be called master virtual MAC address, and the virtual MAC address used by this device on behalf of another device is called proxy virtual MAC address.

➤ **Redirection Time and Timeout of the Proxy Virtual MAC Address**

VRRP Plus provides the proxy function for the virtual MAC address so that another device can take the place of a faulty device with a virtual MAC address to forward packets. If the BVF is recovered from the fault, its forwarding role is recovered and the BVF continues to forward packets of the virtual MAC

address allocated to this BVF. If the faulty BVF is not recovered, the backup group stops redirecting traffic to this virtual MAC address. That is, when ARP requests are received again, this virtual MAC address is no longer responded. After a sufficient long period of time, it is believed that hosts that use the MAC address as the gateway MAC address already update the ARP/ND table entry of the gateway address, and the traffic is already taken over by other devices. At this time, this virtual MAC address can be deleted, and packets sent to this virtual MAC address are dropped.

VRRP Plus supports configuration of the redirection time and timeout of the backup group. When a device is faulty, the backup group allocates the virtual MAC address of the faulty device to another device. Within the redirection time, the backup group continues to use this virtual MAC address to respond the ARP/NS requests. When the redirection time expires, the backup group no longer uses this virtual MAC address to respond the requests. When the timeout elapses, the backup group deletes this virtual MAC address and stops using this virtual MAC address for proxy forwarding. Figure 1-3 shows the changes to the role of the virtual MAC address within the redirection time and timeout.

Figure 5-3 Changes to the Role of the Virtual MAC Address Within the Redirection Time and Timeout

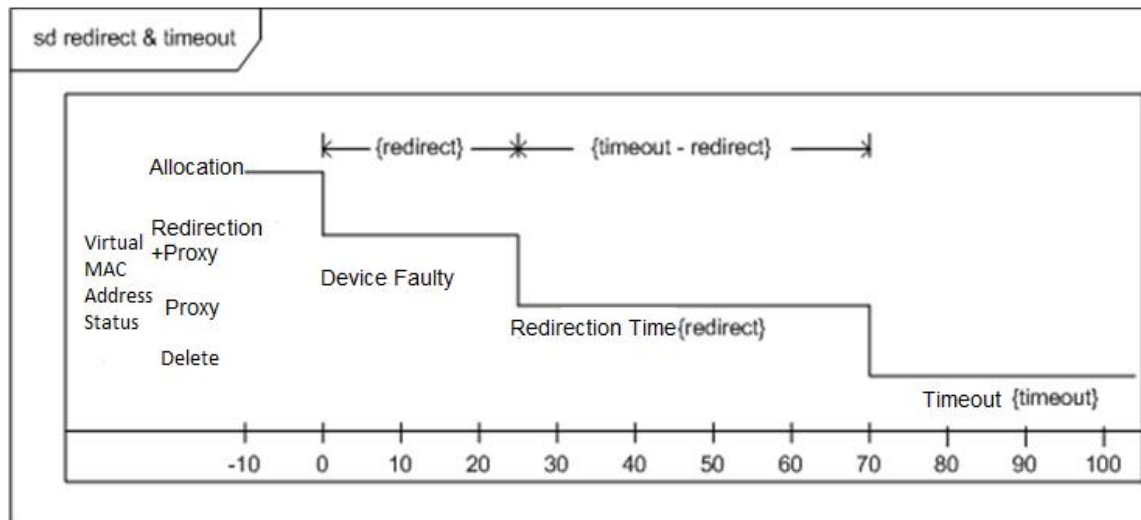

➤ **Weight-based Forwarding**

VRRP Plus supports the weight configuration of the backup group. Different weights are configured for different devices. In this way, more traffic is distributed to the device with a greater weight and less traffic is distributed to the device with a smaller weight, thereby fully utilizing the forwarding performance of different devices. When the weight of a BVF in the backup group is smaller than the lower threshold, the BVF automatically exits from the forwarding role. When the weight recovers and is greater than the upper threshold, the BVF automatically applies for the forwarding role. The forwarding role can be recovered when one or more remaining virtual MAC addresses or proxy virtual MAC addresses exist.

➤ **Association of VRRP Plus with BFD**

VRRP Plus supports association with bidirectional forwarding detection (BFD) to adjust the weight based on the link status. Each device in a backup group can associate its weight with the link status. When a link is abnormal or interrupted, the device automatically decreases its weight. When the weight is too low, the device automatically exits from the forwarding role. If the backup group is currently using

the weighted load balancing policy, traffic can be distributed based on the new weight. When the associated link recovers, the device can automatically restore its original weight and the forwarding role. If the backup group is currently using the weighted load balancing policy, traffic can be distributed based on the recovered weight. IPv6 VRRP Plus currently does not support association with BFD.

➤ **Weight-based Forwarding Seizure**



VRRP Plus supports the function of seizing the forwarding role. In VRRP Plus, at most four devices can participate in load balancing. That is, a VRRP Plus backup group generates at most four virtual MAC addresses. If more than four devices are added to a VRRP Plus group, only four devices participate in packet forwarding. The remaining devices only listen to the status of other devices and do not participate in packet forwarding. Only when a device participating in packet forwarding is faulty, another device that originally does not participate in packet forwarding will take the place of the faulty device to forward packets. Assume that a VRRP Plus backup group already has four devices and all these devices participate in packet forwarding; a fifth device is added to the VRRP Plus group, and the forwarding capability of this device is strong or the original forwarding role encounters a link failure and consequently degradation of forwarding performance. In this case, if the seizure mode is enabled, the fifth device can seize the forwarding role from a device with a smaller weight (that is, with lower forwarding capability). A greater weight is configured for a device with stronger forwarding capability. When the weight of a device in listening state is found greater than that of a forwarding device, the device in listening state automatically seizes the forwarding role from the forwarding device. That is, the device with stronger forwarding capability forwards packets, whereas the device with lower forwarding capability is in listening state. This can minimize the waste of resources.

The BVG in a backup group is responsible for allocation of virtual MAC addresses. Therefore, the BVG role cannot be seized, and only the forwarding role of a BVF can be seized. If the BVG device is faulty, VRRP re-elects a new master device, which assumes the BVG role.

➤ **Factors Affecting the Forwarding Policy**

64. After VRRP Plus is configured, the ARP/NS requests are received from hosts can be responded based on different load balancing policies to implement load balancing among these hosts. However, load balancing cannot be implemented for hosts that have learned the VRRP virtual gateway addresses before configuration of VRRP Plus. Therefore, if VRRP Plus is configured after the VRRP state is changed to Master, real load balancing cannot be implemented before aging of the ARP/NDs learned by hosts. Load balancing is implemented only after the gateway ARP/NDs recorded by the hosts age and the hosts request for new gateway addresses.
65. Periodical sending of gratuitous ARPs on an interface also affect the load balancing function of VRRP Plus. When VRRP Plus is enabled, the function of sending gratuitous ARPs of VRRP virtual IP addresses will be disabled. When an virtual IP address overlaps with an actual IP address, gratuitous ARPs of this address are no longer sent.
66. When an address conflict occurs between a host and the local device, the ARP/NA module will broadcast gratuitous ARP/NA packets of this address. If a conflict of the VRRP Plus virtual address occurs, sending gratuitous ARP/NA packet will result re-learning of the host's gateway MAC address, which negatively affects the load balancing function of VRRP Plus. Therefore, the load balancing function of VRRP Plus is currently not supported in this scenario.

5.4 Configuration

Configuration Item	Description and Command
Configuring VRRP Plus	 (Mandatory) It is used to enable the VRRP Plus function.
	vrrp balance Enables the VRRP Plus function of a VRRP backup group with the specified group ID in interface configuration mode.
	 (Optional) It is used to configure parameters of a VRRP Plus backup group.
	vrrp load-balancing Configures the load balancing policy of VRRP Plus in interface configuration mode.
	vrrp timers redirect Configures the redirection time and timeout of the proxy virtual MAC address in a VRRP Plus backup group in interface configuration mode.
	vrrp weighting Configures the weight and upper and lower thresholds of a VRRP Plus backup group in interface configuration mode.
	vrrp forwarder preempt Configures the forwarding seizure function of a VRRP Plus backup group in interface configuration mode.
	vrrpweighting track Configures a weight tracking object of a VRRP Plus backup group in interface configuration mode.

5.4.1 Configure VRRP Plus

Configuration Effect

- Enable the VRRP Plus function. (By default, this function is disabled.)
- Configure a weight tracking object of a VRRP Plus backup group.

Notes

- To enable the VRRP Plus function, you must configure the VRRP virtual IP address for the corresponding backup group.

Configuration Steps

➤ Enabling VRRP Plus on an Interface

- By default, VRRP Plus is enabled. Perform this configuration if VRRP Plus is required.

➤ Configuring the Load Balancing Policy of VRRP Plus

- After VRRP Plus is enabled, the host-dependent load balancing policy is used by default.

➤ Configuring the Redirection Time and Timeout of the Proxy Virtual MAC Address in a VRRP Plus Backup Group

- After VRRP Plus is enabled, the redirection time is set to 300s and timeout is set to 14,400s by default.

➤ Configuring the Weight and Upper and Lower Thresholds of a VRRP Plus Backup Group

- After VRRP Plus is enabled, the weight of the backup group is set to 100, the lower threshold to 1, and the upper threshold to 100 by default.

➤ Configuring the Forwarding Seizure Function of a VRRP Plus Backup Group

- After VRRP Plus is enabled, the forwarding seizure function is enabled by default.

✚ Configuring the Weight Tracking Object of a VRRP Plus Backup Group

- The weight tracking object of a VRRP Plus backup group is disabled by default. Perform this configuration if the tracking function is required.

Verification

- Run the **show [ipv6]group vrrp balance** command to display the VRRP backup group configuration. If the backup group has the packet forwarding tasks, "local" is displayed in the **forwarders** column, and the virtual MAC address allocated to this backup group is also displayed.

Related Commands

✚ Enabling VRRP Plus on an Interface

Command	vrrp [ipv6]group balance
Parameter	ipv6: Indicates that this configuration applies to IPv6. By default, the configuration applies to IPv4.
Description	<i>group:</i> Indicates the ID of the VRRP group. The value range of the group ID varies according to the product model.
Command Mode	Interface configuration mode
Usage Guide	VRRP Plus can be enabled only after a VRRP group is configured.

✚ Configuring the Load Balancing Policy of a VRRP Plus Backup Group

Command	vrrp [ipv6]group load-balancing{host-dependent round-robin weighted }
Parameter Description	ipv6: Indicates that this configuration applies to IPv6. By default, the configuration applies to IPv4. <i>group:</i> Indicates the ID of the VRRP group. host-dependent: Indicates the host-dependent load balancing policy. round-robin: Indicates the round-robin load balancing policy. weighted: Indicates the weighted load balancing policy.
Command Mode	Interface configuration mode
Usage Guide	After VRRP Plus is enabled, the host-dependent load balancing policy is used by default. The load balancing policy of the entire backup group is determined by the policy configured on the BVG. If you wish to use the same load balancing policy after the role of the BVG device changes, configure the same policy on all devices in the backup group.

✚ Configuring the Redirection Time and Timeout of the Proxy Virtual MAC Address in a VRRP Plus Backup Group

Command	vrrp [ipv6]group timers redirectredirecttimeout
Parameter Description	ipv6: Indicates that this configuration applies to IPv6. By default, the configuration applies to IPv4. <i>group:</i> Indicates the ID of the VRRP group. <i>redirect:</i> Indicates the redirection time. The value ranges from 0 to 3,600s. The default value is 300s, that is, 5 minutes. <i>timeout:</i> Indicates the timeout time. The value ranges from (redirect + 600) to 64,800s. The default value is 14400, that is, 4 hours.
Command Mode	Interface configuration mode

Usage Guide	After VRRP Plus is enabled, the redirection time is set to 300s and timeout is set to 14,400s by default. When a device is faulty, the backup group allocates the virtual MAC address of the faulty device to another device. Within the redirection time, the backup group continues to use this virtual MAC address to respond the ARP/NS requests. When the redirection time expires, the backup group no longer uses this virtual MAC address to respond the requests. When the timeout elapses, the backup group deletes this virtual MAC address.
--------------------	---

↘ Configuring the Weight and Upper and Lower Thresholds of a VRRP Plus Backup Group

Command	vrrp [ipv6]group weighting maximum [lowerlower] [upperupper]
Parameter Description	ipv6: Indicates that this configuration applies to IPv6. By default, the configuration applies to IPv4. maximum: Indicates the weight of the backup group. The value ranges from 2 to 254. The default value is 100. lowerlower: Indicates the lower threshold of the backup group. The value ranges from 1 to (maximum - 1). The default value is 1. upperupper: Indicates the upper threshold of the backup group. The value ranges from lower to maximum . The default value is 100.
Command Mode	Interface configuration mode
Usage Guide	After VRRP Plus is enabled, the weight and upper and lower thresholds of a VRRP Plus backup group are configured by default. You can use this command to configure different weights for different devices so that more traffic is distributed to the device with a greater weight and less traffic is distributed to the device with a smaller weight. When the weight of a BVF in the backup group is lower than the lower threshold, the BVF automatically exits from the forwarding role. When the weight recovers and is higher than the upper threshold, the forwarding role of the BVF is automatically restored.

↘ Configuring the Forwarding Seizure Function of a VRRP Plus Backup Group

Command	vrrp[ipv6]group forwarder preempt
Parameter Description	ipv6: Indicates that this configuration applies to IPv6. By default, the configuration applies to IPv4. group: Indicates the ID of the VRRP group.
Command Mode	Interface configuration mode
Usage Guide	After VRRP Plus is enabled, the forwarding seizure function is enabled by default. VRRP Plus supports configuration of the forwarding seizure function of a backup group. When the weight of a device in listening state is found greater than that of a forwarding device, the device in listening state automatically seizes the forwarding role from the forwarding device. That is, the device with stronger forwarding capability forwards packets, whereas the device with lower forwarding capability is in listening state.

↘ Configuring the Weight Tracking Object of a VRRP Plus Backup Group

Command	vrrp [ipv6] group weighting track object-number [decrement value]
Parameter Description	ipv6: Indicates that this configuration applies to IPv6. By default, the configuration applies to IPv4. group: Indicates the ID of the VRRP group. object-number: Indicates the number of the tracking object. The value ranges from 1 to 700. decrement value: Indicates the decrement weight when the tracking object is down. The decrement value ranges from 1 to 255. The default value is 10.
Command Mode	Interface configuration mode

Usage Guide	After VRRP Plus is enabled, no tracking object is configured by default. After the tracking object is configured, the decrement value is 10 by default.
--------------------	---

Configuration Example

▾ **Enabling Load Balancing Within an IPv4 VRRP Group**

<p>Scenario</p>	<p>The diagram illustrates a network setup for VRRP Plus with load balancing. Two routers, Router A (BVG) and Router B (BVF), are connected to the Internet via their Gi 0/14 interfaces. They are also connected to a LAN via their Gi 0/0 interfaces. The LAN contains four hosts (Host 1, Host 2, Host 3, Host 4) with virtual MACs (vmac1, vmac2) and a default gateway of 192.168.12.1. The LAN is labeled 'LAN, Default Gateway = 192.168.12.1'.</p>
<p>Configuration Steps</p>	<ul style="list-style-type: none"> ● Configure a tracking object respectively on Router A and Router B to track the status of the local GigabitEthernet 0/14 interface. ● Configure a VRRP group and enable VRRP Plus respectively on Router A and Router B. Configure the local IP addresses so that Router A becomes a BVG (master) device, and Router B becomes a BVF (backup) device. ● Configure the weighted load balancing policy. Configure the weight tracking object, and set the decrement value to 100. ● Retain default configurations of the weight, upper and lower thresholds, redirection time, timeout, and forwarding seizure of the backup group. ● Set the default gateway addresses of Host 1 to Host 4 in the LAN to the virtual IP address of VRRP, that is, 192.168.12.1.
<p>Router A</p>	<pre> FSA#config FSA(config)#track 1 interface GigabitEthernet0/14 line-protocol FSA(config)#interface GigabitEthernet0/0 // 'no switchport' is used on the switch. FSA(config-if-GigabitEthernet 0/0)#no switchport FSA(config-if-GigabitEthernet 0/0)#ip address 192.168.12.3 255.255.255.0 FSA(config-if-GigabitEthernet 0/0)#vrrp 1 ip 192.168.12.1 FSA(config-if-GigabitEthernet 0/0)#vrrp 1 balance FSA(config-if-GigabitEthernet 0/0)#vrrp 1 load-balancing weighted FSA(config-if-GigabitEthernet 0/0)#vrrp 1 weighting track 1 decrement 100 </pre>
<p>Router B</p>	<pre> FSB#config </pre>

	<pre> FSB(config)#track 1 interface GigabitEthernet0/14 line-protocol FSB(config)#interface GigabitEthernet0/0 FSB(config-if-GigabitEthernet 0/0)#no switchport FSB(config-if-GigabitEthernet 0/0)#ip address 192.168.12.2 255.255.255.0 FSB(config-if-GigabitEthernet 0/0)#vrrp 1 ip 192.168.12.1 FSB(config-if-GigabitEthernet 0/0)#vrrp 1 balance FSB(config-if-GigabitEthernet 0/0)#vrrp 1 load-balancing weighted FSB(config-if-GigabitEthernet 0/0)#vrrp 1 weighting track 1 decrement 100 </pre>
<p>Verification</p>	<p>Run the show vrrp balance command to display the configuration of the VRRP Plus group. If the backup group has the packet forwarding tasks, "local" is displayed in the forwarders column, and the virtual MAC address allocated to this backup group is also displayed.</p>
<p>Router A</p>	<pre> FSA# show vrrp balance interface GigabitEthernet0/0 State is BVG Virtual IP address is 192.168.12.1 Hello time 1 sec, hold time 3 sec Load balancing: weighted Redirect time 300 sec, forwarder time-out 14400 sec Weighting 100 (configured 100), thresholds: lower 1, upper 100 Track object 1, state: up, decrement weight: 100 There are 2 forwarders Forwarder 1 (local) MAC address: 0000.5e00.0101 Owner ID is 0000.0001.0006 Preemption disabled (BVG cannot be preempted) Forwarder 2 MAC address: 001a.a916.0201 Owner ID is 00d0.f822.33a3 Preemption enabled </pre>
<p>Router B</p>	<pre> FSB# show vrrp balance interface GigabitEthernet0/0 State is BVF Virtual IP address is 192.168.12.1 </pre>

<p>Hello time 1 sec, hold time 3 sec</p> <p>Load balancing: weighted</p> <p>Redirect time 300 sec, forwarder time-out 14400 sec</p> <p>Weighting 100 (configured 100), thresholds: lower 1, upper 100</p> <p>Track object 1, state: up, decrement weight: 100</p> <p>There are 2 forwarders</p> <p>Forwarder 1</p> <p>MAC address:</p> <p style="padding-left: 20px;">0000.5e00.0101</p> <p>Owner ID is 0000.0001.0006</p> <p>Preemption disabled (BVG cannot be preempted)</p> <p>Forwarder 2 (local)</p> <p>MAC address:</p> <p style="padding-left: 20px;">001a.a916.0201</p> <p>Owner ID is 00d0.f822.33a3</p> <p>Preemption enabled</p>
--

Enabling Load Balancing Within an IPv6 VRRP Group

<p>Scenario</p> <p>Figure 5-5</p>	
<p>Configuration Steps</p>	<ul style="list-style-type: none"> ● Configure an IPv6 VRRP group and enable IPv6 VRRP Plus respectively on Router A and Router B. Configure the priorities so that Router A becomes a BVG (master) device, and Router B becomes a BVF (backup) device. ● Configure the weighted load balancing policy for the IPv6 VRRP Plus backup group. ● Retain default configurations of the weight, upper and lower thresholds, redirection time, timeout, and forwarding seizure of the backup group. ● Set the default gateway addresses of Host 1 to Host 4 in the LAN to 2000::8.
<p>Router A</p>	<pre>RouterA#config</pre>

	<pre>RouterA(config)#interface GigabitEthernet0/0 //'no switchport' is used on the switch. RouterA(config-if-GigabitEthernet 0/0)#no switchport RouterA(config-if-GigabitEthernet 0/0)#ipv6 address 2000::6/64 RouterA(config-if-GigabitEthernet 0/0)#vrrp 1 ipv6 fe80::8 RouterA(config-if-GigabitEthernet 0/0)#vrrp 1 ipv62000::8 RouterA(config-if-GigabitEthernet 0/0)#vrrp ipv6 1 priority 120 RouterA(config-if-GigabitEthernet 0/0)#vrrp ipv6 1 load-balancing weighted RouterA(config-if-GigabitEthernet 0/0)#vrrp ipv6 1 balance</pre>
<p>Router B</p>	<pre>RouterB#config RouterB(config)#interface GigabitEthernet0/0 RouterB(config-if-GigabitEthernet 0/0)#no switchport RouterB(config-if-GigabitEthernet 0/0)# ipv6 address 2000::7/64 RouterB(config-if-GigabitEthernet 0/0)#vrrp 1 ipv6fe80::8 RouterB(config-if-GigabitEthernet 0/0)#vrrp 1 ipv62000::8 RouterB(config-if-GigabitEthernet 0/0)#vrrp ipv6 1 load-balancing weighted RouterB(config-if-GigabitEthernet 0/0)#vrrp ipv6 1 balance</pre>
<p>Verification</p>	<p>Run the show ipv6 vrrp balance command to display the configuration of the VRRP Plus group. If the backup group has the packet forwarding tasks, "local" is displayed in the forwarders column, and the virtual MAC address allocated to this backup group is also displayed.</p>
<p>Router A</p>	<pre>RouterA# show ipv6 vrrp balance interface GigabitEthernet0/0 GigabitEthernet 0/0 - Group 1 State is BVG Virtual IPv6 address is as follows: FE80::8 2000::8 Hello time 1 sec, hold time 3 sec Load balancing: weighted Redirect time 300 sec, forwarder time-out 14400 sec Weighting 100 (configured 100), thresholds: lower 1, upper 100 There are 2 forwarders Forwarder 1 (local) MAC address:</pre>

	<pre> 0000.5e00.0201 Owner ID is 00d0.f8fb.96f3 Preemption disabled (BVG cannot be preempted) Forwarder 2 MAC address: 1414.4b72.7701 Owner ID is 00d0.f8fb.6c42 Preemption enabled </pre>
<p>Router B</p>	<pre> RouterB# show ipv6 vrrp balance interface GigabitEthernet0/0 GigabitEthernet 0/0 - Group 1 State is BVF Virtual IPv6 address is as follows: FE80::8 2000::8 Hello time 1 sec, hold time 3 sec Load balancing: weighted Redirect time 300 sec, forwarder time-out 14400 sec Weighting 150 (configured 150), thresholds: lower 1, upper 100 There are 2 forwarders Forwarder 1 MAC address: 0000.5e00.0201 Owner ID is 00d0.f8fb.96f3 Preemption disabled (BVG cannot be preempted) Forwarder 2 (local) MAC address: 1414.4b72.7701 Owner ID is 00d0.f8fb.6c42 Preemption enabled </pre>

Common Errors

- VRRP Plus does not take effect because the VRRP virtual IP address is not configured for the related group.

5.5 Monitoring

Displaying

Description	Command
Displays the brief or detailed configuration of VRRP Plus.	show [ipv6] vrrp balance
Displays the actions of the VRRP Plus group on a specified interface.	show [ipv6] vrrp balance interface

Debugging



System resources are occupied when debugging information is output. Therefore, disable debugging immediately after use.

Description	Command
Debugs the VRRP Plus function.	debug[ipv6] vrrp balance
Debugs errors.	debug[ipv6] vrrp balance error
Debugs events of the VRRP Plus group.	debug [ipv6] vrrp balance event
Debugs the messages between the VRRP module and the track module.	debug[ipv6] vrrp balance messages
Debugs the VRRP Plus packets.	debug[ipv6] vrrp balance packets
Debugs the VRRP Plus group status.	debug [ipv6] vrrp balance state
Debugs the timers of the VRRP Plus group.	debug vrrp balance timer

6 Configuring BFD

6.1 Overview

Communication failures will interrupt networking and thus affect services. Therefore, it is essential to rapidly locate communication failures on links with adjacent devices to ensure a timely action and service availability. Bidirectional Forwarding Detection (BFD) provides a method of rapidly detecting connectivity of the forwarding path between two adjacent routers in an underloaded way. It can quickly spot faults on the bidirectional forwarding path between two routers for upper-layer protocols such as routing protocols and Multi-Protocol Label Switching (MPLS). As a result, a standby forwarding path is adopted to maintain the performance of the existing network.

Protocols and Standards

- draft-ietf-bfd-base-09: Bidirectional Forwarding Detection
- draft-ietf-bfd-generic-05: Generic Application of BFD
- draft-ietf-bfd-mib-06: Bidirectional Forwarding Detection Management Information Base
- draft-ietf-bfd-v4v6-1hop-09: BFD for IPv4 and IPv6 (Single Hop)
- draft-ietf-bfd-multihop-07: BFD for IPv4 and IPv6 (Multi-hop)
- draft-ietf-bfd-mpls-07: BFD For MPLS LSPs

Currently, draft-ietf-bfd-mib-06 and draft-ietf-bfd-multihop-07 are not supported.

6.2 Applications

Application	Description
BFD Support for OSPF	OSPF utilizes BFD to rapidly detect the neighbor status.
BFD Support for Static Routing	Static routing utilizes BFD to rapidly detect the next-hop reachability of a route.

6.2.1 BFD Support for OSPF

Scenario

The Open Shortest Path First (OSPF) protocol dynamically discovers a neighbor by using hello packets. After BFD is enabled, a BFD session is established with the neighbor in the full adjacency to detect the neighbor status. When the neighbor fails, OSPF immediately performs network convergence. The convergence time can be shortened from 120 seconds (by default, on a non-broadcast network, OSPF hello packets are transmitted at an interval of 30 seconds and the neighbor failure time is four times the interval, that is, 120 seconds) to 1 second.

Use the following figure as an example. Router A and Router B are connected through a Layer-2 switch, OSPF is configured on the routers to establish routes, and BFD support for OSPF is enabled on the interfaces of Router A and Router B. When the link between Router B and the Layer-2 switch malfunctions, BFD can rapidly detect the fault and advertise it to OSPF, so as to trigger fast OSPF convergence.

Figure 6-1

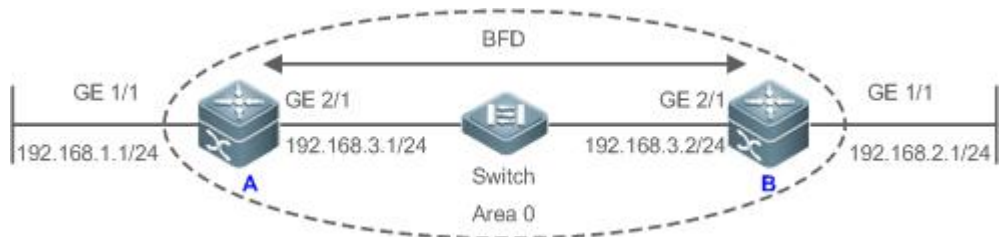

Remarks	<p>A and B are routers.</p> <p>Switch is a Layer-2 switch.</p> <p>A and B are connected through the Layer-2 switch.</p>
----------------	---

Deployment

- Configure IP addresses for interconnected interfaces of Router A and Router B.
- Run OSPF on Router A and Router B.
- Set BFD parameters on interconnected interfaces of Router A and Router B.
- Enable BFD support for OSPF on Router A and Router B.

6.2.2 BFD Support for Static Routing

Scenario

BFD support for static routing prevents routers from selecting a faulty static route as the forwarding path and enables rapid routing failover by using an available backup forwarding path.

Different from dynamic routing protocols, static routing does not have the neighbor discovery (ND) mechanism. When BFD support for static routing is configured, the next-hop reachability of a static route relies on the BFD session status. If a BFD session fails, the next hop of a static route is thought unreachable and will not be added to the routing information base (RIB).

Use the following figure as an example. Router A and Router B are connected through a Layer-2 switch, static routing is configured on the routers to establish forwarding paths, and BFD support for static routing is enabled on the interfaces of Router A and Router B. When the link between Router B and the Layer-2 switch malfunctions, BFD can rapidly detect the fault and advertise it to static routing, so as to trigger the system to delete the static route from the RIB, thereby preventing routing errors.

Figure 6-2



Remarks	A and B are routers. Switch is a Layer-2 switch. A and B are connected through the Layer-2 switch.
----------------	--

Deployment

- Configure IP addresses for interconnected interfaces of Router A and Router B.
- Configure static routing on Router A and Router B.
- Set BFD parameters for interconnected interfaces of Router A and Router B.
- Enable BFD support for static routing on Router A and Router B.

6.3 Features

Basic Concepts

Packet Format

Detection packets transmitted by BFD are User Datagram Protocol (UDP) packets, which are classified into control packets and echo packets. Echo packets concern only the local system of a BFD session. Therefore, their formats are not specified. BFD specifies the format of only control packets. Currently, there are two versions (version 0 and version 1) for the format of control packets. Version 1 is adopted by default for establishing a BFD session. If a device receives packets of version 0 from the peer system, the device automatically switches to version 0.

Figure 6-3

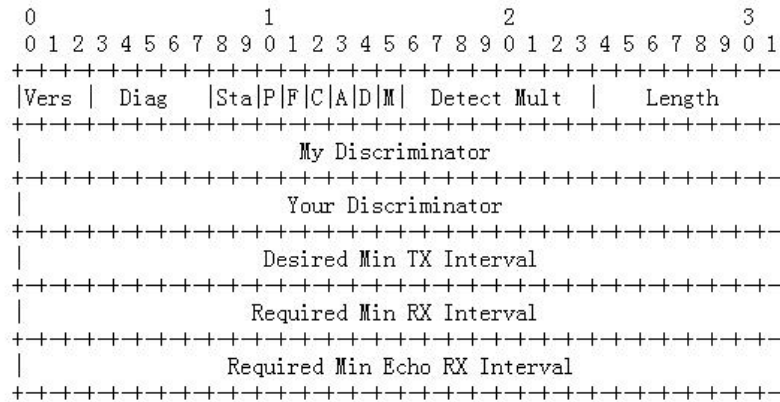

Field	Description
Vers	Indicates the BFD protocol version number, which is 1 currently.
Diag	Indicates the cause for the local system's last change in session state, including: 0 -- No Diagnostic. 1 -- Control Detection Time Expired 2 -- Echo Function Failed 3 -- Neighbor Signaled Session Down 4 -- Forwarding Plane Reset 5 -- Path Down 6 -- Concatenated Path Down 7 -- Administratively Down
Sta	Indicates the BFD local session state, including: 0 -- AdminDown. 1 -- Down. 2 -- Init. 3 -- Up.
P	Indicates that the transmitter in a BFD session adds this bit in a verification request upon parameter changes, waiting for the peer response.
F	Indicates the bit that must be set in the response packet for responding to the P bit.
C	Indicates the control plane independent. If set, changes of the control plane do not affect BFD detection. For example, if the control plane is OSPF, when OSPF is restarted or experiences graceful restart (GR), BFD can continue to detect the link status.
A	Indicates the authentication present. If set, a session is to be authenticated.
D	Indicates the demand request. If set, the transmitter desires to detect links in Demand mode.
M	Indicates the multipoint bit to be used in point-to-multipoint extensions. It must be set to 0 currently.
Detect Mult	Indicates the detection timeout multiplier. It is used by the detector to calculate the detection timeout time.
Length	Indicates the packet length.
My Discriminator	Indicates the discriminator of the local end connected by a BFD session.
Your Discriminator	Indicates the discriminator of the remote end connected by a BFD session.
Desired Min Tx Interval	Indicates the minimum interval of transmitting BFD packets supported by the local end.
Required Min RX Interval	Indicates the minimum interval of receiving BFD packets supported by the local end.

Field	Description
Required Min Echo RX Interval	Indicates the minimum interval of receiving echo packets supported by the local end. It is set to 0 if the local end does not support the echo function.
Auth Type	(Optional) Indicates the authentication type, including: Simple Password Keyed MD5 Meticulous Keyed MD5 Keyed SHA1 Meticulous Keyed SHA1
Auth Length	Indicates the authentication data length.
Authentication Data	Indicates the authentication data area.

📌 Session Status

A BFD session can be in any of the four basic states: Down, Init, Up, and AdminDown.

67. Down: Indicates that a session is in the Down state or is established just now.
68. Init: Indicates that the local system has communicated with the peer system and desires to bring the session to the Up state.
69. Up: Indicates that a session has been negotiated successfully.
70. AdminDown: Indicates that a session is in the AdminDown state.

BFD migrates the state machine based on the local session state and received BFD packets from the peer end.

A BFD state machine is established and torn down using a three-way handshake mechanism, to ensure that both ends know the status change.

📌 Transmission Interval and Detection Time

Both ends negotiate BFD parameters during the establishment of a BFD session, to determine the transmission interval and detection time.

After a BFD session is established, both ends can dynamically negotiate BFD parameters (for example, minimum transmission interval and minimum receiving interval). After protocols at both ends transmit relevant negotiation packets, they adopt the new transmission interval and detection time, without affecting the current state of the session.

Overview

Feature	Description
BFD Session Establishment	Establishes a BFD session.
BFD Session Detection	Rapidly detects a bidirectional forwarding path.
BFD Support for Applications	Rapidly advertises the BFD detection result.
BFD Protection	Protects BFD from attacks for stability.
BFD Flapping Dampening	Protects stability of associated applications in the case of line instability.

6.3.1 BFD Session Establishment

BFD detection starts from the establishment of a BFD session.

Working Principle

Session Establishment Process

BFD itself is unable to discover neighbors. It needs an upper-layer protocol to specify a neighbor to establish a session.

As shown in the following figure, two routers running OSPF and BFD are connected through a Layer-2 switch.

Figure 6-4

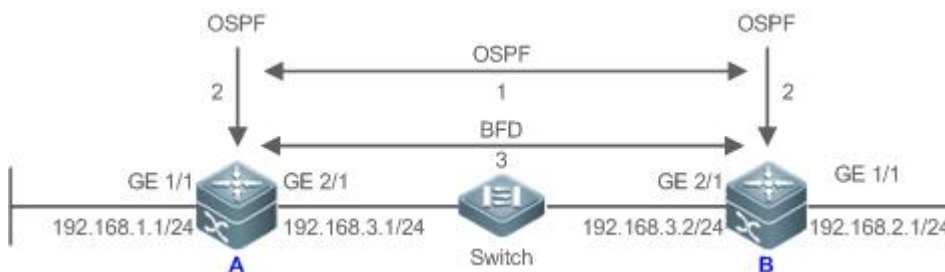

BFD session establishment process:

71. OSPF discovers a neighbor and establishes a connection with the neighbor.
72. OSPF instructs BFD to establish a session with the neighbor.
73. BFD establishes a session with the neighbor.

BFD Session Establishment Mode

The BFD protocol specifies that a BFD session can be established in two modes:

- Active mode

Before the establishment of a session, BFD actively transmits a control packet for establishing a BFD session regardless of whether it receives a control packet for establishing a BFD session from the peer end.

- Passive mode

BFD does not actively transmit a control packet for establishing a BFD session before a session is established but wait till it receives a control packet for establishing a BFD session from the peer end.

 The passive mode is not supported currently.

Negotiation of BFD Session Parameters

Both ends negotiate BFD session parameters during the establishment of a BFD session, to determine the transmission interval and detection time. Pay attention to the following points:

74. BFD session parameters (including **Desired Min Tx Interval**, **Required Min RX Interval**, and **Detect Mult**) must be set for interfaces at both ends. Otherwise, a BFD session cannot be established.
75. Interfaces at both ends negotiate BFD session parameters and detect the session based on the parameters during the establishment of a BFD session.
76. After a BFD session is established, both ends can dynamically negotiate BFD parameters (for example, minimum transmission interval and minimum receiving interval). After protocols at both ends transmit relevant negotiation packets, they adopt the new transmission interval and detection time, without affecting the current state of the session.

6.3.2 BFD Session Detection

Link detection starts after the establishment of a BFD session. BFD periodically transmits BFD control packets. If it fails to receive BFD packets from the peer end within the detection time, it deems that the session is Down and notifies the associated application to accelerate the convergence.

Working Principle

↘ Detection Process

As shown in the following figure, two routers running OSPF and BFD are connected through a Layer-2 switch.

Figure 6-5

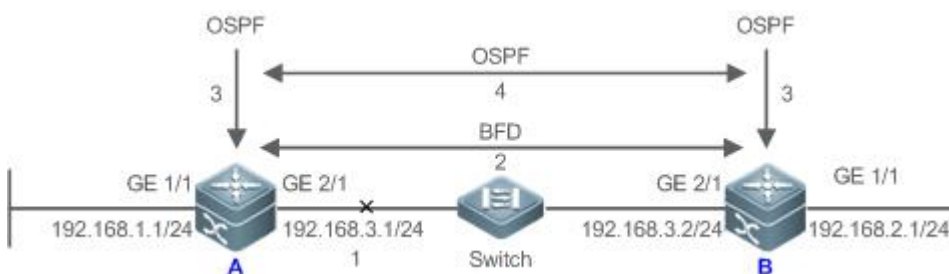

Handling procedure after a BFD session is Down:

77. The link between Router A and Switch fails.
78. The BFD session between Router A and Router B is Down.
79. BFD notifies the local OSPF that the forwarding path to the neighbor is faulty.
80. OSPF processes the neighbor Down situation. If a backup forwarding path is available, it starts protocol convergence to enable the alternative forwarding path.

↘ Detection Mode

BFD supports the following detection modes:

- Asynchronous mode



In asynchronous mode, systems transmit BFD control packets periodically to each other. If a system fails to receive BFD control packets from the peer end within the detection time, it advertises that the session is Down.

- Query mode

In query mode, it is assumed that each system has an independent method for confirming its connection with other systems. After a BFD session is established, the system stops transmitting BFD control packets unless it needs to explicitly verify the connectivity. In such a case, the system transmits a shot-sequence BFD control packet. If a system fails to receive a returned packet within the detection time, it advertises that the session is Down. If it receives a response from the peer end, the forwarding path is reachable.

- Echo mode

In echo mode, the local system periodically transmits BFD echo packets and a remote system receives and loops back the packets through the forwarding path. If the local system fails to receive several consecutive echo packets within the detection time, it advertises that the session is Down. The echo function can be used together the preceding two detection modes. The echo packet detection function does not require the involvement of the control plane of the remote system. Packets are returned by the forwarding plane of the remote system, which reduces the delay and ensures faster fault detection in comparison with transmission of control packets. The enabling of the echo function in asynchronous mode can greatly reduce transmission of control packets because the detection is accomplished by the echo function. The enabling of the echo function in query mode can thoroughly cancel transmission of control packets after a session is established. The echo function must be enabled at both ends of a BFD session. Otherwise, the echo function does not take effect.

-  The query mode is not supported and cannot be configured at present.
-  Only BFD session version 1 supports the BFD echo mode.
-  The echo mode is not supported for an IPv6 BFD session with the link-local address as the source or destination address.

6.3.3BFD Support for Applications

By BFD support, the associated applications can utilize the fast fault detection of BFD to improve the protocol convergence performance. In general, the fault detection time can be shortened within 1 second.

Working Principle

After BFD support for a certain application is enabled, a BFD session is established based on the BFD configuration. When a link fault occurs, BFD can rapidly identify the fault and notify the associated application to process, thereby improving its convergence. Currently, BFD supports the following applications:

- BFD support for RIP

After BFD support for the Routing Information Protocol (RIP) is enabled, RIP can utilize the BFD fault detection, which is faster than the ND mechanism of RIP, to improve the protocol convergence. In general, the fault detection time can be shortened within 1 second.

 -  For more details about BFD support for RIP, see *Configuring RIP*.
- BFD support for OSPF

After BFD support for OSPF is enabled, OSPF can utilize the BFD fault detection, which is faster than the ND mechanism of OSPF, to improve the protocol convergence. In general, the fault detection time can be shortened within 1 second.

 -  For more details about BFD support for OSPF, see *Configuring OSPF*.
- BFD support for OSPFv3

After BFD support for OSPFv3 is enabled, OSPFv3 can utilize the BFD fault detection, which is faster than the ND mechanism of OSPFv3, to improve the protocol convergence. In general, the fault detection time can be shortened within 1 second.

 -  For more details about BFD support for OSPFv3, see *Configuring OSPFv3*.
- BFD support for BGP

After BFD support for the Border Gateway Protocol (BGP) is enabled, BGP can utilize the BFD fault detection, which is faster than the ND mechanism of BGP, to improve the protocol convergence. In general, the fault detection time can be shortened within 1 second.

 For more details about BFD support for BGP, see *Configuring BGP*.

- BFD support for IS-IS

The Intermediate System to Intermediate System (IS-IS) protocol dynamically discovers a neighbor by using hello packets. After BFD is enabled, IS-IS uses BFD to establish a BFD session with a neighbor that is in the Up state and detect the neighbor status. When a BFD neighbor fails, IS-IS immediately performs network convergence. The convergence time can be shortened from 30 seconds (by default, on a point-to-point network, IS-IS hello packets are transmitted at an interval of 10 seconds and the neighbor failure time is triple the interval, that is, 30 seconds) to 1 second.

 For more details about BFD support for IS-IS, see *Configuring IS-IS*.

- BFD support for static routing

After BFD support for static routing is enabled, BFD prevents routers from selecting an unavailable static route as the forwarding path during routing and enables routers to rapidly switch to an available backup forwarding path.

Different from dynamic routing protocols, static routing does not have the ND mechanism. Therefore, after BFD support for static routing is configured, the next-hop reachability of a static route relies on the BFD session state. If a BFD session detects a fault, the next hop of a static route is unreachable and the static route is not added to the RIB.

If the remote system deletes a BFD session during the establishment of a BFD session, the BFD session becomes Down. In this case, the system ensures that the forwarding behavior of static routing is not affected.

 For more details about BFD support for static routing, see *Configuring NSM*.

- BFD support for PBR

After BFD support for PBR is configured, BFD prevents routers from selecting an unavailable policy route as the forwarding path during routing and enables routers to rapidly switch to an available backup forwarding path.

BFD support for PBR is equivalent to that for static routing. BFD tracks and detects the forwarding path to a specified neighbor. When a BFD session fails, BFD notifies the PBR that the next hop is unreachable. Then, the policy route to the next hop does not take effect.

If the remote system deletes a BFD session during the establishment of a BFD session, the BFD session becomes Down. In this case, the system ensures that the PBR forwarding behavior is not affected.

 For more details about BFD support for PBR, see *Configuring PBR*.

- BFD support for VRRP

The BFD support for the Virtual Router Redundancy Protocol (VRRP) can replace the ND mechanism of VRRP to rapidly detect the running status of the active and standby routers. When a fault occurs, it accelerates the active/standby router switching and improves network performance. In general, the fault detection time can be shortened within 1 second.

VRRP can also utilize BFD to track a specified neighbor. If the forwarding path to the neighbor fails during a BFD session, it automatically lowers the VRRP priority to a certain extent to trigger active/standby router switching. This configuration takes effect only when the dynamic routing protocol or other applications notify BFD to establish a session with a neighbor.

 For more details about BFD support for VRRP, see *Configuring VRRP*.

- BFD support for VRRP Plus

The BFD support for VRRP Plus can replace the BFD detection conducted by the balancing virtual gateway (BVG) of VRRP Plus to rapidly detect the running status of balancing virtual functions (BVs). When a fault occurs, it accelerates the forwarding entity switching and improves network performance. In general, the fault detection time can be shortened within 1 second.

VRRP Plus is based on the VRRP protocol. Therefore, no additional configuration is required for BFD support and only VRRP needs to be enabled on devices at both ends and a BFD session is correctly associated.

 For more details about BFD support for VRRP Plus, see *Configuring VRRP Plus*.

- BFD support for MPLS

The BFD support for Multiple protocol Label Switching (MPLS) refers that label switched paths (LSPs) use BFD to rapidly detect the neighbor status. The following detection modes are supported:

1. BFD detects static LSPs.
2. BFD detects LSPs generated by the Label Distribution Protocol (LDP).
3. BFD can detect reverse links of LSPs by using the IP protocols.

 For more details about BFD support for MPLS, see *Configuring MPLS*.

- BFD support for Layer-3 interfaces

BFD supports changing status of Layer-3 interfaces. In interface configuration mode, use the **bfd bind peer-ip** command to detect the direct address of a specified Layer-3 interface. After this CLI command is executed, a BFD session is created and the status of a Layer-3 interface can be changed based on the detection result of the BFD session, for example, BFD Down or BFD Up. This function is often used in various types of fast reroute (FRR), which uses BFD to detect the interface status to implement fast FRR switching.

 Only LDP FRR switching is supported in BFD support for Layer-3 interfaces.

- BFD support for L3AP member ports

After BFD support for Layer-3 access point (L3AP) member ports is enabled, BFD can rapidly detect a fault occurring on a member port link so that traffic on this link is rapidly distributed to other effective member links. In general, the fault detection time can be shortened within 1 second.

 For more details about BFD support for L3AP member ports, see *Configuring AP*.

6.3.4 BFD Protection

The BFD protection is used to protect BFD against session flapping caused by attacks (for example, a large number of ping packets attack devices).

Working Principle

The BFD protocol is very sensitive. If a BFD-enabled device is attacked (for example, attacked by a large number of ping packets) and BFD sessions flap, the BFD protection can be configured to provide protection. If both BFD and BFD protection are enabled on a device, the device discards the BFD packet from the previous hop, affecting the establishment of a BFD session between the previous-hop device and other devices.





6.3.5 BFD Flapping Dampening

A BFD session may frequently switch over between Down and Up due to link instability. As a result, an associated application (such as static routing) may frequently switch forwarding paths and the running services are affected. The BFD flapping dampening can solve this problem.

Working Principle

A BFD session may frequently switch over between Down and Up. This function allows users to set the delay for status change advertisement. After a BFD session is Up for a certain period of time, BFD notifies an associated application of BFD Up. Otherwise, BFD notifies an associated application of BFD Down.

6.4 Configuration

Configuration	Description and Command	
Configuring BFD Basic Functions	 (Mandatory) It is used to establish a BFD session.	
	bfd interval	Sets BFD parameters.
	N/A	Configures the BFD support for applications.  The configuration command varies with the associated applications. For details, see their configuration guides.
	 (Optional) It is used to configure the BFD detection mode, slow timer, and BDF support for Layer-3 interfaces.	
	bfd echo	Configures the BFD echo mode.
	bfd slow-timer	Configures the BFD slow timer.
	bfd bind peer-ip	Configures the BFD support for Layer-3 interfaces.
Configuring BFD Protection	 (Optional) It is used to protect BFD against attacks.	
	bfd cpp	Enables BFD protection.
Configuring BFD Flapping Dampening	 (Optional) It is used to protect associated protocols against BFD flapping.	
	bfd up-dampening	Configures BFD flapping dampening.

6.4.1 Configuring BFD Basic Functions

Configuration Effect

- Configure BFD support for applications.
- Establish a BFD session.
- A BFD session detects link faults.

Notes

- Pay attention to the following points when setting BFD session parameters:

1. It is recommended that parameter settings be consistent at both ends of a BFD session, to ensure that application protocols associated with BFD take effect simultaneously and prevent occurrence of one-way forwarding due to different dampening time at both ends.
 2. Take into account of transmission bandwidth differences of different interfaces when setting parameters. If the minimum transmission interval and minimum receiving interval are set to very small values, data transmission may be affected due to very large BFD bandwidth occupancy.
- Pay attention to the following points when configuring BFD support for applications:
 1. Ensure that it is enabled on neighbors of a BFD session. Otherwise, a BFD session cannot be established. If a dynamic routing protocol or another application requires BFD to establish a session with a neighbor, the BFD session can also be established.
 2. If the interface specified by a BFD session is different from the actual BFD packet outbound interface because of IP routing, or if the interface specified during BFD session creation is different from the actual BFD packet inbound interface, a BFD session cannot be established.
 - Pay attention to the following points when configuring the BFD detection mode:
 1. In the process that the forwarding plane of the peer device returns echo packets transmitted by the local end to the local end, the echo packets may be lost due to congestion of the peer device, causing a session detection failure. In this case, configure Quality of Service (QoS) policies to ensure that echo packets are processed preferentially or disable the echo function.
 2. The echo detection function of BFD does not support multi-hop detection. Ensure that the echo function is disabled when configuring multi-hops.
 3. The echo mode takes effect only after this mode is enabled at both ends of a BFD session.
 4. Before enabling the echo mode of BFD, run the **no ip redirects** command on the neighbors of a BFD session to disable the function of ICMP packet redirection, and run the **no ip deny land** command to disable the Distributed Denial of Service (DDoS) function (prevent the Land-based attack).

Configuration Steps

▾ **Setting BFD Parameters**

- Mandatory.
- BFD parameters need to be set at BFD session egresses of routers at both ends detected by BFD if no special requirements are raised.
- Take into account of transmission bandwidth differences of different interfaces when setting parameters. If the minimum transmission interval and minimum receiving interval are set to very small values, data transmission may be affected due to very large BFD bandwidth occupancy.

Command	bfd interval <i>milliseconds</i> min_rx <i>milliseconds</i> multiplier <i>interval-multiplier</i>
Parameter Description	interval <i>milliseconds</i> : Indicates the minimum TX interval, with the unit of milliseconds. min_rx <i>milliseconds</i> : Indicates the minimum RX interval, with the unit of milliseconds. multiplier <i>interval-multiplier</i> : Indicates the detection timeout multiplier.
Defaults	No BFD session parameter is configured.
Command Mode	Interface configuration mode
Usage Guide	The fast forwarding function must be enabled before the BFD function is enabled on routers.

➤ **Enabling the BFD Echo Mode**

- (Optional) Ports run in asynchronous mode by default. If a BFD session needs to run in echo mode, the echo mode needs to be configured.
- Complete the configuration on ports of switches or routers.
- A session runs in asynchronous mode as long as either of routers at both ends is configured to run in asynchronous mode. If routers at both ends are configured to run in echo mode by default, a BFD session finally runs in echo mode.

Command	bfd echo
Parameter	N/A
Description	
Defaults	The BFD echo mode is disabled.
Command Mode	Interface configuration mode
Usage Guide	<p>This command cannot be configured on AP interfaces.</p> <p>By default, when BFD session parameters are set, the system automatically enables the echo mode.</p> <p>The minimum TX interval and minimum RX interval of echo packets adopt the Interval milliseconds and min_rx milliseconds parameters of a session.</p> <p>Before enabling the echo mode of BFD, run the no ip redirects command on the neighbors of a BFD session to disable the function of ICMP packet redirection, and run the no ip deny land command to disable the Distributed Denial of Service (DDoS) function (prevent the Land-based attack).</p>

➤ **Configuring the BFD Slow Timer**

- (Optional) The default slow timer is 3,000 milliseconds. The value can be changed as required.
- Configure this function in global configuration mode of switches or routers.
- In BFD echo mode or session building, the slow timer is used to control packets. If the value increases, the required time for negotiating and establishing a BFD session becomes longer, and the time required for transmitting slow BFD packets in echo mode is longer.

Command	bfd slow-timer [milliseconds]
Parameter Description	<i>milliseconds</i> : Indicates the BFD slow timer, with the unit of milliseconds. The value ranges from 1,000 to 30,000 and the default value 3,000 is adopted if it is not set.
Defaults	The transmission interval of slow control packets is 3,000 milliseconds.
Command Mode	Global configuration mode
Usage Guide	This command is used to specify the slow timer in echo mode.

➤ **Configuring the BFD Support for Layer-3 Interfaces**

- (Optional) Currently, this function is used only when MPLS LDP is used for FRR.
- Configure this function on interfaces of switches or routers.

Command	bfd bind peer-ip src-address [source-ip dst-address] process-pst
Parameter Description	<p><i>src-address</i>: Indicates the peer IP address of an interface.</p> <p><i>dst-address</i>: Indicates the local IP address of an interface.</p>

Defaults	BFD support for Layer-3 interfaces is not configured by default.
Command	Interface configuration mode
Mode	
Usage Guide	This command is used to enable BFD support for Layer-3 interfaces so as to rapidly detect connectivity of Layer-3 interfaces.

▾ Configuring the BFD Support for Applications

- Mandatory.
- This function is disabled by default.
- The configuration command varies with the associated applications. For details, see their configuration guides.
- This function must be configured at both ends so that a BFD session can be established.
- In RIP routing configuration mode, run the **bfd all interfaces** command to enable BFD support for RIP on all interfaces. For details, see *Configuring RIP*.
- In OSPF routing configuration mode, run the **bfd all interfaces** command to enable BFD support for OSPF on all interfaces. For details, see *Configuring OSPF*.
- In OSPFv3 routing configuration mode, run the **bfd all interfaces** command to enable BFD support for OSPFv3 on all interfaces. For details, see *Configuring OSPFv3*.
- In BGP routing configuration mode, run the **neighbor address fall-over bfd** command to enable BFD support for BGP. For details, see *Configuring BGP*.
- In IS-IS routing configuration mode, run the **bfd all interfaces** command to enable BFD support for IS-IS on all interfaces. For details, see *Configuring IS-IS*.
- In global configuration mode, run the **ip route static bfd [vrf vrf-name] interface-type interface-number gateway [source ip-address]** command to enable BFD support for static routing. For details, see *Configuring NSM*.
- In global configuration mode, run the **ipv6 route static bfd [vrf vrf-name] interface-type interface-number gateway [source ip-address]** command to enable BFD support for IPv6 static routing. For details, see *Configuring NSM*.
- Run the **set ip next-hop verify-availability next-hop-address bfd [vrf vrf-name] interface-type interface-number gateway** command to enable BFD support for PBR. For details, see *Configuring PBR*.
- Run the **set ipv6 next-hop verify-availability next-hop-address bfd [vrf vrf-name] interface-type interface-number gateway** command to enable BFD support for IPv6 PBR. For details, see *Configuring PBR*.
- Run the **vrrip bfd interface-type interface-number ip-address** command to enable BFD support for VRRP. For details, see *Configuring VRRP*.
- VRRP Plus is based on the VRRP protocol. Therefore, no additional configuration is required for BFD support for VRRP Plus. Only VRRP needs to be enabled on devices at both ends and a BFD session is correctly associated.

Verification

- The verification command varies with the associated applications. For details, see their configuration guides.

Configuration Example

▾ Configuring BFD support for OSPF

<p>Scenario Figure 6-6</p>	
<p>Configuration Steps</p>	<ul style="list-style-type: none"> ● Configure IP addresses for interconnected interfaces of Router A and Router B. ● Run OSPF on Router A and Router B. ● Set BFD parameters for interconnected interfaces of Router A and Router B. ● Enable BFD support for OSPF on Router A and Router B.
<p>A</p>	<pre> A#configure terminal A(config)#interface GigabitEthernet2/1 A(config-if-GigabitEthernet2/1)# no switchport //The configuration is not required on routers. A(config-if-GigabitEthernet2/1)#ip address 192.168.3.1 255.255.255.0 A(config-if-GigabitEthernet2/1)#bfd interval 200 min_rx 200 multiplier 5 A(config-if-GigabitEthernet2/1)# exit A(config)#interface GigabitEthernet1/1 A(config-if-GigabitEthernet1/1)# no switchport //The configuration is not required on routers. A(config-if-GigabitEthernet1/1)#ip address 192.168.1.1 255.255.255.0 A(config-if-GigabitEthernet1/1)# exit A(config)# router ospf 123 A(config-router)# log-adj-changes detail A(config-router)# network 192.168.3.0.0.0.255 area 0 A(config-router)# network 192.168.1.0.0.0.255 area 0 A(config-router)# bfd all-interfaces A(config-router)# end </pre>
<p>B</p>	<pre> B#configure terminal B(config)#interface GigabitEthernet2/1 B(config-if-GigabitEthernet2/1)# no switchport //The configuration is not required on routers. B(config-if-GigabitEthernet2/1)#ip address 192.168.3.2 255.255.255.0 B(config-if-GigabitEthernet2/1)#bfd interval 200 min_rx 200 multiplier 5 B(config-if-GigabitEthernet2/1)# exit B(config)#interface GigabitEthernet1/1 B(config-if-GigabitEthernet1/1)# no switchport //The configuration is not required on routers. B(config-if-GigabitEthernet1/1)#ip address 192.168.2.1 255.255.255.0 B(config-if-GigabitEthernet1/1)# exit </pre>

	<pre> B(config)# router ospf 123 B(config-router)# log-adj-changes detail B(config-router)# network 192.168.3.0.0.255 area 0 B(config-router)# network 192.168.2.0.0.255 area 0 B(config-router)# bfd all-interfaces B(config-router)# end </pre>
Verification	Display verification.
A	<pre> A# show bfd neighbors details OurAddr NeighAddr LD/RD RH/RS Holdown(mult) State Int 192.168.3.1 192.168.3.2 1/2 Up 532 (3) Up Ge2/1 Local Diag: 0, Demand mode: 0, Poll bit: 0 MinTxInt: 200000, MinRxInt: 200000, Multiplier: 5 Received MinRxInt: 50000, Received Multiplier: 3 Holdown (hits): 600(22), Hello (hits): 200(84453) Rx Count: 49824, Rx Interval (ms) min/max/avg: 208/440/332 Tx Count: 84488, Tx Interval (ms) min/max/avg: 152/248/196 Registered protocols: OSPF Uptime: 02:18:49 Last packet: Version: 1 - Diagnostic: 0 I Hear You bit: 1 - Demand bit: 0 Poll bit: 0 - Final bit: 0 Multiplier: 3 - Length: 24 My Discr.: 2 - Your Discr.: 1 Min tx interval: 50000 - Min rx interval: 50000 Min Echo interval: 0 </pre>
B	<pre> B# show bfd neighbors details OurAddr NeighAddr LD/RD RH/RS Holdown(mult) State Int 192.168.3.2 192.168.3.1 2/1 Up 532 (5) Up Ge2/1 Local Diag: 0, Demand mode: 0, Poll bit: 0 MinTxInt: 50000, MinRxInt: 50000, Multiplier: 3 Received MinRxInt: 200000, Received Multiplier: 5 Holdown (hits): 600(22), Hello (hits): 200(84453) Rx Count: 49824, Rx Interval (ms) min/max/avg: 209/440/332 last: 66 ms ago Tx Count: 84488, Tx Interval (ms) min/max/avg: 153/249/197 last: 190 ms ago </pre>

Registered protocols: OSPF
Uptime: 02:18:49
Last packet: Version: 1 - Diagnostic: 0
I Hear You bit: 1 - Demand bit: 0
Poll bit: 0 - Final bit: 0
Multiplier: 5 - Length: 24
My Discr.: 1 - Your Discr.: 2
Min tx interval: 200000 - Min rx interval: 200000
Min Echo interval: 0

Common Errors

- BFD parameters are not set for device interfaces at one end.
- The BFD support for applications is disabled.
- The BFD support for applications is enabled only at one end.

6.4.2Configuring BFD Protection

Configuration Effect

- If a BFD-enabled device is attacked (for example, attacked by a large number of ping packets) and BFD session flaps accordingly, the BFD protection can be enabled to provide protection.

Notes

- The BFD basic functions must be configured.
- If both BFD and BFD protection are enabled on a device, the device discards the BFD packet from the previous hop, affecting the establishment of a BFD session between the previous-hop device and other devices.
- This function and limitations are applicable only to switches.

Configuration Steps

↘ Enabling BFD Protection

- Optional.
- Configure this function in global configuration mode on switches or routers.
- The BFD protection function raises the processing priority of BFD packets and ensures normal running of BFD services in a scenario in which devices are attacked.

Command	bfd cpp
Parameter	N/A
Description	
Defaults	The BFD protection function is enabled by default.
Command Mode	Global configuration mode

Usage Guide	Enable the BFD protection function to provide protection if a device encounters BFD flapping due to attacks.
--------------------	--

Verification

Run the **show running-config** command to verify the configuration on an interface.

Configuration Example

📌 **Enabling BFD Protection**

Configuration	<ul style="list-style-type: none"> ● Configure this function on a switch on a network where attacks exist.
Steps	<ul style="list-style-type: none"> ● Configure the BFD protection function.
	<pre>FS#configure terminal FS(config)# bfd cpp FS(config)# end</pre>
Verification	N/A

6.4.3 Configuring BFD Flapping Dampening

Configuration Effect

- A BFD session may frequently switch over between Down and Up due to link instability. As a result, a relevant application (such as static routing) may frequently switch forwarding paths and the running services are affected.
- Users can set the delay for status change advertisement, after which BFD notifies an associated application of BFD Up. After a BFD session is Up for a certain period of time, BFD notifies an associated application of BFD Up. Otherwise, BFD notifies it of BFD Down. The purpose is to reduce flapping of associated protocols caused by instable links.

Notes

- The BFD basic functions must be configured.
- If a BFD session does not frequently switch over between Down and Up, the enabling of BFD flapping dampening will delay notifying an associated application of BFD Up.

Configuration Steps

📌 **Configuring BFD Flapping Dampening**

- (Optional) The BFD flapping dampening is disabled on ports by default. If a BFD session frequently switches over between Down and Up, it is advised to enable this function.
- Configure this function on ports of switches or routers.
- With BFD flapping dampening enabled, it is relieved that associated applications, such as route re-calculation, process quantities of advertisements because of frequent status BFD change. The larger the configured time is, the longer the required BFD stability time is. BFD notifies an application module of BFD Up only after the stability time reaches the configured time.

Command	bfd up-dampening <i>[milliseconds]</i>
Parameter	<i>milliseconds</i> : Indicates the delay for status change advertisement, after which BFD notifies an associated application
Description	of BFD Up, with the unit of milliseconds. The value ranges from 0 to 300,000. The value 0 indicates that BFD notifies

	the application layer immediately when a session switches over from Down to Up and the default value is 0.
Defaults	The BFD flapping dampening function is disabled by default.
Command Mode	Interface configuration mode
Usage Guide	This function needs to be enabled only when the link is instable. If a BFD session does not frequently switch over between Down and Up, the enabling of BFD flapping dampening will delay notifying an associated application of BFD Up.

Verification

Run the **show running-config** command to verify the configuration on an interface.

Configuration Example

📌 **Configuring BFD Flapping Dampening with the Advertisement Delay as 60,000 Milliseconds**

Configuration Steps	<ul style="list-style-type: none"> ● Configure this function in an environment where BFD frequent flaps due to link instability. ● Set the delay for status change advertisement to 60,000 milliseconds.
	<pre>FS#configure terminal FS(config)# interface fastEthernet 0/2 FS(config)# bfd up-dampening 60000 FS(config)# end</pre>
Verification	N/A

6.5 Monitoring

Displaying

Description	Command
Displays BFD session information.	show bfd neighbors [<i>vrf vrf-name</i>] [<i>client {ap bgp ospf rip vrrp static-route pbr vrrp-balance ldp-lsp static-lsp backward-lsp-with-ip pst }</i>][<i>ipv4 ip-address ipv6 ip-address</i>][<i>details</i>]

Debugging

⚠ System resources are occupied when debugging information is output. Therefore, disable debugging immediately after use.

Description	Command
Debugs BFD events.	debug bfd event [<i>interface interface-type interface-number ipv4 ip-address ipv6 ipv6-address</i>]
Debugs BFD packets.	debug bfd packet [<i>interface interface-type interface-number ipv4 ip-address ipv6 ipv6-address</i>]

7 Configuring IP Event Dampening

7.1 Overview

When the Layer-3 port on a Layer-3 device frequently goes Up and Down due to manual enabling/disabling or other external causes, the routing table on the device will flap repeatedly. If a routing protocol is configured, the protocol may propagate the flap to the entire network, causing repeated updates and recalculation of neighboring routes, which wastes network bandwidths and destabilizes the network. Repeated route updates and recalculation on devices consume many CPU resources, which affects the normal running of customer networks.

IP Event Dampening detects abnormal Up/Down flapping and automatically suppresses frequent port state changes, which prevents the propagation of single-point link failures by a routing protocol. When the port is restored, it will be automatically unsuppressed, thus reducing network flaps and CPU resource consumption while improving network stability.

Protocols and Standards

- RFC2439: BGP Route Flap Dampening
- At its core, the suppression algorithm used by IP Event Dampening is the same as that used by BGP Route Flap Dampening.

7.2 Applications

Application	Description
Routed Port Flap Dampening	Monitors the state change of the Layer-3 port on a router, and suppresses frequent port flapping.

7.2.1 Routed Port Flap Dampening

Scenario

In a network that runs a routing protocol, when a port on a router connected to another router frequently goes Up and Down, neighboring routes will be repeatedly updated and recalculated. The routing protocol may propagate the flap to the entire network, causing a network flap. IP Event Dampening can be enabled on the connected routers to monitor port state changes and suppress frequent port flapping, thus reducing network flaps and CPU resource consumption while improving network stability.

Figure 7-1



Remarks	A and B are routers.
----------------	----------------------

Deployment

Configure IP Event Dampening on portGE0/1 on Router A and portGE0/1 on Router B respectively.



The subinterfaces and the virtual templates of interfaces on routers do not support the dampening feature.

7.3 Features

Basic Concepts

↘ **Penalty**

A port that goes Up or Down gets a penalty for each state change, but the penalty decays exponentially when the port is stable. In this way, port behaviors can be sensed and controlled intelligently.

↘ **Suppress Threshold**

When the cumulative penalty of a port exceeds a suppress threshold, the port is considered to flap and will be suppressed.

↘ **Half-Life Period**

The half-life period is the period required for the penalty to decrease to half of the original value when the port is stable. It defines the speed at which the penalty decays exponentially. The shorter the half-life period, the faster the penalty decays, and the faster the port is detected to be stable, but the flap detection sensitivity is reduced.

↘ **Reuse Threshold**

When the port no long flaps and its penalty decays to a certain degree (below the suppress threshold), the port is considered to be stable and is unsuppressed.

↘ **Maximum Suppress Time**

When a port keeps flapping and reaches a very large penalty, the port will not be usable for a long time. To avoid this problem, the maximum suppress time is defined to always maintain the port suppression duration below a certain value no matter how long the port has flapped.

Overview

Feature	Description
Port Flap Suppression	Configure the criteria and parameters of flap suppression on ports to enable switches to identify and suppress frequently flapping ports, which ensures route stability and avoids route flap propagation.

7.3.1 Port Flap Suppression

Working Principle

A port configured with IP Event Dampening is assigned a penalty. The port gets a penalty of 1,000 each time when it goes Down, but the penalty decreases with time. If the port goes Down again, the penalty increases accordingly. When the cumulative penalty exceeds the suppress threshold, the port will be suppressed. For the affected upper-layer protocol, the suppressed port is always Down no matter what the actual port state is. When the penalty decreases to the reuse threshold, the port will be unsuppressed, and the upper-layer protocol can sense the actual port state.

If a Layer-3 port is not configured with IP Event Dampening, or is not suppressed by it, the routing protocol or other protocol concerned about the port status still work normally. When the port is suppressed, the upper-layer protocol considers the port to be Down. Any state change of the port before the port is unsuppressed does not affect the routing table and the route calculation and advertisement performed by the upper-layer routing protocol.

Related Configuration

📌 **Configuring IP Event Dampening**

- By default, IP Event Dampening is disabled on Layer-3 ports.
- Run the **dampening** [*half-life-period* [*reuse-threshold* *suppress-threshold* *max-suppress* [**restart** [*restart-penalty*]]]] command to enable or disable IP Event Dampening on Layer-3 ports.

7.4 Configuration

Configuration	Description and Command
<u>Enabling IP Event Dampening</u>	 (Mandatory) It is used to suppress Layer-3 port flapping.
	dampening Configures IP Event Dampening.

7.4.1 Enabling IP Event Dampening

Configuration Effect

When a port configured with IP Event Dampening keeps flapping until the predefined threshold is exceeded, the port is set to Down.

Notes

- When a Layer-3 port on a switch is converted to a Layer-2 port (for example, from a routed port to a switch port), the IP Event Dampening configuration on the port will be deleted.

Configuration Steps

📌 **Configuring IP Event Dampening**

- Mandatory.
- Perform the configuration in Layer-3 interface configuration mode.
- You can specify the half-life period, reuse threshold, suppress threshold, maximum suppress time, and initial penalty. If you do not set these parameters, their default values will be used.

Verification

Use any one of the following commands to check whether the configuration takes effect:

- **show running-config**
- **show interfaces** [*interface-id*] **dampening**, which is used to check the IP Event Dampening configuration on a specified port

Related Commands

➤ **Enabling IP Event Dampening on a Port**

Command	dampening [<i>half-life-period</i> [<i>reuse-threshold</i> <i>suppress-threshold</i> <i>max-suppress</i> [restart [<i>restart-penalty</i>]]]]
Parameter Description	<p><i>half-life-period</i>: Indicates the half-life period. Value range: <1–30>; default value: 5s.</p> <p><i>reuse-threshold</i>: Indicates the reuse threshold. Value range: <1–20,000>; default value: 1,000.</p> <p><i>suppress-threshold</i>: Indicates the suppress threshold. Value range: <1–20,000>; default value: 2,000.</p> <p><i>max-suppress</i>: Indicates the maximum suppress time. Value range: <1–255>; default value: four times the half-life period.</p> <p>restart <i>restart-penalty</i>: Indicates the initial penalty. Value range: <1–20,000>; default value: 2,000.</p>
Command Mode	Interface configuration mode
Usage Guide	<p>IP Event Dampening can affect direct routes, host routes, static routes, dynamic routes, and VRRP. When a port is suppressed based on the configured criteria, the affected modules determine that the port is Down and therefore delete corresponding routes. No data packet will be transmitted through the port.</p> <p>When the dampening command is rerun on a port configured with IP Event Dampening, the dampening information on the port will be cleared, but the flap count is retained, unless you use the clear counters command to clear the counters on the port.</p> <p>If the max-suppress parameter is set to a very small value, making the maximum penalty smaller than the suppress threshold, the port will never be suppressed. When such a configuration error occurs, the following message indicating a configuration failure will be printed:</p> <pre style="background-color: #f0f0f0; padding: 5px;">% Maximum penalty (10) is less than suppress penalty (2000). Increase maximum suppress time</pre> <p>If the available system memory is insufficient to run the dampening command, the following message indicating a configuration failure will be printed:</p> <pre style="background-color: #f0f0f0; padding: 5px;">% No memory, configure dampening fail!</pre>

Configuration Example

➤ **Configuring IP Event Dampening on Layer-3 Ports**

Scenario Figure 7-2	
Configuration Steps	Enable IP Event Dampening on port GigabitEthernet 0/1 on Router A and on port GigabitEthernet 0/1 on Router B respectively, and set half-time-period to 30s, reuse-threshold to 1,500, suppress-threshold to 10,000, and max-suppress to 120s.
A	<pre style="background-color: #f0f0f0; padding: 5px;">FS(config)#interface GigabitEthernet 0/1 FS(config-if-GigabitEthernet 0/1)#dampening 30 1500 10000 100</pre>
B	<pre style="background-color: #f0f0f0; padding: 5px;">FS(config)#interface GigabitEthernet 0/1 FS(config-if-GigabitEthernet 0/1)#dampening 30 1500 10000 100</pre>
Verification	Run the show interfaces dampening command to check the IP Event Dampening configuration on the

	corresponding ports.
	<pre> FS#show interfaces dampening GigabitEthernet 0/1 Flaps Penalty Supp ReuseTm HalfL ReuseV SuppV MaxSTm MaxP Restart 0 0 FALSE 0 30 1500 1000 100 15119 0 </pre>

Common Errors

- The port on a Layer-3 switch is not converted to a routed port by using the **no swiwithport** command before IP Event Dampening is configured.

7.5 Monitoring

Clearing

Description	Command
Clears the interface counters.	clear counters

For details about the **clear counter** command, see the related chapter for the "Interface" command.

Displaying

Description	Command
Displays the counters on suppressed ports.	show dampening interface
Displays the IP Event Dampening configuration on ports.	show interfaces dampening

Debugging

System resources are occupied when debugging information is output. Therefore, disable debugging immediately after use.

Description	Command
Enables debugging of IP Event Dampening.	debug dampening interface

8 Configuring VSU

8.1 Overview

In order to improve the reliability of networks, the two devices at core layer and convergence layer of traditional networks are configured with two cores to provide redundancy. Access and convergence devices are respectively connected to the cores through two links. The following figure shows a typical traditional network architecture. Redundant network architecture increases the complexity of network design and operation. At the same time, a large number of redundant links reduce the utilization of network resources and return on investment.

Figure 8-1 Traditional network architecture

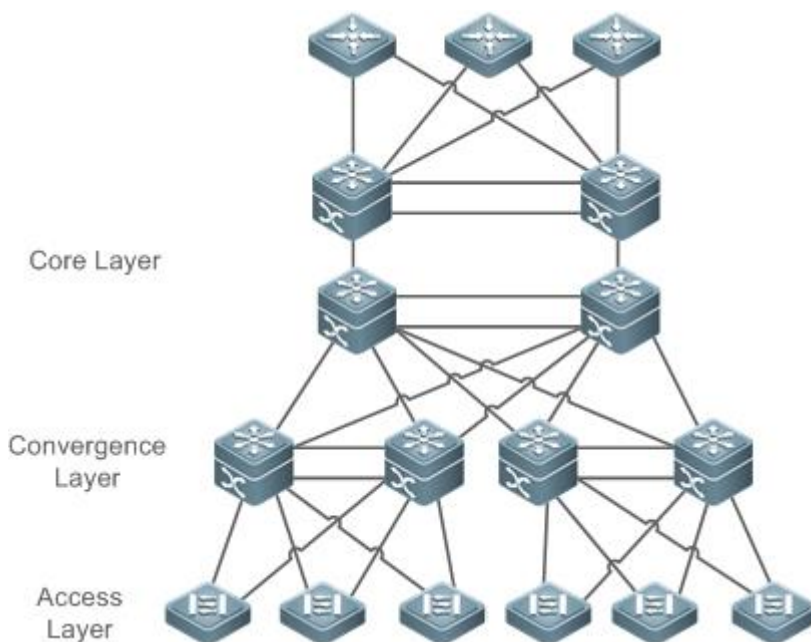

Virtual Switching Unit (VSU) is a kind of network system virtualization technology that supports combining multiple devices into a single virtualized device. As shown in Figure 8-2, access, convergence and core layer devices can respectively form VSUs, and then these VSUs connect to one another to form an end-to-end VSU network. Compared with traditional network, this networking can:

- Simplify the network topology.
- Reduce the costs of network management and maintenance.
- Shorten application recovery time and service interruption time.
- Enhance the utilization of network resources.

Figure 8-2 End-to-End VSU Networking

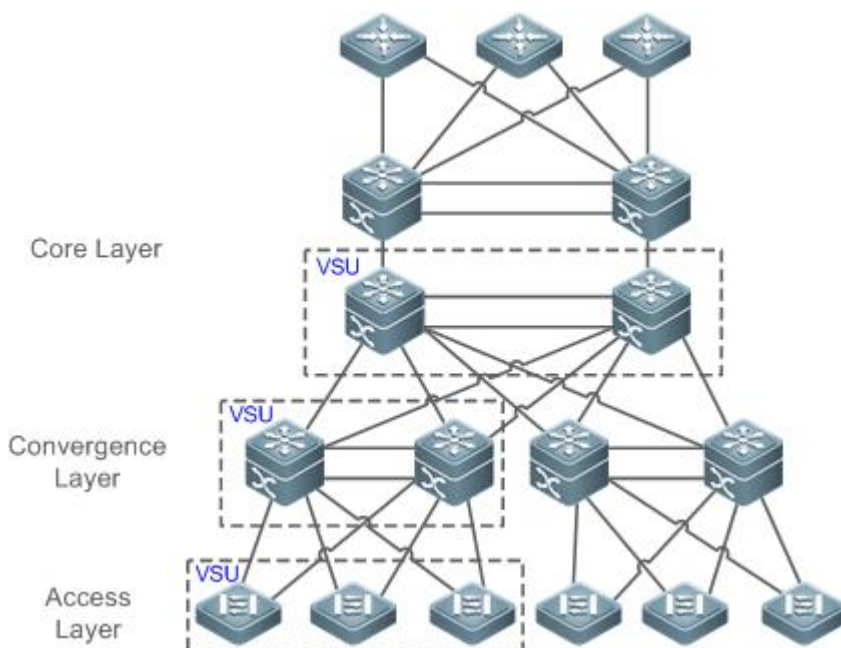

8.2 Applications

Application	Description
Managing Multiple Devices in a Unified Manner	Uses multiple physical devices as a logical device for unified management.
Simplifying Networking Topology	Uses a VSU as a logical device to simplify the networking topology.

8.2.1 Managing Multiple Devices in a Unified Manner

Scenario

When multiple physical devices form a VSU system, the physical devices can be viewed as a logical device. All configurations are managed on the global master device.

As shown in Figure 8-3, four devices (numbered as 1, 2, 3, and 4 from left to right) form a VSU system. Device 1 is the global master device, device 2 is the global slave device, and devices 3 and 4 are the global candidate devices.

- All devices are configured simply on the global master device.

Figure 8-3



Remarks	<p>The devices from left to right in Figure 1-3 are Device 1, Device 2, Device 3 and Device 4.</p> <p>For details on VSL, see the description in section 1.3.1.</p> <p>Device 1 is the global master device.</p> <p>Device 2 is the global slave device.</p> <p>Devices 3 and 4 are the global candidate devices.</p>
----------------	---

Deployment

- The global master device controls the entire VSU system, runs control-plane protocols and is involved in data forwarding.
- The global slave device is involved in data forwarding, does not run control-plane protocols, and works as the backup and takes over the work of the global master device when faulty.
- The global candidate devices are involved in data forwarding and do not run control-plane protocols. When the global slave device is faulty, a global candidate device can take over the work of the global slave device. In this case, when the global master and slave devices are faulty, the VSU system will restart.

8.2.2 Simplifying Networking Topology

Scenario

In traditional networks as shown in Figure 8-4, redundant devices and lines need to be added to increase the networking reliability; however, many algorithms also need to be introduced to prevent loops, which make the networking more complex. In the VSU system, all devices are viewed as a logical

device. Different devices back up each other, and no loop prevention algorithm needs to be introduced, which can simplify the network.

- Two aggregate switches form a VSU system. It is unnecessary to configure a loop prevention algorithm. The two switches are redundant mutually.
- The access switch is connected to the aggregate switches through the uplink AP.
- When a switch in the VSU system is faulty, the other link still works.

Figure 8-4

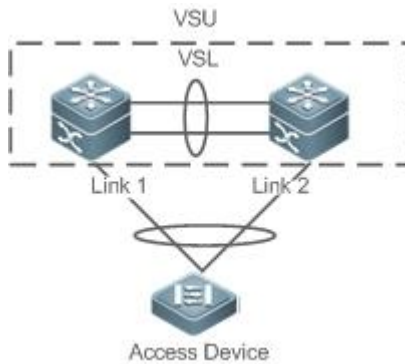

Deployment

- The global master device controls the entire VSU system, runs control-plane protocols and is involved in data forwarding.
- The global slave device is involved in data forwarding, does not run control-plane protocols, and works as the backup and takes over the work of the global master device when the global master device is faulty.
- The access switch is oriented to users and allows access by users' devices.

8.3 Features

Basic Concepts

VSU System

VSU system is a single logical entity consisting of two or multiple devices in traditional network architecture. For example, the convergence layer VSU system as shown in the following figure can be seen as a single device that interacts with the core layer and access layer.

Figure 8-5 Convergence layer VSU

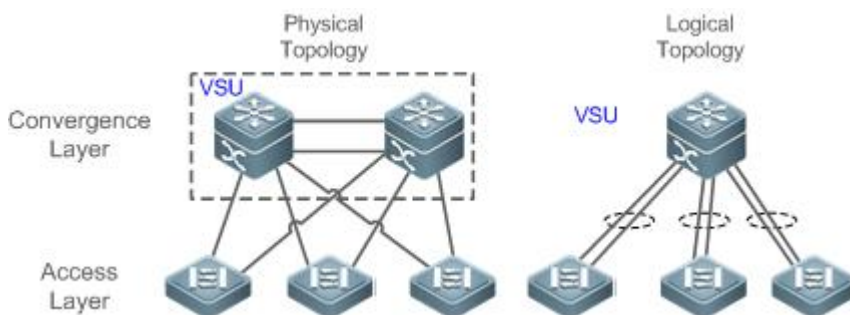

In the above VSU network structure, the member devices form a logical entity through internal links and the access layer devices are connected to the VSU through aggregated links. In this way, there is no layer 2 loop between the access and convergence layers.

Figure 8-6 Access layer VSU

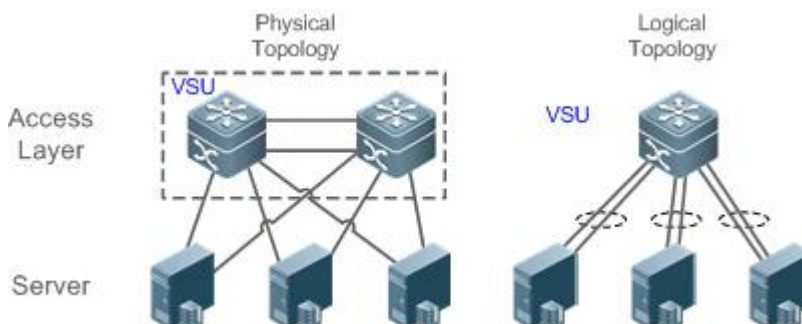

Except the core and convergence layer devices, the access layer devices can also form a VSU system. A server that requires high availability can adopt multiple network cards to form an Aggregate Port (AP) to connect access layer devices. Since AP can only connect to the same access device, the risk of single device fault increases. In this case, VSU can be used to solve the problem. In the VSU mode, a server adopts multiple network cards and binds them into an AP to connect different member devices in the same VSU group. This way can prevent single point failure and network interruption caused by single link failure.

➤ VSU Domain ID

A VSU domain has only one ID. Only the devices with the same domain IDs can form a VSU system.

➤ Member Device ID

Every member device in a VSU system has a unique ID, namely, Switch ID. Switch IDs can be used in device management or configuring interfaces on member devices. You need to configure an ID for a device when adding the device to a VSU system and ensure that the ID is unique in the same VSU system. If an ID conflict occurs, the VSU system will reserve one device according priority.

➤ Member Device Role

A VSU system consists of several devices. When establishing a VSU system, you need to select a global master device and a global slave device. All other devices are global candidate devices. A global master device is elected from multiple devices based on an election protocol. All other devices are global slave devices in the 1: N hot standby mode. When the 1:1 hot standby mode is supported, one device is the global master device, one device is the global slave device, and all other devices are global candidate devices.

The global master device is responsible for controlling the entire VSU system, running control plane protocols and participating in data forwarding. Other devices, including the global slave devices and candidate devices, participate in data forwarding but do not run control plane protocols. All received control plane data flows are forwarded to the global master device for processing.

The global slave device also receives the statuses of the global master device in real-time and provide 1:1 or 1:N redundancy with the global master device. If the global master device becomes faulty, the global slave device will take over services from the master device and manage the entire VSU system.

- ? The following is the method for selecting the master device of a VSU system:
 2. Rules for selecting the master device of a VSU system include (Continue with the next rule if the previous rule does not help in selecting the master device): a) Select the currently running host as the master device with the highest priority (All devices are not master devices during startup). b) Select the device with the highest priority as the master device. c) Select the device with the lowest device No. as the host. d) Select the device with the smallest MAC address as the master device.
 3. In the 1:N hot standby mode, select the device that has the most familiar configurations with the master device as the slave device to prevent dual active devices. The selection order is: the nearest/the highest priority/the smallest MAC address.
 4. VSU system supports hot adding a support device. Even the hot added device has a higher priority than the master device has, the VSU system does not perform active/standby switch.
 5. The startup order of member device may affect the election of master device. A member device may not join in the VSU system because it starts up too slowly. In this case, the device will be hot added to the VSU system. Even the device has a higher priority than the master device, the VSU system does not perform active/standby switchover.

Overview

Feature	Description
<u>Virtual Switching Link (VSL)</u>	In a VSU system, a virtual link is used to connect all devices.
<u>Topology</u>	Describes the internal topology of a VSU system.
<u>Dual-Active Detection (DAD)</u>	Avoids that dual master switches coexist in a VSU domain.
<u>System Management</u>	Describes possible connections between external devices and VSU devices.
<u>Quick Blinking Location</u>	Manages devices in the VSU system.

8.3.1 Virtual Switching Link (VSL)

Working Principle

➤ VSL

The VSU system is a network entity that consists of multiple devices. These devices need to share control information and part of data streams. The VSL is a special link used for transmission of control information and data streams among devices of the VSU system. For example, the VSL can be established between two devices through 10 Gigabit Ethernet interfaces. Figure 8-7 shows the position of the VSL in the VSU system.

Figure 8-7 VSL

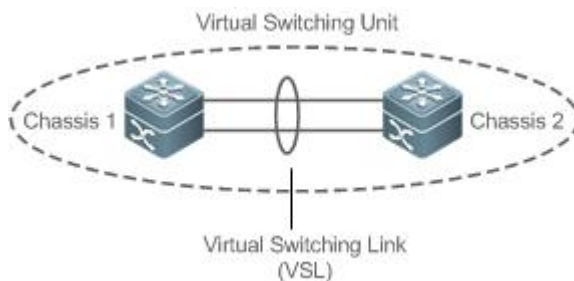

The VSL exists in the form of AP groups. The data streams transmitted through the VSL balance load among the aggregation port members according to the traffic balancing algorithm.

➤ VSL Traffic

The control streams transmitted through the VSL between devices include:

1. The protocol packets received by the member devices: These protocol packets need to be forwarded through the VSL to the global master device for processing.
2. The protocol packets processed by the global master device: These protocol packets need to be forwarded through the VSL to the interfaces of other member devices and then sent to the peer devices by these interfaces.

The data streams transmitted through the VSL between devices include:

1. The data stream flooded on the VLAN
2. The data streams that need to be forwarded across devices and transmitted through the VSL

Furthermore, the internal management packets of the VSU system are also transmitted through the VSL. The management packets include the protocol information switched by the hot backup and configuration information delivered by the host to other member devices.

- ❓ In terms of the switched port analyzer (SPAN) function, the interface associated with the VSL cannot be regarded as the source port or destination port of the SPAN.

↘ VSL Failure

If a certain member link connected to the VSL AP group fails to work, the VSU will adjust the configurations of the VSL aggregation port automatically to prevent the traffic from being transmitted through the faulty member link.

If all member links are disconnected to the VSL AP group, the VSU topology will change. If the original VSU topology is a ring topology, the ring will convert into a line. For details, see topology ring and line conversion in the section of *Topology Changes*.

↘ Detecting Error Frames on a VSL Interface

When a large number of consecutive error frames are detected on a VSL interface, the interface must be disabled and switched to another VSL interface. The detection method is as follows:

If error frames are found on a VSL interface, perform error frame correction. The system detects the VSL interface every 5 seconds by default. If the number of error frames is greater than the value of *num* as compared with that detected last time, it is assumed that error frames are detected once. If error frames are detected consecutively for the value of *times*, it is assumed that the interface is abnormal. If multiple VSL links are available when error frames are detected, the VSL will be switched. The last VSL will not be switched in order to prevent topology splitting.

Different user scenarios have different requirements for *num* and *times*. The default value of *num* is 3 and that of *times* is 10. If users have strict requirements on the scenarios, select smaller values for *num* and *times*; if reverse, select greater values.

8.3.2 Topology

The VSU system supports line topology and ring topology. Devices are connected through a VSL to form a line that is called the line topology.

Working Principle

↘ Topology

The line topology is simple. It uses a very few ports and cables. Two devices are connected with a communication link only. Therefore, the VSL has low reliability.

Figure 8-8 Line topology



Except for the line topology, devices can also form a ring topology, as shown in Figure 8-9. In the ring topology, the two communication links between devices can back up for each other and perform link redundancy to improve the reliability of the VSU system.

Figure 8-9 Ring Topology

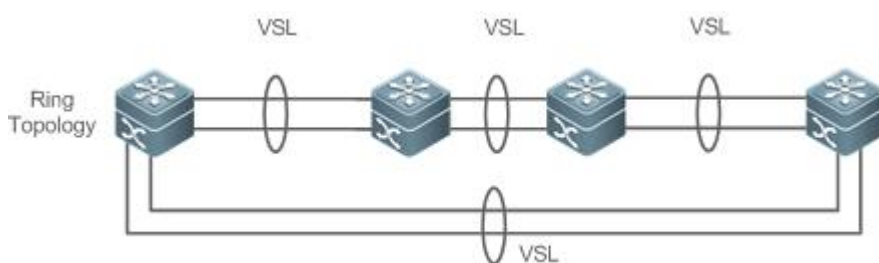

- ? You are advised to select the ring topology for the VSU system, thus the normal operation of the whole VSU system will not be affected by any single faulty device or VSL.
- ? Besides selecting the ring topology networking, you are advised to configure multiple VSLs for every VSL member to improve the reliability of a single VSL. At least two links are recommended and a maximum of four links can be configured. A reasonable configuration comprises more than two VSLs crossing different cards.

➤ Topology Convergence

Before the establishment of the VSU, the member devices need to discover neighbors through topology discovery protocols and check devices in the VSU system to confirm the range of the management domain. Then a global master device is selected to manage the whole VSU system and a global slave device is selected for backup of the master device. Then the whole VSU topology is converged. As the start up time differs for different devices, the first convergence time of the topology is also different.

➤ Topology ring and Line Conversion

In a ring topology, if a VSL link is disconnected, the ring topology will convert into a line topology. The whole VSU system will still run normally without network disconnection. To prevent other VSL links and nodes from being faulty, you are advised to locate the VSL failures and recover the availability of the VSL. After the VSL link is recovered, the line topology will convert into the ring topology.

Figure 8-10 Ring-to-line and line-to-ring

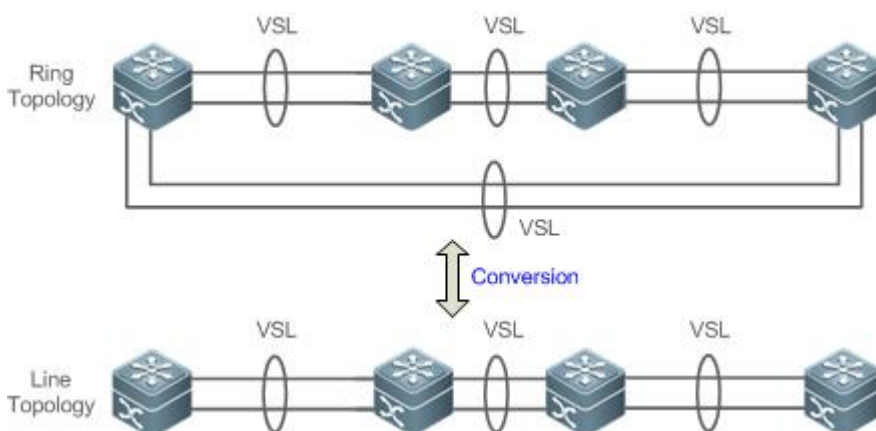

➤ **Topology Splitting**

In the line topology, if the VSL link is disconnected, the line topology will be split, as shown in Figure 8-11. A VSU group is split into two groups. In this condition, two devices with the absolutely same configurations may exist on the network, which will cause abnormal operation of the network. Therefore, the multi-active detection (MAD) function needs to be deployed to solve the problem of topology splitting.

Figure 8-11 Topology splitting

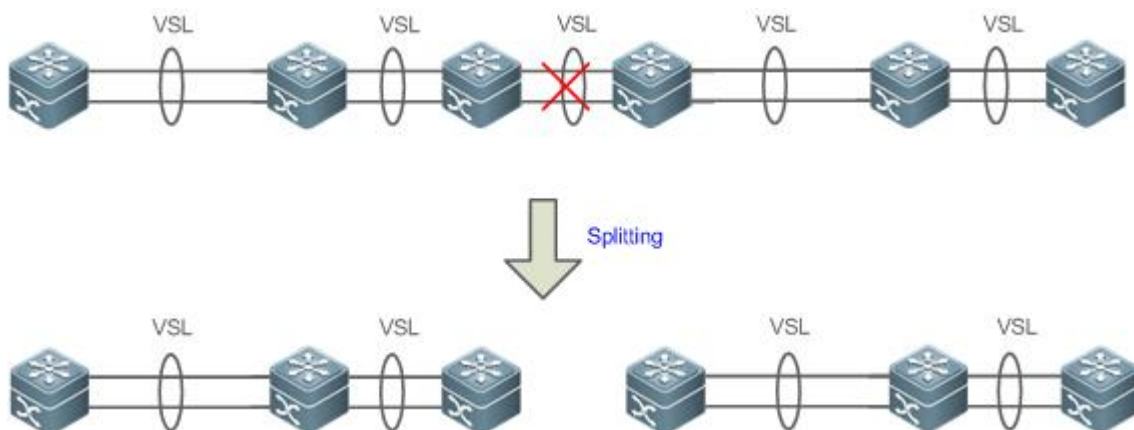

➤ **Topology Combining**

If the two VSU groups are connected through the VSL link, the line topology will be combined. During the topology combining, restart one VSU group and then hot add the other VSU group.

The principle of topology combining: Minimizing influences on the services during topology combining. The rules are as follows (Judge from the first item. If you cannot select the optimal topology, continue to judge the next item):

- Use the device priority as the first criteria for judging topology combining. Reserve the VSU group containing a device with the highest priority.
- If the previous item cannot help make a judgment, select the VSU group with a smaller switch ID (that of the two global master switches).

- If the previous item cannot help make a judgment, reserve the VSU group with a smaller MAC address (that of the global master switches).

Figure 8-12 Topology combining

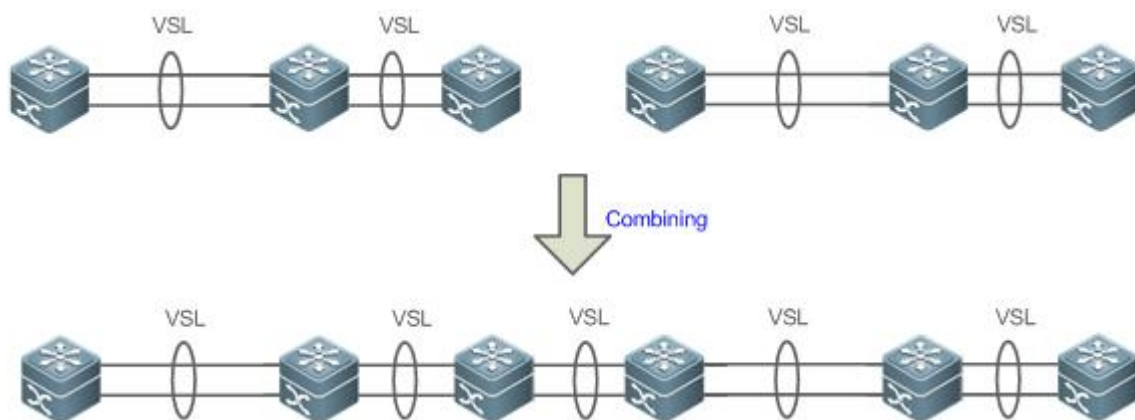

- ❓ During topology combining of two VSU groups, the two VSU groups need to be elected. The VSU group that fails the election will restart automatically and hot add to the other VSU group.

8.3.3 Dual-Active Detection (DAD)

Working Principle

When the VSL is disconnected, the slave device switches to the master device. If the original master device is still running, a series of problems including IP address conflict on the LAN will be caused due to there are two master devices and their configurations are the same completely. In this condition, the VSU system must detect the two devices and take recovery measures. The VSU system provides two methods to perform MAD as follows:

- Bidirectional forwarding detection (BFD)
- AP-based detection

➤ MAD Rules

1. Select the VSU group with the highest priority.
2. If the previous item cannot help make a judgment, select the VSU group with more physical devices.
3. If the previous item cannot help make a judgment, select the VSU group with a higher health. (Health: total bandwidth of all physical interfaces (except for management and VSL interfaces) in the UP state in the topology.)
4. If the previous item cannot help make a judgment, select the VSU group with a smaller switch ID (that of the two global master switches).
5. If the previous item cannot help make a judgment, reserve the VSU group with a smaller MAC address (that of the two global master switches).
6. If the previous item cannot help make a judgment, reserve the VSU group with a greater startup time (that of the global master switches).

➤ BFD

The VSU system supports the BFD to detect multiple master devices. Figure 8-13 shows the topology. A link is added for the two devices on the edges for MAD specially. When the VSL link is disconnected between the global master and slave devices, two master devices exist concurrently. If the BFD function is set, the two master devices will send the BFD packets to each other through the BFD link. Thereby the same devices are detected on the current system. Finally shut down the VSU system of a master device according to some rules and enter the recovery state to avoid network abnormality.

Figure 8-13 BFD



- ⚠ When there is a pair of BFD links, you are advised to deploy the detection links at the two ends of the topology.
- ⚠ You need to adopt the extension BFD and you cannot configure the dual-active detection port by using the existing BFD configurations and commands.

➤ **MAD**

The VSU system also supports the MAD dual-active detection mechanism. Figure 8-14 shows the topology. The VSU system and the upstream device both need to support the MAD function. When the VSL link is disconnected, two master devices exist concurrently. The two master devices respectively send the MAD packets to the member ports of the MAD-APs and then the MAD packets are forwarded to each other through the upstream device. As shown in Figure 8-14, the MAD-AP has four member ports. Each member port is connected to a different device of the VSU system. When the topology splitting occurs, the four member ports all send and receive the MAD packets. Thereby the same devices are detected on the current system. Finally shut down the VSU system of a master device according to some rules and enter the recovery state to avoid network abnormality.

Figure 8-14 MAD based on upstream and downstream devices

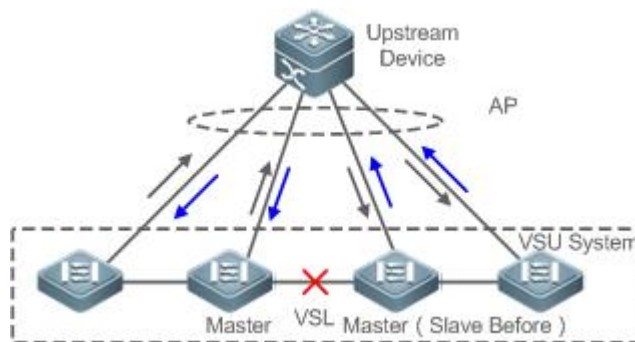

In the topology above, the upstream device must be FS device and support the MAD packet forwarding function.

8.3.4 VSU Traffic Forwarding

Working Principle

↘ Cross-device AP Group

An AP binds multiple physical links together to form a logical link. The VSU system supports the AP across the member devices.

As shown in Figure 8-15, two devices form a VSU group. The external access device Switch A is connected to the VSU in the form of the AP. In terms of Switch A, there is no difference between the AP in Figure 8-15 and the common AP group.

Figure 8-15 Cross-device aggregation port

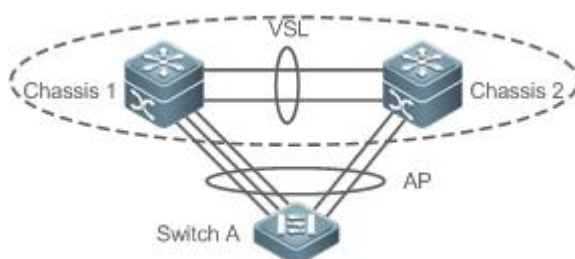

↘ Troubleshooting

You are advised to configure the cross-device AP with the physical link between the peripheral device and each VSU device. On the one hand, the VSL bandwidth can be reserved (prioritize the AP member of the same chassis as the egress to transmitted the cross-chassis AP traffic and prevent unnecessary traffic from being transmitted through the VSL link). On the other hand, the network reliability can be improved (if a certain chassis is faulty, the member ports of normal devices can work normally).

The follows sections describe the possible faults of the cross-device AP and the consequences.

- Single link failure

If a single link of the cross-device AP is faulty but other links still work normally, the cross-device AP will reallocate the traffic for the remaining normal links.

- Link failure of all cross-device AP member ports on the global master device

If the links of all cross-device AP member ports on the global master device fail to work, only the member ports of other member devices continue working normally. In terms of the data stream transmitted through the AP to the VSU system, if the data stream forwarding egress is on the global master device, the system will forward the data stream to the corresponding egress on the global master device through the VSL link.

The control plane protocols are still running on the global master device. Therefore, the protocol packets that enter the VSU system need to be forwarded to the global master device through the VSL link for protocol computing.

- Failure of all links of other member devices

If all links of the cross-device AP and a single device A fail to work, only the member ports of other member devices continue working normally. In terms of the data stream transmitted through the AP to

the VSU system, if the data stream forwarding egress is on the member device A, the system will forward the data stream to the corresponding egress on the member device A through the VSL.

- **Global master device fault**

If the global master device is faulty, the hot backup switching is performed to switch the original slave device to the master device. Meanwhile, the member ports on other member devices continue working. The link failure is detected on the peer device connected to the VSU through this AP. Therefore, the traffic balancing algorithm needs to be adjusted to allocate the data stream to normal links.

- **Member device fault**

If a member device is faulty, the AP member link connected to this member device is disconnected. However, other member links still work normally. The link failure is detected on the peer device connected to the VSU through this AP. Therefore, the traffic balancing algorithm needs to be adjusted to allocate the data stream forwarding paths to normal links.

↘ **Traffic Balancing**

In a VSU system, traffic may have multiple egresses. The AP and ECMP have their own traffic balancing algorithms, for example, using destination or source MAC addresses. For details, see the *Configuring Aggregate Port*. The local forwarding first (LFF) can be configured detailed in this configuration manual. Packets received by a device are forwarded on this device first. In this way, packets can be forwarded to other devices without using a VSL.

8.3.5 System Management

Working Principle

↘ **Access to the Console**

The master device console of VSU system manages multiple devices on the system simultaneously. The consoles of the slave and candidate devices do not support command line input. However, you can configure the VSU system on the master device for a specified member device and log in to the master device console through the serial port of the slave device. A session can be used to redirect to the master console of a device.

↘ **Slot Naming**

In terms of the chassis device, in the VSU mode, the slot is named with the device number (Switch ID). Therefore, the slot number turns from one-dimensional into two-dimensional. For example, cable clip 1/1 indicates the slot numbered 1 of the slot 1 on a member device.

↘ **Interface Naming**

In the VSU working mode, a slot number may occur in multiple devices. Therefore, the interface is named with the device number (Switch ID).

For example, interface gigabitEthernet 1/0/1 indicates the Gigabit port 1 on the slot 0 of the device whose ID is 1; interface gigabitEthernet 2/0/2 indicates the Gigabit port 2 on the slot 0 of the device whose ID is 2.

↘ **Access to the File System**

In the VSU working mode, you can access to the file system on other member devices from the master device. The detailed access method is the same to that of the local file system. The unique difference is that different URL prefixes are used.

↘ System Upgrade

Generally the VSU system requires version consistency of the main program version numbers of the member devices. However, there are so many member devices that it takes too much time and energy to perform upgrade one by one in the standalone mode and it is also easy to make mistakes. FS switches provide consummate system upgrade solution to help you with system upgrade by adopting the two methods as follows:

- When the VSU system is being established: the system will automatically align the main program version numbers of all member devices. Once the main program versions are discovered inconsistency, the main program of the master device will be selected to be synchronized to all member devices.
- After the VSU system is established: the main program version will be synchronized to all member devices automatically by using the file that is downloaded by the TFTP.

↘ SYSLOG

All member devices of the VSU system can display the SYSLOG. The SYSLOG generated by the master device is displayed on the master device console with the same format to that in the standalone mode. The SYSLOG generated by other member devices is also displayed on the master device console, but the message format is different from that in the standalone mode because the device number information is added.

For example, the SYSLOG information generated in the standalone state is "%VSU-5-DTM_TOPO_CVG:Node discovery done. Topology converged." The SYSLOG information generated by the member device numbered 3 is "%VSU-5-DTM_TOPO_CVG:(3) Node discovery done. Topology converged."

8.3.6 Quick Blinking Location

In a network cabling environment, the equipment room where switches are located and the operation console are often at different places. If there are many devices in the environment, network administrators cannot easily locate the locations of specific devices.

Quick blinking location provides network administrators with a method for locating devices by means of quick blinking. By enable this function for a device on the console, you can easily find the corresponding device in the equipment room.

-  When quick blinking location is enabled, the status LED cannot show original status until the quick blinking location is disabled.

8.3.7 Device Recovery in Recovery Mode

By default, a device in recovery mode automatically restarts and is added to the VSU topology again after the VSL link recovers.

The **no recovery auto-restart enable** command is provided to disable the automatic restart and recovery function in recovery mode. After the VSL link recovers, the administrator can enable the automatic restart and recovery function in recovery mode again or manually enter the restart command for devices in recovery mode.

- After the automatic restart and recovery function in recovery mode is disabled, the device stays in recovery mode until the administrator enables the function again or manually resets the device.

8.3.8 Automatic Recovery Without Restart for a Device in Recovery Mode upon Master Device Abnormality

Figure 8-16 Automatic Recovery Without Restart in Recovery Mode

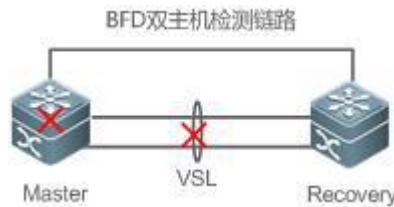

By default, a device in recovery mode does not perform any operation when the master device is abnormal. The device stays in recovery mode until the VSL link recovers.

A configuration command is provided for the administrator to enable the automatic recovery without restart function in recovery mode. In this case, a device in recovery mode can automatically become the master device without being restarted and take over services of the original master device.

- After the automatic recovery without restart function in recovery mode is enabled, a device in recovery mode becomes the master device when a master device abnormality is detected.

8.4 Configuration

Configuration		Configuration and Command	
Configuring VSU in the Standalone Mode	(Mandatory) It is used to configure VSU in the standalone mode.		
	switch virtual domain	Configures the domain ID.	
	switch	Configures the switch ID.	
	switch priority	Configures the switch priority.	
	vsl-port	Enters the VSL interface configuration mode.	
	port-member interface	Configures the VSL member interface.	
	switch convert mode virtual	Changes the standalone mode to the VSU mode.	
	(Optional) It is used to configure the device attributes in the VSU mode.		
	switch description	Configures the device description.	
switch crc	Configures error frame check.		
Configuring VSU in the VSU Mode	Configuring VSU Attributes	(Optional) It is used to configure the device attributes in the VSU mode.	
		switch domain	Changes the domain ID.
		switch renumber	Changes the switch ID.
		switch description	Configures the device description.

Configuration		Configuration and Command	
		switch crc	Configures error frame check.
Configuring the VSL		(Optional) It is used to configure a VSL.	
		vsl-port	Enters the VSL interface configuration mode.
		port-member interface	Configures a VSL member interface.
Configuring Dual-Active Detection		(Mandatory) It is used to configure DAD.	
		dual-active detection	Configures DAD.
		dual-active bfd interface	Configures the BFD DAD interface.
		dual-active interface	Configures an AP as a DAD interface.
Configuring Traffic Balancing		(Optional) It is used to configure traffic balancing in the VSU mode.	
		switch virtual aggregateport-lff enable	Configures the AP LFF mode.
		switch virtual ecmp-lff enable	Configures the ECMP LFF mode.
Configuring the Device Recovery Method in Recovery Mode		(Optional) It is used to configure the device recovery in recovery mode.	
		no recovery auto-restart enable	Disables the automatic restart and recovery function in recovery mode.
Configuring Automatic Recovery Without Restart in Recovery Mode		(Optional) It is used to configure the automatic recovery without restart function in recovery mode.	
		dual-active auto-recovery enable	Enables the automatic recovery without restart function in recovery mode.
Changing the VSU Mode to the Standalone Mode		(Optional) It is used to change the VSU mode to the standalone mode.	
		switch convert mode standalone	Changes the VSU mode to the standalone mode.
Quick Blinking Location		(Optional) It is used to quickly locate a device.	
		led-blink	Enables quick blinking location.
Configuring the MGMT Interface		(Optional) It is used to configure a device to create one MGMT interface for each chassis or create only one MGMT interface in VSU mode.	
		mgmt_mode unique	Configures the system to create only one MGMT interface in VSU mode.
		no mgmt_mode	Configures the system to create one MGMT interface for each chassis in VSU mode.

8.4.1 Configuring VSU in the Standalone Mode

Configuration Effect

Start up the switch in the standalone mode to set relevant VSU parameters to establish the VSU system.

Configuration Steps

Configuring VSU Attributes

- A switch starts in the standalone mode by default. You need to set the same domain ID on the two chassis of the established VSU system. The domain ID must be unique within the local area network (LAN). Furthermore, you need to set the ID of each chassis in the VSU.
- Run the **switch virtual domain** *domain_id* command to configure the domain ID. This command is mandatory.
- Run the **switch** *switch_id* command to configure the device ID in the VSU. This command is mandatory. For devices with the same priorities in the VSU system, a device with the smallest device ID is selected as the global master device.
- Run the **switch** *switch_id* **priority** *priority_num* command to configure the device priority. This command is mandatory.
- The value ranges from 1 to 255. A larger value means a higher priority.
- Run the **switch** *switch_id* **description** *switch1* command to configure the device alias. This command is optional. The default name is FS. For easy identification of devices in the network environment, this item can be selected to set the device alias.
- A maximum of 32 characters are allowed.

Command	switch virtual domain <i>number</i>
Parameter	<i>number</i> : Indicates domain ID of the VSU
Description	
Defaults	The default domain ID is 100.
Command Mode	Domain configuration mode
Usage Guide	Only two devices with the same domain ID can form a VSU. The domain ID must be unique within the LAN.

Command	switch <i>switch_id</i>
Parameter	<i>switch_id</i> : indicates the switch ID in the VSU system. The value varies with products.
Description	
Defaults	The default device ID is 1.
Command Mode	Domain configuration mode
Usage Guide	<p>The device ID identifies each virtual device member. In VSU mode, the interface name format changes to "switch/slot/port" from "slot/port", in which "switch" is the device ID.</p> <p>If either chassis are active or if the role of the just started chassis is uncertain and both have the same priority, the chassis with a smaller ID is elected as the active one.</p> <p>This command can be only used to modify the device ID in standalone mode. In VSU mode, run the switch renumber command to modify the device ID. The modified device ID takes effect only after you restart the device, regardless of in standalone mode or in VSU mode.</p>

Command	switch <i>switch_id</i> priority <i>priority_num</i>
Parameter	<i>switch_id</i> : Indicates a switch ID for which a priority needs to be configured.
Description	<i>priority_num</i> : Indicates the switch priority, ranging from 1 to 255.
Defaults	The default device priority is 100.

Command Mode	Domain configuration mode
Usage Guide	<p>A larger value means a higher priority. A device with the highest priority is chosen as the master device.</p> <p>You can run this command in the standalone or VSU mode. The modified priority takes effect only after you restart the device.</p> <p>This command is not used to modify the value of <i>switch_id</i>. In the standalone mode, if <i>switch_id</i> is set to 1, running the switch 2 priority 200 command does not work. You can first set <i>switch_id</i> to 2 and then run the switch 2 priority 200 command. In the VSU mode, <i>switch_id</i> indicates the ID of the currently running switch. If the ID does not exist, the configuration does not take effect.</p>

Command	switch <i>switch_id</i> description <i>dev-name</i>
Parameter	<i>switch_id</i> : Indicates the device ID.
Description	<i>dev-name</i> : Indicates the device description, no greater than 32 characters.
Defaults	N/A
Command Mode	Domain configuration mode
Usage Guide	This command is configured on a device in whether standalone or VSU mode and takes effect immediately after configuration.

↘ Configuring the VSL

- To establish the VSU system, you need to decide which ports are configured as the VSL member ports.
- Run the **vsl-port** command to enter the VSL interface configuration mode. This command is mandatory.
- Run the **port-member interface** *interface-name* [**copper** | **fiber**] command to add a VSL interface. This command is mandatory.

When the device enters the VSL interface configuration mode, the VSL interface can be configured or deleted.

Command	vsl-port
Parameter	N/A
Description	
Defaults	N/A
Command Mode	Global configuration mode
Usage Guide	You can run this command in the standalone or VSU mode.

Command	port-member interface <i>interface-name</i> [copper fiber]
Parameter Description	<p><i>interface-name</i>: Indicates a two-dimensional interface name, such as Tengigabitethernet 1/1 and Tengigabitethernet 1/3.</p> <p>copper: Indicates the copper interface attribute.</p> <p>fiber: Indicates the optical interface attribute.</p>
Command Mode	VSL interface configuration mode

Usage Guide	<p>Add a member interface of the VSL link. <i>interface-name</i> indicates the two-dimensional interface name in the standalone mode. The two-dimensional interface can be the 10 Gigabit interface or Gigabit interface. (The Gigabit interface can be an opto-copper interface. If the media type is not specified, the Gigabit copper interface is adopted by default.) For an opto-copper interface, you must specify its optical or copper interface attribute. A VSL interface for a chassis device must be a 10 Gigabit interface.</p> <p>You can run this command in the VSU mode or standalone mode. The command can take effect after the command configuration is saved and the device where the VSL member interface resides is restarted.</p>
--------------------	--



In the standalone mode, the VSL configurations cannot take effect immediately unless the device shifts into the VSU mode and restart.

↘ **Configuring Error Frame Check**

- Run the **switch crc** command to configure error frame check. This command is optional. Run this command to modify the default method for checking error frames.
- If error frames are found on a VSL interface, perform error frame correction. The system detects the VSL interfaces every 5 seconds by default. If the number of error frames is greater than 3 as compared with that detected last time, it is assumed that error frames are detected once. If error frames are detected consecutively for 10 times, it is assumed that the interface is abnormal. If multiple VSL links are available when error frames are detected, the VSL will be switched. The last VSL will not be switched in order to prevent topology splitting.

Command	switch crc errors <i>error_num</i> times <i>time_num</i>
Parameter Description	<p><i>error_num</i>: Configures the increase of error frames between two detections. When the number of error frames is greater than the increase, it is assumed that error frames are detected once.</p> <p><i>time_num</i>: Configures the number of times after which an action needs to be taken (the action can be displaying a prompt or disabling the interface).</p>
Defaults	The default value of errors is 3; the default value of times is 10.
Command Mode	Domain configuration mode
Usage Guide	The system detects the VSL interfaces every 5 seconds by default. If the number of error frames is greater than 3 as compared with that detected last time, it is assumed that error frames are detected once. If error frames are detected consecutively for 10 times, it is assumed that the interface is abnormal. The default action for an abnormal interface is displaying a log prompt. You can set the action to disabling the interface. If the interface is disabled, you must recover it by unplugging and plugging it.

Different products have different requirements for error frame check and different processing for VSL interfaces. In version 11.0, error frame check is configurable.

↘ **Changing the Standalone Mode to the VSU Mode**

- Use the **switch convert mode virtual** command to change the standalone mode to the VSU Mode.
- In the standalone mode, the software will take the following actions after you run the **switch convert mode virtual** command.
 - Back up the global configuration file *config.text* in the standalone mode as *standalone.text* for subsequent use.
 - Clear the contents of the configuration file *config.text*.
 - Write the relevant VSU configurations to the special configuration file *config_vsu.dat*.

- If there is a *virtual_switch.text* file on the switch, the system will prompt you whether to overwrite the contents of the file *virtual_switch.text* to the file *config.text* (the file *virtual_switch.text* is a backup file for the file *config.text* when the switch shifts from the VSU mode to the standalone mode). Then you can click **Yes** or **No**. Finally the switch restarts in the VSU mode and reads VSU parameters in the file *config_vsu.dat*.

Command	switch convert mode virtual
Parameter	N/A
Description	
Defaults	The switch is in the standalone mode by default.
Command Mode	Privileged EXEC mode
Usage Guide	Change the standalone mode to the VSU mode.

Verification

Run the **show switch virtual config [switch_id]** command to check the VSU configuration of the current switch in the standalone mode.

Command	show switch virtual config [switch_id]
Parameter Description	<i>switch_id</i> : Indicates the switch ID. After this parameter is specified, only the VSU configuration of the specified device is displayed.
Command Mode	Privileged EXEC mode
Usage Guide	Use this command to display the VSU configuration in the standalone or VSU mode.

The relevant VSU configurations are set for a single physical switch and the configurations are stored in the special configuration file *config_vsu.dat*. Therefore, you can view the current VSU configurations by running the **show switch virtual config** command rather than the **show running config** command.

In the standalone mode, the VSU running information is null. When you enter commands such as **show switch virtual**, the system will prompt you that the switch is in the standalone mode and there is no VSU running information.

Configuration Example

Configuring VSU in the Standalone Mode

<p>Scenario Figure 8-16</p>	<p>Switch 1 and Switch 2 form a VSU system. The domain ID is 100. The chassis on the left side is configured as Chassis 1, with the priority of 200, alias of Switch 1, and the VSL interfaces of 1/1 and 1/2. The chassis on the right side is configured as Chassis 2, with the priority of 100, alias of Switch 2, and the VSL interfaces of 1/1 and 1/2.</p>
<p>Configuration Steps</p>	<p>6. Perform the following configuration on the Switch 1:</p> <ul style="list-style-type: none"> ● Configure VSU attributes and VSL interfaces. ● Change the standalone mode to the VSU mode.

	<p>7. Perform the following configuration on the Switch 2:</p> <ul style="list-style-type: none"> ● Configure VSU attributes and VSL interfaces. ● Change the standalone mode to the VSU mode.
<p>Switch-1</p>	<pre>FS# configure terminal FS(config)# switch virtual domain 100 FS(config-vs-domain)#switch 1 FS(config-vs-domain)#switch 1 priority 200 FS(config-vs-domain)#witch 1 description switch-1 FS(config-vs-domain)# switch crc errors 10 times 20 FS(config-vs-domain))#exit FS(config)#vsl-port FS(config-vsl-port)#port-member interface Tengigabitethernet 1/1 FS(config-vsl-port)#port-member interface Tengigabitethernet 1/2 FS(config)#exit FS#switch convert mode virtual</pre>
<p>Switch-2</p>	<pre>FS# configure terminal FS(config)# switch virtual domain 100 FS(config-vs-domain)# switch 2 FS(config-vs-domain)# switch 2 priority 200 FS(config-vs-domain)# switch 2 description switch-2 FS(config-vs-domain)# switch crc errors 10 times 20 FS(config-vs-domain))#exit FS(config)#vsl-port FS(config-vsl-port)#port-member interface Tengigabitethernet 1/1 FS(config-vsl-port)#port-member interface Tengigabitethernet 1/2 FS(config-vsl-port)#exit FS#switch convert mode virtual</pre>
<p>Verification</p>	<ul style="list-style-type: none"> ● Run the show switch virtual config command to view the VSU attributes of Switch 1 and Switch 2.
<p>Switch-1</p>	<pre>FS#show switch virtual config switch_id: 1 (mac: 0x1201aeda0M) ! switch virtual domain 100 !</pre>

	<pre>switch 1 switch 1 priority 100 ! switch convert mode virtual ! port-member interface Tengigabitethernet 1/1 ! port-member interface Tengigabitethernet 1/2 ! switch crc errors 10 times 20 !</pre>
Switch-2	<pre>FS#show switch virtual config switch_id: 2 (mac: 0x1201aeda0E) ! switch virtual domain 100 ! switch 2 switch 2 priority 100 ! switch convert mode virtual ! port-member interface Tengigabitethernet 1/1 ! port-member interface Tengigabitethernet 1/2 ! switch crc errors 10 times 20 !</pre>

Common Errors

A VSL interface of a chassis device must be 10 Gigabit or higher.

8.4.2 Configuring VSU in the VSU Mode

8.4.2.1 Configuring VSU Attributes

Configuration Effect

During the VSU system running, you can modify the parameters, such as domain ID, switch ID, and priority of the master device or the slave device. However, you can only log in to the VSU master device console to modify these parameters, but cannot enter the global configuration mode from the slave device console.

Notes

- Among the commands above, the all configuration commands take effect only after the switch restarts except the **switch sw_id description switch1** command that can take effect immediately.

Configuration Steps

↘ Entering the Domain Configuration Mode

- Optional.
- Run this command in the VSU mode to enter the domain configuration mode. Switches with the same domain ID form a VSU system. You can modify or configure the domain ID, switch priority, and switch ID only after entering the domain configuration mode in the VSU mode.

Command	switch virtual domain domain_id
Parameter	<i>domain_id</i> : Indicates the virtual domain ID of the VSU system.
Description	
Defaults	The default domain ID is 100.
Command Mode	Domain configuration mode
Usage Guide	Only two devices with the same domain ID can form a VSU system. The domain ID must be unique on a LAN.

↘ Changing the Domain ID

- Optional.
- To modify the value of *domain_id* for a device, you can configure this item on the master device console of the VSU system.

Command	switch switch_id domain new_domain_id
Parameter	<i>switch_id</i> : Indicates the ID of the currently running switch in the VSU mode, ranging from 1 to 8.
Description	<i>new_domain_id</i> : Indicates the modified domain ID, ranging from 1 to 255.
Defaults	The default domain ID is 100.
Command Mode	Domain configuration mode
Usage Guide	Run this command only in the VSU mode. In addition, the setting can take effect only after the device is restarted.

↘ Changing the Switch ID

- Optional.

- To modify the value of *switch_id* for a device, you can configure this item on the master device console of the VSU system.

Command	switch <i>switch_id</i> renumber <i>new_switch_id</i> [force]
Parameter Description	<i>switch_id</i> : Indicates the ID of a switch. In a VSU system, the switch ID ranges from 1 to 16 for box switches. <i>new_switch_id</i> : Indicates the modified switch ID. force : (Optional) Indicates whether the ID of a device needs to be forcibly modified. After this parameter is added, the VSU configuration is saved immediately and the device is restarted.
Defaults	N/A
Command Mode	Domain configuration mode
Usage Guide	Run this command only in the VSU mode. In addition, the setting can take effect only after the device is restarted.

↘ Changing the Switch Priority

- Optional.
- To modify the priority of a device, you can configure this item on the master device console of the VSU system.
- A larger value means a higher priority. Select the device with the highest priority as the master device.

Command	switch <i>switch_id</i> priority <i>priority_num</i>
Parameter Description	<i>switch_id</i> : Indicates a switch ID for which a priority needs to be configured. <i>priority_num</i> : Indicates the switch priority, ranging from 1 to -255 for box switches.
Defaults	The default priority is 100.
Command Mode	Domain configuration mode
Usage Guide	A larger value means a higher priority. Select the device with the highest priority as the master device. You can run this command in the standalone or VSU mode. The modified priority takes effect only after you restart the device. This command is not used to modify the value of switch_id . In the standalone mode, if switch_id is set to 1 , running the switch 2 priority 200 command does not work. You can first set switch_id to 2 and then run the switch 2 priority 200 command. In the VSU mode, switch_id indicates the ID of the currently running switch. If the ID does not exist, the configuration does not take effect.

↘ Configuring the Device Description

- Optional.
- To configure the description for a device, you can configure this item on the master device console of the VSU system.
- Run the **switch** *switch_id* **description** *switch1* command to configure the device description. A maximum of 32 characters are allowed.

Command	switch <i>switch_id</i> description <i>dev-name</i>
Parameter Description	<i>switch_id</i> : Indicates a switch ID for which a priority needs to be configured. <i>dev_name</i> : Indicates the device name.
Defaults	N/A
Command Mode	Domain configuration mode
Usage Guide	You can run this command in the standalone or VSU mode. The configuration takes effect immediately in the VSU mode.

➤ **Configuring Error Frame Check**

- Optional.
- Run the **switch crc errors error_num times time_num** command to configure the conditions for triggering error frame check.

Command	switch crc errors error_num times time_num
Parameter Description	<i>error_num</i> : Configures the increase of error frames between two detections. When the number of error frames is greater than the increase, it is assumed that error frames are detected once. <i>time_num</i> : Configures the number of times after which an action needs to be taken (the action can be displaying a prompt or disabling the interface).
Defaults	The default value of errors is 3 ; the default value of times is 10 .
Command Mode	Domain configuration mode
Default Level	14
Usage Guide	N/A

Verification

Use the **show switch virtual [topology | config]** command to display the current VSU running information, topology or configuration parameters.

Command	show switch virtual [topology config]
Parameter Description	topology : Indicates topology information. config : Indicates the VSU configurations.
Command Mode	Privileged EXEC mode
Usage Guide	View the domain ID, and the device ID, status and role of each device.

Configuration Example

➤ **Configuring VSU Attributes**

<p>Scenario Figure 8-17</p>	<p>Switch 1 and Switch 2 form a VSU system. Modify the chassis ID of Switch 2 to 3 and its priority to 150. Assume that Switch 1 is the global master switch and perform the configuration on the global master switch.</p>
<p>Configuration Steps</p>	<ul style="list-style-type: none"> ● Modify the configurations of Switch 2.
<p>Switch-1</p>	<pre>FS#config FS(config)# switch virtual domain 100 FS(config-vs-domain)# switch 2 renumber 3 FS(config-vs-domain)# switch 2 priority 150 FS(config-vs-domain)# switch 2 description switch-3</pre>

Verification	<ul style="list-style-type: none">● Run the show switch virtual config command for verification.
Switch-1	<pre>FS#show switch virtual config switch_id: 1 (mac: 0x1201aeda0M) ! switch virtual domain 100 ! switch 1 switch 1 priority 100 ! switch convert mode virtual ! port-member interface Tengigabitethernet 1/1 ! port-member interface Tengigabitethernet 1/2 ! switch_id: 3 (mac: 0x1201aeda0E) ! switch virtual domain 100 ! switch 3 switch 3 priority 150 ! switch convert mode virtual ! port-member interface Tengigabitethernet 1/1 ! port-member interface Tengigabitethernet 1/2 ! switch 3 description switch-3 !</pre>

8.4.2.2 Configuring the VSL

Configuration Effect

When switches form a VSU system or when the VSU system is running, you can shift between common interfaces and VSL interfaces. However, you can only log in to the master device console of the VSU system for modification, but cannot enter the global configuration mode from the slave device console.

Notes

- You can log in to the console of the VSU system by using a serial port or telnet, in order to add or delete the configurations of VSL member interfaces.
- To prevent incorrect connections in actual scenarios, the VSL AP uses dynamic negotiation. You need to configure the VSL interface pool first, and then add the VSL interface pool to the same AP after successful negotiation. Interfaces connecting to the same device are within the same AP.

Configuration Steps

➤ **Entering the VSL Interface Configuration mode**

- Run the **vsl-port** command to enter the VSL-PORT configuration mode. This command is optional.
- When the device enters the VSL-PORT configuration mode, the VSL interface can be configured or deleted.

Command	vsl-port
Parameter	N/A
Description	
Defaults	N/A
Command Mode	Global configuration mode
Usage Guide	You can run this command in the standalone or VSU mode.

➤ **Configuring a VSL Member Interface**

- Run the **port-member interface** *interface-name* [**copper** | **fiber**] command to add a VSL interface. This command is optional.
- Run the **port-member interface** command to configure a VSL member interface.

Command	port-member interface <i>interface-name</i> [copper fiber]
Parameter	<i>interface-name</i> : Indicates a two-dimensional interface name, such as GigabitEthernet 0/1 and GigabitEthernet 0/3.
Description	copper : Indicates the copper interface attribute. fiber : Indicates the optical interface attribute.
Defaults	N/A
Command Mode	VSL interface configuration mode
Usage Guide	You can run this command in the VSU mode or standalone mode. The command can take effect after the command configuration is saved and the device where the VSL member interface resides is restarted.

During the VSU system running, the configured VSL member links take effect immediately. VSL interfaces need to be configured for all devices.

For box devices, VSL interfaces can be optical and copper interfaces of Gigabit or higher.

40G one-to-four interfaces cannot be configured as VSL interfaces.

- ⚠ For a 40G port (no matter whether splitting is performed for the interface), its member interfaces (namely, four 10G interfaces) cannot be shifted to VSL member interfaces.

! If an interface has been configured as an NLB reflex interface, this interface can be shifted to a VSL member interface only after the NLB reflex interface configuration is deleted.

! To prevent a loop that may occur when a VSL member interface exits from the VSL AP, the system automatically sets the member interface to the shutdown state when the command is executed to make the VSL member interface exit from the VSL AP. After the VSL member interface exits from the VSL AP, you can reconnect the link and run the **no shutdown** command to enable this interface again. When you configure a VSL interface, the system will shut it down first. If the configuration fails and you want to use it as a common interface, you can run the **no shutdown** command to enable this interface again. Add a member interface number that must be a three-dimensional interface number. For example, in the VSL-PORT configuration mode, if you run the **port-member interface** Tengigabitethernet 1/1/1 command, it indicates that you configure the global three-dimensional interface 1/1/1 as a VSL interface.

! If VSU topology splitting occurs when you change a VSL interface to a common interface, the VSL interface cannot be deleted. You can disconnect the physical interface first and then delete the VSL interface.

Verification

- Use the show switch virtual link [port] to display the current VSL link running information in the VSU mode.

Command	show switch virtual link [port]
Parameter Description	port: Displays the status information of the VSL member interfaces.
Command Mode	Privileged EXEC mode
Usage Guide	N/A

Configuration Example

↘ **Configuring the VSL**

Scenario Figure 8-18	
Configuration Steps	<ul style="list-style-type: none"> ● Add interface 1/1/3 as the VSL interface for Switch 1 and delete interface 1/1/2 from the VSL interface.
Switch-1	<pre>FS#config FS(config)# vsl-port FS(config-vsl-port)# port-member interface Tengigabitethernet 1/1/3 FS(config-vsl-port)# no port-member interface Tengigabitethernet 1/1/2</pre>
Verification	<ul style="list-style-type: none"> ● Run the show switch virtual config command to view the VSL. Assume that Switch 1 is the global master switch and run the command on the global master switch.
Switch-1	<pre>FS#show switch virtual config</pre>

	<pre>switch_id: 1 (mac: 0x1201aeda0M) ! switch virtual domain 100 ! switch 1 switch 1 priority 100 ! switch convert mode virtual ! port-member interface Tengigabitethernet 1/1 ! port-member interface Tengigabitethernet 1/3 !</pre>
	<pre>switch_id: 3 (mac: 0x1201aeda0E) ! switch virtual domain 100 ! switch 3 switch 3 priority 150 ! switch convert mode virtual ! port-member interface Tengigabitethernet 1/1 ! port-member interface Tengigabitethernet 1/2 ! switch 3 description switch-3 !</pre>

8.4.2.3 Configuring Dual-Active Detection

Configuration Effect

Configure the relevant detection mechanism to prevent the dual-active is being generated.

Notes

- The DAD can be configured only in the VSU mode. You are not allowed to configure the DAD mechanism in the standalone mode.
- All DAD configurations will take effect immediately after being configured on the master or slave devices in global configuration mode by running the **show running-config** command.
- The BFD-detected configuration information can be displayed only by running the dual-active detection display command rather than the BFD display command.

Configuration Steps

Configuring the BFD DAD

- The BFD DAD requires establishing a directly connected link between two switches. The interfaces on the two ends must be physical routing interfaces. The following configuration must be performed on both chassis.
- Enter the interface configuration mode of the DAD interface and configure the DAD interface as a routing interface.
- After exiting from the interface configuration mode, run the **switch virtual domain domain_id** command to enter the domain configuration mode.
- In the domain mode, run the **dual-active detection bfd** command to enable BFD. This command is optional and can be used when BFD DAD needs to be configured.
- In the domain configuration mode, run the **dual-active bfd interface interface-name** command to configure the BFD DAD interface. This command is optional and can be used to configure the BFD DAD interface when BFD DAD is configured.
- Delete the BFD DAD interface. If no BFD DAD interface is available, BFD detection cannot be used.

Command	switch virtual domain domain_id
Parameter	<i>domain_id</i> : Indicates the domain ID.
Description	
Defaults	The default domain ID is 100.
Command Mode	Global configuration mode
Usage Guide	Only two devices with the same domain ID can form a VSU system. The domain ID must be unique on a LAN.

Command	dual-active detection { aggregateport bfd }
Parameter	aggregateport : Specifies the AP detection mode.
Description	bfd : Specifies the BFD detection mode.
Defaults	The DAD is disabled.
Command Mode	Domain configuration mode
Usage Guide	Configure this command only in the VSU mode.

Command	dual-active bfd interface interface-name
Parameter	<i>interface-name</i> : Indicates the interface type and ID.
Description	
Defaults	N/A
Command Mode	Domain configuration mode

Mode	
Usage Guide	A BFD DAD interface must be a routing interface and on different switches.

The BFD detection interfaces must be directly connected physical routing ports. The two ports must be on different devices.

The interface type is not limited. The dual-active detection link is only used to transmit BFD packets with a small amount of traffic. Therefore, you are advised to adopt the Gigabit interface or 100 M interface as the dual-active detection interface.

After the layer 3 routing interface that is configured with two master devices is converted into a layer 2 switch interface (run the `switchport` command under this interface), the BFD dual-active detection will be cleared automatically.

You are advised to directly connect BFD detection interfaces only to the master and slave devices.

- ! When the VSU system detects dual-active conflict and brings another VSU group to the recovery state, you can resolve the problem only by rectifying the VSL fault, but not directly restoring the VSU group in the recovery state; otherwise, dual-active conflict may be caused on the network.

▾ Configuring the AP-based DAD

- To configure the AP-based DAD, you must configure an aggregate port (AP) first and then specify the AP port as the DAD interface.
- Run the **port-group** *ap-num* command to add a physical member interface to the AP.
- After entering the domain configuration mode, run the **dual-active detection aggregateport** command to enable AP detection mode. This command is optional. You can run this command when AP detection needs to be configured.
- Run the **dual-active interface** *interface-name* [**vlan** *vlan-id*] command to configure the AP as the DAD interface. This command is optional. You can run this command to configure the AP as the DAD interface when AP detection needs to be configured. When the AP is a trunk port and the native VLAN is beyond the allowable VLAN range of the AP-based DAD interface, a detection VLAN needs to be configured for the AP-based DAD interface. The configured VLAN must be within the allowable VLAN range of the trunk port, and has been correctly created on the device.
- Run the **dad relay enable** command to enable dual-active detection packet relay for upstream and downstream interfaces. This command is optional. You can run this command to relay DAD packets (dual-active detection packets) when AP-based DAD is configured.
- Disabling AP-based DAD will inactivate DAD.
- Delete the detected interface. If no AP-based DAD interface is available, AP-based DAD cannot be used.
- If the AP is a trunk port and VLAN limits have been configured for it, **vlan** *vlan-id* (applicable to the configured limited VLANs) must be configured and the permitted VLANs must be configured on the device. Otherwise, the AP-based DAD function is unavailable.
- The AP-based DAD packet relay is disabled by default.

Command	dual-active detection { aggregateport bfd }
Parameter	aggregateport: Specifies the AP detection mode.
Description	bfd: Specifies the BFD detection mode.
Defaults	The DAD is disabled.
Command	Domain configuration mode

Mode	
Usage Guide	Configure this command only in the VSU mode.

Command	dual-active interface <i>interface-name</i>
Parameter Description	<i>interface-name</i> : Indicates the interface type and interface ID. An AP-based DAD interface must be specified.
Defaults	N/A
Command Mode	Domain configuration mode
Usage Guide	Only one AP-based DAD interface can be configured. This interface must be created before you configure an AP as a DAD interface. Subsequently configured DAD interfaces will overwrite the previous ones.

Command	dad relay enable
Parameter Description	N/A
Defaults	The AP-based DAD packet relay is disabled by default.
Command Mode	Interface configuration mode
Usage Guide	This command can only be executed on the AP.

- You are advised to distribute the physical interfaces that are added to the AP-based detection interface to different devices.
- If the AP is a trunk port and VLAN limits have been configured, **vlan** *vlan-id* (applicable to configured limited VLANs) must be configured and the permitted VLANs must be configured on the device.
- The excluded interface must be routing rather than VSL.
- After the excluded interface is converted from a routing one into a switch interface (run the **switchport** command under this interface), the configurations of the excluded interface that is associated with this interface will be cleared automatically.

Verification

Use the **show switch virtual dual-active { aggregateport | bfd | summary }** to display the current DAD configuration.

Command	show switch virtual dual-active { aggregateport bfd summary }
Parameter Description	aggregateport : Displays DAD information on the AP. bfd : Displays BFD-based DAD information. summary : Displays DAD summary.
Command Mode	Privileged EXEC mode
Usage Guide	N/A

Configuration Example

Configuring the BFD DAD

<p>Scenario Figure 8-19</p>	<ul style="list-style-type: none"> ● Switch 1 and Switch 2 form a VSU (The domain ID is 1) system. The priorities of Switch 1 and Switch 2 are 200 and 150 respectively. The links between Te1/3/1 and Te1/3/2 of Switch 1 and Te2/3/1 and Te2/3/2 of Switch 2 are established respectively to form a VSL between Switch 1 and Switch 2. The G0/1, G0/2, G0/3 and G0/4 interfaces of Switch A are connected to G1/1/1 and G1/2/1 of Switch 1 and G2/1/1 and G2/2/1 of Switch 2 to form an AP group including four member links. The ID of the AP group is 1. All members of AP group 1 are Gigabit optical interfaces. G1/1/2 and G2/1/2 are routing interfaces. ● G1/1/2 and G2/1/2 are a pair of BFD DAD interfaces.
<p>Configuration Steps</p>	<ul style="list-style-type: none"> ● Configure G1/1/2 and G2/1/2 as routing interfaces. ● Enable the BFD DAD. ● Configure G1/1/2 and G2/1/2 as BFD DAD interfaces. <p>Since Switch 1 and Switch 2 are in a VSU system, the preceding configuration can be performed on either Switch 1 or Switch 2. on the following example configures the functions on Switch 1.</p>
<p>Switch 1</p>	<pre> FS(config)# interface GigabitEthernet 1/1/2 FS(config-if-GigabitEthernet 1/1/2)# no switchport FS(config)# interface GigabitEthernet 2/1/2 FS(config-if-GigabitEthernet 2/1/2)# no switchport FS(config-if)# switch virtual domain 1 FS(c config-vs-domain)# dual-active detection bfd FS(config-vs-domain)# dual-active bfd interface GigabitEthernet 1/1/2 FS(config-vs-domain)# dual-active bfd interface GigabitEthernet 2/1/2 </pre>
<p>Switch A</p>	<pre> FS# configure terminal Enter configuration commands, one per line. End with CNTL/Z. FS(config)# interface aggregateport 1 FS(config-if-aggregateport 1)# interface range GigabitEthernet 0/1-4 FS(config-if-aggregateport 1)# port-group 1 FS(config)# interface vlan 1 </pre>

	<pre> FS(config-if-vlan 1)#ip address 1.1.1.2 255.255.255.0 FS(config-if-vlan 1)#exit FS(config)#interface aggregateport 1 FS(config-if-AggregatePort 1)# dad relay enable FS(config-if-AggregatePort 1)# exit </pre>
Verification	<ul style="list-style-type: none"> ● View the DAD configuration. ● View the BFD DAD configuration.
Switch 1	<pre> FS# show switch virtual dual-active summary BFD dual-active detection enabled: No Aggregateport dual-active detection enabled: Yes Interfaces excluded from shutdown in recovery mode: In dual-active recovery mode: NO FS# show switch virtual dual-active bfd BFD dual-active detection enabled: Yes BFD dual-active interface configured: GigabitEthernet 1/1/2: UP GigabitEthernet 2/1/2: UP </pre>

Common Errors

- A BFD DAD interface is not a routing interface.
- Neither BFD DAD nor AP-based DAD are enabled and activated.

8.4.2.4 Configuring Traffic Balancing

Configuration Effect

In the VSU system, if egresses are distributed on multiple devices, the Local Forward First (LFF) can be configured.

Notes

The default configuration is LFF.

Configuration Steps

↘ Configuring the AP LFF mode

- In the domain configuration mode, run the **switch virtual aggregateport-lff enable** command to enable the AP LFF mode. This command is optional.
- The member ports of AP can be distributed on two chassis of the VSU system. You can configure whether the AP egress traffic is forwarded through local member ports first based on actual traffic conditions.

- If this function is disabled, traffic is forwarded based on the AP configuration rules. For details, see the *Configuring Aggregate Port*.

Command	switch virtual aggregateport-lff enable
Parameter	N/A
Description	
Defaults	This function is enabled by default.
Command Mode	Domain configuration mode
Usage Guide	Enable the AP LFF in the VSU mode.

↘ **Configuring the ECMP LFF mode**

- In the domain configuration mode, run the **switch virtual ecmp-lff enable** command to enable the ECMP LFF mode. This command is optional.
- The Equal-Cost MultiPath (ECMP) routing egress can be distributed on two chassis of the VSU system. You can configure whether the ECMP egress traffic is forwarded through local member ports first based on actual traffic conditions.
- If this function is disabled, traffic is forwarded based on the ECMP configuration rules. For details, see the *Configuring Aggregate Port*.

Command	switch virtual ecmp-lff enable
Parameter	N/A
Description	
Defaults	This function is enabled by default.
Command Mode	Domain configuration mode
Usage Guide	Enable the ECMP LFF in the VSU mode.

In the VSU mode, the across-chassis AP LFF mode and the ECMP LFF mode are disabled by default.

To deploy a VSU system for layer-3 switches, you are advised to configure the IP-based AP load balancing (src-ip, dst-ip and src-dst-ip).

Verification

Use the **show switch virtual balance** command to display the current traffic balancing mode of the VSU system.

Command	show switch virtual balance
Parameter	N/A
Description	
Command Mode	Privileged EXEC mode
Usage Guide	Use this command to display the configuration of the traffic balancing mode in the VSU mode.

Configuration Example

↘ **Configuring the LFF**

<p>Scenario Figure 8-20</p>	
	<p>In Figure 1- 20, Switch 1 and Switch 2 form a VSU system. It is assumed that Switch 1 is the global master switch and configuration is performed on Switch 1.</p>
<p>Configuration Steps</p>	<ul style="list-style-type: none"> Configure the AP LFF.
<p>Switch-1</p>	<pre>FS#config FS(config)# switch virtual domain 100 FS(config-vs-domain)# switch virtual aggregateport-lff enable</pre>
<p>Verification</p>	<ul style="list-style-type: none"> Run the show switch virtual balance command for verification.
<p>Switch-1</p>	<pre>FS#show switch virtual balance Aggregate port LFF: enable Ecmp lff enable</pre>

8.4.2.5 Changing the VSU Mode to the Standalone Mode

Configuration Effect

Dismiss the VSU system into individual devices that can operate in the standalone mode.

Configuration Steps

- Run the **switch convert mode standalone** *[switch_id]* command to change the VSU mode to the standalone mode. This command is optional.
- After you run this command, the system will prompt you as follows: Whether to restore the configuration file to standalone text? If **yes**, the configuration file will be restored; if **no**, the configuration of virtual device mode will be cleared.

Command	switch convert mode standalone <i>[switch_id]</i>
Parameter Description	<i>switch_id</i> : Indicates the switch ID.
Defaults	The switch is in the standalone mode by default.
Command Mode	Privileged EXEC mode
Usage Guide	After you run the switch convert mode standalone command, the master switch backs up the global configuration files of all VSDs in the VSU mode as <i>vsd.virtual_switch.text.vsd ID</i> . Then, the master switch clears the global configuration files <i>config.text</i> of all VSDs in the VSU mode, and asks you whether to overwrite the global configuration files <i>config.text</i> with <i>vsd.standalone.text.vsd ID</i> . If you select yes , the content of <i>vsd.standalone.text.vsd ID</i> will overwrite the global configuration file <i>config.text</i> of all VSDs; otherwise, the master switch does not recover <i>config.text</i> . Finally, restart the switch.

This command can be used in the standalone mode or VSU mode. If the command is executed in the standalone mode, the mode switching is performed on the current switch. If the command contains the *sw_id* parameter and is executed in the VSU mode, the mode switching is performed on the switch with the ID specified by *sw_id*. If the command does not contain the *sw_id* parameter, the mode switching is performed on the master switch. You are advised to switch the mode of the slave switch and then that of the master switch.

Configuration Example

Changing the VSU Mode to the Standalone Mode

<p>Scenario Figure 8-21</p>	<p>In Figure 8-21, it is assumed that Switch 1 and Switch 2 form a VSU system and Switch 1 is the global master switch.</p>
<p>Configuration Steps</p>	<ul style="list-style-type: none"> ● Change the mode of Switch 1 to the standalone mode. ● Change the mode of Switch 2 to the standalone mode.
<p>Switch-1</p>	<pre>FS# switch convert mode standalone 1 FS# switch convert mode standalone 2</pre>
<p>Verification</p>	<p>Run the show switch virtual config command to display the switch status.</p>
<p>Switch-1</p>	<pre>FS#show switch virtual config switch_id: 1 (mac: 0x1201aeda0M) ! switch virtual domain 100 ! switch 1 switch 1 priority 100 ! switch convert mode standalone ! port-member interface Tengigabitethernet 1/1 ! port-member interface Tengigabitethernet 1/3 !</pre>
	<pre>switch_id: 2 (mac: 0x1201aeda0E) !</pre>

```

switch virtual domain 100
!
switch 2
switch 2 priority 150
!
switch convert mode standalone
!
port-member interface Tengigabitethernet 1/1
!
port-member interface Tengigabitethernet 1/2
!
switch 2 description switch-2
!
    
```

8.4.3 Configuring Quick Blinking Location

Configuration Effect

- Enable quick blinking location of a switch to make the status LED of the switch quickly blink.

Notes

If you do not disable quick blinking location, the system automatically disables the function 30 minutes after it is enabled.

Configuration Steps

📌 Enabling/Disabling quick blinking location

- Mandatory. Use this function on a switch that needs to be located.
- In the privileged EXEC mode, run the **led-blink** command to enable quick blinking location.

Command	led-blink { enable disable } [device <i>device_id</i>]
Parameter	enable : Enables quick blinking location.
Description	disable : Disables quick blinking location. <i>device_id</i> : Indicates the device ID.
Defaults	Quick blinking location is disabled by default.
Command Mode	Privileged EXEC mode
Usage Guide	Run this command without the <i>device_id</i> parameter to enable or disable the quick blinking search in the standalone mode. In the VSU mode, you can set the <i>device_id</i> parameter to enable or disable this function for a specified device. If you ignore the device_id parameter, you can enable or disable this function for all devices in the VSU system. If you do not disable this function, the system automatically disables the function 30 minutes after it is enabled.

	This configuration cannot be saved. Quick blinking location will be disabled upon restart or failover.
--	--

Verification

- Check whether the status LED of a switch quickly blinks.

Configuration Example

📌 **Enabling quick blinking location for the two VSU devices**

Scenario	Assume that Switch 1 and Switch 2 form a VSU system and Switch 1 is the global master device.
Configuration Steps	<ul style="list-style-type: none"> ● Enter the led-blink enable device 2 command on the Switch 1 console to enable quick blinking location. ● Enter the led-blink enable device 2 command on the Switch 1 console to disable quick blinking location.
Verification	When quick blinking location is enabled, check whether the status LED of Switch 2 quickly blinks.

8.4.4 Configuring the MGMT Interface

Configuration Effect

- Configure a device to create one MGMT interface for each chassis or create only one MGMT interface for the system in VSU mode.

Notes

After this command is configured, run the **write** command to save the configuration. The configuration takes effect only in VSU mode and only after the device is restarted.

Configuration Steps

📌 **Configuring a Device to Create Only One MGMT Interface for the System in VSU Mode**

- Optional. Configure this function only when a device needs to create only one MGMT interface for the system. One MGMT interface is created for each chassis by default.
- In global configuration mode, run the **mgmt_mode** command to configure the MGMT interface.

Command	mgmt_mode unique
Parameter	N/A
Description	
Defaults	N/A
Command Mode	Global configuration mode
Usage Guide	In VSU mode, set the system to create only one MGMT interface. The configuration needs to be saved, and takes effect only after the device is restarted.

📌 **Configuring a Device to Create One MGMT Interface for Each Chassis**

- Optional. After a device has been configured to create only one MGMT interface, use this command to restore default configuration, that is, to create one MGMT interface for each chassis.

Command	no mgmt_mode
----------------	---------------------

Parameter	N/A
Description	
Defaults	N/A
Command Mode	Global configuration mode
Usage Guide	In VSU mode, set the system to create one MGMT interface for each chassis. The configuration needs to be saved, and takes effect only after the device is restarted.

Verification

After configuration, run the **write** command to save the configuration. After running the **reload** command to restart the device, run the **show interface** command to display the number of MGMT interfaces.

Configuration Example

📌 **Configuring a Device to Create Only One MGMT Interface for the System in VSU Mode**

<p>Scenario Figure 1- 22</p>	<p>Switch-1 and Switch-2 form a VSU, and Switch-1 is the global active device.</p>
<p>Configuration Steps</p>	<ul style="list-style-type: none"> Run the command to configure a device to create only one MGMT interface for the system, run the write command to save the configuration, and run the reload command to restart the device for the configuration to take effect.
	<pre>FS(config)#mgmt_mode unique Please write and reload system to take config effect! FS(config)#exit FS#write Building configuration... [OK] FS#reload Reload system?(Y/N)y</pre>
<p>Verification</p>	<ul style="list-style-type: none"> After the device is restarted, run the show interfaces inc mgmt command. The system creates only one MGMT interface even if there are multiple chassis in the VSU mode. <pre>FS#show interfaces inc Mgmt ===== Mgmt 0 ===== Mgmt 0 is UP , line protocol is UP Hardware is Mgmt, address is 1414.3344.5519 (bia 1414.3344.5519)</pre>

8.4.5 Configuring the Device Recovery in Recovery Mode

Configuration Effect

Disable the automatic restart and recovery function in recovery mode.

Notes

If the automatic restart and recovery function is disabled, the function needs to be enabled again or the devices need to be manually restart for devices in recovery mode.

Configuration Steps

✚ Enabling/Disabling the Automatic Restart Function in Recovery Mode

- Mandatory. Enable or disable the function on a device as required.
- In config-vs-domain configuration mode, run the **[no] recovery auto-restart enable** command to enable or disable automatic restart function.

Command	recovery auto-restart enable
Parameter	N/A
Description	
Defaults	The automatic restart and recovery function in recovery mode is enabled by default.
Command Mode	config-vs-domain configuration mode
Usage Guide	This command can be executed only in VSU mode. After the command is configured, the configuration needs to be saved for the configuration to take effect immediately.

Verification

Run the **show run** command to display the configurations.

Configuration Example

✚ Disabling Automatic Restart and Recovery in Recovery Mode in VSU Mode

Scenario	Switch-1 and Switch-2 form a VSU, and Switch-1 is the global active device. The dual-active detection function is enabled.
Configuration Steps	<ul style="list-style-type: none"> ● Run the switch virtual domain 100 command on Switch-1 to enter the config-vs-domain configuration mode. ● Run the no recovery auto-restart enable command on Switch-1 to disable the automatic restart and recovery function.
Verification	<p>Disconnect the VSL link. After dual-active detection is completed, Switch-2 enters the recovery mode.</p> <p>Re-connect the VSL link. Switch-2 does not restart.</p> <p>Run the recovery auto-restart enable command on Switch-2 to enable the automatic restart and recovery function. Switch-2 automatically resets.</p>

8.4.6 Configuring Automatic Recovery Without Restart in Recovery Mode

Configuration Effect

Enable the automatic recovery without restart function in recovery mode.

Configuration Steps

▾ Enabling/Disabling the Automatic Recovery Without Restart Function in Recovery Mode

- Mandatory. Enable or disable the function on a device as required.
- In config-vs-domain configuration mode, run the **[no] dual-active auto-recovery enable** command to enable or disable the automatic recovery without restart function.

Command	dual-active auto-recovery enable
Parameter	N/A
Description	
Defaults	The automatic recovery without restart function in recovery mode is disabled by default.
Command Mode	config-vs-domain configuration mode
Usage Guide	This command can be executed only in VSU mode. After the command is configured, the configuration needs to be saved for immediate validation.

Verification

Run the **show run** command to display the configurations.

Configuration Example

▾ Enabling Automatic Recovery Without Restart in Recovery Mode in VSU Mode

Scenario Figure 1- 23	 <p>Switch-1 and Switch-2 form a VSU, and Switch-1 is the global active device. The DAD function is enabled.</p>
Configuration Steps	<ul style="list-style-type: none"> ● Run the switch virtual domain 100 command on Switch-1 to enter the config-vs-domain configuration mode. ● Ru the dual-active auto-recovery enable command on Switch-1 to enable the automatic recovery without restart function in recovery mode.
Verification	<p>Disconnect all VSL links. After DAD is completed, Switch-2 enters the recovery mode.</p> <p>Power off Switch-1. Verify that Switch-2 automatically becomes the master device without restart.</p>

8.5 Monitoring and Maintenance

Displaying

Description	Command
Displays the current VSU operation, topology or configuration.	show switch virtual [topology config role]
Displays the current dual-active configuration.	show switch virtual dual-active { bfd aggregateport summary }
Displays the current VSL running information in the VSU mode.	show switch virtual link [port]
Redirects to the console of the master switch or any switch.	session { device switch_id master }
Displays the current switch ID.	show switch id

9 Configuring RNS

9.1 Overview

The reliable network service (RNS) tests specific services provided by a peer device to monitor the service availability, integrity of the end-to-end connection, and service quality. Using the RNS test results, you can:

- Learn the network performance in time and take measures accordingly to handle related network performance problems.
- Diagnose and locate network faults.

9.2 Applications

9.2.1 Testing and Evaluating Service Performance

Scenario

As shown in the following figure, a company is going to deploy a video conference system between the headquarters and branches, and has completed the related quality of service (QoS) configurations. Before formal deployment, it must be checked whether the services can be provisioned normally under the existing service pressure of the company. The video conference system is sensitive to the User Datagram Protocol (UDP) delay and UDP transmission jitter of the network. The traditional ping tool can test the Internet Control Message Protocol (ICMP) performance, but cannot effectively evaluate the UDP transmission performance and cannot meet the requirement for jitter measurement.

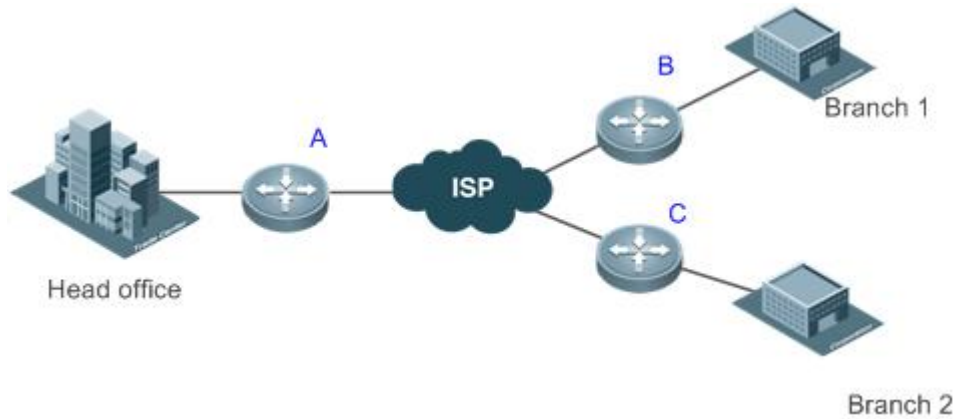

Remarks	A, B, and C are switches.
----------------	---------------------------

Deployment

- Configure RNS on the egress switching device or switch of each branch to test the UDP jitter and delay.
- On Switch A, specify the IP address and UDP port of the egress switching device or switch in the headquarters, and then UDP packets can be automatically sent. Based on the configurations, the egress switching device or switch in the headquarters can automatically respond to the UDP packets. The egress switching device or switch of the branch processes the sent and received packets, and calculates the UDP jitter. To learn the performance in different periods of time, you also need to configure scheduling functions, such as periodically start/stop and repeated running, for the RNS.

9.2.2 Locating Network Faults

Scenario

On the campus network as shown in Figure 9-1, Student 1 reports a Web server access failure, Student 3 reports an Internet access failure, and Student 6 reports an email sending/receiving failure.

Figure 9-1

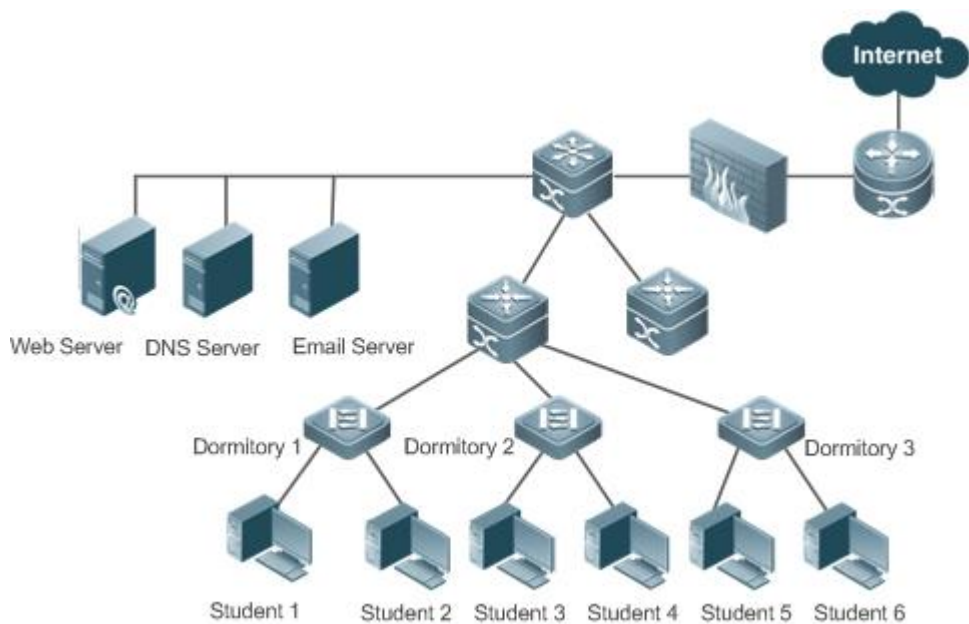

Deployment

- The administrator directly enables the DNS function on the access switch of the dormitories to test whether the domain name service (DNS) server is faulty. If DNS fails, an ICMP echo packet is automatically triggered to test whether the Web server is reachable.
- When a fault occurs, the administrator only needs to start a test, and the subsequent tests can be automatically triggered. Then, the administrator can check the test results to locate the fault, which greatly reduces the workload for the administrator.

9.3 Features

Basic Concepts

📌 RNS Instance

An RNS instance can be treated as an RNS process. Before performing the RNS, you must create an RNS instance. In the RNS instance, you need to configure the RNS parameters, such as the test type, test destination address, and test frequency. The instance ID is globally unique.

Feature	Description
RNS Instance	Use an RNS instance to conduct a functional test.
Track Support for the RNS	Track the test results and notify the related module of the results.

9.3.1 RNS Instance

Use an RNS instance to conduct a functional test, for example, testing whether the DNS function of the device is normal. Currently, the RNS supports the following types of tests: ICMP echo and DNS.

Working Principle

📌 ICMP Echo Test

ICMP echo is a basic function of the RNS, and is implemented in compliance with the RFC 2925. An ICMP packet is sent to check whether the destination is reachable and to calculate the network response time and packet loss rate.

The RNS client sends an ICMP echo request to the destination IP address based on the preset test time and frequency. On receiving the ICMP echo request, the destination address responds with an ICMP echo reply. Based on the information related to the received ICMP echo reply, for example, the packet receiving time and number of packets, the RNS client calculates the response time and packet loss rate of the destination IP address to reflect the current network performance and network status. The ICMP echo test results and historical records will be recorded in the test group. You can use the command line to check the test results and historical records.

 The precondition of a successful ICMP echo test is that the destination device can correctly respond to the ICMP echo request.

📌 DNS Test

In a DNS test, a DNS client is simulated to send a domain name resolution request to a specified DNS server. You can determine whether the DNS server is available and the domain name resolution speed by checking the domain name resolution result and the time required for domain name resolution. In the DNS test, the domain name resolution process is simulated, and the mapping between the resolved

domain name and the IP address is not saved. The DNS test results and historical records will be recorded in the test group. You can use the command line to check the test results and historical records.

➤ Procedure for Configuring an RNS Instance Test

1. Create a test group, and configure the test parameters based on the test type.
2. Start an RNS test.
3. Use the RNS client to construct a packet of the specified test type, and send the packet to the peer end.
4. On receiving the test packet, the peer end returns a reply packet containing the timestamp.
5. The RNS client calculates the packet loss rate and round-trip time based on availability of the received reply packet and the timestamp in the reply packet.
6. Use the show or debug command to check the test result.

 The preceding configuration procedure is a general test procedure of an RNS instance. For details about the specific configuration procedures for the three types of tests, see the configuration descriptions provided later.

Related Configuration

➤ Configuring the Test Repeat Interval

By default, the test repeat interval is 60s.

Run the **frequency** *millisecond* command to configure the repeat interval of an instance.

Perform this configuration in IP RNS configuration mode to perform the test periodically. You can run the **frequency** command to specify the repeat interval. The configured frequency must meet the requirement of the following formula to ensure calculation correctness of the test:

(frequency milliseconds) > (timeout milliseconds) >= (threshold milliseconds)

➤ Configuring the Test Timeout

The default timeout varies according to the test type. You can run the **show ip rns configuration** command to display the timeout of a specific test type.

Run the **timeout** *milliseconds* command to configure the timeout of an instance.

Perform this configuration in IP RNS configuration mode. The value of **timeout** must be equal to or greater than the value of **threshold**. For the relationship between **timeout**, **frequency**, and **threshold**, see "Usage Guide" of the **frequency** command.

➤ Configuring the Test Threshold

By default, the test threshold is 5,000 ms.

Run the **threshold** *milliseconds* command to configure the threshold of an instance.

Perform this configuration in IP RNS configuration mode. The value of **threshold** must be equal to or smaller than the value of **timeout**. For the relationship between **timeout**, **frequency**, and **threshold**, see "Usage Guide" of the **frequency** command.

➤ Configuring a Tag for the Test

No default configuration is available.

Run the **tag text** command to configure a test tag.

Perform this configuration in IP RNS configuration mode. The **tag** command can specify a tag for a test, which is generally used to identify the function of this test.

↘ **Configuring the Protocol Payload Size**

The default protocol payload size varies according to the test type. By default, the protocol payload size of a test type is the minimum or appropriate size for the test.

Run the **request-data-size bytes** command to configure the protocol payload size.

Perform this configuration in IP RNS configuration mode.

↘ **Configuring the TOS of the Test Packet**

By default, the TOS is 0.

Run the **tos number** command to configure the TOS field in the IPv4 packet used for the IP RNS test.

Perform this configuration in IP RNS configuration mode.

↘ **Configuring the VRF**

No default configuration is available.

Run the **vrf vrf-name** command to configure the virtual routing and forwarding (VRF) of the IP RNS test.

Perform this configuration in IP RNS configuration mode.

9.3.2 Track Support for the RNS

Objects that can be tracked include: test result of an RNS instance, RNS list status, link status on an interface, and track list status. When the track status changes, an action of the related module (such as DNS) is triggered.

Working Principle

The test result of an RNS instance is tracked as follows:

- Configure a track object for tracking the test result of an RNS instance.
- When the test result of the RNS instance changes, the RNS module sends a status change message to the track module.
- On receiving this message, the track module locates the track object based on the RNS instance ID. After the preset delay time elapses, if the status of the RNS instance still changes, the status of the track module is modified, and the module of the track object is notified of the modification. If the status of the RNS instance recovers within the preset delay time, the track status is not modified and the related module is not notified.

Related Configuration

↘ **Configuring a Track Object for Tracking the Link Status of An Interface**

By default, the function of tracking the link status of an interface is disabled.

Run the **track interface line-protocol** command to configure a track object, which is used to track the link status of an interface.

If the link status of the interface is UP, the status of the track object is UP. If the link status of the interface is DOWN, the status of the track object is also DOWN.

↘ **Configuring a Track Object for Tracking the Test Result of an RNS Instance**

By default, the function of tracking the test result of an RNS instance is disabled.

Run the **track rns** command to configure a track object, which is used to track the test result of an RNS instance. The RNS instance ID ranges from 1 to 500.

If the test result of the RNS instance is successful, the status of the track object is UP. If the test result of the RNS instance is unsuccessful, the status of the track object is also DOWN.

↘ **Configuring a Track Object for Tracking the Test Result of an RNS List**

By default, the function of tracking the test result of an RNS list is disabled.

Run the **track rns-list** command to configure a track object, which is used to track the test result of an RNS list. The RNS instance ID ranges from 1 to 500.

The result can be the AND or OR operation result of all member status. If the result of this track object is set to the OR operation result of all member status, and the OR result of the status of all the tracked RNS objects is UP, the status of this track object is UP. If the OR result of the status of all the tracked RNS objects is DOWN, the status of this track object is also DOWN. If the result of this track object is set to the AND operation result of all member status, and the AND result of the status of all the tracked RNS objects is UP, the status of this track object is UP. If the AND result of the status of all the tracked RNS objects is DOWN, the status of this track object is also DOWN.

↘ **Configuring a Track Object for Tracking the Status of a Track List**

By default, the function of tracking the status of a track list is disabled.

Run the **track list** command to configure a track object, which is used to track the status of a track list. The result can be the AND or OR operation result of all member status.

If the result of this track object is set to the OR operation result of all member status, and the OR result of the status of all members is UP, the status of this track object is UP. If the OR result of the status of all members is DOWN, the status of this track object is also DOWN. If the result of this track object is set to the AND operation result of all member status, and the AND result of the status of all members is UP, the status of the track object is UP. If the AND result of the status of all members is DOWN, the status of this track object is also DOWN.

↘ **Configuring a Track List Member**

By default, no member is configured for the track list.

Run the **object** command to configure a track list member. The status of a track list member meeting conditions can be set to UP or DOWN.

Assume that the status of a member meeting conditions is set to UP. If the status of a track list member is UP, the member meets conditions. If the status of a track list member is DOWN, the member does not meet conditions.

↘ **Adjusting the Delay for Notifying the Status Change of a Track Object**

By default, the delay for notifying the status change of a track object is 0.

Run the **delay** command to adjust the delay for track notification, including the delay for notifying the status change of a track object from UP to DOWN and the delay for notifying the status change of a track object from DOWN to UP. The delay ranges from 0 to 180. The unit is second.

A longer delay indicates that it takes more time before the module that is concerned with the track object is notified of the status. A shorter delay indicates that it takes less time before the module that is concerned with the track object is notified of the status.

9.4 Configuration

Configuration Item	Description and Command	
Configuring RNS Basic Functions	(Mandatory) It is used to configure basic function parameters of the RNS.	
	ip rns	Supports detailed configuration and brief configuration. <ul style="list-style-type: none"> Detailed configuration: An IP RNS operation object is defined, and used as the configuration ID for subsequent tests and parameters. Brief configuration: Subsequent configuration of the test type is not required. Currently, one-step startup of the ICMP, DNS, and TCP connect tests is supported.
	ip rns reaction-configuration	Configures the proactive threshold monitoring and triggering mechanism of the IP RNS test.
	ip rns reaction-trigger	Triggers another type of the IP RNS test in pending state when the monitoring threshold exceeds the expectation during an IP RNS test.
	ip rns schedule	Configures the scheduling method, start time, and life time of an IP RNS test.
	ip rns restart	Restarts an IP RNS test.
	ip rns reset	Clears all the IP RNS configurations.
Configuring the ICMP Echo Test	(Optional) It is used to implement the ICMP echo test.	
	icmp-echo	Creates an RNS test, the type of which is ICMP echo.
	request-data-size	Configures the protocol payload size.
	frequency	Configures the test repeat interval.
	tag	Configures a tag.
	threshold	Configures the test threshold.
	timeout	Configures the test timeout.
	tos	Configures the TOS field in the header of the IPv4 test packet.
vrf	Configure the VRF of a test.	
Configuring the DNS Test	(Optional) It is used to implement the DNS test.	
	dns	Creates an RNS test, the type of which is DNS.
	frequency	Configures the test repeat interval.

Configuration Item	Description and Command	
	tag	Configures a tag.
	threshold	Configures the test threshold.
	timeout	Configures the test timeout.
	tos	Configures the TOS field in the header of the IPv4 test packet.
	vrf	Configure the VRF of a test.
<u>Configuring the Track Support for the RNS</u>	(Optional) It is used to configure the track support for other test modules.	
	track rns	Configures a track object for tracking the test result of an RNS instance.
	track interface line-protocol	Configures a track object for tracking the link status of an interface.
	track list	Configures a track object for tracking the status of a track list.
	object	Configures a member object for a track list object.
	delay	Configures the delay for notifying the status change of a track object.

9.4.1 Configuring RNS Basic Functions

Configuration Effect

- Detailed configuration: Configures an RNS instance to complete basic configuration of the RNS test.
- Brief configuration: Configure and start an RNS instance at a time. (Optional)

Notes

- In the case of detailed configuration, if you do not further configure the test type after entering ip-ms mode, the RNS object cannot be created.
- In the case of detailed configuration, you must run the command to configure the startup policy after an IP RNS test is configured; otherwise, the test is not conducted.

Configuration Steps

▾ Defining an IP RNS Operation Object

- Mandatory.
- Perform this configuration on every switching device unless otherwise required.
- Brief configuration is optional.

▾ Configuring the Proactive Threshold Monitoring and Triggering Mechanism for the Test

- Perform this configuration if it is required to configure the proactive threshold monitoring and triggering mechanism for the test.
- Perform this configuration on every switching device unless otherwise required.

▾ Enabling an RNS Test to Trigger Another RNS Test

- Perform this configuration if it is required to trigger another type of the IP RNS test in pending state when the monitoring threshold exceeds the expectation during an IP RNS test.
- Perform this configuration on every switching device unless otherwise required.

➤ **Configuring the Schedule Parameters of an RNS Test**

- Configure the scheduling method, start time, and life time if it is required to trigger an IP RNS test.
- Perform this configuration on every switching device unless otherwise required.
- In the case of brief configuration, this command is already configured using the default values, and manual configuration is not required.

➤ **Restarting an IP RNS Test**

- Perform this configuration, or directly run the **ip rns schedule X start-time now** command if it is required to restart an IP RNS instance in pending state.

➤ **Clearing Configurations of All the IP RNS Instances**

- Perform this configuration if it is required to clear configurations of all the IP RNS instances, for example, when a lot of instances are configured but configurations are found incorrect.

➤ **Starting the IP RNS Server to Provide Server Functions**

- Perform this configuration on every switching device unless otherwise required.

Verification

- Run the **show ip rns configuration** command to display configurations of RNS instances.

Related Commands

➤ **Defining an IP RNS Operation Object**

Command	ip rns operation-number
Parameter Description	<i>operation-number</i> : Indicates the ID of the IP RNS operation object. The value ranges from 1 to 500.
Command Mode	Global configuration mode
Usage Guide	<p>Currently, the IP RNS supports only IPv4-related tests, but not IPv6-related tests. At most 500 tests can be configured, depending on the performance of devices. The test function is only a value-added function. When a large number of tests are configured and consume a lot of system resources, the test function may be temporarily disabled to ensure normal operation of core services, such as route forwarding.</p> <p>Detailed configuration (mandatory items of ip rns operation-number): Run this command and enter ip-rns mode. In ip-rns mode, you can define various test types. If the test type is not configured, the RNS object is not created. After configuring an IP RNS test, you must run the ip rns schedule command to configure its scheduling parameter; otherwise, the test cannot be conducted.</p> <p>After configuring an IP RNS test, you can run the ip rns command to directly enter the mode of the related test type. To modify a type of the IP RNS test object that is currently conducted, you must first delete this IP RNS test by running the no ip rns command in global configuration mode.</p>

➤ **Configuring the Proactive Threshold Monitoring and Triggering Mechanism for the Test**

Command	ip rns reaction-configuration <i>operation-number</i> react <i>monitored-element</i> [action-type <i>option</i>][threshold-type { average [<i>number-of-measurements</i>] consecutive [<i>occurrences</i>] immediate never xofy [<i>x-value y-value</i>] }] [threshold-value <i>upper-threshold lower-threshold</i>]																			
Parameter Description	<p><i>operation-number</i>: Indicates the ID of the IP RNS operation object. The value ranges from 1 to 500.</p> <p><i>monitored-element</i>: Specifies the monitored element.</p> <p>action-type <i>option</i>: Indicates the action taken after the test is triggered.</p> <p>average [<i>number-of-measurements</i>]: Indicates that the subsequent associated actions are triggered if the average of <i>number-of-measurements</i> of the monitored element exceeds the threshold.</p> <p>consecutive [<i>occurrences</i>]: Indicates that the test is triggered if the consecutive number of <i>occurrences</i> of the monitored element exceeds the threshold. The default value of <i>occurrences</i> is 5. The value ranges from 1 to 16.</p> <p>immediate: Indicates that the test is triggered immediately after the monitored element exceeds the threshold.</p> <p>never: Indicates that the test is never triggered.</p> <p>xofy [<i>x-value y-value</i>]: Indicates that results of X tests exceed the threshold in the last Y tests. The default values of X and Y are 5. The value of X or Y ranges from 1 to 16.</p> <p>threshold-value <i>upper-threshold lower-threshold</i>: Indicate the upper and lower thresholds.</p> <ul style="list-style-type: none"> When <i>monitored-element</i> is rtt, the thresholds are the time. For default values, see "Usage Guide". The value ranges from 0 to 60,000 ms. Note that you do not need to configure threshold-value when react is set to timeout. 																			
Command Mode	Global configuration mode																			
Usage Guide	<p>For the same IP RNS object, you can configure multiple thresholds to monitor different elements. The following table provides the mapping between test types and monitored elements.</p> <table border="1" data-bbox="313 1220 1097 1422"> <tr> <td>monitored-element</td> <td>icmp-echo</td> <td>dns</td> </tr> <tr> <td>timeout</td> <td></td> <td></td> </tr> <tr> <td>rtt</td> <td></td> <td></td> </tr> </table> <p>The following table lists the default thresholds of each monitored element.</p> <table border="1" data-bbox="313 1489 1097 1680"> <thead> <tr> <th>Monitored Element</th> <th>Upper Threshold</th> <th>Lower Threshold</th> </tr> </thead> <tbody> <tr> <td>timeout</td> <td>-</td> <td>-</td> </tr> <tr> <td>rtt</td> <td>5000ms</td> <td>0ms</td> </tr> </tbody> </table>		monitored-element	icmp-echo	dns	timeout			rtt			Monitored Element	Upper Threshold	Lower Threshold	timeout	-	-	rtt	5000ms	0ms
monitored-element	icmp-echo	dns																		
timeout																				
rtt																				
Monitored Element	Upper Threshold	Lower Threshold																		
timeout	-	-																		
rtt	5000ms	0ms																		

➤ **Enabling an RNS Test to Trigger Another RNS Test**

Command	ip rns reaction-trigger <i>operation-number</i> <i>target-operation</i>
Parameter Description	<p><i>operation-number</i>: Indicates the number of the source operation that triggers the action. The value ranges from 1 to 500.</p> <p><i>target-operation</i>: Indicates the number of the target operation that is triggered. The value ranges from 1 to 500.</p>
Command	Global configuration mode

Mode	
Usage Guide	The trigger function is generally used in network fault diagnosis scenario. In a common scenario, you do not need to configure the trigger function.

✚ Configuring the Schedule Parameters of an RNS Test

Command	ip rns schedule <i>operation-number</i> [life forever <i>seconds</i>] [start-time { <i>hh:mm[:ss]</i> [<i>month day</i> <i>daymonth</i>] } pending now after <i>hh:mm:ss</i>] [recurring]
Parameter Description	<p><i>operation-number</i>: Indicates the number of the RNS operation. The value ranges from 1 to 500.</p> <p>lifeforever: Indicates that the RNS operation life time is valid forever.</p> <p>lifeseconds: Indicates the life time of the RNS in second.</p> <p><i>hh:mm[:ss]</i>: Accurately indicates the start time of the operation. The 24-hour format is used.</p> <p><i>month</i>: Indicates the start month of the operation. The default value is the current month.</p> <p><i>day</i>: Indicates the start date of the operation. The default value is the current date.</p> <p>pending: Indicates that the operation start time is not defined yet. This is the default value.</p> <p>now: Indicates that the operation start time is now, that is, the operation starts now.</p> <p>after <i>hh:mm:ss</i>: Indicates that the operation starts after a delay of <i>hh:mm:ss</i>.</p> <p>recurring: Indicates whether the operation automatically starts every day at the same time.</p>
Command Mode	Global configuration mode
Usage Guide	<p>If the scheduling parameter of an IP RNS test is already configured by running the ip rns schedule command, its test parameters cannot be modified. To modify the configuration, you must run the no ip rns schedule command to delete the scheduling policy configuration.</p> <p>life <i>seconds</i> indicates the lifecycle of the IP RNS test, that is, after the test is started according to the configured start time, the test stops after a period of time specified by <i>seconds</i>.</p>

✚ Restarting an IP RNS Test

Command	ip rns restart <i>operation-number</i>
Parameter Description	<i>operation-number</i> : Indicates the ID of the IP RNS operation object. The value ranges from 1 to 500.
Command Mode	Global configuration mode
Usage Guide	This command restarts an IP RNS test for which the scheduling policy is configured and is in pending state. This command is invalid for an IP RNS test for which the scheduling policy is not configured.

✚ Clearing Configurations of All the IP RNS Instances

Command	ip rns reset
Parameter Description	N/A
Command	Global configuration mode

Mode	
Usage Guide	This command clears configurations of all the IP RNS instances. It is used only in extreme cases, for example, when a lot of RNS tests are configured but the configurations are found incorrect.

Configuration Example

▾ **Configuring RNS Basic Functions**

<p>Scenario Figure 9-2</p>	
<p>Configuration Steps</p>	<ul style="list-style-type: none"> ● Configure instance 1 on Switch A. ● Configure the scheduling method, start time, and life time of instance 1. ● Configure the proactive threshold monitoring and triggering mechanism of instance 1. ● Trigger instance 2 in pending state when the monitoring threshold of instance 1 exceeds the expectation.
<p>Switch A</p>	<pre>A# configure terminal A(config)# ip rns 1 A(config-ip-rns)#icmp-echo 10.1.1.1 A(config-ip-rns-icmp-echo)#exit A(config)ip rns schedule 1 start-time now life forever A(config)ip rns reaction-configuration 1 react timeout threshold-type immediate action-type trigger A(config)ip rns reaction-trigger 1 2</pre>
<p>Verification</p>	<p>Run the show ip rns configuration command to display the instance configurations.</p> <pre>Router#show ip rns configuration 1 Entry number: 1 Tag: FS555 Type of operation to perform: icmp-echo Operation timeout (milliseconds): 5000 Operation frequency (milliseconds): 60000 Threshold (milliseconds): 5000 Recurring (Starting Everyday): FALSE Life (seconds): 3500 Next Scheduled Start Time:Start Time already passed Target address/Source address: 2.2.2.3/0.0.0.0 Request size (ARR data portion): 36</pre>

9.4.2 Configuring the ICMP Echo Test

Configuration Effect

Create an IP RNS test of the ICMP echo type.

Notes

- The RNS basic functions must be configured.

Configuration Steps

↳ Creating an IP RNS Test of the ICMP Echo Type

- Mandatory.
- Perform this configuration on every switching device unless otherwise required.

↳ Configuring Common Optional Parameters of the Test

- Perform this configuration if it is required to change common optional parameters of the test, such as the repeat interval, tag, time threshold, timeout, and TOS.
- Perform this configuration on every switching device unless otherwise required.

↳ Configuring the Protocol Payload Size

- Perform this configuration if it is required to change the protocol payload size of the test.
- Perform this configuration on every switching device unless otherwise required.

Verification

- Run the **show ip rns configuration** command to display the instance configurations.

Related Commands

↳ Creating an IP RNS Test of the ICMP Echo Type

Command	icmp-echo { oob { <i>destination-ip-address</i> <i>destination-hostname</i> [name-server <i>ip-address</i>] } [source-ipaddr <i>ip-address</i>] via <i>type num</i> next-hop <i>ip-address</i> } { { <i>destination-ip-address</i> <i>destination-hostname</i> [name-server <i>ip-address</i>] } [source-ipaddr <i>ip-address</i>] [out-interface <i>type num</i> [next-hop <i>ip-address</i>]] }
Parameter Description	<p>oob: Indicates the test on the MGMT interface.</p> <p><i>destination-ip-address</i>: Indicates the destination IP address.</p> <p><i>destination-hostname</i>: Indicates the destination host name.</p> <p>name-server <i>ip-address</i>: Specifies the DNS server when the destination host name is configured. By default, the DNS server configured by using the ipname-server command is used for address resolution.</p> <p>source-ipaddr <i>ip-address</i>: Indicates the source IP address.</p> <p>out-interface <i>type num</i>: Specifies the outgoing interface (non-MGMT interface) of the test packet.</p> <p>via <i>type num</i>: Specifies the MGMT interface as the outgoing interface of the test packet.</p> <p>next-hop <i>ip-address</i>: Indicates the IP address of the next hop.</p>
Command Mode	IP RNS configuration mode (config-ip-rns)

Usage Guide	<p>After this command is configured, the IP RNS object starts to send the ICMP echo packet, and the destination IP address is the IP address configured by the user. By default, the payload size of an ICMP echo packet is 36 bytes. You can run the request-data-size command to change the packet size.</p> <p>You must first configure the type of the IP RNS test (such as the ICMP echo test), and then configure parameters of the test type. To modify the test type of an IP RNS test, you must first delete this IP RNS test by running the no ip rns command in global configuration mode.</p>
--------------------	---

↘ Configuring the Protocol Payload Size of the IP RNS Test

Command	request-data-size <i>bytes</i>
Parameter Description	<i>bytes</i> : Indicates the bytes of the test packet. The minimum/maximum bytes vary according to the test type. You need to configure this item based on the command prompt in configuration mode of a specific test.
Command Mode	IP RNS ICMP echo configuration mode (config-ip-rns-icmp-echo)
Usage Guide	This command is used to stuff some bytes in the test packet so that large packets can be used for the test.

↘ Configuring the Test Repeat Interval

Command	frequency <i>milliseconds</i>
Parameter Description	<i>milliseconds</i> : Indicates the packet sending interval in ms. The default value is 60,000 ms. The value ranges from 10 to 604,800,000. The maximum value is one week.
Command Mode	IP RNS DNS configuration mode (config-ip-rns-dns) IP RNS ICMP echo configuration mode (config-ip-rns-icmp-echo)
Usage Guide	<p>Tests are conducted periodically in an IP RNS test lifecycle. You can run the frequency command to specify the repeat interval. The configured frequency must meet the requirement of the following formula to ensure calculation correctness of the test:</p> $(\text{frequency milliseconds}) > (\text{timeout milliseconds}) \geq (\text{threshold milliseconds})$

↘ Configuring a Tag for an IP RNS Test

Command	tag <i>text</i>
Parameter Description	<i>text</i> : Sets the test tag. The value is a string of up to 79 characters.
Command Mode	IP RNS DNS configuration mode (config-ip-rns-dns) IP RNS ICMP echo configuration mode (config-ip-rns-icmp-echo)
Usage Guide	This command specifies a tag for a test, which is often used to indicate the function of the test.

↘ Configuring the Time Threshold of an IP RNS Test

Command	threshold <i>milliseconds</i>
----------------	--------------------------------------

Parameter Description	<i>milliseconds</i> : Indicates the time threshold of the test. The value ranges from 0 to 60,000. The unit is ms. The default value is 5,000.
Command Mode	IP RNS DNS configuration mode (config-ip-rns-dns) IP RNS ICMP echo configuration mode (config-ip-rns-icmp-echo)
Usage Guide	The value of threshold must be equal to or smaller than the value of timeout . For the relationship between timeout , frequency , and threshold , see "Usage Guide" of the frequency command.

↘ Configuring the Timeout of an IP RNS Test

Command	timeout <i>millisecond</i>
Parameter Description	<i>millisecond</i> : Indicates the test timeout. The value ranges from 10 to 604,800,000. The unit is ms. The default timeout varies according to the test type.
Command Mode	IP RNS DNS configuration mode (config-ip-rns-dns) IP RNS ICMP echo configuration mode (config-ip-rns-icmp-echo)
Usage Guide	The value of timeout must be equal to or greater than the value of threshold . For the relationship between timeout , frequency , and threshold , see "Usage Guide" of the frequency command.

↘ Configuring the TOS Field in the IPv4 Packet Header of an IP RNS Test

Command	tos <i>number</i>
Parameter Description	<i>number</i> : Sets the TOS field in the IPv4 test packet. The value ranges from 0 to 255. The default value is 0.
Command Mode	IP RNS DNS configuration mode (config-ip-rns-dns) IP RNS ICMP echo configuration mode (config-ip-rns-icmp-echo)
Usage Guide	TOS is a 8-bit field in the IPv4 packet header. By setting the TOS, you can control the priority of the test packet. For different TOS fields, the processing priorities are different on the intermediate routers.

↘ Configuring the VRF of an IP RNS Test

Command	vrf <i>vrf-name</i>
Parameter Description	<i>vrf-name</i> : Specifies the VRF name.
Command Mode	IP RNS DNS configuration mode (config-ip-rns-dns) IP RNS ICMP echo configuration mode (config-ip-rns-icmp-echo)
Usage Guide	This command specifies the VRF of the test packet.

Configuration Example

<p>Figure 9-3</p>	
	<p>Configure RNS instance 1 and related parameters on Switch A.</p>
<p>Switch A</p>	<pre>A# configure terminal A(config)# ip rns 1 A(config-ip-rns)#icmp-echo 10.2.2.2 A(config-ip-rns-icmp-echo)#exit A(config)#ip rns schedule 1 start-time now life forever</pre>
	<p>Run the show ip rns configuration command to display the instance configurations.</p>
<p>Switch A</p>	<pre>A#show ip rns configuration 1 Entry number: 1 Tag: Type of operation to perform: icmp-echo Operation timeout (milliseconds): 5000 Operation frequency (milliseconds): 60000 Threshold (milliseconds): 5000 Recurring (Starting Everyday): FALSE Life (seconds): foerver Next Scheduled Start Time:Start Time already passed Target address/Source address: 10.2.2.2/0.0.0.0 Request size (ARR data portion): 36</pre>

9.4.3 Configuring the DNS Test

Configuration Effect

Create an IP RNS test of the DNS type and implement the DNS test.

Notes

- The RNS basic functions must be configured.

Configuration Steps

➤ Creating an IP RNS Test of the DNS Type

- Mandatory.
- Perform this configuration on every switching device unless otherwise required.

➤ Configuring Common Optional Parameters of the Test

- Perform this configuration if it is required to change common optional parameters of the test, such as the repeat interval, tag, time threshold, timeout, and TOS.
- Perform this configuration on every switching device unless otherwise required.

Verification

- Run the **show ip rns configuration** command to display the instance configurations.

Related Commands

↘ Creating an IP RNS Test of the DNS Type

Command	dns { oob <i>destination-hostname</i> name-server <i>ip-address</i> }
Parameter Description	oob : Indicates the test on the MGMT interface. <i>destination-hostname</i> : Indicates the destination host name. name-server <i>ip-address</i> : Indicates the IP address of the DNS server.
Command Mode	IP RNS configuration mode (config-ip-rns)
Usage Guide	You must first configure the type of the IP RNS test (such as the ICMP echo test), and then configure parameters of the test type. To modify the test type of an IP RNS test, you must first delete this IP RNS test by running the no ip rns command in global configuration mode.

↘ Configuring the Test Repeat Interval

Command	frequency <i>milliseconds</i>
Parameter Description	<i>milliseconds</i> : Indicates the packet sending interval in ms. The default value is 60,000 ms. The value ranges from 10 to 604,800,000. The maximum value is one week.
Command Mode	IP RNS DNS configuration mode (config-ip-rns-dns) IP RNS ICMP echo configuration mode (config-ip-rns-icmp-echo)
Usage Guide	Tests are conducted periodically in an IP RNS test lifecycle. You can run the frequency command to specify the repeat interval. The configured frequency must meet the requirement of the following formula to ensure calculation correctness of the test: (frequency milliseconds) > (timeout milliseconds) >= (threshold milliseconds)

↘ Configuring a Tag for an IP RNS Test

Command	tag <i>text</i>
Parameter Description	<i>text</i> : Sets the test tag. The value is a string of up to 79 characters.
Command Mode	IP RNS DNS configuration mode (config-ip-rns-dns) IP RNS ICMP echo configuration mode (config-ip-rns-icmp-echo)
Usage Guide	This command specifies a tag for a test, which is often used to indicate the function of the test.

↘ Configuring the Upper Threshold of an RNS Test

Command	threshold <i>milliseconds</i>
Parameter	<i>milliseconds</i> : Indicates the upper threshold of the test. The value ranges from 0 to 60,000. The unit is ms. The default

Description	value is 5,000.
Command Mode	IP RNS DNS configuration mode (config-ip-rns-dns) IP RNS ICMP echo configuration mode (config-ip-rns-icmp-echo)
Usage Guide	The value of threshold must be equal to or smaller than the value of timeout . For the relationship between timeout , frequency , and threshold , see "Usage Guide" of the frequency command. The value of threshold must be smaller than the value of timeout .

↘ Configuring the Timeout of an IP RNS Test

Command	timeout <i>millisecond</i>
Parameter Description	<i>millisecond</i> : Indicates the test timeout. The value ranges from 10 to 604,800,000. The unit is ms. The default timeout varies according to the test type.
Command Mode	IP RNS DNS configuration mode (config-ip-rns-dns) IP RNS ICMP echo configuration mode (config-ip-rns-icmp-echo)
Usage Guide	The value of timeout must be equal to or greater than the value of threshold . For the relationship between timeout , frequency , and threshold , see "Usage Guide" of the frequency command.

↘ Configuring the TOS Field in the IPv4 Packet Header of an IP RNS Test

Command	tos <i>number</i>
Parameter Description	<i>number</i> : Sets the TOS field in the IPv4 test packet. The value ranges from 0 to 255. The default value is 0.
Command Mode	IP RNS DNS configuration mode (config-ip-rns-dns) IP RNS ICMP echo configuration mode (config-ip-rns-icmp-echo)
Usage Guide	TOS is a 8-bit field in the IPv4 packet header. By setting the TOS, you can control the priority of the test packet. For different TOS fields, the processing priorities are different on the intermediate routers.

↘ Configuring the VRF of an IP RNS Test

Command	vrf <i>vrf-name</i>
Parameter Description	<i>vrf-name</i> : Specifies the VRF name.
Command Mode	IP RNS DNS configuration mode (config-ip-rns-dns) IP RNS ICMP echo configuration mode (config-ip-rns-icmp-echo)
Usage Guide	This command specifies the VRF of the test packet.

Configuration Example

<p>Scenario Figure 9-4</p>	
<p>Configuration Steps</p>	<p>Configure RNS instance 1 and related parameters on Switch A.</p>
<p>Switch A</p>	<pre>A# configure terminal A(config)# ip rns 1 A(config-ip-rns)# dns www.FS.com.cn name-server 10.2.2.2 A(config-ip-rns-dns)#exit A(config)ip rns schedule 1 start-time now life forever</pre>
<p>Verification</p>	<p>Run the show ip rns configuration command to display the instance configurations.</p>
<p>Switch A</p>	<pre>A#show ip rns configuration 1 Entry number: 1 Tag: Type of operation to perform: dns Operation timeout (milliseconds): 5000 Operation frequency (milliseconds): 60000 Threshold (milliseconds): 5000 Recurring (Starting Everyday): FALSE Life (seconds): forever Next Scheduled Start Time:Start Time already passed Target host name: www.FS.com.cn Name Server: 10.2.2.2</pre>

Common Errors

- The IP address of the server is incorrect.

9.4.4Configuring the Track Support for the RNS

Configuration Effect

- Configure the track function to track the test result of an RNS instance.
- Configure the track function to track the link status of an interface.
- Configure the track function to track the status of a track list.
- Configure the track function to track the status of an RNS list.

Notes

- To configure the track function to track the test result of an RNS instance, you need to configure the related RNS instance.
- To configure the track function to track the link status of an interface, you need to configure the related interface.
- To configure the track function to track the status of a track list, you need to configure the members for the related track list.
- To configure the track function to track the status of an RNS list, you need to configure the members for the related RNS list.

Configuration Steps

▾ Configuring a Track Object

- Perform this operation if it is required to create a track object.
- The following four methods are available to create a track object:
 - Create a track object for tracking the test result of an RNS instance: Perform this configuration on every switching device unless otherwise required.
 - Create a track object for tracking the link status of an interface: Perform this configuration on every switching device unless otherwise required.
 - Create a track object for tracking the status of a track list: Perform this configuration on every switching device unless otherwise required.
 - Create a track object for tracking the status of an RNS list: Perform this configuration on every switching device unless otherwise required.

▾ Configuring the Notification Delay of a Track Object

- Perform this configuration if it is required to delay notification of the status change of a track object.
- Delay for notifying the status change of a track object includes the delay for notifying the status change of a track object from UP to DOWN and the delay for notifying the status change of a track object from DOWN to UP. You can configure either delay or both of delays.
- Perform this configuration on every switching device unless otherwise required.

▾ Configuring a Track Member

- Perform this configuration if it is required to configure a track object for tracking the status of a track list.
- When configuring a track member, you can set the status of a member meeting conditions to UP or DOWN.
- Perform this configuration on every switching device unless otherwise required.

Verification

Observe the status of a track object when the status of the track object (such as test results of an RNS instance, link status of an interface, or status of a track list) changes.

- After the preset delay, run the **show track** command to check whether the current track status changes.

Related Commands

▾ Configuring a Track Object for Tracking the Link Status of An Interface

Command	track object-number interface interface-type interface-number line-protocol
Parameter	<i>object-number</i> : Indicates the number of a track object. The value ranges from 1 to 700.

Description	<i>Interface-type interface-number</i> : Indicates the interface type and interface number.
Command	Global configuration mode
Mode	
Usage Guide	Run this command to configure a track object for tracking the link status of an interface. When the link status of the interface is UP, the status of the corresponding track object is UP.

↘ **Configuring a Track Object for Tracking the Test Result of an RNS Instance**

Command	track <i>object-number</i> rns <i>entry-number</i>
Parameter	<i>object-number</i> : Indicates the number of a track object. The value ranges from 1 to 700.
Description	<i>entry-number</i> : Indicates the number of an RNS object. The value ranges from 1 to 500.
Command	Global configuration mode
Mode	
Usage Guide	Run this command to configure a track object for tracking the test result of an RNS instance. When the test result of the RNS instance is successful, the status of the corresponding track object is UP.

↘ **Configuring a Track Object for Tracking the Status of a Track List**

Command	track <i>object-number</i> listboolean { and or }
Parameter	<i>object-number</i> : Indicates the number of a track object. The value ranges from 1 to 700.
Description	
Command	Global configuration mode
Mode	
Usage Guide	Run this command to configure a track object for tracking the status of a track list. The result can be the AND or OR operation result of all member status.

↘ **Configuring a Track Member**

Command	object <i>object-number</i> [not]
Parameter	<i>object-number</i> : Indicates the number of a track object. The value ranges from 1 to 700.
Description	
Command	Track configuration mode
Mode	
Usage Guide	Run this command to configure a member for a track list. The number of track list members that can be configured is restricted only by the capacity of track objects.

↘ **Configuring a Track Object for Tracking the Status of an RNS List**

Command	track <i>object-number</i> rns-list <i>men-list</i> { and or }
Parameter	<i>object-number</i> : Indicates the number of a track object. The value ranges from 1 to 700.
Description	<i>men-list</i> : Indicates the RNS list that is tracked. mem-list can be an RNS instance or a series of RNS instances. If mem-list is a series of RNS instances, the format is as follows: Smallest RNS ID–Greatest RNS ID, for example, 10–20. The RNS ID ranges from 1 to 500.
Command	Global configuration mode
Mode	
Usage Guide	Run this command to configure a track object for tracking the status of an RNS list. The result can be the AND or OR operation result of all member status.

Configuring the Notification Delay of a Track Object

Command	delay { <i>upseconds</i> [<i>downseconds</i>] [<i>upseconds</i>] <i>downseconds</i> }
Parameter Description	<p>up seconds: Specifies the delay for notifying the status change of a track object from DOWN to UP. The value ranges from 0 to 180. The unit is second. The default value is 0.</p> <p>downseconds: Specifies the delay for notifying the status change of a track object from UP to DOWN. The value ranges from 0 to 180. The unit is second. The default value is 0.</p>
Command Mode	Track configuration mode
Usage Guide	<p>When the status of a track object frequently changes, the status of the client that use this track object will frequently change as well.</p> <p>Using this command can delay notification of the status change of a track object. For example, if the status of a track object changes from UP to DOWN, and delay down 10 is configured, the DOWN status of the track object is notified 10s later. If the status of the track objects changes to UP again within this period of time, no notification is sent. For the client that uses this track object, the status of the track object is always UP.</p>

📌 **Displaying the Track Object Statistics**

Command	showtrack [<i>object-number</i>]
Parameter Description	<i>object-number:</i> Indicates the number of a track object. The value ranges from 1 to 700. The default is all track objects.
Command Mode	Privileged EXEC mode
Usage Guide	Run this command to display statistics of track objects.

Configuration Example

📌 **Configuring Track Object3 for Tracking the Link Status of the Interface FastEthernet 1/0**

Configuration Steps	<ul style="list-style-type: none"> ● Configure a track object for tracking the link status of an interface. ● Configure the delay for notifying the status change from UP to DOWN.
	<pre>FS# configure terminal FS(config)# track 3 interface FastEthernet 1/0 line-protocol FS(config-track)# delay down 10 FS(config-track)# exit</pre>
Verification	<p>Change the link status of the interface FastEthernet 1/0 to DOWN.</p> <ul style="list-style-type: none"> ● Immediately check the status of the track object, and verify that the status is still UP. ● Check the status of the track object 10s later, and verify that the status changes to DOWN.
	<pre>FS# show track 3 Track 3 Interface FastEthernet 1/0 The state is Up, delayed Down (5 secs remaining) 1 change, current state last: 300 secs Delay up 0 secs, down 10 secs</pre>

➤ **Configuring Track Object 3 (When the status of track object 1 is UP, and the status of track object 2 is DOWN, the status of track object 3 is UP.)**

<p>Configuration Steps</p>	<ul style="list-style-type: none"> ● Configuring track object 1 and track object 2. ● Configure track object 3, and its members include track object 1 and track object 2.
	<pre> FS # config FS(config)#track 1 interface gigabitEthernet 0/0 line-protocol FS(config-track)#delay up 20 down 40 FS(config-track)#exit FS(config)# FS(config)#track 2 interface gigabitEthernet 0/1 line-protocol FS(config-track)#delay down 30 FS(config-track)#exit FS(config)# track 3 list Boolean and FS(config-track)#object 1 FS(config-track)#object 2 not FS(config-track)# exit </pre>
<p>Verification</p>	<p>When the status of track objects 1 and 2 change, check the status of track object 3.</p> <ul style="list-style-type: none"> ● When the status of track object 1 changes from DOWN to UP, and the status of track object 2 remains DOWN, verify that the status of track object 3 changes from DOWN to UP. ● When the status of track object 1 remains UP, and the status of track object 2 changes from DOWN to UP, verify that the status of track object 3 changes from UP to DOWN.
	<pre> FS# show track 3 Track 3 List boolean and Object 1 Object 2 not The state is Down 1 change,current state last:10 secs Delay up 0 secs,down 0 secs </pre>

➤ **Configuring Track Object 5 for Tracking the Test Result of RNS Instance 7**

<p>Configuration Steps</p>	<ul style="list-style-type: none"> ● Configure an RNS instance. ● Configure a track object for tracking the test result of an RNS instance. ● Configure the delay for notifying the test result change from successful to unsuccessful, and the delay for notifying the test result change from unsuccessful to successful.
-----------------------------------	--

	<pre> FS# configure terminal FS (config)#ip rns 7 FS (config-ip-rns)#icmp-echo 2.2.2.2 FS (config-ip-rns-icmp-echo)#exit FS (config)#ip rns schedule 7 start-time now life forever FS(config)# track 5 rns 7 FS (config-track)# delay up 20 down 30 FS (config-track)# exit </pre>
<p>Verification</p>	<p>Let the test result of RNS instance 7 change from successful to unsuccessful.</p> <ul style="list-style-type: none"> ● When the test result changes to unsuccessful, immediately check the status of track object 7, and verify that the status is still UP. ● Check the status of the track object 30s later, and verify that the status changes to DOWN.
	<pre> FS# show track 5 Track 5 Reliable Network Service 7 The state is Down 2 change, current state last: 10 secs Delay up 20 secs, down 30 secs </pre>

📌 Configuring Track Object 5 for Tracking the Test Results of an RNS List (consisting of RNS Instances 1, 2-5, and 8)

<p>Configuration Steps</p>	<ul style="list-style-type: none"> ● Configure and start the RNS. ● Configure a track object for tracking the test result of an RNS list. ● Configure the delay for notifying the test result change from UP to DOWN, and the delay for notifying the test result change from DOWN to UP.
	<pre> FS(config)# track 5 rns-list 1,2-5,8 and FS (config-track)# delay up 20 down 30 FS (config-track)# exit </pre>
<p>Verification</p>	<p>Let the test result of one of the RNS instances 1, 2-5, and 8 changes from successful to unsuccessful.</p> <ul style="list-style-type: none"> ● When the test result changes to unsuccessful, immediately check the status of track object 7, and verify that the status is still UP. ● Check the status of the track object 30s later, and verify that the status changes to DOWN.

```

FS# show track 5
Track 5
  rns-list 1,2-5,8 and
  The state is Down
    2 change, current state last: 10 secs
    Delay up 20 secs, down 30 secs
    
```

Common Errors

- The track object for tracking an RNS instance is configured, but the corresponding RNS instance is not configured.
- The track object for tracking the link status of an interface is configured, but the corresponding interface is not configured.
- The track object for tracking the status of a track list, but no member of the RNS list is configured.
- The track object for tracking the status of an RNS list is configured, but the corresponding RNS instance is not configured.

9.5 Monitoring

Displaying

Description	Command
Displays configurations of one or more RNS instances.	show ip rns configuration [<i>operation-number</i>]
Displays detailed statistics of one or more RNS instances.	show ip rns collection-statistics [<i>operation-number</i>]
Displays the current RNS status.	show ip rns operational-state [<i>operation-number</i>]
Displays the proactive threshold monitoring information of one or more RNS instances.	show ip rns reaction-configuration [<i>operation-number</i>]
Displays information about the test triggered by one or more RNS instances.	show ip rns reaction-trigger [<i>operation-number</i>]
Displays the brief statistics of one or more RNS instances.	show ip rns statistics [<i>operation-number</i>]
Displays the brief statistics of one or more track objects.	show track [<i>object-number</i>]
Displays the brief statistics of a track client.	show track client

Debugging

System resources are occupied when debugging information is output. Therefore, disable debugging immediately after use.

Description	Command
Debugs the track module.	debug track { all proc-event rdnd-event client }
Debugs the RNS module.	debug rns { all interface lib rdnd-event restart rns_id [0 , 500] }

10 Configuring PCAP

10.1 Overview

Packet Capture (PCAP) is a maintenance function commonly used in network devices.

Similar to the packet capture software running on a personal computer, the PCAP function can capture, save, or display the packets sent from and received by the network device.

10.2 Applications

Application	Description
Capturing Packets	During routine maintenance, if you find packet sending or receiving failures in the network, specify the capture point and capture direction, enter the packet feature, and start the packet capture to check whether the packets arrives at the device or are sent from the device.

10.2.1 Capturing Packets

Scenario

During routine maintenance, if you find packet sending or receiving failures in the network, specify the capture point and capture direction, enter the packet feature, and start the packet capture to check whether the packets arrives at the device or are sent from the device.

Deployment

Perform packet capture as follows:

- Create a capture feature rule and name it.
- Create a capture point and specify the capture point name, capture location (physical port, VLAN, and control plane), capture direction, and capture feature.
- Specify the name of the file to be saved.
- Enable packet capture at the capture point.
- Wait until the capture ends.
- Upload the file to the PC.
- Enable the capture software on the PC to check the captured packets.

10.3 Features

Overview

Feature	Description
Capturing Packets on Control Plane	Clients can define the capture point and specify the capture location and direction, matching rule information, number of captured packets, and file name; and then enable the capture procedure.
Capturing Packets on	Users can specify rules of matching between ACL IDs and physical ports (ACL IDs are mandatory and physical

<u>Forwarding Plane</u>	ports are optional), number of to-be-captured packets, name of the file for storing captured packets, and other information, and then start the packet capture.
-------------------------	---

10.3.1 Capturing Packets on Control Plane

Clients can define the capture point and specify the capture location and direction, matching rule information, number of captured packets, and file name; and then enable the capture procedure.

Working Principle

Clients can define the capture rules by defining capture points. To capture multiple types of packets at the same time, a client is allowed to define multiple capture points and distinguish them by their names. The capture rules are as follows:

- 1) The capture location can be selected from the certain physical port, VLAN port, and system control plane. Each capture point can only have one capture location.
- 2) The available capture directions can be the outgoing direction, incoming direction, and bidirectional.
- 3) The 7-tuple information can match the source MAC address, destination MAC address, layer-2 protocol type, source IP address, destination IP address, layer-3 protocol type, and TCP/UDP port information.
- 4) The number of captured packets or size of the captured packet can be specified.
- 5) The file name can be specified. The captured packet will be saved in PCAP file format.

A client enables capture via commands after the rules are configured. The capture will automatically stop when the number of captured packets or the file size reaches the specified value, or when timeout happens. The client can also stop the capture after commands are entered manually.

10.3.2 Capturing Packets on Forwarding Plane

Users can specify rules of matching between ACL IDs and physical ports (ACL IDs are mandatory and physical ports are optional), number of to-be-captured packets, name of the file for storing captured packets, and other information, and then start the packet capture.

Working Principle

1. The rule of matching between ACL IDs and physical ports can be specified for packet capture and physical ports are optional.
2. Multiple rules of matching between ACL IDs and physical ports can be configured for packet capture.
3. Packet capture at the ingress is supported.
4. No packet capture point needs to be specified and 7-tuple matching information is not supported.
5. The number of to-be-captured packets or the size of the file for storing captured packets can be defined.
6. Captured packets are stored in a specified file in the PCAP file format. Users can run commands to start packet capture after configuring rules. The capture automatically stops when the number of captured packets or the file size reaches the specified value or when timeout occurs. Users can also run commands to manually stop packet capture.

10.4 Configuration

Configuration	Description and Command	
Capturing Packets on Control Plane	packet capture rule <i>rule-name</i> filter [src-mac <i>smac</i>] [dst-mac <i>dmac</i>][etype <i>type</i> ip arp] [ipv4-sip <i>sip sip-mask</i>] [ipv4-dip <i>dip dip-mask</i>] [ipv6-sip <i>sipv6 sipv6-prefix</i>] [ipv6_dip <i>dipv6 dipv6-prefix</i>] [v6_protocol <i>protocol</i> tcp udp] [ipv6_sport <i>sport</i>] [ipv6_dport <i>dport</i>] [v4_protocol <i>protocol</i> tcp udp] [ipv4_sport <i>sport</i>] [ipv4_dport <i>dport</i>]	Defines capture matching rule.
	packet capture point <i>capture-point-name</i> rule <i>rule-name</i> location { interface <i>interface-name</i> control-plane } { in out both }	Creates the capture point and specifies the capture location, matching rule, and capture direction.
	packet capture file <i>filename</i> [buffer-size <i>buf-size</i>] [packet-num <i>pkt-num</i>] [timeout <i>timeout</i>]	Specifies the name of the file to be saved.
	packet capture { start stop }	Starts/Stops packet capture.
Capturing Packets on Forwarding Plane	packet capture rule <i>rule-name</i> filter acl <i>aclid</i> <i>aclname</i> [interface <i>interface-name</i>]	Defines capture matching rule.
	packet capture file <i>filename</i> [buffer-size <i>buf-size</i>][packet-num <i>pkt-num</i>] [timeout <i>timeout</i>]	Specifies the name of the file to be saved.
	packet capture { start stop }	Starts/Stops packet capture.

10.4.1 Capturing Packets on Control Plane

Configuration Effect

- Define the capture matching rule.
- Create the capture point.
- Specify the name of the file to be saved.
- Start packet capture.
- Stop packet capture.

Configuration Steps

➤ Defining Capture Matching Rule

- (Mandatory) Run this command to define the packet capture rule.

Command	packet capture rule <i>rule-name</i> filter [src-mac <i>smac</i>] [dst-mac <i>dmac</i>] [etype <i>type</i> ip arp] [ipv4_sip <i>sip sip-mask</i>] [ipv4_sip <i>dip dip-mask</i>] [ipv6_sip <i>sipv6 sipv6-prefix</i>] [ipv6_dip <i>dipv6 dipv6-prefix</i>][v6_protocol <i>protocol</i> tcp udp] [ipv6_sport <i>sport</i>] [dst-port <i>dport</i>] [v4_protocol <i>protocol</i> tcp udp] [ipv4_sport <i>sport</i>] [dst-port <i>dport</i>]
Parameter Description	<i>rule-name</i> : Indicates the matching rule name. <i>smac</i> : Indicates the source MAC address. <i>dmac</i> : Indicates the destination MAC address.

	<p><i>type</i> ip arp: Indicates the layer-2 protocol type.</p> <p><i>sip</i>: Indicates the source IP address.</p> <p><i>sip-mask</i>: Indicates the source IP address mask.</p> <p><i>dip</i>: Indicates the destination IP address.</p> <p><i>dip-mask</i>: Indicates the destination IP address mask.</p> <p><i>sipv6</i>: Indicates the source IPv6 address.</p> <p><i>sipv6-prefix</i>: Indicates the source IPv6 prefix.</p> <p><i>dipv6</i>: Indicates the destination IPv6 address.</p> <p><i>sipv6-prefix</i>: Indicates the destination IPv6 prefix.</p> <p><i>protocol</i> tcp udp: Indicates the layer-3 protocol type.</p> <p><i>sport</i>: Indicates the TCP/UDP protocol source port.</p> <p><i>dport</i>: Indicates the TCP/UDP protocol destination port.</p>
Defaults	-
Command Mode	Privileged EXEC mode
Usage Guide	<ol style="list-style-type: none"> 1. The user can define multiple capture rules and distinguish them by different names. After a rule is defined, the rule needs to be referenced by the packet capture point to actually take effect. 2. Before deleting the capture rule, all the packet capture points referencing the rule need to be deleted.

↘ Creating Capture Point

- (Mandatory) Run this command to create the capture point.

Command	packet capture point <i>capture-point-name</i> rule <i>rule-name</i> location (interface <i>interface-name</i> control-plane) { in out both }
Parameter Description	<p><i>capture-point-name</i>: Indicates the capture point name.</p> <p><i>rule-name</i>: Indicates the matching rule name, which is defined by running the packet capture rule command.</p> <p><i>interface-name</i>: Indicates the name of the port on which packets are captured.</p> <p><i>vlan-id</i>: Indicates the ID of the VLAN in which packets are captured.</p> <p>control-plane: Indicates the control plane on which packets are captured.</p> <p>in out both: Indicates the capture direction (incoming, outgoing, or bidirectional).</p>
Defaults	-
Command Mode	Privileged EXEC mode
Usage Guide	<ol style="list-style-type: none"> 1. The user can define multiple capture points at the same location as required to match different capture rules or packet directions. The capture points can work simultaneously without affecting each other. 2. If the capture point is modified during packet capture, the modification will not take effect immediately and will take effect next time when packet capture is enabled.

↘ Specifying Name of File to Be Saved

- (Optional) Run this command to specify the name of the file to be saved.

Command	packet capture file <i>filename</i> [buffer-size <i>buf-size</i>] [packet-num <i>pkt-num</i>] [timeout <i>timeout</i>]
Parameter Description	<p><i>filename</i>: Indicates the name of the file to be saved.</p> <p><i>buf-size</i>: Indicates the buffer size. The buffer size is 2 MB by default if not specified. Packet capture automatically stops when the buffer is full. Up to 200M buffer is supported.</p>

	<p><i>pkt-num</i>: Indicates the number of captured packets. Packet capture automatically stops when the number of captured packets reaches the specified number. 1024 packets will be captured continually by default unless otherwise specified.</p> <p><i>timeout</i>: Indicates packet capture timeout. Packet capture automatically stops when the time of captured packets reaches the specified number. The default packet capture time is 10 minutes unless otherwise specified. The longest continually packet capture time is 120 minutes.</p>
Defaults	-
Command Mode	Privileged EXEC mode
Usage Guide	1. The file name setting takes effect next time packet capture is enabled.

📌 **Starting/Stopping Packet Capture**

- (Mandatory) Enter this command to start or stop packet capture.

Command	packet capture { start stop}
Parameter Description	start stop : Starts/Stops packet capture.
Defaults	-
Command Mode	Privileged EXEC mode
Usage Guide	<p>1. If the packet capture stop command is not entered after packet capture starts, the packet capture automatically stops at the capture point when the number of captured packets reaches the specified number. If the packet capture stop condition is not met, run this command to immediately stop the packet capture.</p> <p>2. Run the packet capture start command to capture packets at all packet capture points simultaneously.</p>

Verification

Run the **show packet capture status** command to display packet capture information.

Command	show packet capture status
Parameter Description	N/A
Command Mode	Privileged EXEC mode
Usage Guide	Run this command to display the packet capture status.
Command Presentation	<pre> FS#show packet capture status Capture rules: Capture rules tcp: etype: 0x0800 source MAC: 2222.2222.2222 destination MAC: 1111.1111.1111 </pre>

protocol: 0x6
source IP: 10.10.10.3
destination IP: 10.10.10.10
source port: 5
destination port: 10

Capture points:

Capture point controlplane:

Capture rules: tcp

location: control-plane

direction: all

Capture file:

Filename: /tmp/tcp.pcap

Buffer size: 2(MB)

Capture Statistic:

Status: stop

Stop reason: Normal

Start time: 2017-5-20 9:24:19

End time: 2017-5-20 9:28:19

Timeout: 10(minutes)

Packets limit: 1024

Packet capture cnts:10

FS#

Configuration Example

↳ Capturing Packets

Scenario	<ul style="list-style-type: none"> ● In the client environment, the TCP connection of a certain application on a device connected to Port 0/1 fails, TCP packets need to be captured on this port for analysis.
Configuration Steps	<ul style="list-style-type: none"> ● Run the packet capture command to capture and save TCP packets to the file tcp.pcap and upload the file to a PC to display the captured data.
	<pre>FS# packet capture rule tcp etype ip protocol tcp FS# packet capture point tcppoint rule tcp location interface gi0/1 both FS# packet capture file usb0:tcp.pcap packet-num 1500 FS# packet capture start</pre>
Verification	<pre>FS#show packet capture status Capture rules: Capture rules tcp: etype: 0x0800 protocol: 0x6 Capture points: Capture point tcppoint: Capture rules: tcp location: Gi0/1 direction: all Capture file: Filename: /mnt/usb0/tcp.pcap Buffer size: 2(MB) Capture Statistic: Status: running Timeout: 10(minutes) Packets limit: 1500 Packet capture cnts:10</pre>

10.4.2 Capturing Packets on Forwarding Plane

Configuration Effect

- Define the capture matching rule.
- Specify the name of the file to be saved.

- Start packet capture.
- Stop packet capture.

Configuration Steps

📌 Defining Capture Matching Rule

- (Mandatory) Run this command to define the packet capture rule.

Command	packet capture rule <i>rule-name</i> filter acl <i>aclid</i> [interface <i>interface-name</i>]
Parameter	<i>rule-name</i> : Indicates the matching rule name.
Description	<i>aclid</i> : Indicates the ACL ID or name. <i>interface-name</i> : Indicates the interface.
Defaults	-
Command Mode	Privileged EXEC mode
Usage Guide	The user can define multiple capture rules and distinguish them by different names. After a rule is defined, the rule needs to be referenced by the packet capture point to actually take effect.

📌 Specifying Name of File to Be Saved

- (Optional) Run this command to specify the name of the file to be saved.

Command	packet capture file <i>filename</i> [buffer-size <i>buf-size</i>] [packet-num <i>pkt-num</i>] [timeout <i>timeout</i>]
Parameter	<i>filename</i> : Indicates the name of the file to be saved.
Description	<i>buf-size</i> : Indicates the buffer size. The buffer size is 2 MB by default if not specified. Packet capture automatically stops when the buffer is full. Up to 200 MB buffer is supported. <i>pkt-num</i> : Indicates the number of captured packets. Packet capture automatically stops when the number of captured packets reaches the specified number. 1024 packets will be captured continually by default unless otherwise specified. <i>timeout</i> : Indicates packet capture timeout. Packet capture automatically stops when the time of captured packets reaches the specified number. The default packet capture time is 10 minutes unless otherwise specified. The longest continually packet capture time is 120 minutes.
Defaults	-
Command Mode	Privileged EXEC mode
Usage Guide	1. The file name setting takes effect next time packet capture is enabled.

📌 Starting/Stopping Packet Capture

- (Mandatory) Enter this command to start or stop packet capture.

Command	packet capture { start stop }
Parameter	start stop : Starts/Stops packet capture.
Description	
Defaults	-
Command Mode	Privileged EXEC mode
Usage Guide	If the packet capture stop command is not entered after packet capture starts, the packet capture automatically

	stops at the capture point when the number of captured packets reaches the specified number. If the packet capture stop condition is not met, run this command to immediately stop the packet capture.
--	--

Verification

Run the **show packet capture status** command to display packet capture information.

Command	show packet capture status
Parameter	N/A
Description	
Command Mode	Privileged EXEC mode
Usage Guide	Run this command to display the packet capture status.
Command Presentation	<pre> FS#show packet capture status Capture rules: Capture rules rule1: acl_id: 1 Capture file: Filename: /tmp/vsd/0/test.pcap Buffer size: 2(MB) Capture Statistic: Status: stopped Stopped reason: Normal Timeout: 10(minutes) Packets limit: 1024 Write file packet count: 0 FS# </pre>

Configuration Example

↳ Capturing Packets

Scenario	<ul style="list-style-type: none"> In the client environment, a traffic error occurs to interface 0/1. Traffic may not reach the device. Therefore, packets need to be captured on this port for analysis.
Configuration Steps	<ul style="list-style-type: none"> Run the packet capture command to capture and save TCP packets to the file tcp.pcap and upload the file to a PC to display the captured data.
	<pre> FS(config)#access-list 100 permit tcp host 1.1.1.1 any FS(config)#exit FS#packet capture rule rule1 filter acl 100 interface tenGigabitEthernet 0/1 </pre>

	<pre>FS# packet capture file usb0:tcp.pcap packet-num 1500 FS# packet capture start</pre>
Verification	<pre>FS#show packet capture status Capture rules: Capture rules rule1: acl_id: 100 acl_ifx: TenGigabitEthernet 0/1 Capture file: Filename: /tmp/vsd/0/test.pcap Buffer size: 2(MB) Capture Statistic: Status: running Start time: 2018-6-4 16:34:55 Timeout: 10(minutes) Packets limit: 1024 Write file packet count: 4</pre>

10.5 Monitoring

Displaying

Description	Command
Displays the packet capture status.	show packet capture status

10.6 Restrictions on the Packet Capture Function

1. Packet capture cannot be configured on the MGMT port but on physical ports.
2. Packet capture cannot be configured on SVIs or VSL interfaces.
3. The packet capture configuration cannot be saved.
 - 1) The packet capture configuration is lost after the efmp_frame.elf process or device is restarted.
 - 2) VSU configuration cannot be synchronized. If packet capture is configured on the active VSU, the packet capture configuration will be lost after active/standby switchover.

4. Interfaces of non-master member devices cannot be configured as packet capture interfaces. Aggregation port (APs) whose member ports include interfaces of non-master member devices can be configured as packet capture interfaces.
5. Either control plane packet capture rules or forwarding plane packet capture rules can be configured at a time. The two types of rules are mutually exclusive.
6. Packet capture is available only when the permit entry is configured in forwarding plane ACL rules. The deny entry in rules does not support packet capture by default.
7. The forwarding plane PCAP function takes effect only on incoming packets. It does not send outgoing packets to the CPU.
8. Packet capture on APs (depending on project requirements):
 - (1) On devices used in early projects such as **N18000_FSOS 11.3(1)B1 R(M08282403212015)**, the forwarding plane packet capture function is available only on physical ports but unavailable on APs.
 - (2) On certain devices used in some released projects such as **S6500_FSOS 11.0(5)B9P43 R(M10544905142019)**, packet capture can be enabled on APs by running commands (some products do not support packet capture on member ports of APs due to chip limitations).
 - (3) On devices used in new projects such as **FSOS 11.0(5)B9P36 R(M20524506292019)**, packet capture is supported on APs (including member ports).

11 Configuring HAM

11.1 Overview

1. The High Availability Module (HAM) is a high availability technology of the system.
2. HAM can start a process when it exits.
3. HAM detects whether a process exits after the device is started. If a process that registers with the HA service exits frequently, HAM starts the HA service and automatically restarts the device. To address possible abnormalities in the patch-based upgrade, CLI commands are added to enable/disable the HA service of a process that restarts frequently.

Protocols and Standards

- HAM is a proprietary protocol.

11.2 Applications

Application	Description
HA Service for Starting a Process When the Process Exits	For a process that registers with the HA service, HAM starts the process when detecting the process exit.
HA Service of a Process That Restarts Frequently	<ol style="list-style-type: none"> 1. Before patches are used for an upgrade, you can stop the HA service of a process that restarts frequently. 2. After the patch-based upgrade is completed, confirm that no process restarts frequently and then start the HA service of the process that restarts frequently.

11.2.1 HA Service for Starting a Process When the Process Exits

Scenario

A process may exit in case of abnormalities. HAM can start this process.

Deployment

- On all devices in the system, run the HA service that starts a process when the process exits.

11.2.2HA Service of a Process That Restarts Frequently

Scenario

Originally, the purpose of importing the HA service of a process that restarts frequently is to clear frequent restart abnormalities of the process by restarting devices in some cases.

A process may restart under some abnormal conditions during a patch-based upgrade. If the device automatically restarts, traffic interruption can be caused. Some users desire to configure CLI commands to enable/disable the HA service of a process that restarts frequently.

 If the HA service of a process that restarts frequently is disabled by a command, frequent restart abnormalities of some processes may not be cleared because the device does not restart automatically, resulting in a longer failure time.

Deployment

- On all devices in the system, run the HA service of a process that restarts frequently. Use CLI commands on the master device to enable/disable this service and synchronize the service status to other non-master devices.

11.3Features

Basic Concepts

 **HAM**

The HAM provides a high availability service for user processes.

Overview

Feature	Description
HAM	Includes the HA service that starts a process when the process exits and the HA service of a process that restarts frequently.

11.3.1HAM

A process may exit under some abnormal conditions. If the process is not started, some services will become unavailable. HAM can start the process in such circumstances, thereby restoring services.

Working Principle

HAM perceives the exit of a process by listening to kernel advertisements and starts the process to restore services. If a process exits five times in two minutes, the HAM tries to start the process five minutes later. If two prompts, asking the HAM to start a process five minutes later, are displayed within ten minutes, it is deemed that services cannot be restored and the device needs to be restarted to restore the services.

11.4 Configuration

Configuration	Description and Command	
Enabling and Disabling the HA Service of a Process That Restarts Frequently	 Disabling this HA service can lead to a longer failure time when a process frequently restarts. Therefore, you are not recommended to disable the configuration in scenarios other than patch-based upgrades.	
	ham single-process-ha auto-restart enable	Enables the HA service of a process that restarts frequently.

11.4.1 Enabling and Disabling the HA Service of a Process That Restarts Frequently

Configuration Effect

- Enable the HA service of a process that restarts frequently so that the system tries to automatically restart the device to restore services.

Notes

- It is not recommended to disable the HA service of a process that restarts frequently.

Configuration Steps

▾ Enabling the HA Service of a Process That Restarts Frequently

- Optional. This feature can be used in a patch-based upgrade, to prevent device reset due to patch-based upgrade abnormalities.

Command	ham single-process-ha auto-restart enable
Parameter Description	N/A
Defaults	The HA service of a process that restarts frequently is enabled by default.
Command Mode	Global configuration mode
Usage Guide	This feature can be disabled before a patch-based upgrade. After the patch-based upgrade is completed, confirm that no process restarts frequently and then enable this feature.

Verification

Run the **show running-config | include ham** command to display the current HAM configuration.

Command	show running-config include ham
Parameter Description	N/A
Command Mode	Privileged EXEC mode
Usage Guide	This feature is enabled by default and the configuration is not displayed. If this feature is disabled, the configuration is displayed in the device running configuration.
Command Presentation	<pre>FS#show running-config include HAM FS#</pre>

Configuration Example

▾ Enabling and Disabling the HA Service of a Process That Restarts Frequently

Scenario	The master device for running CLI configuration commands exists.
Configuration Steps	<ul style="list-style-type: none"> ● In global configuration mode, run the no ham single-process-ha auto-restart enable command to disable the HA service of a process that restarts frequently. ● In global configuration mode, run the ham single-process-ha auto-restart enable command to enable the HA service of a process that restarts frequently.
Master Device	<pre>FS# configure terminal Enter configuration commands, one per line. End with CNTL/Z. FS(config)# no ham single-process-ha auto-restart enable FS(config)# show running-config include ham no ham single-process-ha auto-restart enable FS(config)# ham single-process-ha auto-restart enable FS(config)# show running-config include ham FS(config)#</pre>
Verification	Run the show running-config include ham command to check whether the ham single-process-ha auto-restart enable configuration exists. The configuration is not displayed if this feature is enabled but displayed if this feature is disabled.
Master Device	<pre>FS#show running-config include ham no ham single-process-ha auto-restart enable</pre>

Common Errors

- N/A

11.5 Monitoring

Displaying

Description	Command
Displays the current configuration.	show running-config include ham

12 Configuring VAP (MLAG)

12.1 Overview

A Virtual Aggregate Port (VAP) and Multi-Chassis Link Aggregation (MLAG) are composed of two APs on two independent devices.

For other devices accessed through this VAP, the two devices can be considered as one logic device and the two APs of the VAP can be considered as one AP, thereby raising the link reliability from the board level to the device level. See the figure below.

Figure 12-1 VAP

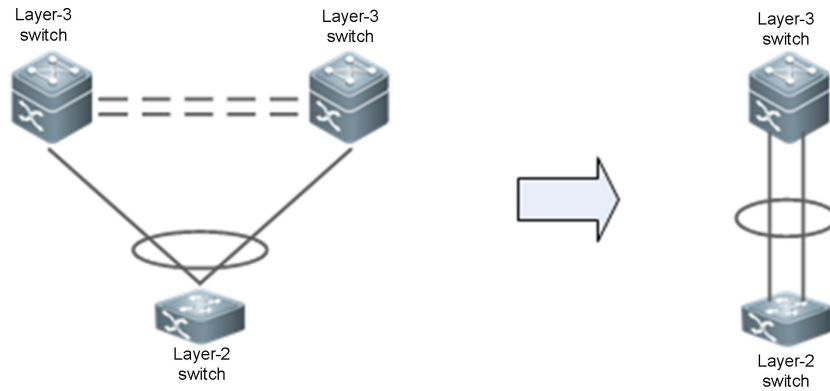

Another similar technology is Virtual Switching Unit (VSU), which virtualizes multiple devices into one device. Compared with VSU, the VAP technology has the following advantages:

- Stacking is discarded and only layer-2 virtualization is required. The two devices are still independent of each other. The VAP reduces deployment difficulties and eliminates shortcomings brought by device stacking (for example, the software failure of the master device may make both devices unavailable).
- Devices can be upgraded independently without affecting the normal operation of the other device.

12.2 Applications

Application	Description
<u>Connecting to an IP Network in Dual-Homing Mode</u>	The two devices of a VAP are connected to an IP network in uplink direction, to implement load balancing of network traffic.
<u>Connecting to a Centralized VXLAN Network in Dual-Homing Mode</u>	The server connects to the network in VXLAN mode and the overlay gateway is configured on the core switch.

12.2.1 Connecting to an IP Network in Dual-Homing Mode

Scenario

The server connects to a network through VAP in dual-homing mode and the server gateway is configured on the VAP devices. The uplink traffic of the server is balanced to two access devices through APs. The downlink traffic is balanced to two access devices through ECMP and then locally forwarded to the server.

Figure 12-2 Connecting a VAP to an IP Network

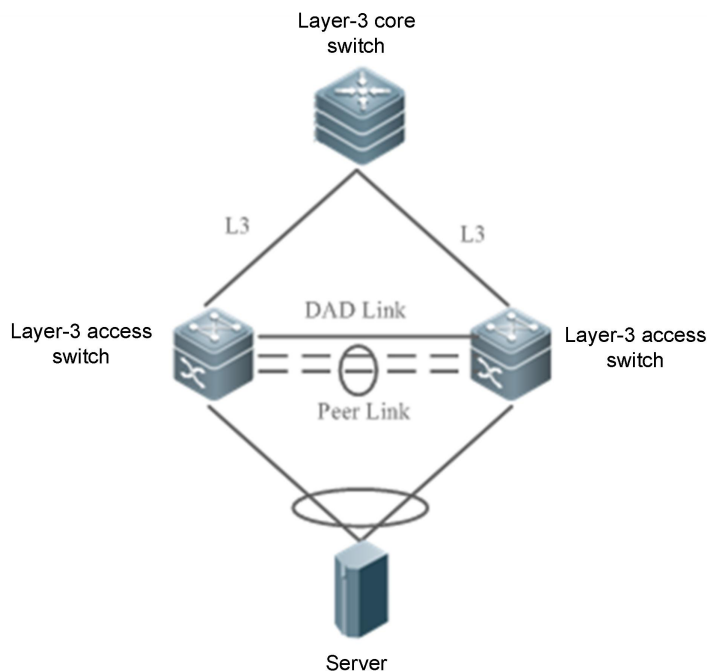

Remarks	AP1 and AP2 are added to the same VAP and are connected to layer-3 devices in uplink direction through routing interfaces and to a server or layer-2 switch in downlink direction.
----------------	--

Deployment

- Configure the same VAP domain on the two devices.
- Configure the same VAP for AP1 and AP2.

12.2.2 Connecting to a VXLAN Network in Dual-Homing Mode

Scenario

The server connects to a VXLAN network through VAP in dual-homing mode and the server gateway is configured on the core switch. The uplink traffic of the server is balanced to two access devices through APs. The downlink traffic is balanced to two access devices through ECMP and then locally forwarded to the server.

Figure 12-3 Connecting a VAP to a Centralized VXLAN Network

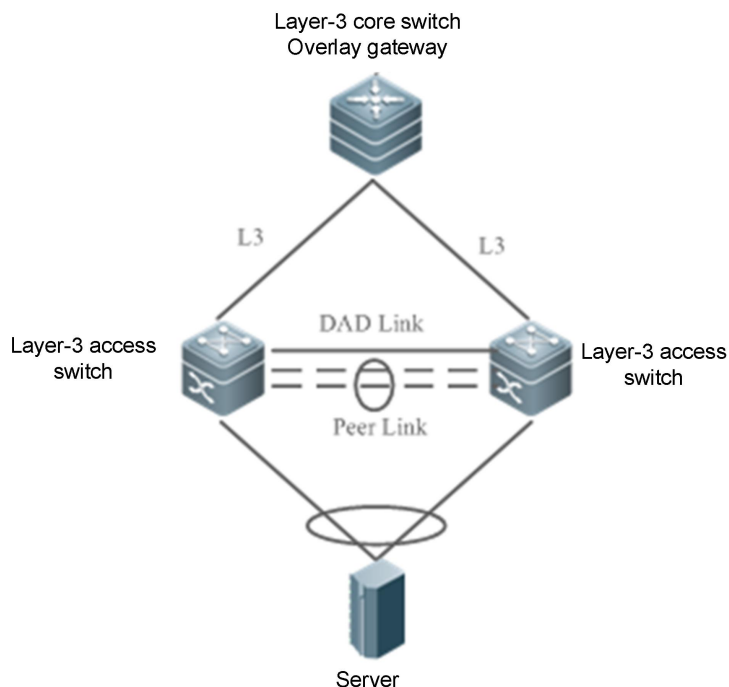

Remarks	AP1 and AP2 are added to the same VAP and are connected to a server or layer-2 switch in downlink direction.
----------------	--

Deployment

- Configure the same VAP domain on the two devices.
- Configure the same VAP for AP1 and AP2.
- Configure VXLAN access and configure the gateway on the core switch.

12.3Features

Basic Concepts

➤ **VAP**

APs on two independent devices form a VAP and only layer-2 APs are supported. Only one AP of a device can be added to the same VAP. One VAP can contain two APs at most.

➤ **VAP Member Interface**

A member interface of a VAP is an AP added to the VAP. A local AP is called the VAP local member interface and a remote AP is called the VAP remote member interface.

➤ **Peer-link**

The peer-link is a link between two devices of a VAP to synchronize data and transmit some traffic. The peer-link is also an AP. In order to enhance the reliability of the peer-link, you are recommended to configure the AP, to which the peer-link belongs, with two or more physical ports. For chassis devices, multiple physical ports should be deployed on different boards to reduce the impact of a board failure.

➤ **Peer-link Interface**

A peer-link interface is a physical port of the peer-link.

➤ **VAP Domain**

A VAP domain consists of two VAP devices connected through the peer-link. The two devices must share the same domain ID.

➤ **Dual-Active Detection Link**

A dual-active detection link is used to detect the dual-active status of VAP devices when the peer-link fails.

➤ **HB Channel**

A Hot-Backup (HB) channel is a TCP connection-based transmission channel established between two VAP devices. The VAP transmits and receives negotiation packets and data through this channel.

Overview

Feature	Description
VAP System Negotiation	A VAP system is built on two devices via negotiation.
Preferential Local Forwarding	Traffic balanced to VAP devices is preferentially forwarded through the local member interface. When the local member interface malfunctions, the traffic is forwarded through the peer-link.
Anti-Loop Mechanism	When the VAP remote member interface works properly, the traffic of the peer-link is not forwarded to the local member interface. When the VAP remote member interface malfunctions, the traffic of the peer-link needs to be forwarded to the local member interface.

12.3.1 VAP System Negotiation

Working Principle

The basis of VAP application is that two devices pair with each other to form a system and provide inter-device aggregation capability. The process is as follows:

1. System pairing

After the domain ID, peer-link, and peer-link-based layer-3 channel are configured for the two VAP devices, the devices synchronize the domain ID with each other through the layer-3 channel. After receiving a synchronization message, a device checks whether the domain ID is consistent with its local domain ID. If yes, the two devices pair with each other successfully.

2. Master/slave negotiation

After successful pairing, the devices elect the master and slave roles based on their priority. The device with a higher priority is elected as the master device. If they share the same priority, the device with a smaller MAC address is elected as the master device.

i When both the master and slave devices work properly, packet forwarding is not different on them but different in failure scenarios. For example, when the peer-link is faulty, the VAP between the two devices fails. To avoid abnormal forwarding of traffic from access devices, the system shuts down service ports on the slave device and switches traffic to the master device.

3. Forwarding entry synchronization

After successful VAP negotiation, the two devices synchronize forwarding entries mutually such as MAC entries and ARP entries, to ensure active-active forwarding.

4. Dual-active detection

After the VAP runs properly, heartbeat packets are sent periodically between the two devices to detect the availability of the dual-active link. When the dual-active link is detected to be faulty, if the peer-link works properly, a prompt is displayed, reminding users to check the dual-active link.

When the peer-link is faulty, the devices send dual-active detection packets to each other:

- If a device receives a detection response packet, dual master devices exist, and service interfaces (interfaces other than MGMT ports, peer-link interfaces, and stacked interfaces) on the slave device will be forced to enter error down state. To prevent an interface from entering error down state, you can configure it as an exceptional interface, for example, the interface for dual-active detection.
- If no detection response packet is received, the peer device is faulty.
 - If the local device is the slave device, it becomes the master device.
 - If the local device is the master device, it does not take any actions.

12.3.2 Preferential Local Forwarding

The peer-link can be understood as a backup link. When the network is stable and free of failures, service traffic is preferentially forwarded through the VAP local member interface. It should not be forwarded through the peer-link unless it is broadcast traffic. When the local member interface fails, service traffic needs to be forwarded through the peer-link. See the figure below.

Figure 12-4 Forwarding by the VAP Local Member Interface

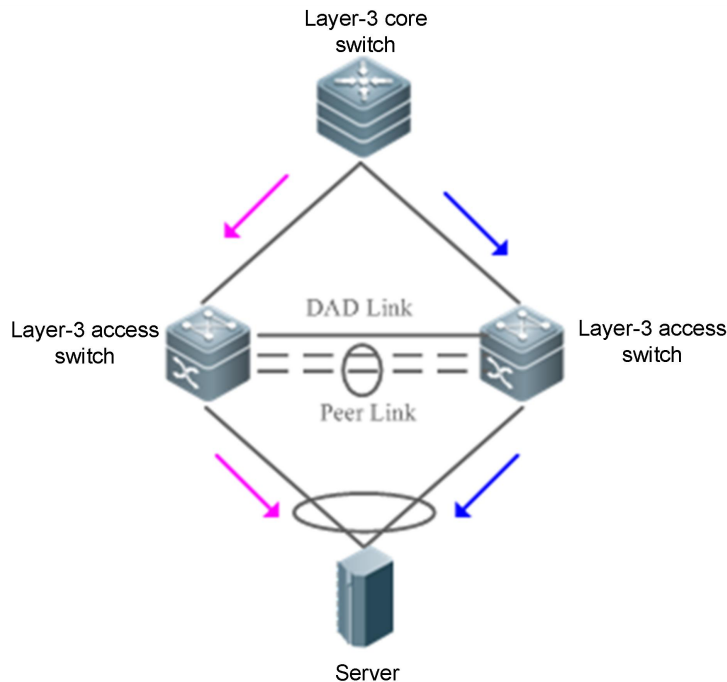
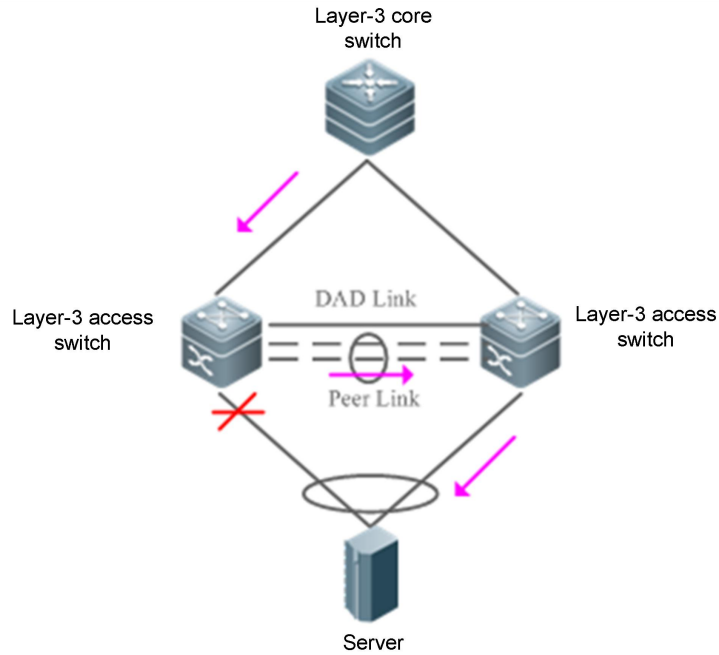

Figure 12-5 Failure of the VAP Local Member Interface



12.3.3 Anti-Loop Mechanism

When an access device connects to a network through VAP in dual-homing mode, the two APs of the VAP are distributed on two independent devices, and independent forwarding by the two APs may result in a loop or receiving of double packets. VAP anti-loop rules are configured as follows:

1. When the VAP remote member interface works properly, traffic from the peer-link is not forwarded to the local member interface. See the figure below.

Figure 12-6 Peer-link Traffic Loop Prevention

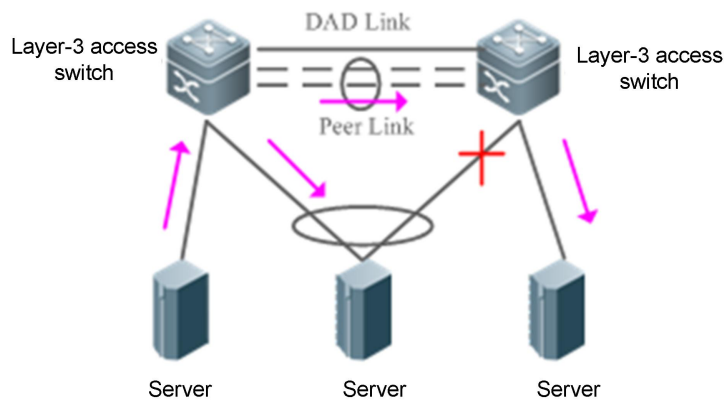

2. When the VAP remote member interface fails, traffic from the peer-link needs to be forwarded to the local member interface. See the figure below.

Figure 12-7 Peer-link Traffic Loop Release

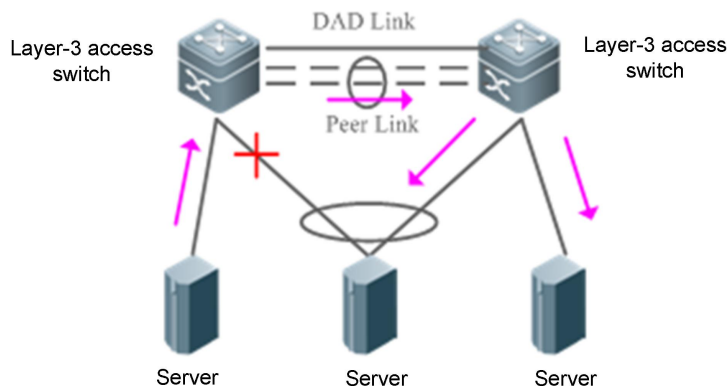

12.4 Configuration

Configuration	Description and Command	
Configuring Basic Functions of VAP	Mandatory:	
	vap domain	Configures a VAP domain.
	peer-link	Configures the peer-link.
	vap	Adds an AP to the VAP.
	data-sync	Configures a data synchronization channel.
	Optional:	
	Priority	Configures the priority.
Configuring Dual-Active Detection	Mandatory:	
	peer-keepalive	Configures a heartbeat link.
	Optional:	
	peer-keepalive hold-time	Configures the heartbeat holding time.
	dual-active auto recovery	Configures dual-active automatic recovery.
	vap error-down except	Configures an error down exceptional interface.
	recover up-delay	Configures the interface recovery delay.
Configuring the Domain Matching Delay	Optional:	
	domain-match delay	Configures the domain matching delay.
Configuring Convergence	Optional:	
	fast-convergence	Configures fast convergence.

12.4.1 Connecting to an IP Network in Dual-Homing Mode

Configuration Effect

- Two devices pair with each other to form a VAP system. The links of access devices are aggregated and connected to the VAP system in dual-homing mode.

- Traffic from VAP devices to access devices is first forwarded through the local VAP interface. When the local VAP interface fails, the traffic is forwarded to the VAP peer device.
- The server is connected to two independent network devices in dual-homing mode to form an active-active forwarding system. If a device malfunctions, user services can be still forwarded normally.

Notes

- The server is connected to the network in dual-homing mode and interfaces on the two devices need to be added to the same VAP.
- It is recommended that the peer-link between the two devices be configured to allow all VLAN traffic to pass.
- You are advised to configure multiple physical links for the peer-link. For chassis devices, you should deploy physical links on different boards to avoid the impact of a board failure on the network.

Configuration Steps

▾ **Configuring a VAP Domain**

- Mandatory.
- Perform the configuration on both network devices that provide dual-homing access.

Command	vap domain <i>domain-id</i>
Parameter	<i>domain-id</i> : Indicates the domain ID. The value ranges from 1 to 255.
Description	
Defaults	No domain ID is configured by default.
Command Mode	Global configuration mode
Usage Guide	Only one domain ID can be configured on one device. VAP negotiation succeeds only when domain IDs on two devices are the same.

▾ **Configuring the Peer-link**

- Mandatory.

Command	peer-link
Parameter	N/A
Description	
Defaults	An AP is not the peer-link by default.
Command Mode	Interface configuration mode
Usage Guide	When all member ports composing an AP of a VAP fail, traffic will be switched to the peer-link. When the remote member interface of a VAP works properly, traffic from the peer-link is not forwarded through the local member interface, in an effort to prevent loops. When the remote member interface of the VAP fails, traffic from the peer-link needs to be forwarded through the local member interface.

▾ **Adding an AP to the VAP**

- Mandatory.
- One AP can be added to only one VAP and different APs on the same device must be added to different VAPs.

Command	vap <i>vap-id</i>
Parameter	<i>vap-id</i> : Indicates the ID of a VAP. The value ranges from 1 to 65,535.

Description	
Defaults	An AP is not added to a VAP by default.
Command Mode	Interface configuration mode
Usage Guide	The two APs on the two network devices that provide dual-homing access must be added to the same VAP.

▾ Configuring a Data Synchronization Channel

- Mandatory.

Command	data-sync local { <i>ip-address</i> <i>ipv6-address</i> } peer { <i>ip-address</i> <i>ipv6-address</i> }
Parameter Description	local { <i>ip-address</i> <i>ipv6-address</i> }: Indicates the local IP address. peer { <i>ip-address</i> <i>ipv6-address</i> }: Indicates the peer IP address.
Defaults	No data synchronization channel is configured by default.
Command Mode	VAP domain configuration mode
Usage Guide	Data is synchronized between VAP devices through a layer-3 IP network and this configuration is required on each VAP device. Either IPv4 or IPv6 addresses can be configured.

▾ Configuring a Heartbeat Link

- Mandatory.

Command	peer-keepalive local { <i>ip-address</i> <i>ipv6-address</i> } peer { <i>ip-address</i> <i>ipv6-address</i> } [<i>interface-type interface-number</i>]
Parameter Description	<i>ip-address</i> : Indicates the IPv4 address used for heartbeat detection. <i>ipv6-address</i> : Indicates the IPv6 address used for heartbeat detection. <i>interface-type</i> : Indicates the interface type. Only MGMT interfaces are supported. <i>interface-number</i> : Indicates the interface number. All MGMT interfaces are supported.
Defaults	No heartbeat link is configured by default.
Command Mode	VAP domain configuration mode
Usage Guide	When the peer-link fails but the heartbeat link is normal, interfaces other than the MGMT interface, heartbeat interface, peer-link interface, and stacked interface on the slave device are triggered to enter the error down state. The interfaces return to the normal state after the peer-link is restored. Either IPv4 or IPv6 addresses can be configured.

▾ Configuring the Priority

- Optional.

Command	priority <i>priority</i>
Parameter Description	<i>priority</i> : Indicates the priority.
Defaults	The default priority is 4.
Command Mode	VAP domain configuration mode
Usage Guide	VAP devices negotiate to determine their master/slave state after establishing communication. The master/slave negotiation rules are as follows:

	<ol style="list-style-type: none"> 1) The device with a higher priority is elected as the master device. 2) If the devices share the same priority, the device with a smaller MAC address is elected as the master device.
--	--

➤ **Configuring the Heartbeat Holding Time**

● Optional.

Command	peer-keepalive hold-time <i>interval</i>
Parameter	<i>interval</i> : Indicates the heartbeat holding time.
Description	
Defaults	The default heartbeat holding time is 3s.
Command	VAP domain configuration mode
Mode	
Usage Guide	After the peer-link fails, the heartbeat link is retained for a period of time by default. After the time expires, if the heartbeat link is still normal, service interfaces on the slave device will enter error down state.

➤ **Configuring the Interface Recovery Delay**

● Optional.

Command	recover up-delay <i>interval</i> [none-vap <i>none-vap-interval</i>]
Parameter	<i>interval</i> : Indicates recovery delay of VAP interfaces, in seconds. The value ranges from 0 to 3,600.
Description	<i>none-vap-interval</i> : Indicates the recovery delay of non-VAP interfaces, in seconds. The value ranges from 0 to 3,600.
Defaults	The default recovery delay of VAP interfaces is 120s. There is no delay in the recovery of non-VAP interfaces by default.
Command	VAP configuration mode
Mode	
Usage Guide	When the peer-link failure is rectified and devices are restarted, VAP interfaces are restored with a delay of 120s while non-VAP interfaces are restored without delay.

➤ **Configuring an Exceptional Port for Dual-Active Detection**

● Optional.

Command	vap error-down except
Parameter	N/A
Description	
Defaults	No exceptional port for dual-active detection is configured by default.
Command	Interface configuration mode
Mode	
Usage Guide	After the VAP detects the dual-active mode, it brings physical ports on the slave device to the error down state. To prevent an interface from entering error down state, you can run this command to configure it as an exceptional port. Within the interface recovery delay, physical ports are still in error down state.

➤ **Configuring Fast Convergence Mode**

● Optional.

Command	fast-convergence
Parameter	N/A
Description	

Defaults	Fast convergence is enabled by default.
Command	VAP configuration mode
Mode	
Usage Guide	After fast convergence is configured, the VAP fault convergence time is minimized. However, there may be considerable packets instantaneously, for example, flooding may occur.

➤ **Configuring Dual-Active Automatic Recovery**

- Optional.

Command	dual-active auto recovery
Parameter	N/A
Description	
Defaults	Dual-active automatic recovery is not configured by default.
Command	VAP configuration mode
Mode	
Usage Guide	<p>When the dual-active mode is detected, interfaces on the slave device are shut down. If dual-active automatic recovery is enabled, after the master device malfunctions, service interfaces on the slave device are restored.</p> <p>When the MGMT port is configured to detect the dual-active mode, dual-active automatic recovery is enabled automatically. When a service interface is configured to detect the dual-active mode, dual-active automatic recovery is disabled by default. You can determine whether to enable this function based on the deployment scenario:</p> <ol style="list-style-type: none"> 1) When the dual-active detection port is a port that directly connects two devices, configure the directly connected port as an exceptional port for dual-active detection (by running the vap dad-down except command), and then enable dual-active automatic recovery. 2) If the dual-active detection port is not a directly connected port of two devices (for example, uplink port), dual-active automatic recovery cannot be enabled. Otherwise, repeated flapping will occur during dual-active detection.

Verification

- Run the **show vap [id]** command to display the two APs in the VAP. One is the local AP and the other is the remote AP.

Command	show vap [id]
Parameter	Indicates the ID of a VAP. The value ranges from 1 to 65,535.
Description	
Command	Privileged EXEC mode, global configuration mode, and interface configuration mode
Mode	
Usage Guide	This command is used to display information about a VAP.
Command Presentation	<pre> FS#show vap Vap domain: 245, Dev id: 2 Vap groups: 1 Vap 2 Local AggregatePort 2 is UP TenGigabitEthernet 0/21 is UP </pre>

Remote AggregatePort 2 is UP
 TenGigabitEthernet 1/0/21 is UP

i For details about fields shown by the **show** command, see the command manual of the corresponding feature.

Configuration Example

Connecting to an IP Network in Dual-Homing Mode

Scenario

Figure 12-8

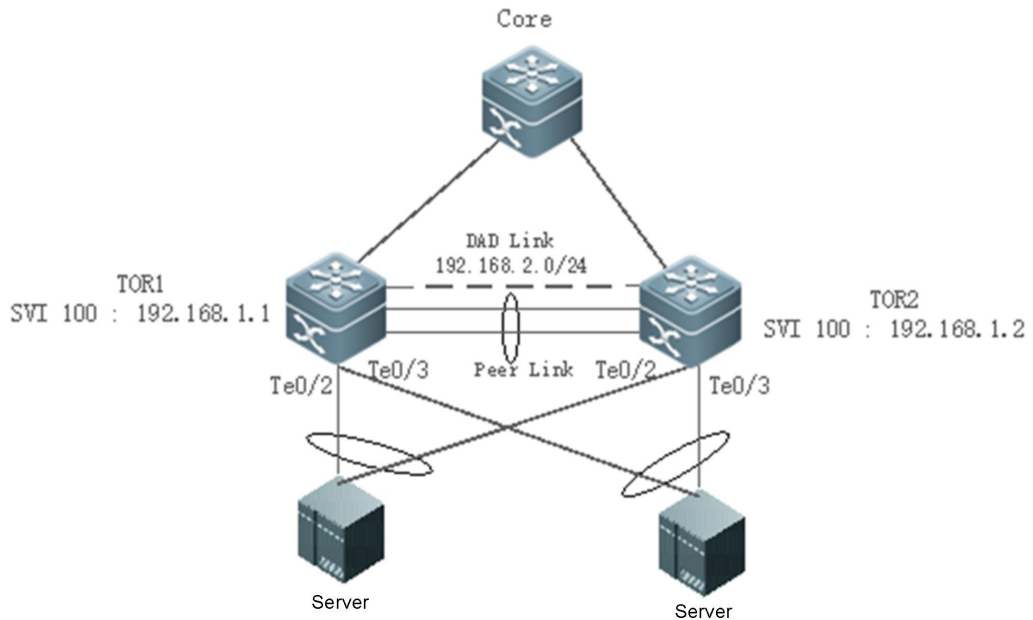

Configuration Steps

- Configure interface IP addresses for all devices (omitted).
- Configure a dynamic routing protocol (such as OSPF) on TOR1, TOR2, and core switch (omitted).
- Configure a VAP on TOR1 and TOR2.

TOR1

```

T1# configure terminal

Configure a layer-3 IP address for VAP data synchronization and a heartbeat layer-3 IP address.

T1(config)# int vlan 100
T1(config-if-VLAN 100)# ip address 192.168.1.1/24
T1(config-if-VLAN 100)# exit

T1(config)# int mgmt 0
T1(config-if-Mgmt 0)# ip address 192.168.2.1/24
T1(config-if-Mgmt 0)# exit

Configure a VAP domain, data synchronization channel, and heartbeat channel.

T1(config)# vap domain 1
T1(config-vap)# data-sync local 192.168.1.1 peer 192.168.1.2
T1(config-vap)# peer-keepalive local 192.168.2.1 peer 192.168.2.2 mgmt 0
T1(config-vap)# exit
    
```

Configure physical member ports for peer-link APs.

```
T1(config)# interface TenGigabitEthernet 0/4
T1(config-if-TenGigabitEthernet 0/4)# port-group 1
T1(config-if-TenGigabitEthernet 0/4)# exit
T1(config)# interface TenGigabitEthernet 0/5
T1(config-if-TenGigabitEthernet 0/5)# port-group 1
T1(config-if-TenGigabitEthernet 0/5)# exit
```

Configure the peer-link.

```
T1(config)# interface AggregatePort 1
T1(config-if-AggregatePort 1)# switchport mode trunk
T1(config-if-AggregatePort 1)# switchport tr allowed vlan all
T1(config-if-AggregatePort 1)# peer-link
T1(config-if-AggregatePort 1)# exit
```

Add downlink interface Te0/2 to AP2 and AP2 to VAP2.

```
T1(config)# interface TenGigabitEthernet 0/2
T1(config-if-TenGigabitEthernet 0/2)# port-group 2
T1(config-if-TenGigabitEthernet 0/2)# exit
T1(config)# interface AggregatePort 2
T1(config-if-AggregatePort 2)# switchport access vlan 2
T1(config-if-AggregatePort 2)# vap 2
T1(config-if-AggregatePort 2)# exit
```

Add downlink interface Te0/3 to AP3 and AP3 to VAP3.

```
T1(config)# interface TenGigabitEthernet 0/3
T1(config-if-TenGigabitEthernet 0/3)# port-group 3
T1(config-if-TenGigabitEthernet 0/3)# exit
T1(config)# interface AggregatePort 3
T1(config-if-AggregatePort 3)# switchport access vlan 3
T1(config-if-AggregatePort 3)# vap 3
T1(config-if-AggregatePort 3)# exit
```

Configure a VRRP active-active gateway.

```
T1(config)# vlan 2
T1(config-vlan)# exit
T1(config)# interface vlan 2
T1(config-if-VLAN 2)# ip address 30.30.2.1/24
```

	<pre> T1(config-if-VLAN 2)# vrrp 1 ip 30.30.2.1 T1(config-if-VLAN 2)# vrrp mode dual-active T1(config-if-VLAN 2)# exit T1(config)# vlan 3 T1(config-vlan)# exit T1(config)# interface vlan 3 T1(config-if-VLAN 2)# ip address 30.30.3.1/24 T1(config-if-VLAN 2)# vrrp 1 ip 30.30.3.1 T1(config-if-VLAN 2)# vrrp mode dual-active T1(config-if-VLAN 2)# exit Configure a Monito Link, with the uplink interface of Te 0/1 and downlink interfaces of Te 0/2 and Te 0/3. T1(config)# link state track 1 up-delay 60 T1(config)# interface TenGigabitEthernet 0/1 T1(config-if-TenGigabitEthernet 0/1)# link state group 1 upstream T1(config-if-TenGigabitEthernet 0/1)# exit T1(config)# interface TenGigabitEthernet 0/2 T1(config-if-TenGigabitEthernet 0/2)# link state group 1 downstream T1(config-if-TenGigabitEthernet 0/2)# exit T1(config)# interface TenGigabitEthernet 0/3 T1(config-if-TenGigabitEthernet 0/3)# link state group 1 downstream T1(config-if-TenGigabitEthernet 0/3)# exit </pre>
TOR-2	<pre> T2# configure terminal Configure a layer-3 IP address for VAP data synchronization and a heartbeat layer-3 IP address. T2(config)# int vlan 100 T2(config-if-VLAN 100)# ip address 192.168.1.2/24 T2(config-if-VLAN 100)# exit T2(config)# int mgmt 0 T2(config-if-Mgmt 0)# ip address 192.168.2.2/24 T2(config-if-Mgmt 0)# exit Configure a VAP data synchronization channel and heartbeat channel. T2(config)# vap domain 1 T2(config-vap)# data-sync local 192.168.1.2 peer 192.168.1.1 T2(config-vap)# peer-keepalive local 192.168.2.2 peer 192.168.2.1 mgmt 0 T2(config-vap)# exit </pre>

Configure physical member ports for peer-link APs.

```
T2(config)# interface TenGigabitEthernet 0/4
```

```
T2(config-if-TenGigabitEthernet 0/4)# port-group 1
```

```
T2(config-if-TenGigabitEthernet 0/4)# exit
```

```
T2(config)# interface TenGigabitEthernet 0/5
```

```
T2(config-if-TenGigabitEthernet 0/5)# port-group 1
```

```
T2(config-if-TenGigabitEthernet 0/5)# exit
```

Configure the peer-link.

```
T2(config)# interface AggregatePort 1
```

```
T2(config-if-AggregatePort 1)# switchport mode trunk
```

```
T2(config-if-AggregatePort 1)# switchport tr allowed vlan all
```

```
T2(config-if-AggregatePort 1)# peer-link
```

```
T2(config-if-AggregatePort 1)# exit
```

Add downlink interface Te0/2 to AP2 and AP2 to VAP2.

```
T2(config)# interface TenGigabitEthernet 0/2
```

```
T2(config-if-TenGigabitEthernet 0/2)# port-group 2
```

```
T2(config-if-TenGigabitEthernet 0/2)# exit
```

```
T2(config)# interface AggregatePort 2
```

```
T2(config-if-AggregatePort 2)# switchport access vlan 2
```

```
T2(config-if-AggregatePort 2)# vap 2
```

```
T2(config-if-AggregatePort 2)# exit
```

Add downlink interface Te0/3 to AP3 and AP3 to VAP3.

```
T2(config)# interface TenGigabitEthernet 0/3
```

```
T2(config-if-TenGigabitEthernet 0/3)# port-group 3
```

```
T2(config-if-TenGigabitEthernet 0/3)# exit
```

```
T2(config)# interface AggregatePort 3
```

```
T2(config-if-AggregatePort 3)# switchport access vlan 3
```

```
T2(config-if-AggregatePort 3)# vap 3
```

```
T2(config-if-AggregatePort 3)# exit
```

Configure a VRRP active-active gateway.

```
T2(config)# vlan 2
```

```
T2(config-vlan)# exit
```

```
T2(config)# interface vlan 2
```

```
T2(config-if-VLAN 2)# ip address 30.30.2.2/24
```

	<pre> T2(config-if-VLAN 2)# vrrp 1 ip 30.30.2.1 T2(config-if-VLAN 2)# vrrp mode dual-active T2(config-if-VLAN 2)# exit T2(config)# vlan 3 T2(config-vlan)# exit T2(config)# interface vlan 3 T2(config-if-VLAN 2)# ip address 30.30.3.2/24 T2(config-if-VLAN 2)# vrrp 1 ip 30.30.3.1 T2(config-if-VLAN 2)# vrrp mode dual-active T2(config-if-VLAN 2)# exit Configure a Monito Link, with the uplink interface of Te 0/1 and downlink interfaces of Te 0/2 and Te 0/3. T2(config)# link state track 1 up-delay 60 T2(config)# interface TenGigabitEthernet 0/1 T2(config-if-TenGigabitEthernet 0/1)# link state group 1 upstream T2(config-if-TenGigabitEthernet 0/1)# exit T2(config)# interface TenGigabitEthernet 0/2 T2(config-if-TenGigabitEthernet 0/2)# link state group 1 downstream T2(config-if-TenGigabitEthernet 0/2)# exit T2(config)# interface TenGigabitEthernet 0/3 T2(config-if-TenGigabitEthernet 0/3)# link state group 1 downstream T2(config-if-TenGigabitEthernet 0/3)# exit </pre>
Verification	Run the show vap command to display the two APs in the same VAP. The APs should be in the normal state.
T1	<pre> T1# show vap Vap domain: 1, Dev id: 1 Vap groups: 2 Vap 2 Local AggregatePort 2 is UP TenGigabitEthernet 0/2 is UP Remote AggregatePort 2 is UP TenGigabitEthernet 0/2 is UP Vap 3 Local AggregatePort 3 is UP </pre>

	<pre>TenGigabitEthernet 0/3 is UP Remote AggregatePort 3 is UP TenGigabitEthernet 0/3 is UP</pre>
<p>T2</p>	<pre>T2# show vap Vap domain: 1, Dev id: 2 Vap groups: 2 Vap 2 Local AggregatePort 2 is UP TenGigabitEthernet 0/2 is UP Remote AggregatePort 2 is UP TenGigabitEthernet 0/2 is UP Vap 3 Local AggregatePort 3 is UP TenGigabitEthernet 0/3 is UP Remote AggregatePort 3 is UP TenGigabitEthernet 0/3 is UP</pre>

Common Errors

N/A

12.4.2 Connecting to a Centralized VXLAN Network in Dual-Homing Mode

Configuration Effect

- Two devices pair with each other to form a VAP system. The links of access devices are aggregated and connected to the VAP system in dual-homing mode.
- Traffic from VAP devices to access devices is first forwarded through the local VAP interface. When the local VAP interface fails, the traffic is forwarded to the VAP peer device.
- Configure a centralized VXLAN, connect a server to a TOR switch, and configure the TOR switch to connect to the VXLAN active-active gateways in dual-homing mode. If one VXLAN gateway malfunctions, user services can be still forwarded normally.

Notes

- The TOR switch is connected to core switches in dual-homing mode and APs on the two core switches need to be added to the same VAP.
- It is recommended that the peer-link between the two devices be configured as a trunk link to allow all VLAN traffic to pass.

- You are advised to configure multiple physical links for the peer-link. For chassis devices, you should deploy physical links on different boards to avoid the impact of a board failure on the network.

Configuration Steps

▾ **Configuring a VAP Domain**

- Mandatory.
- Perform the configuration on both network devices that provide dual-homing access.

Command	vap domain <i>domain-id</i>
Parameter Description	<i>domain-id</i> : Indicates the domain ID. The value ranges from 1 to 255.
Defaults	No domain ID is configured by default.
Command Mode	Global configuration mode
Usage Guide	Only one domain ID can be configured on one device. VAP negotiation succeeds only when domain IDs on two devices are the same.

▾ **Configuring the Peer-link**

- Mandatory.

Command	peer-link
Parameter Description	N/A
Defaults	An AP is not the peer-link by default.
Command Mode	Interface configuration mode
Usage Guide	When all member ports composing an AP of a VAP fail, traffic will be switched to the peer-link. When the remote member interface of a VAP works properly, traffic from the peer-link is not forwarded through the local member interface, in an effort to prevent loops. When the remote member interface of the VAP fails, traffic from the peer-link needs to be forwarded through the local member interface.

▾ **Adding an AP to the VAP**

- Mandatory.
- One AP can be added to only one VAP and different APs on the same device must be added to different VAPs.

Command	vap <i>vap-id</i>
Parameter Description	<i>vap-id</i> : Indicates the ID of a VAP. The value ranges from 1 to 65,535.
Defaults	An AP is not added to a VAP by default.
Command Mode	Interface configuration mode
Usage Guide	The two APs on the two network devices that provide dual-homing access must be added to the same VAP.

▾ **Configuring a Data Synchronization Channel**

- Mandatory.

Command	data-sync local { <i>ip-address</i> <i>ipv6-address</i> } peer { <i>ip-address</i> <i>ipv6-address</i> }
Parameter	local { <i>ip-address</i> <i>ipv6-address</i> }; Indicates the local IP address.
Description	peer { <i>ip-address</i> <i>ipv6-address</i> }; Indicates the peer IP address.
Defaults	No data synchronization channel is configured by default.
Command Mode	VAP domain configuration mode
Usage Guide	Data is synchronized between VAP devices through a layer-3 IP network and this configuration is required on each VAP device. Either IPv4 or IPv6 addresses can be configured.

➤ **Configuring a Heartbeat Link**

- Mandatory.

Command	peer-keepalive local { <i>ip-address</i> <i>ipv6-address</i> } peer { <i>ip-address</i> <i>ipv6-address</i> } [<i>interface-type interface-number</i>]
Parameter	<i>ip-address</i> : Indicates the IPv4 address used for heartbeat detection.
Description	<i>ipv6-address</i> : Indicates the IPv6 address used for heartbeat detection. <i>interface-type</i> : Indicates the interface type. Only MGMT interfaces are supported. <i>interface-number</i> : Indicates the interface number. All MGMT interfaces are supported.
Defaults	No heartbeat link is configured by default.
Command Mode	VAP domain configuration mode
Usage Guide	When the peer-link fails but the heartbeat link is normal, interfaces other than the MGMT interface, heartbeat interface, peer-link interface, and stacked interface on the slave device are triggered to enter the error down state. The interfaces return to the normal state after the peer-link is restored. Either IPv4 or IPv6 addresses can be configured.

➤ **Configuring the Priority**

- Optional.

Command	priority <i>priority</i>
Parameter	<i>priority</i> : Indicates the priority.
Description	
Defaults	The default priority is 4.
Command Mode	VAP domain configuration mode
Usage Guide	VAP devices negotiate to determine their master/slave state after establishing communication. The master/slave negotiation rules are as follows: 3) The device with a higher priority is elected as the master device. 4) If the devices share the same priority, the device with a smaller MAC address is elected as the master device.

➤ **Configuring the Heartbeat Holding Time**

- Optional.

Command	peer-keepalive hold-time <i>interval</i>
Parameter	<i>interval</i> : Indicates the heartbeat holding time.
Description	

Defaults	The default heartbeat holding time is 3s.
Command	VAP domain configuration mode
Mode	
Usage Guide	After the peer-link fails, the heartbeat link is retained for a period of time by default. After the time expires, if the heartbeat link is still normal, service interfaces on the slave device will enter error down state.

↘ Configuring the Interface Recovery Delay

- Optional.

Command	recover up-delay <i>interval</i> [none-vap <i>none-vap-interva</i>]
Parameter	<i>interval</i> : Indicates recovery delay of VAP interfaces, in seconds. The value ranges from 0 to 3,600.
Description	<i>none-vap-interval</i> : Indicates the recovery delay of non-VAP interfaces, in seconds. The value ranges from 0 to 3,600.
Defaults	The default recovery delay of VAP interfaces is 120s. There is no delay in the recovery of non-VAP interfaces by default.
Command	VAP configuration mode
Mode	
Usage Guide	When the peer-link failure is rectified and devices are restarted, VAP interfaces are restored with a delay of 120s while non-VAP interfaces are restored without delay.

↘ Configuring an Exceptional Port for Dual-Active Detection

- Optional.

Command	vap error-down except
Parameter	N/A
Description	
Defaults	No exceptional port for dual-active detection is configured by default.
Command	Interface configuration mode
Mode	
Usage Guide	After the VAP detects the dual-active mode, it brings physical ports on the slave device to the error down state. To prevent an interface from entering error down state, you can run this command to configure it as an exceptional port. Within the interface recovery delay, physical ports are still in error down state.

↘ Configuring Fast Convergence Mode

- Optional.

Command	fast-convergence
Parameter	N/A
Description	
Defaults	Fast convergence is enabled by default.
Command	VAP configuration mode
Mode	
Usage Guide	After fast convergence is configured, the VAP fault convergence time is minimized. However, there may be considerable packets instantaneously, for example, flooding may occur.

↘ Configuring Dual-Active Automatic Recovery

- Optional.

Command	dual-active auto recovery
Parameter	N/A
Description	
Defaults	Dual-master automatic recovery is not configured by default.
Command Mode	VAP configuration mode
Usage Guide	<p>When the dual-active mode is detected, interfaces on the slave device are shut down. If dual-active automatic recovery is enabled, after the master device malfunctions, service interfaces on the slave device are restored.</p> <p>When the MGMT port is configured to detect the dual-active mode, dual-active automatic recovery is enabled automatically. When a service interface is configured to detect the dual-active mode, dual-active automatic recovery is disabled by default. You can determine whether to enable this function based on the deployment scenario:</p> <ol style="list-style-type: none"> 1) When the dual-active detection port is a port that directly connects two devices, configure the directly connected port as an exceptional port for dual-active detection (by running the vap dad-down except command), and then enable dual-active automatic recovery. 2) If the dual-active detection port is not a directly connected port of two devices (for example, uplink port), dual-active automatic recovery cannot be enabled. Otherwise, repeated flapping will occur during dual-active detection.

Verification

- Run the **show vap [id]** command to display the two APs in the VAP. One is the local AP and the other is the remote AP.

Command	show vap [id]
Parameter Description	Indicates the ID of a VAP. The value ranges from 1 to 65,535.
Command Mode	Privileged EXEC mode, global configuration mode, and interface configuration mode
Usage Guide	This command is used to display information about a VAP.
Command Presentation	<pre> FS#show vap Vap domain: 245, Dev id: 2 Vap groups: 1 Vap 2 Local AggregatePort 2 is UP TenGigabitEthernet 0/21 is UP Remote AggregatePort 2 is UP TenGigabitEthernet 1/0/21 is UP </pre>

For details about fields shown by the **show** command, see the command manual of the corresponding feature.

Configuration Example

Connecting to a Centralized VXLAN Network in Dual-Homing Mode

Scenario

Figure 12-9

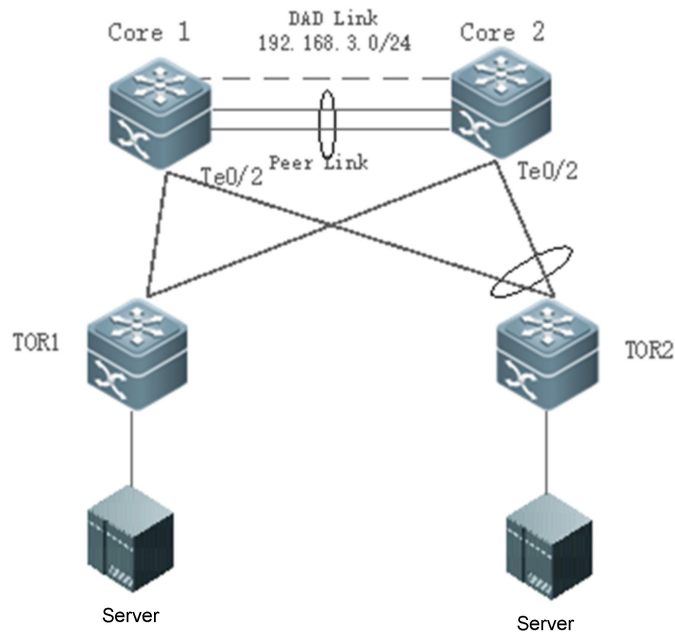

Configuration Steps

- Configure interface IP addresses for all devices (omitted).
- Configure a centralized EVPN VXLAN on TOR1, Core1, and Core2 (omitted).
- Configure an AP on TOR2 and configure TOR2 to connect to Core1 and Core2 in dual-homing mode (omitted).
- Configure a VAP on Core1 and Core2.

Core1

```

Core1# configure terminal

Configure a layer-3 IP address for VAP data synchronization and a heartbeat layer-3 IP address.

Core1(config)# int vlan 100
Core1(config-if-VLAN 100)# ip address 192.168.1.1/24
Core1(config-if-VLAN 100)# exit

Core1(config)# int mgmt 0
Core1(config-if-Mgmt 0)# ip address 192.168.2.1/24
Core1(config-if-Mgmt 0)# exit

Configure a VAP domain, data synchronization channel, and heartbeat detection channel.

Core1(config)# vap domain 1
Core1(config-vap)# data-sync local 192.168.1.1 peer 192.168.1.2
Core1(config-vap)# peer-keepalive local 192.168.2.1 peer 192.168.2.2 mgmt 0
Core1(config-vap)# exit

Configure physical member ports for peer-link APs.

Core1(config)# interface TenGigabitEthernet 0/4
Core1(config-if-TenGigabitEthernet 0/4)# port-group 1
Core1(config-if-TenGigabitEthernet 0/4)# exit
    
```

	<pre>Core1(config)# interface TenGigabitEthernet 0/5 Core1(config-if-TenGigabitEthernet 0/5)# port-group 1 Core1(config-if-TenGigabitEthernet 0/5)# exit Configure the peer-link. Core1(config)# interface AggregatePort 1 Core1(config-if-AggregatePort 1)# switchport mode trunk Core1(config-if-AggregatePort 1)# switchport tr allowed vlan all Core1(config-if-AggregatePort 1)# peer-link Core1(config-if-AggregatePort 1)# exit Add downlink interface Te0/2 to AP2 and AP2 to VAP2. Core1(config)# interface TenGigabitEthernet 0/2 Core1(config-if-TenGigabitEthernet 0/2)# port-group 2 Core1(config-if-TenGigabitEthernet 0/2)# exit Core1(config)# interface AggregatePort 2 Core1(config-if-AggregatePort 2)# switchport access vlan 2 Core1(config-if-AggregatePort 2)# vap 2 Core1(config-if-AggregatePort 2)# exit Configure an overlay router active-active gateway. Core1(config)# interface OverlayRouter 10 Core1(config-if-OverlayRouter 10)# ip address 30.30.2.1/24 Core1(config-if-OverlayRouter 10)# anycast-gateway Core1(config-if-OverlayRouter 10)# exit</pre>
Core2	<pre>Core2# configure terminal Configure a layer-3 IP address for VAP data synchronization and a heartbeat IP address. Core2(config)# int vlan 100 Core2(config-if-VLAN 100)# ip address 192.168.1.2/24 Core2(config-if-VLAN 100)# exit Core2(config)# int mgmt 0 Core2(config-if-Mgmt 0)# ip address 192.168.2.2/24 Core2(config-if-Mgmt 0)# exit Configure a VAP data synchronization channel and heartbeat detection channel. Core2(config)# vap domain 1 Core2(config-vap)# data-sync local 192.168.1.2 peer 192.168.1.1 Core2(config-vap)# peer-keepalive local 192.168.2.2 peer 192.168.2.1 mgmt 0</pre>

	<pre> Core2(config-vap)# exit Configure physical member ports for peer-link APs. Core2(config)# interface TenGigabitEthernet 0/4 Core2(config-if-TenGigabitEthernet 0/4)# port-group 1 Core2(config-if-TenGigabitEthernet 0/4)# exit Core2(config)# interface TenGigabitEthernet 0/5 Core2(config-if-TenGigabitEthernet 0/5)# port-group 1 Core2(config-if-TenGigabitEthernet 0/5)# exit Configure the peer-link. Core2(config)# interface AggregatePort 1 Core2(config-if-AggregatePort 1)# switchport mode trunk Core2(config-if-AggregatePort 1)# switchport tr allowed vlan all Core2(config-if-AggregatePort 1)# peer-link Core2(config-if-AggregatePort 1)# exit Add downlink interface Te0/2 to AP2 and AP2 to VAP2. Core2(config)# interface TenGigabitEthernet 0/2 Core2(config-if-TenGigabitEthernet 0/2)# port-group 2 Core2(config-if-TenGigabitEthernet 0/2)# exit Core2(config)# interface AggregatePort 2 Core2(config-if-AggregatePort 2)# switchport access vlan 2 Core2(config-if-AggregatePort 2)# vap 2 Core2(config-if-AggregatePort 2)# exit Configure an overlay router active-active gateway. Core2(config)# interface OverlayRouter 10 Core2(config-if-OverlayRouter 10)# ip address 30.30.2.1/24 Core2(config-if-OverlayRouter 10)# anycast-gateway Core2(config-if-OverlayRouter 10)# exit </pre>
Verification	Run the show vap command to display the two APs in the same VAP. The APs should be in the normal state.
Core1	<pre> Core1# show vap Vap domain: 1, Dev id: 1 Vap groups: 2 Vap 2 Local AggregatePort 2 is UP </pre>

	<pre>TenGigabitEthernet 0/2 is UP Remote AggregatePort 2 is UP TenGigabitEthernet 0/2 is UP</pre>
Core2	<pre>Core2# show vap Vap domain: 1, Dev id: 2 Vap groups: 2 Vap 2 Local AggregatePort 2 is UP TenGigabitEthernet 0/2 is UP Remote AggregatePort 2 is UP TenGigabitEthernet 0/2 is UP</pre>

Common Errors

N/A

12.4.3 Connecting to a Distributed VXLAN Network in Dual-Homing Mode

Configuration Effect

- Two devices pair with each other to form a VAP system. The links of access devices are aggregated and connected to the VAP system in dual-homing mode.
- Traffic from VAP devices to access devices is first forwarded through the local VAP interface. When the local VAP interface fails, the traffic is forwarded to the VAP peer device.
- Configure a distributed VXLAN and configure a server to connect to the VXLAN active-active gateways in dual-homing mode. If one VXLAN gateway malfunctions, user services can be still forwarded normally.

Notes

- The server is connected to the network in dual-homing mode and interfaces on the two TOR devices need to be added to the same VAP.
- It is recommended that the peer-link between the two devices be configured as a trunk link to allow all VLAN traffic to pass.
- You are advised to configure multiple physical links for the peer-link. For chassis devices, you should deploy physical links on different boards to avoid the impact of a board failure on the network.

Configuration Steps

➤ **Configuring a VAP Domain**

- Mandatory.
- Perform the configuration on both network devices that provide dual-homing access.

Command	<code>vap domain domain-id</code>
----------------	-----------------------------------

Parameter Description	<i>domain-id</i> : Indicates the domain ID. The value ranges from 1 to 255.
Defaults	No domain ID is configured by default.
Command Mode	Global configuration mode
Usage Guide	Only one domain ID can be configured on one device. VAP negotiation succeeds only when domain IDs on two devices are the same.

▾ **Configuring the Peer-link**

- Mandatory.

Command	peer-link
Parameter Description	N/A
Defaults	An AP is not the peer-link by default.
Command Mode	Interface configuration mode
Usage Guide	When all member ports composing an AP of a VAP fail, traffic will be switched to the peer-link. When the remote member interface of a VAP works properly, traffic from the peer-link is not forwarded through the local member interface, in an effort to prevent loops. When the remote member interface of the VAP fails, traffic from the peer-link needs to be forwarded through the local member interface.

▾ **Adding an AP to the VAP**

- Mandatory.
- One AP can be added to only one VAP and different APs on the same device must be added to different VAPs.

Command	vap <i>vap-id</i>
Parameter Description	<i>vap-id</i> : Indicates the ID of a VAP. The value ranges from 1 to 65,535.
Defaults	An AP is not added to a VAP by default.
Command Mode	Interface configuration mode
Usage Guide	The two APs on the two network devices that provide dual-homing access must be added to the same VAP.

▾ **Configuring a Data Synchronization Channel**

- Mandatory.

Command	data-sync local { <i>ip-address</i> <i>ipv6-address</i> } peer { <i>ip-address</i> <i>ipv6-address</i> }
Parameter Description	local { <i>ip-address</i> <i>ipv6-address</i> }: Indicates the local IP address. peer { <i>ip-address</i> <i>ipv6-address</i> }: Indicates the peer IP address.
Defaults	No data synchronization channel is configured by default.
Command Mode	VAP domain configuration mode
Usage Guide	Data is synchronized between VAP devices through a layer-3 IP network and this configuration is required on each VAP device.

	Either IPv4 or IPv6 addresses can be configured.
--	--

➤ **Configuring a Heartbeat Link**

- Mandatory.

Command	peer-keepalive local { <i>ip-address</i> <i>ipv6-address</i> } peer { <i>ip-address</i> <i>ipv6-address</i> } [<i>interface-type interface-number</i>]
Parameter Description	<i>ip-address</i> : Indicates the IPv4 address used for heartbeat detection. <i>ipv6-address</i> : Indicates the IPv6 address used for heartbeat detection. <i>interface-type</i> : Indicates the interface type. Only MGMT interfaces are supported. <i>interface-number</i> : Indicates the interface number. All MGMT interfaces are supported.
Defaults	No heartbeat link is configured by default.
Command Mode	VAP domain configuration mode
Usage Guide	When the peer-link fails but the heartbeat link is normal, interfaces other than the MGMT interface, heartbeat interface, peer-link interface, and stacked interface on the slave device are triggered to enter the error down state. The interfaces return to the normal state after the peer-link is restored. Either IPv4 or IPv6 addresses can be configured.

➤ **Configuring the Priority**

- Optional.

Command	priority <i>priority</i>
Parameter Description	<i>priority</i> : Indicates the priority.
Defaults	The default priority is 4.
Command Mode	VAP domain configuration mode
Usage Guide	VAP devices negotiate to determine their master/slave state after establishing communication. The master/slave negotiation rules are as follows: 1) The device with a higher priority is elected as the master device. 2) If the devices share the same priority, the device with a smaller MAC address is elected as the master device.

➤ **Configuring the Heartbeat Holding Time**

- Optional.

Command	peer-keepalive hold-time <i>interval</i>
Parameter Description	<i>interval</i> : Indicates the heartbeat holding time.
Defaults	The default heartbeat holding time is 3s.
Command Mode	VAP domain configuration mode
Usage Guide	After the peer-link fails, the heartbeat link is retained for a period of time by default. After the time expires, if the heartbeat link is still normal, service interfaces on the slave device will enter error down state.

➤ **Configuring the Interface Recovery Delay**

- Optional.

Command	recover up-delay <i>interval</i> [none-vap <i>none-vap-interval</i>]
Parameter	<i>interval</i> : Indicates recovery delay of VAP interfaces, in seconds. The value ranges from 0 to 3,600.
Description	<i>none-vap-interval</i> : Indicates the recovery delay of non-VAP interfaces, in seconds. The value ranges from 0 to 3,600.
Defaults	The default recovery delay of VAP interfaces is 120s. There is no delay in the recovery of non-VAP interfaces by default.
Command Mode	VAP configuration mode
Usage Guide	When the peer-link failure is rectified and devices are restarted, VAP interfaces are restored with a delay of 120s while non-VAP interfaces are restored without delay.

↘ Configuring an Exceptional Port for Dual-Active Detection

- Optional.

Command	vap error-down except
Parameter	N/A
Description	
Defaults	No exceptional port for dual-active detection is configured by default.
Command Mode	Interface configuration mode
Usage Guide	After the VAP detects the dual-active mode, it brings physical ports on the slave device to the error down state. To prevent an interface from entering error down state, you can run this command to configure it as an exceptional port. Within the interface recovery delay, physical ports are still in error down state.

↘ Configuring Fast Convergence Mode

- Optional.

Command	fast-convergence
Parameter	N/A
Description	
Defaults	Fast convergence is enabled by default.
Command Mode	VAP configuration mode
Usage Guide	After fast convergence is configured, the VAP fault convergence time is minimized. However, there may be considerable packets instantaneously, for example, flooding may occur.

↘ Configuring Dual-Active Automatic Recovery

- Optional.

Command	dual-active auto recovery
Parameter	N/A
Description	
Defaults	Dual-active automatic recovery is not configured by default.
Command Mode	VAP configuration mode
Usage Guide	When the dual-active mode is detected, interfaces on the slave device are shut down. If dual-active automatic recovery is enabled, after the master device malfunctions, service interfaces on the slave device are restored.

	<p>When the MGMT port is configured to detect the dual-active mode, dual-active automatic recovery is enabled automatically. When a service interface is configured to detect the dual-active mode, dual-active automatic recovery is disabled by default. You can determine whether to enable this function based on the deployment scenario:</p> <ol style="list-style-type: none"> 1) When the dual-active detection port is a port that directly connects two devices, configure the directly connected port as an exceptional port for dual-active detection (by running the vap dad-down except command), and then enable dual-active automatic recovery. 2) If the dual-active detection port is not a directly connected port of two devices (for example, uplink port), dual-active automatic recovery cannot be enabled. Otherwise, repeated flapping will occur during dual-active detection.
--	---

Verification

- Run the **show vap [id]** command to display the two APs in the VAP. One is the local AP and the other is the remote AP.

Command	show vap [id]
Parameter Description	Indicates the ID of a VAP. The value ranges from 1 to 65,535.
Command Mode	Privileged EXEC mode, global configuration mode, and interface configuration mode
Usage Guide	This command is used to display information about a VAP.
Command Presentation	<pre> FS#show vap Vap domain: 245, Dev id: 2 Vap groups: 1 Vap 2 Local AggregatePort 2 is UP TenGigabitEthernet 0/21 is UP Remote AggregatePort 2 is UP TenGigabitEthernet 1/0/21 is UP </pre>

For details about fields shown by the **show** command, see the command manual of the corresponding feature.

Configuration Example

↘ Connecting to a Distributed VXLAN Network in Dual-Homing Mode

<p>Scenario Figure 12-10</p>	
<p>Configuration Steps</p>	<ul style="list-style-type: none"> ● Configure interface IP addresses for all devices (omitted). ● Configure a dynamic routing protocol (such as OSPF) on TOR1, TOR2, TOR3, Core1, and Core2 (omitted). ● Configure a distributed VXLAN on TOR1, TOR2, TOR3, Core1, and Core2, and configure the same VTEP IP address for TOR2 and TOR3 (omitted). ● Configure a VAP on TOR1 and TOR2.
<p>TOR1</p>	<pre> T1# configure terminal Configure a layer-3 IP address for VAP data synchronization and a heartbeat IP address. T1(config)# int vlan 100 T1(config-if-VLAN 100)# ip address 192.168.1.1/24 T1(config-if-VLAN 100)# exit T1(config)# int mgmt 0 T1(config-if-Mgmt 0)# ip address 192.168.2.1/24 T1(config-if-Mgmt 0)# exit Configure a VAP domain, data synchronization channel, and heartbeat detection channel. T1(config)# vap domain 1 T1(config-vap)# data-sync local 192.168.1.1 peer 192.168.1.2 T1(config-vap)# peer-keepalive local 192.168.2.1 peer 192.168.2.2 mgmt 0 T1(config-vap)# exit Configure physical member ports for peer-link APs. T1(config)# interface TenGigabitEthernet 0/4 T1(config-if-TenGigabitEthernet 0/4)# port-group 1 </pre>

	<pre> T1(config-if-TenGigabitEthernet 0/4)# exit T1(config)# interface TenGigabitEthernet 0/5 T1(config-if-TenGigabitEthernet 0/5)# port-group 1 T1(config-if-TenGigabitEthernet 0/5)# exit Configure the peer-link. T1(config)# interface AggregatePort 1 T1(config-if-AggregatePort 1)# switchport mode trunk T1(config-if-AggregatePort 1)# switchport tr allowed vlan all T1(config-if-AggregatePort 1)# peer-link T1(config-if-AggregatePort 1)# exit Add downlink interface Te0/2 to AP2 and AP2 to VAP2. T1(config)# interface TenGigabitEthernet 0/2 T1(config-if-TenGigabitEthernet 0/2)# port-group 2 T1(config-if-TenGigabitEthernet 0/2)# exit T1(config)# interface AggregatePort 2 T1(config-if-AggregatePort 2)# switchport access vlan 2 T1(config-if-AggregatePort 2)# vap 2 T1(config-if-AggregatePort 2)# exit Add downlink interface Te0/3 to AP3 and AP3 to VAP3. T1(config)# interface TenGigabitEthernet 0/3 T1(config-if-TenGigabitEthernet 0/3)# port-group 3 T1(config-if-TenGigabitEthernet 0/3)# exit T1(config)# interface AggregatePort 3 T1(config-if-AggregatePort 3)# switchport access vlan 3 T1(config-if-AggregatePort 3)# vap 3 T1(config-if-AggregatePort 3)# exit Configure an overlay router active-active gateway. T1(config)# interface OverlayRouter 10 T1(config-if-OverlayRouter 10)# ip address 30.30.2.1/24 T1(config-if-OverlayRouter 10)# anycast-gateway T1(config-if-OverlayRouter 10)# exit </pre>
<p>TOR-2</p>	<pre> T2# configure terminal Configure a layer-3 IP address for VAP data synchronization and a heartbeat IP address. T2(config)# int vlan 100 </pre>

```
T2(config-if-VLAN 100)# ip address 192.168.1.2/24
T2(config-if-VLAN 100)# exit
T2(config)# int mgmt 0
T2(config-if-Mgmt 0)# ip address 192.168.2.2/24
T2(config-if-Mgmt 0)# exit
Configure a VAP data synchronization channel and heartbeat detection channel.
T2(config)# vap domain 1
T2(config-vap)# data-sync local 192.168.1.2 peer 192.168.1.1
T2(config-vap)# peer-keepalive local 192.168.2.2 peer 192.168.2.1 mgmt 0
T2(config-vap)# exit
Configure physical member ports for peer-link APs.
T2(config)# interface TenGigabitEthernet 0/4
T2(config-if-TenGigabitEthernet 0/4)# port-group 1
T2(config-if-TenGigabitEthernet 0/4)# exit
T2(config)# interface TenGigabitEthernet 0/5
T2(config-if-TenGigabitEthernet 0/5)# port-group 1
T2(config-if-TenGigabitEthernet 0/5)# exit
Configure the peer-link.
T2(config)# interface AggregatePort 1
T2(config-if-AggregatePort 1)# switchport mode trunk
T2(config-if-AggregatePort 1)# switchport tr allowed vlan all
T2(config-if-AggregatePort 1)# peer-link
T2(config-if-AggregatePort 1)# exit
Add downlink interface Te0/2 to AP2 and AP2 to VAP2.
T2(config)# interface TenGigabitEthernet 0/2
T2(config-if-TenGigabitEthernet 0/2)# port-group 2
T2(config-if-TenGigabitEthernet 0/2)# exit
T2(config)# interface AggregatePort 2
T2(config-if-AggregatePort 2)# switchport access vlan 2
T2(config-if-AggregatePort 2)# vap 2
T2(config-if-AggregatePort 2)# exit
Add downlink interface Te0/3 to AP3 and AP3 to VAP3.
T2(config)# interface TenGigabitEthernet 0/3
T2(config-if-TenGigabitEthernet 0/3)# port-group 3
```

	<pre>T2(config-if-TenGigabitEthernet 0/3)# exit T2(config)# interface AggregatePort 3 T2(config-if-AggregatePort 3)# switchport access vlan 3 T2(config-if-AggregatePort 3)# vap 3 T2(config-if-AggregatePort 3)# exit Configure an overlay router active-active gateway. T2(config)# interface OverlayRouter 10 T2(config-if-OverlayRouter 10)# ip address 30.30.2.1/24 T2(config-if-OverlayRouter 10)# anycast-gateway T2(config-if-OverlayRouter 10)# exit</pre>
Verification	Run the show vap command to display the two APs in the same VAP. The APs should be in the normal state.
T1	<pre>T1# show vap Vap domain: 1, Dev id: 1 Vap groups: 2 Vap 2 Local AggregatePort 2 is UP TenGigabitEthernet 0/2 is UP Remote AggregatePort 2 is UP TenGigabitEthernet 0/2 is UP</pre>
T2	<pre>T2# show vap Vap domain: 1, Dev id: 2 Vap groups: 2 Vap 2 Local AggregatePort 2 is UP TenGigabitEthernet 0/2 is UP Remote AggregatePort 2 is UP TenGigabitEthernet 0/2 is UP</pre>

Common Errors

N/A

12.5 Monitoring

Clearing

N/A

Displaying

Description	Command
Displays information about a VAP.	show vap [id]
Displays information about the peer-link.	show vap peer-link
Displays information about the peer of a data channel.	show vap data-sync
Displays information about the heartbeat channel.	show vap keepalive
Displays MAC entry information.	show vap mac
Displays VXLAN MAC entry information.	show vap xmac
Displays a list of error down interfaces and a list of exceptional interfaces.	show vap error-down

Debugging



System resources are occupied when debugging information is output. Therefore, disable the debugging switch immediately after use.

Description	Command
Debugs the VAP function globally.	debug vap all
Debugs VAP events.	debug vap event
Debugs VAP interfaces.	debug vap lsm
Debugs VAP packet receiving.	debug vap recv
Debugs VAP packet transmission.	debug vap send
Debugs keepalive packets of the VAP.	debug vap hello
Debugs hot backup information about the VAP.	debug vap rdnd
Debugs VAP bridge information.	debug vap bridge
Debugs dual-active detection of the VAP.	debug vap dad
Debugs MAC information of the VAP.	debug vap mac
Debugs VXLAN MAC information of the VAP.	debug vap xmac
Debugs the VAP test.	debug vap test
Debugs the NETCONF of VAP.	debug vap netconf

Network Management & Monitoring Configuration

1. Configuring SNMP
2. Configuring RMON
3. Configuring NTP
4. Configuring SNTP
5. Configuring SPAN-RSPAN
6. Configuring ERSPAN
7. Configuring sFlow
8. Configuring NETCONF
9. Configuring gRPC
10. Configuring IFA and PSR
11. Configuring IPFIX

1 Configuring SNMP

1.1 Overview

Simple Network Management Protocol (SNMP) became a network management standard RFC1157 in August 1988. At present, because many vendors support SNMP, SNMP has in fact become a network management standard and is applicable to the environment where systems of multiple vendors are interconnected. By using SNMP, the network administrator can implement basic functions such as information query for network nodes, network configuration, fault locating, capacity planning, and network monitoring and management.

📄 SNMP Versions

Currently, the following SNMP versions are supported:

- SNMPv1: The first official version of SNMP, which is defined in RFC1157.
- SNMPv2C: Community-based SNMPv2 management architecture, which is defined in RFC1901.
- SNMPv3: SNMPv3 provides the following security features by identifying and encrypting data.
 7. Ensuring that data is not tampered during transmission.
 8. Ensuring that data is transmitted from legal data sources.
 9. Encrypting packets and ensuring data confidentiality.

Protocols and Standards

- RFC 1157, Simple Network Management Protocol (SNMP)
- RFC 1901, Introduction to Community-based SNMPv2
- RFC 2578, Structure of Management Information Version 2 (SMIv2)
- RFC 2579, Textual Conventions for SMIv2
- RFC 3411, An Architecture for Describing Simple Network Management Protocol (SNMP) Management Frameworks
- RFC 3412, Message Processing and Dispatching for the Simple Network Management Protocol (SNMP)
- RFC 3413, Simple Network Management Protocol (SNMP) Applications
- RFC 3414, User-based Security Model (USM) for version 3 of the Simple Network Management Protocol (SNMPv3)
- RFC 3415, View-based Access Control Model (VACM) for the Simple Network Management Protocol (SNMP)
- RFC 3416, Version 2 of the Protocol Operations for the Simple Network Management Protocol (SNMP)
- RFC 3417, Transport Mappings for the Simple Network Management Protocol (SNMP)
- RFC 3418, Management Information Base (MIB) for the Simple Network Management Protocol (SNMP)
- RFC 3419, Textual Conventions for Transport Addresses

1.2 Applications

Application	Description
Managing Network Devices Based on SNMP	Network devices are managed and monitored based on SNMP.

1.2.1 Managing Network Devices Based on SNMP

Scenario

Take the following figure as an example. Network device A is managed and monitored based on SNMP network manager.

Figure 1- 1



Remarks	A is a network device that needs to be managed. PC is a network management station.
----------------	--

Deployment

The network management station is connected to the managed network devices. On the network management station, users access the Management Information Base (MIB) on the network devices through the SNMP network manager and receive messages actively sent by the network devices to manage and monitor the network devices.

1.3 Features

Basic Concepts

SNMP is an application layer protocol that works in C/S mode. It consists of three parts:

- SNMP network manager
- SNMP agent
- MIB

Figure 1- 2 shows the relationship between the network management system (NMS) and the network management agent.

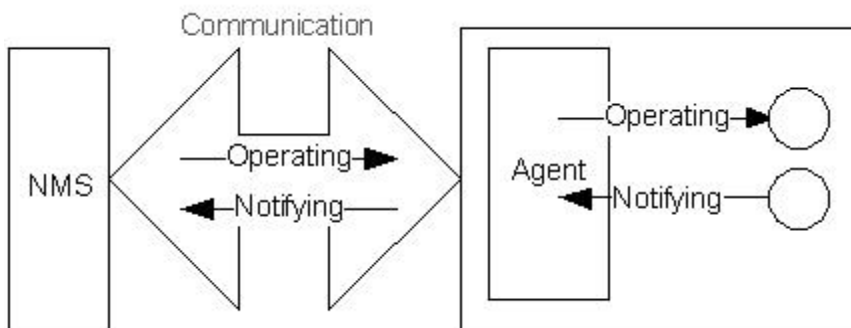

➤ SNMP Network Manager

The SNMP network manager is a system that controls and monitors the network based on SNMP and is also called the NMS.

➤ SNMP Agent

The SNMP agent (hereinafter referred to as the agent) is software running on the managed devices. It is responsible for receiving, processing, and responding to monitoring and control packets from the NMS. The agent may also actively send messages to the NMS.

➤ **MIB**

The MIB is a virtual network management information base. The managed network devices contain lots of information. To uniquely identify a specific management unit among SNMP packets, the MIB adopts the tree hierarchical structure. Nodes in the tree indicate specific management units. A string of digits may be used to uniquely identify a management unit system among network devices. The MIB is a collection of unit identifiers of network devices.

Figure 1- 3 Tree Hierarchical Structure

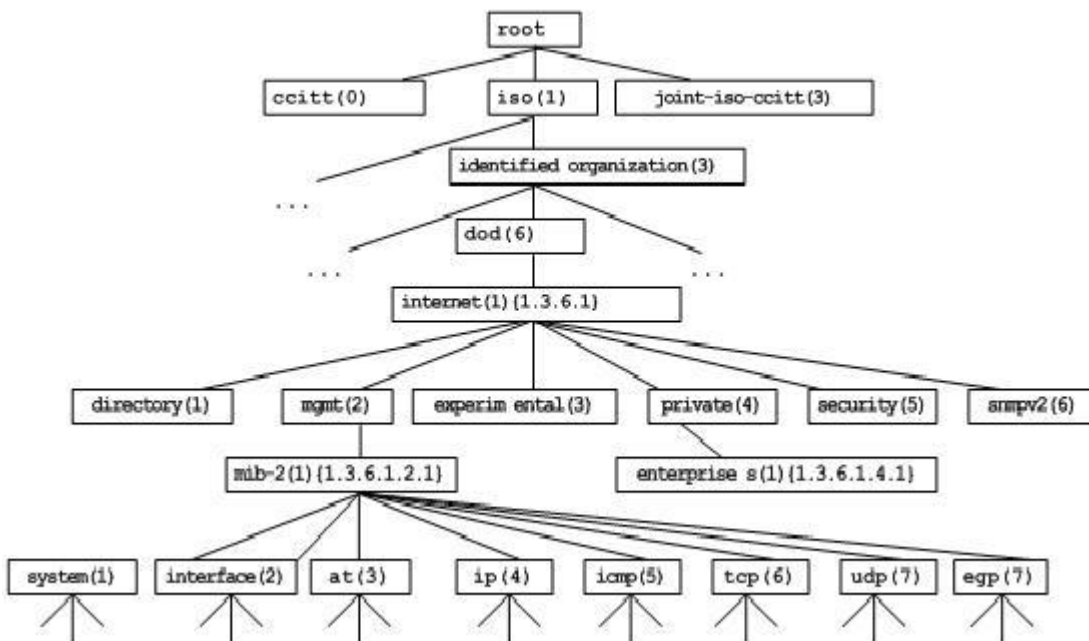

➤ **Operation Types**

Six operation types are defined for information exchange between the NMS and the agent based on SNMP:

- Get-request: The NMS extracts one or more parameter values from the agent.
- Get-next-request: The NMS extracts the parameter value next to one or more parameters from the agent.
- Get-bulk: The NMS extracts a batch of parameter values from the agent.
- Set-request: The NMS sets one or more parameter values of the agent.
- Get-response: The agent returns one or more parameter values, which are the operations in response to the three operations performed by the agent on the NMS.
- Trap: The agent actively sends a message to notify the NMS of something that happens.

The first four packets are sent by the NMS to the agent and the last two packets are sent by the agent to the NMS. (Note: SNMPv1 does not support the Get-bulk operation.) Figure 1- 4 describes the operations.

Figure 1- 4 SNMP Packet Types

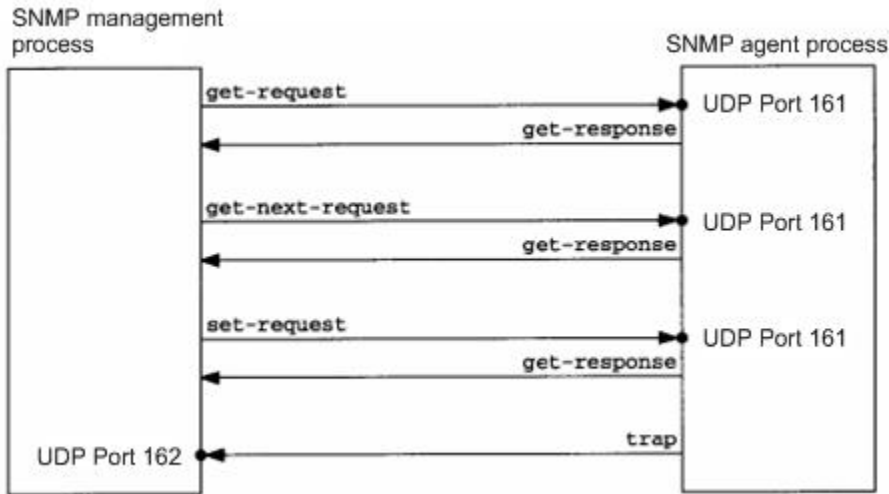

The three operations performed by the NMS on the agent and the response operations of the agent are based on UDP port 161. The trap operation performed by the agent is based on UDP port 162.

Overview

Feature	Description
<u>Basic SNMP Functions</u>	The SNMP agent is configured on network devices to implement basic functions such as information query for network nodes, network configuration, fault locating, and capacity planning.
<u>SNMPv1 and SNMPv2C</u>	SNMPv1 and SNMPv2C adopt the community-based security architecture, including authentication name and access permission.
<u>SNMPv3</u>	SNMPv3 redefines the SNMP architecture, namely, it enhances security functions, including the security model based on users and access control model based on views. The SNMPv3 architecture already includes all functions of SNMPv1 and SNMPv2C.

1.3.1 Basic SNMP Functions

Working Principle

📌 **Working Process**

SNMP protocol interaction is response interaction (for exchange of packets, see Figure 1-4). The NMS actively sends requests to the agent, including Get-request, Get-next-request, Get-bulk, and Set-request. The agent receives the requests, completes operations, and returns a Get-response. Sometimes, the agent actively sends a trap message and an Inform message to the NMS. The NMS does not need to respond to the trap message but needs to return an Inform-response to the agent. Otherwise, the agent re-sends the Inform message.

Related Configuration

📌 **Shielding or Disabling the SNMP Agent**

By default, the SNMP function is enabled.

The **no snmp-server** command is used to disable the SNMP agent.

The **no enable service snmp-agent** command is used to directly disable all SNMP services.

📌 Setting Basic SNMP Parameters

By default, the system contact mode, system location, and device Network Element (NE) information are empty. The default serial number is 60FF60, the default maximum packet length is 1,572 bytes, and the default UDP port ID of the SNMP service is 161.

The **snmp-server contact** command is used to configure or delete the system contact mode.

The **snmp-server location** command is used to configure or delete the system location.

The **snmp-server chassis-id** command is used to configure the system serial number or restore the default value.

The **snmp-server packet-size** command is used to configure the maximum packet length of the agent or restore the default value.

The **snmp-server net-id** command is used to configure or delete the device NE information.

The **snmp-server udp-port** command is used to set the UDP port ID of the SNMP service or restore the default value.

By default, SNMPv3 is enabled, while SNMP v1 and SNMPv2c are disabled.

The **no snmp-server enable version [v1 | v2c | v3]** command is used to disable a specified SNMP version.

📌 Configuring the SNMP Host Address

By default, no SNMP host is configured.

The **snmp-server host** command is used to configure the NMS host address to which the agent actively sends messages or to delete the specified SNMP host address. In the messages sent to the host, the SNMP version, receiving port, authentication name, or user can be bound. This command is used with the **snmp-server enable traps** command to actively send trap messages to the NMS.

📌 Setting Trap Message Parameters

By default, SNMP is not allowed to actively send a trap message to the NMS, the function of sending a Link Trap message on an interface is enabled, the function of sending a system reboot trap message is disabled, and a trap message does not carry any private field.

By default, the IP address of the interface where SNMP packets are sent is used as the source address.

By default, the length of a trap message queue is 10 and the interval for sending a trap message is 30s.

The **snmp-server enable traps** command is used to enable or disable the agent to actively send a trap message to the NMS.

The **snmp trap link-status** command is used to enable or disable the function of sending a Link Trap message on an interface.

The **snmp-server trap-source** command is used to specify the source address for sending messages or to restore the default value.

The **snmp-server queue-length** command is used to set the length of a trap message queue or to restore the default value.

The **snmp-server trap-timeout** command is used to set the interval for sending a trap message or to restore the default value.

The **snmp-server trap-format private** command is used to set or disable the function of carrying private fields in a trap message when the message is sent.

The **snmp-server system-shutdown** command is used to enable or disable the function of sending a system reboot trap message.

1.3.2SNMPv1 and SNMPv2C

SNMPv1 and SNMPv2C adopt the community-based security architecture. The administrator who can perform operations on the MIB of the agent is limited by defining the host address and authentication name (community string).

Working Principle

SNMPv1 and SNMPv2 determine whether the administrator has the right to use MIB objects by using the authentication name. The authentication name of the NMS must be the same as an authentication name defined in devices.

SNMPv2C adds the Get-bulk operation mechanism and can return more detailed error message types to the management workstation. The Get-bulk operation is performed to obtain all information from a table or obtain lots of data at a time, so as to reduce the number of request responses. The enhanced error handling capabilities of SNMPv2C include extension of error codes to differentiate error types. In SNMPv1, however, only one error code is provided for errors. Now, errors can be differentiated based on error codes. Because management workstations supporting SNMPv1 and SNMPv2C may exist on the network, the SNMP agent must be able to identify SNMPv1 and SNMPv2C packets and return packets of the corresponding versions.

📌 Security

One authentication name has the following attributes:

- Read-only: Provides the read permission of all MIB variables for authorized management workstations.
- Read-write: Provide the read/write permission of all MIB variables for authorized management workstations.

Related Configuration

📌 Setting Authentication Names and Access Permissions

The default access permission of all authentication names is read-only.

The **snmp-server community** command is used to configure or delete an authentication name and access permission.

This command is the first important command for enabling the SNMP agent function. It specifies community attributes and NMS scope where access to the MIB is allowed.

1.3.3SNMPv3

SNMPv3 redefines the SNMP architecture and includes functions of SNMPv1 and SNMPv2 into the SNMPv3 system.

Working Principle

The NMS and SNMP agent are SNMP entities. In the SNMPv3 architecture, SNMP entities consist of the SNMP engine and SNMP applications. The SNMP engine is used to send and receive messages, identify and encrypt information, and control access to managed objects. SNMP applications refer to internal applications of SNMP, which work by using the services provided by the SNMP engine.

SNMPv3v determines whether a user has the right to use MIB objects by using the User-based Security Model (USM). The security level of the NMS user must be the same as that of an SNMP user defined in devices so as to manage devices.

SNMPv3 requires the NMS to obtain the SNMP agent engine IDs on devices when the NMS manages devices. SNMPv3 defines the discover and report operation mechanisms. When the NMS does not know agent engine IDs, the NMS may first send a discover message to the agent and the agent returns a report message carrying an engine ID. Later, management operations between the NMS and the agent must carry the engine ID.

📌 Security

- SNMPv3 determines the data security mechanism based on the security model and security level. At present, security models include: SNMPv1, SNMPv2C, and SNMPv3. SNMPv3 includes SNMPv1 and SNMPv2C into the security model.

SNMPv1 and SNMPv2C Security Models and Security Levels

Security Model	Security Level	Authentication	Encryption	Description
SNMPv1	noAuthNoPriv	Authentication name	N/A	Data validity is confirmed through authentication name.
SNMPv2c	noAuthNoPriv	Authentication name	N/A	Data validity is confirmed through authentication name.

SNMPv3 Security Model and Security Level

Security Model	Security Level	Authentication	Encryption	Description
SNMPv3	noAuthNoPriv	User name.	N/A	Data validity is confirmed through user name.
SNMPv3	authNoPriv	MD5 or SHA	N/A	The data authentication mechanism based on HMAC-MD5 or HMAC-SHA is provided.
SNMPv3	authPriv	MD5 or SHA	DES	The data authentication mechanism based on HMAC-MD5 or HMAC-SHA and data encryption mechanism based on CBC-DES are provided.

📌 Engine ID

An engine ID is used to uniquely identify an SNMP engine. Because each SNMP entity includes only one SNMP engine, one SNMP engine uniquely identifies an SNMP entity in a management domain. Therefore, the SNMPv3 agent as an entity must have a unique engine ID, that is, SmpEngineID.

An engine ID is an octet string that consists of 5 to 32 bytes. RFC3411 defines the format of an engine ID:

- The first four bytes indicate the private enterprise ID (allocated by IANA) of a vendor, which is expressed in hexadecimal.
- The fifth byte indicates remaining bytes:
- 0: Reserved.
- 1: The later four bytes indicate an IPv4 address.
- 2: The later 16 bytes indicate an IPv6 address.
- 3: The later six bytes indicate a MAC address.
- 4: Text consisting of 27 bytes, which is defined by the vendor.
- 5: Hexadecimal value consisting of 27 bytes, which is defined by the vendor.
- 6-127: Reserved.
- 128-255: Formats specified by the vendor.

Related Configuration

📌 Configuring an MIB View and a Group

By default, one view is configured and all MIB objects can be accessed.

By default, no user group is configured.

The **snmp-server view** command is used to configure or delete a view and the **snmp-server group** command is used to configure or delete a user group.

One or more instructions can be configured to specify different community names so that network devices can be managed by NMSs of different permissions.

📌 **Configuring an SNMP User**



By default, no user is configured.

The **snmp-server user** command is used to configure or delete a user.

The NMS can communicate with the agent by using only legal users.

An SNMPv3 user can specify the security level (whether authentication and encryption are required), authentication algorithm (MD5 or SHA), authentication password, encryption password (only DES is available currently), and encryption password.

1.4 Configuration

Configuration	Description and Command	
<u>Configuring Basic SNMP Functions</u>	 (Mandatory) It is used to enable users to access the agent through the NMS.	
	enable service snmp-agent	Enables the agent function.
	snmp-server community	Sets an authentication name and access permission.
	snmp-server user	Configures an SNMP user.
	snmp-server view	Configures an SNMP view.
	snmp-server group	Configures an SNMP user group.
	snmp-server authentication	Configures the SNMP attack protection and detection function.
	snmp-server enable secret-dictionary-check	Configures password dictionary check for communities and users.
<u>Enabling the Trap Function</u>	 (Optional) It is used to enable the agent to actively send a trap message to the NMS.	
	snmp-server host	Configures the NMS host address.
	snmp-server enable traps	Enables the agent to actively send a trap message to the NMS.
	snmp trap link-status	Enables the function of sending a Link Trap message on an interface.
	snmp-server system-shutdown	Enables the function of sending a system reboot trap message.
	snmp-server trap-source	Specifies the source address for sending a trap message.
	snmp-server trap-format private	Enables a trap message to carry private fields when the message is sent.
<u>Shielding the Agent Function</u>	 (Optional) It is used to shield the agent function when the agent service is not required.	
	no snmp-server	Shields the agent function.

Configuration	Description and Command	
Setting SNMP Control Parameters	 (Optional) It is used to set or modify SNMP control parameters.	
	snmp-server contact	Sets the device contact mode.
	snmp-server location	Sets the device location.
	snmp-server chassis-id	Sets the serial number of the device.
	snmp-server net-id	Sets NE information about the device.
	snmp-server packetsize	Modifies the maximum packet length.
	snmp-server udp-port	Modifies the UDP port ID of the SNMP service.
	snmp-server queue-length	Modifies the length of a trap message queue.
	snmp-server trap-timeout	Modifies the interval for sending a trap message.
	no snmp-server enable version	Disables a specified SNMP version.

1.4.1 Configuring Basic SNMP Functions

Configuration Effect

Enable users to access the agent through the NMS.

Notes

- By default, no authentication name is set on network devices and SNMPv1 or SNMPv2C cannot be used to access the MIB of network devices. When an authentication name is set, if no access permission is specified, the default access permission is read-only.

Configuration Steps

▾ Configuring an SNMP View

- Optional
- An SNMP view needs to be configured when the View-based Access Control Model (VACM) is used.

▾ Configuring an SNMP User Group

- Optional
- An SNMP user group needs to be configured when the VACM is used.

▾ Configuring an Authentication Name and Access Permission

- Mandatory
- An authentication name must be set on the agent when SNMPv1 and SNMPv2C are used to manage network devices.

▾ Configuring an SNMP User

- Mandatory
- A user must be set when SNMPv3 is used to manage network devices.

▾ Enabling the Agent Function

- Optional

- By default, the agent function is enabled. When the agent function needs to be enabled again after it is disabled, this command must be used.

Verification

Run the **show snmp** command to check the SNMP function on devices.

Related Commands

↘ **Configuring an SNMP View**

Command	snmp-server view <i>view-name oid-tree</i> { include exclude }
Parameter	<i>view-name</i> : View name
Description	<i>oid-tree</i> : MIB objects associated with a view, which are displayed as an MIB subtree. include : Indicates that the MIB object subtree is included in the view. exclude : Indicates that the MIB object subtree is not included in the view.
Command Mode	Global configuration mode
Usage Guide	Specify a view name and use it for view-based management.

↘ **Configuring an SNMP User Group**

Command	snmp-server group <i>groupname</i> { v1 v2c v3 { auth noauth priv } } [read <i>readview</i>] [write <i>writeview</i>] [access { ipv6 <i>ipv6-aclname</i> <i>aclnum</i> <i>aclname</i> }]
Parameter	v1 v2c v3 : Specifies the SNMP version.
Description	auth : Messages sent by users in the group need to be verified but data confidentiality is not required. This configuration is valid for SNMPv3 only. noauth : Messages sent by users in the group do not need to be verified and data confidentiality is not required. This configuration is valid for SNMPv3 only. priv : Messages sent by users in the group need to be verified and confidentiality of transmitted data is required. This configuration is valid for SNMPv3 only. <i>readview</i> : Associates one read-only view. <i>writeview</i> : Associates one read/write view. <i>aclnum</i> : ACL number. The specified ACL is associated and the range of IPv4 NMS addresses from which access to the MIB is allowed is specified. <i>aclname</i> : ACL name. The specified ACL is associated and the range of IPv4 NMS addresses from which access to the MIB is allowed is specified. <i>ipv6-aclname</i> : IPv6 ACL name. The specified ACL is associated and the range of IPv6 NMS addresses from which access to the MIB is allowed is specified.
Command Mode	Global configuration mode
Usage Guide	Associate certain users with a group and associate the group with a view. Users in a group have the same access permission. In this way, you can determine whether managed objects associated with an operation are in the allowable range of a view. Only managed objects in the range of a view can be accessed.

↘ **Configuring an Authentication Name and Access Permission**

Command	snmp-server community [<i>0</i> <i>7</i>] <i>string</i> [view <i>view-name</i>] [[ro rw]] [host <i>ipaddr</i>] [ipv6 <i>ipv6-aclname</i>] [<i>aclnum</i>]
----------------	---

	<i>aclname</i>]
Parameter Description	<p>0: Indicates that the input community string is a plaintext string.</p> <p>7: Indicates that the input community string is a ciphertext string.</p> <p><i>string</i>: Community string, which is equivalent to the communication password between the NMS and the SNMP agent.</p> <p><i>view-name</i>: Specifies a view name for view-based management.</p> <p>ro: Indicates that the NMS can only read variables of the MIB.</p> <p>rw: The NMS can read and write variables of the MIB.</p> <p><i>aclnum</i>: ACL number. The specified ACL is associated and the range of IPv4 NMS addresses from which access to the MIB is allowed is specified.</p> <p><i>aclname</i>: ACL name. The specified ACL is associated and the range of IPv4 NMS addresses from which access to the MIB is allowed is specified.</p> <p><i>ipv6-aclname</i>: ACL name. The specified ACL is associated and the range of IPv6 NMS addresses from which access to the MIB is allowed is specified.</p> <p><i>ipaddr</i>: Associates NMS addresses and specifies NMS addresses for accessing the MIB.</p>
Command Mode	Global configuration mode
Usage Guide	<p>This command is the first important command for enabling the SNMP agent function. It specifies community attributes and NMS scope where access to the MIB is allowed.</p> <p>To disable the SNMP agent function, run the no snmp-server command.</p>

📌 **Configuring an SNMP User**

Command	snmp-server user <i>username</i> <i>groupname</i> { v1 v2c v3 [encrypted] [auth { md5 sha } <i>auth-password</i>] [priv des56 <i>priv-password</i>] } [access { ipv6 <i>ipv6-aclname</i> <i>aclnum</i> <i>aclname</i> }]
Parameter Description	<p><i>username</i>: User name.</p> <p><i>groupname</i>: Specifies the group name for a user.</p> <p>v1 v2c v3: Specifies the SNMP version. Only SNMPv3 supports later security parameters.</p> <p>encrypted: The specified password input mode is ciphertext input. Otherwise, plaintext is used for input. If ciphertext input is selected, enter a key consisting of continuous hexadecimal digits. An MD5 protocol authentication key consists of 16 bytes and an SHA authentication protocol key consists of 20 bytes. Two characters stand for one byte. Encrypted keys are valid for this engine only.</p> <p>auth: Specifies whether authentication is used.</p> <p>md5: Specifies the MD5 authentication protocol. sha specifies the SHA authentication protocol.</p> <p><i>auth-password</i>: Configures a password string (not more than 32 characters) used by the authentication protocol. The system converts the passwords into the corresponding authentication keys.</p> <p>priv: Specifies whether confidentiality is used. des56 specifies the use of the 56-bit DES encryption protocol.</p> <p><i>priv-password</i>: Configures a password string (not more than 32 characters) used for encryption. The system converts the password into the corresponding encryption key.</p> <p><i>aclnum</i>: ACL number. The specified ACL is associated and the range of IPv4 NMS addresses from which access to the MIB is allowed is specified.</p> <p><i>aclname</i>: ACL name. The specified ACL is associated and the range of IPv4 NMS addresses from which access to the MIB is allowed is specified.</p> <p><i>ipv6-aclname</i>: IPv6 ACL name. The specified ACL is associated and the range of IPv6 NMS addresses from which access to the MIB is allowed is specified.</p>

Command Mode	Global configuration mode
Usage Guide	Configure user information so that the NMS can communicate with the agent by using a valid user. For an SNMPv3 user, you can specify the security level, authentication algorithm (MD5 or SHA), authentication password, encryption algorithm (at present, only DES is available), and encryption password.

📌 **Enabling the Agent Function**

Command	enable service snmp-agent
Parameter Description	
Configuration mode	Privileged mode.
Usage Guide	This command is used to enable the SNMP agent function of a device.

📌 **Displaying the SNMP Status Information**

Command	show snmp [mib user view group host process-mib-time]
Parameter Description	mib: Displays information about the SNMP MIB supported in the system. user: Displays information about an SNMP user. view: Displays information about an SNMP view. group: Displays information about an SNMP user group. host: Displays information about user configuration. process-mib-time: Displays the MIB node with the longest processing time.
Configuration mode	Privileged mode.
Usage Guide	N/A

📌 **Configuration Example Configuring SNMP v1/2c**

Scenario Figure 1-5	<p>The diagram illustrates a network configuration where an Agent (switch) is connected to an NMS (server) through an Ethernet interface labeled Gi0/1. The Agent's IP address is 192.168.3.1/24, and the NMS's IP address is 192.168.3.2/24.</p> <ul style="list-style-type: none"> The NMS is connected to an agent through the Ethernet. The IP address of the agent is 192.168.3.1/24, and the IP address of the NMS is 192.168.3.2/24. The NMS monitors and manages the agent through SNMP v1 or SNMP v2c. When the agent is faulty or an error occurs, the agent can actively reports the related information to the NMS.
Configuration Steps	<ul style="list-style-type: none"> Configure the SNMP basic information, including the version and community name. Allow the NMS (192.168.3.2/24) to send Trap messages. Configure the IP address of the agent, and set the IP address of the Gi0/1 interface to 192.168.3.1/24.
Agent	FS(config)#snmp-server community public rw

	<pre>FS(config)#snmp-server host 192.168.3.2 traps version 2c public FS(config)#snmp-server enable traps FS(config)#interface gigabitEthernet 0/1 FS(config-if-gigabitEthernet 0/1)#ip address 192.168.3.1 255.255.255.0 FS(config-if-gigabitEthernet 0/1)#exit</pre>
Verification	<ul style="list-style-type: none"> ● Run the show running-config command to display configuration information of the device. ● Run the show snmp host command to display the host information configured by the user.
NMS	<p>On the NMS that uses the SNMP v1/v2c, configure the read/write community name, timeout time, and retry times. You can use the NMS to query and configure the device.</p> <p> Configurations on the NMS must be consistent with those on the device; otherwise, related operations cannot be performed.</p>

Configuring SNMP v3 (Default View)

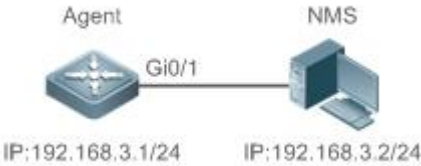
<p>Scenario Figure 1-6</p>	 <ul style="list-style-type: none"> ● The NMS manages network devices (agents) based on the user authentication and encryption mode, for example, the NMS uses user1 as the user name, MD5 as the authentication mode, 123 as the authentication password, DES56 as the encryption algorithm, and 321 as the encryption password. ● You can access all MIB nodes. ("read default write default" indicates that all MIB nodes can be accessed.) ● Network devices can actively send authentication and encryption messages to the NMS.
Configuration Steps	<ul style="list-style-type: none"> ● Configure an MIB group. Create a group "g1", select the version "v3", set the security level to the authentication and encryption mode "priv", and configure permissions to read and write the view "default". "Default" indicates that all MIB nodes can be accessed. ● Configure an SNMP user. Create a user named "user1" under group "g1", select "v3" as the version, and set the authentication mode to "md5", authentication password to "123", encryption mode to "DES56", and encryption password to "321". ● Configure the SNMP host address. Set the host address to 192.168.3.2, select "3" as the version, set the security level to the authentication and encryption mode "priv", and associate the user name "user1". Enable the agent to actively send a trap message to the NMS. ● Configure the IP address of the agent. Set the address of the Gi0/1 interface to 192.168.3.1/24.
Agent	<pre>FS(config)#snmp-server group g1 v3 priv read default write default FS(config)#snmp-server user user1 g1 v3 auth md5 123 priv des56 321 FS(config)#snmp-server host 192.168.3.2 traps version 3 priv user1 FS(config)#snmp-server enable traps</pre>

	<pre>FS(config)#interface gigabitEthernet 0/1 FS(config-if-gigabitEthernet 0/1)#ip address 192.168.3.1 255.255.255.0 FS(config-if-gigabitEthernet 0/1)#exit</pre>
Verification	<ul style="list-style-type: none"> ● Run the show running-config command to display configuration information of the device. ● Run the show snmp user command to display the SNMP user. ● Run the show snmp view command to display the SNMP view. ● Run the show snmp group command to display the SNMP group. ● Run the show snmp host command to display the host information configured by the user. ● Install MIB-Browser.
NMS	<p>SNMP v3 adopts the authentication and encryption security mechanisms. On the NMS, configure the user name, and select a security level. Based on the selected security level, configure the authentication mode, authentication password, encryption mode, and encryption password. In addition, configure the timeout time and retry times. You can use the NMS to query and configure the device. For details about the configuration, see Figure 1-7.</p> <p> Configurations on the NMS must be consistent with those on the device; otherwise, related operations cannot be performed.</p>

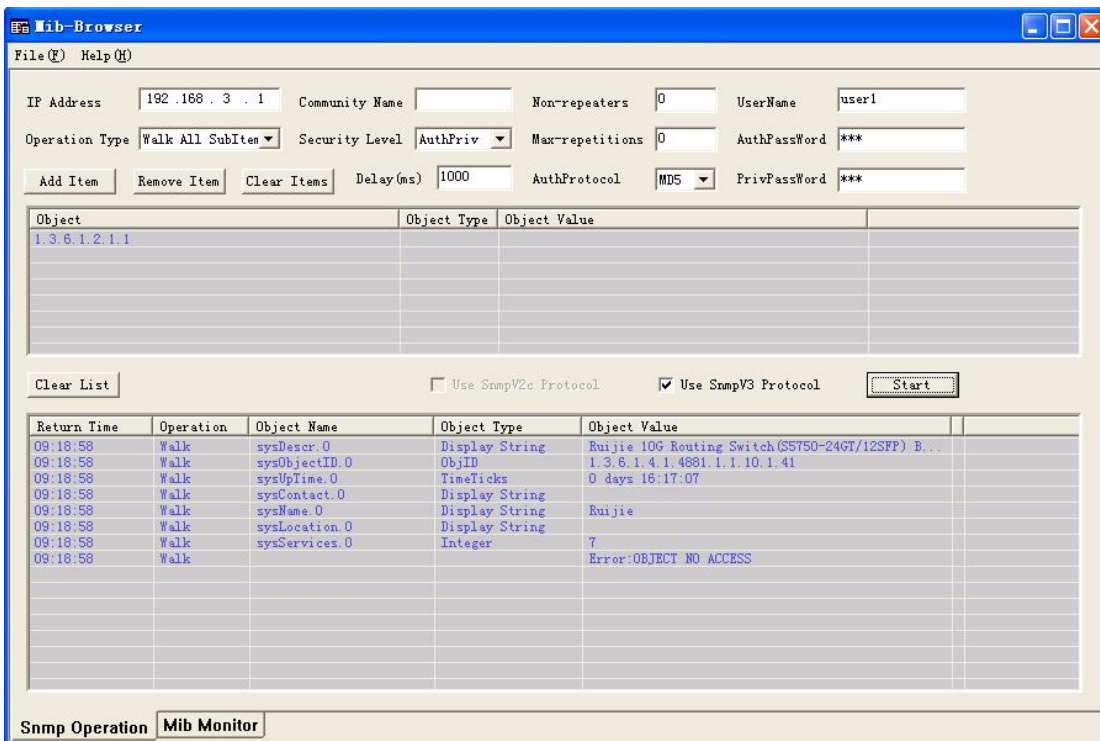

➤ **Configuring SNMPv3 Configuration (Specified View)**

<p>Scenario Figure 1-7</p>	<div style="text-align: center;"> </div> <ul style="list-style-type: none"> ● The NMS manages network devices (agents) based on the user authentication and encryption mode, for example, the NMS uses user1 as the user name, MD5 as the authentication mode, 123 as the authentication password, DES56 as the encryption algorithm, and 321 as the encryption password. ● Network devices can control the operation permission of users to access MIB objects. For example, the user named user1 can read MIB objects under the system node (1.3.6.1.2.1.1) and can only write MIB objects under the SysContact node (1.3.6.1.2.1.1.4.0). ● Network devices can actively send authentication and encryption messages to the NMS.
<p>Configuration Steps</p>	<ul style="list-style-type: none"> ● Configure a MIB view and a MIB group. Create a MIB view “view1”, which includes the associated MIB object (1.3.6.1.2.1.1); then create a MIB view “view2”, which includes the associated MIB object (1.3.6.1.2.1.1.4.0). Create a group “g1”, select the version “v3”, set the security level to the authentication and encryption mode “priv”, and configure permissions to read the view “view1” and write the view “view2”. ● Configure an SNMP user. Create a user named “user1” under group “g1”, select “v3” as the version, and set the authentication mode to “md5”, authentication password to “123”, encryption mode to “DES56”, and encryption password to “321”. ● Configure the SNMP host address. Set the host address to 192.168.3.2, select “3” as the version, set the security level to the authentication and encryption mode “priv”, and associate the user name “user1”. Enable the agent to actively send a trap message to the NMS. ● Set the IP address of the agent. Set the address of the Gi0/1 interface to 192.168.3.1/24.
<p>Agent</p>	<pre> FS(config)#snmp-server view view1 1.3.6.1.2.1.1 include FS(config)#snmp-server view view2 1.3.6.1.2.1.1.4.0 include FS(config)#snmp-server group g1 v3 priv read view1 write view2 FS(config)#snmp-server user user1 g1 v3 auth md5 123 priv des56 321 FS(config)#snmp-server host 192.168.3.2 traps version 3 priv user1 FS(config)#snmp-server enable traps FS(config)#interface gigabitEthernet 0/1 FS(config-if-gigabitEthernet 0/1)#ip address 192.168.3.1 255.255.255.0 FS(config-if-gigabitEthernet 0/1)#exit </pre>
<p>Verification</p>	<ol style="list-style-type: none"> 1. Run the show running-config command to display configuration information of the device. 2. Run the show snmp user command to display the SNMP user. 3. Run the show snmp view command to display the SNMP view. 4. Run the show snmp group command to display the SNMP group. 5. Run the show snmp host command to display the host information configured by the user.

	<p>6. Install MIB-Browser.</p>
<p>Agent</p>	<pre> FS# show running-config ! interface gigabitEthernet 0/1 no ip proxy-arp ip address 192.168.3.1 255.255.255.0 ! snmp-server view view1 1.3.6.1.2.1.1 include snmp-server view view2 1.3.6.1.2.1.1.4.0 include snmp-server user user1 g1 v3 encrypted auth md5 7EBD6A1287D3548E4E52CF8349CBC93D priv des56 D5CEC4884360373ABBF30AB170E42D03 snmp-server group g1 v3 priv read view1 write view2 snmp-server host 192.168.3.2 traps version 3 priv user1 snmp-server enable traps </pre> <pre> FS# show snmp user User name: user1 Engine ID: 800013110300d0f8221120 storage-type: permanent active Security level: auth priv Auth protocol: MD5 Priv protocol: DES Group-name: g1 </pre> <pre> FS#show snmp view view1(include) 1.3.6.1.2.1.1 view2(include) 1.3.6.1.2.1.1.4.0 default(include) 1.3.6.1 </pre> <pre> FS# show snmp group groupname: g1 securityModel: v3 securityLevel:authPriv readview: view1 writeview: view2 notifyview: </pre>

```
FS#show snmp host
Notification host: 192.168.3.2
udp-port: 162
type: trap
user: user1
security model: v3 authPriv
```

Install MIB-Browser, enter IP address **192.168.3.1** in **IP Address** and **user1** in **UserName**, select **AuthPriv** for **Security Level**, enter **123** in **AuthPassWord**, select **MD5** for **AuthProtocol**, and enter **321** in **PrivPassWord**. Click **Add Item** and select a management unit for which the MIB needs to be queried, for example, **System** in the following figure. Click **Start**. The MIB is queried for network devices. The lowest pane in the following figure shows query results.

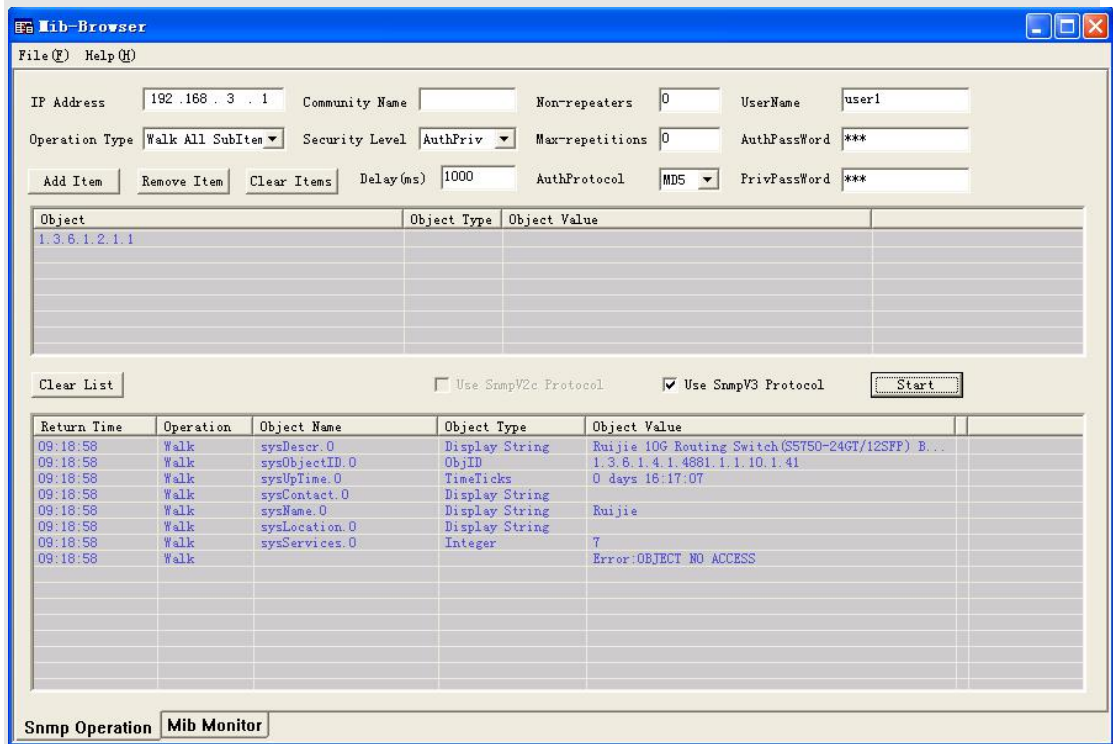

Common Errors

1.4.2 Enabling the Trap Function

Configuration Effect

Enable the agent to actively send a trap message to the NMS.

Notes

N/A

Configuration Steps

➤ **Configuring the SNMP Host Address**

- Optional
- Configure the host address of the NMS when the agent is required to actively send messages.

➤ **Enabling the Agent to Actively Send a Trap Message to the NMS**

- Optional
- Configure this item on the agent when the agent is required to actively send a trap message to the NMS.

➤ **Enabling the Function of Sending a Link Trap Message on an Interface**

- Optional
- Configure this item on the agent when a link trap message needs to be sent on an interface.

➤ **Enabling the Function of Sending a System Reboot Trap Message**

- Optional
- Configure this item on the agent when the FSOS system is required to send a trap message to the NMS to notify system reboot before reloading or reboot of the device.

➤ **Specifying the Source Address for Sending a Trap Message**

- Optional
- Configure this item on the agent when it is required to permanently use a local IP address as the source SNMP address to facilitate management.

➤ **Enabling a Trap Message to Carry Private Fields when the Message Is Sent**

- Optional
- Configure this item on the agent when private fields need to be carried in a trap message.

Verification



Run the **show snmp** command to display the SNMP status.

Run the **show running-config** command to display configuration information of the device.

Related Commands

➤ **Setting the NMS Host Address**

Command	snmp-server host [oob] { <i>host-addr</i> ipv6 <i>ipv6-addr</i> domain <i>domain-name</i> } [vrf <i>vrfname</i>] [traps informs] [version { 1 2c 3 { auth noauth priv }] <i>community-string</i> [udp-port <i>port-num</i>] [<i>notification-type</i>]
Parameter Description	<p>oob: Configures Out-Of-Band (OOB) communication for the alarm server (that is, information is sent to the alarm server through the MGMT interface).</p> <p><i>host-addr</i>: Address of the SNMP host.</p> <p><i>ipv6-addr</i>: (IPv6) address of the SNMP host.</p> <p><i>domain-name</i>: Domain name of the SNMP host.</p> <p><i>vrfname</i>: Configures a VRF forwarding table name.</p> <p>traps informs: Configures the host to send a trap message or an inform message.</p>

	<p>version: SNMP version, which can be set to V1, V2C, or V3.</p> <p>auth noauth priv: Sets the security level of V3 users.</p> <p><i>community-string:</i> Community string or user name (V3).</p> <p><i>port-num:</i> Configures the port ID of the SNMP host.</p> <p><i>notification-type:</i> Type of trap messages that are actively sent, for example, snmp.</p> <p> If no trap type is specified, all trap messages are sent.</p>
Command Mode	Global configuration mode
Usage Guide	<p>This command is used with the snmp-server enable traps command to actively send trap messages to the NMS. You can configure different SNMP hosts to receive trap messages. A host can support different traps, ports, and VRF forwarding tables. If the same host is configured (the port and VRF configuration are the same), the last configuration is combined with the previous configurations, that is, to send different trap messages to the same host, configure one type of trap messages each time. These configurations are finally combined.</p> <p> In this command, the via parameter can be specified only when the oob parameter is enabled. In addition, the vrf parameter cannot be used.</p>

➤ **Enabling the Agent to Actively Send a Trap Message to the NMS**

Command	snmp-server enable traps [<i>notification-type</i>]
Parameter Description	<p><i>notification-type:</i> Enables trap notification for the corresponding events, including the following types:</p> <p>snmp: Enables trap notification for SNMP events.</p> <p>bgp: Enables trap notification for BGP events.</p> <p>bridge: Enables trap notification for bridge events.</p> <p>isis: Enables trap notification for ISIS events.</p> <p>mac-notification: Enables trap notification for MAC events.</p> <p>ospf: Enables trap notification for OSPF events.</p> <p>urpf: Enables trap notification for URPF events.</p> <p>vrrp: Enables trap notification for VRRP events.</p> <p>web-auth: Enables trap notification for Web authentication events.</p>
Command Mode	Global configuration mode
Usage Guide	This command must be used with the snmp-server host command to so that trap messages can be actively sent.

➤ **Enabling the Function of Sending a Link Trap Message on an Interface**

Command	snmp trap link-status
Parameter Description	-
Configuration mode	Interface configuration mode
Usage Guide	For interfaces (Ethernet interface, AP interface, and SVI interface), when this function is enabled, the SNMP sends a Link Trap message if the link status on the interfaces changes. Otherwise, the SNMP does not send the message.

➤ **Enabling the Function of Sending a System Reboot Trap Message**

Command	snmp-server system-shutdown
Parameter	-
Description	
Configuration mode	Global configuration mode
Usage Guide	When the function of notification upon SNMP system reboot is enabled, a trap message is sent to the NMS to notify system reboot before reloading or reboot of the device.

➤ **Specifying the Source Address for Sending a Trap Message**

Command	snmp-server trap-source <i>interface</i>
Parameter	<i>interface</i> : Used as the interface for the SNMP source address.
Description	
Configuration mode	Global configuration mode
Usage Guide	By default, the IP address of the interface where SNMP packets are sent is used as the source address. To facilitate management and identification, this command can be run to permanently use one local IP address as the source SNMP address.

➤ **Enabling a Trap message to Carry Private Fields when the Message Is Sent**

Command	snmp-server trap-format private
Parameter	-
Description	
Configuration mode	Global configuration mode
Usage Guide	This command can be used to enable a trap message to carry private fields when the message is sent. At present, supported private fields include the alarm generation time. For the specific data types and data ranges of the fields, see FS-TRAP-FORMAT-MIB.mib.

Configuration Example

➤ **Enabling the Trap Function**

<p>Scenario Figure 1- 8</p>	
	<ul style="list-style-type: none"> The NMS manages network devices (agents) based on the community authentication mode, and network devices can actively send messages to the NMS.
<p>Configuration Steps</p>	<ol style="list-style-type: none"> Perform configuration to enable the agent to actively send messages to the NMS. Set the SNMP host address to 192.168.3.2, the message format to Version2c, and the authentication name to user1. Enable the agent to actively send trap messages. Set the IP address of the agent. Set the address of the Gi0/1 interface to 192.168.3.1/24.

<p>Agent</p>	<pre>FS(config)#snmp-server host 192.168.3.2 traps version 2c user1 FS(config)#snmp-server enable traps FS(config)#interface gigabitEthernet 0/1 FS(config-if-gigabitEthernet 0/1)#ip address 192.168.3.1 255.255.255.0 FS(config-if-gigabitEthernet 0/1)#exit</pre>
<p>Verification</p>	<ul style="list-style-type: none"> ● Run the show running-config command to display configuration information of the device. ● Run the show snmp command to display the SNMP status.
<p>Agent</p>	<pre>FS# show running-config ip access-list standard a1 10 permit host 192.168.3.2 interface gigabitEthernet 0/1 no ip proxy-arp ip address 192.168.3.1 255.255.255.0 snmp-server view v1 1.3.6.1.2.1.1 include snmp-server location fuzhou snmp-server host 192.168.3.2 traps version 2c user1 snmp-server enable traps snmp-server contact FS.com.cn snmp-server community user1 view v1 rw a1 snmp-server chassis-id 1234567890</pre>
	<pre>FS#show snmp Chassis: 1234567890 0 SNMP packets input 0 Bad SNMP version errors 0 Unknown community name 0 Illegal operation for community name supplied 0 Encoding errors 0 Number of requested variables 0 Number of altered variables 0 Get-request PDUs 0 Get-next PDUs 0 Set-request PDUs</pre>

0 SNMP packets output
0 Too big errors (Maximum packet size 1472)
0 No such name errors
0 Bad values errors
0 General errors
0 Response PDUs
0 Trap PDUs
SNMP global trap: enabled
SNMP logging: disabled
SNMP agent: enabled

Common Errors

N/A

1.4.3 Shielding the Agent Function

Configuration Effect

Shield the agent function when the agent service is not required.

Notes

- Run the **no snmp-server** command to shield the SNMP agent function when the agent service is not required.
- Different from the shielding command, after the **no enable service snmp-agent** command is run, all SNMP services are directly disabled (that is, the SNMP agent function is disabled, no packet is received, and no response packet or trap packet is sent), but configuration information of the agent is not shielded.

Configuration Steps

▾ Shielding the SNMP Agent Function for the Device

- Optional
- To shield the configuration of all SNMP agent services, use this configuration.

▾ Disabling the SNMP Agent Function for the Device

- Optional
- To directly disable all services, use this configuration.

Verification

Run the **show service** command to check whether SNMP services are enabled or disabled.

Run the **show snmp** command to display the SNMP status.

Run the **show running-config** command to display configuration information of the device.

Related Commands

➤ **Shielding the SNMP Agent Function for the Device**

Command	no snmp-server
Parameter Description	N/A
Command Mode	Global configuration mode
Usage Guide	<p>By default, the SNMP agent function is disabled. When SNMP agent parameters (for example, NMS host address, authentication name, and access permission) are set, the SNMP agent service is automatically enabled. The enable service snmp-agent command must also be run at the same time so that the SNMP agent service can take effect. If the SNMP agent service is disabled or the enable service snmp-agent command is not run, the SNMP agent service does not take effect. Run the no snmp-server command to disable SNMP agent services of all versions supported by the device.</p> <p>After this command is run, all SNMP agent service configurations are shielded (that is, after the show running-config command is run, no configuration is displayed. Configurations are restored after the SNMP agent service is enabled again). After the enable service snmp-agent command is run, the SNMP agent configurations are not shielded.</p>

➤ **Disabling the SNMP Agent Function for the Device**

Command	no enable service snmp-agent
Parameter Description	N/A
Configuration mode	Global configuration mode
Usage Guide	This command can be used to disable the SNMP service, but it will not shield SNMP agent parameters.

Configuration Example

➤ **Enabling the SNMP Service**

Scenario Figure 1-9	<p>After the SNMP service is enabled and the SNMP agent server is set, the NMS can access devices based on SNMP.</p>
Configuration Steps	<ol style="list-style-type: none"> 1. Enable the SNMP service. 2. Set parameters for the SNMP agent server to make the SNMP service take effect.
A gent	FS(config)#enable service snmp-agent
Verification	<ol style="list-style-type: none"> 1. Run the show service command to check whether the SNMP service is enabled or disabled.
Agent	FS#show service

```
web-server : disabled
web-server(https): disabled
snmp-agent : enabled
ssh-server : disabled
telnet-server : enabled
```

Common Errors

N/A

1.4.4 Setting SNMP Control Parameters

Configuration Effect

Set basic parameters of the SNMP agent, including the device contact mode, device location, serial number, and parameters for sending a trap message. By accessing the parameters, the NMS can obtain the contact person of the device and physical location of the device.

Notes

N/A

Configuration Steps

▾ Setting the System Contact Mode

- Optional
- When the contact mode of the system needs to be modified, configure this item on the agent.

▾ Setting the System Location

- Optional
- When the system location needs to be modified, configure this item on the agent.

▾ Setting the System Serial Number

- Optional
- When the system serial number needs to be modified, configure this item on the agent.

▾ Setting NE Information about the Device

- Optional
- When the NE code needs to be modified, configure this item on the agent.

▾ Setting the Maximum Packet Length of the SNMP Agent

- Optional
- When the maximum packet length of the SNMP agent needs to be modified, configure this item on the agent.

▾ Setting the UDP Port ID of the SNMP Service

- Optional
- When the UDP port ID of the SNMP service needs to be modified, configure this item on the agent.

↘ **Setting the Queue Length of Trap Messages**

- Optional
- When the size of the message queue needs to be adjusted to control the message sending speed, configure this item on the agent.

↘ **Setting the Interval for Sending a Trap Message**

- Optional
- When the interval for sending a trap message needs to be modified, configure this item on the agent.

↘ **Configuring SNMP Flow Control**

- Optional
- If a large number of SNMP request packets result in high CPU usage for SNMP tasks, configure SNMP flow control to limit the number of request packets processed per second in each SNMP task, so as to control the CPU usage for SNMP tasks.

↘ **Configuring the SNMP Version**

- Optional.
- SNMP contains three versions, that is, v1, v2C, and v3. If only a specific version is used for MIB interaction management in a user scenario, you can disable unused SNMP versions.

Verification

Run the **show snmp** command to display the SNMP status.

Run the **show running-config** command to display configuration information of the device.

Related Commands

↘ **Setting the System Contact Mode**

Command	snmp-server contact <i>text</i>
Parameter	<i>text</i> : String that describes the system contact mode.
Description	
Command Mode	Global configuration mode
Usage Guide	N/A

↘ **Setting the System Location**

Command	snmp-server location <i>text</i>
Parameter	<i>text</i> : String that describes system information.
Description	
Configuration	Global configuration mode

mode	
Usage Guide	N/A

⌵ Setting the System Serial Number

Command	snmp-server chassis-id <i>text</i>
Parameter Description	<i>text</i> : Text of the system serial number, which may be digits or characters.
Configuration mode	Global configuration mode
Usage Guide	In general, the device serial number is used as the SNMP serial number to facilitate identification of the device.

⌵ Setting NE Information about the Device

Command	snmp-server net-id <i>text</i>
Parameter Description	<i>text</i> : Text that is used to set the device NE code. The text is a string that consists of 1 to 255 characters that are case-sensitive and may include spaces.
Configuration mode	Global mode.
Usage Guide	Set the NE code of the device.

⌵ Setting the Maximum Packet Length of the SNMP Agent

Command	snmp-server packet-size <i>byte-count</i>
Parameter Description	<i>byte-count</i> : Packet size, ranging from 484 bytes to 17,876 bytes.
Configuration mode	Global mode.
Usage Guide	N/A

⌵ Setting the UDP Port ID of the SNMP Service

Command	snmp-server udp-port <i>port-num</i>
Parameter Description	<i>port-num</i> : Specifies the UDP port ID of the SNMP service, that is, the ID of the protocol port that receives SNMP packets.
Configuration mode	Global mode.
Usage Guide	Specify the protocol port ID for receiving SNMP packets.

⌵ Setting the Length of a Trap Message Queue

Command	snmp-server queue-length <i>length</i>
Parameter Description	<i>length</i> : Queue length, ranging from 1 to 1,000.
Configuration mode	Global configuration mode
Usage Guide	Adjust the size of the message queue to control the message sending speed.

⌵ Setting the Interval for Sending a Trap Message

Command	snmp-server trap-timeout <i>seconds</i>
Parameter	<i>seconds</i> : Interval (unit: second). The value range is 1 to 1,000.
Description	
Configuration mode	Global configuration mode
Usage Guide	Adjust the interval for sending a message to control the message sending speed.

⤵ **Configuring SNMP Flow Control**

Command	snmp-server flow-control pps [<i>count</i>]
Parameter	<i>count</i> : Number of SNMP request packets processed per second. The value range is 50 to 65,535.
Description	
Command Mode	Global configuration mode
Usage Guide	If a large number of SNMP request packets result in high CPU usage for SNMP tasks, configure SNMP flow control to limit the number of request packets processed per second in each SNMP task, so as to control the CPU usage for SNMP tasks.

⤵ **Configuring the SNMP Version**

Command	snmp-server enable version [<i>v1</i> <i>v2c</i> <i>v3</i>]
Parameter	<i>v1</i> , <i>v2c</i> , and <i>v3</i> indicate three SNMP versions.
Description	
Command Mode	Global configuration mode
Usage Guide	If only one version is used for MIB interaction management in a user scenario, run this command to disable other versions.

Configuration Example

⤵ **Setting SNMP Control Parameters**

Scenario Figure 1- 10	<p>● The NMS manages network devices (agents) based on the community authentication mode and can obtain basic system information about the devices, for example, system contact mode, location, and serial number.</p>
Configuration Steps	<ol style="list-style-type: none"> 1. Set SNMP agent parameters. Set the system location, contact mode, and serial number. 2. Set the IP address of the agent. Set the address of the Gi0/1 interface to 192.168.3.1/24.
Agent	<pre>FS(config)#snmp-server location fuzhou FS(config)#snmp-server contact FS.com.cn</pre>

	<pre> FS(config)#snmp-server chassis-id 1234567890 FS(config)#interface gigabitEthernet 0/1 FS(config-if-gigabitEthernet 0/1)#ip address 192.168.3.1 255.255.255.0 FS(config-if-gigabitEthernet 0/1)#exit </pre>
<p>Verification</p>	<ol style="list-style-type: none"> 1. Check the configuration information of the device. 2. Check the SNMP view and group information.
<p>Agent</p>	<pre> FS# show running-config ip access-list standard a1 10 permit host 192.168.3.2 interface gigabitEthernet 0/1 no ip proxy-arp ip address 192.168.3.1 255.255.255.0 snmp-server view v1 1.3.6.1.2.1.1 include snmp-server location fuzhou snmp-server host 192.168.3.2 traps version 2c user1 snmp-server enable traps snmp-server contact FS.com.cn snmp-server community user1 view v1 rw a1 snmp-server chassis-id 1234567890 </pre>
	<pre> FS#show snmp view v1(include) 1.3.6.1.2.1.1 default(include) 1.3.6.1 FS#show snmp group groupname: user1 securityModel: v1 securityLevel:noAuthNoPriv readview: v1 writeview: v1 notifyview: groupname: user1 securityModel: v2c securityLevel:noAuthNoPriv readview: v1 </pre>

	writeview: v1 notifyview:
--	------------------------------

Common Errors

N/A

1.5 Monitoring

Displaying

Description	Command
Displays the SNMP status.	show snmp [mib user view group host version]

2Configuring RMON

2.1Overview

The Remote Network Monitoring (RMON) aims at resolving problems of managing local area networks (LANs) and remote sites by using one central point. In RMON, network monitoring data consists of a group of statistics and performance indicators, which can be used for monitoring the network utilization, so as to facilitate network planning, performance optimization, and network error diagnosis.

RMON is mainly used by a managing device to remotely monitor and manage managed devices.

Protocols and Standards

STD 0059 / RFC 2819: Remote Network Monitoring Management Information Base

RFC4502: Remote Network Monitoring Management Information Base Version 2

RFC 3919: Remote Network Monitoring (RMON) Protocol Identifiers for IPv6 and Multi Protocol Label Switching (MPLS)

RFC 3737: IANA Guidelines for the Registry of Remote Monitoring (RMON) MIB Modules

RFC 3434: Remote Monitoring MIB Extensions for High Capacity Alarms

RFC 3395: Remote Network Monitoring MIB Protocol Identifier Reference Extensions

RFC 3287: Remote Monitoring MIB Extensions for Differentiated Services

RFC 3273: Remote Network Monitoring Management Information Base for High Capacity Networks

RFC 2896: Remote Network Monitoring MIB Protocol Identifier Macros

RFC 2895: Remote Network Monitoring MIB Protocol Identifier Reference

2.2Applications

Application	Description
Collecting Statistics on Information of a Monitored Interface	Applies four functions of RMON to an interface to monitor the network communication of the interface.

2.2.1Collecting Statistics on Information of a Monitored Interface

Scenario

The RMON Ethernet statistics function is used to monitor accumulated information of an interface, the history statistics function is used to monitor the packet count of an interface within each monitoring interval, and the alarm function is used to immediately acquire packet count exceptions of an interface. The following figure shows the networking topology.

Figure 2-1

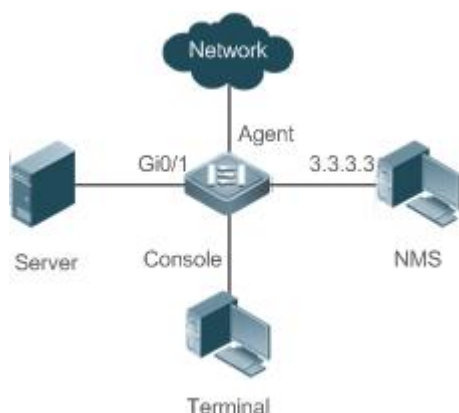

Deployment

Interface is monitored to accumulatively collect statistics on the packet count of the interface and collect statistics on the packet count and bandwidth utilization of the interface within the monitoring interval. If a packet count exception occurs on the interface, an alarm is reported to the network management system (NMS). The configuration key points are as follows:

- Configure the RMON Ethernet statistics function on interface.
- Configure the RMON history statistics function on interface.
- Configure the RMON alarm table and define RMON event processing actions in configuration mode. Monitored objects of alarms are the object identifier (OID) values of specific fields in the RMON Ethernet statistical table configured for interface.

2.3 Features

Basic Concepts

RMON defines multiple RMON groups. FS products support the statistics group, history group, alarm group, and event group, which are described as follows:

Statistics Group

The statistics group is used to monitor and collect statistics on Ethernet interface traffic information, which is accumulated from the entry creation time to the current time. The statistical items include discarded data packets, broadcast data packets, cyclic redundancy check (CRC) errors, large and small blocks, and collisions. Statistical results are stored in the Ethernet statistical table.

History Group

The history group is used to periodically collect network traffic information. It records accumulated values of network traffic information and the bandwidth utilization within each interval, and saves them in the history control table. It includes two small groups:

- The HistoryControl group is used to set the sampling interval, sampling data source, and other control information.
- The EthernetHistory group provides administrators with historical data, including statistics on network segment traffic, error packets, broadcast packets, utilization, and number of collisions.

Alarm Group

The alarm group is used to monitor a specified Management Information Base (MIB) object. When the value of a MIB object exceeds the preset upper limit or is lower than the preset lower limit, an alarm is triggered and the alarm is processed as an event.

Event Group

The event group is used to define the event processing mode. When a monitored MIB object meets alarm conditions, an event is triggered. An event can be processed in any of the following modes:

- none: No action is taken.
- log: Event-relevant information is recorded in the log record table so that administrators can view it at any time.
- snmp-trap: A trap message is transmitted to the NMS to notify the NMS of the event occurrence.
- log-and-trap: Event-relevant information is recorded in the log record table and a trap message is transmitted to the NMS.

Working Principle

RMON supports multiple monitors and two data collection methods. Method 1: A dedicated RMON probe is used to collect data and the NMS can directly acquire all information about the RMON MIB from the RMON probe. Method 2: RMON agents are built into network devices so that the devices have the RMON probe function. The NMS uses basic commands of the Simple Network Management Protocol (SNMP) to exchange data with the RMON agents and collect network management information. This method, however, is limited by device resources and information of only four groups rather than all data of the RMON MIB is acquired.

The following figure shows an example of communication between the NMS and RMON agents. The NMS, through the RMON agents running on devices, can acquire information about overall traffic, error statistics, and performance statistics of the network segment where a managed network device interface is, thereby implementing remote management of network devices.

Figure 2-2

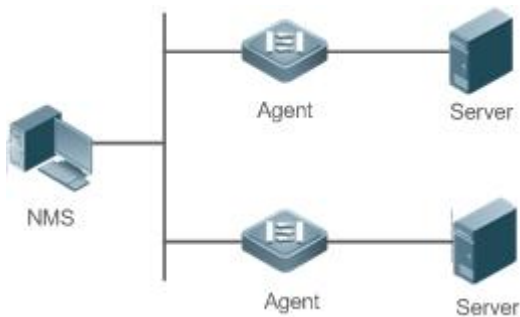

Overview

Feature	Description
<u>RMON Ethernet Statistics</u>	Collects statistics on the packet count, byte count, and other data of a monitored Ethernet interface accumulatively.
<u>RMON History Statistics</u>	Records the counts of packets, bytes, and other data communicated by an Ethernet interface within the configured interval and calculates the bandwidth utilization within the interval.
<u>RMON Alarm</u>	Samples values of monitored variables at intervals. The alarm table is used in combination with the event table. When the upper or lower limit is reached, a relevant event table is triggered to perform event processing or no processing is performed.

2.3.1 RMON Ethernet Statistics

Working Principle

The RMON Ethernet statistics function accumulatively collects statistics on network traffic information of an Ethernet interface from the entry creation time to the current time.

Related Configuration

↘ **Configuring RMON Statistical Entries**

- The RMON Ethernet statistics function is disabled by default.
- Run the **rmon collection stats** command to create Ethernet statistical entries on a specified Ethernet interface.
- After statistical entries are successfully created on a specified interface, the statistics group collects statistics on the traffic information of the current interface. The statistical items are variables defined in the RMON Ethernet statistical table, and recorded information is the accumulated values of variables from the creation time of the RMON statistical table to the current time.

2.3.2 RMON History Statistics

Working Principle

The RMON history statistics function records accumulated statistics on traffic information of an Ethernet interface within each interval.

Related Configuration

↘ **Configuring RMON Historical Control Entries**

- The RMON history statistics function is disabled by default.
- Run the **rmon collection history** command to create historical control entries on an Ethernet interface.
- The RMON history group collects statistics on variables defined in the RMON history table and records accumulated values of variables within each interval.

2.3.3 RMON Alarm

Working Principle

The RMON alarm function periodically monitors value changes of alarm variables. If the value of an alarm variable reaches the specified upper threshold or lower threshold, a corresponding event is triggered for processing, for example, a trap message is transmitted or one logTable entry record is generated. If a lower threshold or upper threshold is reached multiple times consecutively, only one corresponding event is triggered and another event is triggered till a reverse threshold is reached.

Related Configuration

↘ **Configuring the Event Table**



- The RMON event group function is disabled by default.
- Run the **rmon event** command to configure the event table.

↘ **Configuring Alarm Entries**

- The RMON alarm group function is disabled by default.
- Run the **rmon event** command to configure the event table and run the **rmon alarm** command to configure the RMON alarm table.

- The RMON alarm function is implemented by the alarm table and event table jointly. If a trap message needs to be transmitted to a managing device in the case of an alarm event, the SNMP agent must be correctly configured first. For the configuration of the SNMP agent, see the *Configuring SNMP*.
- If a configured alarm object is a field node in the RMON statistics group or history group, the RMON Ethernet statistics function or RMON history statistics function need to be configured on a monitored Ethernet interface first.

2.4 Configuration

Configuration	Description and Command	
Configuring RMON Ethernet Statistics	 (Mandatory) It is used to accumulatively collect statistics on traffic information of an Ethernet interface.	
	rmon collection stats	Configures Ethernet statistical entries.
Configuring RMON History Statistics	 (Mandatory) It is used to collect, at intervals, statistics on traffic information of an Ethernet interface and the bandwidth utilization within the interval.	
	rmon collection history	Configures historical control entries.
Configuring RMON Alarm	 (Mandatory) It is used to monitor whether data changes of a variable is within the valid range.	
	rmon event	Configures event entries.
	rmon alarm	Configures alarm entries.

2.4.1 Configuring RMON Ethernet Statistics

Configuration Effect

Acquire accumulated statistics on traffic information of a monitored Ethernet interface from the entry creation time to the current time.

Notes

This function cannot be configured in batch interface configuration mode.

Configuration Steps

⌵ Configuring RMON Statistical Entries

- Mandatory.
- If statistics and monitoring are required for a specified interface, Ethernet statistical entries must be configured on this interface.

Verification

Run the **show rmon stats** command to display Ethernet statistics.

Related Commands

⌵ Configuring RMON Statistical Entries

Command	rmon collection stats <i>index</i> [owner <i>ownername</i>]
Parameter	<i>index</i> : Indicates the index number of a statistical entry, with the value ranging from 1 to 65,535.
Description	owner <i>ownername</i> : Indicates the entry creator, that is, <i>ownername</i> , which is a case-sensitive string of 1-63 characters.

Command	Interface configuration mode
Mode	
Usage Guide	The values of statistical entry parameters cannot be changed.

Configuration Example

▾ **Configuring RMON Ethernet Statistics**

<p>Scenario</p> <p>Figure 2-3</p>	
	<p>As shown in the preceding figure, the RMON agent is connected to the server, and the NMS requires the RMON statistics group to conduct performance statistics on received packets of interface Gi0/1. Administrators can view the statistics at any time to understand data about received packets of an interface and take measures in a timely manner to handle network exceptions.</p>
<p>Configuration Steps</p>	<ul style="list-style-type: none"> Configure a statistical table instance on interface GigabitEthernet 0/1 to collect statistics on the traffic of this interface.
<p>Agent</p>	<pre>FS# configure terminal FS (config)# interface gigabitEthernet 0/1 FS (config-if-GigabitEthernet 0/1)# rmon collection stats 1 owner admin</pre>
<p>Verification</p>	<p>Run the show rmon stats command to display Ethernet statistics.</p>
<p>Agent</p>	<pre>FS# show rmon stats ether statistic table: index = 1 interface = GigabitEthernet 0/1 owner = admin status = 1 dropEvents = 0 octets = 25696 pkts = 293 broadcastPkts = 3 multiPkts = 0 crcAlignErrors = 0</pre>

	<pre> underSizePkts = 0 overSizePkts = 0 fragments = 0 jabbers = 0 collisions = 0 packets64Octets = 3815 packets65To127Octets = 1695 packets128To255Octets = 365 packets256To511Octets = 2542 packets512To1023Octets = 152 packets1024To1518Octets = 685 </pre>
--	---

Common Errors

Statistical table entries are re-configured or configured statistical table entries are modified.

2.4.2 Configuring RMON History Statistics

Configuration Effect

Acquire accumulated statistics on the traffic of a monitored Ethernet interface and the bandwidth utilization within each interval.

Notes

This function cannot be configured in batch interface configuration mode.

Configuration Steps

- Mandatory.
- If network statistics on a specified interface need to be collected, RMON historical control entries must be configured on the interface.

Verification

Run the **show rmon history** command to display history group statistics.

Related Commands

↘ Configuring RMON Historical Control Entries

Command	rmon collection history <i>index</i> [owner <i>ownername</i>] [buckets <i>bucket-number</i>] [interval <i>seconds</i>]
Parameter	<i>index</i> : Indicates the index number of a history statistical entry, with the value ranging from 1 to 65,535.
Description	<p>owner <i>ownername</i>: Indicates the entry creator, that is, <i>ownername</i>, which is a case-sensitive string of 1-63 characters.</p> <p>buckets <i>bucket-number</i>: Sets the capacity of the history table in which a history statistical entry exists, that is, sets the maximum number of records (<i>bucket-number</i>) that can be accommodated in the history table. The value of <i>bucket-number</i> ranges from 1 to 65,535 and the default value is 10.</p> <p>interval <i>seconds</i>: Sets the statistical interval, with the unit of seconds. The value ranges from 1 second to 3,600</p>

	seconds and the default value is 1,800 seconds.
Command	Interface configuration mode
Mode	
Usage Guide	The values of history statistical entry parameters cannot be changed.

Configuration Example

▾ **Configuring RMON History Statistics**

<p>Scenario Figure 2-4</p>	
	<p>As shown in the preceding figure, the RMON agent is connected to the server, and the NMS needs to collect statistics on received packets of interface Gi0/1 through the RMON history group at an interval of 60 seconds, in an effort to monitor the network and understand emergency data.</p>
<p>Configuration Steps</p>	<ul style="list-style-type: none"> Configure the history control table on interface GigabitEthernet 0/1 to periodically collect statistics on the traffic of this interface.
<p>Agent</p>	<pre>FS# configure terminal FS(config)# interface gigabitEthernet 0/1 FS(config-if-GigabitEthernet 0/1)# rmon collection history 1 buckets 5 interval 300 owner admin</pre>
<p>Verification</p>	<p>Run the show rmon history command to display history group statistics.</p>
<p>Agent</p>	<pre>FS# show rmon history rmon history control table: index = 1 interface = GigabitEthernet 0/1 bucketsRequested = 5 bucketsGranted = 5 interval = 60 owner = admin stats = 1 rmon history table: index = 1</pre>

```
sampleIndex = 786
intervalStart = 6d:18h:37m:38s
dropEvents = 0
octets = 2040
pkts = 13
broadcastPkts = 0
multiPkts = 0
crcAlignErrors = 0
underSizePkts = 0
overSizePkts = 0
fragments = 0
jabbers = 0
collisions = 0
utilization = 0

index = 1
sampleIndex = 787
intervalStart = 6d:18h:38m:38s
dropEvents = 0
octets = 1791
pkts = 16
broadcastPkts = 1
multiPkts = 0
crcAlignErrors = 0
underSizePkts = 0
overSizePkts = 0
fragments = 0
jabbers = 0
collisions = 0
utilization = 0

index = 1
sampleIndex = 788
intervalStart = 6d:18h:39m:38s
```

```
dropEvents = 0
octets = 432
pkts = 6
broadcastPkts = 0
multiPkts = 0
crcAlignErrors = 0
underSizePkts = 0
overSizePkts = 0
fragments = 0
jabbers = 0
collisions = 0
utilization = 0

index = 1
sampleIndex = 789
intervalStart = 6d:18h:40m:38s
dropEvents = 0
octets = 432
pkts = 6
broadcastPkts = 0
multiPkts = 0
crcAlignErrors = 0
underSizePkts = 0
overSizePkts = 0
fragments = 0
jabbers = 0
collisions = 0
utilization = 0

index = 1
sampleIndex = 790
intervalStart = 6d:18h:41m:38s
dropEvents = 0
octets = 86734
```

<pre> pkts = 934 broadcastPkts = 32 multiPkts = 23 crcAlignErrors = 0 underSizePkts = 0 overSizePkts = 0 fragments = 0 jabbers = 0 collisions = 0 utilization = 0 </pre>
--

Common Errors

History control table entries are re-configured or configured history control table entries are modified.

2.4.3 Configuring RMON Alarm

Configuration Effect

Periodically monitor whether value changes of alarm variables are within the specified valid range.

Notes

If a trap message needs to be transmitted to a managing device when an alarm event is triggered, the SNMP agent must be correctly configured. For the configuration of the SNMP agent, see the *Configuring SNMP*.

If an alarm variable is a MIB variable defined in the RMON statistics group or history group, the RMON Ethernet statistics function or RMON history statistics function must be configured on the monitored Ethernet interface. Otherwise, an alarm table fails to be created.

Configuration Steps

↘ Configuring Event Entries

- Mandatory.
- Complete the configuration in global configuration mode.

↘ Configuring Alarm Entries

- Mandatory.
- Complete the configuration in global configuration mode.

Verification

- Run the **show rmon event** command to display the event table.
- Run the **show rmon alarm** command to display the alarm table.

Related Commands

➤ **Configuring the Event Table**

Command	rmon event <i>number</i> [log] [trap <i>community</i>] [description <i>description-string</i>] [owner <i>ownername</i>]
Parameter	<i>number</i> : Indicates the index number of an event table, with the value ranging from 1 to 65,535.
Description	<p>log: Indicates a log event. The system logs a triggered event.</p> <p>trap <i>community</i>: Indicates a trap event. When an event is triggered, the system transmits a trap message with the community name of <i>community</i>.</p> <p>description <i>description-string</i>: Sets the description information about an event, that is, <i>description-string</i>. The value is a string of 1-127 characters.</p> <p>owner <i>ownername</i>: Indicates the entry creator, that is, <i>ownername</i>, which is a case-sensitive string of 1-63 characters.</p>
Command	Global configuration mode
Mode	
Usage Guide	The values of configured event entry parameters can be changed, including the event type, trap community name, event description, and event creator.

➤ **Configuring the RMON Alarm Group**

Command	rmon alarm <i>number</i> <i>variable</i> <i>interval</i> { absolute delta } rising-threshold <i>value</i> [<i>event-number</i>] falling-threshold <i>value</i> [<i>event-number</i>] [owner <i>ownername</i>]
Parameter	<i>number</i> : Indicates the index number of an alarm entry, with the value ranging from 1 to 65,535.
Description	<p><i>variable</i>: Indicates an alarm variable, which is a string of 1-255 characters and is represented in dotted format using the node OID (format: entry.integer.instance; example: 1.3.6.1.2.1.2.1.10.1).</p> <p><i>interval</i>: Indicates the sampling interval, with the unit of seconds and the value ranging from 1 to 2,147,483,647.</p> <p>absolute: Indicates that the sampling type is absolute value sampling, that is, variable values are directly extracted when the sampling time is up.</p> <p>delta: Indicates that the sampling type is changing value sampling, that is, changes in the variable values within the sampling interval are extracted when the sampling time is up.</p> <p>rising-threshold <i>value</i>: Sets the upper limit of the sampling quantity (<i>value</i>), with the value ranging from -2,147,483,648 to +2,147,483,647.</p> <p><i>event-number</i>: Indicates that an event with the event number of <i>event-number</i> is triggered when the upper limit or lower limit is reached.</p> <p>falling-threshold <i>value</i>: Sets the lower limit of the sampling quantity (<i>value</i>), with the value ranging from -2,147,483,648 to +2,147,483,647.</p> <p>owner <i>ownername</i>: Indicates the entry creator, that is, <i>ownername</i>, which is a case-sensitive string of 1-63 characters.</p>
Command	Global configuration mode
Mode	
Usage Guide	Values of configured alarm entry parameters can be changed, including alarm variables, sampling type, entry creator, sampling interval, upper/lower limit of the sampling quantity, and relevant trigger events.

Configuration Example

➤ **Configuring RMON Alarm**

<p>Scenario Figure 2-5</p>	
	<p>Assume that SNMPv1 runs on the NMS, the community name used for accessing the settings is public, with the attribute of read-write, and the IP address used by the NMS to receive trap messages is 3.3.3.3.</p> <p>Assume that the OID value of unknown protocol packets received by monitored interface GigabitEthernet0/1 is 1.3.6.1.2.1.2.2.1.15.3, the sampling mode is relative sampling, and the sampling interval is 60 seconds. When the relative sampling value is larger than 100 or lower than 10, event 1 and event 2 are triggered respectively. In event 1, a trap message is transmitted and the event is logged. In event 2, the event is only logged.</p> <p>The configuration of the RMON agent is completed on the terminal. The RMON agent is connected to the NMS and is connected to the server through interface Gi0/1. The RMON agent needs to monitor the count of unknown protocol packets received by interface Gi0/1. The sampling interval is 60 seconds. When the absolute sampling value is smaller than 10, the event is only logged. When the absolute sampling value is larger than 100, the event is logged and a trap message is transmitted to the NMS.</p>
<p>Configuration Steps</p>	<ul style="list-style-type: none"> ● Configure the host address for receiving trap messages. ● Configure an event group to process alarm trigger. ● Configure the alarm function.
<p>Agent</p>	<pre> FS# configure terminal Enter configuration commands, one per line. End with CNTL/Z. FS(config)# snmp-server community public rw FS(config)# snmp-server host 3.3.3.3 trap public FS(config)# rmon event 1 description rising-threshold-event log trap public owner admin FS(config)# rmon event 2 description falling-threshold-event log owner admin FS(config)# rmon alarm 1 1.3.6.1.2.1.2.2.1.15.3 60 delta rising-threshold 100 1 falling-threshold 10 2 owner admin </pre>
<p>Verification</p>	<ul style="list-style-type: none"> ● Run the show rmon event command to display the event table. ● Run the show rmon alarm command to display the alarm table.
<p>Agent</p>	<pre> FS# show rmon event rmon event table: index = 1 </pre>

```
description = rising-threshold-event
```

```
type = 4
```

```
community = public
```

```
lastTimeSent = 0d:0h:0m:0s
```

```
owner = admin
```

```
status = 1
```

```
index = 2
```

```
description = falling-threshold-event
```

```
type = 2
```

```
community =
```

```
lastTimeSent = 6d:19h:21m:48s
```

```
owner = admin
```

```
status = 1
```

```
rmon log table:
```

```
eventIndex = 2
```

```
index = 1
```

```
logTime = 6d:19h:21m:48s
```

```
logDescription = falling-threshold-event
```

```
FS# show rmon alarm
```

```
rmon alarm table:
```

```
index: 1,
```

```
interval: 60,
```

```
oid = 1.3.6.1.2.1.2.2.1.15.3
```

```
sampleType: 2,
```

```
alarmValue: 0,
```

```
startupAlarm: 3,
```

```
risingThreshold: 100,
```

```
fallingThreshold: 10,
```

```
risingEventIndex: 1,
```

```
fallingEventIndex: 2,
```

```
owner: admin,
```

```
stauts: 1
```

Common Errors

- The entered OID of a monitored object is incorrect, the variable corresponding to the OID does not exist, or the type is not an integer or unsigned integer.
- The upper threshold is smaller than or equal to the lower threshold.

2.5 Monitoring

Displaying

Description	Command
Displays all RMON configuration information.	show rmon
Displays the Ethernet statistical table.	show rmon stats
Displays the history control table.	show rmon history
Displays the alarm table.	show rmon alarm
Displays the event table.	show rmon event

3 Configuring NTP

3.1 Overview

The Network Time Protocol (NTP) is an application-layer protocol that enables network devices to synchronize time. NTP enables network devices to synchronize time with their servers or clock sources and provides high-precision time correction (the difference from the standard time is smaller than one millisecond in a LAN and smaller than decades of milliseconds in a WAN). In addition, NTP can prevent attacks by using encrypted acknowledgment.

Currently, FS devices can be used both as NTP clients and NTP servers. In other words, a FS device can synchronize time with a time server, and be used as a time server to provide time synchronization for other devices. When a FS device is used as a server, it supports only the unicast server mode.

Protocols and Standards

- RFC 1305 : Network Time Protocol (Version 3)

3.2 Applications

Application	Description
Synchronizing Time Based on an External Reference Clock Source	A device is used as a client that synchronizes time with an external clock source. After successful synchronization, it is used as a server to provide time synchronization for other devices.
Synchronizing Time Based on a Local Reference Clock Source	A device uses a local clock as a reliable NTP reference clock source and is also used as a server to provide time synchronization for other devices.

3.2.1 Synchronizing Time Based on an External Reference Clock Source

Scenario

As shown in Figure 3-1

- DEVICE-A is used as a reliable reference clock source to provide time synchronization for external devices.
- DEVICE-B specifies DEVICE-A as the NTP server and synchronizes time with DEVICE-A.
- After successful synchronization, DEVICE-B provides time synchronization for DEVICE-C.

Figure 3-1



Deployment

Configure DEVICE-B to the NTP external reference clock mode.

3.2.2 Synchronizing Time Based on a Local Reference Clock Source

Scenario

As shown in Figure 3-2, DEVICE-B uses a local clock as the NTP reference clock source and provides time synchronization for DEVICE-C.

Figure 3-2

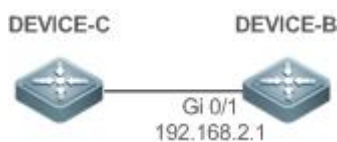

Deployment

Configure DEVICE-B to the NTP local reference clock mode.

3.3 Features

Basic Concepts

↘ NTP Packet

As defined in RFC1305, NTP uses User Datagram Protocol (UDP) packets for transmission and the used UDP port ID is 123.

Figure 3-3 shows the format of an NTP time synchronization packet.

Figure 3-3 Format of an NTP Time Synchronization Packet

0	7	15	23	31
LI	VN	Mode	Stratum	Poll Interval
Precision				
Root Delay (32-bit)				
Root Dispersion (32-bit)				
Reference Clock Identifier (32-bit)				
Reference Timestamp (64-bit)				
Originate Timestamp (64-bit)				
Receive Timestamp (64-bit)				
Transmit Timestamp (64-bit)				
Authenticator (optional 96-bit)				

- Leap Indicator(LI): indicates a 2-bit leap second indicator.
- i 00: indicates no warning information; 01: indicates that there are 61 seconds in the previous minute; 10: indicates that there are 59 seconds in the previous minute; 11: indicates that the clock is not synchronized.
- Version Number(VN): indicates a 3-bit NTP version number. The current version number is 3.
- Mode: indicates a 3-bit NTP working mode.
- i 0: indicates no definition; 1: indicates symmetric active; 2: indicates symmetric passive; 3: indicates a client; 4: indicates a server; 5: indicates broadcasting; 6: indicates control information; 7: reserved.
- Stratum: indicates the 8-bit stratum of a local clock. 0: indicates no definition; 1: indicates the master reference clock source; other values: indicate slave reference clock sources.
- Poll Interval: indicates the poll interval (seconds), which is a 8-bit integer.
- Precision: indicates the time precision (seconds) of a local clock, which is a 8-bit integer.
- Root Delay: indicates the round-trip time to the master reference clock source, which is a 32-bit integer.
- Root Dispersion: indicates the largest difference from the master reference clock source, which is a 32-bit integer.
- Reference Clock Identifier: indicates the 32-bit identifier of a reference clock source.
- Reference Timestamp: indicates a 64-bit timestamp, namely, the time that is set or corrected at the last time.
- Originate Timestamp: indicates a 64-bit timestamp, namely, the local time when a time synchronization request leaves from a client.
- Receive Timestamp: indicates a 64-bit timestamp, namely, the local time when a time synchronization request packet arrives at a server.
- Transmit Timestamp: indicates a 64-bit timestamp, namely, the local time when a time synchronization response packet leaves from a server.
- Authenticator (optional): indicates authentication information.

⏏ NTP Server

A device uses a local clock as the reference clock source to provide time synchronization for other devices in the network.

➤ **NTP Client**

A device is used as an NTP client that synchronizes time with an NTP server in the network.

➤ **Stratum**

In NTP, "stratum" is used to describe the hops from a device to an authority clock source. An NTP server whose stratum is 1 has a directly connected atomic clock or radio controlled clock; an NTP server whose stratum is 2 obtains time from the server whose stratum is 1; an NTP server whose stratum is 3 obtains time from the server whose stratum is 2; and so on. Therefore, clock sources with lower stratums have higher clock precisions.

➤ **Hardware Clock**

A hardware clock operates based on the frequency of the quartz crystal resonator on a device and is powered by the device battery. After the device is shut down, the hardware clock continues running. After the device is started, the device obtains time information from the hardware clock as the software time of the device.

Overview

Feature	Description
NTP Time Synchronization	Network devices synchronize time with their servers or reliable clock sources to implement high-precision time correction.
NTP Security Authentication	The NTP packet encryption authentication is used to prevent unreliable clock sources from time synchronization interference on a device.
NTP Access Control	An Access Control List (ACL) is used to filter sources of received NTP packets.

3.3.1 NTP Time Synchronization

Working Principle

NTP time synchronization is implemented by interaction of NTP packets between a client and a server:

- The client sends a time synchronization packet to all servers every 64 seconds. After receiving response packets from the servers, the client filters and selects the response packets from all servers, and synchronizes time with an optimum server.
- After receiving the time synchronization request packet, a server uses the local clock as the reference source, and fills the local time information into the response packet to be sent to the client based on the protocol requirement.

Figure 3-4 shows the format of an NTP time synchronization packet.

Figure 3-4 Working Principle of NTP

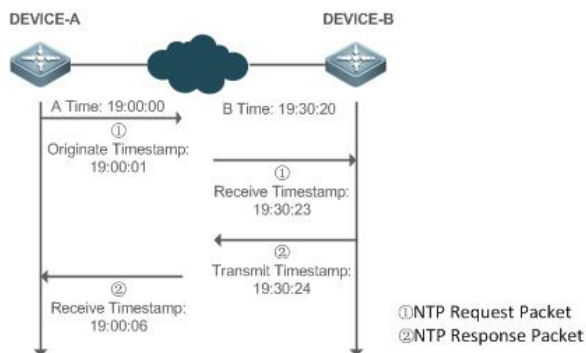

DEVICE-B (B for short) is used as an NTP reference clock source, DEVICE-A (A for short) is used as an NTP client that synchronizes time with DEVICE-B. At a time point, the local clock of A is 19:00:00 and the local clock of B is 19:30:20.

10. A sends an NTP request packet. The local time (T0) when the packet leaves from A is 19:00:00 and is filled in Originate Timestamp.
11. After a 2-second network delay, the local time (T1) when B receives the request packet is 19:30:23 and is filled in Receive Timestamp.
12. B processes the NTP request and sends an NTP response packet one second later. The local time (T2) when the response packet leaves from B is 19:30:24 and is filled in Transmit Timestamp.
13. After a 2-second network delay, A receives the response packet. The local time (T3) when the response packet arrives at A is 19:00:06.

The specific calculations for time synchronization are as follows:

- A obtains the time difference of 30 minutes and 20 seconds between B and A by using the formula $((T1-T0)+(T2-T3))/2$.
- A obtains the packet round-trip delay of four seconds between A and B by using the formula $(T3-T0)-(T2-T1)$.

↘ NTP Working Mode

- External clock reference mode

In this mode, a device is used as both a server and a client. If receiving time synchronization requests from other clients, the device must synchronize time with the specified server first and provide time synchronization for the clients after successful synchronization.

- Local clock reference mode

In this mode, a device uses the default local clock as the reliable clock source and provides time synchronization directly for other clients.

Related Configuration

↘ Configuring an NTP Server

- The NTP function is disabled by default.
- Run the **ntp server** command to specify an NTP server (external clock reference source), which can enable NTP.
- After the configuration, the device works in the external clock reference mode.

↘ Real-time Synchronization

- A device performs time synchronization every 64 seconds by default.

↘ Updating a Hardware Clock

- By default, a device does not update synchronized time to the hardware clock.
- Run the **ntp update-calendar** command to enable a device to automatically update the hardware clock after successfully synchronizing time each time.

↘ Configuring the NTP Master Clock

- By default, a device works in the external clock reference mode.
- Run the **ntp master** command to configure a device to the local clock reference mode.

3.3.2 NTP Security Authentication

To prevent malicious damage on an NTP server, NTP uses the authentication mechanism to check whether the time synchronization information is really from the announced server and check the information return path to provide an anti-interference protection mechanism.

Working Principle

An NTP client and an NTP server are configured with the same key. When sending request and response packets, a device calculates the hash values of the packets by using the MD5 algorithm based on the specified key and NTP packet content, and fills the hash values into the packet authentication information. The receiving device checks whether the packets are sent by a trusted device or modified based on the authentication information.

Related Configuration

▾ Configuring a Global Security Authentication Mechanism for NTP

- By default, no NTP security authentication mechanism is enabled.
- Run the **ntp authenticate** command to enable the NTP security authentication mechanism.

▾ Configuring a Global Authentication Key for NTP

- By default, no global authentication key is configured.
- Run the **ntp authentication-key** command to enable an NTP global authentication key.

▾ Configuring a Globally Trusted Key ID for NTP

- By default, no globally trusted key is configured.
- Run the **ntp trusted-key** command to configure a device as the reference clock source to provide a trusted key for time synchronization externally.

▾ Configuring a Trusted Key ID for an External Reference Clock Source

- Run the **ntp server** command to specify an external reference source and the trusted key of this clock source as well.

3.3.3 NTP Access Control

Working Principle

Provide a minimum security measure by using an ACL.





Related Configuration

▾ Configuring the Access Control Rights for NTP Services

- By default, there is no access control right for NTP.
- Run the **ntp access-group** command to configure the access control rights for NTP.

3.4 Configuration

Configuration	Description and Command
---------------	-------------------------

<u>Configuring Basic Functions of NTP</u>	 (Mandatory) It is used to enable NTP. After NTP is enabled, a device works in the external clock reference mode.	
	ntp server	Configures an NTP server.
	ntp update-calendar	Automatically updates a hardware clock.
	 (Optional) It is used to configure a device to the local clock reference mode.	
	ntp master	Configures the NTP master clock.
	 (Optional) It is used to disable NTP.	
	no ntp	Disables all functions of NTP and clears all NTP configurations.
	ntp disable	Disables receiving of NTP packets from a specified interface.
<u>Configuring NTP Security Authentication</u>	 (Optional) It is used to prevent unreliable clock sources from performing time synchronization interference on a device.	
	ntp authenticate	Enables a security authentication mechanism.
	ntp authentication-key	Configures a global authentication key.
	ntp trusted-key	Configures a trusted key for time synchronization.
	ntp server	Configures a trusted key for an external reference clock source.
<u>Configuring NTP Access Control</u>	 (Optional) It is used to filter the sources of received NTP packets.	
	ntp access-group	Configures the access control rights for NTP.

3.4.1 Configuring Basic Functions of NTP

Configuration Effect

External Clock Reference Mode

- Use a device as a client to synchronize time from an external reference clock source to the local clock.
- After the time synchronization is successful, use the device as a time synchronization server to provide time synchronization.

Local Clock Reference Mode

- Use the local clock of a device as the NTP reference clock source to provide time synchronization.

Notes

- In the client/server mode, a device can be used as a time synchronization server to provide time synchronization only after successfully synchronizing time with a reliable external clock source.
- Once the local clock reference mode is configured, the system will not synchronize time with a clock source with a higher stratum.

- Configuring a local clock as the master clock (especially when specifying a lower stratum) may overwrite an effective clock source. If this command is used for multiple devices in a network, the clock difference between the devices may cause unstable time synchronization of the network.
- Before a local clock is configured as the master clock, if the system never synchronizes time with an external clock source, you may need to manually calibrate the system clock to ensure that there is no excessive difference. For details about how to manually calibrate the system clock, refer to the system time configuration section in the configuration guide.

Configuration Steps

➤ **Configuring an NTP Server**

- (Mandatory) At least one external reference clock source must be specified (A maximum of 20 different external reference clock sources can be configured).
- If it is necessary to configure an NTP key, you must configure NTP security authentication before configuring the NTP server.

➤ **Automatically Updating a Hardware Clock**

- Optional.
- By default, the system updates only the system clock, but not the hardware clock after successful time synchronization.
- After this command is configured, the system automatically updates the hardware clock after successful time synchronization.

➤ **Configuring the NTP Master Clock**

- To switch a device to the local clock reference mode, run this command.

➤ **Disabling NTP**

- To disable NTP and clear NTP configurations, run the **no ntp** command.
- By default, all interfaces can receive NTP packets after NTP is enabled. To disable NTP for a specified interface, run the **ntp disable** command.

➤ **Disabling the NTP Time Synchronization Service**

- NTP works in client/server mode. After the NTP device synchronizes time from an external reliable clock source, it serves as the time server to provide the time synchronization service. If the device just needs to be served as an NTP client, configure the **ntp service disable** command to disable the NTP time synchronization service.

Verification

- Run the **show ntp status** command to display the NTP configuration.
- Run the **show clock** command to check whether time synchronization is completed.

Related Commands

➤ **Configuring an NTP Server**

Command	ntp server [oob vrf vrf-name]{ ip-addr domain ip domain ipv6 domain}[version version] [source if-name] [key keyid][prefer] [via mgmt-name]
Parameter	oob: Indicates whether a reference clock source is bound to the MGMT interface.

Description	<p><i>vrf-name</i>: Indicates the name of the VRF that is bound to the reference clock source.</p> <p><i>ip-addr</i>: Indicates the IPv4/IPv6 address of the reference clock source.</p> <p><i>domain</i>: Indicates the IPv4/IPv6 domain name of the reference clock source.</p> <p><i>version</i>: Indicates the NTP version number, ranging from 1 to 3.</p> <p><i>if-name</i>: Indicates the interface type, including AggregatePort, Dialer GigabitEthernet, Loopback, Multilink, Null, Tunnel, Virtual-ppp, Virtual-template and VLAN.</p> <p><i>keyid</i>: Indicates the key used for communicating with the reference clock source, ranging from 1 to 4294967295.</p> <p>prefer: Indicates whether the reference clock source has a high priority.</p> <p><i>mgmt-name</i>: Specifies the egress management interface for packets in the oob mode.</p>
Command Mode	Global configuration mode
Usage Guide	<p>By default, no NTP server is configured. FS client system supports interaction with up to 20 NTP servers. You can configure an authentication key for each server (after configuring global authentication and the related key) to initiate encrypted communication with the servers.</p> <p> If it is necessary to configure an authentication key, you must configure NTP security authentication before configuring an NTP server.</p> <p>The default version of NTP for communicating with a server is NTP version 3. In addition, you can configure the source interface for transmitting NTP packets and specify that the NTP packets from a corresponding server can be received only on the transmitting interface.</p>

📌 **Updating a Hardware Clock**

Command	ntp update-calendar
Parameter Description	N/A
Command Mode	Global configuration mode
Usage Guide	N/A

📌 **Configuring a Local Reference Clock Source**

Command	ntp master [stratum]
Parameter Description	<i>stratum</i> : specifies the stratum of a local clock, ranging from 1 to 15. The default value is 8.
Command Mode	Global configuration mode
Usage Guide	N/A

📌 **Disabling NTP**

Command	no ntp
Parameter Description	N/A
Command Mode	Global configuration mode
Usage Guide	This command can be used to fast disable all functions of NTP and clear all NTP configurations.

📌 **Disabling Receiving of NTP Packets on an Interface**

Command	ntp disable
Parameter	N/A
Description	
Command Mode	Interface configuration mode
Usage Guide	N/A

📌 **Disabling the Time Synchronization Service Provided by NTP**

Command	ntp service disable
Parameter	N/A
Description	
Command Mode	Global configuration mode
Usage Guide	This command disables the NTP time synchronization service. After this command is configured, external devices cannot be synchronized time from the NTP device (this command is supported only in some versions).

Configuration Example

📌 **External Clock Reference Mode of NTP**

Scenario	
Figure 3-5	
	<ul style="list-style-type: none"> ● DEVICE-B is configured to the NTP external clock reference mode. ● DEVICE-A is used as the reference clock source of DEVICE-B. ● DEVICE-C synchronizes time with DEVICE-B.
Configuration Steps	<ul style="list-style-type: none"> ● DEVICE-A configures the local clock as the NTP reference clock source. ● DEVICE-B configures DEVICE-A as the reference clock source. ● DEVICE-C configures DEVICE-B as the reference clock source.
DEVICE-A	<pre>A#configure terminal A(config)# ntp master A(config)#exit</pre>
DEVICE-B	<pre>B#configure terminal B(config)# ntp server 192.168.1.1 B(config)# exit</pre>
DEVICE-C	<pre>C#configure terminal</pre>

	<pre>C(config)# ntp server 192.168.2.1 C(config)# exit</pre>
Verification	<ul style="list-style-type: none"> ● Run the show ntp status command on DEVICE-B to display the NTP configuration. ● DEVICE-B sends a time synchronization packet to 192.168.1.1 in order to synchronize time with DEVICE-A. ● After successfully synchronizing time with DEVICE-A, DEVICE-B can respond to the time synchronization request from DEVICE-C. ● Run the show clock command on DEVICE-B and DEVICE-C to check whether the time synchronization is successful.

📌 **Local Clock Reference Mode of NTP**

Scenario Figure 3-6	
	<ul style="list-style-type: none"> ● DEVICE-B configures the local clock as the NTP reference clock source. ● DEVICE-C synchronizes time with DEVICE-B.
Configuration Steps	<ul style="list-style-type: none"> ● DEVICE-B configures the local clock as the NTP reference clock source. ● DEVICE-C configures DEVICE-B as the reference clock source.
DEVICE-B	<pre>B#configure terminal B(config)# ntp master B(config)# exit</pre>
DEVICE-C	<pre>C#configure terminal C(config)# ntp server 192.168.2.1 C(config)# exit</pre>
Verification	<ul style="list-style-type: none"> ● Run the show clock command on DEVICE-C to check whether the time synchronization is successful.

3.4.2 Configuring NTP Security Authentication

Configuration Effect

📌 **Synchronizing Time from a Trusted Reference Clock Source**

Use a device as a client to synchronize time only from a trusted external reference clock source to the local clock.

📌 **Providing Time Synchronization for a Trusted Device**

Use the local clock of a device as the NTP reference clock source to provide time synchronization for only a trusted device.

Notes

The authentication keys of the client and server must be the same.

Configuration Steps

➤ **Configuring a Global Security Authentication Mechanism for NTP**

- Mandatory.
- By default, a device disables the security authentication mechanism.

➤ **Configuring a Global Authentication Key for NTP**

- Mandatory.
- By default, a device is not configured with an authentication key.

➤ **Configuring a Globally Trusted Key ID for NTP**

- Optional.
- To provide time synchronization for a trusted device, you must specify a trusted authentication key by using the key ID.
- Only one trusted key can be configured. The specified authentication key must be consistent with that of the trusted device.

➤ **Configuring an Authentication Key ID for an External Reference Clock Source**

- Optional.
- To synchronize time with a trusted reference clock source, you must specify a trusted authentication key by using the key ID.
- Each trusted reference clock source is mapped to an authentication key. The authentication keys must be consistent with the keys of trusted reference clock sources.

Verification

- Run the **show run** command to verify the NTP configuration.
- Run the **show clock** command to check whether time is synchronized only with a trusted device.

Related Commands

➤ **Enabling a Security Authentication Mechanism**

Command	ntp authenticate
Parameter	N/A
Description	
Command Mode	Global configuration mode
Usage Guide	By default, a client does not use a global security authentication mechanism. If no security authentication mechanism is used, communication will not be encrypted. A global security indicator is not enough to imply that the communication between the client and server is implemented in an encrypted manner. Other global keys and an encryption key for the server must also be configured for initiating encrypted communication between the client and server.

➤ **Configuring a Global Authentication Key**

Command	ntp authentication-key <i>key-id</i> md5 <i>key-string</i> [<i>enc-type</i>]
Parameter	<i>key-id</i> : indicates the ID of a global authentication key, ranging from 1 to 4294967295.
Description	<i>key-string</i> : indicates a key string. <i>enc-type</i> : (optional) indicates whether an entered key is encrypted. 0 indicates no encryption, and 7 indicates simple

	encryption. The default setting is no encryption.
Command	Global configuration mode
Mode	
Usage Guide	N/A

📌 **Configuring a Trusted Key for NTP**

Command	ntp trusted-key <i>key-id</i>
Parameter	<i>key-id</i> : Indicates the ID of a trusted key, ranging from 1 to 4294967295.
Description	
Command	Global configuration mode
Mode	
Usage Guide	N/A

📌 **Configuring a Trusted Key for an External Reference Clock Source**

Refer to the section "Related Commands".

Configuration Example

📌 **Security Authentication**

Scenario Figure 3-7	
	<ul style="list-style-type: none"> ● DEVICE-B is configured to the NTP client/server mode and provides NTP services requiring security authentication for DEVICE-C. The authentication key is "abcd". ● DEVICE-A is used as the reference clock source of DEVICE-B. ● DEVICE-C synchronizes time with DEVICE-B.
Configuration Steps	<ul style="list-style-type: none"> ● DEVICE-B configures DEVICE-A as the reference clock source. ● DEVICE-C configures DEVICE-B as the reference clock source.
DEVICE-B	<pre>B#configure terminal B(config)# ntp authentication-key 1 md5 abcd B(config)# ntp trusted-key 1 B(config)# ntp server 192.168.1.1 B(config)# exit</pre>
DEVICE-C	<pre>C#configure terminal C(config)# ntp authentication-key 1 md5 abcd C(config)# ntp server 192.168.2.1 key 1 C(config)# exit</pre>
Verification	<ul style="list-style-type: none"> ● DEVICE-B sends a time synchronization packet that carries authentication information to 192.168.1.1 in order to synchronize time with DEVICE-A.

- Run the **show clock** command on DEVICE-B to check whether the time synchronization is successful.

3.4.3 Configuring NTP Access Control

Configuration Effect

Access control for NTP services provides a minimum security measure. A more secure method is to use an NTP authentication mechanism.

Notes

- Currently, the system does not support control query (used to control NTP servers by using network management devices, such as setting the leap second indicator or monitoring its working status). Though rule matching is implemented in the preceding sequence, no request related to control query is supported.
- If no access control rule is configured, all accesses are allowed. If any access control rule is configured, only accesses allowed by the rule can be implemented.

Related Configuration

▾ Configuring the Access Control Rights for NTP

- Optional.
- Run the **ntp access-group** command to configure the access control rights and a corresponding ACL for NTP.

Verification

Run the **show run** command to verify the NTP configuration.

Related Commands

▾ Configuring the Access Control Rights for NTP Services

Command	ntp access-group { peer serve serve-only query-only } <i>access-list-number</i> <i>access-list-name</i>
Parameter Description	<p>peer: allows time request and control query for local NTP services, and allows a local device to synchronize time with a remote system (full access rights).</p> <p>serve: allows time request and control query for local NTP services, but does not allow a local device to synchronize time with a remote system.</p> <p>serve-only: allows only time request for local NTP services.</p> <p>query-only: allows only control query for local NTP services.</p> <p><i>access-list-number</i>: indicates the number of an IP ACL, ranging from 1 to 99 and from 1300 to 1999. For details about how to create an IP ACL, refer to the <i>Configuring ACL</i>.</p> <p><i>access-list-name</i>: indicates the name of an IP ACL. For details about how to create an IP ACL, refer to the <i>Configuring ACL</i>.</p>
Command Mode	Global configuration mode
Usage Guide	<p>Configure NTP access control rights.</p> <p>When an access request arrives, the NTP service matches rules in the sequence from the minimum access restriction to the maximum access restriction and uses the first matched rule. The matching sequence is peer, serve, serve-only,</p>

	and query-only.
--	-----------------

Configuration Example

↘ **Configuring NTP Access Control Rights**

Configuration Steps	Allow only the device with the IP address of 192.168.1.1 to send a time synchronization request to a local device.
	<pre>FS(config)# access-list 1 permit 192.168.1.1 FS(config)# ntp access-group serve-only 1</pre>

3.5 Monitoring

Displaying

Description	Command
show ntp status	Displays the current NTP information.

Debugging

System resources are occupied when debugging information is output. Therefore, disable debugging immediately after use.

Description	Command
debug ntp	Enables debugging.
no debug ntp	Disables debugging.

4 Configuring SNTP

4.1 Overview

The Simple Network Time Protocol (SNTP) is a simplified version of Network Time Protocol (NTP), which is used to synchronize the clocks of computers on the Internet. SNTP is applied in scenarios where it is unnecessary to use all NTP functions.

NTP uses a complex algorithm and has higher requirements for the system whereas SNTP uses a simpler algorithm and provides higher performance. Generally, SNTP precision can reach about 1s, which meets the basic requirements of most scenarios. Since SNTP packets are the same as NTP packets, the SNTP client implemented on a device is fully compatible with an NTP server.

Protocols and Standards

- RFC 2030: Simple Network Time Protocol (SNTP) Version 4 for IPv4, IPv6 and OSI

4.2 Applications

Application	Description
<u>Synchronizing Time with an NTP Server</u>	A device is used as a client to synchronize time with an NTP server.

4.2.1 Synchronizing Time with an NTP Server

Scenario

As shown in Figure 4-1, DEVICE-B uses a local clock as the NTP clock reference source and provides time synchronization for DEVICE-C. DEVICE-C is used as an SNTP client to synchronize time with DEVICE-B.

Figure 4-1



Deployment

- Specify DEVICE-B as the SNTP server of DEVICE-C.
- Enable SNTP for DEVICE-C.

4.3 Features

Basic Concepts

SNTP Packet

SNTPV4 is developed from NTP, which is intended to simplify the functions of NTP. It does not change the NTP specifications and the original implementation of NTP. The message format of SNTPV4 is the same as that of NTP defined in RFC1305, with only some data fields initialized into preset values.

As defined in RFC1305, SNTP uses User Datagram Protocol (UDP) packets for transmission and the used UDP port ID is 123.

Figure 4-2 shows the format of an SNTP time synchronization packet.

Figure 4-2 Format of an SNTP Time Synchronization Packet

0	7	15	23	31
LI	VN	Mode	Stratum	Poll Interval
Precision				
Root Delay (32-bit)				
Root Dispersion (32-bit)				
Reference Clock Identifier (32-bit)				
Reference Timestamp (64-bit)				
Originate Timestamp (64-bit)				
Receive Timestamp (64-bit)				
Transmit Timestamp (64-bit)				
Authenticator (optional 96-bit)				

- Leap Indicator(LI): indicates a 2-bit leap second indicator.

- **i** 00: indicates no warning information; 01: indicates that there are 61 seconds in the previous minute; 10: indicates that there are 59 seconds in the previous minute; 11: indicates that the clock is not synchronized.
- Version Number(VN): indicates a 3-bit NTP/SNTP version number. The current version number is 3.
- Mode: indicates a 3-bit SNTP/NTP working mode.
- **i** 0: indicates no definition; 1: indicates symmetric active; 2: indicates symmetric passive; 3: indicates a client; 4: indicates a server; 5: indicates broadcasting; 6: indicates control information; 7: reserved.
- Stratum: indicates the 8-bit stratum of a local clock. 0: indicates no definition; 1: indicates the master clock reference source; other values: indicate slave clock reference sources.
- Poll Interval: indicates the poll interval (seconds), which is a 8-bit integer.
- Precision: indicates the time precision (seconds) of a local clock, which is a 8-bit integer.
- Root Delay: indicates the round-trip time to the master clock reference source, which is a 32-bit integer.
- Root Dispersion: indicates the largest difference from the master reference clock source, which is a 32-bit integer.
- Reference Clock Identifier: indicates the 32-bit identifier of a reference clock source.
- Reference Timestamp: indicates a 64-bit timestamp, namely, the time that is set or corrected at the last time.
- Originate Timestamp: indicates a 64-bit timestamp, namely, the local time when a time synchronization request leaves from a client.
- Receive Timestamp: indicates a 64-bit timestamp, namely, the local time when a time synchronization request packet arrives at a server.
- Transmit Timestamp: indicates a 64-bit timestamp, namely, the local time when a time synchronization response packet leaves from a server.
- Authenticator (optional): indicates authentication information.

Overview

Feature	Description
SNTP Time Synchronization	Synchronizes time from an SNTP/NTP server to a local device.

4.3.1SNTP Time Synchronization

Working Principle

SNTP time synchronization is implemented by interaction of SNTP/NTP packets between a client and a server. The client sends a time synchronization packet to the server at intervals (half an hour by default). After receiving a response packet from the server, the client synchronizes time.

Figure 4-3 shows the format of an SNTP time synchronization packet.

Figure 4-3 Working Principle of SNTP

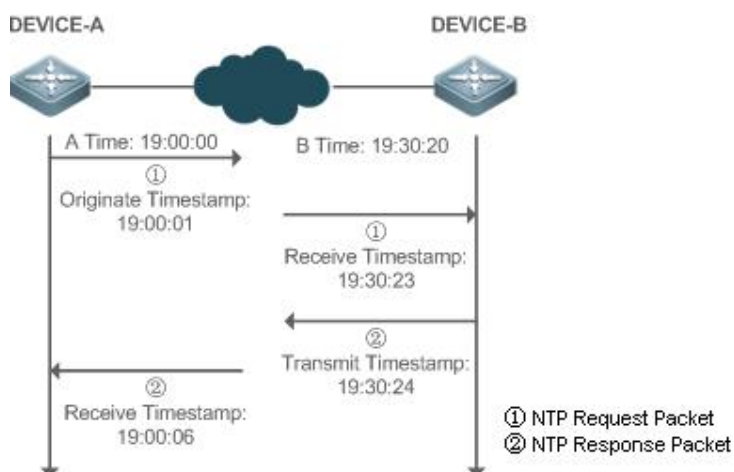

DEVICE-B (B for short) is used as an NTP reference clock source, DEVICE-A (A for short) is used as an SNTP client that synchronizes time with DEVICE-B. At a time point, the local clock of A is 19:00:00 and the local clock of B is 19:30:20.

14. A sends an SNTP/NTP request packet. The local time (T_0) when the packet leaves from A is 19:00:00 and is filled in Originate Timestamp.
15. After a 2-second network delay, the local time (T_1) when B receives the request packet is 19:30:23 and is filled in Receive Timestamp.
16. B processes the NTP request and sends an NTP response packet one second later. The local time (T_2) when the response packet leaves from B is 19:30:24 and is filled in Transmit Timestamp.
17. After a 2-second network delay, A receives the response packet. The local time (T_3) when the response packet arrives at A is 19:00:06.

The specific calculations for time synchronization are as follows:

- A obtains the time difference of 30 minutes and 20 seconds between B and A by using the formula $((T_1 - T_0) + (T_2 - T_3)) / 2$.
- A obtains the packet round-trip delay of four seconds between A and B by using the formula $(T_3 - T_0) - (T_2 - T_1)$.

Related Configuration

▾ Enabling SNTP

- SNTP is disabled by default.
- Run the **sntp enable** command to enable SNTP.

▾ Configuring an SNTP Server

- By default, no SNTP server is configured.
- Run the **sntp server** command to specify an SNTP server.

▾ Configuring the SNTP Time Synchronization Interval

- By default, the SNTP time synchronization interval is 1,800s.
- Run the **sntp interval** command to specify the time synchronization interval.

4.4 Configuration

Configuration	Description and Command	
Configuring SNTP	(Mandatory) It is used to enable SNTP.	
	sntp enable	Enables SNTP.
	sntp server	Configures the IP address of an SNTP server.
	(Optional) It is used to configure the SNTP time synchronization interval.	
	sntp interval	Configures the SNTP time synchronization interval.

4.4.1 Configuring SNTP

Configuration Effect

An SNTP client accesses an NTP server at fixed intervals to correct the clock regularly.

Notes

All time obtained through SNTP communication is Greenwich Mean Time (GMT). To obtain precise local time, you need to set the local time zone for alignment with GMT.

Configuration Steps

➤ Enabling SNTP

- (Mandatory) SNTP is disabled by default.

➤ Configuring the IP address of an SNTP Server

- (Mandatory) No SNTP/NTP server is configured by default.

➤ Configuring the SNTP Time Synchronization Interval

- Optional.
- By default, a device synchronizes time every half an hour.

Verification

Run the **show sntp** command to display SNTP-related parameters.

Related Commands

➤ Enabling SNTP

Command	sntp enable
Parameter	N/A
Description	
Command Mode	Global configuration mode
Usage Guide	SNTP is disabled by default.

	Run the no sntp enable global configuration command to disable SNTP.
--	---

📌 **Configuring the IP address of an SNTP/NTP Server**

Command	sntp server [oob] ip-address [via mgmt-name]
Parameter Description	<i>ip-address</i> : indicates the IP address of an NTP/SNTP server. No NTP/SNTP server is configured by default.
	oob : indicates that the NTP/SNTP server supports an out-band management interface (interface of mgmt). <i>mgmt-name</i> : Specifies the egress management interface for packets in the oob mode.
Command Mode	Global configuration mode
Usage Guide	Since SNTP is fully compatible with NTP, the server can be configured as a public NTP server on the Internet. Since SNTP packets are the same as NTP packets, the SNTP client is fully compatible with the NTP server. There are many NTP servers on the Internet. You can select an NTP server with a shorter delay as the SNTP server on your device.

📌 **Configuring the SNTP Time Synchronization Interval**

Command	sntp interval seconds
Parameter Description	<i>seconds</i> : Indicates the time synchronization interval, ranging from 60s to 65,535s. The default value is 1,800s.
Command Mode	Global configuration mode
Usage Guide	Run this command to set the interval for an SNTP client to synchronize time with an NTP/SNTP server. The interval configured here does not take effect immediately. To make it take effect immediately, run the sntp enable command.

Configuration Example

📌 **SNTP Time Synchronization**

Scenario Figure 4-4	
	<ul style="list-style-type: none"> ● DEVICE-B indicates an NTP server on the Internet. ● DEVICE-C synchronizes time with DEVICE-B.
Configuration Steps	Enable SNTP for DEVICE-C and configure DEVICE-B as an NTP server.
DEVICE-C	<pre>C#configure terminal C(config)# sntp server 192.168.2.1 C(config)# sntp enable C(config)# exit</pre>
Verification	<ul style="list-style-type: none"> ● Run the show clock command on DEVICE-C to check whether the time synchronization is successful. ● Run the show sntp command on DEVICE-C to display the SNTP status and check whether the server is

successfully configured.

4.5 Monitoring

Displaying

Description	Command
show sntp	Displays SNTP-related parameters.

Debugging



System resources are occupied when debugging information is output. Therefore, disable debugging immediately after use.

Description	Command
debug sntp	Enables debugging.

5 Configuring SPAN-RSPAN

5.1 Overview

The Switched Port Analyzer (SPAN) is to copy packets of a specified port to another switch port that is connected to a network monitoring device, so as to achieve network monitoring and troubleshooting.

All input and output packets of a source port can be monitored through SPAN. For example, as shown in the following figure, all packets on Port 5 are mapped to Port 10, and the network analyzer connected to Port 10 receives all packets that pass through Port 5.

Figure 5-1 SPAN Configuration Instance

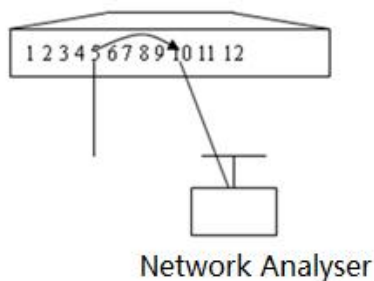

The SPAN function is mainly applied in network monitoring and troubleshooting scenarios, to monitor network information and rectify network faults.

The Remote SPAN (RSPAN), an extension to SPAN, is capable of remotely monitoring multiple devices. Each RSPAN session is established in a specified remote VLAN. RSPAN breaks through the limitation that a mirrored port and a mirroring port must reside on the same device, and allows a mirrored port to be several network devices away from a mirroring port. Users can observe data packets of the remote mirrored port by using an analyzer in the central equipment room.

The application scenarios of RSPAN are similar to those of SPAN. RSPAN allows users to conduct real-time data monitoring without staying in the equipment room, providing great convenience for users.

VLAN SPAN (VSPAN) considers data streams of some VLANs as data sources and mirrors them to a destination port. The configuration is similar to that of the port-based SPAN. VSPAN has the following features:

- A VLAN that is not a remote VLAN can be specified as the data source of VSPAN.
- Some VLANs that are not remote VLANs can be specified as the data sources of VSPAN.
- When a VLAN is configured as a data source, packets only in the Rx direction can be mirrored.

5.2 Applications

Application	Description
<u>Stream-based SPAN</u>	Data streams with certain characteristics need to be monitored, for example, data streams using a specified access control list (ACL) policy need to be monitored.
<u>One-to-Many RSPAN</u>	Multiple users need to monitor data of the same port.
<u>RSPAN Basic Applications</u>	Packets on the mirroring source device need to be mirrored to the destination device for monitoring.

5.2.1 Stream-based SPAN

Scenario

As shown in the following figure, the network analyzer can be configured to can monitor all data streams forwarded by Switch A to Switch B and specific data streams of Switch B (for example, data streams from PC1 and PC2).

Figure 5-2 SPAN Simple Application Topology

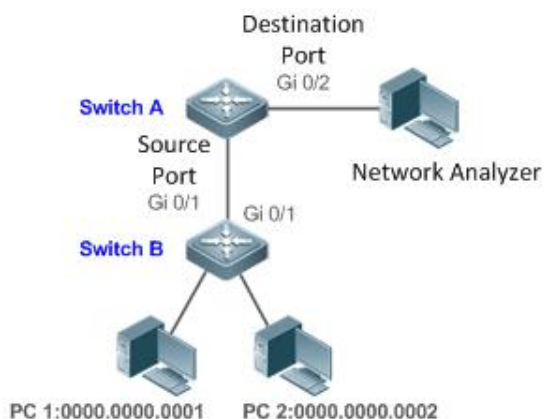

Remarks 0000.0000.0001 is the MAC address of PC1.
0000.0000.0002 is the MAC address of PC2.

Deployment

- In the preceding figure, configure the SPAN function on Switch A connected to the network analyzer, set port Gi 0/1 connected to Switch B as the SPAN source port, and set port Gi 0/2 that is directly connected to the network analyzer as the SPAN destination port.
- Configure stream-based SPAN (only data streams of PC1 and PC2 are allowed) for the source port Gi 0/1 of SPAN.

5.2.2 One-to-Many RSPAN

Scenario

As shown in the following figure, one-to-many RSPAN can be implemented on a single device, that is, both PC 1 and PC 2 can be configured to monitor the transmitted and received traffic of the port connected to the server. Users can make proper configuration (for example, remote VLAN and port MAC loopback) to monitor data streams that pass through port Gi 4/1 on PC 1 and PC 2, thereby monitoring data streams of the server.

Figure 5-3 Application Topology of One-to-Many RSPAN

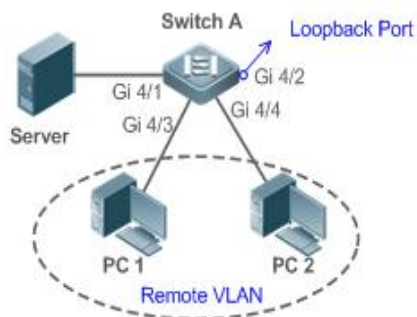

Deployment

- Create a remote VLAN on Switch A.
- Configure Switch A as the source device of RSPAN and configure the port Gi 4/1 that is directly connected to the server as the RSPAN source port. Select a port that is in the Down state, Gi 4/2 in this example, as the RSPAN output port, add this port to the remote VLAN, and configure MAC loopback (run the **mac-loopback** command in interface configuration mode).
- Add ports that are directly connected to PC 1 and PC 2 to the remote VLAN.
- **i** Run the **mac-loopback remove-itag** command if removal of the inner VLAN tag in the input direction of the loopback port is needed.

5.2.3 RSPAN Basic Applications

Scenario

As shown in the following figure, the RSPAN function enables the network analyzer to monitor the STA connected to the source device Switch A from the destination device Switch C through the intermediate device Switch B. The devices can normally exchange data with each other.

Figure 5-4 Basic Application Topology of RSPAN

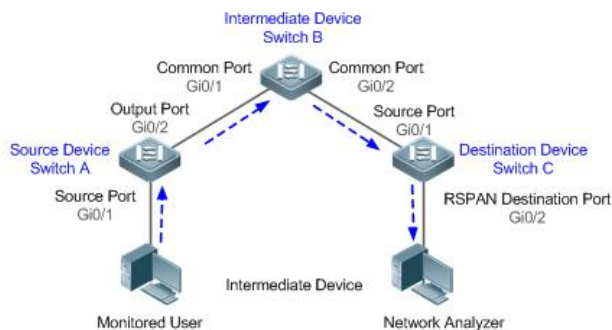

Deployment

- Configure a remote VLAN on Switch A, Switch B, and Switch C.
- On Switch A, configure port Gi 0/1 directly connected to the STA as the source port, configure port Gi 0/2 connected to Switch B as the output port, and configure the switching function for the output port.
- On Switch B, configure port Gi 0/1 connected to Switch A and port Gi 0/2 connected to Switch C as common ports.
- On Switch C, configure port Gi0/1 connected to Switch B as a common source port, configure port Gi 0/2 connected to the network analyzer as the RSPAN destination port, and configure the switching function for the RSPAN destination port.

5.3 Features

Basic Concepts

▾ SPAN Session

A SPAN session is data streams between the SPAN source port and the destination port, which can be used to monitor the packets of one or more ports in the input, output, or both directions. Switched ports, routed ports, and aggregate ports (APs) can be configured as source ports or destination ports of SPAN sessions. Normal operations on a switch are not affected after ports of the switch are added to a SPAN session.

Users can configure a SPAN session on a disabled port but the SPAN session is inactive. A SPAN session is in the active state only after the port on which the SPAN session is configured is enabled. In addition, a SPAN session does not take effect after a switch is powered on. It is active only after the destination port is in the operational state. Users can run the **show monitor [session session-num]** command to display the operation status of a SPAN session.

▾ SPAN Data Streams

A SPAN session covers data streams in three directions:

- **Input data streams:** All packets received by a source port are copied to the destination port. Users can monitor input packets of one or more source ports in a SPAN session. Some input packets of a source port may be discarded for some reasons (for example, for the sake of port security). It does not affect the SPAN function and such packets are still mirrored to the destination port.
- **Output data streams:** All packets transmitted by a source port are copied to the destination port. Users can monitor output packets of one or more source ports in a SPAN session. Packets transmitted from other ports to a source port may be discarded for some reasons and such packets will not be transmitted to the destination port. The format of output packets of a source port may be changed for some reasons. For example, after routing, packets transmitted from the source port are changed in source

MAC addresses, destination MAC addresses, VLAN IDs, and TTLs, and their formats are also changed after copied to the destination port.

- Bidirectional data streams: Bidirectional data streams include input data streams and output data streams. In a SPAN session, users can monitor data streams of one or more source ports in the input and output directions.

📌 Source Port

A source port is called a monitored port. In a SPAN session, data streams of the source port are monitored for network analysis and troubleshooting. In a single SPAN session, users can monitor the input, output, and bidirectional data streams, and the number of source ports is not restricted.

A source port has the following features:

- A source port can be a switched port, routed port, or AP.
- A source port cannot be used as a destination port simultaneously.
- A source port and a destination port can belong to the same VLAN or different VLANs.

📌 Destination Port

A SPAN session has one destination port (called a monitoring port) for receiving packets copied from a source port.

A destination port has the following features:

- A destination port can be a switched port, routed port, or AP.
- A destination port cannot be used as a source port simultaneously.

Overview

Feature	Description
SPAN	Configures mirroring of ports on the same device.
RSPAN	Configures mirroring of ports on different devices.

5.3.1 SPAN

SPAN is used to monitor data streams on switches. It copies frames on one port to another switch port that is connected to a network analyzer or RMON analyzer so as to analyze the communication of the port.

Working Principle

When a port transmits or receive packets, SPAN, after checking that the port is configured as a SPAN source port, copies the packets transmitted and received by the port to the destination port.

📌 Configuring a SPAN Source Port

Users need to specify a SPAN session ID and source port ID to configure a SPAN source port, and set the optional SPAN direction item to determine the direction of SPAN data streams or specify an ACL policy to mirror specific data streams.

📌 Configuring a SPAN Destination Port

Users need to specify a SPAN session ID and destination port ID to configure a SPAN destination port, and set the optional switching function item to determine whether to enable the switching function and tag removal function on the SPAN destination port.

Related Configuration

The SPAN function is disabled by default. It is enabled only after a session is created, and the SPAN source and destination ports are configured. A SPAN session can be created when a SPAN source port or destination port is configured.

📌 Configuring a SPAN Source Port

A SPAN session does not have a SPAN source port by default. Users can run the following command to configure a SPAN source port:

```
monitor session session-num source interface interface-id [ both | rx | tx ] [ acl name ]
```

In the preceding command:

session-num: Indicates the SPAN session ID. The number of supported SPAN sessions varies with products.

interface-id: Indicates the SPAN source port to be configured.

rx: Indicates that only packets received by the source port are monitored after **rx** is configured.

tx: Indicates that only packets transmitted by the source port are monitored after **tx** is configured.

both: Indicates that packets transmitted and received by the source port are copied to the destination port for monitoring after **both** is configured, that is, **both** includes **rx** and **tx**. If none of **rx**, **tx**, and **both** is selected, **both** is enabled by default.

acl: Specifies an ACL policy. After this option is configured, packets allowed by the ACL policy on the source port are monitored. This function is disabled by default.

📌 Configuring a SPAN Destination Port

A SPAN session does not have a SPAN destination port by default. Users can run the following command to configure a SPAN destination port:

```
monitor session session-num destination interface interface-id [switch ]
```

In the preceding command:





switch: Indicates that the SPAN destination port only receives packets mirrored from the SPAN source port and discards other packets if this option is disabled, and receives both packets mirrored from the SPAN source port and packets from non-source ports if this option is enabled, that is, the communication between this destination port and other devices is not affected.

When the SPAN destination port is configured, the relevant function is disabled by default if **switch** is not configured.

📌 Configuring Stream-based SPAN

This function is disabled by default. Users can run the **monitor session** *session-num* **source interface** *interface-id* **rxacl** *acl-name* command to configure stream-based SPAN.

Pay attention to the following points when using SPAN:

-  The SPAN destination port is used for the Spanning Tree Protocol (STP) calculation.
-  SPAN is unavailable if a source port or destination port is disabled.
-  If a VLAN (or VLAN list) is used as a SPAN source, ensure that the destination port has sufficient bandwidth for receiving mirrored data of the VLAN (or VLAN list).
-  Not all products support all options of the preceding commands because of product differences.

5.3.2RSPAN

RSPAN is capable of monitoring multiple devices. Each RSPAN session is established in a specified remote VLAN. RSPAN breaks through the limitation that a mirrored port and a mirroring port must reside on the same device, and allows a mirrored port to be several network devices away from a mirroring port.

Working Principle

A remote VLAN is created for the source device, intermediate device, and destination device, all ports involved in an RSPAN session need to be added to the remote VLAN. Mirrored packets are broadcasted in the remote VLAN so that they are transmitted from the source port of the source switch to the destination port of the destination switch.

📌 Configuring a Remote VLAN

Packets from an RSPAN source port are broadcasted in a remote VLAN so as to be copied from the local switch to the remote switch. The RSPAN source port, output port, reflection port, transparent transmission ports of the intermediate device (packet input port and output port of the intermediate device), destination port and input port of the destination port must be added to the remote VLAN. The RSPAN function requires configuring a VLAN as a remote VLAN in VLAN mode. The remote VLAN configuration in the loopback topology will become invalid after the VLAN interface is created.

📌 Configuring an RSPAN Session

The configuration of the RSPAN source port and destination port are similar to that of the SPAN source port and destination port, but the mirroring session ID specified during configuration must be the ID of an RSPAN session.

📌 Configuring an RSPAN Source Port

The configuration of an RSPAN source port is the same as that of a SPAN source port, but the specified mirroring session ID must be the ID of an RSPAN session.

📌 Configuring an RSPAN Output Port

The output port is located on the source device and must be added to a remote VLAN. Mirrored packets of a source port are broadcasted in this remote VLAN. The source device transmits packets to the intermediate switch or destination switch through the output port.

📌 Configuring an RSPAN Destination Port

When an RSPAN destination port is configured, an RSPAN session ID, remote VLAN, and port name must be specified so that packets from the source port are copied to the destination port through the remote VLAN.

📌 Configuring Stream-based RSPAN

RSPAN is an extension to SPAN and also supports stream-based mirroring. The configuration is the same as that of stream-based SPAN. Stream-based RSPAN does not affect normal communication.

Users can configure an ACL in the input direction of a source port on an RSPAN source device. Standard ACLs, extended ACLs, MAC ACLs, and user-defined ACLs are supported.

Users can configure a port ACL in the input direction of a source port on an RSPAN source device, and configure a port ACL in the output direction of the destination port on the RSPAN destination device. Users can also configure an ACL in the output direction of a remote VLAN on an RSPAN source switch and configure an ACL in the input direction of the remote VLAN on the RSPAN destination switch.

➤ **Configuring One-to-Many RSPAN**

If data streams of one source port need to be mirrored to multiple destination ports, users can configure an RSPAN session, configure the source port of the RSPAN session as a one-to-many mirroring source port and select another Ethernet port as the forwarding port (output port on the source device). In addition, the MAC loopback function needs to be configured on the RSPAN forwarding port in interface configuration mode, the expected RSPAN output port and RSPAN forwarding port need to be added to the remote VLAN. Then, mirrored packets are looped back on the RSPAN forwarding port and then broadcasted in the remote VLAN, thereby implementing one-to-many RSPAN.

Related Configuration

The RSPAN function is disabled by default. It is enabled only after an RSPAN session is created, and a remote VLAN, RSPAN source port, and RSPAN destination port are configured.

➤ **Configuring a Remote VLAN**

No remote VLAN is specified for RSPAN by default. Users can run the **remote-span** command in VLAN mode to configure a VLAN as a remote VLAN. One remote VLAN corresponds to one RSPAN session.

➤ **Configuring an RSPAN Source Device**

This function is disabled by default. Users can run the **monitor session session-num remote-source** command in global configuration mode to configure a device as the remote source device of a specified RSPAN session.

➤ **Configuring an RSPAN Destination Device**

This function is disabled by default. Users can run the **monitor session session-num remote-destination** command in global configuration mode to configure a device as the remote destination device of a specified RSPAN session.

➤ **Configuring an RSPAN Source Port**

A source port of an RSPAN session is configured on the source device. The configuration is the same as that of a SPAN source port but an RSPAN session ID needs to be specified. This function is disabled by default.

➤ **Configuring an Output Port on the RSPAN Source Device**

This function is disabled by default. Users can run the **monitor session session-num destination remote vlan remote-vlan interface interface-name [switch]** command in global configuration mode to configure an output port on the RSPAN source device. If the option **switch** is configured, the output port can participate in normal data packet switching. It is not configured by default. The output port must be added to a remote VLAN.

➤ **Configuring a Destination Port on the RSPAN Destination Device**

This function is disabled by default. Users can run the **monitor session session-num destination remote vlan remote-vlan interface interface-name [switch]** command in global configuration mode to configure a destination port on the RSPAN destination device. If the option **switch** is configured, the destination port can participate in normal data packet switching. It is not configured by default. The destination port must be added to a remote VLAN.



Pay attention to the following points when using RSPAN:



A remote VLAN must be configured on each device, their VLAN IDs must be consistent, and all ports that participate in a session must be added to the VLAN.



It is not recommended that common ports be added to a remote VLAN.

Do not configure a port that is connected to an intermediate switch or destination switch as an RSPAN source port. Otherwise, traffic on the network may be in chaos.

5.4 Configuration

Configuration	Description and Command	
Configuring SPAN Basic Functions	(Mandatory) It is used to create SPAN.	
	monitor session <i>session-num</i> source interface <i>interface-id</i> [both rx tx]	Configures a SPAN source port.
	monitor session <i>session-num</i> destination interface <i>interface-id</i> [switch]	Configures a SPAN destination port.
	monitor session <i>session-num</i> source interface <i>interface-id</i> rxacl <i>acl-name</i>	Configures stream-based SPAN.
	monitor session <i>session-num</i> source vlan <i>vlan-id</i> [rx]	Specifies a VLAN as the data source of SPAN.
	monitor session <i>session-num</i> filter vlan <i>vlan-id-list</i> [rx tx both]	Specifies some VLANs as the data sources of SPAN.
Configuring RSPAN Basic Functions	(Mandatory) It is used to create RSPAN.	
	monitor session <i>session-num</i> remote-source	Configures an RSPAN session ID and specifies a source device.
	monitor session <i>session-num</i> remote-destination	Configures an RSPAN session ID and specifies a destination device.
	remote-span	Configures a remote VLAN.
	monitor session <i>session-num</i> source interface <i>interface-id</i> [both rx tx]	Configures an RSPAN source port.
	monitor session <i>session-num</i> destination remote vlan <i>remote-vlan-id</i> interface <i>interface-id</i> [switch]	Configures an output port on the RSPAN source device or a destination port on the RSPAN destination device.

5.4.1 Configuring SPAN Basic Functions

Configuration Effect

- Configure a source and destination ports for a SPAN session.
- Configure a destination port to monitor any packets transmitted and received by a source port.

Notes

- If the switch function is disabled on a SPAN destination port, the destination port receives only mirrored packets and discards other packets that pass through the port. After the switch function is enabled, the destination port can receive non-mirrored packets.

Configuration Steps

↘ Configuring a SPAN Session

- Global configuration mode. Mandatory.
- You can configure a SPAN session when configuring a SPAN source port or destination port, or when configuring a specified VLAN or some VLANs as a data source or data sources of SPAN.

↘ Configuring a SPAN Source Port

- Global configuration mode. Mandatory.
- You can select the SPAN direction when configuring a SPAN source port. The **both** direction is configured by default, that is, both transmitted and received packets are monitored.

↘ Configuring a SPAN Destination Port

Global configuration mode. Mandatory.

A SPAN session is active only when a SPAN source port is configured (or a VLAN is specified as the data source of SPAN) and a SPAN destination port is configured.

Verification

- Run the **show monitor** command or the **show running** command to verify the SPAN configuration. Alternatively, conduct packet capture analysis on the SPAN destination port and check whether the SPAN function takes effect according to the captured packets.

Related Commands

↘ Configuring a SPAN Source Port

Command	monitor session <i>session-num</i> source interface <i>interface-id</i> [both rx tx]
Parameter Description	<p><i>session-num</i>: Indicates the ID of a SPAN session.</p> <p><i>interface-id</i>: Indicates the interface ID.</p> <p>both: Indicates that packets in the input and output directions are monitored. It is the default value.</p> <p>rx: Indicates that packets in the input direction are monitored.</p> <p>tx: Indicates that packets in the output direction are monitored.</p>
Command Mode	Global configuration mode
Usage Guide	N/A

↘ Configuring a SPAN Destination Port

Command	monitor session <i>session-num</i> destination interface <i>interface-id</i> [switch]
Parameter Description	<p><i>session-num</i>: Indicates the ID of a SPAN session.</p> <p><i>interface-id</i>: Indicates the interface ID.</p> <p>switch: Indicates that the switching function is enabled on the SPAN destination port. It is disabled by default.</p>
Command	Global configuration mode

Mode	
Usage Guide	N/A

↘ **Configuring Stream-based SPAN**

Command	monitor session <i>session-num</i> source interface <i>interface-id</i> rx acl <i>acl-name</i>
Parameter Description	<i>session-num</i> : Indicates the ID of a SPAN session. <i>interface-id</i> : Indicates the interface ID. <i>acl-name</i> : Indicates an ACL name.
Command Mode	Global configuration mode
Usage Guide	N/A

↘ **Specifying a VLAN as the Data Source of SPAN**

Command	monitor session <i>session-num</i> source vlan <i>vlan-id</i> [rx]
Parameter Description	<i>session-num</i> : Indicates the ID of a SPAN session. <i>vlan-id</i> : Indicates a specified VLAN ID. rx : Indicates that packets in the input direction are monitored.
Command Mode	Global configuration mode
Usage Guide	N/A

↘ **Specifying Some VLANs as the Data Sources of SPAN**

Command	monitor session <i>session-num</i> filter vlan <i>vlan-id-list</i> [rx tx both]
Parameter Description	<i>session-num</i> : Indicates the ID of a SPAN session. <i>vlan-id-list</i> : Indicates some specified VLAN IDs. rx : Indicates that packets in the input direction are monitored. tx : Indicates that packets in the output direction are monitored. both : Indicates that packets in both input and output directions are monitored. (Default settings)
Command Mode	Global configuration mode
Usage Guide	N/A

Configuration Example

↘ **The following uses SPAN as an example.**

<p>Scenario Figure 5-5</p>	
<p>Configuration Steps</p>	<ul style="list-style-type: none"> As shown in Figure 5-5, add ports Gi 0/1 and Gi 0/2 of Device A to VLAN 1. Create SVI 1 and set the address of SVI 1 to 10.10.10.10/24. Set IP addresses of PC 1 and PC 2 to 10.10.10.1/24 and 10.10.10.2/24 respectively. Configure SPAN for Device A and configure ports Gi 0/1 and Gi 0/2 as the source port and destination port of SPAN respectively.
<p>A</p>	<pre> FS# configure FS(config)# vlan 1 FS(config-vlan)# exit FS(config)# interface vlan 1 FS(config-if-VLAN 1)# ip address 10.10.10.10 255.255.255.0 FS(config-if-VLAN 1)# exit FS(config)# monitor session 1 source interface gigabitEthernet 0/1 FS(config)# monitor session 1 destination interface gigabitEthernet 0/2 </pre>
<p>Verification</p>	<p>Run the show monitor command to check whether SPAN is configured correctly. After successful configuration, PC 1 sends ping packets to SVI 1 and PC 2 conducts monitoring by using the packet capture tool.</p>
<p>A</p>	<pre> FS# show monitor sess-num: 1 span-type: LOCAL_SPAN src-intf: GigabitEthernet 0/1 frame-type Both dest-intf: GigabitEthernet 0/2 </pre>

Common Errors

- The session ID specified during configuration of the SPAN source port is inconsistent with that specified during configuration of the SPAN destination port.
- Packet loss may occur if packets of a port with large bandwidth are mirrored to a port with small bandwidth.

5.4.2 Configuring RSPAN Basic Functions

Configuration Effect

- Configure a source port and destination port on the source device of an RSPAN session and configure the destination port on the destination device.
- Configure the destination port on the RSPAN destination device to monitor any packets that are transmitted or received by the source port.

Notes

- If the switch function is disabled on an RSPAN destination port, the destination port receives only mirrored packets and discards other packets that pass through the port. After the switch function is enabled, the destination port can receive non-mirrored packets.
- All ports involved in RSPAN must be added to a remote VLAN.
- A remote VLAN must be created on an intermediate device and transparent transmission ports must be added to the remote VLAN.

Configuration Steps

↘ **Configuring an RSPAN Session**

- Global configuration mode. Mandatory.
- The same session ID needs to be configured on the RSPAN source device and RSPAN destination device.

↘ **Configuring an RSPAN Source Device**

- Global configuration mode. Mandatory.
- It is used to specify a device to be monitored by RSPAN.

↘ **Configuring an RSPAN Destination Device**

- Global configuration mode. Mandatory.
- It is used to specify the destination device for outputting RSPAN packets.

↘ **Configuring an RSPAN Source Port**

- Global configuration mode. Mandatory.
- Complete the configuration on an RSPAN source device. After configuration, RSPAN monitoring can be conducted on packets of the RSPAN source port. You can specify RSPAN to monitor remote VLAN packets in the input direction, output direction, or both directions of the RSPAN source port.

↘ **Configuring an RSPAN Output Port**

- Global configuration mode. Mandatory.
- Complete the configuration on an RSPAN source device. After configuration, mirrored packets received by the ports added to the remote VLAN can be transmitted to the RSPAN destination device through the output port.

↘ **Configuring an RSPAN Destination Port**

- Global configuration mode. Mandatory.
- Complete the configuration on the RSPAN destination device. After configuration, the RSPAN destination device forwards mirrored packets received by the ports added to the remote VLAN to the monitoring device through the destination port.

Verification

- Run the **show monitor** command or the **show running** command to check whether RSPAN is successfully configured on each device, or conduct packet capture on the destination mirroring port on the RSPAN destination device to check whether packets mirrored from the source port of the RSPAN source device are captured.

Related Commands

↘ Configuring an RSPAN Source Device

Command	monitor session <i>session-num</i> remote-source
Parameter	<i>session-num</i> : Indicates the ID of an RSPAN session.
Description	
Command	Global configuration mode
Mode	
Usage Guide	N/A

↘ Configuring an RSPAN Destination Device

Command	monitor session <i>session-num</i> remote-destination
Parameter	<i>session-num</i> : Indicates the ID of an RSPAN session.
Description	
Command	Global configuration mode
Mode	
Usage Guide	N/A

↘ Configuring a Remote VLAN

Command	remote-span
Parameter	N/A
Description	
Command	VLAN mode
Mode	
Usage Guide	N/A

↘ Configuring an RSPAN Source Port

Command	monitor session <i>session-num</i> source interface <i>interface-id</i> [both rx tx][acl <i>acl-name</i>]
Parameter	<i>session-num</i> : Indicates the ID of an RSPAN session.
Description	<i>interface-id</i> : Indicates the interface ID. both : Indicates that packets in the input and output directions are monitored. It is the default value. rx : Indicates that packets in the input direction are monitored. tx : Indicates that packets in the output direction are monitored. <i>acl-name</i> : Indicates an ACL name.
Command	Global configuration mode

Mode	
Usage Guide	The configuration is the same as that of a SPAN source port but an RSPAN session ID needs to be specified.

➤ **Configuring an Output Port on the RSPAN Source Device**

Command	monitor session <i>session-num</i> destination remote vlan <i>remote-vlan</i> interface <i>interface-id</i> [switch]
Parameter	<i>session-num</i> : Indicates the ID of an RSPAN session.
Description	<i>remote-vlan</i> : Indicates a remote VLAN. <i>interface-id</i> : Indicates the interface ID. switch : Indicates whether the port participates in packet switching.
Command Mode	Global configuration mode
Usage Guide	N/A

➤ **Configuring a Destination Port on the RSPAN Destination Device**

Command	monitor session <i>session-num</i> destination remote vlan <i>remote-vlan</i> interface <i>interface-id</i> [switch]
Parameter	<i>session-num</i> : Indicates the ID of an RSPAN session.
Description	<i>remote-vlan</i> : Indicates a remote VLAN. <i>interface-id</i> : Indicates the interface ID. switch : Indicates whether the port participates in packet switching.
Command Mode	Global configuration mode
Usage Guide	N/A

Configuration Example

➤ **Configuring One-to-Many RSPAN**

<p>Scenario Figure 5-6</p>	
<p>Configuration Steps</p>	<ul style="list-style-type: none"> As shown in the preceding figure, configure a remote VLAN on Switch A, Switch B, and Switch C. Configure the source port, output port and loopback port on Switch A. Configure the destination port on Switch B and Switch C.

<p>A</p>	<pre> FS# configure FS(config)# vlan 7 FS(config-vlan)# remote-span FS(config-vlan)# exit FS(config)# monitor session 1 remote-source FS(config)# monitor session 1 source interface fa 0/1 both FS(config)# monitor session 1 destination remote vlan 7 interface fa 0/2 switch FS(config)# interface fa0/2 FS(config-if)# mac-loopback FS(config-if)# switchport access vlan 7 FS(config-if)# exit FS(config)# interface range fa0/3-4 FS(config-if-range)# switchport mode trunk </pre>
<p>B, C</p>	<pre> FS(config)# vlan 7 FS(config-vlan)# remote-span FS(config-vlan)# exit FS(config)# monitor session 1 remote-destination FS(config)# monitor session 1 destination remote vlan 7 interface fa 0/2 FS(config)# interface fa0/1 FS(config-if)#switchport mode trunk </pre>
<p>Verification</p>	<p>Run the show monitor command or the show running command on Switch A, Switch B, and Switch C to check whether RSPAN is configured successfully.</p>
<p>A</p>	<pre> FS# show monitor sess-num: 1 span-type: SOURCE_SPAN src-intf: FastEthernet 0/1 frame-type Both dest-intf: FastEthernet 0/2 Remote vlan 7 mtp_switch on </pre>
<p>B</p>	<pre> FS# show monitor sess-num: 1 </pre>

	<pre>span-type: DEST_SPAN dest-intf: FastEthernet 0/2 Remote vlan 7 mtp_switch on</pre>
C	<pre>FS# show monitor sess-num: 1 span-type: DEST_SPAN dest-intf: FastEthernet 0/2 Remote vlan 7 mtp_switch on</pre>

Common Errors

- A remote VLAN must be configured on the source device, intermediate device, and destination device, and their VLAN IDs must be consistent.
- Packet loss may occur if packets of a port with large bandwidth are mirrored to a port with small bandwidth.
- Multiple output ports need to be configured to implement one-to-many RSPAN.

5.5 Monitoring

Displaying

Description	Command
Displays all mirroring sessions existing in the system.	show monitor
Displays a specified mirroring session.	show monitor session <i>session-id</i>

Debugging

 System resources are occupied when debugging information is output. Therefore, disable debugging immediately after use.

Description	Command
Debugs SPAN.	debug span

6 Configuring ERSPAN

6.1 Overview

Encapsulated Remote Switched Port Analyzer (ERSPAN) is an extension to Remote Switched Port Analyzer (RSPAN). SPAN data packets of common RSPANs can be transmitted only within Layer 2 and cannot pass through routing networks. However, an ERSPAN can transmit SPAN packets between routing networks.

An ERSPAN encapsulates all SPAN packets into IP packets through a generic routing encapsulation (GRE) tunnel, and routes them to the destination port of an RSPAN device. The following figure shows the topology of a typical application:

Figure 6-1 Topology of a Typical ERSPAN GRE Tunnel Application

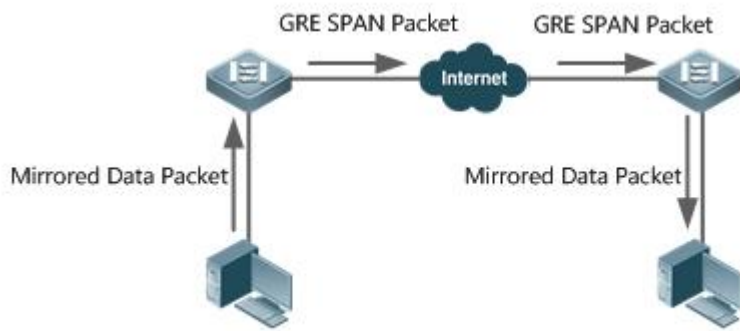

There are two kinds of roles played by the devices in the figure:

- Source switch: A source switch refers to the switch where the ERSPAN source port resides. It copies the packets on the source port, outputs the copies from the output port, encapsulates them into IP packets, and forwards the IP packets to the destination switch.
- Destination switch: A destination switch refers to the switch where the ERSPAN destination port resides. It puts the received SPAN packets through the SPAN destination port, decapsulates them into GRE packets, and then forwards the GRE packets to the monitoring device.

To implement ERSPAN, the GRE-encapsulate IP packets must be able to be normally routed to the destination SPAN device.

6.2 Applications

Application	Description
Basic ERSPAN Applications	Packets on the SPAN source device need to be mirrored to the destination device for monitoring.

6.3 Basic ERSPAN Applications

Scenario

As shown in the following figure, ERSPAN enables the network analyzer to monitor the users connected to the source device Switch A. The devices can normally exchange data with each other.

Figure 6-2 Topology of Basic ERSPAN Applications

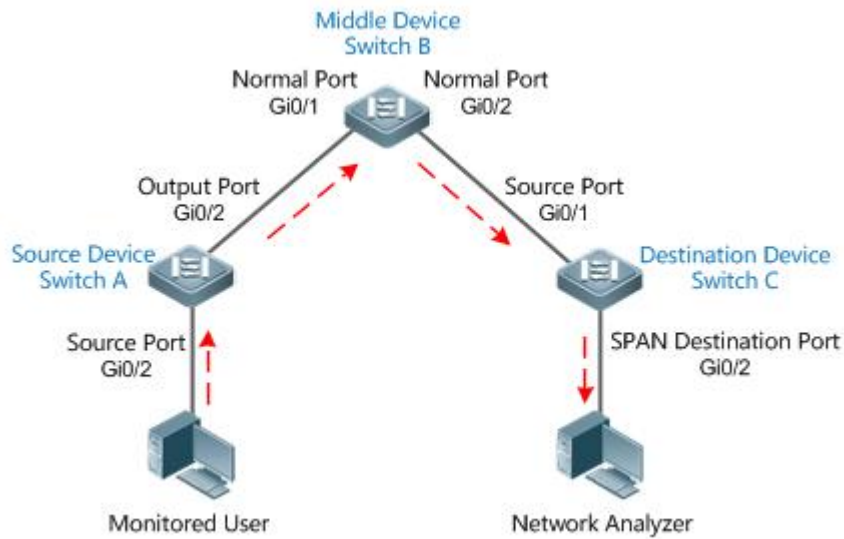

Deployment

- On Switch A, configure the port directly connected to users (Gi 0/1) as a source port, and configure the port connected to Switch B (Gi 0/2) as an output port.
- On Switch B, the ports connected to Switch A and Switch C (Gi 0/1 and Gi 0/2) are respectively member interfaces of switch virtual interface (SVI) interfaces of two network segments, ensuring interworking between the two IP network segments.

6.4 Features

Basic Concepts

↳ ERSPAN Session

SPAN data packets of common RSPANs can be transmitted only within Layer 2 and cannot pass through routing networks. However, ERSPAN mirroring allows SPAN packets to be transmitted between routing networks. An ERSPAN encapsulates all SPAN packets into IP packets through a GRE tunnel, and routes them to the destination port of an RSPAN device. An ERSPAN can monitor input, output, and bidirectional packets of one or more ports. Ports such as a switched port, routed port and aggregate port (AP) can be configured as a source port for an ERSPAN session. The switch is not affected after the port is added to an ERSPAN session.

↳ Source Port

A source port is also called a monitored port. In an ERSPAN session, data streams of the source port are monitored for network analysis and troubleshooting. In a single ERSPAN session, users can monitor the input, output, and bidirectional data streams, and the number of source ports is not limited. A source port has the following features:

- A source port can be a switched port, routed port, or an AP.
- It supports mirroring of multiple source ports on the source device to the designated output ports.
- The source port and output port cannot be on the same port; when the SPAN source port is a Layer-3 interface, both Layer-2 and Layer-3 packets are monitored.
- When multiple ports are bidirectionally monitored, a packet is input from a port and output from the other. Such monitoring is considered correct if only one packet is monitored.

- When the status of enabled Spanning Tree Protocol (STP) port is in block state, the input and output packets on the port can be monitored;
- Source port and destination port can belong to the same VLAN or different VLANs.

Overview

Feature	Description
ERSPAN	Configures SPAN on different Internet ports.

6.4.1 ERSPAN

Encapsulated ERSPAN is an extension of RSPAN. SPAN data packets of common RSPANs can be transmitted only within Layer 2 and cannot pass through routing networks. However, an ERSPAN can transmit SPAN packets between routing networks.

Working Principle

All the mirrored packets are encapsulated into IP packets through a GRE tunnel, and routed to the destination port of an RSPAN device.

↳ Configuring an ERSPAN Session

Configure ERSPAN of the switch, and distinguish between attributes of ERSPAN switch of the device. You need to designate an ERSPAN session ID, and enter the ERSPAN configuration mode after configuration succeeds.

↳ Configuring a Source Port

After entering the ERSPAN configuration mode, you need to name the source port to configure the SPAN source port, and determine the direction of SPAN data streams according to optional configurations of SPAN direction.

↳ Enabling an ERSPAN Session

By default, enabling an ERSPAN session is to enable ERSPAN mirroring. Only enabled ERSPAN sessions take effect.

↳ Encapsulating the Origin IP Address

Encapsulating an origin IP address aims to configure the origin IP address of an encapsulated GRE packet.

↳ Encapsulating the Destination IP Address

Encapsulating a destination IP address aims to configure the destination IP address of an encapsulated GRE packet and ensure normal routing of SPAN packets on the network.

↳ Encapsulating IP TTL/DSCP

Encapsulate Time to Live (TTL) and Differentiated Services Code Point (DSCP) values of IP packets.

↳ Configuring Capture Mode

Configure the capture mode (whether to mirror the entire packet or the header bytes of the original packet).

↳ Configuring Sampling Frequency

Configure the sampling frequency (the number of packets for one mirroring operation) for mirroring on the source port.

↳ `vrf vrf-name`

It indicates the name of virtual routing. Different virtual routing values might obtain different egresses for the same destination IP.

Related Configuration

By default, an SPAN is disabled. It is enabled only after a session is created, and source SPAN port, origin IP and destination IP addresses are configured.

↘ Configuring an ERSPAN Session

```
FS(config)# monitor session session_num erspan-source
```

Wherein,

session-num: Indicates that the number of SPAN sessions supported by SPAN session IDs varies with products.

↘ Configuring a Source Port

```
FS(config-mon-erspan-src)# source interface {single-interface | all} { [rx | tx | both ] }
```

Wherein,

single_interface: Indicates the SPAN source port to be configured.

all: Indicates that the to-be-configured SPAN source port is global interfaces that support mirroring.

rx: Indicates that only the packets received by the source port are monitored after **rx** is configured.

tx: Indicates that only the packets sent from the source port are monitored after **tx** is configured.

both: Indicates that after **both** is configured, the packets sent and received by the source port are transmitted to the destination port to be monitored; that is to say, **both** includes **rx** and **tx**. If none of **rx**, **tx**, or **both** is configured, **both** is enabled by default.

↘ Configuring Stream-based SPAN

The function is disabled by default. Run the FS(config-mon-erspan-src)# **source interface** *interface-id* **rx acl** *acl-name* { *sample* } command to configure stream-based SPANs and the sampling frequency (optional).

↘ Enabling an ERSAN Session

```
FS (config-mon-erspan-src)# shutdown
```

This command is used to disable ERSPAN mirroring. (By default) Run the **no shutdown** command to enable ERSPAN mirroring.

↘ Encapsulating the Destination IP Address

```
FS(config-mon-erspan-src)# destination ip address ip-address
```

Wherein,

ip-address: Encapsulates the destination IP address.

↘ Encapsulating the Origin IP Address

```
FS(config-mon-erspan-src)# origin ip address ip-address
```

Wherein,

ip-address: Encapsulates the origin IP address.

↘ Encapsulating IP TTL

```
FS(config-mon-erspan-src)# ip ttl tll_value
```

Wherein,

ttl_value: Configures the TTL value of an encapsulated IP address. The TTL value ranges from 0 to 255, and the default value is 64.

📌 **Encapsulating IP DSCP**

FS(config-mon-erspan-src)# **ip dscp** *dscp_value*

Wherein,

dscp_value: Configures the DSCP value of an encapsulated IP address. The DSCP value ranges from 0 to 63, and the default value is 0. The function takes effect only after trusting DSCP is configured on the SPAN source port.

📌 **Configuring Capture Mode**

FS(config-mon-erspan-src)# **capture-mode** [**all** | **truncate**]

all: default value, which indicates that the entire original packet is mirrored.

truncate: Indicates that the header byte of the original packet is mirrored. A specific number of header bytes to be mirrored is determined by the product chip.

📌 **Configuring Sampling Frequency**

FS(config-mon-erspan-src)# **sampling-rate** *rate*

rate: Indicates the sampling frequency value, ranging from 1 to 1000000. For example, if the sampling frequency is 100, one packet is sampled from 100 packets, that is, the sampling ratio is 100:1. The default sampling frequency is 1:1, that is, each packet is sampled. This function is valid only when the sampling frequency is configured on the SPAN source port.

📌 **Encapsulating vrf** *vrf-name*

FS(config-mon-erspan-src)# **vrf** *vrf-name*

Wherein,

vrf-name: Indicates the name of VPN Routing & Forwarding Instance (VRF).

⚠️ Pay attention to the following issues during use:

- Confirm the Layer-3 routing connectivity from source switch to destination switch.
- ERSPAN is unavailable if a source port is disabled.
- If a source port or destination port is added to an AP, the source port or destination port egresses an ERSPAN session.
- As a result of product differences, not all products support all options of the above-mentioned commands.

6.5 Configuration

Configuration	Description and Command	
Configuring Basic ERSPAN Functions	(Mandatory) It is used to create ERSPAN mirroring.	
	monitor session <i>erspan_source_session_number</i> erspan-source	Configures an ERSPAN session ID, and enters the configuration mode of the source ERSPAN device.
	source interface [<i>single-interface</i> all] [{ rx tx both]}	Associates the source ERSPAN port, and selects an SPAN direction.
	source interface [<i>single-interface</i> all] rx acl <i>acl-name</i>	Configures the stream-based SPAN source for ERSPAN and

[sample]	enables sampling.
shutdown	Disables ERSPAN mirroring.
destination ip address <i>ip_address</i>	Configures the destination IP address for an ERSPAN stream. The address must be the interface address of the destination device.
original ip address <i>ip_address</i>	Configures the encapsulated origin IP address for ERSPAN.
ip ttl <i>ttl_value</i>	(Optional) Configures the TTL value of an encapsulated IP address for ERSPAN.
ip dscp <i>dscp_value</i>	(Optional) Configures the DSCP field value of an encapsulated IP address for ERSPAN.
capture-mode [all truncate]	(Optional) Configures the capture mode for mirroring the original packet.
sampling-rate <i>rate</i>	(Optional) Configures the sampling frequency for mirroring.
vrf <i>vrf_name</i>	(Optional) Configures the VRF name.

6.5.1 Configuring Basic ERSPAN Functions

Configuration Effect

- RSPAN enables a network analyzer to monitor users.
- Devices can normally exchange data with each other.

Notes

- If a source port is added to an AP, the source port egresses an ERSPAN session.
- The Layer-3 routing connectivity from source switch to destination switch must be ensured.

Configuration Steps

● ERSPAN Session

- Global configuration mode. Mandatory.
- The session ID configured with local SPAN or RSPAN cannot be used for an ERSPAN session. Enter the ERSPAN mode after configuration.

↘ Source Port

- ERSPAN configuration mode. Mandatory.
- An SPAN direction can be selected during configuration of the SPAN source port. The direction is **both** by default; that is, both reception and transmission of packets are monitored.

↘ Enabling an ERSPAN Session

- ERSPAN configuration mode. Mandatory.
- By default, enabling an ERSPAN session is to enable ERSPAN mirroring. Only enabled ERSPAN sessions take effect.

↘ Encapsulating the Origin IP Address

- ERSPAN configuration mode. Mandatory.

- It is used to encapsulate origin IP addresses of SPAN packets.

↘ **Encapsulating the Destination IP Address**

- ERSPAN configuration mode. Mandatory.
- It is used to encapsulate destination IP addresses of SPAN packets.

↘ **Encapsulating IP TTL/DSCP**

- ERSPAN configuration mode. Optional.
- It is used to encapsulate DSCP values of SPAN IP packets.

↘ **Configuring Capture Mode**

- ERSPAN configuration mode. Optional.
- It is used to configure the capture mode for mirroring the original packet.

↘ **Configuring Sampling Frequency**

- ERSPAN configuration mode. Optional.
- It is used to configure the sampling frequency for mirroring.

↘ **vrf vrf-name**

- Global configuration mode. Optional.
- It indicates the name of VRF. VRF must exist.

Verification

- Run the **show monitor** command or the **show running** command to verify the SPAN configuration. You can also conduct packet capture analysis on the SPAN destination port and check whether SPAN takes effect according to the captured packets.

Related Commands

↘ **Configuring an ERSPAN Session**

Command	monitor session <i>session_number</i> erspan-source
Parameter	<i>session-num</i> : Indicates the SPAN session ID.
Description	
Command Mode	Global configuration mode
Usage Guide	N/A

↘ **Configuring a Source Port**

Command	source interface { <i>single-interface</i> all } {[rx tx both]}
Parameter	<i>single_interface</i> : Indicates the SPAN session ID.
Description	<p>all: Indicates global interfaces that support mirroring.</p> <p>both: Monitors both input and output packets by default.</p> <p>rx: Monitors only input packets.</p> <p>tx: Monitors only output packets.</p>

Command	ERSPAN session mode
Mode	
Usage Guide	N/A

↘ **Configuring Stream-based SPAN**

Command	source interface { <i>single-interface</i> all } rx acl <i>acl-name</i> sample
Parameter	<i>single-interface</i> : Indicates the interface name.
Description	all : Indicates global interfaces that support mirroring. <i>acl-name</i> : Indicates the ACL name. sample : Indicates whether the sampling is enabled.
Command	ERSPAN session mode
Mode	
Usage Guide	N/A

↘ **Enabling an ERSAN Session**

Command	shutdown
Parameter	
Description	
Command	ERSPAN session mode
Mode	
Usage Guide	N/A

↘ **Encapsulating the Origin IP Address**

Command	original ip address <i>ip_address</i>
Parameter	<i>ip_address</i> : Indicates the origin IP address to be encapsulated.
Description	
Command	ERSPAN session mode
Mode	
Usage Guide	

↘ **Encapsulates the Destination IP Address**

Command	destination ip address <i>ip_address</i>
Parameter	<i>ip_address</i> : Indicates the destination IP address to be encapsulated.
Description	
Command	ERSPAN session mode
Mode	

↘ **Configuring Capture Mode**

Command	capture-mode [all truncate]
Parameter	all : Indicates that the entire original packet is mirrored.
Description	truncate : Indicates that the header byte of the original packet is mirrored. A specific number of header bytes to be mirrored is determined by the product chip.
Command	ERSPAN session mode

Mode	
Usage Guide	N/A

↘ **Configuring Sampling Frequency**

Command	sampling-rate <i>rate</i>
Parameter Description	<i>rate</i> : Indicates the required sampling frequency.
Command Mode	ERSPAN session mode

↘ **Encapsulating IP TTL**

Command	ip ttl <i>tll_value</i>
Parameter Description	<i>tll_value</i> : Configures the TTL value of an encapsulated IP address for ERSPAN. The value ranges from 1 to 255.
Command Mode	ERSPAN session mode
Usage Guide	-

↘ **Encapsulating DSCP**

Command	ip dscp <i>dscp_value</i>
Parameter Description	<i>dscp_value</i> : Configures the DSCP field value of an encapsulated IP address for ERSPAN. The value ranges from 0 to 64.
Command Mode	ERSPAN session mode
Usage Guide	-

↘ **Configuring VRF** *vrf-name*

Command	vrf <i>vrf_name</i>
Parameter Description	<i>vrf_name</i> : Indicates the VRF name.
Command Mode	ERSPAN session mode
Usage Guide	-

Configuration Example

↘ **The following uses a SPAN as an example.**

<p>Scenario Figure 6-3</p>	
<p>Configuration Steps</p>	<ul style="list-style-type: none"> As shown in Figure 6-3, on Switch A, create ERSPAN Session 1 and configure it as the source device, and configure Gi 0/1 as the source port.
	<pre>SwitchA(config)#monitor session 1 erspan-source SwitchA(config-mon-erspan-src)#source interface gigabitEthernet 0/1 both SwitchA(config-mon-erspan-src)#origin ip address 10.1.1.2 SwitchA(config-mon-erspan-src)#destination ip address 12.1.1.2 SwitchA(config-mon-erspan-src)#vrf vrf-name</pre>
<p>Verification</p>	<p>Step 1: Check the configuration of the device.</p>
	<pre>SwitchA#show running-config ! monitor session 1 erspan-src source interface GigabitEthernet 0/1 both origin ip address 10.1.1.2 destination ip address 12.1.1.2 vrf vrf-name</pre>
	<p>Step 2: Check the ERSPAN information of the device.</p> <pre>SwitchA#show monitor sess-num: 1 //ERSPAN Session</pre>

```

span-type: ERSPAN_SOURCE //ERSPAN source device
src-intf: //ERSPAN source port information
GigabitEthernet 0/1 frame-type Both TX status: Inactive RX status: Inactive
dest-intf: //ERSPAN output port information
GigabitEthernet 0/2
origin ip address 10.1.1.2
destination ip address 12.1.1.2
destination capture mode all
SwitchA#show monitor
sess-num: 1
span-type: ERSPAN_SOURCE
src-intf:
GigabitEthernet 0/1 frame-type Both TX status: Inactive RX status: Inactive
dest-intf:
GigabitEthernet 0/2
origin ip address 10.1.1.2
destination ip address 12.1.1.2
destination capture mode all
ip ttl 64
ip dscp 0
sample rate 0
vrf vrf-name
    
```

Common Errors

- The session ID used to configure ERSPAN mirroring is configured with RSPAN or LOCAL SPAN.
- Layer-3 routing interworking between source switch and destination switch fails.

6.6 Monitoring

Displaying

Description	Command
Displays all SPAN sessions in the system.	show monitor
Displays specific SPAN sessions.	show monitor session <i>session-id</i>

Debugging

System resources are occupied when debugging information is output. Therefore, disable debugging immediately after use.

Description	Command
Debugs SPAN.	debug span

7 Configuring sFlow

7.1 Overview

sFlow is a network monitoring technology jointly developed by InMon, HP, and FoundryNetworks in 2001. This technology has been standardized. It can provide complete traffic flows of Layer 2 to Layer 4, and it is applicable to traffic analysis in the extra-large network. This technology helps users analyze the performance, trend, and existence of network traffic flows in a detailed manner in real time.

sFlow has the following advantages:

- Accurate: sFlow supports accurate monitoring of traffic on a Gigabit network or a network with higher bandwidth.
- Scalable: One sFlow Collector can monitor thousands of sFlow Agents, and it has high scalability.
- Low cost: sFlow Agent is embedded in a network device, and its cost is low.

Protocol Specification

- sFlow Version 5
- RFC 1014

7.2 Applications

Typical Application	Scenario
Monitoring the LAN Traffic	Regard the device as an sFlow Agent, perform sampling of interface traffic in the LAN, and send the sFlow datagrams to an sFlow Collector for traffic analysis, thereby achieving the purpose of network monitoring.

7.2.1 Monitoring the LAN Traffic

Application Scenario

As shown in Figure 7-1, start switch A that serves as an sFlow Agent, enable flow sampling and counter sampling on port Te 0/1, monitor the traffic in the 192.168.1.0 network segment, encapsulate the sampling data into sFlow datagrams at regular intervals or when the buffer is full, and sent the sFlow data to the sFlow Collector for traffic analysis.

Figure 7-1

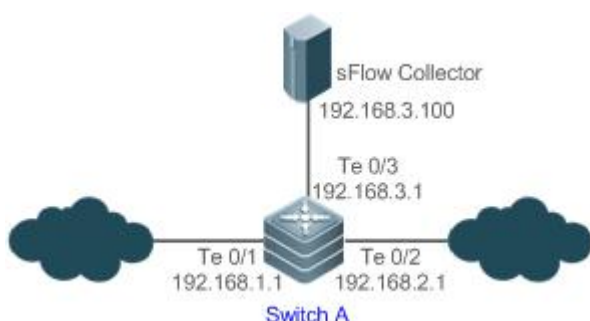

Function Deployment

- Configure the addresses of sFlow Agent and sFlow Collector on switch A.

- Enable flow sampling and counter sampling on port Te 0/1 of switch A.
- **i** Lots of server software supports sFlow. You can obtain software supporting sFlow at <http://www.sflow.org/products/collectors.php>. The software sflowtrend is free of charge.

7.3 Features

Basic Concepts

↳ sFlow Agent

sFlow Agent is embedded in a network device. Generally, one network device can serve as an sFlow Agent. sFlow Agent can perform flow sampling and counter sampling, encapsulate sampled data into sFlow datagrams, and send the sFlow datagrams to the sFlow Collector.

sFlow datagrams are encapsulated in UDP. Figure 7-2 shows the sFlow datagram format.

Figure 7-2 sFlow Datagram Format

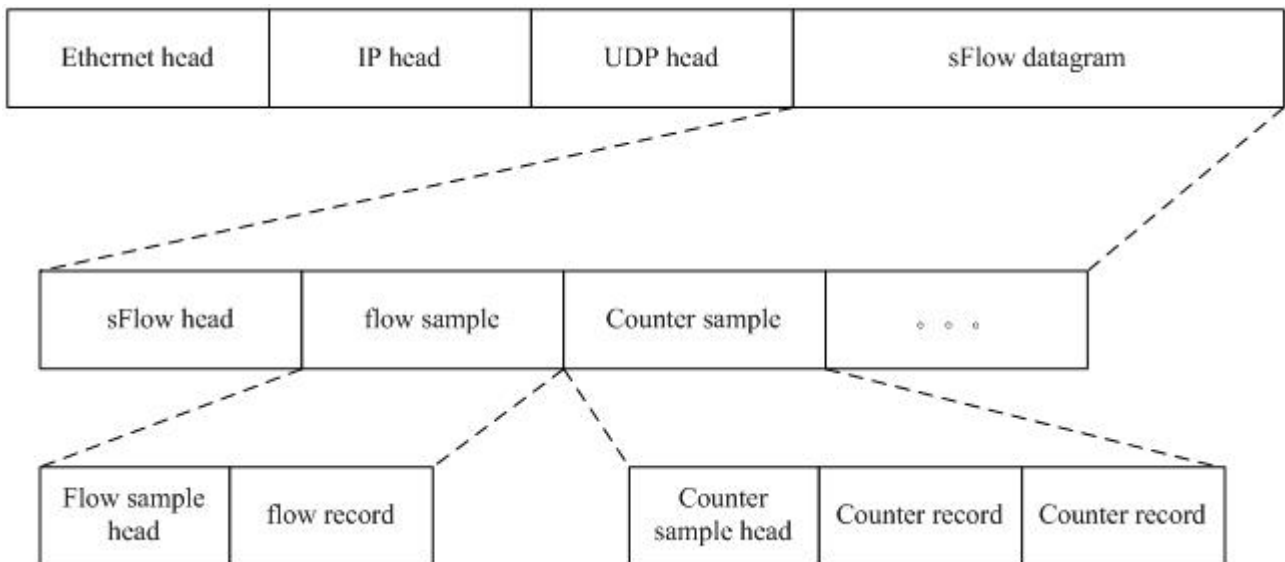

One sFlow datagram may contain one or multiple flow samples and counter samples.

Figure 7-3 sFlow Header

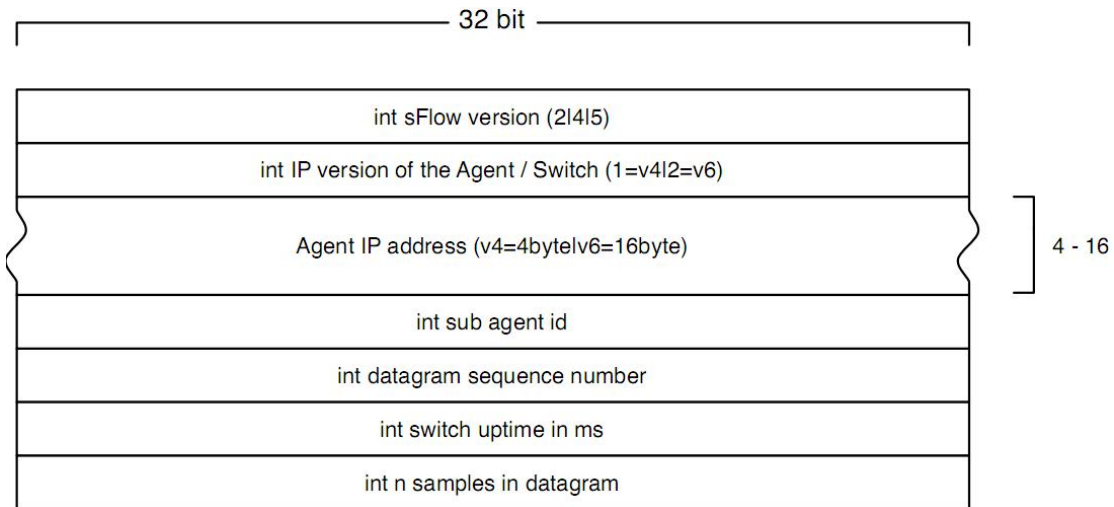

sFlow Header Description:

Field	Description
sFlow version	sFlow version. V2, V4, and V5 are available. Currently, FS supports V5 only.
IP version of the agent/switch	IP address version of the sFlow Agent
Agent IP address	IP address of the sFlow Agent
Sub agent id	Sub-agent ID
Datagram sequence number	Serial number of the sFlow datagram
Switch uptime	Duration from the startup time of the switch to the current time
n samples in datagram	The number of samples in the an sFlow datagram. One sFlow datagram may contain one or multiple flow samples and counter samples.

➤ sFlow Collector

sFlow Collector receives and analyzes the sFlow datagram sent from the sFlow Agent. sFlow Collector may be a PC or server. A PC or server installed with the application software for sFlow datagram analysis can be regarded as an sFlow Collector.

➤ Flow Sampling

Based on the specified sampling rate, the sFlow Agent device performs flow sampling on the traffic flowing through an interface, including copying the header of the packet, extracting the Ethernet header and IP header of the packet, and obtaining the route information of the packet.

Figure 7-4 Flow Sample Header

1	8	32
int data format sample data (20 bit enterprise & 12 bit format) (standard enterprise 0, formats 1)		
int sample length byte		
int sample sequence number		
int source id type (0=ifIndex 1=smonVlanDataSource 2=entPhysicalEntry)	int source id index value	
int sampling rate		
int sample pool (total number of packets that could have been sampled)		
int drops (packets dropped due to a lack of resources)		
int input (SNMP ifIndex of input interface, 0 if not known)		
int output (SNMP ifIndex of output interface, 0 if not known) broadcast or multicast are handled as follows: the first bit indicates multiple destinations, the lower order bits number of interfaces		
int n * flow records		

↘ Counter Sampling

In counter sampling, an sFlow Agent periodically obtains the statistics and CPU usage on a specified interface. The statistics on the interface include the number of packets input through the interface and the number of packets output through the interface.

Figure 7-5 Counter Sample Header

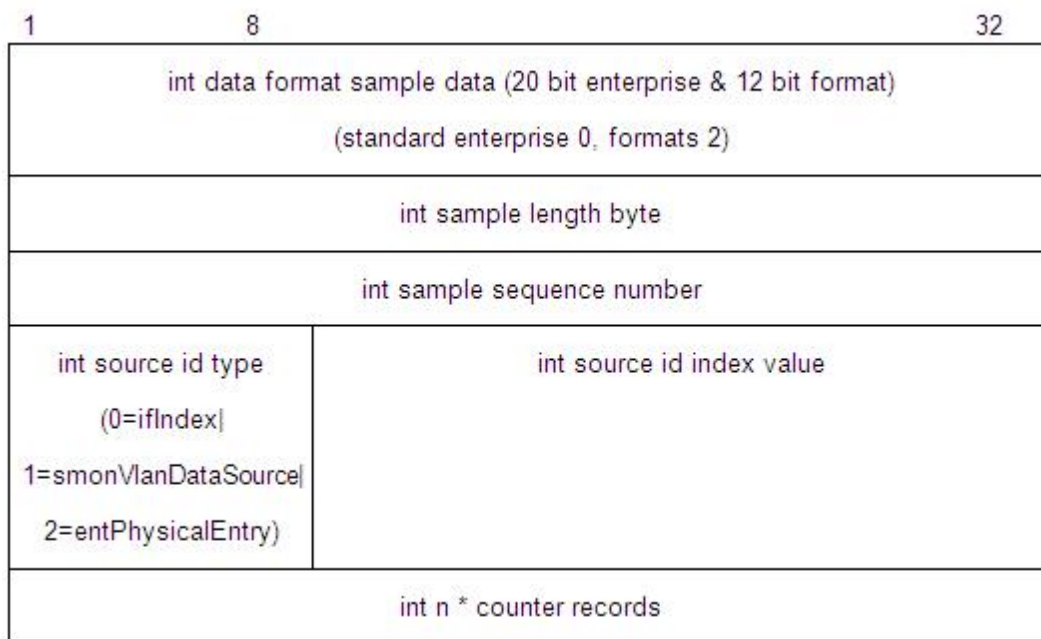

Functions and Features

Feature	Description
<u>Flow Sampling</u>	Sample the traffic flowing through the interface, and send the encapsulated sFlow datagram to the sFlow Collector for analysis.
<u>Counter Sampling</u>	Periodically send the statistics on the interface to the sFlow Collector for analysis.

7.3.1 Flow Sampling

Sample the traffic flowing through the interface, and send the encapsulated sFlow datagram to the sFlow Collector for analysis.

Working Principle

Based on the specified sampling rate, the sFlow Agent device performs flow sampling on the traffic flowing through an interface, including copying the header of the packet, extracting the Ethernet header and IP header of the packet, and obtaining the route information of the packet. Then, the sFlow Agent encapsulates the flow sampling data into an sFlow datagram and sends the datagram to the sFlow Collector for analysis.

7.3.2 Counter Sampling

Periodically send the statistics on the interface to the sFlow Collector for analysis.

Working Principle

The sFlow Agent performs interface polling on a regular basis. For an interface whose counter sampling interval expires, the sFlow Agent obtains the statistics on this interface, encapsulates the statistics into an sFlow datagram, and sends the datagram to the sFlow Collector for analysis.

7.4 Configuration

Configuration Item	Suggestion & Related Command	
Configuring Basic Functions of sFlow	Mandatory configuration. Establish communication connections between sFlow Agent and sFlow Collector.	
	sflow agent {address interface}	Configures the sFlow Agent address.
	sflow collector collector-id destination	Configures the sFlow Collector address.
	Mandatory configuration. Enable flow sampling and counter sampling.	
	sflow counter collector	Enables the sFlow Agent to send counter samples to the sFlow Collector.
	sflow flow collector	Enables the sFlow Agent to send flow samples to the sFlow Collector .
	sflow enable	Enables sFlow sampling for the configuration interface, that is, enables counter sampling and flow sampling.
Configuring Optional Parameters of sFlow	Optional configuration. Sets the optional parameter attributes of sFlow.	
	sflow collector collector-id max-datagram-size	Configures the maximum length of the sFlow datagram.
	sflow counter interval	Configures the counter sampling interval.
	sflow flow max-header	Configures the maximum length of the packet header copied during flow sampling.
	sflow sampling-rate	Configures the sampling rate of flow sampling.
	sflow source {address interface}	Configures the sFlow source address.

7.4.1 Configuring Basic Functions of sFlow

Configuration Effect

- sFlow Agent and sFlow Collector can communicate with each other.
- Traffic flowing through the interface are sampled based on the default sampling rate and sent to the sFlow Collector for analysis.
- Statistics of the interface are periodically sent to the sFlow Collector based on the default sampling interval for analysis.

Notes

- Flow sampling can be configured on only physical interfaces.
- To enable the sFlow Collector to analyze the flow sampling results, the IP address of the sFlow Collector on the sFlow Agent device is required.

Configuration Method

📌 Configuring sFlow Agent Address

- Mandatory configuration.

- Use the **sflow agent address** command to configure the address of the sFlow Agent.
- The sFlow Agent address must be a valid address. That is, the sFlow Agent address must not be a multicast or broadcast address. It is recommended that the IP address of the sFlow Agent device be used.

Command Syntax	sflow agent { address {ip-address ipv6 ipv6-address } } { interface { interface-name ipv6 interface-name } }
Parameter Description	<p>address: Configures the IP address of the sFlow agent.</p> <p><i>ip-address:</i> sFlow Agent IPv4 address</p> <p>ipv6 <i>ipv6-address:</i> sFlow Agent IPv6 address</p> <p>interface: Configures the interface of the sFlow agent.</p> <p><i>interface-name:</i> Interface of IPv4 address.</p> <p>ipv6 <i>interface-name:</i> Interface of IPv6 address.</p>
Defaults	No sFlow Agent address is configured by default
Command Mode	Global configuration mode
Configuration Usage	This command is used to configure the Agent IP address field in the output sFlow datagram. The datagram not configured with this field cannot be output. The sFlow Agent address shall be a host address. When a non-host address (for example, a multicast or broadcast address) is configured as the sFlow Agent address, a message indicating configuration failure is displayed. It is recommended that the IP address of the sFlow Agent device be configured as the sFlow Agent address.

⤵ Configuring sFlow Collector Address

- Mandatory configuration.
- Use the **sflow collector** command to configure the address of the sFlow Collector.
- The sFlow Collector address must be a valid address. That is, the sFlow Collector address must not be a multicast or broadcast address. sFlow Collector must exist, and the route to it must be reachable.

Command Syntax	sflow collector collector-id destination { ip-address ipv6 ipv6_address } udp-port [[vrf vrf-name] [oob] [via mgmt mgmt-name]]] [description collector-name]
Parameter Description	<p><i>collector-id:</i> sFlow Collector ID. The range is from 1 to 2.</p> <p><i>ip-address:</i> sFlow Agent IPv4 address. It is not configured by default</p> <p>ipv6 <i>ipv6-address:</i> sFlow Agent IPv6 address. It is not configured by default</p> <p><i>udp-port:</i> sFlow Collector listening port number</p> <p>vrf <i>vrf-name:</i> VRF instance name. It is not configured by default</p> <p>oob: The sampled traffics are output through the management interface. By default, this parameter is not configured.</p> <p>via mgmt <i>mgmt-name:</i> Management port. It is not configured by default.</p> <p>description <i>collector-name:</i> Description of the sFlow Connector. It is not configured by default.</p>
Command Mode	Global configuration mode
Configuration Usage	This command is used to configure the sFlow Collector address. The sFlow Collector address shall be a host address. When a non-host address (for example, a multicast or broadcast address) is configured as the sFlow Collector address, a message indicating configuration failure is displayed. The sFlow Collector monitors the sFlow datagram

	on the specified port. When the vrf parameter is configured, the corresponding VRF instance must exist. When you remove the a VRF instance, the sFlow Collector address will be removed if this VRF instance is also configured for an sFlow Collector address. When the oob parameter is configured, a datagram is sent to the sFlow Collector through the management interface.
--	---

➤ **Enabling sFlow Samples Output to the sFlow Collector**

- Mandatory configuration.
- You can use the **sflow flow collector** command to enable the sFlow Agent to send flow samples to the sFlow Collector.
- This function must be enabled on the interface to send flow samples to the sFlow Collector. In addition, sFlow Collector must exist, the route to it must be reachable, and the IP address of the corresponding sFlow Collector has been configured on the sFlow Agent device.

Command	sflow flow collector <i>collector-id</i>
Syntax	
Parameter	<i>collector-id</i> : sFlow Collector ID. The range is from 1 to 2.
Description	
Defaults	Sending the flow samples to the sFlow Collector is disabled by default.
Command Mode	Interface configuration mode
Configuration	This command can be used for physical ports, SVI ports and sub routed ports.
Usage	sFlow datagrams can be output only when an IP address is configured for the corresponding sFlow Collector.

➤ **Enabling Counter Samples Output to the sFlow Collector**

- Mandatory configuration.
- You can use the **sflow counter collector** command to enable the sFlow Agent to send counter samples to the sFlow Collector.
- This must be enabled on the interface to send counter samples to the sFlow Collector. In addition, sFlow Collector must exist, the route to it must be reachable, and the IP address of the corresponding sFlow Collector has been configured on the sFlow Agent device.

Command	sflow counter collector <i>collector-id</i>
Syntax	
Parameter	<i>collector-id</i> : sFlow Collector ID. The range is from 1 to 2.
Description	
Defaults	Sending counter samples to the sFlow Collector is disabled by default.
Command Mode	Interface configuration mode
Configuration	This command can be used for physical ports, SVI ports and sub routed ports.
Usage	sFlow datagrams can be output only when an IP address is configured for the corresponding sFlow Collector.

➤ **Enabling Counter Sampling and Flow Sampling**

- Mandatory configuration.
- You can use the **sflow enable** command to enable the flow sampling and counter sampling on an interface.
- The forwarding performance of an interface may be affected after flow sampling is enabled.

Command Syntax	sflow enable [ingress [acl id name] egress]
Parameter Description	ingress: Enables sFlow sampling in ingress direction. egress: Enables sFlow sampling in egress direction. <i>id:</i> Indicates the ACL number. <i>name:</i> Indicates the ACL name.
Defaults	The sFlow sampling function on an interface is disabled by default.
Command Mode	Interface configuration mode
Configuration Usage	This command can be used to enable counter sampling and flow sampling for physical ports, SVI ports, and sub routed ports. If the direction parameter is not specified, sampling on both directions are enabled. The SVI ports and sub routed ports support only the ingress parameter. The ACL should be configured and applied on the interface before the flow sampling based on ACL matching is enabled. Up to two commands for ingress ACL-based flow sampling are supported on an interface.

Check Method

- Use the **show sflow** command to display the sFlow configuration, and check whether the displayed information is consistent with the configuration.

Configuration Examples

📌 **Configuring Flow Sampling and Counter Sampling for sFlow Agent**

Network Environment Figure 7-6	
	As shown in Figure 7-6, start switch A that serves as the sFlow Agent, enable flow sampling and counter sampling on port Te 0/1, monitor the traffic in the 192.168.1.0 network segment, encapsulate the sampling traffic into sFlow datagrams at regular intervals or when the buffer is full, and send the sFlow datagrams to the sFlow Collector for traffic analysis.
Configuration Method	<ul style="list-style-type: none"> ● Configure 192.168.1.1 as the sFlow Agent address. ● Configure 192.168.3.100 as the address of sFlow Collector 1, and 6343 as the port number. ● Configure interface TenGigabitEthernet 0/1 to output flow samples and counter samples to sFlow Collector 1,

	and enable the sFlow sampling function on this interface.
Switch A	<pre> FS# configure terminal FS(config)# sflow agent address 192.168.1.1 FS(config)# sflow collector 1 destination 192.168.3.100 6343 FS(config)# interface TenGigabitEthernet 0/1 FS(config-if-TenGigabitEthernet 0/1)# sflow flow collector 1 FS(config-if-TenGigabitEthernet 0/1)# sflow counter collector 1 FS(config-if-TenGigabitEthernet 0/1)# sflow enable FS(config-if-TenGigabitEthernet 0/1)# end </pre>
Check Method	Use the show sflow command to check whether the command output is consistent with the configuration.
	<pre> FS# show sflow sFlow datagram version 5 Global information: Agent IP: 192.168.1.1 sflow counter interval:30 sflow flow max-header:64 sflow sampling-rate:8192 Collector information: ID IP Port Size VRF 1 192.168.3.100 6343 1400 2 NULL 0 1400 Port information Interface CID FID Enable TenGigabitEthernet 0/1 1 1 Y </pre> <p>Information displayed on the sFlowTrend software:</p>

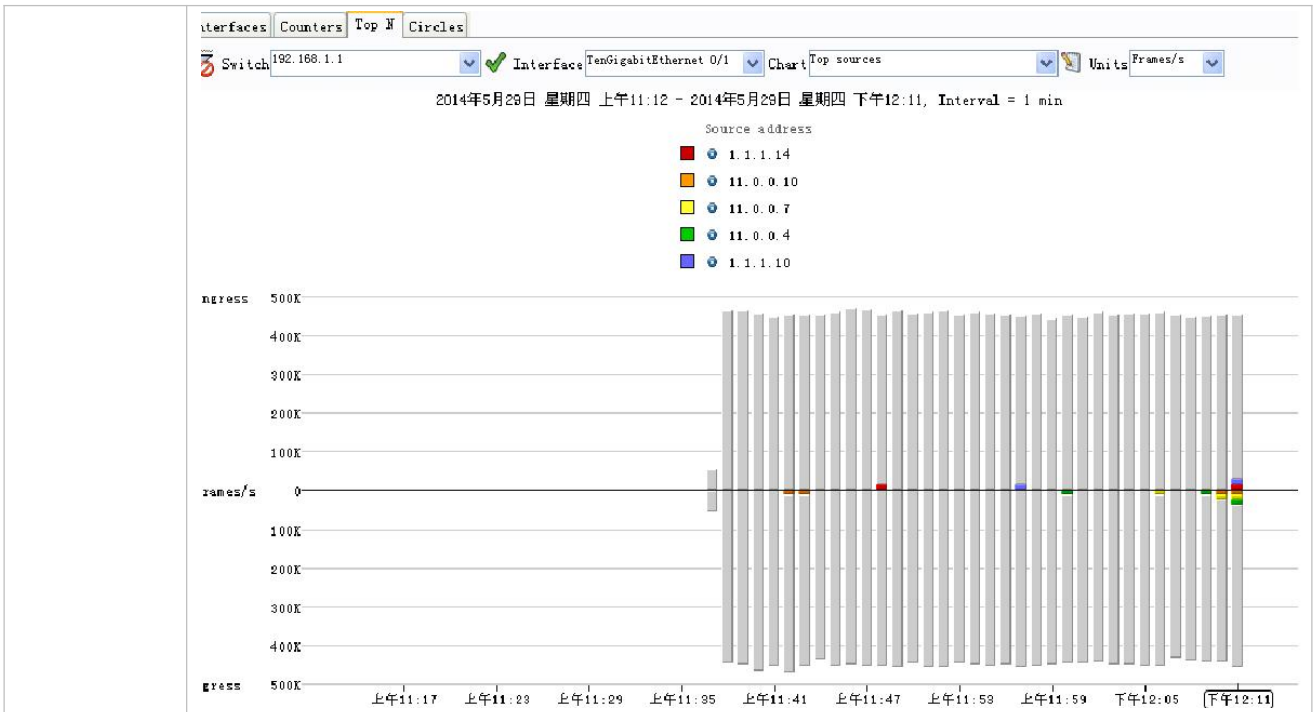

The preceding figure shows the Top N page of the sFlowTrend software. This page displays the flow sampling results and displays the top 5 source IP addresses that involve the largest traffic. The total incoming traffic is about 450 Kpps and the total outgoing traffic is 450 Kpps, which are consistent with the actual traffic.

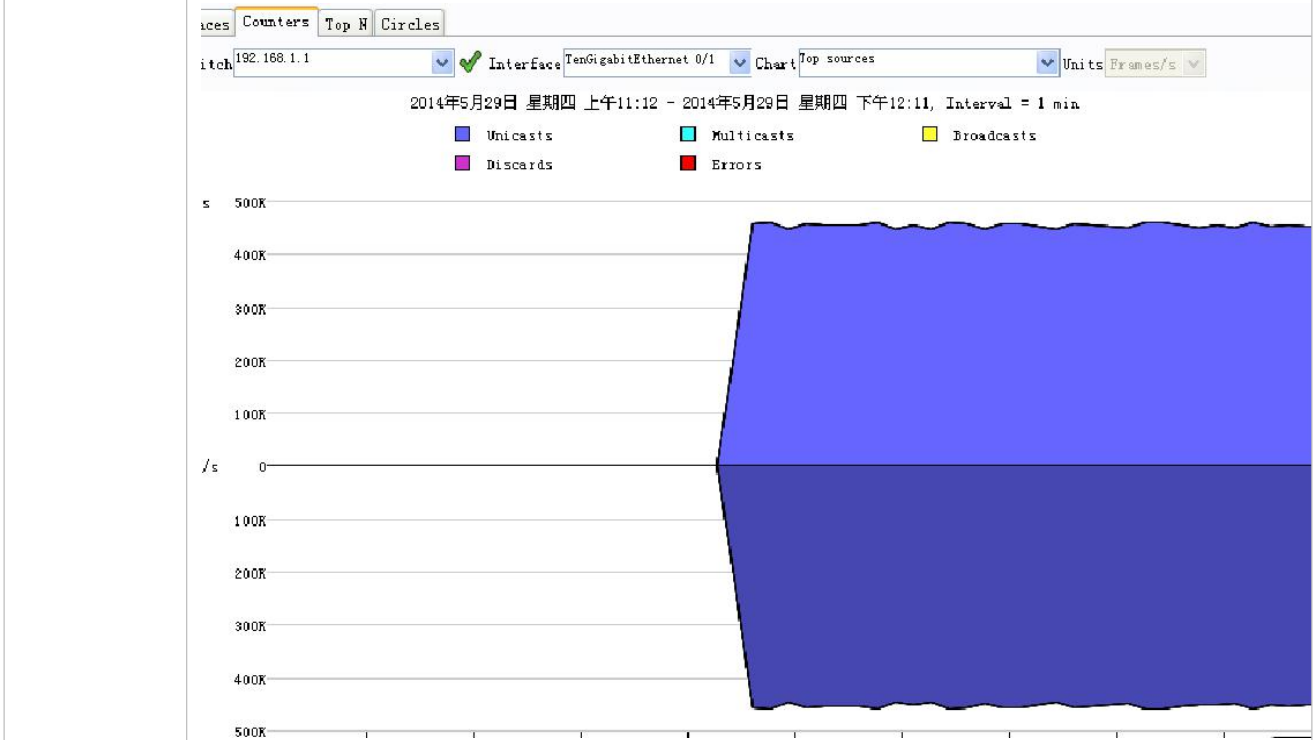

The preceding figure shows the counters page of the sFlowTrend software. This page displays the counter sampling results. The incoming traffic is 450 Kpps and the outgoing traffic is also 450 Kpps. In addition, all packets are unicast

	packets.
--	----------

7.4.2 Configuring Optional Parameters of sFlow

Configuration Effect

You can adjust the data sampling accuracy by modifying relevant parameter attributes of sFlow.

Notes

- The forwarding performance may be affected when the sampling rate is too low.

Configuration Method

▾ Configuring the Maximum Length of the Output sFlow Datagram

- Optional configuration.
- You can use the **sflow collector** command to configure the length of the sFlow datagram, excluding the Ethernet header, IP header, and UDP header. An sFlow datagram may contain one or multiple flow samples and counter samples. Configuration of the output sFlow datagram's maximum length may lead to the result that the number of sFlow datagrams output during processing of a certain number of flow samples differs from the number of sFlow datagrams output during processing of the same number of counter packets. If the maximum length is greater than MTU, the output sFlow datagrams will be segmented.

Command Syntax	sflow collector <i>collector-id</i> <i>max-datagram-size</i> <i>datagram-size</i>
Parameter Description	<i>collector-id</i> : sFlow Collector ID. The range is from 1 to 2 <i>max-datagram-size</i> <i>datagram-size</i> : maximum length of the output sFlow datagram. The range is from 200 to 9,000.
Defaults	The default value is 1,400.
Command Mode	Global configuration mode
Configuration Usage	-

▾ Configuring the Flow Sampling Rate

- Optional configuration.
- You can use the **sflow sampling-rate** command to configure the global flow sampling rate.
- Configuration of flow sampling rate may affect the sFlow sampling accuracy. A lower sampling rate means a higher accuracy and larger CPU consumption. Therefore, the forwarding performance of the interface may be affected when the sampling rate is low.

Command Syntax	sflow sampling-rate <i>rate</i>
Parameter Description	<i>rate</i> : Sampling rate of sFlow sampling. One packet is sampled from every <i>n</i> packets (<i>n</i> equals the value of rate). The range is from 4,096 to 16,777,215.
Defaults	The default global flow sampling rate is 8,192.
Command Mode	Global configuration mode
Configuration Usage	This command is used to configure the global sampling rate of sFlow flow sampling, and sFlow flow sampling of all interfaces uses this sampling rate.

✚ **Configuring the Maximum Length of the Packet Header Copied During Flow Sampling**

- Optional configuration.
- You can use the **sflow flow max-header** command to configure the length of the packet header copied during flow sampling globally.
- Users can use this command to modify the datagram information to be sent to the sFlow Collector. For example, if a user concerns about the IP header, this user can configure the length to 56 bytes. During encapsulation of flow samples, the first 56 bytes of the sample packet are copied to the sFlow datagram.

Command Syntax	sflow flow max-header <i>length</i>
Parameter Description	<i>length</i> : maximum length of the packet header to be copied. The range is from 18 to 256.
Defaults	The default length of the packet header to be copied during global flow sampling is 64 bytes.
Command Mode	Global configuration mode
Configuration Usage	Configure the maximum number of bytes of the packet content copied from the header of the original packet. The copied content is recorded in the generated sample.

✚ **Configuring the Sampling Interval**

- Optional configuration.
- You can use the **sflow counter interval** command to configure the global counter sampling interval.
- Enable the counter sampling interface to send the statistics on it to the sFlow Collector at the sampling interval.

Command Syntax	sflow counter interval <i>seconds</i>
Parameter Description	<i>seconds</i> : time interval. The range is form 3 to 2,147,483,647. The unit is second.
Defaults	The default global counter sampling interval is 30 seconds.
Command Mode	Global configuration mode
Configuration Usage	This command is used to configure the global sFlow counter sampling interval, and sFlow Counter sampling of all interfaces uses this sampling interval.

✚ **Configuring the sFlow Source Address**

- Optional configuration.
- You can use the **sflow source { address | ipv6 }** command to configure the sFlow Source address of the output packets.

Command	sflow source { address {<i>ip-address</i> ipv6 <i>ipv6-address</i> } } { interface { <i>interface-name</i> ipv6 <i>interface-name</i> } }
Parameter Description	address : Configures the source IP address of sFlow output packets. <i>ip-address</i> : sFlow Source IPv4 address

	<p>ipv6 <i>ipv6-address</i>: sFlow Source IPv6 address.</p> <p>interface: Configures the source interface of sFlow output packets</p> <p><i>interface-name</i>: sFlow Source interface (configured with an IPv4 address)</p> <p>ipv6 <i>interface-name</i>: sFlow Source interface (configured with an IPv6 address)</p>
Defaults	The default sFlow Source address is the local device IP address which is used to ping the destination IP.
Command Mode	Global configuration mode
Configuration Usage	This command is used to configure the source IP address of the output packets. If a source interface is specified, the primary address of the interface will be the source IP address of the outputs packets. If the source interface is not specified, for example, the interface is shutdown, the default source address will be used.

Check Method

- Check whether an sFlow datagram with the flow samples is received on the sFlow Collector.
- Use the **show sflow** command to display the sFlow configuration, and check whether the displayed information is consistent with the configuration.

Configuration Examples

▾ **Configuring Optional Parameters of sFlow**

Network Environment	See Figure 7-6.
	<ul style="list-style-type: none"> ● Set the flow sampling rate to 4,096 in global configuration mode. ● Configure the length of the packet header copied during flow sampling to 128 bytes in global configuration mode. ● Set the sampling interval to 10 in global configuration mode.
Configuration Method	<pre>FS# configure terminal FS(config)# sflow sampling-rate 4096 FS(config)# sflow flow max-header 128 FS(config)# sflow counter interval 10</pre>
	<p>Make traffic pass through interface TenGigabitEthernet 0/1.</p> <ul style="list-style-type: none"> ● Check whether there is traffic on interface TenGigabitEthernet 0/1 on sFlow Collector 1. ● Use the show sflow command to check whether the command output is consistent with the configuration.
Check Method	<pre>FS# show sflow sFlow datagram version 5 Global information: Agent IP: 10.10.10.10 sflow counter interval:10 sflow flow max-header:128</pre>

```

sflow sampling-rate:4096

Collector information:

ID   IP                               Port Size VRF
1    192.168.2.100                    6343 1400
2    NULL                               0    1400

Port information

Interface                CID  FID  Enable
TenGigabitEthernet 0/1   0    1    B
TenGigabitEthernet 0/2   0    1    I
TenGigabitEthernet 0/3   0    1    E
    
```

7.5 Monitoring

Displaying

Function	Command
Displays the sFlow configuration.	show sflow
Displays sFlow statistics.	show sflow stats

8 Configuring NETCONF

8.1 Overview

The Network Configuration Protocol (NETCONF) is a brand new Extensible Markup Language (XML)-based protocol proposed by the NETCONF working group of the Internet Engineering Task Force (IETF) in 2003. It can be used for device configuration, parameter retrieval, and monitoring and management. This protocol adopts the client/server communication mode, in which the protocol server program runs on the device while the protocol client program runs on clients. The XML format is used in packets of this protocol, including all configuration data and protocol messages. The NETCONF protocol consists of four layers: content layer, operation layer, Remote Procedure Call (RPC) layer, and transport layer. The content layer is a collection of managed data objects and configuration data of devices is stored at this layer. The operation layer is the basic primitive operation set applied to RPCs, such as <get>, <get-config>, <edit-config>, and <delete-config>. The RPC layer provides a simple mechanism unrelated to transport protocols, and the mechanism specifies elements of some error feedback messages. The transport layer provides a secure transport channel. The NETCONF protocol supports Secure Shell (SSH) (mandatory), Simple Object Access Protocol (SOAP), and Blocks Extensible Exchange Protocol (BEEP).

Protocols and Standards

- RFC4741: NETCONF Configuration Protocol
- RFC4742: Using the NETCONF Configuration Protocol over Secure Shell (SSH)
- RFC4743: Using NETCONF over the Simple Object Access Protocol (SOAP)

- RFC4744: Using the NETCONF Protocol over the Blocks Extensible Exchange Protocol (BEEP)
- RFC5277: NETCONF Event Notifications
- RFC5381: Experience of Implementing NETCONF over SOAP
- RFC5539: NETCONF Over Transport Layer Security (TLS)
- RFC5717: Partial Lock RPC for NETCONF
- RFC6022: NETCONF Monitoring Schema
- RFC6241: Network Configuration Protocol
- RFC6242: Using the Network Configuration Protocol over Secure Shell
- RFC6243: With-defaults capability for NETCONF
- RFC6470: NETCONF Notification Events
- RFC6536: NETCONF Access Control Model (NACM)
- RFC4741 and RFC4742 are replaced by RFC6241 and RFC6242 respectively.

8.2 Applications

Application	Description
NETCONF Network Device Management	Users send NETCONF configuration packets in the XML format to devices through network management software installed on a NETCONF client, to configure and manage the devices.

8.2.1 NETCONF Network Device Management

Scenario

As shown in the figure below, users can utilize the NETCONF network management software to manage and monitor network devices.

Figure 8- 1

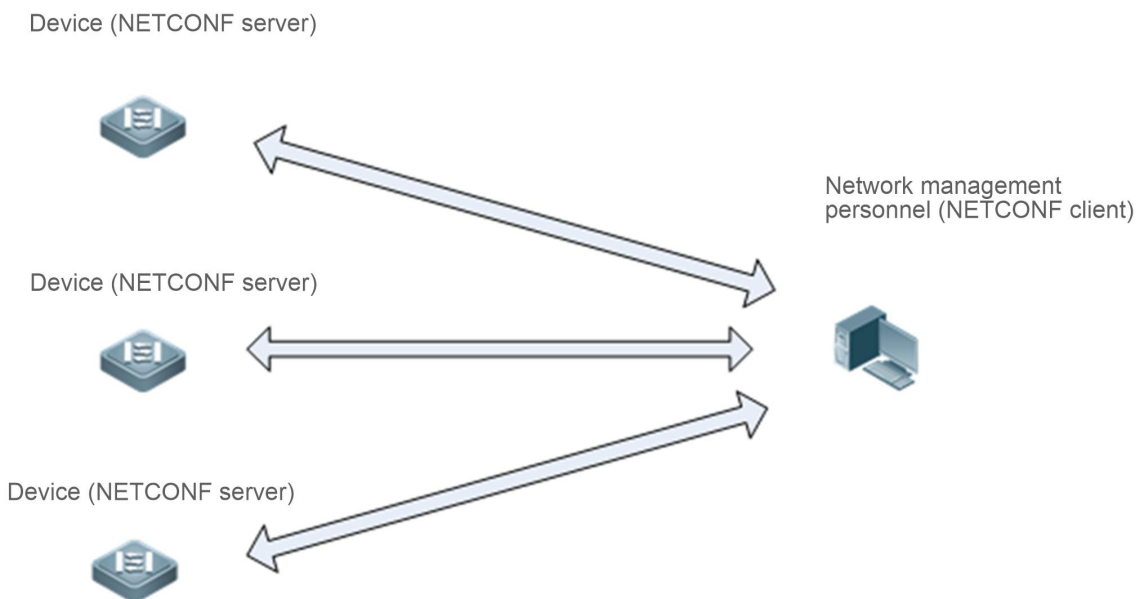

Deployment

The network management station and managed network devices are connected via networks. The SSH protocol needs to run on both the network management software and the devices. On the network management station, by using the NETCONF network management software, users can access the configuration databases and state databases on network devices, receive event notifications sent from the network devices, and manages and monitors the network devices.

8.3 Features

Basic Concepts

Common Terms

- RFC: Remote Procedure Call
- DM: Data Model

Protocol Structure

The figure below shows the structure of the NETCONF protocol.

Figure 8- 2 Structure of the NETCONF Protocol

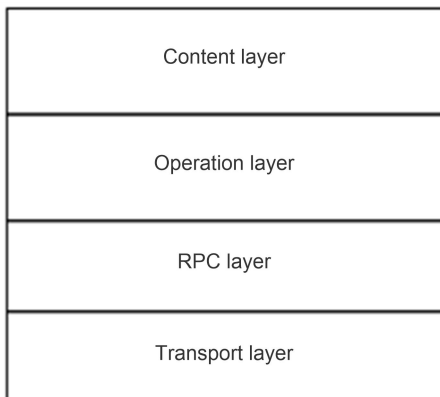

Session Connection

- NETCONF over SSH

The server listens to Port 830. An SSH channel needs to be established before the NETCONF protocol is used. The establishment of the SSH channel (SSH subsystem, named netconf) requires user authentication and negotiation of a range of transmission algorithms (including negotiation of keys, a compression algorithm, a hash algorithm, an encryption algorithm, and a signature algorithm).

Figure 8- 3 Packets Exchanged in a NETCONF Session

NETCONF client

NETCONF server (device)

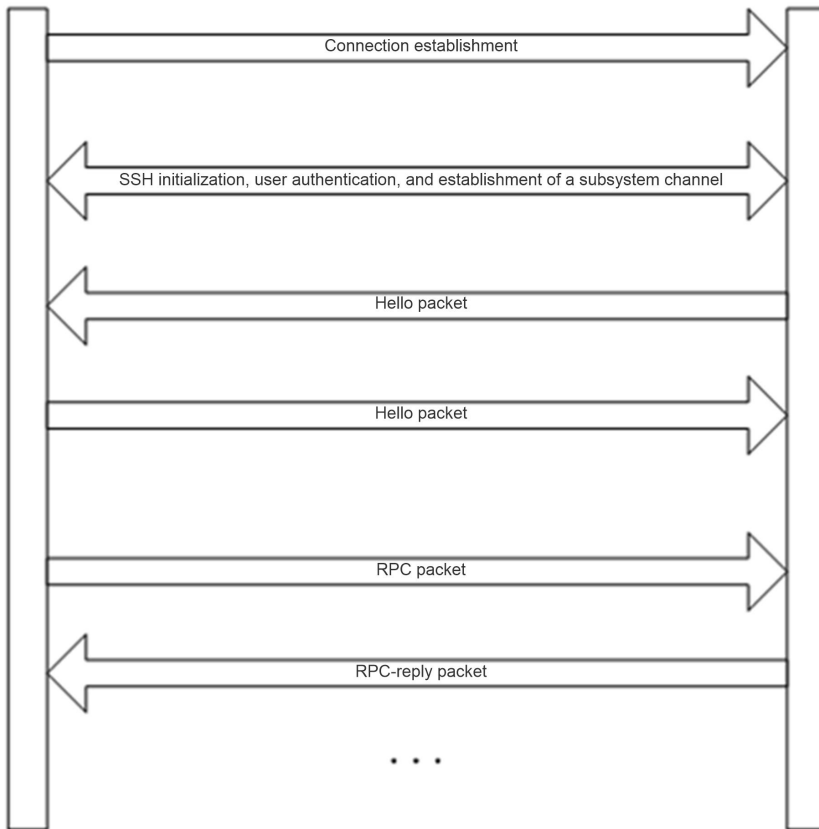

▾ Capability Set Exchange

Capability sets need to be exchanged after a channel is established. Both the server and client provide their implemented capability sets and ignore capabilities that are not understood or not implemented. Each peer must support at least the basic protocol capability (urn:ietf:params:netconf:base:1.1). If the NETCONF protocol is compatible with an earlier protocol version, each peer should support the basic capability (urn:ietf:params:netconf:base:1.0) of this earlier version.

▾ Protocol Operations

Nine basic operation methods are defined for the operation layer of NETCONF and the operation methods are as follows: <get> and <get-config> are value acquisition operations, <edit-config>, <copy-config>, and <delete-config> are configuration operations, <lock> and <unlock> are lock protection operations provided in the case of concurrent operations on critical device resources (configuration files), and <close-session> and <kill-session> are session termination operations.

- <get>: Obtains the status and configuration data of a device.
- <get-config>: Obtains configuration data based on the filtering node in an RPC request.
- <edit-config>: Configures a device based on the provided data model definition and operation attributes. One important attribute **operation** can be set to **merge**, **replace**, **create**, **delete**, or **remove**, and the default value is **merge**.
- <copy-config>: Copies a configuration file, for example, copies a candidate configuration into a configuration file, copies a startup configuration into the running configuration, and writes a running configuration into the startup configuration. These copy operations need the target files to support the write capability.
- <delete-config>: Deletes a configuration file of a device. The running configuration file of a device cannot be deleted.

- `<lock>`: Provides lock protection for configuration data files. When a client is accessing (or modifying) a configuration data file of a device, other clients or non-NETCONF clients (such as SNMP or CLI clients) cannot access (or modify) the configuration data file.
- `<unlock>`: Unlocks a configuration data file.
- `<close-session>`: Closes the current session, including resource release, lock release, and disconnection. When this operation is performed, it must be ensured that the handling of the current service is complete and no new request is being handled.
- `<kill-session>`: forcibly terminates a session (the current session cannot be terminated), including resource release, lock release, and disconnection. When this operation is performed, an ongoing service must be terminated and uncompleted services must be rolled back to the state prior to service handling.

Overview

Feature	Description
<u>Capability Set Exchange</u>	The NETCONF server and client mutually send capability sets to each other. The server (device) supports NETCONF 1.0 and NETCONF 1.1.
<u><get></u>	The client obtains configuration or state data of the device.
<u><get-config></u>	The client obtains configuration data of the device.
<u><edit-config></u>	The client modifies configuration data of the device.
<u><copy-config></u>	The client copies a configuration file on the device into another configuration file.
<u><delete-config></u>	The client deletes a configuration file on the device.
<u><close-session></u>	The client actively closes the current NETCONF session with the device.
<u><lock></u>	The client locks configuration files of the device.
<u><unlock></u>	The client unlocks the configuration files of the device.

8.3.1 Capability Set Exchange

The NETCONF client and NETCONF server exchange their capability sets immediately after establishing a connection. They can perform subsequent data operations only when they support the same NETCONF protocol version. The format of sent packets is as follows:

```

<hello xmlns="urn:ietf:params:xml:ns:netconf:base:1.0">
  <capabilities>
    <capability>
      urn:ietf:params:netconf:base:1.1
    </capability>
    <capability>
      Capability set 1
    </capability>
    <capability>
      Capability set 2
    </capability>
  </capabilities>
  <session-id>Session ID</session-id>
</hello>
    
```

 The capability exchange packet sent from the client to the server cannot contain the session ID (`<session-id>`) node.

Example of capability set exchange on the server:

```
<hello xmlns="urn:ietf:params:xml:ns:netconf:base:1.0">
  <capabilities>
    <capability>urn:ietf:params:netconf:base:1.0</capability>
    <capability>urn:ietf:params:netconf:base:1.1</capability>
    <capability>urn:ietf:params:netconf:capability:writable-running:1.0</capability>
    <capability>urn:ietf:params:xml:ns:yang:ietf-yang-types?module=ietf-yang-types&revision=2013-07-15</capability>
    <capability>urn:rg:params:xml:ns:yang:rg-tacacs?module=rg-tacacs&revision=2016-10-25</capability>
    <capability>urn:rg:params:xml:ns:yang:rg-interfaces?module=rg-interfaces&revision=2016-10-25</capability>
    <capability>urn:ietf:params:xml:ns:yang:ietf-inet-types?module=ietf-inet-types&revision=2010-09-24</capability>
    <capability>urn:rg:params:xml:ns:yang:rg-openflow?module=rg-openflow&revision=2016-09-26</capability>
  </capabilities>
  <session-id>28</session-id>
</hello>
```

Example of capability set exchange on the client:

```
<hello xmlns="urn:ietf:params:xml:ns:netconf:base:1.0">
  <capabilities>
    <capability>urn:ietf:params:netconf:base:1.0</capability>
  </capabilities>
</hello>
```

8.3.2 <get>

This operation is used to obtain the configuration or state data of the device.

The format of packets sent by the client is as follows:

```
<?xml version="1.0" encoding="utf-8"?>
<rpc message-id="xxx" xmlns="urn:ietf:params:xml:ns:netconf:base:1.0">
  <get-config>
    <filter type="subtree">
      Configuration data (or state data) filtering rule
    </filter>
  </get-config>
</rpc>
```

The format of packets returned by the server is as follows:

```
<?xml version="1.0" encoding="utf-8"?>
<rpc-reply message-id="xxx" xmlns="urn:ietf:params:xml:ns:netconf:base:1.0">
  <data xmlns="urn:ietf:params:xml:ns:netconf:base:1.0">
    Acquired configuration data (or state data)
  </data>
</rpc-reply>
```

If none of the subsets of state data on the device matches a filtering rule, the device returns a blank data node shown below:

```
<?xml version="1.0" encoding="utf-8"?>
```

```
<rpc-reply message-id="message ID " xmlns="urn:ietf:params:xml:ns:netconf:base:1.0">
  <data xmlns="urn:ietf:params:xml:ns:netconf:base:1.0"/>
</rpc-reply>
```

8.3.3 <get-config>

This operation is used to acquire configuration data of the device. It acquires configuration data subsets based on various subtree filtering rules but cannot obtain the state data of the device.

The format of packets sent by the client is as follows:

```
<?xml version="1.0" encoding="utf-8"?>
<rpc message-id="xxx" xmlns="urn:ietf:params:xml:ns:netconf:base:1.0">
  <get-config>
    <source>
      <running/>
    </source>
    <filter type="subtree">
      Protocol filtering rules
    </filter>
  </get-config>
</rpc>
```

The format of packets returned by the server is as follows:

```
<?xml version="1.0" encoding="utf-8"?>
<rpc-reply message-id="xxx" xmlns="urn:ietf:params:xml:ns:netconf:base:1.0">
  <data xmlns="urn:ietf:params:xml:ns:netconf:base:1.0">
    Acquired configuration data
  </data>
</rpc-reply>
```

If none of the subsets of configuration data on the device matches filtering rules, the device returns a blank data node shown below:

```
<?xml version="1.0" encoding="utf-8"?>
<rpc-reply message-id="xxx" xmlns="urn:ietf:params:xml:ns:netconf:base:1.0">
  <data xmlns="urn:ietf:params:xml:ns:netconf:base:1.0"/>
</rpc-reply>
```

8.3.4 <edit-config>

This operation is used to edit the configuration based on the provided data model definition and operation attributes. The edit-config packets contain five operation attributes, which are specified in the operation attribute description of the configuration node in the delivered XML packets. The five attributes are as follows:

merge: Merges configuration data in edit-config packets that contain this attribute into a specified device configuration file (or database). If the configuration data does not exist, it is created based on delivered content.

replace: Uses configuration data in the edit-config packets that contain this attribute to replace a related configuration data node in a specified device configuration file (or database). If the configuration data does not exist, it is created based on delivered content. FS devices do not support this operation temporarily. If such an attribute is delivered, it is treated as the merge attribute.

create: Creates, in a specified configuration data file (or database), the configuration data in the edit-config packets that contain this attribute. If the configuration data does not exist, it is created based on delivered content. If the configuration data already exists, an rpc-error packet is returned and error-tag indicates that the data already exists.

delete: Deletes configuration data in the edit-config packets that contain this attribute from a specified configuration data file (or database). If the configuration data already exists, it is deleted directly. If the configuration data does not exist, an rpc-error packet is returned and error-tag indicates that the data is missing.

remove: Removes configuration data in the edit-config packets that contain this attribute from a specified configuration data file (or database). If the configuration data already exists, it is removed directly. If the configuration data does not exist, this operation is ignored and an OK response is returned.

The format of packets sent by the client is as follows:

```
<?xml version="1.0" encoding="utf-8"?>
<rpc message-id="xxx" xmlns="urn:ietf:params:xml:ns:netconf:base:1.0">
  <edit-config>
    <target> <running/> </target>
    <config xmlns:xc="urn:ietf:params:xml:ns:netconf:base:1.0">
      Configuration data
    </config>
  </edit-config>
</rpc>
```

If a packet does not carry the error-option node, the value of this node is **stop-on-error** by default, indicating that once the configuration of a node in a packet is incorrect, subsequent configuration in the same packet is stopped and rpc-error is returned. If a packet does not carry the test-option node, the value of this node is **test-then-set** by default. If a packet does not carry the default-operation node, the value of this node is **merge** by default.

The format of packets returned by the server is as follows:

```
<?xml version="1.0" encoding="utf-8"?>
<rpc-reply message-id="message ID" xmlns="urn:ietf:params:xml:ns:netconf:base:1.0">
  <ok/>
</rpc-reply>
```

If a packet carries the error-option node, the format is generally as follows:

```
<?xml version="1.0" encoding="utf-8"?>
<rpc message-id="xxx" xmlns="urn:ietf:params:xml:ns:netconf:base:1.0">
<edit-config>
  <target> <running/> </target>
  <error-option>behavior option in the case of a configuration error</error-option>
  <config xmlns:xc="urn:ietf:params:xml:ns:netconf:base:1.0">
    Configuration data
  </config>
</edit-config>
</rpc>
```

The error-option node is a node of the enumeration type. It can be set to either of the following values:

stop-on-error: Stops the current edit-config operation immediately when the first error occurs. It is the default value of error-option.

The configuration data before the error in the current configuration packet already takes effect.

continue-on-error: Continues processing configuration data even if an error occurs. Errors are recorded, and an error message is returned after all processing is completed (that is, rpc-error is returned for all configuration errors).

8.3.5 <copy-config>

This operation is used to synchronize startup configuration to running configuration.

The format of packets sent by the client is as follows:

```
<?xml version="1.0" encoding="utf-8"?>
<rpc message-id="xxx" xmlns="urn:ietf:params:xml:ns:netconf:base:1.0">
  <copy-config>
    <target>
      <startup/>
    </target>
    <source>
      <running/>
    </source>
  </copy-config>
</rpc>
```

The format of packets returned by the server is as follows:

```
<?xml version="1.0" encoding="utf-8"?>
<rpc-reply message-id="xxx" xmlns="urn:ietf:params:xml:ns:netconf:base:1.0">
  <ok/>
</rpc-reply>
```

8.3.6 <delete-config>

This operation is used to delete the startup configuration of the device. The running configuration cannot be deleted.

The format of packets sent by the client is as follows:

```
<?xml version="1.0" encoding="utf-8"?>
<rpc message-id="xxx" xmlns="urn:ietf:params:xml:ns:netconf:base:1.0">
  <delete-config>
    <target>
      <startup/>
    </target>
  </delete-config>
</rpc>
```

The format of packets returned by the server is as follows:

```
<?xml version="1.0" encoding="utf-8"?>
<rpc-reply message-id="xxx" xmlns="urn:ietf:params:xml:ns:netconf:base:1.0">
  <ok/>
</rpc-reply>
```

8.3.7 <close-session>

This operation is used to close the current session, release resources and locks, and break the connection.

The format of packets sent by the client is as follows:

```
<?xml version="1.0" encoding="utf-8"?>
<rpc message-id="xxx" xmlns="urn:ietf:params:xml:ns:netconf:base:1.0">
  <close-session/>
</rpc>
```

The format of packets returned by the server is as follows:

```
<?xml version="1.0" encoding="utf-8"?>
<rpc-reply message-id="xxx" xmlns="urn:ietf:params:xml:ns:netconf:base:1.0">
  <ok/>
</rpc-reply>
```

8.3.8 <lock>

According to RFC6241, this operation is used to lock the configuration database (configuration files) and prevent multiple sources (such as the CLI, SNMP, and multiple concurrent NETCONF sessions) from modifying configuration files of the device concurrently, so as to avoid unnecessary configuration modifications. The device simplifies this operation, and can only prevent concurrent modifications (running configuration) from multiple NETCONF sessions and ensures modification security of configuration data.

The format of packets sent by the client is as follows:

```
<?xml version="1.0" encoding="utf-8"?>
<rpc message-id="xxx" xmlns="urn:ietf:params:xml:ns:netconf:base:1.0">
  <lock>
    <target>
      <running/>
    </target>
  </lock>
</rpc>
```

The format of packets returned by the server is as follows:

```
<?xml version="1.0" encoding="utf-8"?>
<rpc-reply message-id="xxx" xmlns="urn:ietf:params:xml:ns:netconf:base:1.0">
  <ok/>
</rpc-reply>
```

8.3.9 <unlock>

This operation is used to unlock the configuration database (configuration files; running configuration on the device here). <lock> and <unlock> are an operation pair.

The format of packets sent by the client is as follows:

```
<?xml version="1.0" encoding="utf-8"?>
<rpc message-id="xxx" xmlns="urn:ietf:params:xml:ns:netconf:base:1.0">
  <unlock>
```

```
<target>
  <running/>
</target>
</unlock>
</rpc>
```



The format of packets returned by the server is as follows:

```
<?xml version="1.0" encoding="utf-8"?>
<rpc-reply message-id="xxx " xmlns="urn:ietf:params:xml:ns:netconf:base:1.0">
  <ok/>
</rpc-reply>
```

8.4 Configuration

Configure parameters related to SSH channel authentication before using NETCONF. For the SSH configuration, see *Configuring SSH*.

Configuration	Description and Command	
Configuring the Candidate Capability of NETCONF	(Optional) It is used to configure the NETCONF server to feed back the candidate capability to the client when exchanging capabilities with the client.	
	netconf capability candidate	Enables the candidate and confirmed-commit capabilities of NETCONF.
Configuring the Rollback Capability of NETCONF	(Optional) It is used to configure the NETCONF server to feed back the rollback-on-error capability to the client when exchanging capabilities with the client.	
	netconf capability rollback	Enables the rollback-on-error capability of NETCONF.
Configuring the Validate Capability of NETCONF	(Optional) It is used to configure the NETCONF server to feed back the validate capability to the client when exchanging capabilities with the client.	
	netconf capability validate	Enables the validate capability of NETCONF.
Configuring DSCP for NETCONF Packets	(Optional) It is used to configure the DSCP value for NETCONF packets.	
	netconf dscp [ip ipv6] ssh value	Configures the DSCP value for NETCONF packets.
Configuring the NETCONF Framework	(Optional) It is used to configure the NETCONF framework.	
	netconf enable	Enables the NETCONF framework.
Configuring the Feature Function of the YANG Module	(Optional) It is used to configure the NETCONF server not to feed back the feature attribute to the client when exchanging capabilities with the client.	
	netconf feature-disable	Disables the feature function of the NETCONF.
Configuring the Maximum Number of Returned Nodes from NETCONF	(Optional) It is used to configure maximum number of returned nodes from NETCONF	

Session	session. If the upper limit is exceeded, NETCONF will not return the nodes.	
	netconf filter nodes-limit	Configures the maximum number of returned nodes from NETCONF.
Configuring the Maximum Number of the NETCONF Session	 (Optional) It is used to configure maximum number of the NETCONF session. If the upper limit is exceeded, the connection between the NETCONF client and server will not succeed.	
	netconf max-sessions	Configures the maximum number of the NETCONF session.
Configuring the NETCONF Monitoring Port	 (Optional) It is used to configure a monitoring port for the connection between NETCONF server and client.	
	netconf port	Configures the NETCONF monitoring port.
Configuring the YANG Module Multi-version Notification	 (Optional) It is used to configure the server to advertise all versions of all supported YANG modules to the client when exchanging capabilities with the client.	
	netconf yang multi-revision	Configures the YANG module multi-version notification function of NETCONF.

8.4.1 Configuring the Candidate Capability of NETCONF

Configuration Effect

The NETCONF server returns the candidate and confirmed-commit capabilities when exchanging capabilities with the NETCONF client (via Hello packets and capabilities packets).

Configuration Steps

↳ Enabling the Candidate and Confirmed-Commit Capabilities of NETCONF

Command	netconf capability candidate
Parameter	N/A
Description	
Defaults	The candidate and confirmed-commit capabilities of NETCONF are disabled by default.
Command Mode	Global configuration mode
Usage Guide	N/A

Configuration Example

↳ Enabling the Candidate and Confirmed-Commit Capabilities of NETCONF

Scenario Figure 8- 4	<div style="display: flex; justify-content: space-around;"> NETCONF server NETCONF client </div> 
Configuration Steps	<ul style="list-style-type: none"> ● Enable the candidate and confirmed-commit capabilities of NETCONF.
NETCONF	<pre>FS# configure terminal Enter configuration commands, one per line. End with CNTL/Z. FS(config)# netconf capability candidate FS(config)#</pre>
Verification	N/A

8.4.2 Configuring the Rollback Capability of NETCONF

Configuration Effect

The NETCONF server returns the rollback capability when exchanging capabilities with the NETCONF client (via Hello packets and capabilities packets).

Configuration Steps

▾ Enabling the Rollback Capability of NETCONF

Command	netconf capability rollback
Parameter	N/A
Description	
Defaults	The rollback capability of NETCONF is disabled by default.
Command Mode	Global configuration mode
Usage Guide	N/A

Configuration Example

▾ Enabling the Rollback Capability of NETCONF

Scenario Figure 8- 5	<div style="display: flex; justify-content: space-around;"> NETCONF server NETCONF client </div> 
Configuration Steps	<ul style="list-style-type: none"> ● Enable the rollback capability of NETCONF.
NETCONF	<pre>FS# configure terminal Enter configuration commands, one per line. End with CNTL/Z.</pre>

	<pre>FS(config)# netconf capability rollback FS(config)#</pre>
Verification	N/A

8.4.3 Configuring the Validate Capability of NETCONF

Configuration Effect

The NETCONF server returns the validate capability when exchanging capabilities with the NETCONF client (via Hello packets and capabilities packets).

Configuration Steps

▾ Enabling the Validate Capability of NETCONF

Command	netconf capability validate
Parameter	N/A
Description	
Defaults	The validate capability of NETCONF is disabled by default.
Command Mode	Global configuration mode
Usage Guide	N/A

Configuration Example

▾ Enabling the Validate Capability of NETCONF

Scenario Figure 8-6	<p>NETCONF server NETCONF client</p>
Configuration Steps	<ul style="list-style-type: none"> ● Enable the validate capability of NETCONF.
NETCONF	<pre>FS# configure terminal Enter configuration commands, one per line. End with CNTL/Z. FS(config)# netconf capability validate FS(config)#</pre>
Verification	N/A

8.4.4 Configuring the DSCP of NETCONF Communication Packets

Configuration Effect

The NETCONF framework of the device allows STAs to configure the DSCP value of communication packets .

Configuration Steps

📌 **Configuring the DSCP Value of NETCONF Communication Packets**

Command	<code>netconf dscp [ip ipv6] ssh value</code>
Parameter	<i>value</i> : indicates the DSCP value. The range is from 0 to 63.
Description	By default, the TOS value of the TCP packets for SSH session is 0 and the TOS value of the NETCONF communication packets is 8.
Defaults	The NETCONF communication packet is not configured, and the TOS value of the TCP packets for SSH session is 0 and the TOS value of the NETCONF communication packets is 8.
Command Mode	Global configuration mode
Usage Guide	N/A

Configuration Example

📌 **Configuring the DSCP Value of NETCONF Communication Packets**

Scenario Figure 8-7	<p>NETCONF server NETCONF client</p>
Configuration Steps	<ul style="list-style-type: none"> ● Enable the DSCP value of NETCONF communication packets.
NETCONF	<pre>FS# configure terminal Enter configuration commands, one per line. End with CNTL/Z. FS(config)# netconf dscp ip ssh 48 FS(config)#</pre>
Verification	N/A

8.4.5 Enabling the NETCONF Framework

Configuration Effect

The NETCONF framework of the device allows STAs to connect to a configured port (port 830 by default).

Notes

N/A

Configuration Steps

📌 **Enabling the NETCONF Framework**

Command	<code>netconf enable</code>
Parameter	N/A
Description	

Defaults	The NETCONF framework is enabled.
Command	Global configuration mode
Mode	
Usage Guide	N/A

Verification

N/A

Configuration Example

▾ **Enabling the NETCONF Framework**

Scenario Figure 8-8	<p>NETCONF server NETCONF client</p>
Configuration Steps	Enable the NETCONF framework.
NETCONF	<pre>FS# configure terminal Enter configuration commands, one per line. End with CNTL/Z. FS(config)# netconf enable FS(config)#</pre>
Verification	N/A

8.4.6 Configuring the Feature Function of the YANG Module

Configuration Effect

The NETCONF server does not return the feature attribute of the YANG module when exchanging capabilities with the NETCONF client (via Hello packets and capabilities packets).

Configuration Steps

▾ **Disabling the Feature Attribute of NETCONF**

Command	netconf feature-disable
Parameter	N/A
Description	
Defaults	The feature attribute of NETCONF is enabled by default.
Command	Global configuration mode
Mode	
Usage Guide	N/A

Configuration Example

▾ **Disabling the Feature Attribute of NETCONF**

NETCONF	<pre>FS# configure terminal Enter configuration commands, one per line. End with CNTL/Z. FS(config)# netconf filter nodes-limit 101 FS(config)#</pre>
Verification	<pre>FS (config)# show running-config in filter nodes-limit netconf filter nodes-limit 101</pre>

8.4.8 Configuring the Maximum Number of the NETCONF Session

Configuration Effect

The NETCONF client can only support the specified number of sessions.

Configuration Steps

▾ Configuring the Maximum Number of the NETCONF Session

Command	<code>netconf max-sessions num</code>
Parameter Description	<i>num</i> : indicates the maximum number of the NETCONF session. The default value is 5, and the value ranges from 1 to 36.
Defaults	The maximum number of the NETCONF session is 5.
Command Mode	Global configuration mode
Usage Guide	N/A

Configuration Example

▾ Configuring the Maximum Number of the NETCONF Session

Scenario Figure 8-11	<p>NETCONF server NETCONF client</p>
Configuration Steps	<ul style="list-style-type: none"> ● Configure the maximum number of the NETCONF session.
NETCONF	<pre>FS# configure terminal Enter configuration commands, one per line. End with CNTL/Z. FS(config)# netconf max-sessions 15 FS(config)#</pre>
Verification	<pre>FS (config)#show running-config in max-sessions netconf max-sessions 15</pre>

8.4.9 Configuring the NETCONF Monitoring Port

Configuration Effect

Configure a port that a NETCONF client can connect to.

Notes

N/A

Configuration Steps

▾ Configuring the NETCONF Monitoring Port

Command	netconf port num
Parameter Description	<i>num</i> : Specifies a monitoring port, which is port 830 by default. The value ranges from 1025 to 65535 .
Defaults	The default monitoring port is port 830.
Command Mode	Global configuration mode
Usage Guide	N/A

Verification

N/A

Configuration Example

▾ Configuring the NETCONF Monitoring Port

Scenario NETCONF server NETCONF client
Figure 8-12



Configuration ● Configure the NETCONF monitoring port.

Steps

```
NETCONF      FS# configure terminal
Enter configuration commands, one per line.    End with CNTL/Z.
FS(config)# netconf port 1234
FS(config)#
```

```
Verification      FS (config)#show running-config | in netconf
netconf port 1234
```

8.4.10 Configuring the YANG Module Multi-version Notification

Configuration Effect

Notes

- The **netconf yang suite openconfig** command takes effect only after the device restarts. The OpenConfig YANG model is supported once configured. Otherwise, the YANG model self-defined by FS is supported.
- The **no netconf yang suite openconfig** command takes effect only after the device restarts. In this case, the OpenConfig YANG model is not supported.
- After the command takes effect upon device restart, output of the **show running-config** command is configuration by executing the CLI command.

Configuration Steps

📌 **Configuring NETCONF to Preferentially Support the OpenConfig YANG Model**

- Optional.
- The configuration takes effect only after the device restarts.

Command	netconf yang suite openconfig
Parameter	N/A
Description	
Defaults	The OpenConfig YANG model is disabled by default.
Command Mode	Global configuration mode
Usage Guide	N/A

Verification

- Run the **show netconf yang-suite** command to display the currently effective YANG model supported by NETCONF and the currently configured YANG model (which may be ineffective and can take effect only after the device restarts).

Configuration Example

📌 **Configuring NETCONF to Preferentially Support the OpenConfig YANG Model**

Scenario Figure 8- 14	NETCONF server	NETCONF client
Configuration Steps	<ul style="list-style-type: none"> ● Configure NETCONF to preferentially support the OpenConfig YANG model. 	
NETCONF	<pre>FS# configure terminal Enter configuration commands, one per line. End with CNTL/Z. FS(config)#netconf yang suite openconfig This command will take effect after device restart. FS(config)#</pre>	

Verification	N/A

8.5 Monitoring

Displaying

Description	Command
Displays the yang model.	show netconf yang-suite

9- Configuring gRPC

9.1 Overview

The Google Remote Procedure Call (gRPC) is a remote procedure call protocol developed by Google for server program design. For a local procedure call, a code segment is executed on the local device to perform an operation. For an RPC, the service user and provider can be located on different computers and the client only needs to notify the server of the operation to be performed. This operation request is sent to the server via a network and the server returns the execution result to the client.

gRPC uses protocol buffers to implement data serialization and deserialization and uses the Hypertext Transfer Protocol Version 2 (HTTP/2) as the data transmission protocol, to achieve better performance.

Protocols and Standards

- <https://github.com/grpc/grpc>

9.2 Applications

Application	Description
One-to-one Topology	Allows one device to report gRPC information to one server.
One-to-many Topology	Allows one device to report gRPC information to multiple servers.

9.2.1 One-to-one Topology

Scenario

One tested device is connected to only one server and reports gRPC data to the server, as shown in Figure 9- 1.

Figure 9- 1 One-to-one Topology



Remarks	S: tested device for collecting gRPC information
	PC: gRPC server for receiving gRPC information

Deployment

- Ensure that PC1 is reachable by S.
- Enable the gRPC function on S.
- On S, configure the events to be reported to the server.

9.2.2 One-to-many Topology

Scenario

One tested device is connected to multiple servers and reports gRPC data to the servers simultaneously, as shown in Figure 9- 2.

Figure 9- 2 One-to-many Topology



Remarks	S: tested device for collecting gRPC information
	PC: gRPC server for receiving gRPC information

Deployment

- Ensure that PC1 and PC2 are reachable by S.
- Ensure that the IP addresses of PC1 and PC2 are different.
- Enable the gRPC function on S.
- On S, configure the events to be reported to the server.

9.3 Features

Basic Concepts

➤ **gRPC**

gRPC is a high-performance cross-language open-source RPC framework developed by Google. It complies with the HTTP/2 and protobuf3.x protocols.

➤ **Channel**

A channel is established between a device and a server.

➤ **Stub**

A stub is an object generated during the multiplexing of a channel.

i For more information about gRPC terms, visit <https://github.com/grpc/grpc>.

Overview

Feature	Description
Enabling the gRPC Function	Enables the gRPC service on the device. The device can serve as a gRPC server to receive authentication and acquisition event messages, or serve as a gRPC client to report gRPC data.
Supporting the gRPC Login and Logout Function	Supports the login and logout operations initiated by a server.
Event Types Supported by gRPC	Supports real-time events, periodical events, and acquisition events.
Configuring a Specified Interface to Send gRPC Packets	Binds a specified interface to send packets.
Preconfiguring Servers and To-be-subscribed Events	Preconfigures servers and to-be-subscribed events.
Preconfiguring Information About Login Users of the gRPC Servers	Preconfigures information about login users of servers.

9.3.1 Enabling the gRPC Function

Configure gRPC, start the gRPC client and gRPC server services, configure to-be-subscribed events for the device, and receive a subscribed event sent by the NETCONF manager, to complete the gRPC data reporting process.

Working Principle

The gRPC communication complies with the HTTP/2 protocol. A client initiates a request and a server responds to this request, to complete one data exchange. A data request can be initiated only by a client and one data exchange must end with a response of a server. See the figure below.

Figure 9- 3 gRPC Communication

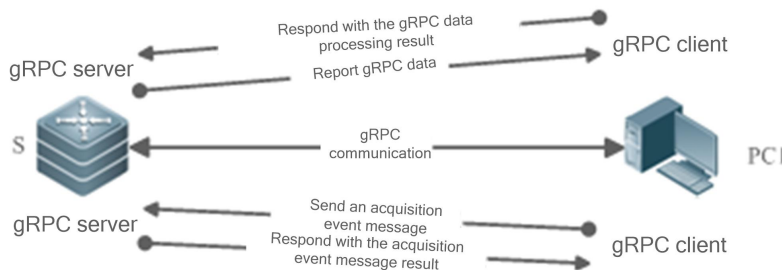

- Configure the gRPC function on device S and start the gRPC client and gRPC server services.

- Device S receives an acquisition event message from the server and responds to the server with the acquisition event message result.
- The gRPC server service configured on device S waits for a subscribed event sent from the NETCONF manager.
- The gRPC client service configured on device S reports gRPC data to the gRPC server based on the subscribed event and waits for a response.

9.3.2 Supporting the gRPC Login and Logout Function

gRPC supports the login and logout operations initiated by a server.

Working Principle

Figure 9- 4 gRPC Login

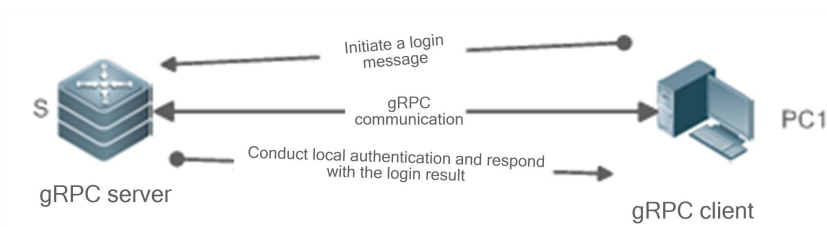

- Configure the gRPC function on device S and start the gRPC server service.
- Device S receives a login message initiated by a server, conducts local authentication, and responds to the server with the login result.
- The gRPC server service configured on device S receives only acquisition events initiated by authenticated login servers.

Figure 9- 5 gRPC Logout

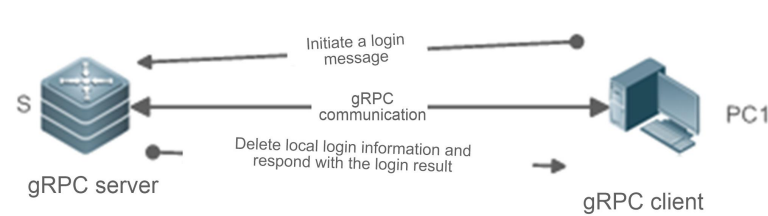

- Configure the gRPC function on device S and start the gRPC server service.
- Device S receives a logout message initiated by a server, deletes the local matched login information, and responds to the server with the logout result.
- The gRPC server service configured on device S no longer receives acquisition events initiated by the logged out servers.

9.3.3 Event Types Supported by gRPC

gRPC supports three types of events: real-time events, periodic events, and acquisition events.

Working Principle

Real-time events: Real-time events use an event triggering threshold as a condition for information collection. When the event triggering threshold is reached, the device collects information and reports the collected information to a server.

Periodic events: Information is collected on the device based on a time interval. When the interval arrives, the device collects information and reports the collected information to a server.

Acquisition events: An acquisition event is initiated by a server to query data at a time. After receiving the message, the device collects information and reports the collected information to the server.

9.3.4 Configuring a Specified Interface to Send gRPC Packets

Working Principle

After the NETCONF manager delivers a gRPC command to a device to create a channel, the device creates a socket before sending packets to the server, to perform the ping operation to test the availability of the path. The device sends gRPC data packets to the server only when the path is available. By default, the created socket randomly binds the source address of a port of the device to send ping packets. When the server receives only packets from a specified source address, the path cannot become available after the default gRPC action is performed and gRPC data packets cannot be uploaded.

Therefore, bind a specified source address when a socket is created, to test the availability of the path. In this way, gRPC data packets can be uploaded correctly.

9.3.5 Preconfiguring Servers and To-be-subscribed Events

Working Principle

The device can precreate servers and to-be-subscribed events via commands, or a controller can be simulated to notify the device of servers and to-be-subscribed events via NETCONF.

The device can delete servers and subscribed events via commands, or a controller can be simulated to notify the device of servers and unsubscribed events via NETCONF.



9.3.6 Preconfiguring Information About Login Users of the gRPC Servers

Working Principle

The device can precreate login users of authenticated servers via commands, or a server can be simulated to initiate a login request, pass authentication, and save information about the login users.

The device can delete login users of authenticated servers via commands, or a server can be simulated to initiate a logout request and delete information about the login users.

9.4 Configuration

Configuration	Description and Command	
<u>Enabling the gRPC Function</u>	 (Mandatory) It is used to enable the gRPC function. Subscription and data reporting are supported only after the gRPC function is enabled.	
	grpc	Creates the gRPC mode and enables the gRPC function.
<u>Configuring the Authentication Mode and AAA Server Authentication Attributes of the gRPC Login and Logout Function</u>	 (Optional) It is used to configure the authentication mode and AAA server authentication attributes of the gRPC login and logout function when server login authentication is required.	
	authen login {local authentication <i>mlist</i>}	Configures the authentication mode for server login.

	authn aaa-config {retry times timeout second}	Configures the login retry count and timeout time for AAA server authentication.
Configuring Event Types Supported by gRPC	 (Mandatory) It is used to configure specified subscribed events.	
	subscr realtime enable	Enables all subscribed real-time events of gRPC.
	subscr sample enable	Enables all subscribed periodic events of gRPC.
	subscr-sample-interval interval	Sets the timer interval for periodic events.
Specifying a Specified Interface to Send gRPC Packets	subscr-realtime-interval {all interval realtime json-event interval}	Sets the suppression time for real-time events.
	subscr-source-interface	Configures a specified interface to send gRPC packets.
Setting gRPC Data Response Timeout Time	reply-source-interface	Configures a specified interface to send GET data.
	reply-timeout	Sets data response timeout time for the GET/SET operation.
Preconfiguring Servers and To-be-subscribed Events	user-server ip-address port-id	Preconfigures servers that can subscribe to events.
	type json-event value value	Preconfigures to-be-subscribed events of a specified server.
Preconfiguring Information About Login Users of gRPC Servers	user-client id user-name ip-address	Preconfigures information about login users of gRPC servers.

9.4.1 Enabling the gRPC Function

Configuration Effect

- Enable the gRPC client and gRPC server services.

Notes

- Ensure the network connectivity between the device and a server.
- The port ID of the local gRPC server is 50051.

Configuration Steps

▾ Enabling the gRPC Function

- Mandatory.
- Enable the gRPC function on each device in global configuration mode unless otherwise specified.

Command	grpc
Parameter Description	N/A
Defaults	The gRPC function is disabled by default.
Command Mode	Global configuration mode
Usage Guide	Use this command to create a gRPC instance, enable the gRPC function, and enter the gRPC process configuration mode. The gRPC client and gRPC server services are created at the same time when the gRPC function is enabled. The gRPC

	client service uploads data to a server while the gRPC server service parses authentication messages and acquisition messages sent from a server.
--	---

Verification

- Run the **show grpc status** command to display the running time after the gRPC function is enabled.

Configuration Example

i Only gRPC-related configuration is described.

▾ Enabling the gRPC Function

Scenario	The network communication between device S and PC1 is normal.
Figure 9-6 One-to-One Topology	
Configuration Steps	<p>Enable the gRPC function.</p> <p>Configure a WAN port.</p>
S	<pre>S(config)# grpc S(config-grpc)# exit S(config)# interface HundredGigabitEthernet 0/49 S(config-if-HundredGigabitEthernet 0/49)# ip address 192.168.1.1 255.255.255.252</pre>
Verification	<p>Ping the server address and check whether the address can be pinged successfully.</p> <p>Check whether the gRPC function is enabled.</p>
S	<pre>S# show grpc status</pre>

9.4.2 Configuring the Authentication Mode and AAA Server Authentication Attributes of the gRPC Login and Logout Function

Configuration Effect

- Set the authentication mode of the gRPC login and logout function to authentication-free mode, AAA local authentication, or AAA server authentication (the timeout time and retry count can be configured).

Notes

- The new-model mode needs to be enabled for AAA server authentication.
- The authentication-free mode is not recommended.
- It is not recommended to modify the timeout time and retry count.

Configuration Steps

▾ Configuring the Authentication Mode of the gRPC Login and Logout Function

- Optional.

- Perform this configuration as required.
- Run the **authen login** command on a required device in gRPC process configuration mode unless otherwise specified.

Command	authen login {local authentication <i>mlist</i>}
Parameter	local: Uses the local username library for authentication. It is the default authentication mode.
Description	authentication: Uses a specified AAA server list for authentication. <i>mlist:</i> Indicates the name of an AAA list.
Defaults	Local login is configured by default, that is, the authen login local command is configured.
Command Mode	gRPC process configuration mode
Usage Guide	After receiving a login request from a server, the device selects AAA local authentication, AAA server authentication, or authentication-free mode as required. When the authentication is successful, the device records the login user information, namely, the IP address and username of the server. The device responds only to acquisition event requests initiated by authenticated servers.

↘ **Configuring the AAA Server Authentication Attributes of the gRPC Login and Logout Function**

- Optional.
- Perform this configuration as required.
- It is not recommended to modify this configuration on the device unless otherwise specified.

Command	authen aaa-config {retry <i>times</i> timeout <i>second</i>}
Parameter	retry: Sets the retry count for AAA server authentication.
Description	<i>times:</i> Indicates the retry count. The value ranges from 1 to 100 . timeout: Sets the timeout time for AAA server authentication. <i>second:</i> Indicates the timeout time, in seconds. The value ranges from 0 to 300 and the value 0 indicates that the authentication is considered failed after an AAA server timeout message is received.
Defaults	The default retry count is 1 and the default timeout time is 4s.
Command Mode	gRPC process configuration mode
Usage Guide	Use this command to configure the authentication retry count and timeout time for the AAA server authentication mode in the case of server login. It is not recommended to change the default retry count and timeout time. A large retry count or improper timeout time may result in AAA lockout for 15 minutes (you can run the clear aaa local user lockout all command to clear the AAA lockout).

Verification

- Run the **show running** command to check whether the configuration is correct.

Configuration Example

- ✔ Only gRPC-related configuration is described.

↘ **Configuring the Authentication Mode of the gRPC Login and Logout Function**

Scenario	The network communication between device S and PC1 is normal.
-----------------	---

<p>Figure 9-7 One-to-One Topology</p>	
<p>Configuration Steps</p>	<p>Enable the gRPC function. Configure the new-model mode for AAA authentication and a mlist list named test.</p>
<p>S</p>	<pre>S(config)# grpc S(config-grpc)# authen login authentication test</pre>
<p>Verification</p>	<p>Check whether the configuration is correctly saved. Check whether the device can be pinged successfully from the PC client. Check whether the PC client can conduct authentication and make records.</p>
<p>S</p>	<pre>S# show running S# show grpc client</pre>

9.4.3 Configuring Event Types Supported by gRPC

Configuration Effect

- Enable all subscribed real-time events of the device.
- Enable all subscribed periodic events of the device.
- Modify the timer time for periodic events.

Notes

- Events subscribed by the server take effect only after the specified subscribed events are configured on the device.

Configuration Steps

▾ Enabling Subscribed Events of the Device

- Mandatory.
- Run the **subscr realtime enable** command to enable all subscribed real-time events of the device.
- Run the **subscr sample enable** command to enable all subscribed periodic events of the device.
- Run the **show grpc channel [counter]** command to display real-time/periodic events subscribed by a server or to display statistics.

Command	subscr [realtime sample] enable
Parameter	realtime: Indicates subscribed real-time events.
Description	sample: Indicates subscribed periodic events.
Defaults	Subscribed real-time/periodic events are disabled by default.
Command Mode	gRPC process configuration mode
Usage Guide	After configuring to-be-subscribed events, the gRPC process waits for the NETCONF manager to send a subscribed event.

	<p>When a received subscription message matches the local to-be-subscribed event, the gRPC process enables the function of reporting gRPC data of the event to the server. After the NETCONF manager sends an unsubscribed event, if the received unsubscription message matches the local to-be-subscribed event, the gRPC process disables the function of reporting gRPC data of the event to the server.</p> <p>If the gRPC process configures no to-be-subscribed event, the gRPC process performs no processing when receiving a subscribed or unsubscribed event from the NETCONF manager.</p>
--	---

↘ **Configuring the Timer Interval for Periodic Events**

- Optional.
- Perform this configuration as required.
- Run the **subscr-sample-interval** command on a required device in gRPC process configuration mode to modify the timer interval for periodic events unless otherwise specified.

Command	subscr-sample-interval <i>interval</i>
Parameter Description	<p><i>interval</i>: Indicates the locally configured interval for reporting periodic events, in seconds. The value ranges from 1 to 65535 and the default value is 10.</p> <p><i>millisecond</i>: Indicates the millisecond part in the locally configured interval for reporting periodic events. The value ranges from 0 to 999 and the default value is 0. This value plus <i>interval</i> is the actual reporting interval, which should not be smaller than 100 milliseconds.</p>
Defaults	The default timer interval for periodic events is used by default.
Configuration Mode	gRPC process configuration mode
Usage Guide	After a subscribed periodic event of the device is enabled and the NETCONF manager sends the subscribed periodic event, the gRPC process starts a periodic event timer and sends gRPC data to the server that subscribes to the event. When the periodic event sent by the NETCONF manager does not carry the timer interval, the timer interval is determined by the subscr-sample-interval command. When the periodic event sent by the NETCONF manager carries the timer interval, this timer interval shall prevail.

↘ **Configuring the Suppression Time for Real-time Events**

- Optional.
- Perform this configuration as required.
- Run the **subscr-realtime-interval** command on a required device in gRPC process configuration mode to modify the suppression time for real-time events unless otherwise specified.

Command	subscr-realtime-interval { all <i>interval</i> realtime <i>json-event interval</i> }
Parameter Description	<p>all: Indicates that the configuration takes effect on all real-time events.</p> <p>realtime: Indicates that the configuration takes effect on a specific real-time event.</p> <p><i>json-event</i>: Indicates the type of the configured real-time event.</p> <p><i>interval</i>: Specifies the suppression interval for reporting data of real-time events, in milliseconds. The value ranges from 1 to 1000000 and real-time events are not suppressed by default.</p>
Defaults	Real-time events are not suppressed by default.
Configuration Mode	gRPC process configuration mode
Usage Guide	After the device enables a subscribed real-time event, if the threshold of the event is triggered, real-time packets are

	<p>generated and sent to the server that subscribes to the event. When the threshold is triggered frequently, a large number of packets are generated and sent to the server within a short period of time. Data of these packets may be the same but handling these packets greatly increases the overheads of the device and server. To prevent this case, run the subscr-realtime-interval command to suppress the generation of new packets for real-time events within a period of time.</p>
--	--

Verification

- Run the **show grpc subscr realtime** command to display subscribed real-time events.
- Run the **show grpc subscr sample** command to display subscribed periodic events.
- Run the **show grpc channel [counter]** command to display the IP address, port ID, and subscribed events of a server, or display various statistics.

Configuration Example

▾ **Enabling Subscribed Real-time Events of the Device**

Scenario	The network communication between device S and PC1 is normal.
Figure 9-8 One-to-One Topology	
Configuration Steps	<ul style="list-style-type: none"> ● Enable the gRPC function (omitted). ● Set the to-be-subscribed CLI configuration modification real-time event. ● The NETCONF manager subscribes to the CLI configuration modification real-time event.
S	<pre>S(config)# grpc S(config-grpc)# subscr realtime enable</pre>
Verification	<p>Run the show grpc subscr realtime command to display the number of servers that subscribe to the CLI configuration modification real-time event.</p> <p>Run the show grpc channel [counter] command to display the IP addresses, port IDs, and subscribed events of the servers or various statistics.</p>
S	<pre>S# show grpc subscr realtime S# show grpc channel counter</pre>

▾ **Enabling Subscribed Periodic Events of the Device**

Scenario	The network communication between device S and PC1 is normal.
-----------------	---

<p>Figure 9-9 One-to-One Topology</p>	
<p>Configuration Steps</p>	<ul style="list-style-type: none"> ● Enable the gRPC function (omitted). ● Configure the to-be-subscribed DCB PFC periodic event. ● The NETCONF manager subscribes to the DCB PFC periodic event.
<p>S</p>	<pre>S(config)# grpc S(config-grpc)# subscr sample enable</pre>
<p>Verification</p>	<p>Run the show grpc subscr sample command to display the number of servers that subscribe to the DCB PFC periodic event.</p> <p>Run the show grpc channel [counter] command to display the IP addresses, port IDs, and subscribed events of the servers or various statistics.</p>
<p>S</p>	<pre>S# show grpc subscr sample S# show grpc channel counter</pre>

➤ **Configuring the Timer Interval for Periodic Events**

<p>Scenario</p>	<p>The network communication between device S and PC1 is normal.</p>
<p>Figure 9-10 One-to-One Topology</p>	
<p>Configuration Steps</p>	<ul style="list-style-type: none"> ● Enable the gRPC function (omitted). ● Set the interval for periodically acquiring the subscribed periodic event to 10s.
<p>S</p>	<pre>S(config)# grpc S(config-grpc)# subscr-sample-interval 10</pre>
<p>Verification</p>	<p>Run the show grpc subscr sample command to display the timer interval of all subscribed periodic events.</p>
<p>S</p>	<pre>S# show grpc subscr sample</pre>

Common Errors

N/A

➤ **Configuring the Suppression Time for Real-time Events**

Scenario	The network communication between device S and PC1 is normal.
Figure 9- 11 One-to-One Topology	
Configuration Steps	<ul style="list-style-type: none"> ● Enable the gRPC function (omitted). ● Set the suppression time to 500 ms for all subscribed real-time events.
S	<pre>S(config)# grpc S(config-grpc)# subscr-realtime-interval all 500</pre>
Verification	Run the show grpc subscr realtime command to display the suppression time of all subscribed real-time events.
S	<pre>S# show grpc subscr realtime</pre>

9.4.4 Configuring a Specified Interface to Send gRPC Packets

Configuration Effect

- gRPC uses the IP address of a specified interface to send packets.

Notes

- The bound interface needs to be up.
- An IP address needs to be configured for the bound interface.

Configuration Steps

▾ Configuring a Specified Interface to Send Real-time and Periodic Data

- Optional.
- Perform this configuration as required.
- Run the **subscr-source-interface** command on a required device in gRPC process configuration mode unless otherwise specified.

▾ Configuring a Specified Interface to Send GET Data

- Optional.
- Perform this configuration as required.
- Run the **reply-source-interface** command on a required device in gRPC process configuration mode unless otherwise specified.

Verification

- Run the **show running** command to check whether the configuration is correct.

Related Commands

↘ **Configuring a Specified Interface to Send GET Data**

Command	reply-source-interface <i>interface-type interface-number</i>
Parameter Description	<i>interface-type interface-number</i> : Specifies the interface name.
Defaults	gRPC randomly specifies a source address to send GET data by default.
Command Mode	gRPC process configuration mode
Usage Guide	By default, the GET data is sent from a random source interface. You can use this command to enable the server to receive packets from a specified interface only.

↘ **Configuring a Specified Interface to Send Real-time and Periodic Data**

Command	subscr-source-interface <i>interface-type interface-number</i>
Parameter Description	<i>interface-type interface-number</i> : Specifies the interface name.
Defaults	gRPC randomly specifies a source address to send real-time and periodic data by default.
Command Mode	gRPC process configuration mode
Usage Guide	By default, the real-time and periodic data is sent from a random source interface. You can use this command to enable the server to receive packets from a specified interface only.

Configuration Example

- ✔ Only gRPC-related configuration is described.

↘ **Binding a Specified Interface to Send gRPC Packets**

Scenario	The network communication between device S and PC1 is normal.
Figure 9- 12 One-to-One Topology	
Configuration Steps	<p>Enable the gRPC function.</p> <p>Configure a WAN port.</p>
S	<pre>S(config)# interface HundredGigabitEthernet 0/49 S(config-if-HundredGigabitEthernet 0/49)# ip address 192.168.1.1 255.255.255.252 S(config-if-HundredGigabitEthernet 0/49)# exit S(config)# grpc S(config-grpc)# subscr-source-interface HundredGigabitEthernet 0/49 S(config-grpc)# reply-source-interface HundredGigabitEthernet 0/49</pre>

Verification	<p>Check whether the configuration is correctly saved.</p> <p>Ping the server address and check whether the address can be pinged successfully.</p> <p>Check whether the device and the server can communicate with each other properly.</p>
S	<pre>S# show running S# show grpc channel</pre>

9.4.5 Setting gRPC Data Response Timeout Time

Configuration Effect

- Set the data response timeout time for the device serving as the gRPC server.

Notes

- The value can be set based on actual scenarios. A smaller value may result in a timeout error when the GET operation involves time-consuming data.

Related Commands

▾ Setting gRPC Data Response Timeout Time

- Mandatory.

Command	reply-timeout <i>interval</i>
Parameter Description	<i>interval</i> : Indicates the data response timeout time of the device serving as the gRPC server, in seconds. The default value is 10 and the value ranges from 1 to 300.
Defaults	The default value is 10 seconds.
Command Mode	gRPC process configuration mode
Usage Guide	After timeout time is set for the gRPC process and the collector delivers the GET/SET operation, the device returns a timeout error to the collector if it fails to obtain data within the timeout time.

Verification

- Run the **show running** command to check whether the configuration is correct.

Configuration Example

- ✔ Only gRPC-related configuration is described.

▾ Setting gRPC Data Response Timeout Time

Scenario	The network communication between device S and PC1 is normal.
Figure 9-13 One-to-One Topology	
Configuration	Enable the gRPC function.

Steps	Set the gRPC data response timeout time.
S	S(config)# grpc S(config-grpc)# reply-timeout 30
Verification	Check whether the configuration is correctly saved. Run a command to check whether the displayed timeout value is the same as the configured value.
S	S# show running

Common Errors

9.4.6 Preconfiguring Servers and To-be-subscribed Events

Configuration Effect

- After servers and to-be-subscribed events are preconfigured, gRPC packets of related events can be reported to the servers.

Notes

- The address and port ID of a server need to be valid.
- To-be-subscribed events and parameters need to be correct and valid.

Configuration Steps

➤ **Preconfiguring a Server that Can Subscribe to Events**

- Mandatory.

Command	user-server <i>ip-address</i> <i>port-id</i>
Parameter Description	<i>ip-address</i> : Indicates the server IPv4 address. <i>port-id</i> : Indicates the port ID of the server.
Defaults	N/A
Command Mode	gRPC process configuration mode
Usage Guide	Use this command to precreate a specified server channel and switch to the gRPC server subscription mode. The to-be-subscribed events of the channel can be configured in this mode. The device can precreate servers and to-be-subscribed events via commands, or a controller can be simulated to notify the device of servers and to-be-subscribed events via NETCONF. The device can delete servers and subscribed events via commands, or a controller can be simulated to notify the device of servers and unsubscribed events via NETCONF.

➤ **Preconfiguring To-be-subscribed Events**

- Mandatory.

Command	type <i>json-event</i> value <i>value</i>
Parameter Description	<i>json-event</i> : Indicates the type of an event. For details, see the output of the show grpc subscr include json command. <i>Value</i> : Configures the parameter value, that is, the threshold for real-time events and time interval for periodic events. <i>value-extend</i> : Indicates the extension of <i>value</i> . This parameter is used to set the millisecond part in the interval for

	reporting periodic events. The value ranges from 0 to 999. This value plus <i>value</i> should not be smaller than 100 milliseconds.
Defaults	N/A
Command Mode	gRPC server subscription mode
Usage Guide	Configure to-be-subscribed events and parameters for the channel, which should be consistent with the configuration on NETCONF.

Verification

- Run the **show running** command to check whether the configuration is correct.
- Run the **show grpc channel** command to check whether servers and to-be-subscribed events are correct.

Configuration Example

- ✔ Only gRPC-related configuration is described.

▾ **Preconfiguring Servers and To-be-subscribed Events**

Scenario	The network communication between device S and PC1 is normal.
Figure 9-14 One-to-One Topology	
Configuration Steps	<p>Enable the gRPC function.</p> <p>Configure a channel.</p> <p>Configure the subscription type.</p>
S	<pre>S(config)# grpc S(config-grpc)# user-server 192.168.0.1 12345 S(config-grpc-us)# type 0x10000000 value 10</pre>
Verification	<p>Check whether the configuration is correctly saved.</p> <p>Ping the server address and check whether the address can be pinged successfully.</p> <p>Check whether the device and the server can communicate with each other properly.</p>
S	<pre>S# show running S# show grpc channel</pre>

Common Errors

The threshold for real-time events ranges from **-1** to **100**, the time interval for periodic events ranges from **-1** to **65535**, and an existing type needs to be used. Otherwise, the configuration does not take effect and is not retained.

9.4.7 Preconfiguring Information About Login Users of gRPC Servers

Configuration Effect

- After information about the login user of a gRPC server is preconfigured, information can be correctly acquired for acquisition event requests initiated by the specified gRPC server.

Notes

- The server address needs to be valid.
- The ID of a login user needs to be unique.

Related Commands

📄 Preconfiguring Information About Login Users of the gRPC Server

- Mandatory.

Command	<code>user-client id user-name ip-address</code>
Parameter	<i>id</i> : Indicates the ID of a login user.
Description	<i>user-name</i> : Indicates the username (unrelated to the AAA library; there may be no login user). <i>ip-address</i> : Indicates the allowed address.
Defaults	N/A
Command Mode	gRPC process configuration mode
Usage Guide	The device can precreate login users of authenticated servers via commands, or a server can be simulated to initiate a login request, pass authentication, and save information about the login users. The device can delete login users of authenticated servers via commands, or a server can be simulated to initiate a logout request and delete information about the login users.

Verification

- Run the **show running** command to check whether the configuration is correct.
- Run the **show grpc client** command to display information about login users.

Configuration Example

- ✔ Only gRPC-related configuration is described.

📄 Preconfiguring Information About Login Users of the gRPC Server

Scenario	The network communication between device S and PC1 is normal.
Figure 9-15 One-to-One Topology	

Configuration Steps	<p>Enable the gRPC function.</p> <p>Configure information about the login user of a specified server.</p>
S	<pre>S(config)# grpc S(config-grpc)# user-client 12345 test-user 192.168.0.1</pre>
Verification	<p>Check whether the configuration is correctly saved.</p> <p>Ping the server address and check whether the address can be pinged successfully.</p> <p>Check whether information can be acquired for an acquisition event request initiated by the server.</p>
S	<pre>S# show running S# show grpc client</pre>

9.5 Monitoring

Clearing



Running the **clear** commands may lose vital information and thus interrupt services.

Description	Command
Clears statistics of a server that can subscribe to gRPC events.	clear grpc channel [<i>ip-address port-id</i>] [counter]
Clears data of gRPC periodic events and real-time events.	clear grpc subscr [sample] [counter]

Displaying

Description	Command
Displays the IP address, port ID, and subscribed events of a server or various statistics.	show grpc channel [counter]
Displays information about login users of gRPC servers.	show grpc client
Displays the running status of gRPC.	show grpc status
Displays the statuses and statistics of subscribed events on the device.	show grpc subscr [realtime sample]

Debugging



System resources are occupied when debugging information is output. Therefore, disable the debugging switch immediately after use.

Description	Command
Debugs the gRPC function.	debug grpc { all event }

10 Configuring IFA and PSR

10.1 Overview

The In-band Flow Analyzer (IFA) and Packet Statistics Report (PSR) provide the sampling function for traffic visualization. IFA can be used to accurately determine the path and forwarding delay of specific traffic, encapsulate such information into User Datagram Protocol (UDP) packets, and send the packets to a customer's server for analysis. PSR can be used to periodically sample the Management Information Base (MIB) of an interface and interface statistics, encapsulate such information into UDP packets, and send the packets to a customer's server.

Protocols and Standards

- FS proprietary protocol

10.2 Applications

Application	Description
Traffic Visualization	Samples interface traffic on a LAN, and sends sampling results to the server for traffic analysis, so as to achieve the network monitoring purpose.

10.2.1 Traffic Visualization

Scenario

As shown in the figure below, the traffic visualization solution is configured to monitor the communication between server 1 and server 2. Network devices between the two servers are simplified as three devices shown in the figure, and the configuration of omitted intermediate devices is the same as that of switch 2. IFA sampling is enabled on switch 1, the sampling start device. IFA sampling packets have the Meta-date (MD) field added on the sampling start device switch 1, intermediate device switch 2, and sampling end device switch 3 in sequence, and switch 3 sends the packets to the IFA server for analysis.

Figure 10-1

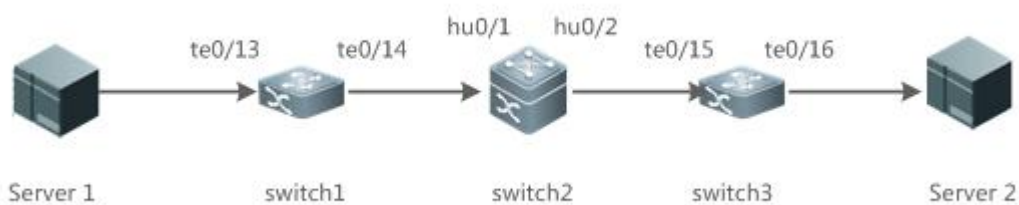

Deployment

- Configure an IFA loopback port on switch 1, and configure an IFA sampling-associated ACL, sampling rate, MD field to be added to packets on the sampling interface.
- On switch 2, configure the sampling interface to add the MD field to packets.
- On switch 3, configure server information, and configure the sampling interface to add the MD field to packets.
- Configure PSR sampling on any switch to output the MIB and statistics of the sampling interface.

10.3 Features

Basic Concepts

Using network devices as nodes and device interfaces as basic sampling units, traffic visualization utilizes hardware chips to sample and send information about traffic forwarding paths to the server for traffic monitoring. In this way, traffic status can be monitored in real time and traffic exceptions can be identified in a timely manner, thereby ensuring normal and stable network running. IFA sampling is to add information about specific traffic such as the path and timestamps to packets, encapsulate the packets into UDP packets, and send the UDP packets to the server for analysis. PSR sampling is to periodically observe information about specific interfaces.

Overview

Feature	Description
IFA Sampling	Processes packets that pass through interfaces and sends them to the server for processing.
PSR Sampling	Sends MIB, buffer, and other information of an interface to the server periodically.

10.3.1 IFA Sampling

Packets that pass through interfaces are processed and sent to the server for processing.

Working Principle

On a monitored network, the start device and end device of IFA monitoring can be selected as required and there may be multiple intermediate devices. On the start device, when packets pass through the IFA sampling interface, the interface conducts IFA sampling processing on ACL-matched packets based on the sampling configuration of the interface. The processing includes adding the INT probe header (probe mark, load length, SN, and other information) and MD field (device ID, ingress/egress information, and ingress/egress timestamp). The IFA function utilizes a loopback interface to forward packets tagged with the INT Probe header through the original ingress. The MD field also needs to be added to the packets when they pass through intermediate devices and the end device. The end device encapsulates IFA sampling results into UDP packets and sends them to the IFA server for analysis. The path and forwarding delay of specific traffic can be determined based on the MD field and other information in IFA packets.

10.3.2 PSR Sampling

In PSR sampling, the MIB and statistics of an interface are sent to the server periodically.

Working Principle

PSR sampling is to upload the MIB (device information) and buffer information (interface status and packet transmission and receiving statistics) of an interface to the server. When the PSR sampling interval expires, the above-mentioned information of the interface is encapsulated into UDP packets and sent to the server for analysis.

10.4 Product Description



Currently, only S6510 series devices can be used as the IFA end device. Therefore, only S6510 series devices can encapsulate IFA sampling packets and send the encapsulated packets to a specified server.



Currently, only S6510 series devices can be used as the IFA end device. Therefore, only S6510 series devices support server information configuration and only one server can be configured.



Currently, only S6510 series devices can be used as the IFA start device. Therefore, only S6510 series devices support IFA ACL configuration for sampling.



Currently, only S6510 series devices can be used as the IFA start device. Therefore, only S6510 series devices support the configuration of the IFA host port.



Currently, S6510 series devices do not support filtering of IFA sampling packets.

10.5 Configuration

Configuration	Description and Command	
<u>Configuring IFA Basic Functions</u>	(Mandatory) It is used to establish the connection and communication between the IFA sampling end device and the server.	
	ifa server <i>server-name</i> source	Configures an IFA server.
	ifa send-server <i>server-name</i> [acl id <i>name</i>]	Configures the name of the server to which IFA packets of an interface are to be sent, and ACL rules.
	(Mandatory) It is used to enable the IFA sampling function.	
	ifa set-loopback interface <i>interface-name</i>	Configures an IFA loopback interface.
	ifa acl	Configures an IFA sampling-associated ACL and sampling rate.
	ifa set-header md	Adds the MD field to the header of IFA sampling packets.
	(Optional) It is used to filter IFA packets.	
	ifa filter enable	Filters IFA packets on an interface.
	ifa host-port	Configures an interface as the IFA server port.
<u>Configuring PSR Basic Functions</u>	(Optional) It is used to configure the address of an IFA device.	
	ifa set-device	Configures the address of an IFA device.

psr server <i>server-name source</i>	Configures a PSR server.
psr send-server <i>server-name</i>	Configures the name of the server to which PSR packets of an interface are to be sent.
(Optional) It is used to adjust the transmission interval and packet length of PSR sampling packets.	
psr interval <i>seconds</i>	Configures the time interval for PSR sampling.
psr collect-interface <i>numbers</i>	Configures the number of interfaces whose sampling information is to be encapsulated into PSR packets.

10.5.1 Configuring IFA Basic Functions

Configuration Effect

- The IFA sampling end device can communicate with the server.
- An interface processes packets that pass through the interface based on the sampling rate and sends the packets to the server for processing.

Configuration Steps

▾ Configuring an IFA Server

- Mandatory.
- Configure IFA server information on an end device.
- Configure the **ifa send-server** *server-name* command on a specified interface of the same end device so that IFA sampling packets can be encapsulated and sent to the specified server.

Command	ifa server <i>server-name source ip-address port udp-port destination ip-address port udp-port</i>
Parameter Description	<i>server-name</i> : Indicates the name of an IFA server. <i>ip-address</i> : Specifies the source and destination IPv4 addresses of IFA encapsulated packets. <i>udp-port</i> : Specifies the server port.
Defaults	No IFA server is configured by default.
Command Mode	Global configuration mode
Usage Guide	This command is used to configure the source and destination addresses of IFA encapsulated packets. The addresses can be host addresses only. When a non-host address (such as a multicast address or broadcast address) is configured, a configuration failure occurs. The IFA server listens to a configured port.

▾ Configuring the Name of the Server to Which IFA Packets of an Interface Are to Be Sent

- Mandatory.
- Configure the **ifa send-server** *server-name [acl id | name]* command on a specified interface of an end device so that IFA sampling packets of the interface are encapsulated and sent to the specified server.
- The IFA server information needs to be configured on the same end device so that IFA sampling packets can be encapsulated and sent to the specified server.

Command	ifa send-server <i>server-name [acl id name]</i>
Parameter	<i>server-id</i> : Indicates the name of an IFA server.

Description	<i>id</i> : ACL number <i>name</i> : ACL name
Defaults	IFA packets are not sent by default.
Command Mode	Interface configuration mode
Usage Guide	This command can be configured only on physical ports and aggregation ports (APs). Packets can be sent to the IFA server only after the IP address of the IFA server is configured. The ACL rule is optional configuration. All the IFA packets on the interface will be sent to the server when no ACL rule is configured. To send the IFA packets matching the ACL rule to the specified server, configure the ACL rule first, and then apply the rule on the interface.

↘ Configuring an IFA Loopback Interface

- Mandatory.
- Configure a physical port on a start device as the IFA loopback port of the device.

Command	ifa set-loopback interface <i>interface-name</i>
Parameter Description	<i>interface-name</i> : Indicates an interface name.
Defaults	No IFA loopback interface is configured by default.
Command Mode	Global configuration mode
Usage Guide	This command can be configured only on physical ports.

↘ Configuring an IFA Sampling–Associated ACL and Sampling Rate

- Mandatory.
- Configure sampling rules on a start device.
- A smaller sampling rate indicates lower sampling accuracy.

Command	ifa acl { <i>id</i> <i>name</i> } rate <i>rate</i>
Parameter Description	<i>id</i> : Indicates the ACL ID. <i>name</i> : Indicates the ACL name. <i>rate</i> : Indicates the sampling rate. The value ranges from 1 to 65535 and the default value is 1000 .
Defaults	IFA sampling is disabled by default.
Command Mode	Interface configuration mode
Usage Guide	This command can be configured only on physical ports and APs. It is used to configure an IFA sampling–associated ACL and sampling rate. Four sampling rules using different ACLs and sampling rates can be configured for one interface.

↘ Adding the MD Field to the Header of IFA Sampling Packets

- Mandatory.
- Complete this configuration on a device interface that needs IFA sampling.

Command	ifa set-header md
Parameter	N/A

Description	
Defaults	No MD field is added to packets by default.
Command Mode	Interface configuration mode
Usage Guide	This command can be configured only on physical ports and APs. This command is required on the ports of the non-end hop device that forwards the IFA sampling packets. Otherwise, the IFA sampling packets may not be able to be re-encapsulated and sent to the server, or the packets information may be incomplete.

↘ **Filtering IFA Sampling Packets on an Interface**

- Optional.
- Complete this configuration on a device interface that needs IFA sampling.

Command	ifa filter enable
Parameter Description	N/A
Defaults	IFA sampling packets are not filtered by default.
Command Mode	Interface configuration mode
Usage Guide	This command can be configured only on physical ports and APs.

↘ **Configuring an Interface as the IFA Server Port**

- Optional.
- Complete this configuration on a device interface connected to the IFA server.

Command	ifa host-port
Parameter Description	N/A
Defaults	No interface is configured as the IFA server port by default.
Command Mode	Interface configuration mode
Usage Guide	This command can be configured only on physical ports and APs. The IFA server port can be configured only after the IFA server is configured.

↘ **Configuring the Address of an IFA Device**

- Optional.
- Complete this configuration on a device interface that needs IFA sampling.

Command	ifa set-device
Parameter Description	N/A
Defaults	The address of an IFA device is not configured by default.
Command Mode	Global configuration mode
Usage Guide	N/A

Verification

- Run the **show run** command to display IFA configuration and check whether the displayed configuration is consistent with the actual configuration.

Configuration Example

📌 **Configuring IFA Sampling**

<p>Scenario</p> <p>Figure 10-2</p>	
<p>Configuration Steps</p>	<ul style="list-style-type: none"> ● On the start device switch 1, configure TenGigabitEthernet 0/1 as an IFA loopback interface, enable IFA sampling on the interface on the packet path, and configure the interface to add the MD field to packets. ● On the intermediate device switch 2, configure the interface on the packet path to add the MD field to packets. ● On the end device switch 3, configure the interface on the packet path to add the MD field to packets and configure IFA server information.
<p>Switch 1</p>	<pre> FS# configure terminal FS(config)# access-list 100 permit ip any any FS(config)# ifa set-loopback interface TenGigabitEthernet 0/1 FS(config)# interface TenGigabitEthernet 0/13 FS(config-if-TenGigabitEthernet 0/13)# ifa acl 100 rate 100 FS(config-if-TenGigabitEthernet 0/13)# ifa set-header md FS(config-if-TenGigabitEthernet 0/13)# interface TenGigabitEthernet 0/14 FS(config-if-TenGigabitEthernet 0/14)# ifa set-header md FS(config-if-TenGigabitEthernet 0/14)# end </pre>
<p>Switch2</p>	<pre> FS# configure terminal FS(config)# interface HundredGigabitEthernet0/1 FS(config-if-HundredGigabitEthernet0/1)# ifa set-header md FS(config-if-HundredGigabitEthernet0/1)# interface HundredGigabitEthernet0/2 FS(config-if-HundredGigabitEthernet0/2)# ifa set-header md FS(config-if-HundredGigabitEthernet0/2)# end </pre>
<p>Switch3</p>	<pre> FS# configure terminal FS(config)# ifa server server1 source 192.168.2.100 port 1000 destination 192.168.2.101 port 2000 FS(config)# interface TenGigabitEthernet 0/15 FS(config-if-TenGigabitEthernet 0/15)# ifa set-header md FS(config-if-TenGigabitEthernet 0/15)# interface TenGigabitEthernet 0/16 FS(config-if-TenGigabitEthernet 0/16)# ifa set-header md FS(config-if-TenGigabitEthernet 0/16)# ifa send-server server1 FS(config-if-TenGigabitEthernet 0/16)# end </pre>

Verification

- Run the **show run** command to check whether displayed information is consistent with the configuration.
- Enable packets matching the ACL to transmit from TenGigabitEthernet0/13 of switch 1 and pass through the interfaces above. Check whether the server receives IFA packets from switch 3 and whether sampling data in the packets is correct.
- Run the **show ifa statistics** command to display statistics.

```
FS# show ifa statistics
Type          Acl    Statistic(pkts)  Applied interface
-----
sample-to-cpu 100    20426            Te0/13-14
sample-to-cpu 101    0                TF0/2
insert-md     -      20586            Hu0/1-2, Te0/13-16
```

10.5.2 Configuring PSR Basic Functions

Configuration Effect

- The PSR sampling end device can communicate with the server.
- The PSR sampling end device sends statistics of an interface to the server based on the sampling time interval.

Notes

- A very small sampling time interval may affect forwarding performance.

Configuration Steps

▾ Configuring a PSR Server

- Mandatory.
- Configure the **psr send-server server-name** command on a specified interface of the same end device so that PSR sampling packets can be encapsulated and sent to the specified server.

Command	psr server server-name source ip-address port udp-port destination ip-address port udp-port
Parameter Description	<i>server-id</i> : Indicates the name of a PSR server. <i>ip-address</i> : Specifies the source and destination IPv4 addresses of PSR encapsulated packets. <i>udp-port</i> : Specifies the server port.
Defaults	No PSR server is configured by default.
Command Mode	Global configuration mode
Usage Guide	This command is used to configure the source and destination addresses of PSR encapsulated packets. The addresses can be host addresses only. When a non-host address (such as a multicast address or broadcast address) is configured, a configuration failure occurs. The PSR server listens to a configured port.

▾ Configuring the ID of the Server to Which PSR Packets of an Interface Are to Be Sent

- Mandatory.
- The PSR server information needs to be configured on the end device so that PSR sampling packets can be encapsulated and sent to the specified server.

Command	psr send-server server-name
----------------	------------------------------------

Parameter Description	<i>server-id</i> : Indicates the name of a PSR server.
Defaults	PSR packets are not sent by default.
Command Mode	Interface configuration mode
Usage Guide	This command can be configured only on physical ports and APs. Packets can be sent to the PSR server only after the IP address of the PSR server is configured.

↘ **Configuring the Time Interval for PSR Sampling**

- Optional.
- The actual transmission interval is subject to the CPU usage.

Command	psr interval <i>seconds</i>
Parameter Description	<i>seconds</i> : Indicates the time interval, in seconds. The value ranges from 1 to 100 and the default value is 5 .
Defaults	5
Command Mode	Global configuration mode
Usage Guide	This command is used to configure the global time interval for PSR sampling. The PSR sampling of all interfaces uses this sampling interval.

↘ **Configuring the Number of Interfaces Whose Sampling Information Is to Be Encapsulated into PSR Packets**

- Optional.
- This command affects the actual PSR packet length.

Command	psr collect-interface <i>numbers</i>
Parameter Description	<i>numbers</i> : Indicates the interface quantity. The value ranges from 1 to 100 , and the default value is 1 .
Defaults	The default value is 1.
Command Mode	Global configuration mode
Usage Guide	This command is used to configure the number of interfaces whose sampling information is to be encapsulated into PSR packets.

Verification

- Run the **show run** command to display PSR configuration and check whether the displayed configuration is consistent with the actual configuration.

Configuration Example

↘ **Configuring PSR Sampling**

<p>Scenario</p> <p>Figure 10-3</p>	
<p>Configuration Steps</p>	<ul style="list-style-type: none"> ● Configure PSR server information on any device on the network and enable PSR sampling on interfaces. ● Set the PSR sampling interval to 10s in global configuration mode.
<p>Switch3</p>	<pre> FS# configure terminal FS(config)# psr server server1 source 192.168.2.100 port 1001 destination 192.168.2.101 port 2002 FS(config)# psr interval 10 FS(config)# psr collect-interface 2 FS(config)# interface TenGigabitEthernet 0/16 FS(config-if-TenGigabitEthernet 0/16)# psr send-server server1 FS(config-if-TenGigabitEthernet 0/16)# end </pre>
<p>Verification</p>	<ul style="list-style-type: none"> ● Run the show run command to check whether displayed information is consistent with the configuration. ● Check whether the server receives PSR sampling data from the TenGigabitEthernet 0/16 interface of switch 3 every 10s. ● Run the show psr statistics command to display statistics. <pre> FS# show psr statistics Server id Name Statistic(pkts) Applied interface ----- 1 server1 20426 Te0/16 </pre>

10.6 Monitoring

Clearing

Description	Command
Clears IFA statistics.	clear ifa statistics
Clears PSR statistics.	clear psr statistics

Displaying

Description	Command
Displays IFA and PSR configuration.	show run
Displays IFA statistics.	show ifa statistics
Displays PSR statistics.	show psr statistics

11 Configuring IPFIX

11.1 Overview

The IP Flow Information eXport (IPFIX) is a standard protocol published by the Internet Engineering Task Force (IETF) for the measurement of flow information on networks. It standardizes the format of network traffic statistics so that network devices and servers from different vendors can interwork with each other.

Through IPFIX, users can learn about the current network situation, including the interface rate, traffic, and traffic of various applications. Then, network optimization, security detection, and traffic charging can be carried out based on the information.

Protocols and Standards

- RFC 5470: Architecture for IP Flow Information Export
- RFC 5472: IP Flow Information Export (IPFIX) Applicability
- RFC 5103: Bidirectional Flow Export Using IP Flow Information Export (IPFIX)
- RFC 5153: IP Flow Information Export (IPFIX) Implementation Guidelines
- RFC 5102: Information Model for IP Flow Information Export
- RFC 5101: Specification of the IP Flow Information Export (IPFIX) Protocol for the Exchange of IP Traffic Flow Information
- RFC 3917: Requirements for IP Flow Information Export
- RFC 3954: Cisco Systems NetFlow Services Export Version 9

11.2 Applications

Application	Description
Deploying IPFIX Sampling on a Network	Deploy the IPFIX sampling function on a network to collect statistics on the network traffic.

11.2.1 Deploying IPFIX Sampling on a Network

Scenario

Deploy the IPFIX sampling function on a network to collect statistics on the network traffic.

As shown in the figure below, statistics on the network traffic need to be collected.

Figure 11-1 IPFIX Sampling Application

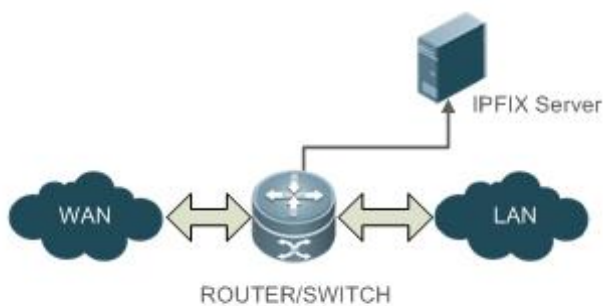

Remarks	The server serves as the IPFIX server to analyze IPFIX information.
----------------	---

The router/layer-3 switch collects traffic information and sends the information to the IPFIX server.

Deployment

- Enable the IPFIX sampling function on the egress of the router/layer-3 switch.
- Configure the output of IPFIX packets to the IPFIX server on the router/layer-3 switch.
-  The IPFIX server software is generally commercial software and ManageEngine NetFlow Analyzer is recommended.

11.3 Features

Basic Concepts

↘ IPFIX Sampling

A network device receives packets from one interface and sends them out through another interface. When IPFIX needs to analyze packets, it is necessary to specify the interface and inbound/outbound direction for packet statistics. This is called sampling. FS devices allow you to specify the interface for packet sampling in the inbound or outbound direction or in both directions.

↘ IPFIX Flow

A network forwarding device forwards packets one after another based on the destination address of the packets. It does not need to know the relevance between these packets, which actually exists. For example, the packets may belong to the same TCP session.

A packet consists of a series of properties, such as the IP address and TCP port number. Different packets may share some identical properties. A succession of consecutive packets with some identical properties that pass through a detection point within a period of time is called one packet flow. Properties used to determine whether packets belong to the same flow are key properties of the flow. Packets with the same key properties belong to the same flow. These properties can be some fields in the IP packet header such as the source IP address, the ToS field, or any combination of these fields. In the IPFIX implementation on FS devices, one flow is jointly determined by the following key fields:

- Source IP address
- Destination IP address
- Source port number
- Destination port number
- Layer-3 protocol type
- ToS
- Index of the packet sampling interface

The seven key fields jointly determine a unique flow. Packets sharing the same seven fields belong to the same flow. A packet with even only one key field different from other packets belongs to a different flow. One flow also has other statistical fields, such as the number of packets, next-hop IP address, and total number of flow bytes. Flow information on FS devices also includes the following:

- Flow establishment time
- Flow transmission time
- Total number of packets
- Total number of bytes
- Start time of the first flow

- End time of the final flow
- Inbound interface index of the flow (for inbound sampling)
- Outbound interface index of the flow (for outbound sampling)
- i** IPFIX flow described here is also known as IPFIX basic flow or main mode flow.

↘ IPFIX Flow Table

An IPFIX flow table stores information about measured IP flows. When receiving an IP packet, the device, based on its flow key fields in the packet, searches the main cache for records about the flow. If no record about the flow exists, the device creates a flow record and records the flow information. If records about the flow exist, the device updates flow statistics in the flow records, such as the number of packets and number of flow bytes. For flow information in the IPFIX flow table in FS devices, see the IPFIX flow section.

For example, the device receives the following packets in sequence:

First packet:

Source IP address	192.168.196.3
Destination IP address	218.30.66.101
Source port number	1000
Destination port number	80
Layer-3 protocol type	TCP
ToS	0x0
...	
Bytes	100
Time	2009/4/8 11:21:13

The flow table is empty. The device creates a new flow entry for the packet and records the flow information.

Input ifx	Gi 1/0	
Src ip	192.168.196.3	
Dst ip	218.30.66.101	
Pro	TCP	
src port	1000	
Dst port	80	
Tos	0	
Start time	2009/4/8 11:21:13	
Stop time	2009/4/8 11:21:13	
packet	1	
bytes	100	

Second packet:

Source IP address	192.168.196.3
Destination IP address	218.30.66.101
Source port number	2000
Destination port number	80
Layer-3 protocol type	TCP
ToS	0x0

Input logical interface	Gi 1/0
...	
Bytes	100
Time	2009/4/8 11:21:14

The second packet has a different source interface from the first packet and therefore, it belongs to a new flow. Then, the device creates a new flow entry for this packet and records the flow information.

Input ifx	Gi 1/0	Gi 1/0
Src ip	192.168.196.3	192.168.196.3
Dst ip	218.30.66.101	218.30.66.101
Pro	TCP	TCP
src port	1000	2000
Dst port	80	80
Tos	0	0
Start time	2009/4/8 11:21:13	2009/4/8 11:21:14
Stop time	2009/4/8 11:21:13	2009/4/8 11:21:14
packet	1	1
bytes	100	100

Third packet:

Source IP address	192.168.196.3
Destination IP address	218.30.66.101
Source port number	1000
Destination port number	80
Layer-3 protocol type	TCP
ToS	0x0
Input logical interface	Gi 1/0
...	
Bytes	100
Time	2009/4/8 11:21:15

The third packet has the same key fields as the first packet and belongs to the same flow as the first packet. The device updates information in the first flow entry.

Input ifx	Gi 1/0	Gi 1/0
Src ip	192.168.196.3	192.168.196.3
Dst ip	218.30.66.101	218.30.66.101
Pro	TCP	TCP
src port	1000	2000
Dst port	80	80
ToS	0	0
Start time	2009/4/8 11:21:13	2009/4/8 11:21:14 AM
Stop time	2009/4/8 11:21:15 AM	2009/4/8 11:21:14 AM
packet	2	1
bytes	200	100

i IPFIX flow table described here is also known as the IPFIX basic flow table or main mode flow table. It is used to store information about basic flows.

Basic Functions of IPFIX

An IPFIX device provides the following basic functions:

1. Collecting statistics on flows: The device acquires packet properties from a received packet and searches the flow table based on the seven key fields. If no relevant flow records exist in the flow table, the packet belongs to a new flow. Then, the device creates a flow entry and collects statistics on the flow. If the packet belongs to a recorded flow, the device updates the flow statistics.
2. Exporting flow information to the server: The device sends flow statistics to the server for analysis at appropriate time.

i The IPFIX specification defines only how the IPFIX device exports flow records. The storage and analysis (implemented by the IPFIX server) of flow records are beyond the scope of the IPFIX specification.

Overview

Feature	Description
IPFIX Flow Statistics	Creates an IPFIX flow table and collects statistics on traffic in the network.
IPFIX Flow Aging	Deletes flow records from the flow table and exports statistics to the server before deletion.
IPFIX Flow Export	Exports flow record statistics to the server.

11.3.1 IPFIX Flow Statistics

The IPFIX flow statistics function module is used to create a flow table, extract information from packets, and collect statistics on traffic in the network.

Working Principle

Figure 11-2 IPFIX Flow Statistics Process on the Network Device

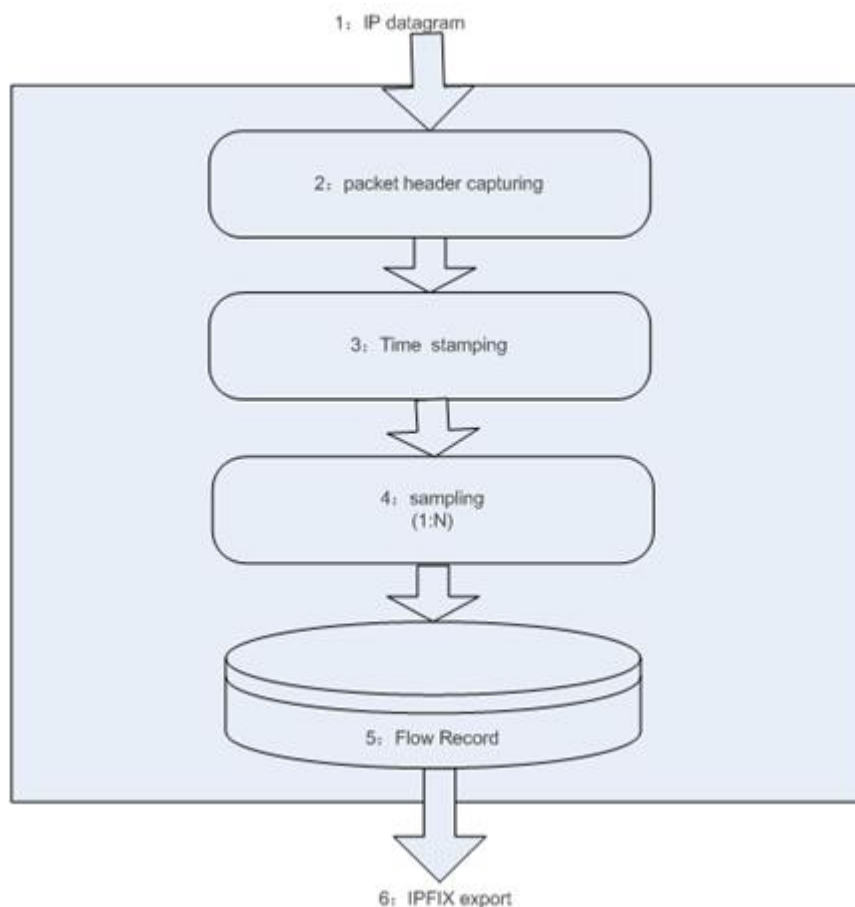

- A network device forwards packets normally. It receives a packet from an interface and sends it out through another interface.
- The IPFIX function module of the network device extracts relevant packet properties (such as the IP address and packet length) from the packet header.
- The device adds a timestamp to the packet for the purpose of recording the flow establishment time, flow transmission time, and duration.
- The device conducts sampling on packets according to the configuration. Sampling here refers to processing one packet out of every n packets. For example, 1:100 sampling rate indicates that one packet is selected for processing by subsequent modules in every 100 packets. If the configured sampling rate is 1:1, all packets will be processed.
- The device collects statistics on the flow. If no record about a flow exists, the device creates a flow record. If the flow record exists, the device updates flow information (such as the number of packets and number of bytes).
- Flow records will be deleted at specific time and exported to the IPFIX server.

11.3.2 IPFIX Flow Aging

Flow records in the flow table need to be deleted under certain circumstances, and the statistics need to be exported to the server before deletion. This process is called flow aging. Flow aging aims to avoid infinite growth of the flow table and ensure that the IPFIX server can receive flow statistics.

Working Principle

- When no packet belonging to a flow is received within a period of time (inactive aging time), the flow has aged and the flow information should be exported.
- A flow may last very long and its information cannot be recorded infinitely. Users can set a time (active aging time) for flow aging. When the duration of a flow exceeds the time, the flow should be aged.
- IPFIX-relevant configuration can be performed to age flow records.

If a flow entry is aged and deleted but a packet with the seven key fields same as the aged flow is received very soon, a new flow entry will be created for the packet because no entry about the flow exists in the flow table.

11.3.3 IPFIX Flow Export

IPFIX flow export refers to exporting aged flow records to the IPFIX server, which analyzes flow records.

Working Principle

After aging, flow records need to be exported to the server. In this case, the flow record will be encapsulated into a UDP or TCP packet in the format defined in IPFIX and sent to the configured server. The collector on the server will process the record. The collector is a special software tool for processing flow records. It can visually display the current network status and analyze network traffic based on received flow records.

The IPFIX device transmits flow records by using a template. Before transmitting flow records, the device generates a template in the flow record format and sends it to the server regularly. The template defines properties and length of fields in the flow record. IPFIX has defined up to hundreds of field properties and each property has an identifier to mark its meaning. For example, identifier 8 indicates the source IP address. After receiving the template, the server knows the format of the subsequent flow record from the template, and interprets the IPFIX flow record based on the flow record format defined in the template. The template and flow record can be stored in the same packet or one packet can contain multiple flow records or templates.

The IPFIX device can send only important properties of a flow. The server software can extract only useful flow properties from flow records and ignore other properties. For example, FS devices consider the TCP flag useful for network security analysis, and carry the TCP flag in exported flow information. But some server software is used for traffic analysis only and does not support network analysis, and therefore ignores the TCP flag. There is no compatibility issue between the device and server.

Likewise, when a network device adds new fields (flow properties) to flow records, the network device needs to only re-create a data template. The server interprets flow records based on the new template, with no need to upgrade the server software, greatly enhancing the scalability.

The following uses UDP as an example to describe the IPFIX template and data.

Figure 11-3 IPFIX Packet

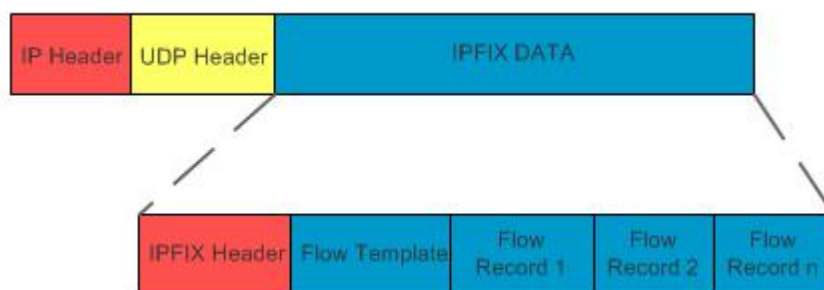

As shown in the figure above, an IPFIX packet contains a template and flow records. An IPFIX header is added to the front of the IPFIX packet and is transmitted over UDP.

Figure 11-4 IPFIX Template and Data

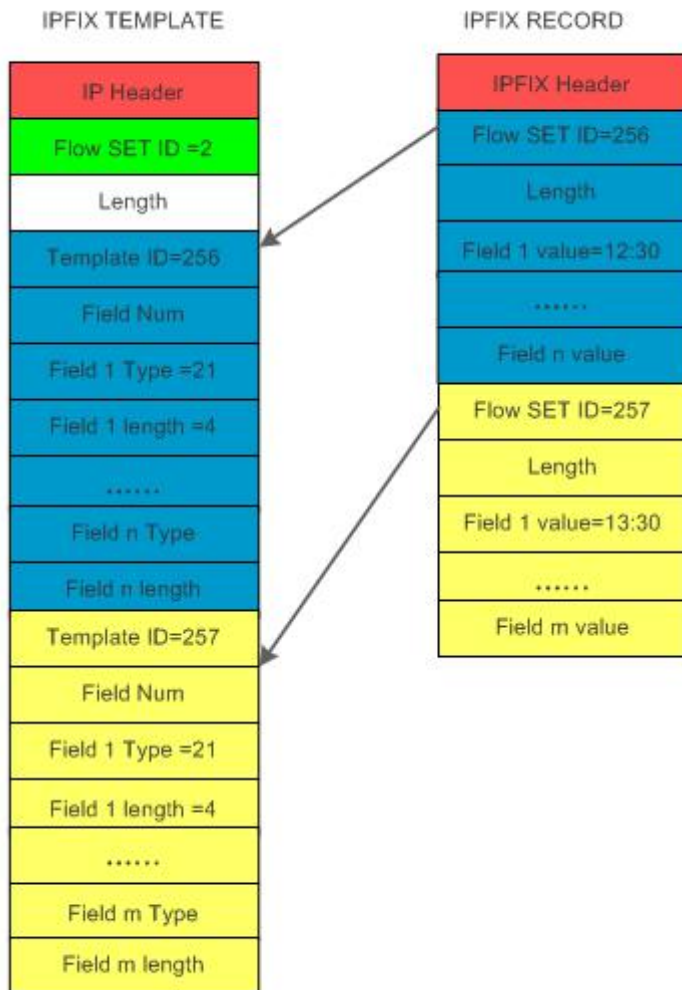

The IPFIX template format is described as follows:

Flow Set ID = 2 indicates that subsequent content is a template, which defines the format of flow records.

Length indicates the template length.

Template ID = 256 indicates that subsequent content is the format of a flow record of type 256.

Field Num indicates the number of fields composing a flow record format.

Field n type indicates the meaning of field N in the flow record. The meaning of each value is defined in detail in the IPFIX specification. For example, Field 1 type = 21 defines that the first field of a flow record indicates the flow establishment time.

Field n length indicates the number of bytes of field N in the flow record. For example, Field 1 length = 4 defines that the first field of a flow record indicates the flow establishment time and the value occupies four bytes.

A template can define the format of a flow record, including the number of fields composing the template, meaning of each field, and data bit width.

Description of the IPFIX data format:

Flow Set ID = 256 indicates that subsequent content is a flow record and the record is interpreted according to template 256.

Length indicates the data length.

Field n Value indicates the value of field N in the flow record. For example, Field 1 Value = 12:30 indicates that the flow establishment time is 12:30 and occupies four bytes (the meaning and bit width have been defined in the template).

11.4 Configuration

Configuration	Description and Command	
Configuring the IPFIX Flow Statistics Function	(Mandatory) It is used to enable IPFIX sampling.	
	{ ip } flow ingress	Enables the IPFIX function in the inbound direction of an interface.
	{ ip } flow egress	Enables the IPFIX function in the outbound direction of an interface.
	flow-sampler <i>sampler-map-name</i> [egress]	Configures the sampling rate rule on an interface.
	flow-sampler-map <i>sampler-map-name</i>	Enters the sampling rate rule configuration mode.
	mode random one-out-of <i>packet-interval</i>	Configures the sampling rate rule.
Configuring the Export of Main Mode Flow Records	(Mandatory) It is used to configure the export of IPFIX flow records.	
	{ ip ipv6 } flow-export destination	Configures the address of the server, to which flow records are to be exported.
	{ ip ipv6 } flow-export version	Configures the format for packets to be exported.
	{ ip ipv6 } flow-export source	Configures the source interface for exporting packets.
	{ ip ipv6 } flow-export template	Configures parameters relevant to an export template.
Configuring Parameters for the Main Mode Flow Table	(Optional) It is used to configure parameters for the IPFIX main mode flow table.	
	{ ip ipv6 } flow-cache timeout	Configures the aging time of flow records.

11.4.1 Configuring the IPFIX Flow Statistics Function

Configuration Effect

- Collect statistics on IPv4 traffic on the network.
- Collect statistics on IPv6 traffic on the network.

Notes

N/A

Configuration Steps

➤ Enabling the IPFIX Function in the Inbound Direction of an Interface

- Mandatory.

- Run the **{ ip } flow ingress** command on a specified interface to enable the IPFIX function in the inbound direction of the interface.

Command	{ ip } flow ingress
Parameter	N/A
Description	
Defaults	The IPFIX function is disabled by default.
Command Mode	Interface configuration mode
Usage Guide	N/A

↘ Enabling the IPFIX Function in the Outbound Direction of an Interface

- Mandatory.
- Run the **{ ip } flow egress** command on a specified interface to enable the IPFIX function in the outbound direction of the interface.

Command	{ ip } flow egress
Parameter	N/A
Description	
Defaults	The IPFIX function is disabled by default.
Command Mode	Interface configuration mode
Usage Guide	N/A

↘ Entering the Sampling Rate Rule Configuration Mode

- Mandatory.
- In global configuration mode, run the **flow-sampler-map *sampler-map-name*** command to enter the sampling rate rule configuration mode and then configure sampling rate rules.
- If you enter the sampling rate rule configuration mode but do not configure sampling rate rules, the **show run** command will not show the sampling rate rule configuration mode.

Command	flow-sampler-map <i>sampler-map-name</i>
Parameter	<i>sampler-map-name</i> : Indicates the name of a sampling rate rule.
Description	
Defaults	No sampling rate rule is configured by default.
Command Mode	Global configuration mode
Usage Guide	This command is used to enter the sampling rate rule configuration mode.

↘ Configuring the Sampling Rate Rule

- Mandatory.
- In sampling rate rule configuration mode, run the **mode random one-out-of *packet-interval*** command to configure a sampling rate rule, that is, to conduct sampling once every *packet-interval* packets.

- You need to run the **flow-sampler** *sampler-map-name* [**egress**] command on a specified interface for the sampling rate rule to take effect on the interface.

Command	mode random one-out-of <i>packet-interval</i>
Parameter	<i>packet-interval</i> : Indicates the sampling interval, that is, sampling is conducted once every <i>packet-interval</i> packets.
Description	
Defaults	No random sampling rate rule is defined by default.
Command	Sampling rate rule configuration mode
Mode	
Usage Guide	N/A

📌 Applying the Sampling Rate Rule Configuration to an Interface

- Mandatory.
- Run the **flow-sampler** *sampler-map-name* [**acl { id | name } | egress**] command on a specified interface to enable the IPFIX function in the inbound/outbound direction of the interface and collect statistics on incoming/outgoing traffic of the interface.

Command	flow-sampler <i>sampler-map-name</i> [acl { id name } egress]
Parameter	<i>sampler-map-name</i> : Indicates the name of a sampling rate rule.
Description	egress : Indicates the outbound direction. The rule is applied to the inbound direction if no direction is specified. id : Indicates the ACL ID. name : Indicates the ACL name.
Defaults	No sampling rate rule is applied to an interface by default.
Command	Interface configuration mode
Mode	
Usage Guide	An ACL is applied only to inbound sampling by default. That is, if an ACL is configured or egress is not specified, the configured sampling rate rule is applied to inbound sampling. Configure an ACL before applying a sampling rate rule. After the ACL is applied to an interface, sampling is conducted on packets matching the ACL.

Verification

- Run the **show ip flow interface** command to display the IPFIX configuration of an interface.
- Run the **show { ip | ipv6 } flow cache** command to display flow table information of the device.

Configuration Example

📌 Configuring the IPFIX Sampling Function

Configuration Steps	<ul style="list-style-type: none"> ● Interface GigabitEthernet 1/1 is connected to the Internet and the Internet traffic needs to be monitored and analyzed. ● Enable the IPFIX function on interface GigabitEthernet 1/1.
	<pre> FS# config terminal FS(config-sampler)# mode random one-out-of 10000 FS(config-sampler)# exit FS(config)# interface gigabitEthernet 1/1 FS(config-if)# flow-sampler my-sampler </pre>

	<p>Or</p> <pre>FS(config-if)# flow-sampler my-sampler egress FS(config-if)# ip flow ingress FS(config-if)# ip flow egress</pre>
Verification	<ul style="list-style-type: none"> ● Run the show ip flow interface command to display the interface configuration. ● Generate traffic on interface gigabitEthernet 1/1. If the ip flow ingress command is configured, statistics on incoming traffic of interface gigabitEthernet 1/1 are collected. If the ip flow egress command is configured, statistics on outgoing traffic of interface gigabitEthernet 1/1 are collected. Run the show ip flow cache command to check traffic statistics.
	<pre>FS# show ip flow interface interface GigabitEthernet 1/1 flow-sampler my-sample flow-sampler my-sampler egress ip flow ingress ip flow egress</pre>

Common Errors

N/A

11.4.2 Configuring the Export of Main Mode Flow Records

Configuration Effect

- Send aged main mode flow records to the server.

Notes

- The route to the configured address of the server, to which flow records are to be exported, must be reachable. Otherwise, the **show { ip | ipv6 } flow export** command displays nothing.
- If the type of interface used for exporting flow records is changed from port to VLAN and the interface is an SVI, you also need to configure IPFIX on the VLAN interface.

Configuration Steps

➤ **Configuring the Address of the Server, to Which Flow Records Are to Be Exported**

- Mandatory.
- You can run the **{ ip | ipv6 } flow-export destination** command to export aged flow records to the IPFIX server.
- A maximum of two IPFIX servers can be configured for record output.

Command	{ ip ipv6 } flow-export destination { ipv6 ipv6_addr ip-address hostname } udp-port [[vrf vrf-name] [oob [via mgmt mgmt-name]]]
Parameter	ipv6 ipv6_addr : Sets an IPv6 address of the server, to which flow records are to be exported.

Description	<p><i>ip-address</i>: Sets an IPv4 address of the server, to which flow records are to be exported.</p> <p><i>hostname</i>: Sets a domain name of the server, to which flow records are to be exported.</p> <p><i>udp-port</i>: Indicates the ID of the server port used for monitoring IPFIX packets.</p> <p>vrf vrf-name: Indicates the name of the VRF instance, to which the server address belongs.</p> <p>oob: Indicates that sampled packets are exported from the management port. It is not configured by default.</p> <p>mgmt mgmt-name: Indicates the name of the management port for exporting sampled packets. It is not configured by default.</p>
Defaults	IPFIX flow records are not exported to the server by default.
Command	Global configuration mode
Mode	
Usage Guide	IPFIX flow records of IPv4 and IPv6 protocol packets can be exported to a server with either an IPv4 or IPv6 address.

⤵ **Configuring the Format for Packets to Be Exported**

- Optional.
- Run the { **ip | ipv6** } **flow-export version** command to specify the format of packets to be exported.

Command	{ ip ipv6 } flow-export version { 9 10 }
Parameter	version 9 : Indicates that the format of to-be-exported packets complies with the Netflow V9 standard.
Description	version 10 : Indicates that the format of to-be-exported packets complies with the IETF standard.
Defaults	The version10 packet format is adopted by default.
Command	Global configuration mode
Mode	
Usage Guide	N/A

⤵ **Configuring the Source Interface for Exporting Packets**

- Optional.
- Perform the configuration when aged flow records need to be exported to the server and the source IP address of packets needs to be specified.

Command	{ ip ipv6 } flow-export source <i>interface-name</i>
Parameter	source <i>interface-name</i> : Indicates the interface name.
Description	
Defaults	By default, the local interface address that best-matches the server address is adopted.
Command	Global configuration mode
Mode	
Usage Guide	<p>This command is used to configure the source IP address for packets to be exported. The default source address of IPFIX packets to be exported is the local address that best-matches the server address. When the source interface is specified, the source address of the IPFIX packets to be exported is the main address of the interface (the IPv6 address is the first global IPv6 address of the interface).</p> <p>When no source interface is specified, the source address of the IPFIX packets to be exported is the local address that best-matches the server address. The server address can be an IPv4 or IPv6 address or both. If the source interface is specified and the server address is set to an IPv6 address, ensure that an IPv6 address is configured for the source interface. If the server address is set to an IPv4 address, ensure that an IPv4 address is configured for the source interface. Otherwise, the system obtains the best-matched local address as the source address based on the server address. You</p>

	must ensure that the source interface and the server, to which flow records are to be exported, belong to the same VRF instance. Otherwise, the system obtains the best-matched local address as the source address based on the server address.
--	--

⤵ Configuring Parameters Relevant to an Export Template

- Optional.
- Perform the configuration when the template export frequency needs to be adjusted. The IPFIX server parses IPFIX packets according to the template. When the IPFIX function is enabled on the device at the first start, you can set the template retransmission frequency to a smaller value so that the IPFIX server can receive the IPFIX template soon, for example, set the retransmission interval to 1 minute.

Command	<code>{ ip ipv6 } flow-export template { refresh-rate packets timeout-rate minutes options { export-stats refresh-rate packets timeout-rate minutes } model model-id }</code>
Parameter Description	<p>refresh-rate packets: Specifies the template retransmission frequency, with the unit of packets. The value ranges from 1 to 600 and the default value is 20.</p> <p>timeout-rate minutes: Specifies the template retransmission interval, with the unit of minutes. The value ranges from 1 to 3600 and the default value is 10.</p> <p>options export-stats: Enables the export of option packets.</p> <p>options refresh-rate packets: Sets the retransmission frequency of option data, with the unit of packets. The value ranges from 1 to 600. The default value is 20.</p> <p>options timeout-rate minutes: Sets the retransmission interval of option data. The value ranges from 1 to 3600. The default value is 10 minutes.</p> <p>model model-id: Indicates the template mode ID. The value can be 0 or 1 and the default value is 0. Template mode 0 indicates that an inbound sampling template and an outbound sampling template exist. Template mode 1 indicates that the sampling direction is not differentiated and statistics in the inbound and outbound directions are recorded in the same template.</p>
Defaults	The default data template retransmission frequency is 20 packets and the default retransmission interval is 10 minutes.
Command Mode	Global configuration mode
Usage Guide	N/A

Verification

Run the **show { ip | ipv6 } flow export** command to display information on the IPFIX server.

Configuration Example

⤵ Configuring the Server, to Which Flow Records Are to Be Exported

Configuration Steps	<ul style="list-style-type: none"> ● Configure the output destination address and destination port. ● Configure the format for packets to be exported. ● Configure the output template retransmission frequency. ● Configure output options.
	<pre>FS# config terminal FS(config)# ip flow-export destination 192.168.2.2 9996 FS(config)# ip flow-export source gigabitEthernet 4/2</pre>

<pre> FS(config)# ip flow-export version 9 FS(config)# ip flow-export template refresh-rate 30 FS(config)# ip flow-export template timeout-rate 40 FS(config)# ip flow-export template options export-stats FS(config)# ip flow-export template options refresh-rate 35 FS(config)# ip flow-export template options timeout-rate 45 </pre>
<p>Verification Run the show ip flow export command to display exported information.</p>
<pre> FS# show ip flow export IPV4 main Cache: Exporting flows to 192.168.2.2(9996) Exporting using source IP address 192.168.2.1 Version 0 flow records IPV4 Template ID = 257 Template timeout = 30 Minute(s) Template refresh rate = 40 0 flows exported in 0 udp datagrams 0 flows failed to export </pre>

Common Errors

N/A

11.4.3 Configuring Parameters for the Main Mode Flow Table

Configuration Effect

- Adjust the aging time of flow records in the flow table.

Notes

- If the IPFIX function is enabled globally (the **{ ip } flow ingress** or **{ ip } flow egress** command is configured on a port), the change on the maximum number of entries that can be cached does not take effect immediately unless the IPFIX function is enabled globally again or the device is restarted. On any port with the IPFIX function enabled, you can run the no **{ ip } flow ingress** or no **{ ip } flow egress** command to disable the IPFIX function on all ports so as to disable the IPFIX function globally. Then, run the **{ ip } flow ingress** command to enable the IPFIX flow statistics again.

Configuration Steps

➤ **Configuring the Aging Time of Flow Records**

- Optional.

- Run the **ip flow-cache timeout { active minutes | inactive seconds }** command to modify the inactive aging time and active aging time.
- When traffic needs to be displayed on the server in real time, it is recommended to set the aging time to a smaller value, for example, set the active aging time to 1 minute.
- Modifying aging time affects how long a flow record is stored in the flow table. If the aging time is set to a larger value, flow records exist in the flow table longer and the IPFIX server is slower in receiving the flow records.

Command	{ ip ipv6 } flow-cache timeout { active minutes inactive seconds }
Parameter Description	active minutes: Indicates the active aging time, in minutes, that is, the time that an active entry can exist in the main mode cache before export or deletion. The valid value range is from 1 to 60 and the default value is 30. inactive seconds: Indicates the inactive aging time, in which no flow record about an entry is detected before the main mode entry is aged. The value ranges from 10 seconds to 600 seconds. The default value is 15 seconds.
Defaults	The default inactive aging time is 15 seconds and the default active aging time is 30 minutes.
Command Mode	Global configuration mode
Usage Guide	N/A

Verification

- Run the **show { ip | ipv6 } flow cache** command to display information about the main mode flow table.

Configuration Example

📌 **Configuring Parameters for the Main Mode Flow Table**

Configuration Steps	<ul style="list-style-type: none"> ● Configure the active aging time for flow records. ● Configure the inactive aging time for flow records.
	<pre>FS# config terminal FS(config)# ip flow-cache timeout active 2 FS(config)# ip flow-cache timeout inactive 20</pre>
Verification	Run the show ip flow cache command to display information about the main mode flow table.
	<pre>FS# show ip flow cache</pre>

Common Errors

N/A

11.5 Monitoring

Clearing

Description	Command
Clears flow table information.	clear { ip ipv6 } flow stats

Displaying

Description	Command
Displays information about the main mode flow table.	show { ip ipv6 } flow cache
Displays information about the server, to which flow records are to be exported.	show { ip ipv6 } flow export
Displays IPFIX configuration of an interface.	show ip flow interface

Debugging

N/A

Data Center Configuration

1. Configuring DCB
2. Configuring VXLAN

1 Configuring DCB

1.1 Overview

A data center (DC) mainly processes the following three traffic types:

- Storage traffic: The requirement of packet integrity must be met.
- High-performance computing traffic: The requirement of low delay must be met.
- Ethernet traffic: Certain degree of packet loss and delay are allowed.

Due to the different requirements for the three traffic types, traditional DC bears the traffic on three types of networks, as shown in Figure 1-1.

Figure 1-1 Three types of DC networks

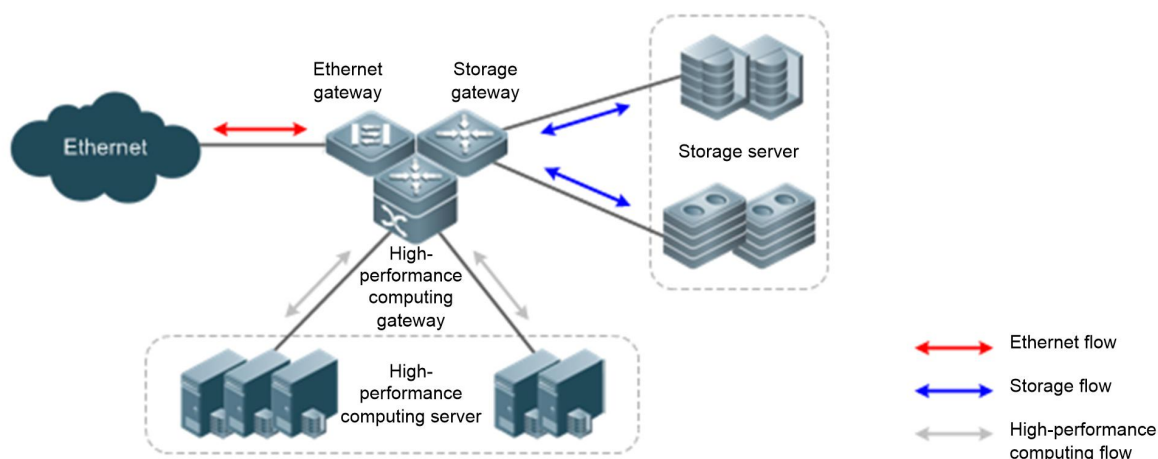

This topology configuration is feasible for a small-sized DC. If the DC grows, running the three types of networks becomes costly. An alternative method is to bear the three traffic types on Ethernet and define additional mechanisms, so that the Ethernet can meet the requirements of the three types of networks. The following definitions are formulated in IEEE to implement the method:

- Priority-based Flow Control (PFC): a mechanism that avoids packet loss in storage traffic and impact on other traffic types if the three traffic types coexist on Ethernet.
- Data Center Bridging Capability Exchange Protocol (DCBX): a protocol that is defined by IEEE 802.1Qaz for negotiating the data center bridge (DCB) capability. With the Link Layer Discovery Protocol (LLDP), DCBX discovers devices and exchanges DCB capability.

Protocols and Standards

- IEEE Std 802.1Qaz
- IEEE 802.1Qbb
- IEEE 802.1Qau
- IEEE 802.3bd
- <http://www.ieee802.org/1/files/public/docs2008/az-wadekar-dcbx-capability-exchange-discovery-protocol-1108-v1.01.pdf>

1.2 Applications

Application	Description
Configuring DC Network	The Ethernet of a DC bears three types of data traffic.

1.2.1 Configuring DC Network

Scenario

The DC Ethernet bearing three types of data traffic must meet the following requirements:

- Storage traffic: The requirement of packet integrity must be met.
- High-performance computing traffic: The requirement of low delay must be met.
- Ethernet traffic: Certain degree of packet loss and delay are allowed.

Figure 1-2

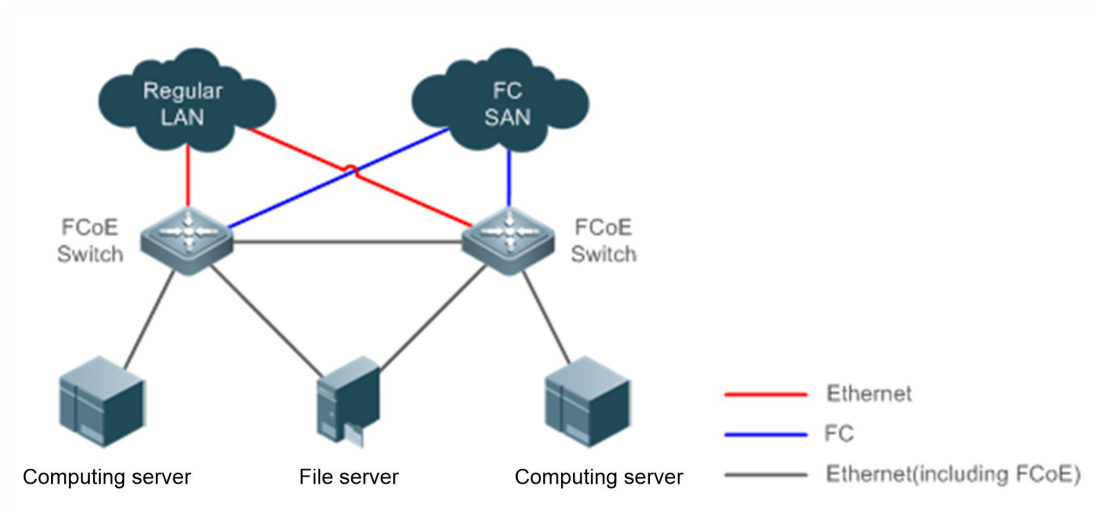

Deployment

- Enable PFC for storage traffic to meet the requirement of packet integrity.
- Map the packet priority of high-performance computing traffic to the traffic class (TC) which boasts strict priority (SP) algorithm.
- Allocate bandwidth to the TC of Ethernet traffic.

1.3 Features

Basic Concepts

802.1p (Cos)

In 802.1p, the L2 header Virtual Local Area Network (VLAN) tag field falls into 8 priorities, ranging from 0 to 7.

16bit	3 bit	12bit
-------	----------	-------

Tag Protocol ID (0x8100)	pr io rit y	VLAN ID
--------------------------	----------------------	---------

Traffic with priorities in the range 0~2 indicates common Ethernet traffic that is transmitted with maximum capability; traffic with priority 3 indicates Fiber Channel Over Ethernet (FCoE) Storage Area Network (SAN) traffic; traffic with priorities 4 and 5 indicates delay-sensitive voice traffic; and traffic with priorities 6 and 7 indicates delay-sensitive main traffic. Traffic with priority 7 indicates network control packets.

➤ **Trust edge and application priority identification**

By default, Ethernet ports are untrusted ports and need to be set to trust mode, so that packets carrying 802.1p value tags can be mapped to corresponding TC. The priority of untagged packets is 0 by default and can be modified.

The identified priority of FCoE packets is 3 by default and can be modified. The priority identification function must be enabled on a network interface card (NIC) which supports DCBX. If the NIC does not support DCBX, the priority identification function will be ignored.

If NICs do not support DCBX or users require more detailed priority identification function, configure Quality of Service (QoS) policies on ports to map an access control list (ACL) and identify application priority; or modify the FCoE packet priority on the servers directly connected to switches.

➤ **Queue and TC**

A switch port has 3~8 queues for caching packets. A traffic class (TC) can be a single queue caching packets with different priorities or composed of multiple queues, with each queue caching packets of specified priority. The SP algorithm can be performed for a TC.

For example, TC 1 contains queue 1 only, and queue 1 caches packets with priorities 0~2; or TC 1 contains queues 0~2, where, queue 0 caches packets with priority 0, queue 1 caches packets with priority 1, and queue 2 caches packets with priority 2. Meanwhile, the SP algorithm may be enabled for queues 0~2 to ensure that packets with priority 2 are transmitted first.

➤ **Mapping list**

Packets are mapped to a TC in the mapping list according to identified priority and then allocated to a specific queue of the TC.

- A TC is composed of multiple queues.

Each packet with a priority is mapped to a specific queue of the TC. The following table lists the mapping relationship between priorities and queues.

Cos	0	1	2	3	4	5	6	7
Queue	0	1	2	3	4	5	6	7

Queues in a TC are associated with the priorities mapped. According to the mapping list, users can modify queues contained in a TC. For example, users can map priorities 0~2 to TC 1, then TC 1 contains queues 0~2 that are associative with priorities 0~2.

- A TC contains a single queue.

A TC is associative with a specific queue. The following table lists the mapping relationship between queues and TCs.

Queue	0	1	2	3	4	5	6	7
TC	0	1	2	3	4	5	6	7

According to the mapping list, the mapping relationship between priorities and TCs is the mapping relationship between priorities and queues. For example, if priority 3 is mapped to TC 1, packets with priority 3 will be mapping to queue 1 of TC 1.

Overview

Feature	Description
PFC	Implements PFC on packets based on 802.1p value. If traffic of specified priority becomes congested, stops forwarding packets of this priority and instructs the transmitting device to stop sending such packets. With this function, packet integrity of Ethernet can be ensured.
DCBX	The DCB device on the edge access layer instructs the servers connected to automatically synchronize with the DCB device.

1.3.1 Configuring PFC

With PFC, packet integrity of the storage traffic can be ensured and impact on other traffic types can be avoided if the three traffic types, storage traffic, high-performance computing traffic, and Ethernet traffic, coexists on Ethernet. An 802.1p value is allocated to the storage traffic, and the PFC function is enabled for the priority. Other 802.1p values are allocated to the high-performance computing traffic and Ethernet traffic and the PFC function is disabled.

Working Principle

PFC is an enhanced version of the flow control function. Generally, if a receiver is unable to process received packets, the receiver instructs the packet sender to stop sending packets, which avoids packet loss. The flow control function is implemented by receiving or sending PAUSE frames via ports.

Figure 1-3 Flow control



As shown in Figure 1-3, when ports Gi 0/1 and Gi 0/2 forward packets at 1 Gbps, port Fa 0/1 will be congested. To avoid packet loss, enable the flow control function on ports Gi 0/1 and Gi 0/2.

- If port Fa 0/1 is congested in the course of forwarding packets, switch B will cache the packets. When the traffic exceeds the forwarding capability of switch B, packets will be lost. In this case, port Gi 0/2 will send a PAUSE frame to port Gi 0/1, instructing port Gi 0/1 to stop forwarding packets.
- Upon receiving the PAUSE frame, port Gi 0/1 stops forwarding packets to port Gi 0/2. The pause time is subject to the information carried in the PAUSE frame. If the congestion problem persists after the pause time is up, the preceding procedure will repeat until the congestion problem is cleared.

As described above, the flow control function can avoid packet loss, but it will result in link stop as well. That is, the entire link is stopped. The PFC function, however, allows eight virtual links to be created over an Ethernet link and specifies an 802.1p value for each virtual link. Any virtual link can be paused or restarted independently, without causing traffic interruption to other virtual links.

Figure 1-4 PFC

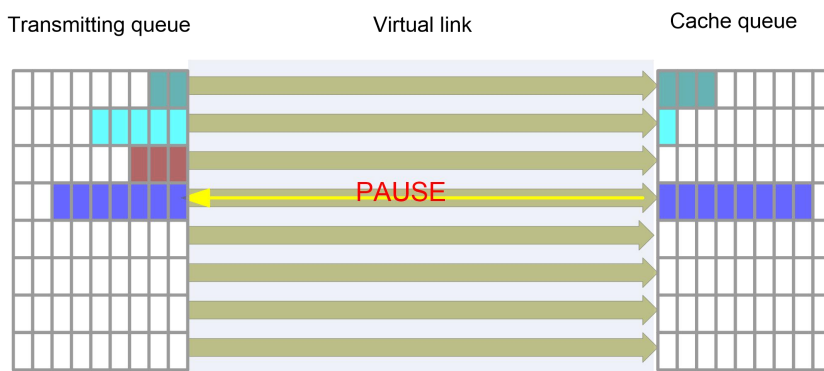

As shown in the preceding figure, enable the PFC function on ports Gi 0/1 and Gi 0/2 for priority 3.

- If port Fa 0/1 is congested in the course of forwarding packets with priority 3, switch B will cache the packets. When the traffic exceeds the forwarding capability of switch B, port Gi 0/2 will send a PFC PAUSE frame to port Gi 0/1, instructing port Gi 0/1 to stop forwarding packets with 802.1p value 3.
- Upon receiving the PFC PAUSE frame, port Gi 0/1 stops forwarding packets to port Gi 0/2. The pause time is subject to the information carried in the PFC PAUSE frame. If the congestion problem persists after the pause time is up, the preceding procedure will repeat until the congestion problem is cleared. As shown in the preceding figure, stopping forwarding packets with priority 3 will not have impact on packet transmission of other links between Gi 0/1 and Gi 0/2.

Related Configuration

📌 Enabling the PFC Function

The PFC function is disabled for any priority by default.

Run the **priority-flow-control nodrop** *cos-value-list* {**off** | **on**} command to enable the PFC function for a specified priority. *cos-value-list* indicates a priority list (range: 0~7); **on** indicates that the PFC function is enabled; and **off** indicates that the PFC function is disabled.

📌 Disabling the PFC RX/TX Function

The PFC RX/TX function is enabled on the device by default.

Run the **priority-flow-control** { **rx** | **tx** } **disable** command to disable the PFC RX/TX function. After this command is configured, PFC PAUSE frames are not received or transmitted.

📌 Configuring the Value of XOFF-TIME in a PFC Frame

By default, the value of **XOFF-TIME** in PFC frames sent by the device is **65535**.

Run the **priority-flow-control xoff-time** *number* command to configure the value of **XOFF-TIME** in PFC frames to be sent. The value of **XOFF-TIME** ranges from **1** to **65535**. The unit of **XOFF-TIME** is the time required by the chip to send 512-bit data at the physical layer.

📌 Configuring Flow Rate Warning for Pause Frames for a Priority of an Interface

By default, no warning is generated when a device interface sends or receives Pause frames.

Run the **priority-flow-control early-warning** *cos-value-list* { **output pps** *rate-num* } | **input pps** *rate-num*} command to configure the flow rate warning thresholds for Pause frames in the input and output directions for a specified PFC priority of an interface.

cos-value-list indicates the configured priority list, and a priority ranges from **0** to **7**. **output pps rate-num** indicates the threshold of Pause frames in the output direction while **input pps rate-num** indicates the threshold of Pause frames in the input direction.

If the rate for an interface at a specified priority to send/receive Pause frames exceeds the configured threshold (packets per second), a warning is generated and logged.

1.3.1.1 PFC Deadlock Detection

After the PFC priority is configured on the switch, the Ethernet is apt to encounter deadlock if a link is congested. This is called PFC deadlock.

Working Principle

The figure below shows a typical scenario, in which devices in a data center have cyclic buffer areas that are mutually dependent. In the ring topology, any device may affect the buffer areas of the uplink device, and wait for its downlink device to release some buffer areas to recover the data packet transmission (dependency relationship). When Device A, Device B, and Device C reach the XOFF waterline and transmit PFC frames to the peer device at the same time, all switches in the topology are in the flow pause state, that is, deadlock occurs. The throughput of the entire network or part of the network becomes zero due to the back pressure effect of PFC Pause frames. A lot of facts show that deadlock surely occurs in such networks. Deadlock may also occur when a transient loop forms in a closed-loop network. In a data center, when a link fault occurs, a transient loop arises during the rerouting of the Border Gateway Protocol (BGP, an autonomous system routing protocol running over TCP); a transient loop may also appear during the update of the SDN-based data center. Though the transient loop disappears rapidly, the deadlock incurred persists. The system cannot automatically clear deadlock even after the error cause (for example, configuration error or link fault/update) is eliminated.

Figure 1- 5 Deadlock Principle

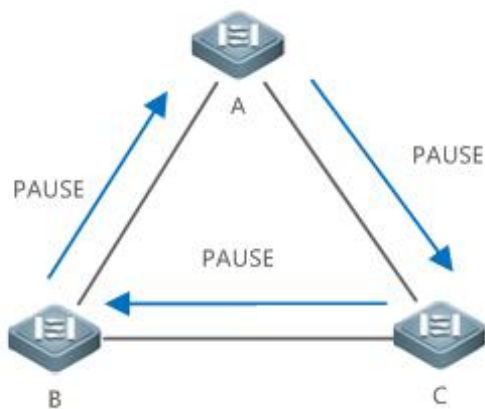

Remarks	Device A, Device B, and Device C are switches.
----------------	--

A buffer time can be set for PFC priority queues of a device interface to eliminate the deadlock. When a queue is congested and PFC Pause frames are received, a few time slices are still allocated for packet processing, to recover from the deadlock state.

When it is detected that an interface of a PFC priority enters the deadlock state frequently, the PFC function of the priority can be disabled to avoid impact on the normal forwarding of packets.

Related Configuration

➤ Configuring the PFC Deadlock Detection Time and Packet Processing Time for a Specified Priority

Run the **priority-flow-control deadlock cos-value** *cos-value-list* [**detect** *detect-time* **recover** *recover-time* [**continue** | **backoff** *most-times*]] command to configure the PFC deadlock detection time and packet processing time for a specified priority. (If the PFC deadlock detection time and packet processing time are not configured, default values are used.) **continue** indicates that an algorithm is enabled, in which an interface is always in the deadlock state and exits the deadlock state only when it does not receive PFC PAUSE frames. **backoff** *most-times* indicates that the recover-time backoff algorithm is enabled and *most-times* indicates the maximum number of backoff times. If **continue** or **backoff** is not configured, the recover-time algorithm is not enabled. After the deadlock recover-time ends, the interface directly exits the deadlock state.

➤ Enabling the PFC Deadlock Detection Function for a Priority of an Interface

The PFC deadlock detection function is disabled for all priorities of all interfaces by default.

When the **priority-flow-control deadlock cos-value detect recover** command is executed to configure the global PFC deadlock detection function for a priority, you can run the **priority-flow-control deadlock cos-value** *cos-value-list* **enable** command to enable the PFC deadlock detection function for the specified priority of an interface.

After the PFC deadlock detection function is enabled for a specified priority of an interface, the interface will detect PFC deadlock events at this priority of the interface. If a PFC deadlock event occurs, the interface processes packets according to the configured policy. The **priority-flow-control deadlock drop** command is used to discard packets; if this command is not configured, packets are allowed to pass.

➤ Configuring the PFC Deadlock Threshold Function

The PFC deadlock threshold function is disabled for all priorities by default.

After the **priority-flow-control deadlock cos-value detect recover** command is executed to configure the global PFC deadlock detection function for a priority, you can run the **priority-flow-control deadlock limit cos-value** *cos-value-list* **enable** command to enable the PFC deadlock threshold function for the specified priority.

After the PFC deadlock threshold function is enabled for a priority, if the number of deadlock times occurring for the priority within a detection period (1 minute by default) reaches the threshold (10 times by default), the PFC function is disabled for the priority, and the event and the disabling of the PFC function are logged (you can run the **show priority-flow-control deadlock status** command to display the logs).

1.3.2 Configuring DCBX

Working Principle

➤ DCBX version

Currently, market products support the following DCBX versions:

- CIN-DCBX: indicates the first-generation of DCBX designed by Cisco, Intel, and Nuova that is compatible with the converged network adapter (CNA).
- CEE-DCBX: indicates the second-generation of DCBX that is compatible with the CAN.
- IEEE-DCBX: indicates a standard DCBX that is defined by IEEE 802.1Qaz.

➤ Negotiating DCB capability

DCBX encapsulates each DCB capability into an LLDP type/length/value (TLV). Based on the LLDP TLV, peer devices discover the DCB capabilities of neighboring devices and then negotiate with the neighboring devices according to the discovered DCB capabilities. By the negotiation, DCB configuration can be synchronized and error detection can be implemented at both ends.

DCB capabilities that need to be negotiated include PFC, and APP. The Willing field is contained in corresponding TLV of the capabilities. When the Willing field is 1, peer DCB configuration is acceptable; when the Willing field is 0, peer DCB configuration is unacceptable. DCB capabilities are negotiated based on the Willing field. The following table lists the values of the Willing field at both ends and negotiation results.

Local Willing Field	Peer Willing Field	Negotiation Result
1	1	DCB configuration of the device with smaller media access control (MAC) address is selected as a common DCB configuration.
1	0	Peer DCB configuration is selected.
0	1	Local DCB configuration is selected.
0	0	If DCB configuration at both ends is the same, negotiation succeeds; otherwise, negotiation fails.

Related Configuration

The DCBX function is enabled by default, so DCB capability configuration can be performed without additional configuration.

1.4 Configuration

Configuration	Description and Command	
Configuring Basic Functions of the PFC	 (Mandatory) It is used to enable the PFC capability.	
	priority-flow-control nodrop <i>cos-value-list</i> { off on }	Configures the PFC function for specified priorities.
	priority-flow-control {rx tx} disable	Disables the PFC RX/TX function.
	priority-flow-control xoff-time <i>number</i>	Configures the value of XOFF-TIME in a PFC frame.
	priority-flow-control early-warning <i>cos-value-list</i> { output pps rate-num input pps rate-num }	Configures the flow rate warning for a priority of an interface.
	priority-flow-control counting-interval <i>number</i>	Configures the global PFC statistics collection interval.
	priority-flow-control deadlock cos-value <i>cos-value-list</i> [detect <i>detect-time</i> recover <i>recover-time</i> [continue backoff <i>most-times</i>]]	Configures attributes of the PFC deadlock detection function for a PFC priority.
	priority-flow-control deadlock cos-value <i>cos-value-list</i> enable	Enables the PFC deadlock detection function for a priority of an interface.
	priority-flow-control deadlock drop	Configures the function of discarding packets in the PFC deadlock state.
	priority-flow-control deadlock precision low	Sets the PFC deadlock time precision to low .
	priority-flow-control deadlock limit frequency <i>number</i> { period period-second } <i>time</i>	Configures the PFC deadlock threshold and detection period.
priority-flow-control deadlock limit cos-value <i>cos-value-list</i> enable [rx]	Enables the PFC deadlock threshold function for a priority.	

Configuring Basic Functions of the DCBX	(Mandatory) It is used to discover, detect, and negotiate peer DCB capabilities.	
	dcbx enable	Enables the global and interface DCBX function.
	dcbx mode { auto cee ieee }	Configures the DCBX mode of interfaces.
	dcbx { pfc app-proto } advertise	Configures the DCBX TLV type that can be released on ports.
	dcbx { pfc app-proto } willing enable	Enables DCB capability synchronization for ports.

- Remark: Configuration commands vary with specific products. For details about the commands, refer to DCB Commands.

1.4.1 Configuring Basic Functions of the PFC

Configuration Effect

- Implement PFC for port data traffic based on 802.1p values.

Notes

- PFC is applicable to point-to-point (P2P) full-duplex links only.
- The PFC function conflicts with ordinary flow control function.
- If the priorities with PFC enabled and the priorities with PFC disabled are mapped to a queue, packets with the latter priorities will be suppressed. Generally, it is not recommended to map such priorities to a same queue.
- The PFC function is not applicable to packets sent by a CPU.
- The PFC function can take effect after a port trusts the CoS values.
- Priorities with the PFC function enabled cannot be mapped to a TC or queue that contains any other priorities (including priorities with the PFC function enabled). In another word, priorities mapped to a TC or queue cannot have the PFC function enabled.

Configuration Steps

➤ Enabling the PFC function

- The PFC function is disabled for packets with any priority by default. To implement PFC on specified priority, configure PFC.

Verification

- Check the display result.

Related Commands

➤ Enabling the PFC function

Command	priority-flow-control nodrop <i>cos-value-list</i> {off on}
Parameter	<i>cos-value-list</i> : Indicates a priority list (range: 0~7).
Description	on : Enables the PFC function of a priority. off : Disables the PFC function of a priority.
Command Mode	Global configuration mode

Usage Guide	N/A
--------------------	-----

Command	priority-flow-control nodrop <i>cos-value-list</i> { off on }
Parameter Description	<i>cos-value-list</i> : Indicates a priority list (range: 0~7). on : Enables the PFC function of a priority. off : Disables the PFC function of a priority.
Command Mode	Interface configuration mode
Usage Guide	The PFC function can be automatically negotiated and configured based on DCBX. After the PFC function is configured on the CLI, configuration results fall into the following scenarios: <ol style="list-style-type: none"> 1) The PFC function is automatically negotiated and configured based on DCBX. The automatic configuration takes effect. 2) The PFC function is not automatically negotiated and configured based on DCBX. The configuration on the CLI takes effect.

↘ Disabling the PFC RX/TX Function

Command	priority-flow-control { rx tx } disable
Parameter Description	N/A
Command Mode	Global or interface configuration mode
Usage Guide	<ol style="list-style-type: none"> (1) By default, the PFC RX/TX function is enabled. When this command is configured, the PFC function is disabled. (2) This command can be configured in global or interface configuration mode depending on the chip capability. When the PFC RX/TX function supports the global configuration capability, the command is unavailable on interfaces. (3) When the PFC RX/TX function supports the interface configuration capability, the command can be configured in global configuration mode and the configuration can be saved to each interface. The configuration is displayed only on interfaces.

↘ Configuring the Value of XOFF-TIME in a PFC Frame

Command	priority-flow-control xoff-time <i>number</i>
Parameter Description	<i>number</i> : Indicates the value of XOFF-TIME in a PFC frame, ranging from 1 to 65535 . (The unit of XOFF-TIME is the time required by the chip to send 512-bit data at the physical layer.)
Command Mode	Global or interface configuration mode
Usage Guide	<ol style="list-style-type: none"> (1) Use this command to configure the value of XOFF-TIME in a PFC frame. The default value of XOFF-TIME is 65535. (2) This command can be configured in global or interface configuration mode depending on the chip capability. When the PFC frame XOFF-TIME function supports the global configuration capability, the command is unavailable on interfaces. (3) When the PFC frame XOFF-TIME function supports the interface configuration capability, the command can be configured in global configuration mode and the configuration can be saved to each interface. The

	configuration is displayed only on interfaces.
--	--

➤ **Configuring Flow Rate Warning for a Priority of an Interface**

Command	priority-flow-control early-warning <i>cos-value-list</i> { output pps <i>rate-num</i> } input pps <i>rate-num</i> }
Parameter	<i>cos-value-list</i> : Indicates the configured priority list. The priority ranges from 0 to 7 .
Description	<i>rate-num</i> : Indicates the flow rate warning value. The value ranges from 1 to 148809523 .
Command Mode	Interface configuration mode
Usage Guide	N/A

➤ **Configuring the Global PFC Statistics Collection Interval**

Command	priority-flow-control counting-interval <i>number</i>
Parameter	<i>number</i> : Indicates the statistics collection interval in seconds. The value ranges from 1 to 20 .
Command Mode	Global configuration mode
Usage Guide	N/A

Configuration Example

➤ **Enabling PFC for 802.1p value 3**

Scenario Figure 1-6	
Configuration Steps	<ul style="list-style-type: none"> Specify PFC IEEE 802.1p value 3 on a server. Specify PFC IEEE 802.1p value 3 on a switch.
A	FS(config)# priority-flow-control nodrop 3 on
Verification	Check the display result.
A	<pre> FS# show priority-flow-control status PFC Global PriorityEnablePFC: 3 FS# show priority-flow-control status interface FastEthernet 0/1 Interface PriorityEnabledPFC PriorityEnalbedPFCByUser ----- FastEthernet 0/1 3 FS# show priority-flow-control statistics interface FastEthernet 0/1 interface Priority PauseSend PauseSend-Rate PauseReceived PauseReceived-Rate (packets/sec) (packets/sec) ----- Fa 0/1 0 0 0 0 0 </pre>

Fa 0/1	1	0	0	0	0
Fa 0/1	2	0	0	0	0
Fa 0/1	3	0	0	0	0
Fa 0/1	4	0	0	0	0
Fa 0/1	5	0	0	0	0
Fa 0/1	6	0	0	0	0
Fa 0/1	7	0	0	0	0

S6510-4C#show priority-flow-control statistics history-top int hu 1/1

Interface : HundredGigabitEthernet 1/1

Prioroty : 0

PauseSended : 0
 PauseSended-Rate : 0 packets/sec
 PauseSended-Rate-1st : 0 packets/sec
 PauseSended-Rate-2nd : 0 packets/sec
 PauseSended-Rate-3rd : 0 packets/sec
 PauseReceived : 0
 PauseReceived-Rate : 0 packets/sec
 PauseReceived-Rate-1st : 0 packets/sec
 PauseReceived-Rate-2nd : 0 packets/sec
 PauseReceived-Rate-3rd : 0 packets/sec

Prioroty : 1

PauseSended : 0
 PauseSended-Rate : 0 packets/sec
 PauseSended-Rate-1st : 0 packets/sec
 PauseSended-Rate-2nd : 0 packets/sec
 PauseSended-Rate-3rd : 0 packets/sec
 PauseReceived : 0
 PauseReceived-Rate : 0 packets/sec
 PauseReceived-Rate-1st : 0 packets/sec
 PauseReceived-Rate-2nd : 0 packets/sec
 PauseReceived-Rate-3rd : 0 packets/sec

Prioroty : 2

PauseSended : 0
 PauseSended-Rate : 0 packets/sec
 PauseSended-Rate-1st : 0 packets/sec
 PauseSended-Rate-2nd : 0 packets/sec
 PauseSended-Rate-3rd : 0 packets/sec
 PauseReceived : 0
 PauseReceived-Rate : 0 packets/sec
 PauseReceived-Rate-1st : 0 packets/sec
 PauseReceived-Rate-2nd : 0 packets/sec
 PauseReceived-Rate-3rd : 0 packets/sec

Prioroty : 3

PauseSended	: 0
PauseSended-Rate	: 0 packets/sec
PauseSended-Rate-1st	: 0 packets/sec
PauseSended-Rate-2nd	: 0 packets/sec
PauseSended-Rate-3rd	: 0 packets/sec
PauseReceived	: 0
PauseReceived-Rate	: 0 packets/sec
PauseReceived-Rate-1st	: 0 packets/sec
PauseReceived-Rate-2nd	: 0 packets/sec
PauseReceived-Rate-3rd	: 0 packets/sec
Priority : 4	
PauseSended	: 0
PauseSended-Rate	: 0 packets/sec
PauseSended-Rate-1st	: 0 packets/sec
PauseSended-Rate-2nd	: 0 packets/sec
PauseSended-Rate-3rd	: 0 packets/sec
PauseReceived	: 0
PauseReceived-Rate	: 0 packets/sec
PauseReceived-Rate-1st	: 0 packets/sec
PauseReceived-Rate-2nd	: 0 packets/sec
PauseReceived-Rate-3rd	: 0 packets/sec
Priority : 5	
PauseSended	: 0
PauseSended-Rate	: 0 packets/sec
PauseSended-Rate-1st	: 0 packets/sec
PauseSended-Rate-2nd	: 0 packets/sec
PauseSended-Rate-3rd	: 0 packets/sec
PauseReceived	: 0
PauseReceived-Rate	: 0 packets/sec
PauseReceived-Rate-1st	: 0 packets/sec
PauseReceived-Rate-2nd	: 0 packets/sec
PauseReceived-Rate-3rd	: 0 packets/sec
Priority : 6	
PauseSended	: 0
PauseSended-Rate	: 0 packets/sec
PauseSended-Rate-1st	: 0 packets/sec
PauseSended-Rate-2nd	: 0 packets/sec
PauseSended-Rate-3rd	: 0 packets/sec
PauseReceived	: 0
PauseReceived-Rate	: 0 packets/sec
PauseReceived-Rate-1st	: 0 packets/sec
PauseReceived-Rate-2nd	: 0 packets/sec
PauseReceived-Rate-3rd	: 0 packets/sec
Priority : 7	

```

PauseSended           : 0
PauseSended-Rate      : 0 packets/sec
PauseSended-Rate-1st  : 0 packets/sec
PauseSended-Rate-2nd  : 0 packets/sec
PauseSended-Rate-3rd  : 0 packets/sec
PauseReceived         : 0
PauseReceived-Rate    : 0 packets/sec
PauseReceived-Rate-1st : 0 packets/sec
PauseReceived-Rate-2nd : 0 packets/sec
PauseReceived-Rate-3rd : 0 packets/sec

```

Common Errors

- The common flow control function is not disabled. As a result, PFC fails to be enabled.
- A port is not set to trust the CoS values.
- Priorities with the PFC function enabled are mapped to a TC that contains any other priorities (including priorities with the PFC function enabled).

1.4.1.1 Configuring the PFC Deadlock Detection Function

Configuration Effect

- If the PFC deadlock detection is enabled for a PFC priority on a port and deadlock is detected, allow packets to pass or discard packets within a period of time as per the configured policy.
- If the PFC deadlock threshold function is enabled for a PFC priority and it is detected that the number of deadlock times reaches the threshold, disable the PFC function of the PFC priority.

Notes

- The prerequisite for the PFC deadlock detection function to take effect for a priority is that the PFC function must be enabled for the priority.
- The prerequisite for the PFC deadlock threshold function to take effect for a priority is that the PFC deadlock detection function is configured for the priority.
- Modifying PFC deadlock time precision will affect the detection time and packet processing time of the configured PFC deadlock detection function.
- Disabling the PFC deadlock detection function for a priority will delete the configuration of the PFC deadlock threshold function of the priority.
- Disabling the global PFC deadlock detection function or PFC function for a priority will delete the configuration of the PFC deadlock detection function for the priority on all interfaces.

Configuration Steps

▾ Enabling the PFC Deadlock Detection Function

- The PFC deadlock detection function is disabled for all priorities on all interfaces by default. Configure the global PFC deadlock detection function for a priority and set attribute parameters (use default parameter values if no parameter is configured), and then enable the PFC deadlock detection function for the relevant priority on a specified interface.

➤ **Enabling the PFC Deadlock Threshold Function**

- The PFC deadlock threshold function is disabled for all priorities by default. The PFC deadlock threshold function can be enabled for a priority, for which the PFC deadlock detection function has been enabled. The threshold can be globally configured.

Verification

➤ **Checking the Configuration of the PFC Deadlock Detection Function and Threshold Function**

- Run the **show priority-flow-control deadlock status** command to display the configuration of the PFC deadlock detection function and threshold function, and check whether the functions are enabled, configured parameter values, and the interfaces and priorities for which the PFC deadlock detection function is enabled.

Command	show priority-flow-control deadlock status
Parameter Description	N/A
Command Mode	Privileged EXEC mode, global configuration mode, and interface configuration mode
Usage Guide	<p>Check the configuration and enabling status of the PFC deadlock function.</p> <pre> FS#show priority-flow-control deadlock status Global PFC Deadlock: 1-2 Time Precision: Low<100ms> Packet Dispose: Forward Limit Cos-value: off Limit Period: 5 Limit Frequency: 10 Priority Attribute: Cos-value Detect-time Recover-time ----- - 1 1 10 2 15 20 Interface Enable: Interface Cos-value ----- - Hu0/1 1-2 Hu0/2 2 Limit Log(Close PFC Log): Interface Cos-valueFrequency Time ----- - Hu0/1 1 20 2017-12-15 11:00:00 </pre>

Hu0/12	20	2017-12-15 11:00:00
Hu0/11	20	2017-12-15 12:00:00
Hu0/12	20	2017-12-15 12:00:00
Hu0/11	20	2017-12-15 13:00:00
Hu0/1	2	20 2017-12-15 13:00:00
Hu0/11	20	2017-12-15 14:00:00
Hu0/1	2	20 2017-12-15 14:00:00
Hu0/11	20	2017-12-15 15:00:00
Hu0/1	2	20 2017-12-15 15:00:00

Field description:

Field	Description
Global PFC Deadlock	Priority value configured for the PFC deadlock function
Time Precision	PFC deadlock time precision. High precision (100ms) is configured by default.
Packet Dispose	Packet processing mode in the PFC deadlock state. The value is Forward in preceding example.
Limit Cos-value	Priority value configured for the PFC deadlock threshold
Limit Period	Detection period set for the PFC deadlock threshold
Limit Frequency	PFC deadlock threshold
Priority Attribute	PFC deadlock priority attributes (cos-value, detection time, and recovery time)
Interface Enable	Interface on which the PFC deadlock function is enabled and priority information (interface name and enabling priority)
Limit Log	PFC deadlock threshold log (recording the historical disabling of the PFC function resulted from that the number of PFC deadlock events exceeds the threshold)
Interface	Interface on which the number of PFC deadlock events exceeds the threshold
Cos-value	Priority for which the number of PFC deadlock events exceeds the threshold
Frequency	Number of PFC deadlock events that occur in a period
Time	Time at which the number of PFC deadlock events exceeds the threshold

Related Commands

Configuring Attributes of the PFC Deadlock Detection Function for a PFC Priority

Command	<code>priority-flow-control deadlock cos-value cos-value-list [detect detect-time recover recover-time [continue backoff most-times]]</code>
Parameter Description	<p><i>cos-value-list</i>: Indicates the priority list. The priority ranges from 0 to 7.</p> <p><i>detect-time</i>: Indicates the deadlock detection time in time slices. The value ranges from 1 to 15. The default value is 15.</p> <p><i>recover-time</i>: Indicates the deadlock recovery time in milliseconds. The value ranges from 10 to 3000. The default value is 150.</p> <p>continue: Indicates the continue algorithm used to calculate the deadlock recover-time.</p> <p>backoff most-times: Indicates the backoff algorithm used to calculate the deadlock recover-time. <i>most-times</i> indicates the maximum number of backoff times. The value ranges from 2 to 100.</p>
Command Mode	Global configuration mode
Usage Guide	1. The PFC deadlock detection function detects whether an interface at a PFC priority enters the PFC deadlock state.

	<p>When it is detected that the interface enters the PFC deadlock state, the interface forwards or discards received packets within a period of time. You can run the priority-flow-control deadlock drop command to configure the packet processing mode.</p> <p>2. You can use this command to configure attributes of the PFC deadlock detection function for PFC priorities.</p> <p>3. <i>detect-time</i>: Indicates the time for determining whether an interface at a PFC priority enters the PFC deadlock state. When the interface stays in the PFC congested state in consecutive detect-time periods, it indicates that the interface enters the PFC deadlock state.</p> <p>4. <i>recover-time</i>: Indicates the allowed packet processing time after an interface at a PFC priority enters the PFC deadlock state.</p> <p>5. <i>detect-time</i> is in unit of time slice. You can run the priority-flow-control deadlock precision low command to configure the length of one time slice. <i>recover-time</i> is in unit of milliseconds.</p> <p>6. continue: Indicates that an interface of the priority in the deadlock state continues in this state for one recover-time period if it receives PFC PAUSE frames. The interface checks whether it receives PFC PAUSE frames in the next recover-time period. If the interface still receives such frames, it continues to be in the deadlock state for another recover-time period. The process repeats till the interface does not receive PFC PAUSE frames within the recover-time period and then the interface exits the deadlock state.</p> <p>7. <i>most-times</i>: indicates the maximum number of recover-time backoff times . If an interface enters the deadlock state within the backoff period (<i>recover-time</i> x <i>most-times</i>) after it recovers from the first deadlock, the backoff time needs to be added to the <i>recover-time</i> (Backoff time = Number of backoff times x <i>recover-time</i>). If the interval between two deadlock states exceeds the backoff period, the number of backoff times is reset to zero. Otherwise, the number of backoff times increases by 1 (if the number of backoff times already reaches the maximum number of backoff times, the maximum number of backoff times, that is, <i>most-times</i>, is used.)</p> <p>8. If neither continue nor backoff is configured, the deadlock recover-time algorithm is disabled. After the deadlock recover-time ends, the interface directly exits the deadlock state.</p>
--	--

▾ **Enabling the PFC Deadlock Detection Function for a Priority of an Interface**

Command	priority-flow-control deadlock cos-value <i>cos-value-list</i> enable
Parameter Description	<i>cos-value-list</i> : Indicates the configured priority list. The priority ranges from 0 to 7 .
Command Mode	Interface configuration mode
Usage Guide	<p>1. When the priority-flow-control deadlock cos-value detect recover command is not executed to globally configure the PFC deadlock detection function for a priority, the PFC deadlock detection function cannot be enabled on interfaces for the priority.</p> <p>2. Likewise, if the priority-flow-control deadlock cos-value detect recover command, the PFC deadlock detection function will be disabled on all interfaces for the priority.</p>

▾ **Configuring the Function of Discarding Packets in the PFC Deadlock State**

Command	priority-flow-control deadlock drop
Parameter Description	N/A
Command Mode	Global configuration mode
Usage Guide	If this command is not configured, an interface at a PFC priority forwards packets after entering the PFC deadlock

	<p>state.</p> <p>If this command is configured, an interface at a PFC priority discards packets after entering the PFC deadlock state.</p>
--	--

↘ Setting the PFC Deadlock Time Precision to Low

Command	priority-flow-control deadlock precision low
Parameter Description	N/A
Command Mode	Global configuration mode
Usage Guide	<ol style="list-style-type: none"> 1. This command is used to configure the length of a single deadlock time slice. It affects the detect time unit in the priority-flow-control deadlock cos-value cos-value-list detect detect-time recover recover-time command. 2. When this command is not configured, the PFC deadlock time precision is high (one time slice equals 10ms). After this command is configured, the PFC deadlock time precision is low (one time slice equals 100ms). 3. After the PFC deadlock function is configured for a priority, configuring this command will modify the time precision of the PFC deadlock function for the priority.

↘ Enabling the PFC Deadlock Threshold Function for a Priority

Command	priority-flow-control deadlock limit cos-value cos-value-list enable
Parameter Description	N/A
Command Mode	Global configuration mode
Usage Guide	<ol style="list-style-type: none"> 1. This command is not configured by default. Configuring this command will enable the PFC deadlock threshold function for the PFC priority corresponding to <i>cos-value-list</i>. If the number of deadlock times occurring for a priority within one detection period (1 minute by default) reaches the threshold (10 times by default), the PFC function is disabled for the priority via the priority-flow-control nodrop cos-value-list off command. 2. This command relies on the configuration of the priority-flow-control deadlock cos-value cos-value-list detect detect-time recover recover-time command. This command can be configured only after the command for configuring attributes of the PFC deadlock detection function is configured for a priority. Likewise, if the command for configuring attributes of the PFC deadlock detection function is deleted for a priority, the PFC deadlock threshold command of the priority is also deleted. 3. You can run the priority-flow-control deadlock limit frequency number period time command to configure the detection period and deadlock threshold.

↘ Configuring the PFC Deadlock Threshold and Detection Period

Command	priority-flow-control deadlock limit frequency number period time
Parameter Description	N/A
Command Mode	Global configuration mode
Usage Guide	<p>This command modifies the PFC deadlock threshold and detection period. When the priority-flow-control deadlock limit cos-value cos-value-list enable command is executed to enable the PFC deadlock threshold function for a PFC priority, the PFC deadlock threshold and detection period configured using this command are applied.</p>

Configuration Example

▾ Enabling the PFC Deadlock Detection Function and Deadlock Threshold Function for Priority 3

<p>Scenario Figure 1-7</p>											
<p>Configuration Steps</p>	<ul style="list-style-type: none"> ● Set PFC IEEE 802.1p priority to 3 on the server. ● Enable the PFC function for Priority 3 on the switch. 										
<p>A</p>	<pre>FS(config)# priority-flow-control nodrop 3 on</pre> <ul style="list-style-type: none"> ● Set attributes of the PFC deadlock detection function for Priority 3 on the switch: Set the detection time to 5 time slices, recovery time to 20ms, and time precision to low. <pre>FS(config)# priority-flow-control deadlock cos-value 3 detect 5 recover 20</pre> <pre>FS(config)# priority-flow-control deadlock precision low</pre> <ul style="list-style-type: none"> ● Enable the PFC deadlock detection function for Priority 3 on Interface Hu0/1 of the switch. <pre>FS(config)#interface hundredGigabitEthernet 0/1</pre> <pre>FS(config-if-HundredGigabitEthernet 0/1)#priority-flow-control deadlock cos-value 3 enable</pre> <ul style="list-style-type: none"> ● Enable the PFC deadlock threshold function for Priority 3, set the detection time to 5 minutes, and threshold to 100 times. <pre>FS(config-if-HundredGigabitEthernet 0/1)#exit</pre> <pre>FS(config)# priority-flow-control deadlock limit frequency 100 period 5</pre> <pre>FS(config)# priority-flow-control deadlock limit cos-value 3 enable</pre>										
<p>Verification</p>	<p>Check the displayed configuration.</p>										
<p>A</p>	<pre>FS# show priority-flow-control deadlock status</pre> <pre>Global PFC Deadlock: 3</pre> <pre>Time precision: Low<100ms></pre> <pre>Packet dispose: Forward</pre> <pre>Limit cos-value: 3</pre> <pre>Limit period: 5</pre> <pre>Limit frequency: 100</pre> <pre>Priority attribute:</pre> <table border="1"> <thead> <tr> <th>cos-value</th> <th>detect-time</th> <th>recover-time</th> </tr> </thead> <tbody> <tr> <td>3</td> <td>5</td> <td>20</td> </tr> </tbody> </table> <pre>Interface Enable:</pre> <table border="1"> <thead> <tr> <th>interface</th> <th>cos-value</th> </tr> </thead> <tbody> <tr> <td>Hu0/1</td> <td>3</td> </tr> </tbody> </table> <pre>Limit Log(Close PFC Log):</pre>	cos-value	detect-time	recover-time	3	5	20	interface	cos-value	Hu0/1	3
cos-value	detect-time	recover-time									
3	5	20									
interface	cos-value										
Hu0/1	3										

Interface	Cos-value	Frequency	Time
-----	-----	-----	-----

Common Errors

- The PFC deadlock detection function is enabled on an interface without globally configuring the PFC deadlock detection function for a priority or globally enabling the PFC function for a priority in advance.
- The PFC deadlock threshold function is configured without globally configuring attributes of the PFC deadlock detection function for a priority.

1.4.2 Configuring Basic Functions of the DCBX

Configuration Effect

- Discover peer DCB capabilities.
- Check whether DCB capabilities configured for both ends are the same.
- Automatically negotiate and configure DCB.

Notes

- The DCB capability negotiation function can take effect on interfaces only after the following requirements are met: the LLDP function is enabled in global configuration mode and interface configuration mode; the LLDP working mode of the interfaces is set to txrx; the TLV of corresponding DCB capability can be released; and corresponding DCB capability is supported. If the requirements are not met, the DCBX function will not take effect even if it is enabled on the interfaces.
- When configuring AP ports, make sure that the LLDP of different AP member ports is set to the same value, the AP port topology is correctly set, and the DCBX TLV released for different AP member ports is the same. Otherwise, abnormalities occur when DCB capabilities are negotiated on the AP ports at both ends.

Configuration Steps

➤ Enabling DCBX

- The global and interface DCBX function is enabled by default.
- Enable DCBX in global or interface configuration mode to launch the DCB capability negotiation of the interface. Disabling the global DCBX function will disable the DCB capability negotiation of all interfaces. The DCBX function runs on physical ports or AP ports, and it is not applicable to stacking ports or VSL ports.

➤ Configuring a DCBX mode

- (Mandatory) Interfaces work in the automatic switch mode by default.
- (Interface configuration mode) The DCBX function runs on physical ports or AP ports, and it is not applicable to stacking ports or VSL ports.

➤ Configuring DCBX TLV types that can be released

- (Mandatory) All types of DCBX TLV can be released on interfaces by default.
- (Interface configuration mode) The DCBX function runs on physical ports or AP ports, and it is not applicable to stacking ports or VSL ports.

➤ **Configuring synchronization willingness**

- Local end is unwilling to receive peer configuration by default. That is, the Willing parameter is not set.
- During negotiation of DCB capability synchronization, specify the Willing parameter for local ports to receive peer configuration. If local end is willing to receive peer configuration, configure the Willing parameter.

Verification

- Check the display result.

Related Commands

➤ **Enabling DCBX**

Command	dcbx enable
Parameter	N/A
Description	
Command mode	Global configuration mode/Interface configuration mode
Usage Guide	Disabling the global DCBX function will disable the DCB capability negotiation of all interfaces. AP ports negotiate DCB capabilities based on AP member ports.

➤ **Configuring a DCBX mode**

Command	dcbx mode { auto cee ieee }
Parameter	Interfaces work in the automatic switch mode by default.
Description	<p>auto: Allows an interface to automatically switch a DCBX mode based on the received DCBX TLV type if an interface works in the automatic switch mode and the default mode is CEE-DCBX.</p> <p>cee: Disallows an interface to automatically switch a DCBX mode based on the received DCBX TLV type if an interface works in CEE-DCBX mode.</p> <p>ieee: Disallows an interface to automatically switch a DCBX mode based on the received DCBX TLV type if an interface works in IEEE-DCBX mode.</p>
Command mode	Interface configuration mode
Usage Guide	AP ports negotiate DCB capabilities based on AP member ports.

➤ **Configuring DCBX TLV types that can be released**

Command	dcbx { pfc app-proto } advertise
Parameter	All types of DCBX TLV can be released on interfaces by default.
Description	<p>pfc: Enables the DCBX TLV release function corresponding to the PFC capability.</p> <p>app-proto: Enables the DCBX TLV release function corresponding to the APP capability.</p>
Command mode	Interface configuration mode
Usage Guide	AP ports negotiate DCB capabilities based on AP member ports. Types of DCBX TLV that can be released on AP ports will be applied to different AP member ports.

➤ **Configuring synchronization willingness**

Command	dcbx { pfc app-proto } willing enable
----------------	--

Parameter	pfc: Enables PFC capability synchronization willingness.
Description	app-PROTO: Enables APP capability synchronization willingness.
Command mode	Interface configuration mode
Usage Guide	<p>AP ports negotiate DCB capabilities based on AP member ports.</p> <p>If the Willing parameter is set to the same value at both ends and the local and peer ports are willing to receive peer configuration, the configuration on the port with a smaller MAC address prevails. If the local and peer ports are unwilling to receive peer configuration, the same value of the Willing parameter indicates negotiation success; otherwise, it indicates negotiation failure.</p> <p>If DCB capabilities support only global configuration mode, they cannot be negotiated over DCBX. In this case, local configuration prevails. For example, if the PFC function supports only global configuration mode, even though the local PFC Willing bit is set to 1, the local port will not receive peer configuration. That is, the PFC capability cannot be negotiated, and local PFC configuration prevails.</p>

Configuration Example

📌 **Automatically configuring DCB**

Scenario Figure 1-8	
Configuration Steps	<ul style="list-style-type: none"> ● Enable LLDP in global configuration mode and interface configuration mode (default configuration). ● Set the LLDP mode of an interface to txrx (default configuration). ● Enable DCBX of an interface (default configuration). ● Allow all types of DCBX TLV to be released on an interface (default configuration).
A	By default, switch A can instruct the server to automatically configure DCB, free users of manually configuring DCB.
Verification	Check the display result.
A	<pre> FS#show dcbx status interface GigabitEthernet 0/1 ----- Port [GigabitEthernet 0/1] ----- Local managing configuration information and port link state: Port status of DCBX : Enable Port mode of DCBX : AUTO mode Port active of DCBX : CEE active PFC is allowed to advertise : Yes APP is allowed to advertise : Yes PFC is willing to accept peer configuration : No APP is willing to accept peer configuration : No Port link state : UP Negotiated configuration information: PFC negotiated result : using local configuraiton </pre>

	APP negotiated result : using local configuration
--	---

Common Errors

- The LLDP function is not enabled in global configuration mode or interface configuration mode.
- The LLDP mode of an interface is not set to txrx.

1.5 Monitoring

Clearing

Running the **clear** commands may lose vital information and thus interrupt services.

Description	Command
Clears statistical information of PFC.	clear priority-flow-control statistics [interface <i>interface-name</i>]
Clears the PFC deadlock statistics of an interface	clear priority-flow-control deadlock statistics [interface <i>interface-name</i>]

Displaying

Description	Command
Displays global PFC configuration information.	show priority-flow-control status
Displays PFC configuration and status information of a port.	show priority-flow-control status [interface <i>interface-name</i>]
Displays statistical information of PFC.	show priority-flow-control statistics [interface <i>interface-name</i>]
Displays the PFC deadlock statistics of all priorities of an interface.	show priority-flow-control deadlock statistics [interface <i>interface-name</i>]
Displays PFC deadlock configuration and enabling status.	show priority-flow-control status
Displays DCBX configuration information and negotiation status of an interface.	show dcbx status [interface <i>interface-name</i>]
Displays DCB configuration information and capability negotiation status at both ends.	show dcbx information { pfc app-proto } [interface <i>interface-name</i>]

Debugging

System resources are occupied when debugging information is output. Therefore, disable the debugging switch immediately after use.

Description	Command
Debugs the PFC deadlock function.	debug pfc deadlock
Debugs the PFC details.	debug pfc detail
Debugs the PFC error.	debug pfc error
Debugs the PFC event.	debug pfc event
Debugs the PFC statistics.	debug pfc statistics
Debugs ETS events.	debug ets event

Debugs DCBX events.	debug dcbx event
Debugs DCBX and DCB capability submodule interaction.	debug dcbx detail
Debugs error information during DCBX running.	debug dcbx error
Debugs packet transmission and receiving of DCBX.	debug dcbx pkt
Debugs change of the DCBX status machine.	debug dcbx stm
Debugs hot standby information of DCBX.	debug dcbx ha
Debugs the DCB library.	debug dcb-lib

2 Configuring VXLAN

2.1 Overview

Virtual Extensible Local Area Network (VXLAN) is a virtual Ethernet based on the physical IP (overlay) network. It is a technology that encapsulates layer 2 (L2) Ethernet frames within layer 3 User Datagram Protocol (UDP) packets.

VXLAN has a 24-bit VXLAN network identifier (VNI). It allows users to create up to 16,000,000 isolated virtual networks to meet the requirements of multi-tenant environments and scale expansion, far surpassing the widely used Virtual Local Area Network (VLAN) technology that is limited to 4,000 isolated networks. VXLAN uses the IP multicast method to encapsulate multicast, broadcast, and unknown unicast packets, effectively controlling the broadcast domain in multi-tenant environments.

With the transformation of data centers, more and more virtual machines are deployed. In addition, as virtual machines must be migrated in L2 environments, scales of L2 networks increase. VXLAN can extend L2 networks over layer 3 (L3) networks, so that virtual machines can be moved to L3 networks interconnected to L2 networks without changing the IP addresses and MAC addresses, thereby ensuring service continuity.

Protocols and Standards

- RFC7348: Virtual eXtensible Local Area Network (VXLAN) -- A Framework for Overlaying Virtualized Layer 2 Networks over Layer 3 Networks

2.2 Applications

Application	Description
EVPN-based Multi-tenant Centralized Deployment	Applicable to the centralized deployment scenario with Ethernet virtual private network (EVPN) enabled.
EVPN-based Multi-tenant Distributed Deployment	Applicable to the distributed deployment scenario with EVPN enabled.
EVPN-based Single-tenant VXLAN Routing Deployment	Applicable to the VXLAN routing deployment scenario with a single tenant.
EVPN-based Multi-tenant VXLAN Route Deployment	Applicable to the VXLAN route deployment scenario with multiple tenants.
SDN Controller-based Centralized	Applicable to the scenario for deploying all-active anycast gateways based on the

All-active Anycast Gateway Deployment	software-defined networking (SDN) controller in a centralized manner data centers.
Deployment of an EVPN Distributed Network to Be Compatible with Non-EVPN VTEP Devices	Applicable to the deployment scenario in which dynamic and static tunnels coexist.
Deployment of L2 Subinterfaces to Access a VXLAN	Applicable to the deployment scenario in which hosts access VXLANs through L2 subinterfaces.
VNI Mapping-based Data Center Interconnection Deployment	Applicable to the scenario in which VXLANs across different data centers are interconnected using the VNI mapping technology.

2.2.1 EVPN-based Multi-tenant Centralized Deployment

Scenario

VPN routing and forwarding (VRF) networks are usually allocated to different tenants to support the multi-tenant application in a data center. Multiple VXLANs can be assigned to each tenant. VXLANs of the same tenant can be mutually accessed through the L3 router, while VXLANs of different tenants cannot be mutually accessed, as shown in Figure 2-1.

Tenant A rents VRF-10, which includes VXLAN 10 and VXLAN 20. Servers HOST-1 and HOST-2 belong to VXLAN 10 and Servers HOST-3 and HOST-4 belong to VXLAN 20.

Tenant B rents VRF-20, which includes VXLAN 100. Servers HOST-5 and HOST-6 belong to VXLAN 100.

The networks of Tenant A and Tenant B are isolated from each other.

The entire network is formed by a Border Gateway Protocol (BGP) network and includes CORE and TOR switches. The BGP neighbor relationship is formed between every two devices and the BGP-EVPN protocol family is supported. All VXLAN gateways on the network are deployed in the core switches in a centralized manner.

Figure 2- 1

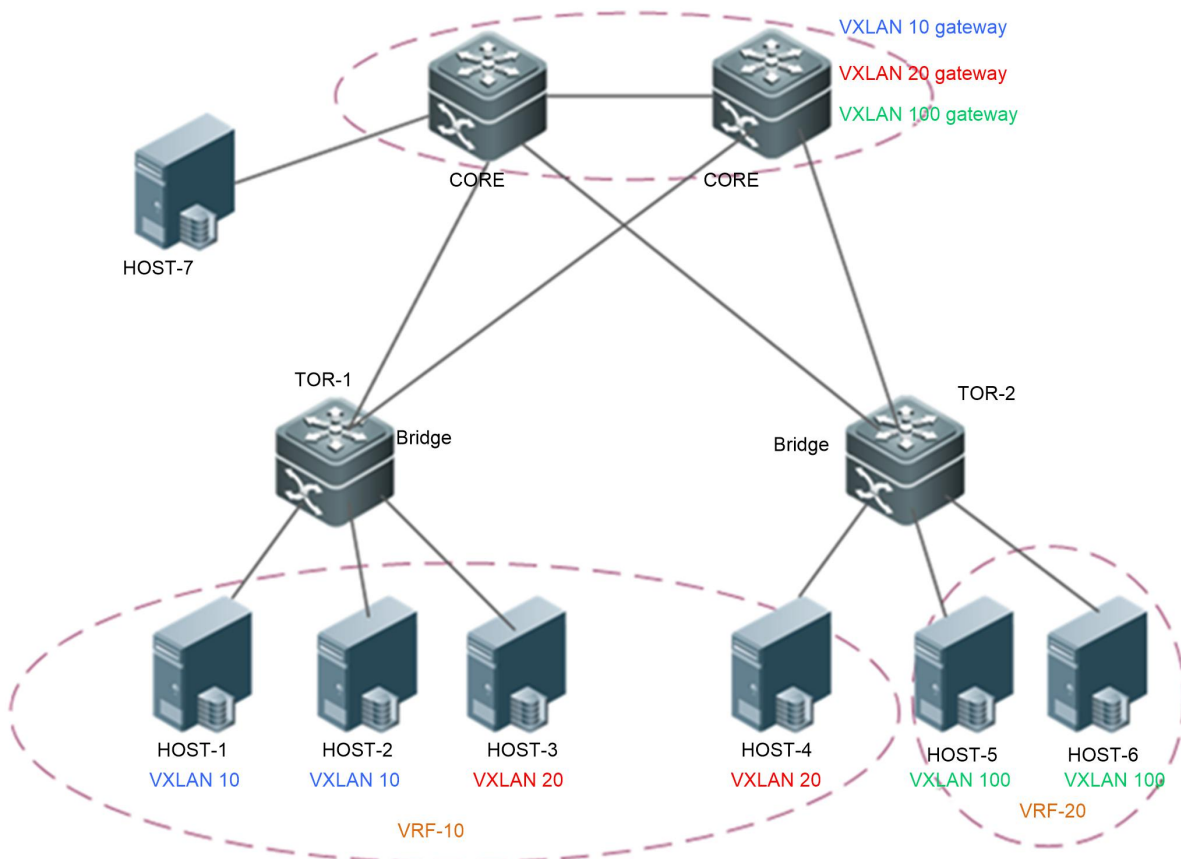

- Packets between HOST-1 and HOST-2 are forwarded through TOR-1 at L2 within the VXLAN.
- Packets between HOST-3 and HOST-4 are forwarded through TOR-1 > CORE > TOR-2 at L2 within the VXLAN.
- Packets between HOST-5 and HOST-6 are forwarded through TOR-2 at L2 within the VXLAN.
- Packets between VXLAN 10 and VXLAN 20 are forwarded through TOR-1 > CORE > TOR-2 at L3 across the VXLANs.
- VRF-10 and VRF-20 cannot communicate with each other.

Remarks:	<p>CORE indicates a core switch that supports the VXLAN function.</p> <p>When centralized all-active anycast gateways are deployed, multiple core gateways exist and the VXLAN gateways deployed on the core gateways are the same.</p> <p>TOR1 and TOR2 are access switches that support the VXLAN function.</p> <p>HOST-1, HOST-2, HOST-3, HOST-4, HOST-5, and HOST-6 are servers in the data center.</p>
-----------------	---

Deployment

- Configure an Internet Protocol version 4 (IPv4) unicast routing protocol, for example, the Open Shortest Path First (OSPF) protocol, on the switches to ensure that unicast routes are reachable.
- Configure the BGP routing protocol (supporting EVPN) on the switches to establish neighbor relationships between each other.
- Deploy the VXLAN gateway on the core switches.
- Deploy the VXLAN bridge on the TOR switches.

2.2.2 EVPN-based Multi-tenant Distributed Deployment

Scenario

The EVPN-based multi-tenant distributed deployment applies to data center networks that support multiple tenants. The difference between this deployment and the EVPN-based multi-tenant centralized deployment described in section 2.2.1 lies in that: On the distributed deployment network, gateways are deployed on the TOR switches, as shown in Figure 2-2.

Tenant A rents VRF-10, which includes VXLAN 10 and VXLAN 20.

Tenant B rents VRF-20, which includes VXLAN 100.

The networks of Tenant A and Tenant B are isolated from each other.

The entire network is formed by a BGP network and includes CORE and TOR switches. The BGP neighbor relationship is formed between every two devices and the BGP-EVPN protocol family is supported.

VXLAN gateways are deployed on TOR switches on the network. Anycast gateways can be deployed so that the IP addresses and MAC addresses of all gateways on the network are kept consistent. In this way, the gateway configuration does not need to be modified no matter which TOR switch a virtual machine of a customer is migrated to.

VXLANs are unnecessarily deployed on the core switches.

ARP suppression can be configured on TOR switches to curb flooding of ARP packets, and the TOR switches respond to ARP requests from hosts as a proxy.

The ARP proxy function can be enabled on the TOR switches for all or some VXLANs. In this way, L2 traffic in VXLANs is isolated and server communication traffic in the same VXLAN is forwarded at L3 rather than at L2.

ND suppression can be configured on TOR switches to curb flooding of IPv6 ND protocol packets, and the TOR switches respond to IPv6 NS multicast packets from hosts as a proxy.

Figure 2-2

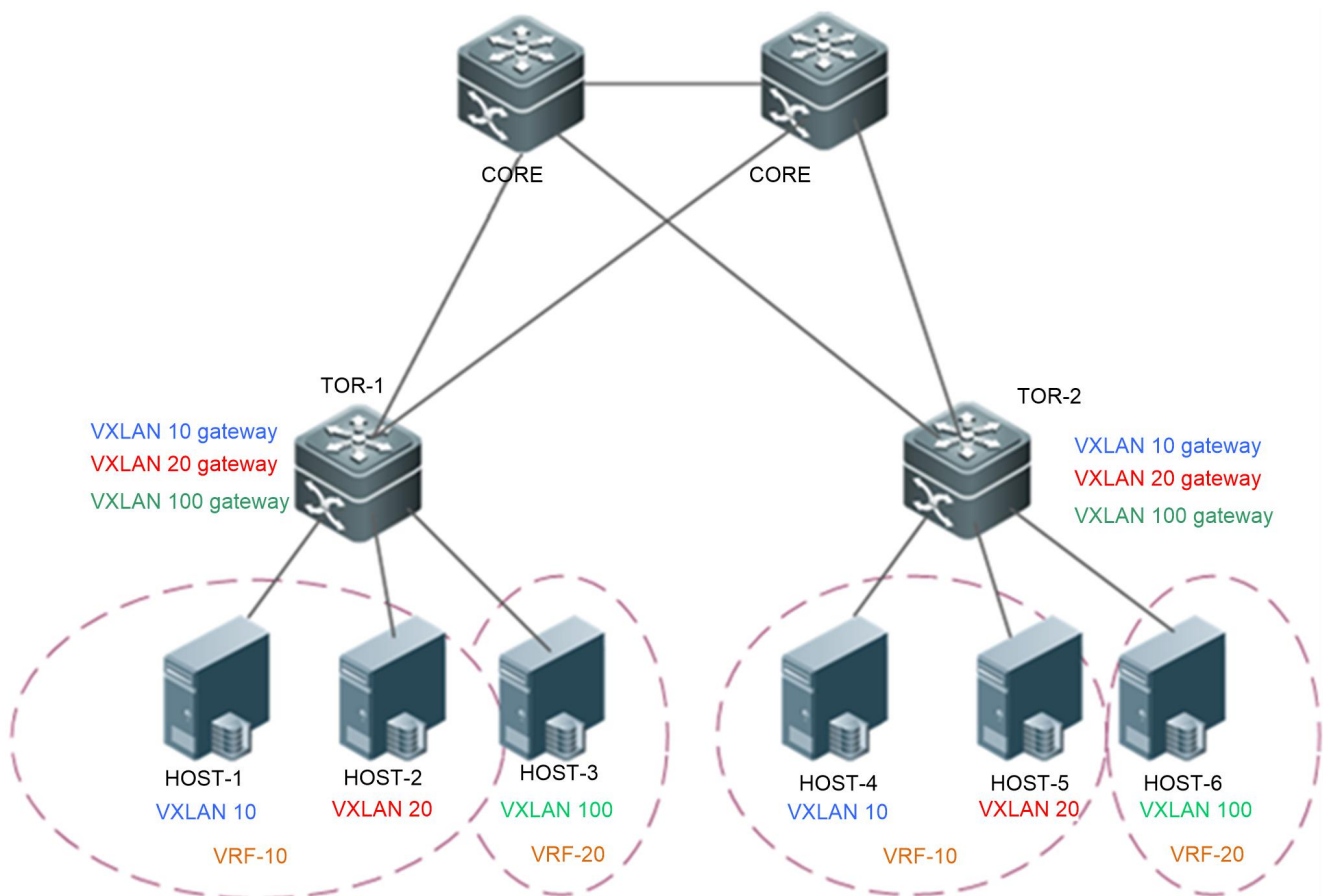

- Packets between HOST-1 and HOST-4 are forwarded through TOR-1 > TOR-2 at L2 within the VXLAN.
- Packets between HOST-1 and HOST-2 are forwarded through TOR-1 at L3 across the VXLANs.
- Packets between HOST-1 and HOST-5 are forwarded through TOR-1 > TOR-2 at L3 across the VXLANs.
- VRF-10 and VRF-20 cannot communicate with each other.
- If the ARP proxy function is configured on VXLAN 10, packets between HOST-1 and HOST-4 are forwarded through TOR-1 > TOR-2 at L3 within the VXLAN.

Remarks:	<p>CORE indicates a core switch that supports the BGP-EVPN function.</p> <p>TOR1 and TOR2 are access switches that support the VXLAN function.</p> <p>HOST-1, HOST-2, HOST-3, HOST-4, HOST-5, and HOST-6 are servers in the data center.</p>
-----------------	--

Deployment

- Configure an IPv4 unicast routing protocol, for example, the OSPF protocol, on the switches to ensure that unicast routes are reachable.
- Configure the BGP routing protocol (supporting EVPN) on the switches to establish neighbor relationships between each other.
- Deploy the VXLAN bridge on the core switches if required.
- Deploy the VXLAN gateway on the TOR switches.
- (Optional) Deploy ARP suppression on the TOR switches.
- (Optional) Deploy ARP proxy on the TOR switches.
- (Optional) Deploy IPv6 ND suppression on the TOR switches.
- (Optional) Deploy the EVPN protocol packet control function on the TOR switches to reduce the traffic of EVPN packets.

2.2.3 EVPN-based Single-tenant VXLAN Routing Deployment

Scenario

Single-tenant VXLAN route deployment is shown in Figure 2-3.

In this scenario, only the VRF-10 is deployed, which includes VXLAN 10 and VXLAN 20.

The border devices are connected to the external network. These devices are deployed in VRF-10 (including VXLAN 90) and interconnect with the external network at L3 via the overlay router interface.

The entire network is formed by a BGP network and includes TOR and border devices. The BGP neighbor relationship is formed between every two devices (except between Border-1 and Border-2) and the BGP-EVPN protocol family is supported.

The TOR and border devices must use a symmetric VXLAN (VXLAN 100) for interconnection with each other. The border devices import network routes to the TOR switches through the symmetric VXLAN.

VXLAN gateways are deployed on TOR switches on the network. Anycast gateways can be deployed so that the IP addresses and MAC addresses of all gateways on the network are kept consistent. In this way, the gateway configuration does not need to be modified no matter which TOR switch a virtual machine of a customer is migrated to.

Figure 2-3

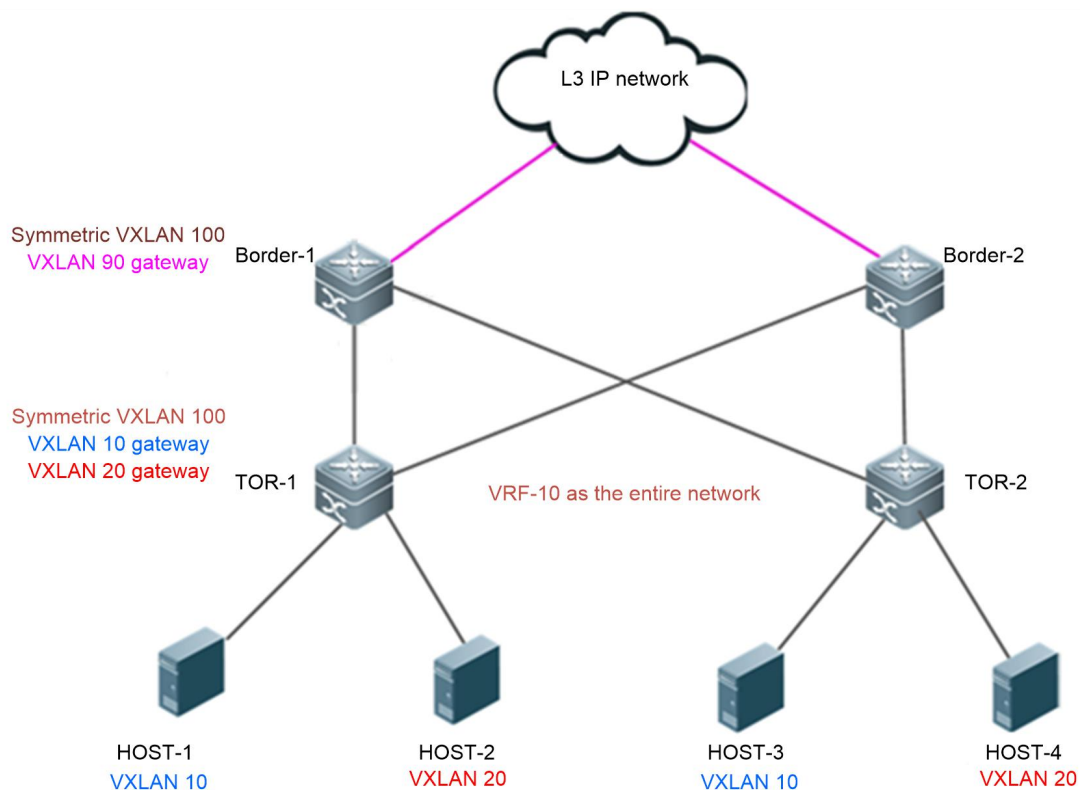

- Packets between HOST-1 and HOST-3 are forwarded through TOR-1 > TOR-2 at L2 within the VXLAN.
- Packets between HOST-1 and HOST-2 are forwarded through TOR-1 at L3 across the VXLANs.
- To access the external network, HOST-1 forwards packets to the border device through TOR1 at L3 across the VXLANs, and then the border device forwards the packets to the external network at L3.

Deployment

- Configure an IPv4 unicast routing protocol, for example, the OSPF protocol, on the switches to ensure that unicast routes are reachable.
- Configure the BGP routing protocol (supporting EVPN) on the switches to establish neighbor relationships between each other (except between the border devices).
- Deploy the VXLAN on the border devices for L3 interconnection with the external network.
- Deploy the VXLAN gateway on the TOR switches.

2.2.4EVPN-based Multi-tenant VXLAN Route Deployment

Scenario

VRF networks are usually allocated to different tenants to support the multi-tenant application in a data center. Multiple VXLANs can be assigned to each tenant. VXLANs of the same tenant can be mutually accessed through the L3 router, while VXLANs of different tenants cannot be mutually accessed, as shown in Figure 2-4.

Tenant A rents VRF-10, which includes VXLAN 10 and VXLAN 20.

Tenant B rents VRF-20, which includes VXLAN 30.

The border devices are connected to the external network. These devices are deployed in VRF-30 (including VXLAN 90) and interconnect with the external network at L3 via the overlay router interface.

The networks of Tenant A and Tenant B are isolated from each other.

The entire network is formed by a BGP network and includes TOR and border devices. The BGP neighbor relationship is formed between every two devices (except between Border-1 and Border-2) and the BGP-EVPN protocol family is supported

The TOR and border devices must use a symmetric VXLAN (VXLAN 100 and VXLAN200) for interconnection with each other. The border devices import network routes to the TOR switches through the symmetric VXLAN.

VXLAN gateways are deployed on TOR switches on the network. Anycast gateways can be deployed so that the IP addresses and MAC addresses of all gateways on the network are kept consistent. In this way, the gateway configuration does not need to be modified no matter which TOR switch a virtual machine of a customer is migrated to.

Figure 2-4

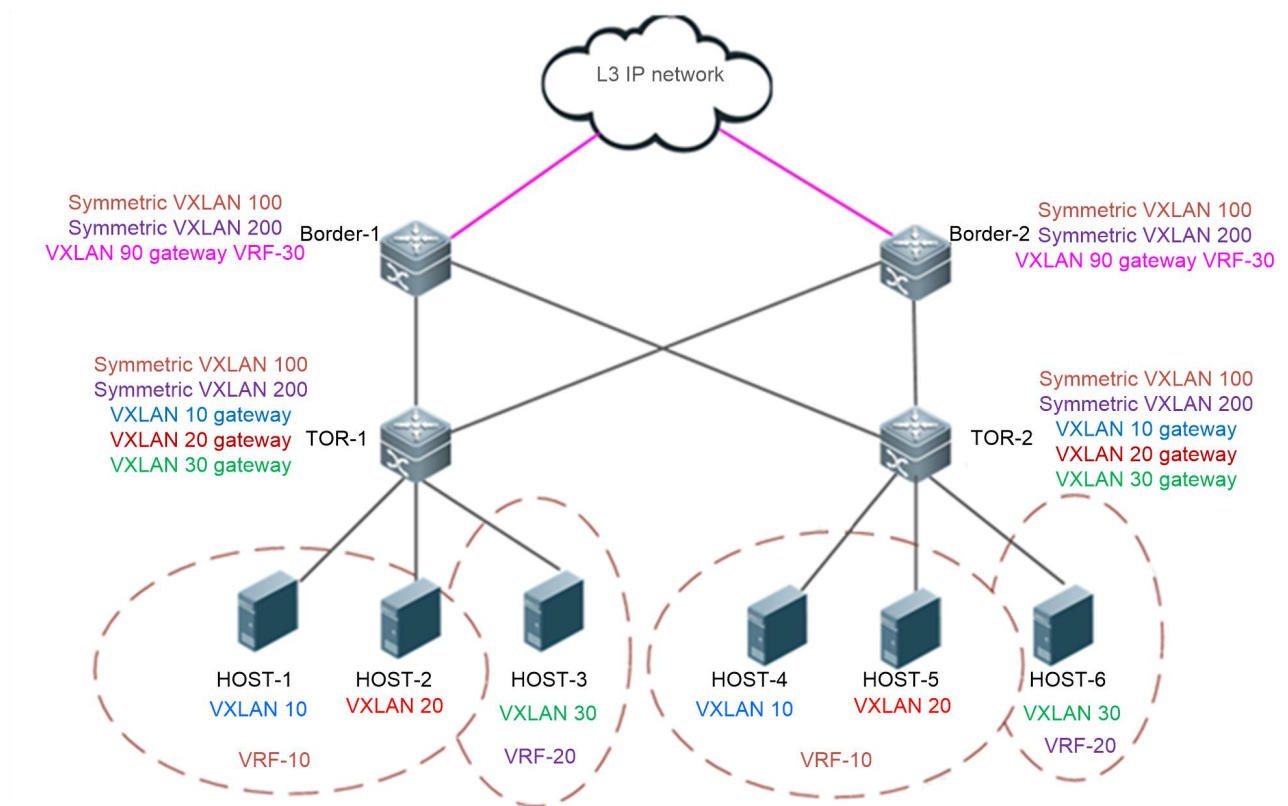

- Packets between HOST-1 and HOST-4 are forwarded through TOR-1 > TOR-2 at L2 within the VXLAN.
- Packets between HOST-1 and HOST-2 are forwarded through TOR-1 at L3 across the VXLANs.
- To access the external network, HOST-1 forwards packets to the border device through TOR1 at L3 across the VXLANs, and then the border device forwards the packets to the external network at L3.

Deployment

- Configure an IPv4 unicast routing protocol, for example, the OSPF protocol, on the switches to ensure that unicast routes are reachable.
- Configure the BGP routing protocol (supporting EVPN) on the switches to establish neighbor relationships between each other (except between the border devices).

- Deploy the VXLAN on the border devices for L3 interconnection with the external network.
- Deploy the VXLAN gateway on the TOR switches.

2.2.5SDN Controller–based Centralized All-active Anycast Gateway Deployment

Scenario

SDN controller–based centralized all-active anycast gateway deployment applies to data center networks that support the control of an SDN controller, as shown in Figure 2-5.

1. VXLAN overlay network topology:

In this scenario, the VXLAN overlay network is a two-layer structure including a core layer and an access layer.

- 1) TOR switches serve as VXLAN bridges to directly connect to servers (virtual machines).
- 2) Core switches serve as VXLAN gateways. Multiple all-active VXLAN physical gateways are deployed in a centralized manner. The physical gateways are in the all-active state. The anycast function is deployed on each physical gateway and the same IP address and MAC address are configured on all gateways to form a logical gateway. The fault of any particular physical gateway does not affect the normal operation of the logical gateway.
- 3) Virtual tunnel end points (VTEPs), including VXLAN bridges and VXLAN gateways, interconnect with each other through the L3 underlay network.
- 4) At the underlay layer, an L3 network connection is established between each TOR switch and each physical gateway. However, all physical gateways are virtualized into one logical gateway VTEP to communicate with the external network. Only one VXLAN tunnel is established between a TOR switch and the logical gateway VTEP. Traffic on the tunnel is balanced to multiple physical gateways via the equal-cost multi-path routing (ECMP).
- 5) No VXLAN tunnel or direct physical link is established between physical gateways.
- 6) On the server (virtual machine), only one logical gateway is visible.
- 7) VRF networks are allocated to multiple tenants. Networks of tenants are isolated from each other.

2. SDN controller management:

On the network, the administrator can configure the overlay network topology through the SDN controller and deliver the configurations to VTEPs. The administrator can also monitor the status of the overlay topology and network traffic through the SDN controller.

In addition, the administrator can manage the servers (virtual machines) on the entire network through the cloud management platform. The SDN controller can associate with the cloud management platform to acquire the configuration information (such as IP address and MAC address) of the virtual machine and deliver the configuration information to VTEPs. After the information is delivered, VXLAN forwarding entries are generated and synchronized on VTEPs.

3. VXLAN device automatic-learning capability

VTEPs can automatically learn the MAC address and the ARP routing table of the host if required, which can be used as an emergency solution for the case that the SDN controller fails. The automatic-learning function can be enabled according to the actual deployment.

Figure 2-5

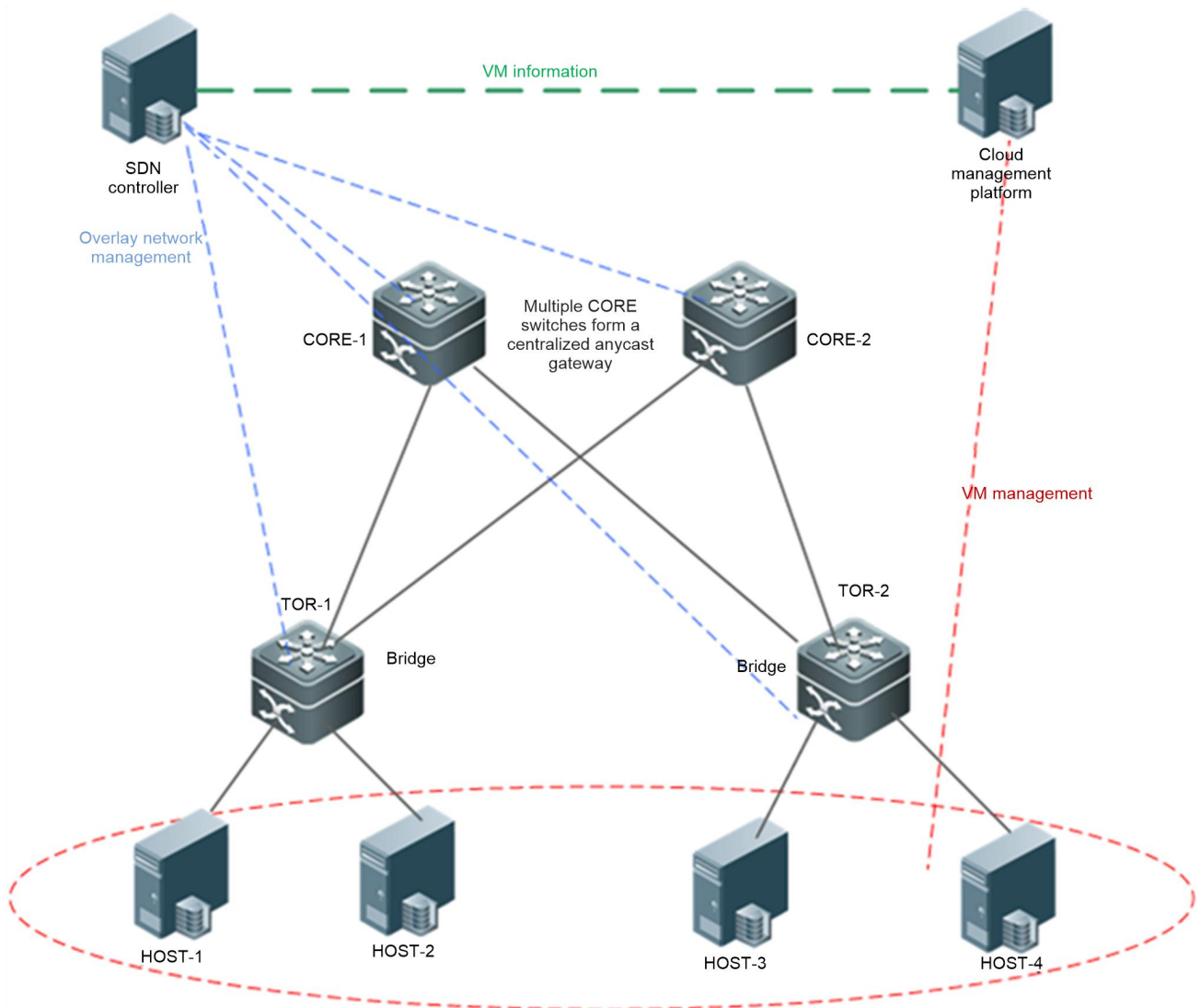

Deployment

- Deploy the VXLAN bridging function on TOR switches and the VXLAN gateway function on the core switches.
- Configure an IPv4 unicast routing protocol, for example, the OSPF protocol, on all VTEPs (including the TOR and core switches) to ensure that unicast routes are reachable.
- On the core gateways, assign the gateway anycast IP addresses to different routing domains to avoid IP conflicts.

2.2.6 Deployment of an EVPN Distributed Network to Be Compatible with Non-EVPN VTEP Devices

Scenario

In a data center where an EVPN-based multi-tenant distributed network is deployed, one VTEP device that does not support the BGP-EVPN protocol (for example, a virtual switch supporting the VXLAN protocol) is connected. See the figure below.

BGP is deployed on the TOR and CORE switches. They mutually establish BGP neighbor relationships and support the EVPN routing protocol.

The VXLAN anycast gateways are deployed on the TOR switches and network-wide gateways share the same IP address and MAC address. TOR switches are directly connected to servers (virtual machines) and core switches are connected to external networks.

VXLANs do not need to be deployed on the core switches.

ARP suppression can be configured on TOR switches to curb flooding of ARP packets, and the TOR switches respond to ARP requests from hosts as a proxy.

The ARP proxy function can be enabled on the TOR switches for all or some VXLANs. In this way, L2 traffic in VXLANs is isolated and server communication traffic in the same VXLAN is forwarded at L3 rather than at L2.

ND suppression can be configured on TOR switches to curb flooding of IPv6 ND protocol packets, and the TOR switches respond to IPv6 NS multicast packets from hosts as a proxy.

When the device does not support the data center interconnection tunnel function, BGP-EVEN can be configured on VTEP-1 and all VTEP devices on the network so that VTEP-1 establish VXLAN tunnels with other VTEP devices, thereby forming a full mesh network. The figure below shows the topology.

Figure 2- 6

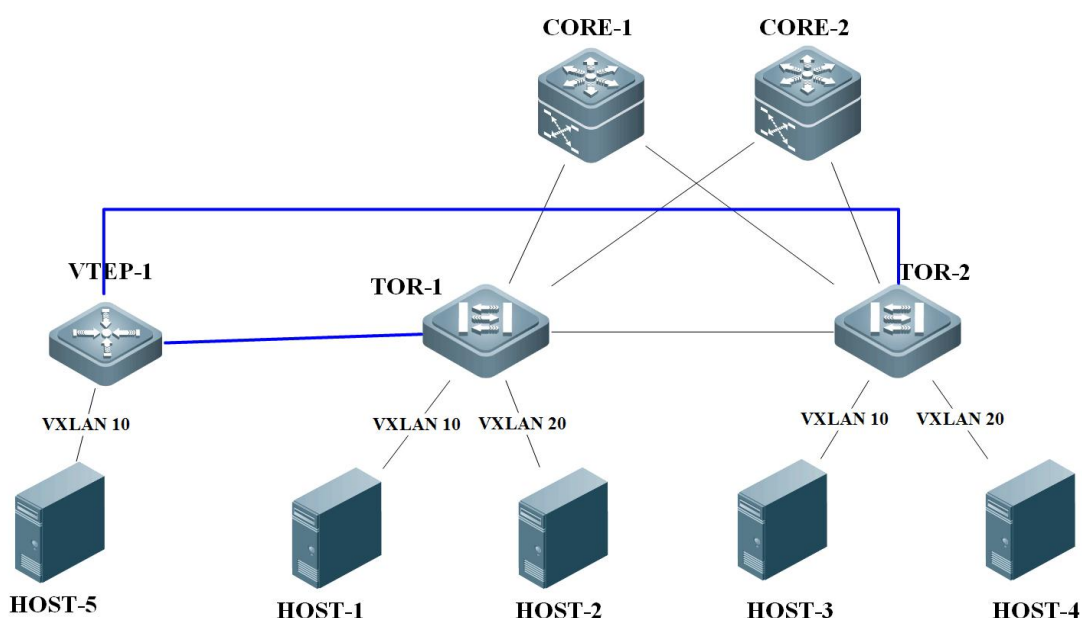

Note: Blue lines in the figure indicate the VXLAN tunnels that the manually configured VTEP-1 establishes with other VTEPs.

Deployment

- Configure an IPv4 unicast routing protocol (such as OSPF) on switches to ensure that unicast routes are reachable.
- Configure the BGP routing protocol (supporting EVPN) on the TOR and core switches so that the switches establish neighbor relationships mutually.
- Deploy the VXLAN gateway on the TOR switches and the VXLAN bridge on VTEPs.
- Configure core switches to interconnect to external networks at L3.
- (Optional) Deploy ARP suppression on the TOR switches.
- (Optional) Deploy ARP proxy on the TOR switches.
- (Optional) Deploy IPv6 ND suppression on the TOR switches.

2.2.7 Deployment of L2 Subinterfaces to Access a VXLAN

Scenario

A server can access a VXLAN through an L2 subinterface and the access using other subinterfaces is not affected.

Figure 2- 7

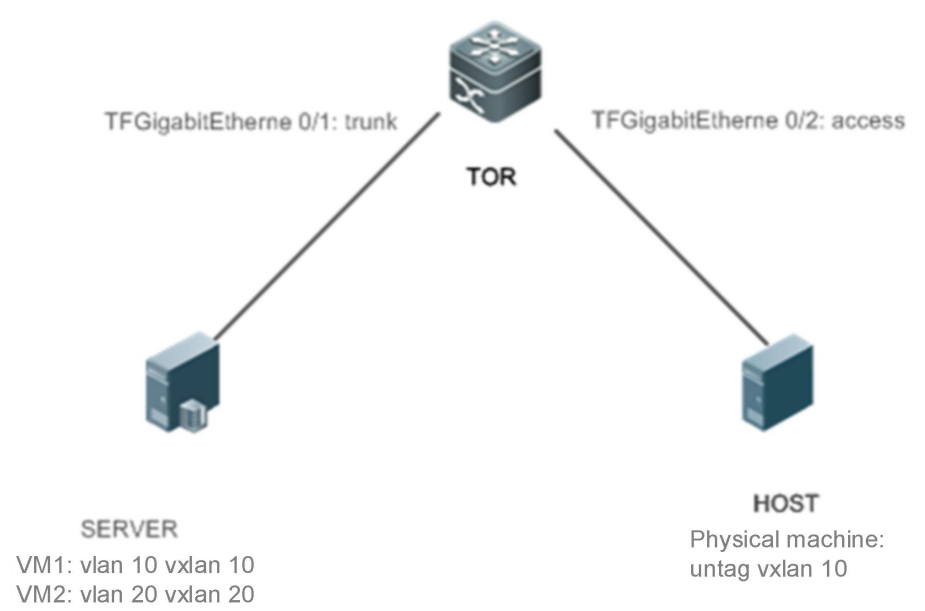

- On the TOR, configure the VLAN or untagged access mode for subinterfaces and configure a VXLAN instance (that is, gateway).

Deployment

- Complete the function configuration on virtual machines on virtual servers as well as on the physical server.
- Create an L2 subinterface on the TOR switch, configure VXLAN encapsulation and VLAN or untagged encapsulation rule for the subinterface.
- Create an overlay router interface on the TOR switch and configure the VXLAN gateway IP address.
- Configure the VXLAN instance to associate with the overlay router interface on the TOR switch to implement VXLAN routing.

2.3 Features

Basic Concepts

📄 VXLAN Packet Format

A VXLAN encapsulates the Ethernet frames into UDP packets and transmits them on the IP core network.

The VXLAN defines a VTEP entity, which encapsulates the data generated by the virtual machine into the UDP headers, and sends the data out. After the encapsulation, the MAC address and VLAN information of the virtual machine no longer serves as the basis for data forwarding.

The VTEP entity can be software, a hardware server, or other device. If the VTEP function is directly integrated into a hypervisor (also called virtual machine monitor), all virtual machine traffic is marked with new VXLAN tags and UDP headers before entering the switch. This is equivalent to creating a tunnel between any two virtual machines.

As the VLAN information of the virtual machine is externally invisible, a new VXLAN label (VNI) is added. VNIs replace VLANs to represent different VXLAN segments. Same as the forwarding behavior of VLANs, only the virtual machines with the same VNI in the same VXLAN segment can communicate with each other.

The new UDP header and VNI form a new frame structure. After receiving the data frame sent from the virtual machine, a VTEP encapsulates four elements (which are the VXLAN header, outer UDP header, outer IPv4 header, and outer Ethernet frame header from inside out) to form a new frame header. In the new frame header, the original source and destination MAC addresses, inner VLAN tag, and Ethernet type that are carried by the inner data frame remain the same.

The format of an encapsulated VXLAN frame is as follows:

Figure 2-8

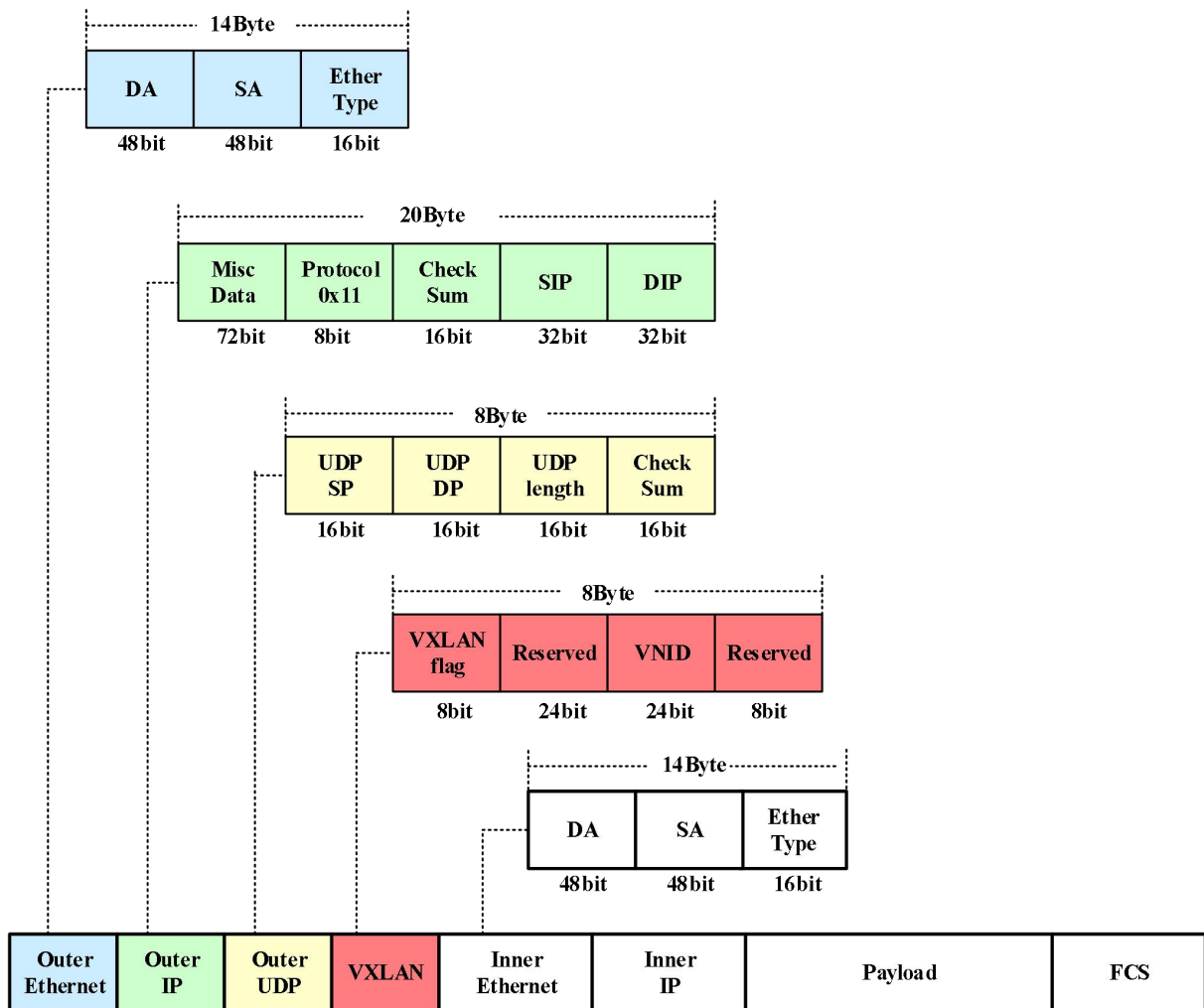

2.3.1 Packet Format

✎ VXLAN Header Information

Figure 2-9

VXLAN Header:

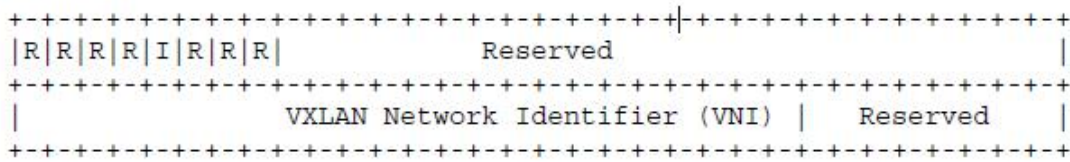

A VXLAN header has 64 bits. In the design of the current protocol version, the sole purpose of a VXLAN header is to carry the 24-bit VNI assigned by the VTEP.

- Flag (8 bits): The I bit must be set to 1 to indicate a valid VNI, and the R bit must be set to 0.
- VXLAN segment ID/VNI: Includes 24 bits and indicates the VXLAN network identifier. Only the virtual machines that belong to the same VXLAN can communicate with each other.
- Reserved: The 24th bit and 8th bit are reserved, and are set to 0.

➤ **Outer UDP Header**

Figure 2-10

Outer UDP Header:

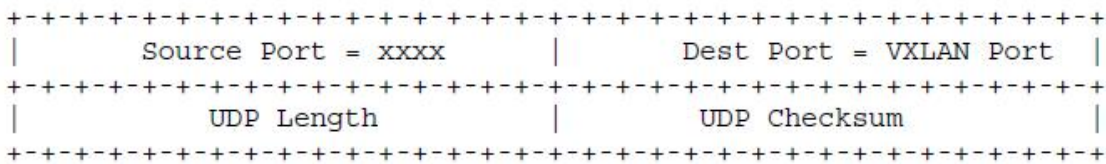

The definitions of the fields of the UDP header are as follows:

- Source Port: Indicates the source port ID of the UDP packet. Assigned by the VTEP, the source port ID is the result of the hash operation of the L2 header of the data frame. This hash result can serve as the basis for traffic load balancing.
- Dest Port: Indicates the destination port ID. The port ID assigned by the Internet Assigned Numbers Authority (IANA) is 4789.
- UDP Length: Indicates the length of the UDP header.
- UDP Checksum: Indicates the UDP checksum, which is set to 0 for transmission.

➤ **Outer IP Header**

Figure 2-11

Outer IPv4 Header:

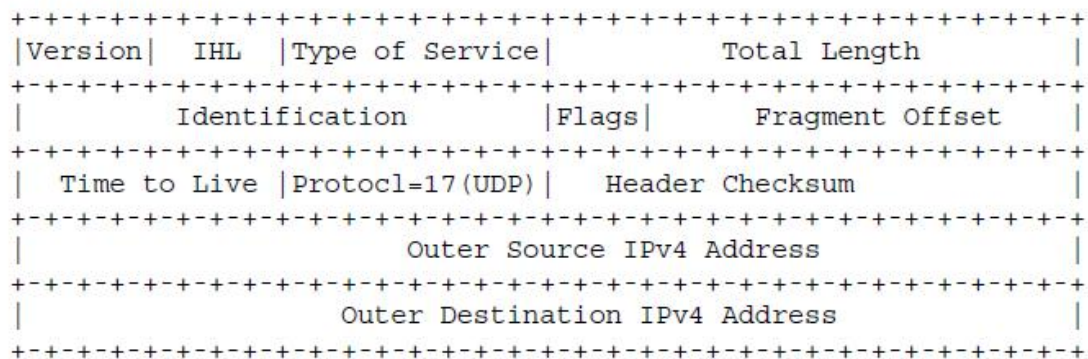

The definitions of the fields of the outer IP header are as follows:

- Source IPv4 Address: Identifies the IP address of the VTEP that corresponds to the virtual machine.
- Destination IPv4 Address: Indicates the unicast or multicast IP address. If it is a unicast IP address, it indicates the IP address of the VTEP corresponding to the virtual machine to be communicated with.

The IP address of the outer IP header is no longer the address of the virtual machines of both communication parties, but the address of the VTEPs at both ends of the tunnel. If the hypervisor directly takes over the work of the VTEP, the IP address is the IP address of the NIC of the server that runs the hypervisor. If the VTEP is an access switch, the IP address is the IP address of an egress interface or the IP address of an L3 switch virtual interface (SVI).

Outer Ethernet Header

Figure 2-12

Outer Ethernet Header:

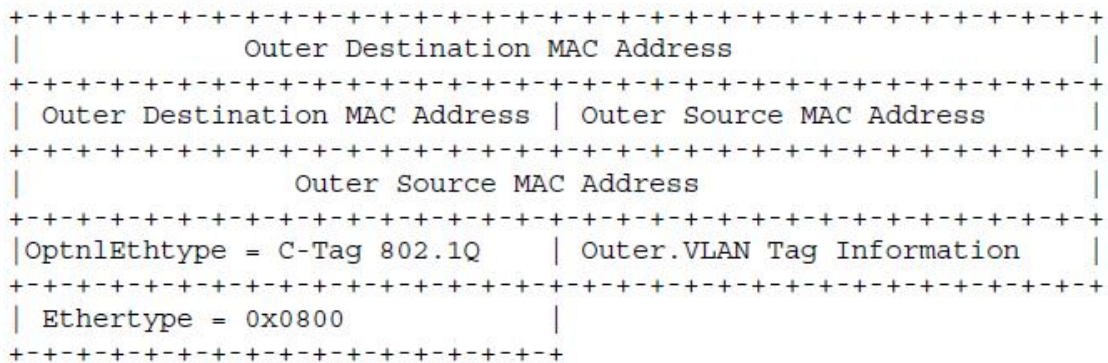

The definitions of the fields of the outer Ethernet header are as follows:

- Destination MAC address: Next-hop MAC address directed to the IP address of the destination VTEP.
- Source MAC address: MAC address of the local VTEP.
- VLAN tag: Optional.

2.3.2 Forwarding Model

VXLAN Bridging Principle

VXLAN encapsulates Ethernet packets within UDP packets to transmit them on the IP network. On the receiver, the VXLAN packets are decapsulated into Ethernet packets and then forwarded, as shown in Figure 2-13.

Figure 2-13

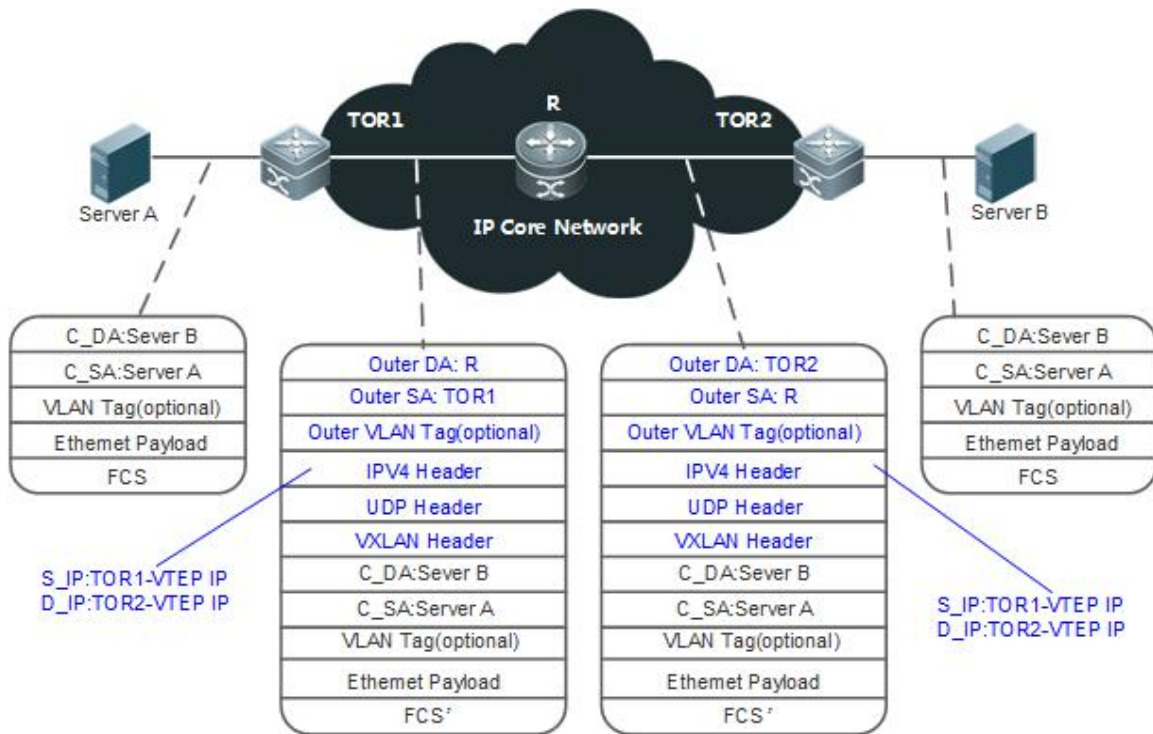

- Switch TOR1 receives the common Ethernet packet, and then encapsulates the packet into a VXLAN packet.
- The VXLAN packet is forwarded in the IP core network. As shown in Figure 2-13, R forwards the VXLAN packet.
- Switch TOR2 receives the VXLAN packet, and then decapsulates and forwards it at L2 of the LAN.

Overview

Feature	Description
VXLAN Bridging and Forwarding	Encapsulates broadcast, multicast, and unknown unicast packets into IP multicast packets to realize flooding. The well-known unicast packets are encapsulated and forwarded by searching the VXLAN address table for the MAC address and IP address.

➤ **VXLAN Routing Principle**

VXLANs interconnect with each other through the VXLAN IP gateway, as shown in Figure 2-14.

Figure 2-14

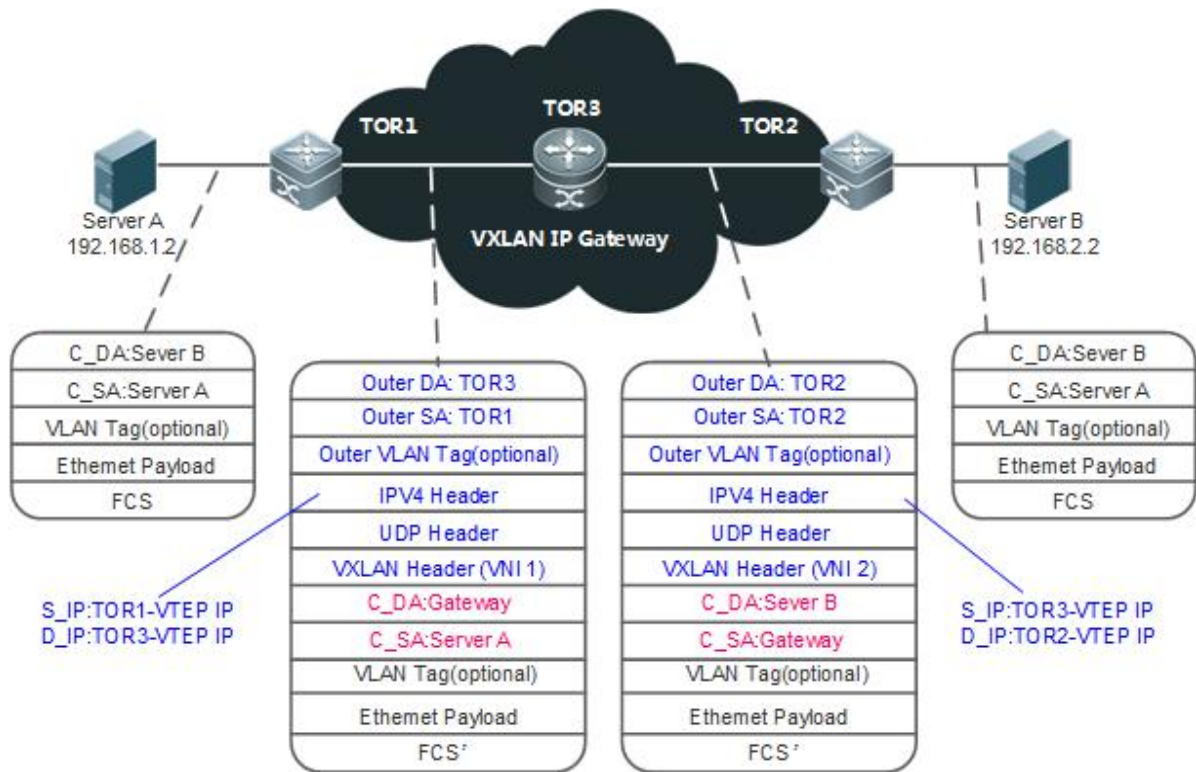

- To implement cross-VXLAN communication, Server A first sends a packet to the IP gateway, which is deployed on TOR3.
- The packet sent by Server A is encapsulated by TOR1 into a VXLAN packet and then sent to TOR3.
- After receiving the VXLAN packet, TOR3 finds that the destination MAC address is the local MAC address and sends the packet to TOR2 after VXLAN routing.
- After receiving the packet from TOR3, TOR2 decapsulates the packet and sends it to Server B.

Overview

Feature	Description
VXLAN Routing and Forwarding	Implements cross-VXLAN communication and supports communication between a conventional IP network and a VXLAN. A VXLAN router can serve as a VXLAN IP gateway.

2.3.3 Forwarding Process

Working Principle

As shown in Figure 2-15, three servers use a VXLAN to achieve L2 interconnection on the IP network. The VXLAN VNI is 100.

Figure 2-15

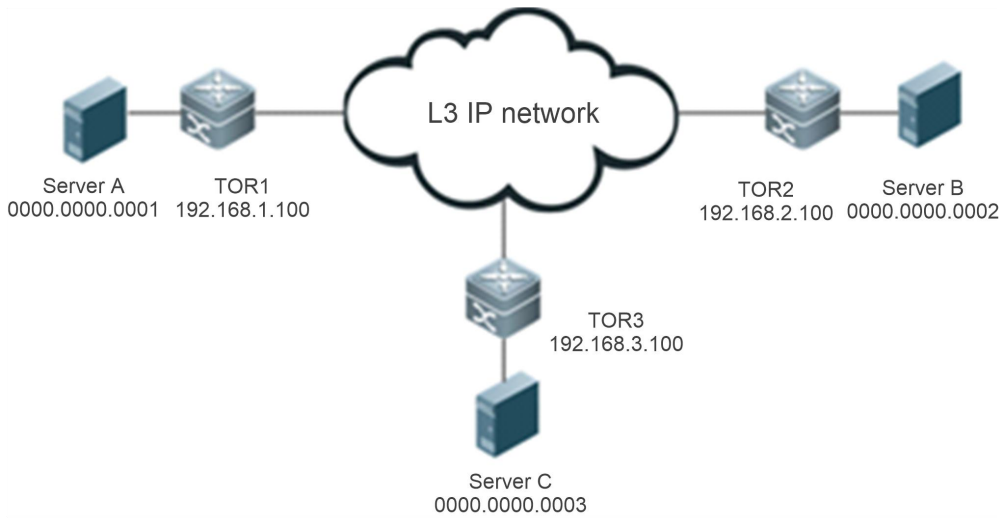

The VXLAN packet forwarding process is described by using an example in which Server A sends an Address Resolution Protocol (ARP) request to Server B and Server B returns an ARP response.

Figure 2-16

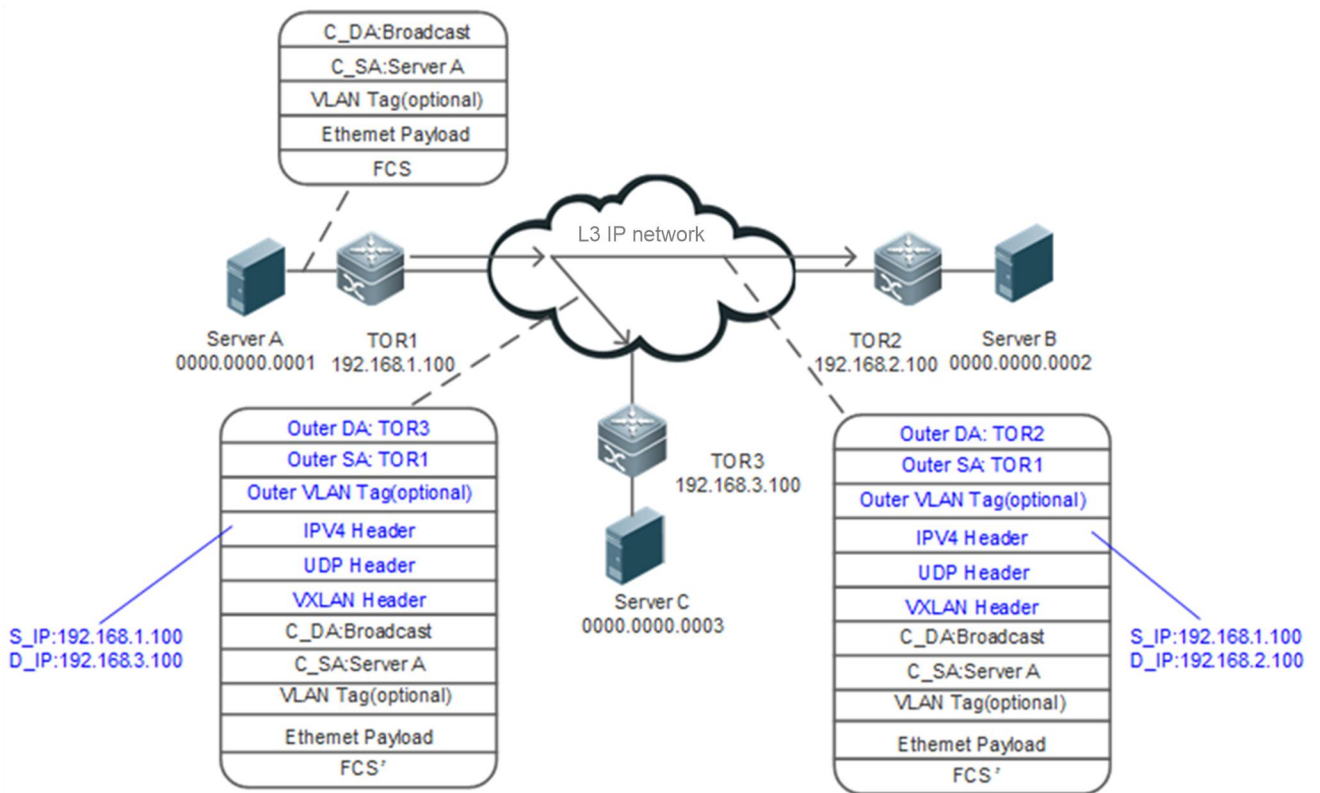

- ✓ Server A sends an ARP request, which is a broadcast packet. After receiving the ARP request, switch TOR1 floods the broadcast packet in tunnel header replication mode, encapsulates it into two unicast packets, and sends them to TOR2 and TOR3 through tunnels. (Switch TOR1 floods the broadcast packet to all tunnels. The tunnel between TOR1 and TOR2, and tunnel between TOR1 and TOR3 are created.)
- ✓ The IP core network forwards the multicast VXLAN packet.

Figure 2-17

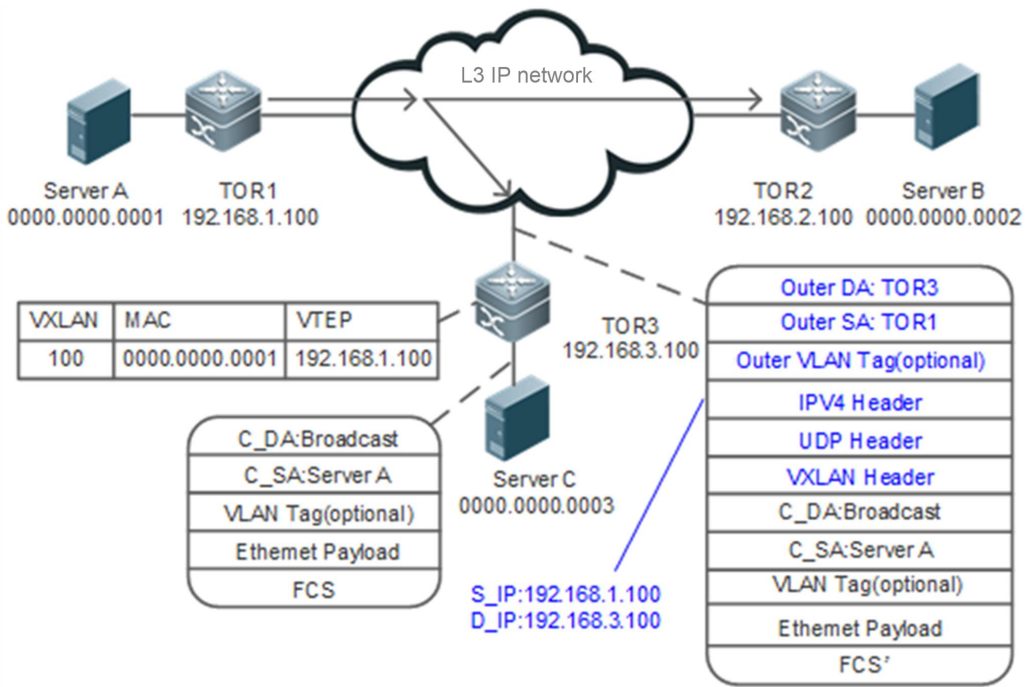

- ✓ After receiving the VXLAN packet, TOR3 decapsulates the packet into an Ethernet packet and implements VXLAN address learning (the VXLAN ID is 100, the MAC address is 0000.0000.0001, and the IP address is 192.168.1.100).

Figure 2-18

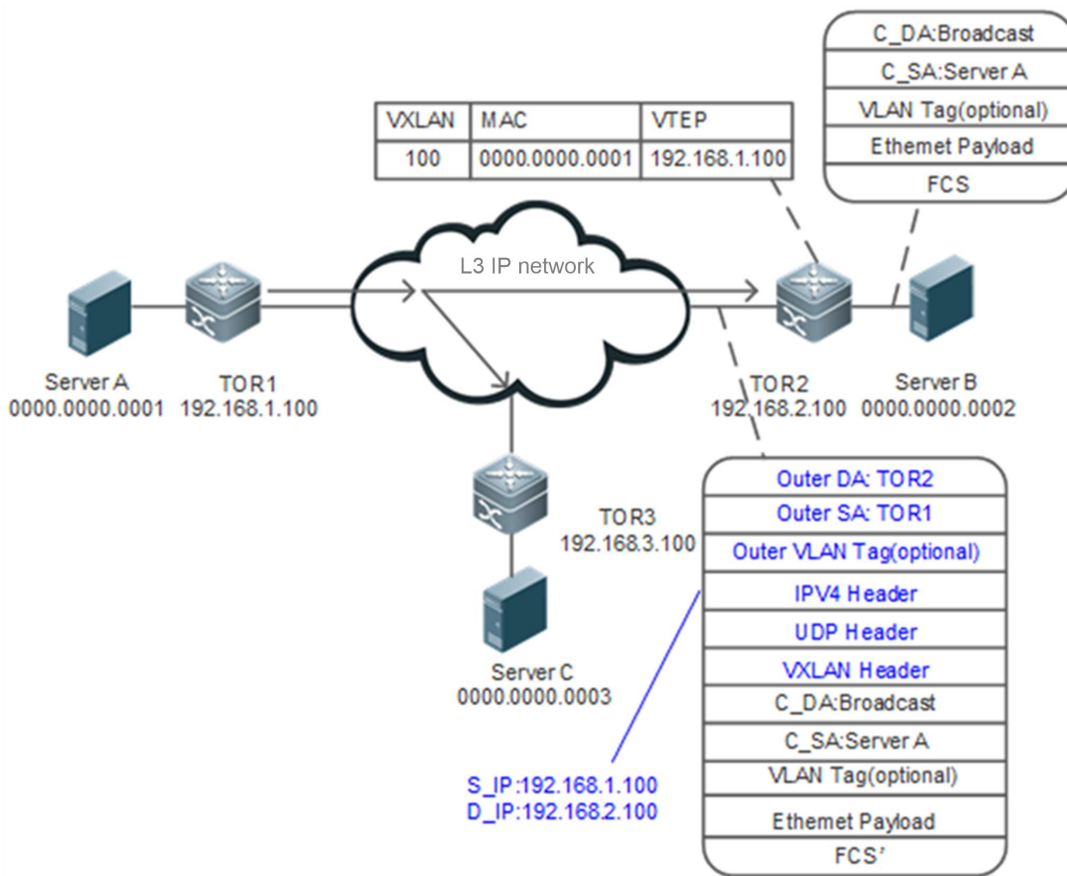

- ✓ After receiving the VXLAN packet, TOR2 decapsulates the packet into an Ethernet packet, implements address learning (the VXLAN ID is 100, the MAC address is 0000.0000.0001, and the IP address is 192.168.1.100) and forwards the packet. Then, Server B receives the ARP request packet and returns a response packet.

Figure 2-19

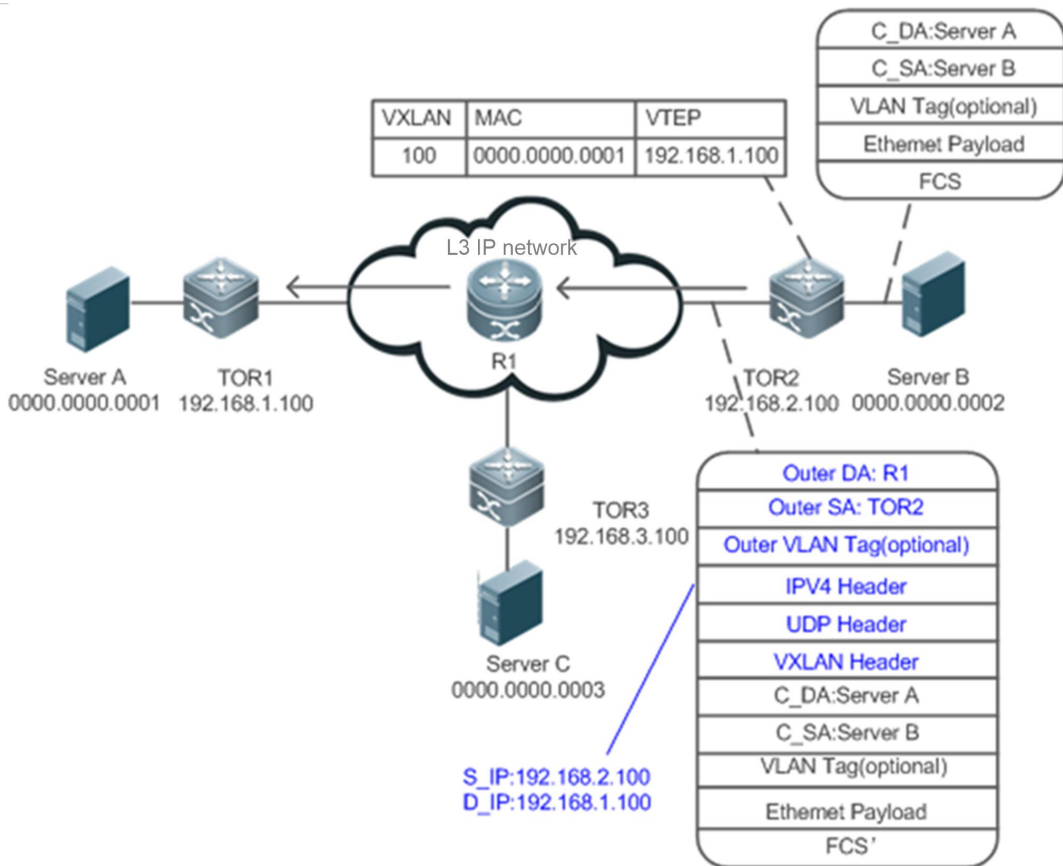

- ✓ After receiving the ARP response packet from Server B, TOR2 searches the address table and finds that the destination IP address is 192.168.1.100. Then, TOR2 encapsulates the packet into a unicast VXLAN packet (the outer source IP address is 192.168.2.100) destined for the switch at 192.168.1.100.

Figure 2-20

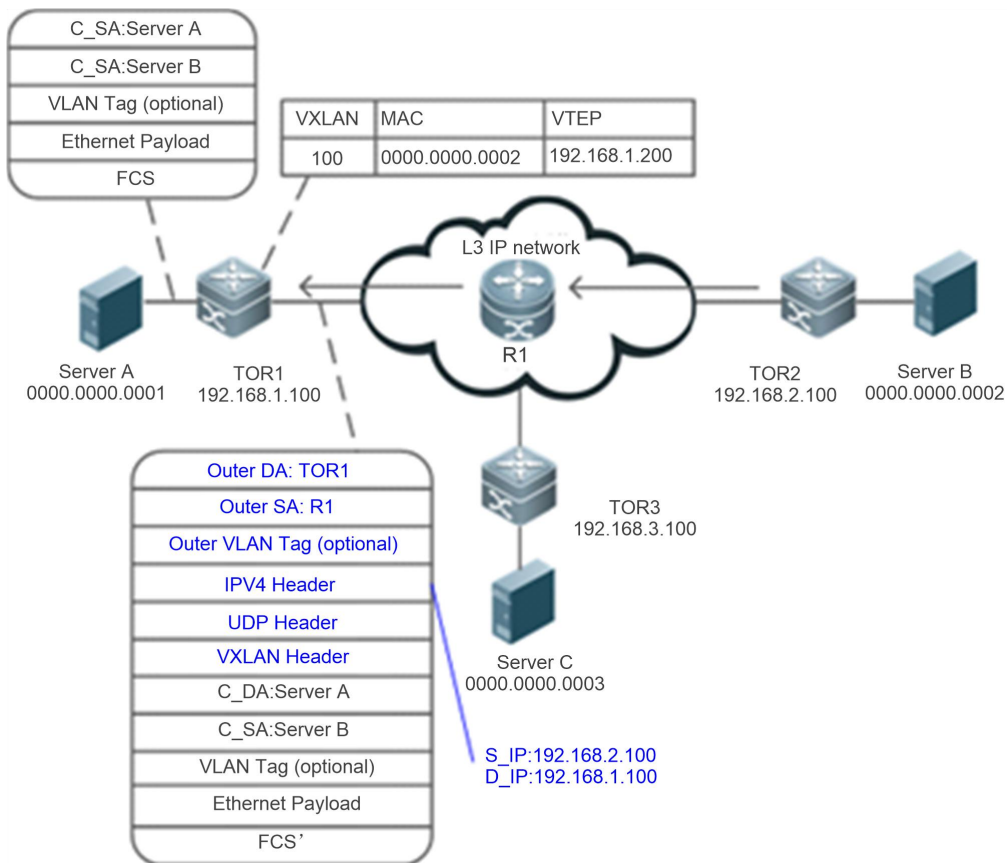

- ✔ The IP core network forwards the VXLAN packet.
- ✔ TOR1 receives the ARP response packet encapsulated in the VXLAN, decapsulates the packet into an Ethernet packet, implements VXLAN address learning (the VXLAN ID is 100, the MAC address is 0000.0000.0002, and the IP address is 192.168.2.100), and forwards the packet. Then, Server A receives the ARP response packet.

➤ **Multicast VXLAN Packet Flooding**

A VXLAN uses multicast packets to flood broadcast, multicast, and unknown unicast packets. After receiving an ARP request packet, TOR1 encapsulates the packet into a multicast VXLAN packet and sends it to TOR2 and TOR3, as shown in Figure 2-21.

Figure 2-21

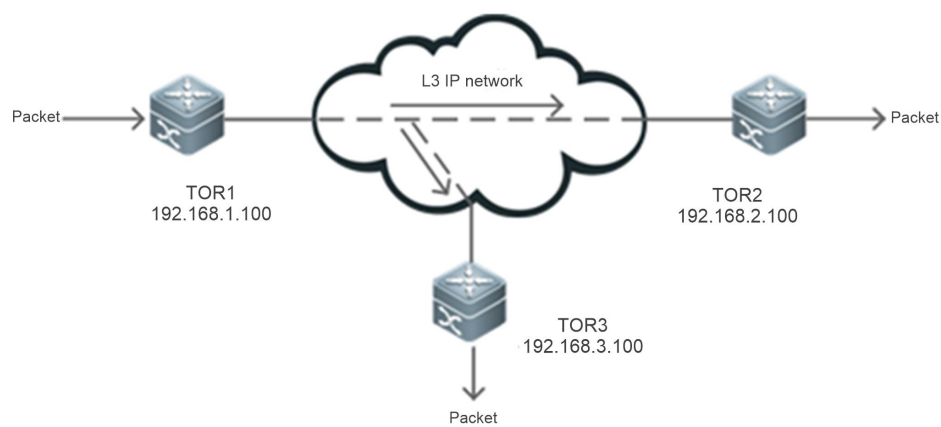

✚ VTEP Address Learning

As shown in Figure 2-21, in the process of using multicast packets to flood broadcast, multicast, and unknown unicast packets, TOR2 and TOR3 learn the VTEP information during decapsulation, and therefore establish neighbor relationships.

Related Configuration

✚ Configuring VXLAN Type Instance

No VXLAN instance is configured on the switches by default.

Run the **vxlan vni-number** command to create a VXLAN instance.

✚ Configuring VLAN Associated with VXLAN Instance

Run the **extend-vlan vlan-id** command in VXLAN instance configuration mode to configure the associated VLAN.

2.4 Configuration

2.4.1 Configuring VXLAN SDN

Configuration Effect

- Create a VXLAN instance and associate it with the overlay router interface and overlay tunnel interface. Provide the VXLAN routing (IP gateway) function to achieve cross-VXLAN communication. The VXLAN configurations can be delivered by the SDN controller over communication mechanisms such as Network Configuration Protocol (NETCONF), or can be implemented by CLI configuration.
- Configure the anycast gateway and an anycast MAC address to provide centralized anycast all-active gateway function. The centralized anycast all-active gateways serve as one logical gateway (VTEP) to communicate with external devices and use the same VTEP IP address. Only one tunnel is configured between each TOR bridge device and the logical gateway. Packets are balanced to physical gateways via the underlay ECMP to achieve the gateway all-active function.
- Enable the SDN controller to deliver the host routes and VXLAN forwarding flow table to the gateways and the gateways generate routes and entries through automatic learning. You can run the configuration commands to enable or disable the automatic learning function on the gateways. When the SDN controller malfunctions, the automatic learning function ensures that the VXLAN works normally.

Notes

- The VXLAN configurations can be delivered by the SDN controller over communication mechanisms such as NETCONF, or can be implemented by CLI configuration. Only configuration delivery from the SDN controller is recommended in normal cases.
- The VXLAN instances require support from existing unicast routes on the network. Therefore, an IPv4 unicast routing protocol, for example, the OSPF protocol, must be configured on the network devices.
- On the centralized anycast gateways, assign the gateway anycast IP addresses to different routing domains to avoid IP conflicts.

Configuration Steps

↘ **Creating VXLAN Instances**

- Mandatory.

↘ **Creating Overlay Router Interfaces**

- Mandatory for VXLAN gateways.

↘ **Configuring Overlay Router Interfaces as Anycast**

- Mandatory for centralized anycast gateways.

↘ **Configuring Anycast MAC Address**

- Mandatory for centralized anycast gateways.

↘ **Configuring Overlay Tunnel**

- Mandatory.

↘ **Configuring Source and Destination IP Addresses for Overlay Tunnel**

- Mandatory.

↘ **Associating VXLAN Instance with Overlay Router Interface**

- Mandatory for gateways.

↘ **Associating VXLAN Instance with VLAN**

- Mandatory for TOR bridges.

↘ **Associating VXLAN Instance with Overlay Tunnel**

- Mandatory.
- This is used to statically designate a VXLAN tunnel.

↘ **Configuring Storm Control of VXLAN Instances**

- Optional.
- This function is required only when the storm rate needs to be limited based on VXLAN instances.

↘ **Configuring Static VXLAN MAC Address Table**

- Optional. The VXLAN MAC address table delivered by the SDN controller is represented as a static VXLAN MAC address table.
- You can also configure the static VXLAN MAC address table via CLI configuration.

➤ **Configuring VXLAN UDP Destination Port**

- Optional. As the VXLAN UDP destination port used by early devices may not be Port 4789, you can run this command to achieve compatibility. In addition, you can also run this command to customize the VXLAN UDP destination port.
- The VXLAN UDP destination port 4789 designated by IANA is used by default.

➤ **Enabling ARP Automatic Learning**

- Optional. ARP automatic learning is enabled by default.
- After the ARP automatic learning function is enabled, the gateways can automatically learn the APR entries without relying on the SDN control to deliver.

➤ **Enabling IPv6 ND Automatic Learning**

- Optional. IPv6 ND automatic learning is enabled by default.
- After the IPv6 ND automatic learning function is enabled, the device can automatically learn the host ND entries, with no need to thoroughly rely on ND entries delivered by the SDN controller.

Verification

After SDN-VXLAN is enabled, virtual machines can communicate with each other.

- Run the **show vxlan vni-number** command to check whether the VXLAN devices can learn their mutual VTEP neighbor relationships.
- Run the **show vxlan mac** command to check whether the VXLAN MAC address is learned.
- Run the **show arp** command to check whether all local/remote entries are learned. Run the **show ip route** command to check whether the routes of VXLAN IP gateways are learned.
- Run the **show ipv6 neighbors** command to check whether all local/remote IPv6 ND entries are learned. Run the **show ipv6 route** command to check whether the routes of the VXLAN IPv6 gateways are learned.
- Run the **show vxlan udp-port** command to display the VXLAN UDP destination port.

Related Commands

➤ **Creating or Entering VXLAN Instances**

Command	vxlan vni-number
Parameter Description	<i>vni-number</i> : Indicates the VNI. The value ranges from 1 to 16777215.
Command Mode	Global configuration mode
Usage Guide	N/A

➤ **Associating VXLAN Instance with VLAN**

Command	extend-vlan vlan-id-list
Parameter Description	<i>vlan-id-list</i> : Indicates the VLAN ID queue. The VLAN ID ranges from 1 to 4094.
Command Mode	VXLAN configuration mode

Usage Guide	Use this command to associate the VXLAN instance with the VLAN. After receiving the VLAN packet, the device will be associated with the VLAN instance.
--------------------	--

↘ Creating Overlay Router Interfaces

Command	interface OverlayRouter <i>port-id</i>
Parameter Description	<i>port-id</i> : Indicates the ID of an overlay router interface. The ID ranges from 1 to 16,777,215.
Command Mode	Global configuration mode
Usage Guide	Similar to SVI in a VLAN, this interface serves as the VXLAN IP gateway in the VXLAN routing environment.

↘ Configuring VRF Network for Overlay Router Interface

Command	vrf forwarding <i>vrf-name</i>
Parameter Description	<i>vrf-name</i> : Indicates the VRF network to which the overlay router interface belongs.
Command Mode	Overlay router interface configuration mode
Usage Guide	Allocate VRF networks to different VXLAN tenants. The traffic of VXLAN instances of different VRF networks is isolated from each other.

↘ Configuring IP Address for Overlay Router Interface

Command	ip address <i>ip-address mask</i>
Parameter Description	<i>ip-address</i> : Indicates the IP address of the overlay router interface. <i>mask</i> : Indicates the subnet mask.
Command Mode	Overlay router interface configuration mode
Usage Guide	Similar to the IP address of the SVI in a VLAN, this IP address serves as the address of the VXLAN IP gateway in the VXLAN routing environment.

↘ Configuring an IPv6 Address for the Overlay Router Interface

Command	ipv6 address <i>ip-address mask</i>
Parameter Description	<i>ip-address</i> : Indicates the IPv6 address of the overlay router interface. <i>mask</i> : Indicates the subnet mask.
Command Mode	Overlay router interface configuration mode
Usage Guide	This IPv6 address serves as the VXLAN IPv6 gateway address in the VXLAN routing environment. It is similar to the IP address of an SVI in a VLAN.

↘ Configuring the Overlay Router Interface as an Anycast Interface

Command	anycast-gateway
Parameter Description	N/A
Command Mode	Overlay router interface configuration mode
Usage Guide	Configure the gateway as an anycast gateway.

↘ Associating VXLAN Instance with Overlay Router Interface

Command	router-interface <i>interface-name</i>
Parameter	<i>interface-name</i> : Indicates the name of the overlay router interface.
Description	
Command	VXLAN configuration mode
Mode	
Usage Guide	Different VXLANs cannot be associated with the same overlay router interface.

↘ Configuring Virtual MAC Address for Anycast Gateways

Command	fabric anycast-gateway-mac <i>mac-addr</i>
Parameter	<i>mac-addr</i> : Indicates the MAC address. The format is xxxx.xxxx.xxxx.
Description	
Command	Global configuration mode
Mode	
Usage Guide	All gateways on which the anycast function is enabled use this MAC address as the gateway MAC address. The virtual MAC address for an anycast gateway must not be the same as the local MAC address or the same as the MAC address of any device on the overlay network.

↘ Creating Overlay Tunnel Interfaces

Command	interface OverlayTunnel <i>port-id</i>
Parameter	<i>port-id</i> : Indicates the ID of the overlay tunnel interface. The ID ranges from 1 to 6144.
Description	
Command	Global configuration mode
Mode	
Usage Guide	This interface is used to statically create an overlay tunnel. You can run the tunnel-interface command to associate it with a VXLAN.

↘ Configuring Source IP Address for Tunnel of Overlay Tunnel Interface

Command	tunnel source <i>ip-address</i>
Parameter	<i>ip-address</i> : Indicates the source IP address of a tunnel.
Description	
Command	Overlay tunnel interface configuration mode
Mode	
Usage Guide	Use this command to designate a source IP address for the overlay tunnel. Designate this IP address as the outer source IP address of a packet for encapsulation and forwarding.

↘ Configuring Destination IP Address for Tunnel of Overlay Tunnel Interface

Command	tunnel destination <i>ip-address</i>
Parameter	<i>ip-address</i> : Indicates the destination IP address of a tunnel.
Description	
Command	Overlay tunnel interface configuration mode
Mode	
Usage Guide	Use this command to designate a destination IP address for the overlay tunnel. Designate this IP address as the outer

destination IP address of a packet for encapsulation and forwarding. The destination IP address of the tunnel is globally unique. Different overlay tunnels cannot be configured with the same destination IP address. Otherwise, a conflict occurs.

↘ Associating VXLAN Instance with Overlay Tunnel Interface

Command	tunnel-interface <i>interface-name</i>
Parameter	<i>interface-name</i> : Indicates the name of the overlay tunnel interface.
Description	
Command Mode	VXLAN configuration mode
Usage Guide	Use this command to designate the VXLAN VTEP statically.

↘ Configuring Storm Control of VXLAN Instances

Command	storm-control {broadcast multicast unicast} [kpbs-value pps pps-value]
Parameter	<i>kpbs-value</i> : Indicates the rate limit value (unit: kbit/s).
Description	<i>pps-value</i> : Indicates the rate limit value (unit: packet count/s).
Command Mode	VXLAN configuration mode
Usage Guide	Configure the storm control when the storm rate needs to be limited based on the VNI.

↘ Configuring Static VXLAN MAC Address Table

Command	vxlan mac static <i>mac-addr vni vxlan-id interface interface-name</i>
Parameter	<i>mac-addr</i> : Indicates the MAC entry address. The format is xxxx.xxxx.xxxx.
Description	<i>vxlan-id</i> : Indicates the VNI of the MAC entry. <i>interface-name</i> : Indicates the next hop egress of the MAC table. It can be an overlay tunnel interface, an Ethernet interface, or an aggregate port (AP). <i>vid</i> : Indicates the ID of a VLAN to which the MAC entry belongs.
Command Mode	Global configuration mode
Usage Guide	1. Use this command to deliver the static VXLAN MAC entries via the SDN controller or configure the static VXLAN MAC entries via CLI static configuration. This command is mainly used for setting the host forwarding table. 2. When the next-hop interface is not an overlay tunnel interface, a VID must be configured and the VID is not required for overlay tunnel interfaces.

↘ Configuring VXLAN UDP Destination Port

Command	vxlan udp-port <i>port-number</i>
Parameter	<i>port-number</i> : Indicates the UDP destination port ID. The value ranges from 0 to 65535 and the default value is 4789.
Description	
Command Mode	Global configuration mode
Usage Guide	Note that the UDP destination port cannot be same as commonly used UDP ports.

Configuration Example

 Only configuration related to the VXLAN is described below.

i Only IPv4 configuration is used as an example below and the IPv6 scenario configuration is largely the same as the IPv4 scenario configuration.

➤ VXLAN Configuration Instance

<p>Scenario Figure 2- 22</p>	
<p>Configuration Steps</p>	<ul style="list-style-type: none"> ● Configure an IPv4 unicast routing protocol such as the OSPF protocol on TOR-1, TOR-2, CORE-1, and CORE-2 to ensure that unicast routes are reachable. ● Configure loopback IP addresses on TOR-1, TOR-2, CORE-1, and CORE-2 and distribute packets via the unicast routing protocol. The VTEP IP addresses of CORE-1 and CORE-2 must be the same and be allocated to different routing domains. ● Configure a VXLAN on the virtual server and designate the gateway address of the virtual machine. . ● Establish a BGP neighbor relationship between CORE-1 and CORE-2 and configure the BGP-EVPN routing protocol on them. <p>The following configuration can be delivered by the SDN controller:</p> <ul style="list-style-type: none"> ● Create VXLAN instances VXLAN 10 and VXLAN 20 on TOR-1, and associate them with VLAN 10 and VLAN 20 respectively. Configure the address learning mode as SDN controller advertisement. Configure two overlay tunnels to connect TOR-1 with TOR-2 and CORE. Associate VXLAN 10 and VXLAN 20 with the two tunnels separately. ● Create VXLAN instance VXLAN 20 on TOR-2 and associate it with VLAN 20. Configure the address learning mode as

	<p>SDN controller advertisement. Configure two overlay tunnels to connect TOR-2 with TOR-1 and CORE-2. Associate VXLAN 20 with the two tunnels.</p> <ul style="list-style-type: none"> ● Create VXLAN instances VXLAN 10 and VXLAN 20 on CORE-1. Configure the address learning mode as SDN controller advertisement. Configure the anycast MAC address. Configure two overlay router gateway interfaces and configure their IP addresses as 10.1.1.1/24 and 10.1.2.1/24 respectively. Associate VXLAN 10 with the overlay router gateway interface with the IP address 10.1.1.1/24. Associate VXLAN 20 with the overlay router gateway interface with the IP address 10.1.2.1/24. Configure two overlay tunnels to connect CORE-1 with TOR-1 and TOR-2. Associate VXLAN 10 and VXLAN 20 with the two tunnels separately. <p>Enable the synchronization function on all-active VXLAN gateways to synchronize the automatically learned entries between the gateways.</p> <ul style="list-style-type: none"> ● The configuration of CORE-2 is same with that of CORE-1.
<p>TOR1</p>	<pre>TOR1# configure terminal Enter configuration commands, one per line. End with CNTL/Z. TOR1(config)#interface loopback 0 TOR1(config-if-Loopback 0)# ip address 1.1.1.1 255.255.255.255 TOR1(config-if-Loopback 0)# exit TOR1(config)# interface OverlayTunnel 1 TOR1(config-if-OverlayTunnel 1)# tunnel source 1.1.1.1 TOR1(config-if-OverlayTunnel 1)# tunnel destination 2.2.2.2 TOR1(config-if-OverlayTunnel 1)# exit TOR1(config)# interface OverlayTunnel 2 TOR1(config-if-OverlayTunnel 2)# tunnel source 1.1.1.1 TOR1(config-if-OverlayTunnel 2)# tunnel destination 3.3.3.3 TOR1(config-if-OverlayTunnel 2)# exit TOR1(config)# vxlan 10 TOR1(config-vxlan)# tunnel-interface OverlayTunnel 1 TOR1(config-vxlan)# tunnel-interface OverlayTunnel 2 TOR1(config-vxlan)# extend-vlan 10 TOR1(config-vxlan)# end TOR1(config)# vxlan 20 TOR1(config-vxlan)# tunnel-interface OverlayTunnel 1 TOR1(config-vxlan)# tunnel-interface OverlayTunnel 2 TOR1(config-vxlan)# extend-vlan 20 TOR1(config-vxlan)# end</pre>
<p>TOR2</p>	<pre>TOR2# configure terminal Enter configuration commands, one per line. End with CNTL/Z. TOR2(config)#interface loopback 0 TOR2(config-if-Loopback 0)# ip address 2.2.2.2 255.255.255.255 TOR2(config-if-Loopback 0)# exit TOR2(config)# interface OverlayTunnel 1 TOR2(config-if-OverlayTunnel 1)# tunnel source 2.2.2.2 TOR2(config-if-OverlayTunnel 1)# tunnel destination 1.1.1.1 TOR2(config-if-OverlayTunnel 1)# exit</pre>

	<pre>TOR2(config)# interface OverlayTunnel 2 TOR2(config-if-OverlayTunnel 2)# tunnel source 2.2.2.2 TOR2(config-if-OverlayTunnel 2)# tunnel destination 3.3.3.3 TOR2(config-if-OverlayTunnel 2)# exit TOR2(config)# vxlan 20 TOR2(config-vxlan)# tunnel-interface OverlayTunnel 1 TOR2(config-vxlan)# tunnel-interface OverlayTunnel 2 TOR2(config-vxlan)# extend-vlan 20 TOR2(config-vxlan)# end</pre>
CORE1	<p>Create VXLAN instances VXLAN10 and VXLAN20 on CORE-1. Set the address learning mode to SDN controller advertisement. Configure an anycast MAC address. Configure two overlay router gateway interfaces and set their IP addresses to 10.1.1.1/24 and 10.1.2.1/24 respectively. Configure VXLAN10 to associate with the overlay router gateway interface with the IP address of 10.1.1.1/24. Configure VXLAN20 to associate with the overlay router gateway interface with the IP address of 10.1.2.1/24. Configure two overlay tunnels reachable to TOR1 and TOR2 respectively. Configure VXLAN10 and VXLAN20 to associate with the two tunnels respectively. Configure loopback 1 on both CORE-1 and CORE-2 and set the IP address to 3.3.3.4 and 3.3.3.5 for loopback 1. The two core switches establish a BGP neighbor relationship through loopback 1. Configure the L2VPN EVPN address family activation command.</p> <pre>TOR1# configure terminal Enter configuration commands, one per line. End with CNTL/Z. CORE1(config)# fabric anycast-gateway-mac 0000.1234.5678 CORE1(config)# interface loopback 0 CORE1(config-if-Loopback 0)# ip address 3.3.3.3 255.255.255.255 CORE1(config-if-Loopback 0)# exit CORE1(config)# interface loopback 1 CORE1(config-if-Loopback 0)# ip address 3.3.3.4 255.255.255.255 CORE1(config-if-Loopback 0)# exit CORE1(config)# route bgp 10000 CORE1(config-router)# neighbor 3.3.3.5 remote-as 10000 CORE1(config-router)# neighbor 3.3.3.5 update-source Loopback 1 CORE1(config-router)# address-family l2vpn evpn CORE1(config-router-af)# neighbor 3.3.3.5 activate CORE1(config-router-af)# neighbor 3.3.3.5 send-community extended CORE1(config-router-af)# exit-address-family CORE1(config-router)#exit CORE1(config)# interface OverlayTunnel 1 CORE1(config-if-OverlayTunnel 1)# tunnel source 3.3.3.3 CORE1(config-if-OverlayTunnel 1)# tunnel destination 2.2.2.2 CORE1(config-if-OverlayTunnel 1)# exit CORE1(config)# interface OverlayTunnel 2 CORE1(config-if-OverlayTunnel 2)# tunnel source 3.3.3.3 CORE1(config-if-OverlayTunnel 2)# tunnel destination 1.1.1.1 CORE1(config-if-OverlayTunnel 2)# exit CORE1(config)# interface overlayrouter 1 CORE1(config-if-OverlayRouter 1)# ip address 10.1.1.1/24</pre>

	<pre> CORE1(config-if-OverlayRouter 1)# anycast-gateway CORE1(config-if-OverlayRouter 1)# exit CORE1(config)# interface overlayrouter 2 CORE1(config-if-OverlayRouter 2)# ip address 10.1.2.1/24 CORE1(config-if-OverlayRouter 2)# anycast-gateway CORE1(config-if-OverlayRouter 2)# exit CORE1(config)# vxlan 10 CORE1(config-vxlan)# tunnel-interface OverlayTunnel 1 CORE1(config-vxlan)# tunnel-interface OverlayTunnel 2 CORE1(config-vxlan)# router-interface OverlayRouter 1 CORE1(config-vxlan)# end CORE1(config)# vxlan 20 CORE1(config-vxlan)# tunnel-interface OverlayTunnel 1 CORE1(config-vxlan)# tunnel-interface OverlayTunnel 2 CORE1(config-vxlan)# router-interface OverlayRouter 2 CORE1(config-vxlan)# end </pre>																																																																																																
CORE-2	Same with that of CORE-1																																																																																																
Verification	<ul style="list-style-type: none"> ● Verify that the virtual machines of HOST-1, HOST-2, HOST-3, and HOST-4 can ping each other. ● Display the static MAC entries of hosts delivered by the SDN controller on TOR and core switches. <pre> TOR1(config)#show vxlan mac </pre> <table border="1"> <thead> <tr> <th>Vxlan</th> <th>MAC Address</th> <th>Type</th> <th>Location</th> <th>Interface</th> <th>Vlan</th> </tr> </thead> <tbody> <tr> <td>10</td> <td>0000.0000.0001</td> <td>STATIC</td> <td>LOCAL</td> <td>GigabitEthernet 0/1</td> <td>10</td> </tr> <tr> <td>10</td> <td>0000.1234.5678</td> <td>STATIC</td> <td>REMOTE</td> <td>OverlayTunnel 2</td> <td>-</td> </tr> <tr> <td>20</td> <td>0000.0000.0002</td> <td>STATIC</td> <td>LOCAL</td> <td>GigabitEthernet 0/2</td> <td>20</td> </tr> <tr> <td>20</td> <td>0000.0000.0003</td> <td>STATIC</td> <td>REMOTE</td> <td>OverlayTunnel 1</td> <td>-</td> </tr> <tr> <td>20</td> <td>0000.0000.0004</td> <td>STATIC</td> <td>REMOTE</td> <td>OverlayTunnel 1</td> <td>-</td> </tr> <tr> <td>20</td> <td>0000.1234.5678</td> <td>STATIC</td> <td>REMOTE</td> <td>OverlayTunnel 2</td> <td>-</td> </tr> </tbody> </table> <pre> TOR2(config)#show vxlan mac </pre> <table border="1"> <thead> <tr> <th>Vxlan</th> <th>MAC Address</th> <th>Type</th> <th>Location</th> <th>Interface</th> <th>Vlan</th> </tr> </thead> <tbody> <tr> <td>10</td> <td>0000.0000.0001</td> <td>STATIC</td> <td>REMOTE</td> <td>OverlayTunnel 1</td> <td>-</td> </tr> <tr> <td>10</td> <td>0000.1234.5678</td> <td>STATIC</td> <td>REMOTE</td> <td>OverlayTunnel 2</td> <td>-</td> </tr> <tr> <td>20</td> <td>0000.0000.0002</td> <td>STATIC</td> <td>REMOTE</td> <td>OverlayTunnel 1</td> <td>-</td> </tr> <tr> <td>20</td> <td>0000.0000.0003</td> <td>STATIC</td> <td>LOCAL</td> <td>GigabitEthernet 0/1</td> <td>20</td> </tr> <tr> <td>20</td> <td>0000.0000.0004</td> <td>STATIC</td> <td>LOCAL</td> <td>GigabitEthernet 0/2</td> <td>20</td> </tr> <tr> <td>20</td> <td>0000.1234.5678</td> <td>STATIC</td> <td>REMOTE</td> <td>OverlayTunnel 2</td> <td>-</td> </tr> </tbody> </table> <pre> CORE1#show vxlan mac </pre> <table border="1"> <thead> <tr> <th>Vxlan</th> <th>MAC Address</th> <th>Type</th> <th>Location</th> <th>Interface</th> <th>Vlan</th> </tr> </thead> <tbody> <tr> <td>10</td> <td>0000.0000.0001</td> <td>STATIC</td> <td>REMOTE</td> <td>OverlayTunnel 2</td> <td>-</td> </tr> </tbody> </table>	Vxlan	MAC Address	Type	Location	Interface	Vlan	10	0000.0000.0001	STATIC	LOCAL	GigabitEthernet 0/1	10	10	0000.1234.5678	STATIC	REMOTE	OverlayTunnel 2	-	20	0000.0000.0002	STATIC	LOCAL	GigabitEthernet 0/2	20	20	0000.0000.0003	STATIC	REMOTE	OverlayTunnel 1	-	20	0000.0000.0004	STATIC	REMOTE	OverlayTunnel 1	-	20	0000.1234.5678	STATIC	REMOTE	OverlayTunnel 2	-	Vxlan	MAC Address	Type	Location	Interface	Vlan	10	0000.0000.0001	STATIC	REMOTE	OverlayTunnel 1	-	10	0000.1234.5678	STATIC	REMOTE	OverlayTunnel 2	-	20	0000.0000.0002	STATIC	REMOTE	OverlayTunnel 1	-	20	0000.0000.0003	STATIC	LOCAL	GigabitEthernet 0/1	20	20	0000.0000.0004	STATIC	LOCAL	GigabitEthernet 0/2	20	20	0000.1234.5678	STATIC	REMOTE	OverlayTunnel 2	-	Vxlan	MAC Address	Type	Location	Interface	Vlan	10	0000.0000.0001	STATIC	REMOTE	OverlayTunnel 2	-
Vxlan	MAC Address	Type	Location	Interface	Vlan																																																																																												
10	0000.0000.0001	STATIC	LOCAL	GigabitEthernet 0/1	10																																																																																												
10	0000.1234.5678	STATIC	REMOTE	OverlayTunnel 2	-																																																																																												
20	0000.0000.0002	STATIC	LOCAL	GigabitEthernet 0/2	20																																																																																												
20	0000.0000.0003	STATIC	REMOTE	OverlayTunnel 1	-																																																																																												
20	0000.0000.0004	STATIC	REMOTE	OverlayTunnel 1	-																																																																																												
20	0000.1234.5678	STATIC	REMOTE	OverlayTunnel 2	-																																																																																												
Vxlan	MAC Address	Type	Location	Interface	Vlan																																																																																												
10	0000.0000.0001	STATIC	REMOTE	OverlayTunnel 1	-																																																																																												
10	0000.1234.5678	STATIC	REMOTE	OverlayTunnel 2	-																																																																																												
20	0000.0000.0002	STATIC	REMOTE	OverlayTunnel 1	-																																																																																												
20	0000.0000.0003	STATIC	LOCAL	GigabitEthernet 0/1	20																																																																																												
20	0000.0000.0004	STATIC	LOCAL	GigabitEthernet 0/2	20																																																																																												
20	0000.1234.5678	STATIC	REMOTE	OverlayTunnel 2	-																																																																																												
Vxlan	MAC Address	Type	Location	Interface	Vlan																																																																																												
10	0000.0000.0001	STATIC	REMOTE	OverlayTunnel 2	-																																																																																												

```

20 0000.0000.0002 STATIC REMOTE OverlayTunnel 2 -
20 0000.0000.0003 STATIC REMOTE OverlayTunnel 1 -
20 0000.0000.0004 STATIC REMOTE OverlayTunnel 1 -

CORE2#show vxlan mac
Vxlan      MAC Address      Type      Location Interface      Vlan
-----
10 0000.0000.0001  STATIC  REMOTE  OverlayTunnel 2      -
20 0000.0000.0002  STATIC  REMOTE  OverlayTunnel 2      -
20 0000.0000.0003  STATIC  REMOTE  OverlayTunnel 1      -
20 0000.0000.0004  STATIC  REMOTE  OverlayTunnel 1
    
```

2.4.2 Configuring VXLAN EVPN

Configuration Effect

- Enable the control plane learning function to implement VXLAN tunnel learning, MAC address learning, and route learning via control plane protocols, thereby finally implementing VXLAN bridging, VXLAN routing, and data communication between VXLANs and between a VXLAN and an external network.
- Support functions such as anycast gateways, symmetric VXLAN instances, and ARP suppression in EVPN control plane mode.

Notes

- The VXLAN instances require support from existing unicast routes on the network. Therefore, an IPv4 unicast routing protocol, for example, the OSPF protocol must be configured on the network devices.
- The MP-BGP-EVPN protocol is required for VXLANs to implement VXLAN tunnel learning, MAC address learning, and route learning. Therefore, the devices on the network must complete BGP-related configurations.

Configuration Steps

⚡ Configuring Loopback Interface Associated with Local End

- Mandatory.
- Configure the IP address of a loopback interface as the IP address of the local VTEP. One VTEP device can be associated with only one loopback interface to serve as the VXLAN VTEP IP address.
- If the L3 egress is an overlay router interface during static route configuration, the next-hop IP address cannot be set to the VTEP IP address.

⚡ Configuring Virtual MAC Address for Anycast Gateways

- Optional.
- Configure a unified virtual MAC address for all anycast gateways on the network. The anycast function can be enabled on the VXLAN overlay router interface of the local device only after the virtual MAC address is configured.

⚡ Configuring ARP Suppression

- Optional.

- After ARP suppression is enabled, the switch responds to the ARP request from the host as a proxy, reducing the flooded ARP data.
- ARP suppression is generally enabled on the TOR bridge devices in a centralized deployment scenario, or on the distributed gateways in a distributed deployment scenario.

▾ **Configuring ARP Proxy**

- Optional.
- After ARP suppression is enabled on a VTEP device, you can enable the ARP proxy function on an overlay router interface.
- After ARP proxy is enabled, the VTEP device responds to ARP requests from hosts as a proxy and the MAC address used for proxy response is the gateway MAC address configured on the VTEP device. In this way, the MAC address in the ARP request responses are the MAC address of the VTEP device, and the traffic between hosts in the same VNI is forwarded at L3.

ARP proxy can be enabled only on VXLAN gateways and is generally enabled on distributed gateways in distributed deployment scenarios.

▾ **Configuring IPv6 ND Suppression**

- Optional.
- After IPv6 ND suppression is enabled, the VTEP device responds to NS multicast packets from hosts as a proxy, to reduce flooded NS multicast packets on the network.
- IPv6 ND suppression is generally enabled on distributed gateways in distributed deployment scenarios.

▾ **Configuring the EVPN Protocol Packet Control Function**

- In symmetric EVPN deployment scenarios, the EVPN protocol packet control function can be configured on TOR switches to reduce the traffic of EVPN packets.

Currently, the EVPN protocol packet control function includes the following:

- Extracting MAC entries from EVPN MAC-IP type-2 routes (ARP entries) on a L2-VPN VXLAN instance
- Extracting MAC entries from EVPN MAC-IPv6 type-2 routes (IPv6 ND entries) on a L2-VNI VXLAN instance
- Banning synchronization of the local MAC address to the remote VTEP through EVPN messages on an L2-VNI VXLAN instance
- Banning delivery of the MAC addresses remotely synchronized through EVPN messages to the local MAC address table on an L2-VNI VXLAN instance
- Stopping an L2-VNI VXLAN instance from generating EVPN type-2 routes

▾ **Configuring Remote ARP Packet Learning**

- Mandatory for centralized gateways and not recommended for other devices.
- After the remote ARP packet learning function is enabled, the VXLAN gateways can learn the VXLAN route entries from the encapsulated VXLAN ARP packets received from the VXLAN tunnels.

▾ **Configuring Remote IPv6 ND Protocol Packet Learning**

- Mandatory for centralized gateways and not recommended for other devices.
- After the remote IPv6 ND protocol packet learning function is enabled, the VXLAN gateway can learn IPv6 ND entries from VXLAN-encapsulated IPv6 protocol packets received from VXLAN tunnels.

↘ **Creating VXLAN Instances**

- Mandatory.

↘ **Associating VXLAN Instance with Overlay Router Interface**

- Mandatory for VXLAN gateways.
- Only after the VXLAN is associated with the overlay router interface, the device can provide the VXLAN routing function and serve as a VXLAN IP gateway.

↘ **Associating VXLAN Instance with VLAN**

- Mandatory for VXLAN devices directly connected to the host.
- Only after a VLAN is associated with a VXLAN instance, packets of the VLAN can be encapsulated into VXLAN packets and then forwarded.
- After a VLAN is associated with a VXLAN, all packets of the VLAN will be encapsulated into VXLAN packets. Therefore, an SVI cannot be used as the VLAN IP gateway on the device.

↘ **Configuring Storm Control of VXLAN Instances**

- Optional.
- This function is required only when the storm rate needs to be limited based on VXLAN instances.

↘ **Configuring VXLAN UDP Destination Port**

- Optional. As the VXLAN UDP destination port used by early devices may not be Port 4789, you can run this command to achieve compatibility. In addition, you can also run this command to customize the VXLAN UDP destination port.
- The VXLAN UDP destination port 4789 designated by IANA is used by default.

↘ **Configuring Symmetric Instances**

- Optional.
- Symmetric instances need to be configured only in symmetric scenarios. Only one symmetric instance can be configured for each VRF network. After a symmetric instance is configured in a VRF network, L3 forwarding of other asymmetric instances is all switched to the symmetric instance for implementation.

↘ **Configuring Static VXLAN Network Routes**

- Optional.
- Configure the static VXLAN network routes based on VXLAN instances if required.

Verification

Based on EVPN control plane learning, VXLAN tunnels, VXLAN MAC entries, and VXLAN route entries can be formed. Run the following commands for verification.

- Run the **show vxlan vni-number** command to check whether the local and remote VXLAN devices can learn mutual VTEP neighbor relationships.
- Run the **show vxlan mac** command to check whether the VXLAN MAC address is learned.
- Run the **show arp** command to check whether the ARP entry of the VXLAN IP gateway is learned.

- Run the **show ipv6 neighbors** command to check whether all local/remote IPv6 ND entries are learned.
- Run the **show vxlan udp-port** command to display the VXLAN UDP destination port.

Related Commands

↘ **Configuring Loopback Interface Associated with Local End**

Command	source loopback <i>loopback-port-id</i>
Parameter	<i>loopback-port-id</i> : Indicates the ID of the loopback interface.
Description	
Command	VTEP configuration mode
Mode	
Usage Guide	The local VETP IP address is the configured loopback interface IP address.

↘ **Configuring Virtual MAC Address for Anycast Gateways**

Command	fabric anycast-gateway-mac <i>mac-addr</i>
Parameter	<i>mac-addr</i> : Indicates the MAC address. The format is xxxx.xxxx.xxxx.
Description	
Command	Global configuration mode
Mode	
Usage Guide	All gateways on which the anycast function is enabled use this MAC address as the gateway MAC address. The virtual MAC address for an anycast gateway must not be the same as the local MAC address or the same as the MAC address of any device on the overlay network.

↘ **Configuring Remote ARP Packet Learning**

Command	remote arp learn enable
Parameter	N/A
Description	
Command	VTEP configuration mode
Mode	
Usage Guide	Enable or disable the remote ARP packet learning function globally. After this function is enabled, the VXLAN gateways can learn the VXLAN route entries from the encapsulated VXLAN ARP packets received from the VXLAN tunnels.

↘ **Configuring Remote IPv6 ND Protocol Packet Learning**

Command	remote nd learn enable
Parameter	N/A
Description	
Command	VTEP configuration mode
Mode	
Usage Guide	Enable or disable the remote IPv6 ND packet learning function globally. After this function is enabled, the device can learn IPv6 ND entries from the VXLAN-encapsulated IPv6 NS packets received from VXLAN tunnels.

↘ **Configuring ARP Suppression**

Command	arp suppress enable
Parameter	N/A

Description	
Command	VTEP configuration mode
Mode	
Usage Guide	Enable or disable ARP suppression globally. After ARP suppression is enabled, the switch responds to the ARP requests from the host as a proxy. The VNI-based ARP suppression may be also supported, depending on the product type. You can configure global ARP suppression or VNI-based ARP suppression based on the actual application scenario.

↘ **Configuring VNI-based ARP Suppression**

Command	arp suppress enable
Parameter	N/A
Description	
Command	VXLAN configuration mode
Mode	
Usage Guide	Enable or disable VNI-based ARP suppression. After ARP suppression is enabled, the switch responds to ARP requests from hosts as a proxy. The global ARP suppression may be also supported, depending on the product type. You can configure global ARP suppression or VNI-based ARP suppression based on the actual application scenario.

↘ **Configuring ARP Proxy**

Command	route-in-vni
Parameter	N/A
Description	
Command	Overlay router interface configuration mode
Mode	
Usage Guide	After the intra-VNI routing function (ARP proxy) is enabled on an overlay router interface, the VTEP device uses its gateway MAC address to respond to all ARP requests from hosts in the VNI, to which the overlay router interface belongs, when serving as an ARP proxy. In this way, the communication traffic between hosts in the same VNI is forwarded through VXLAN routes.

↘ **Configuring Global IPv6 ND Suppression**

Command	nd suppress enable
Parameter	N/A
Description	
Command	VTEP configuration mode
Mode	
Usage Guide	Enable or disable the global IPv6 ND suppression function. After IPv6 ND suppression is enabled, the device responds to IPv6 NS multicast packets from hosts as a proxy. The VNI-based IPv6 ND suppression may be also supported, depending on the product type. You can configure global IPv6 ND suppression or VNI-based IPv6 ND suppression based on the actual application scenario.

↘ **Configuring VNI-based IPv6 ND Suppression**

Command	nd suppress enable
Parameter	N/A
Description	

Command Mode	VXLAN configuration mode
Usage Guide	Enable or disable the VNI-based IPv6 ND suppression function. After IPv6 ND suppression is enabled, the device responds to IPv6 NS multicast packets from hosts as a proxy. The global IPv6 ND suppression may be also supported, depending on the product type. You can configure global IPv6 ND suppression or VNI-based IPv6 ND suppression based on the actual application scenario.

↘ **Extracting MAC Entries from EVPN MAC-IP Type-2 Routes (ARP Entries)**

Command	evpn arp mac-learning enable
Parameter Description	N/A
Command Mode	VXLAN configuration mode
Usage Guide	<p>After this command is configured, the device parses one ARP entry and one MAC entry from a MAC-IP type-2 route synchronized from the VXLAN-EVPN neighbor.</p> <p>This command is disabled by default and the device parses one ARP entry but no MAC entry from a MAC-IP type-2 route synchronized from the VXLAN-EVPN neighbor.</p> <p>This command is configured on a VXLAN instance and affects only the EVPN entry parsing of the VXLAN instance. Other VXLAN instances, for which this command is not configured, are not affected.</p> <p>This command can be used in combination with the evpn mac advertise disable command. After they are executed, the network-wide VXLAN-EVPN neighbors synchronize only MAC-IP type-2 routes but no MAC-only type-2 routes. All devices parse and extract MAC entries from MAC-IP type-2 routes.</p> <p>This command is configured on L2-VNI VXLAN instances.</p>

↘ **Extracting MAC Entries from EVPN MAC-IPv6 Type-2 Routes (IPv6 ND Entries)**

Command	evpn nd mac-learning enable
Parameter Description	N/A
Command Mode	VXLAN configuration mode
Usage Guide	<p>After this command is configured, the device parses one IPv6 ND entry and one MAC entry from a MAC-IPv6 type-2 route (IPv6 ND entry) synchronized from the VXLAN-EVPN neighbor.</p> <p>This command is disabled by default and the device parses one IPv6 ND entry but no MAC entry from a MAC-IPv6 type-2 route synchronized from the VXLAN-EVPN neighbor.</p> <p>This command is configured on a VXLAN instance and affects only the EVPN entry parsing of the VXLAN instance. Other VXLAN instances, for which this command is not configured, are not affected.</p> <p>This command can be used in combination with the evpn mac advertise disable command. After they are executed, the network-wide VXLAN-EVPN neighbors synchronize only MAC-IPv6 type-2 routes but no MAC-only type-2 routes. All devices parse and extract MAC entries from MAC-IPv6 type-2 routes.</p> <p>This command is configured on L2-VNI VXLAN instances.</p>

↘ **Configuring an L2-VNI VXLAN Instance Not to Synchronize the Local MAC Address to the Remote VTEP Through EVPN Messages**

Command	evpn mac advertise disable
Parameter Description	N/A
Command Mode	VXLAN configuration mode
Usage Guide	<p>This command is not configured on a device by default. The device generates one MAC-only type-2 route through the VXLAN-EVPN protocol based on a locally learned MAC entry, and synchronizes the type-2 route to the EVPN neighbor (that is, remote VTEP). Then, the remote VTEP can learn the MAC entry from the MAC-only type-2 route.</p> <p>After this command is configured, the device does not generate VXLAN-EVPN MAC-only type-2 routes based on MAC entries, and therefore, it will not advertise MAC-only type-2 routes to the EVPN neighbor.</p> <p>This command is configured on a VXLAN instance and affects only whether the VXLAN instance generates MAC-only type-2 routes. Other VXLAN instances, for which this command is not configured, can still generate MAC-only type-2 routes.</p> <p>This command can be used in combination with the evpn arp mac-learning enable and evpn nd mac-learning enable commands. After they are executed, the network-wide VXLAN-EVPN neighbors synchronize only MAC-IP type-2 routes but no MAC-only type-2 routes. All devices parse and extract MAC entries from MAC-IP or MAC-IPv6 type-2 routes.</p> <p>Note: This command can be configured only on L2-VNI VXLAN instances (that is, VXLAN instances with the symmetric command not configured). It is unavailable on L3-VNI VXLAN instances.</p>

▾ Configuring an L2-VNI VXLAN Instance Not to Deliver MAC Addresses Remotely Synchronized Through EVPN Messages to the Local MAC Address Table

Command	evpn mac inactive
Parameter Description	N/A
Command Mode	VXLAN configuration mode
Usage Guide	<p>After this command is configured, the device does not learn MAC entries from VXLAN-EVPN type-2 routes (MAC-IP or MAC-only type-2 routes) synchronized from neighbors.</p> <p>This command is not configured on a device by default. The device learns MAC entries from VXLAN-EVPN type-2 routes synchronized from neighbors.</p> <p>This command is configured on a VXLAN instance and affects only whether the VXLAN instance learns MAC entries from VXLAN-EVPN type-2 routes. Other VXLAN instances, for which this command is not configured, can still learn MAC entries.</p> <p>Note: This command can be configured only on L2-VNI VXLAN instances (that is, VXLAN instances with the symmetric command not configured). It is unavailable on L3-VNI VXLAN instances.</p>

▾ Configuring an L2-VNI VXLAN Instance Not to Generate EVPN Type-2 Routes

Command	evpn rt-2 advertise disable
Parameter Description	N/A
Command Mode	VXLAN configuration mode
Usage Guide	<p>This command is not configured on a device by default. The device generates one MAC-only type-2 route through the VXLAN-EVPN protocol based on a locally learned MAC entry, and synchronizes the type-2 route to the EVPN neighbor</p>

	<p>(that is, remote VTEP). Then, the remote VTEP learns the MAC entry from the MAC-only type-2 route. In addition, the device generates one MAC-IP type-2 route through the VXLAN-EVPN protocol based on a locally learned ARP entry and synchronizes the type-2 route to the EVPN neighbor. Then, the remote VTEP learns the ARP entry and host route from the MAC-IP type-2 route. The device generates one MAC-IPv6 type-2 route through the VXLAN-EVPN protocol based on a locally learned IPv6 ND entry, and synchronizes the type-2 route to the EVPN neighbor. Then, the remote VTEP learns the IPv6 ND entry and host route from the MAC-IPv6 type-2 route. After this command is configured, the MAC entries, ARP entries, and IPv6 ND entries of the device are not used to generate VXLAN-EVPN type-2 routes and therefore, no type-2 route is advertised to the EVPN neighbor.</p> <p>This command is configured on a VXLAN instance and affects only whether the VXLAN instance generates type-2 routes. Other VXLAN instances, for which this command is not configured, can still generate type-2 routes.</p> <p>Note: This command can be configured only on L2-VNI VXLAN instances (that is, VXLAN instances with the symmetric command not configured). It is unavailable on L3-VNI VXLAN instances.</p>
--	---

➤ **Creating Overlay Router Interfaces**

Command	interface OverlayRouter <i>port-id</i>
Parameter Description	<i>port-id</i> : Indicates the ID of an overlay router interface. The ID ranges from 1 to 16,777,215.
Command Mode	Global configuration mode
Usage Guide	Similar to SVI in a VLAN, this interface serves as the VXLAN IP gateway in the VXLAN routing environment.

➤ **Configuring IP Address for Overlay Router Interface**

Command	ip address <i>ip-address mask</i>
Parameter Description	<i>ip-address</i> : Indicates the IP address of the overlay router interface. <i>mask</i> : Indicates the subnet mask.
Command Mode	Interface configuration mode
Usage Guide	Similar to the IP address of the SVI in a VLAN, this IP address serves as the address of the VXLAN IP gateway in the VXLAN routing environment.

➤ **Configuring an IPv6 Address for the Overlay Router Interface**

Command	ipv6 address <i>ip-address mask</i>
Parameter Description	<i>ip-address</i> : Indicates the IPv6 address of the overlay router interface. <i>mask</i> : Indicates the subnet mask.
Command Mode	Overlay router interface configuration mode
Usage Guide	This IPv6 address serves as the VXLAN IPv6 gateway address in the VXLAN routing environment. It is similar to the IP address of an SVI in a VLAN.

➤ **Associating Overlay Router Interface with VRF Network**

Command	vrf forwarding <i>table name</i>
Parameter Description	<i>Table name</i> : Indicates the VRF network associated with the overlay router interface.
Command	Interface configuration mode

Mode	
Usage Guide	Use this command to associate an overlay router interface with a VRF network in the VXLAN routing environment, to implement VXLAN L3 route isolation.

↘ Creating or Entering VXLAN Instances

Command	vxlan <i>vni-number</i>
Parameter	<i>vni-number</i> : Indicates the VNI. The value ranges from 1 to 16777215.
Description	
Command	Global configuration mode
Mode	
Usage Guide	N/A

↘ Configuring Symmetric Instances

Command	symmetric
Parameter	N/A
Description	
Command	VXLAN configuration mode
Mode	
Usage Guide	No symmetric instance is configured by default. Symmetric instances are used to manage the L3 forwarding entries of all asymmetric instances of the VRF networks associated with the symmetric instances.

↘ Associating VXLAN Instance with Overlay Router Interface

Command	router-interface <i>interface-name</i>
Parameter	<i>interface-name</i> : Indicates the name of the overlay router interface.
Description	
Command	VXLAN configuration mode
Mode	
Usage Guide	Different VXLANs cannot be associated with the same overlay router interface.

↘ Configuring VXLAN UDP Destination Port

Command	vxlan udp-port <i>port-number</i>
Parameter	<i>port-number</i> : Indicates the UDP destination port ID. The value ranges from 0 to 65535 and the default value is 4789.
Description	
Command	Global configuration mode
Mode	
Usage Guide	Note that the UDP destination port cannot be same as commonly used UDP ports.

↘ Configuring Storm Control of VXLAN Instances

Command	storm-control { broadcast multicast unicast } [<i>kpps-value</i> pps <i>pps-value</i>]
Parameter	<i>kpps-value</i> : Indicates the rate limit value (unit: kbit/s).
Description	<i>pps-value</i> : Indicates the rate limit value (unit: packet count/s).
Command	VXLAN configuration mode
Mode	
Usage Guide	Configure the storm control when the storm rate needs to be limited based on the VNI.

Configuration Example

- i Only configuration related to the VXLAN is described below.
- i Only IPv4 configuration is used as an example below and the IPv6 scenario configuration is largely the same as the IPv4 scenario configuration.

2.4.2.1 Configuring EVPN-based Multi-tenant Centralized Scenario

<p>Scenario Figure 2-23</p>	
<p>Configuration Steps</p>	<ul style="list-style-type: none"> ● Configure an IPv4 unicast routing protocol such as the OSPF protocol on CORE, TOR-1, and TOR-2 to ensure that unicast routes are reachable. ● Configure the BGP-EVPN routing protocol on CORE, TOR-1, and TOR-2 to establish BGP neighbor relationships between the three devices and to support the EVPN protocol family. ● Configure the EVI for BGP-EVPN on CORE, TOR-1, and TOR-2. For details, see <i>BGP-EVPN Configuration Guide</i>. ● Configure a VXLAN on the virtual server and designate the gateway address of the virtual machine. ● Associate the VTEP with the loopback interface on TOR-1, TOR-2, and CORE to establish tunnels. ● Create VXLAN instances on TOR-1, TOR-2, and CORE and associate the VXLAN instances with VLANs. ● Create overlay router interfaces and configure the VXLAN gateway IP address on CORE. Configure different VRF networks for different overlay router interfaces to determine their respective tenants. ● Associate VXLAN instances with overlay router interfaces on CORE to realize VXLAN routing. ● Enable the remote ARP packet learning function on CORE to generate VXLAN routing entries dynamically. ● (Optional) Configure ARP suppression on TOR-1 and TOR-2 to reduce the ARP packets entering the VXLAN.
<p>HOST</p>	<p>Configuring the IP address and gateway according to Figure 2-23 (the detailed configuration on the server is omitted herein).</p>
<p>CORE</p>	<p>The configuration of the OSPF, and Ethernet interface is omitted herein. The following describe only the VXLAN</p>

```
configuration.
CORE# configure terminal
Enter configuration commands, one per line. End with CNTL/Z.
CORE(config)# interface Loopback 1
CORE(config-if- Loopback 1)# ip address 1.1.1.1/32
CORE(config-if- Loopback 1)# exit
CORE(config)# vtep
CORE(config-vtep)# source loopback 1
CORE(config-vtep)# remote arp learn enable
CORE(config-vtep)# exit
CORE(config)# ip vrf vrf-10
CORE(config-vrf)# rd 10:10
CORE(config-vrf)# route-target both 1000:1000
CORE(config-vrf)# exit
CORE(config)# ip vrf vrf-20
CORE(config-vrf)# rd 20:20
CORE(config-vrf)# route-target both 2000:2000
CORE(config-vrf)# exit
CORE(config)# int overlayrouter 10
CORE(config-if-OverlayRouter 10)# ip vrf forwarding vrf-10
CORE(config-if-OverlayRouter 10)# ip address 10.1.1.1/24
CORE(config-if-OverlayRouter 10)# exit
CORE(config)# int overlayrouter 20
CORE(config-if-OverlayRouter 20)# ip vrf forwarding vrf-10
CORE(config-if-OverlayRouter 20)# ip address 10.1.2.1/24
CORE(config-if-OverlayRouter 20)# exit
CORE(config)# int overlayrouter 100
CORE(config-if-OverlayRouter 100)# ip vrf forwarding vrf-20
CORE(config-if-OverlayRouter 100)# ip address 10.1.3.1/24
CORE(config-if-OverlayRouter 100)# exit
CORE(config)# vxlan 10
CORE(config-vxlan)# router-interface OverlayRouter 10
CORE(config-vxlan)# exit
CORE(config)# vxlan 20
CORE(config-vxlan)# router-interface OverlayRouter 20
CORE(config-vxlan)# exit
CORE(config)# vxlan 100
CORE(config)# vxlan 100
CORE(config-vxlan)# router-interface OverlayRouter 100
CORE(config-vxlan)# exit
CORE(config)# router bgp 64512
CORE(config-router)# neighbor 2.2.2.2 remote-as 64512
CORE(config-router)# neighbor 3.3.3.3 remote-as 64512
CORE(config-router)# neighbor 2.2.2.2 update-source Loopback 1
```

	<pre> CORE(config-router)# neighbor 3.3.3.3 update-source Loopback 1 CORE(config-router)# address-family l2vpn evpn CORE(config-router-af)# neighbor 2.2.2.2 activate CORE(config-router-af)# neighbor 3.3.3.3 activate CORE(config-router-af)# neighbor 2.2.2.2 route-reflector-client CORE(config-router-af)# neighbor 3.3.3.3 route-reflector-client CORE(config-router-af)# exit CORE(config-router)# address-family ipv4 vrf vrf-10 CORE(config-router-af)# network 10.1.1.0 mask 255.255.255.0 CORE(config-router-af)# network 10.1.2.0 mask 255.255.255.0 CORE(config-router-af)# exit CORE(config-router)# address-family ipv4 vrf vrf-20 CORE(config-router-af)# network 10.1.3.0 mask 255.255.255.0 CORE(config-router-af)# exit CORE(config-router)# exit CORE(config)# evpn CORE(config-evpn)# vni 10 CORE(config-evpn-vni)# rd auto CORE(config-evpn-vni)# route-target both auto CORE(config-evpn-vni)# exit CORE(config-evpn)# vni 20 CORE(config-evpn-vni)# rd auto CORE(config-evpn-vni)# route-target both auto CORE(config-evpn-vni)# exit CORE(config-evpn)# vni 100 CORE(config-evpn-vni)# rd auto CORE(config-evpn-vni)# route-target both auto CORE(config-evpn-vni)# exit </pre>
TOR1	<pre> TOR1# configure terminal Enter configuration commands, one per line. End with CNTL/Z. TOR1(config)# interface Loopback 1 TOR1(config-if- Loopback 1)# ip address 2.2.2.2/32 TOR1(config-if- Loopback 1)# exit TOR1(config)# vtep TOR1(config-vtep)# source loopback 1 TOR1(config-vtep)# arp suppress enable TOR1(config-vtep)# exit TOR1(config)# vxlan 10 TOR1(config-vxlan)# extend-vlan 10 TOR1(config-vxlan)# arp suppress enable TOR1(config-vxlan)# exit TOR1(config)# vxlan 20 TOR1(config-vxlan)# extend-vlan 20 TOR1(config-vxlan)# arp suppress enable </pre>

	<pre> TOR1(config-vxlan)# exit TOR1(config)# router bgp 64512 TOR1(config-router)# neighbor 1.1.1.1 remote-as 64512 TOR1(config-router)# neighbor 1.1.1.1 update-source loopback 1 TOR1(config-router)# address-family l2vpn evpn TOR1(config-router-af)# neighbor 1.1.1.1 activate TOR1(config-router-af) #exit TOR1(config-router)# exit TOR1(config)# evpn TOR1(config-evpn)# vni 10 TOR1(config-evpn-vni)# rd auto TOR1(config-evpn-vni)# route-target both auto TOR1(config-evpn-vni)# exit TOR1(config-evpn)# vni 20 TOR1(config-evpn-vni)# rd auto TOR1(config-evpn-vni)# route-target both auto TOR1(config-evpn-vni)# exit </pre>
TOR2	<pre> TOR2# configure terminal Enter configuration commands, one per line. End with CNTL/Z. TOR2(config)# interface Loopback 1 TOR2(config-if- Loopback 1)# ip address 3.3.3.3/32 TOR2(config-if- Loopback 1)# exit TOR2(config)# vtep TOR2(config-vtep)# source loopback 1 TOR2(config-vtep)# arp suppress enable TOR2(config-vtep)# exit TOR2(config)# vxlan 100 TOR2(config-vxlan)# extend-vlan 100 TOR2(config-vxlan)# arp suppress enable TOR2(config-vxlan)# exit TOR2(config)# vxlan 20 TOR2(config-vxlan)# extend-vlan 20 TOR2(config-vxlan)# arp suppress enable TOR2(config-vxlan)# exit TOR2(config)# router bgp 64512 TOR2(config-router)# neighbor 1.1.1.1 remote-as 64512 TOR2(config-router)# neighbor 1.1.1.1 update-source loopback 1 TOR2(config-router)# address-family l2vpn evpn TOR2(config-router)# neighbor 1.1.1.1 activate TOR2(config-router-af)# exit TOR2(config-router)# exit TOR2(config)# evpn TOR2(config-evpn)# vni 20 </pre>

	<pre>TOR2(config-evpn-vni)# rd auto TOR2(config-evpn-vni)# route-target both auto TOR2(config-evpn-vni)# exit TOR2(config-evpn)# vni 100 TOR2(config-evpn-vni)# rd auto TOR2(config-evpn-vni)# route-target both auto TOR2(config-evpn-vni)# exit</pre>
<p>Verification</p>	<ul style="list-style-type: none"> ● Verify that HOST-1, HOST-2, HOST-3, and HOST-4 can ping each other. ● Verify that HOST-5 and HOST-6 can ping each other. ● Verify that HOST-1, HOST-2, HOST-3, and HOST-4 cannot ping HOST-5 and HOST-6. ● Verify that the virtual machines can be migrated between the hosts on the same VXLAN and can access the network normally after migration without modifying the configuration.
	<pre>TOR1#sho vxlan VXLAN Total Count: 2 VXLAN Capacity : 8000 VXLAN 10 Symmetric property : FALSE Router Interface : - Extend VLAN : 10 VTEP Adjacency Count: 1 VTEP Adjacency List : Interface Source IP Destination IP Type ----- OverlayTunnel 6145 2.2.2.2 1.1.1.1 dynamic VXLAN 20 Symmetric property : FALSE Router Interface : - Extend VLAN : 20 VTEP Adjacency Count: 2 VTEP Adjacency List : Interface Source IP Destination IP Type ----- OverlayTunnel 6145 2.2.2.2 1.1.1.1 dynamic OverlayTunnel 6146 2.2.2.2 3.3.3.3 dynamic CORE#sho vxlan VXLAN Total Count: 3 VXLAN Capacity : 8000 VXLAN 10 Symmetric property : FALSE Router Interface : OverlayRouter 10 (non-anycast)</pre>

	<p>Extend VLAN : -</p> <p>VTEP Adjacency Count: 1</p> <p>VTEP Adjacency List :</p> <table border="1"> <thead> <tr> <th>Interface</th> <th>Source IP</th> <th>Destination IP</th> <th>Type</th> </tr> </thead> <tbody> <tr> <td>OverlayTunnel 6147</td> <td>1.1.1.1</td> <td>2.2.2.2</td> <td>dynamic</td> </tr> </tbody> </table>	Interface	Source IP	Destination IP	Type	OverlayTunnel 6147	1.1.1.1	2.2.2.2	dynamic				
Interface	Source IP	Destination IP	Type										
OverlayTunnel 6147	1.1.1.1	2.2.2.2	dynamic										
	<p>VXLAN 20</p> <p>Symmetric property : FALSE</p> <p>Router Interface : OverlayRouter 20 (non-anycast)</p> <p>Extend VLAN : -</p> <p>VTEP Adjacency Count: 2</p> <p>VTEP Adjacency List :</p> <table border="1"> <thead> <tr> <th>Interface</th> <th>Source IP</th> <th>Destination IP</th> <th>Type</th> </tr> </thead> <tbody> <tr> <td>OverlayTunnel 6147</td> <td>1.1.1.1</td> <td>2.2.2.2</td> <td>dynamic</td> </tr> <tr> <td>OverlayTunnel 6148</td> <td>1.1.1.1</td> <td>3.3.3.3</td> <td>dynamic</td> </tr> </tbody> </table>	Interface	Source IP	Destination IP	Type	OverlayTunnel 6147	1.1.1.1	2.2.2.2	dynamic	OverlayTunnel 6148	1.1.1.1	3.3.3.3	dynamic
Interface	Source IP	Destination IP	Type										
OverlayTunnel 6147	1.1.1.1	2.2.2.2	dynamic										
OverlayTunnel 6148	1.1.1.1	3.3.3.3	dynamic										
	<p>VXLAN 100</p> <p>Symmetric property : FALSE</p> <p>Router Interface : OverlayRouter 100 (non-anycast)</p> <p>Extend VLAN : -</p> <p>VTEP Adjacency Count: 1</p> <p>VTEP Adjacency List :</p> <table border="1"> <thead> <tr> <th>Interface</th> <th>Source IP</th> <th>Destination IP</th> <th>Type</th> </tr> </thead> <tbody> <tr> <td>OverlayTunnel 6148</td> <td>1.1.1.1</td> <td>3.3.3.3</td> <td>dynamic</td> </tr> </tbody> </table>	Interface	Source IP	Destination IP	Type	OverlayTunnel 6148	1.1.1.1	3.3.3.3	dynamic				
Interface	Source IP	Destination IP	Type										
OverlayTunnel 6148	1.1.1.1	3.3.3.3	dynamic										

2.4.2.2 Configuring EVPN-based Multi-tenant Centralized All-active Anycast Gateway Scenario

<p>Scenario Figure 2- 24</p>	
<p>Configuration Steps</p>	<ul style="list-style-type: none"> ● Configure an IPv4 unicast routing protocol such as the OSPF protocol on CORE, TOR-1, and TOR-2 to ensure that unicast routes are reachable. ● Configure the BGP-EVPN routing protocol on CORE, TOR-1, and TOR-2 to establish BGP neighbor relationships between the three devices and to support the EVPN protocol family. ● Configure the EVI for BGP-EVPN on CORE, TOR-1, and TOR-2. For details, see <i>BGP-EVPN Configuration Guide</i>. ● Configure a VXLAN on the virtual server and designate the gateway address of the virtual machine.(Omitted). ● Associate the VTEP with the loopback interface on TOR-1, TOR-2, and CORE to establish tunnels. <p>Note that the same loopback interface IP address needs to be configured on CORE1 and CORE2 as the VTEP IP address for tunnel establishment.</p> <p>After the loopback interface IP address is configured, no tunnel is established between CORE1 and CORE2.</p> <p>On TOR1, only one tunnel whose VTEP IP address is 1.1.1.1 and one tunnel whose VTEP IP address is 3.3.3.3 can be viewed.</p> <p>On TOR2, only one tunnel whose VTEP IP address is 1.1.1.1 and one tunnel whose VTEP IP address is 2.2.2.2 can be viewed.</p> <p>On CORE1, only one tunnel whose VTEP IP address is 2.2.2.2 and one tunnel whose VTEP IP address is 3.3.3.3 can be viewed.</p> <p>On CORE2, only one tunnel whose VTEP IP address is 2.2.2.2 and one tunnel whose VTEP IP address is 3.3.3.3 can be viewed.</p>

	<ul style="list-style-type: none"> ● Create VXLAN instances on TOR-1, TOR-2, and CORE and associate the VXLAN instances with VLANs. ● Create overlay router interfaces and configure the VXLAN gateway IP address on CORE. Configure different VRF networks for different overlay router interfaces to determine their respective tenants. Associate VXLAN instances with overlay router interfaces to realize VXLAN routing. <p>Note that the overlay router interface configurations on CORE1 and CORE2 must be the same. That is, the IP addresses and masks configured for the overlay router interfaces associated with the same VXLAN instance must be the same on CORE1 and CORE2 and belong to the same tenant (VRF).</p> <p>In addition, an anycast gateway must be configured for all overlay router interfaces.</p> <ul style="list-style-type: none"> ● Configure the same anycast gateway MAC address on CORE1 and CORE2 to ensure that all VXLAN anycast gateways on CORE use the same MAC address. ● Enable the remote ARP packet learning function on CORE to generate VXLAN routing entries dynamically. ● (Optional) Configure ARP suppression on TOR-1 and TOR-2 to reduce the ARP packets entering the VXLAN.
HOST	<p>Configure the IP address and gateway according to Figure 2-24 (the detailed configuration on the server is omitted herein).</p>
CORE	<p>The configuration of the OSPF and Ethernet interface is omitted herein. The following describes only the VXLAN configuration.</p> <p>Note: VXLAN configuration on CORE1 and CORE2 is the same. The following configuration applies to CORE1 and CORE2: Configure loopback 1 on both CORE1 and CORE2 and set the IP address to 1.1.1.2 and 1.1.1.3 for loopback 1. The two core switches establish a BGP neighbor relationship through loopback 1. Configure the L2VPN EVPN address family activation command.</p> <pre> CORE# configure terminal Enter configuration commands, one per line. End with CNTL/Z. CORE(config)# interface Loopback 0 CORE(config-if- Loopback 0)# ip address 1.1.1.1/32 CORE(config-if- Loopback 0)# exit CORE(config)#int loopback 1 CORE(config-if-Loopback 1)# ip address 1.1.1.2/32 CORE(config-if- Loopback 1)# exit CORE(config)# vtep CORE(config-vtep)# source loopback 0 CORE(config-vtep)# remote arp learn enable CORE(config-vtep)# exit CORE(config)# fabric anycast-gateway-mac 0011.2233.2016 CORE(config)# ip vrf vrf-10 CORE(config-vrf)# rd 10:10 CORE(config-vrf)# route-target both 1000:1000 CORE(config-vrf)# exit CORE(config)# ip vrf vrf-20 CORE(config-vrf)# rd 20:20 CORE(config-vrf)# route-target both 2000:2000 CORE(config-vrf)# exit CORE(config)# int overlayrouter 10 CORE(config-if-OverlayRouter 10)# ip vrf forwarding vrf-10 CORE(config-if-OverlayRouter 10)# ip address 10.1.1.1/24 </pre>

```
CORE(config-if-OverlayRouter 10)# anycast-gateway
CORE(config-if-OverlayRouter 10)# exit
CORE(config)# int overlayrouter 20
CORE(config-if-OverlayRouter 20)# ip vrf forwarding vrf-10
CORE(config-if-OverlayRouter 20)# ip address 10.1.2.1/24
CORE(config-if-OverlayRouter 20)# anycast-gateway
CORE(config-if-OverlayRouter 20)# exit
CORE(config)# vxlan 20
CORE(config)# int overlayrouter 100
CORE(config-if-OverlayRouter 100)# ip vrf forwarding vrf-20
CORE(config-if-OverlayRouter 100)# ip address 10.1.3.1/24
CORE(config-if-OverlayRouter 100)# anycast-gateway
CORE(config-if-OverlayRouter 100)# exit
CORE(config)# vxlan 10
CORE(config-vxlan)# router-interface OverlayRouter 10
CORE(config-vxlan)# exit
CORE(config)# vxlan 20
CORE(config-vxlan)# router-interface OverlayRouter 20
CORE(config-vxlan)# exit
CORE(config)# vxlan 100
CORE(config-vxlan)# router-interface OverlayRouter 100
CORE(config-vxlan)# exit
CORE(config)# router bgp 64512
CORE(config-router)# neighbor 1.1.1.3 remote-as 64512
CORE(config-router)# neighbor 1.1.1.3 update-source loopback 1
CORE(config-router)# neighbor 2.2.2.2 remote-as 64512
CORE(config-router)# neighbor 2.2.2.2 update-source loopback 1
CORE(config-router)# neighbor 3.3.3.3 remote-as 64512
CORE(config-router)# neighbor 3.3.3.3 update-source loopback 1
CORE(config-router)# address-family l2vpn evpn
CORE(config-router)# neighbor 1.1.1.3 activate
CORE(config-router)# neighbor 2.2.2.2 activate
CORE(config-router)# neighbor 3.3.3.3 activate
CORE(config-router-af)# exit
CORE(config-router)# address-family ipv4 vrf vrf-10
CORE(config-router-af)# network 10.1.1.0 mask 255.255.255.0
CORE(config-router-af)# network 10.1.2.0 mask 255.255.255.0
CORE(config-router-af)# exit
CORE(config-router)# address-family ipv4 vrf vrf-20
CORE(config-router-af)# network 10.1.3.0 mask 255.255.255.0
CORE(config-router-af)# exit
CORE(config-router)# exit
CORE(config)# evpn
CORE(config-evpn)# vni 10
```

	<pre> CORE(config-evpn-vni)# rd auto CORE(config-evpn-vni)# route-target both auto CORE(config-evpn-vni)# exit CORE(config-evpn)# vni 20 CORE(config-evpn-vni)# rd auto CORE(config-evpn-vni)# route-target both auto CORE(config-evpn-vni)# exit CORE(config-evpn)# vni 100 CORE(config-evpn-vni)# rd auto CORE(config-evpn-vni)# route-target both auto CORE(config-evpn-vni)# exit </pre>
TOR1	<pre> TOR1# configure terminal Enter configuration commands, one per line. End with CNTL/Z. TOR1(config)# interface Loopback 1 TOR1(config-if- Loopback 1)# ip address 2.2.2.2/32 TOR1(config-if- Loopback 1)# exit TOR1(config)# vtep TOR1(config-vtep)# source loopback 1 TOR1(config-vtep)# arp suppress enable TOR1(config-vtep)# exit TOR1(config)# vxlan 10 TOR1(config-vxlan)# extend-vlan 10 TOR1(config-vxlan)# arp suppress enable TOR1(config-vxlan)# exit TOR1(config)# vxlan 20 TOR1(config-vxlan)# extend-vlan 20 TOR1(config-vxlan)# arp suppress enable TOR1(config-vxlan)# exit TOR1(config)# router bgp 64512 TOR1 (config-router)# neighbor 1.1.1.2 remote-as 64512 TOR1 (config-router)# neighbor 1.1.1.2 update-source loopback 1 TOR1 (config-router)# neighbor 1.1.1.3 remote-as 64512 TOR1 (config-router)# neighbor 1.1.1.3 update-source loopback 1 TOR1 (config-router)# neighbor 3.3.3.3 remote-as 64512 TOR1 (config-router)# neighbor 3.3.3.3 update-source loopback 1 TOR1(config-router)# address-family l2vpn evpn TOR1(config-router-af)# neighbor 1.1.1.2 activate TOR1(config-router-af)# neighbor 1.1.1.3 activate TOR1(config-router-af)# neighbor 3.3.3.3 activate TOR1(config-router-af)# exit TOR1(config-router)# exit TOR1(config)# evpn TOR1(config-evpn)# vni 10 TOR1(config-evpn-vni)# rd auto </pre>

	<pre>TOR1(config-evpn-vni)# route-target both auto TOR1(config-evpn-vni)# exit TOR1(config-evpn)# vni 20 TOR1(config-evpn-vni)# rd auto TOR1(config-evpn-vni)# route-target both auto TOR1(config-evpn-vni)# exit</pre>
TOR2	<pre>TOR2# configure terminal Enter configuration commands, one per line. End with CNTL/Z. TOR2(config)# interface Loopback 1 TOR2(config-if- Loopback 1)# ip address 3.3.3.3/32 TOR2(config-if- Loopback 1)# exit TOR2(config)# vtep TOR2(config-vtep)# source loopback 1 TOR2(config-vtep)# arp suppress enable TOR2(config-vtep)# exit TOR2(config)# vxlan 100 TOR2(config-vxlan)# extend-vlan 100 TOR2(config-vxlan)# arp suppress enable TOR2(config-vxlan)# exit TOR2(config)# vxlan 20 TOR2(config-vxlan)# extend-vlan 20 TOR2(config-vxlan)# arp suppress enable TOR2(config-vxlan)# exit TOR2(config)# router bgp 64512 TOR2 (config-router)# neighbor 1.1.1.2 remote-as 64512 TOR2 (config-router)# neighbor 1.1.1.2 update-source loopback 1 TOR2 (config-router)# neighbor 1.1.1.3 remote-as 64512 TOR2 (config-router)# neighbor 1.1.1.3 update-source loopback 1 TOR2 (config-router)# neighbor 2.2.2.2 remote-as 64512 TOR2 (config-router)# neighbor 2.2.2.2 update-source loopback 1 TOR2(config-router)# address-family l2vpn evpn TOR2(config-router-af)# neighbor 1.1.1.2 activate TOR2(config-router-af)# neighbor 1.1.1.3 activate TOR2(config-router-af)# neighbor 2.2.2.2 activate TOR2(config-router-af)# exit TOR2(config-router)# exit TOR2(config)# evpn TOR2(config-evpn)# vni 20 TOR2(config-evpn-vni)# rd auto TOR2(config-evpn-vni)# route-target both auto TOR2(config-evpn-vni)# exit TOR2(config-evpn)# vni 100 TOR2(config-evpn-vni)# rd auto TOR2(config-evpn-vni)# route-target both auto</pre>

	<p>TOR2(config-evpn-vni)# exit</p>
<p>Verification</p>	<ul style="list-style-type: none"> ● Verify that HOST-1, HOST-2, HOST-3, and HOST-4 can ping each other. ● Verify that HOST-5 and HOST-6 can ping each other. ● Verify that HOST-1, HOST-2, HOST-3, and HOST-4 cannot ping HOST-5 and HOST-6. ● Verify that virtual machines can be migrated between the hosts on the same VXLAN and can access the network normally after migration without modifying the configuration.
	<pre> TOR1#sho vxlan VXLAN Total Count: 2 VXLAN Capacity : 8000 VXLAN 10 Symmetric property : FALSE Router Interface : - Extend VLAN : 10 VTEP Adjacency Count: 1 VTEP Adjacency List : Interface Source IP Destination IP Type ----- OverlayTunnel 6145 2.2.2.2 1.1.1.1 dynamic VXLAN 20 Symmetric property : FALSE Router Interface : - Extend VLAN : 20 VTEP Adjacency Count: 2 VTEP Adjacency List : Interface Source IP Destination IP Type ----- OverlayTunnel 6145 2.2.2.2 1.1.1.1 dynamic OverlayTunnel 6146 2.2.2.2 3.3.3.3 dynamic CORE#sho vxlan VXLAN Total Count: 3 VXLAN Capacity : 8000 VXLAN 10 Symmetric property : FALSE Router Interface : OverlayRouter 10 (anycast) Extend VLAN : 10 VTEP Adjacency Count: 1 VTEP Adjacency List : Interface Source IP Destination IP Type ----- </pre>

	OverlayTunnel 6147	1.1.1.1	2.2.2.2	dynamic
	VXLAN 20			
	Symmetric property : FALSE			
	Router Interface : OverlayRouter 20 (anycast)			
	Extend VLAN : 20			
	VTEP Adjacency Count: 2			
	VTEP Adjacency List :			
	Interface	Source IP	Destination IP	Type

	OverlayTunnel 6147	1.1.1.1	2.2.2.2	dynamic
	OverlayTunnel 6148	1.1.1.1	3.3.3.3	dynamic
	VXLAN 100			
	Symmetric property : FALSE			
	Router Interface : OverlayRouter 100 (anycast)			
	Extend VLAN : 100			
	VTEP Adjacency Count: 1			
	VTEP Adjacency List :			
	Interface	Source IP	Destination IP	Type

	OverlayTunnel 6148	1.1.1.1	3.3.3.3	dynamic

2.4.2.3 Configuring EVPN-based Multi-tenant Distributed Scenario (Enabling Anycast Gateway)

<p>Scenario Figure 2- 25</p>	<p>VXLAN 10 gateway:10.1.1.1/24 VXLAN 20 gateway:10.1.2.1/24 VXLAN 100 gateway: 10.1.3.1/24</p> <p>VXLAN 10 gateway:10.1.1.1/24 VXLAN 20 gateway:10.1.2.1/24 VXLAN 100 gateway: 10.1.3.1/24</p>
<p>Configuration Steps</p>	<ul style="list-style-type: none"> ● Configure an IPv4 unicast routing protocol such as the OSPF protocol on CORE, TOR-1, and TOR-2 to ensure that unicast routes are reachable. ● Configure the BGP-EVPN routing protocol on CORE, TOR-1, and TOR-2 to establish BGP neighbor relationships between the four devices and to support the EVPN protocol family. ● Configure the EVI for BGP-EVPN on TOR-1 and TOR-2. For details, see <i>BGP-EVPN Configuration Guide</i>. ● Configure a VXLAN on the virtual server and designate the gateway address of the virtual machine. ● Associate the VTEP with loopback interface on TOR-1 and TOR-2 to establish tunnels. ● Configure the anycast gateway MAC address on TOR-1 and TOR-2 to ensure that all VXLAN anycast gateways on the network use the same MAC address. ● Create VXLAN instances on TOR-1 and TOR-2 and associate the VXLAN instances with VLANs. ● Create overlay router interfaces on TOR-1 and TOR-2 and configure the VXLAN gateway IP address for the interfaces. Configure different VRF networks for different overlay router interfaces to determine their respective tenants. Configure the anycast gateway to ensure that all VXLAN gateways on the network use the same IP address and MAC address. As the anycast gateway function is enabled, the overlay router interfaces associated with the same VXLAN on TOR-1 and TOR-2 must be configured with the same VXLAN gateway IP address. ● Associate VXLAN instances with overlay router interfaces on TOR-1 and TOR-2 to realize VXLAN routing. ● (Optional) Configure ARP suppression on TOR-1 and TOR-2 to reduce the ARP packets entering the VXLAN. ● (Optional) Configure ARP proxy on the overlay router interfaces of TOR-1 and TOR-2 so that the VXLAN gateway uses the gateway MAC address to respond as a proxy and VXLAN network traffic is forwarded only at L3.
<p>HOST</p>	<p>Configuring the IP address and gateway according to Figure 2-25 (the detailed configuration on the server is omitted herein).</p>

CORE	VXLAN may be not configured on the core switches. The configuration of the OSPF and BGP is omitted herein.
TOR1	<pre> TOR1# configure terminal Enter configuration commands, one per line. End with CNTL/Z. TOR1(config)# interface Loopback 1 TOR1(config-if- Loopback 1)# ip address 2.2.2.2/32 TOR1(config-if- Loopback 1)# exit TOR1(config)# vtep TOR1(config-vtep)# source loopback 1 TOR1(config-vtep)# arp suppress enable TOR1(config-vtep)# exit TOR1(config)# fabric anycast-gateway-mac 0011.2233.2016 TOR1(config)# ip vrf vrf-10 TOR1(config-vrf)# rd 10:10 TOR1(config-vrf)# route-target both 1000:1000 TOR1(config-vrf)# exit TOR1(config)# ip vrf vrf-20 TOR1(config-vrf)# rd 20:20 TOR1(config-vrf)# route-target both 2000:2000 TOR1(config-vrf)# exit TOR1(config)# int overlayrouter 10 TOR1(config-if-OverlayRouter 10)# ip vrf forwarding vrf-10 TOR1(config-if-OverlayRouter 10)# ip address 10.1.1.1/24 TOR1(config-if-OverlayRouter 10)# anycast-gateway TOR1(config-if-OverlayRouter 10)# route-in-vni //Optional. It needs to be used in combination with the arp suppress enable command. TOR1(config-if-OverlayRouter 10)# exit TOR1(config)# int overlayrouter 20 TOR1(config-if-OverlayRouter 20)# ip vrf forwarding vrf-10 TOR1(config-if-OverlayRouter 20)# ip address 10.1.2.1/24 TOR1(config-if-OverlayRouter 20)# anycast-gateway TOR1(config-if-OverlayRouter 20)# route-in-vni //Optional. It needs to be used in combination with the arp suppress enable command. TOR1(config-if-OverlayRouter 20)# exit TOR1(config)# int overlayrouter 100 TOR1(config-if-OverlayRouter 100)# ip vrf forwarding vrf-20 TOR1(config-if-OverlayRouter 100)# ip address 10.1.3.1/24 TOR1(config-if-OverlayRouter 100)# anycast-gateway TOR1(config-if-OverlayRouter 100)# route-in-vni //Optional. It needs to be used in combination with the arp suppress enable command. TOR1(config-if-OverlayRouter 100)# exit TOR1(config)# vxlan 10 TOR1(config-vxlan)# extend-vlan 10 TOR1(config-vxlan)# router-interface OverlayRouter 10 TOR1(config-vxlan)# arp suppress enable </pre>

	<pre> TOR1(config-vxlan)# exit TOR1(config)# vxlan 20 TOR1(config-vxlan)# extend-vlan 20 TOR1(config-vxlan)# router-interface OverlayRouter 20 TOR1(config-vxlan)# arp suppress enable TOR1(config-vxlan)# exit TOR1(config)# vxlan 100 TOR1(config-vxlan)# extend-vlan 100 TOR1(config-vxlan)# router-interface OverlayRouter 100 TOR1(config-vxlan)# arp suppress enable TOR1(config-vxlan)# exit TOR1(config)# router bgp 64512 TOR1(config-router)# neighbor 3.3.3.3 remote-as 64512 TOR1(config-router)# neighbor 3.3.3.3 update-source loopback 1 TOR1(config-router)# address-family l2vpn evpn TOR1(config-router-af)# neighbor 3.3.3.3 activate TOR1(config-router-af)# exit TOR1(config-router)# exit TOR1(config)# evpn TOR1(config-evpn)# vni 10 TOR1(config-evpn-vni)# rd auto TOR1(config-evpn-vni)# route-target both auto TOR1(config-evpn-vni)# exit TOR1(config-evpn)# vni 20 TOR1(config-evpn-vni)# rd auto TOR1(config-evpn-vni)# route-target both auto TOR1(config-evpn-vni)# exit TOR1(config-evpn)# vni 100 TOR1(config-evpn-vni)# rd auto TOR1(config-evpn-vni)# route-target both auto TOR1(config-evpn-vni)# exit </pre>
TOR2	<pre> TOR2# configure terminal Enter configuration commands, one per line. End with CNTL/Z. TOR2(config)# interface Loopback 1 TOR2(config-if- Loopback 1)# ip address 3.3.3.3/32 TOR2(config-if- Loopback 1)# exit TOR2(config)# vtep TOR2(config-vtep)# source loopback 1 TOR2(config-vtep)# arp suppress enable TOR2(config-vtep)# exit TOR1(config)# fabric anycast-gateway-mac 0011.2233.2016 TOR2(config)# ip vrf vrf-10 TOR2(config-vrf)# rd 10:10 TOR2(config-vrf)# route-target both 1000:1000 </pre>

```
TOR2(config-vrf)# exit
TOR2(config)# ip vrf vrf-20
TOR2(config-vrf)# rd 20:20
TOR2(config-vrf)# route-target both 2000:2000
TOR2(config-vrf)# exit
TOR2(config)# int overlayrouter 10
TOR2(config-if-OverlayRouter 10)# ip vrf forwarding vrf-10
TOR2(config-if-OverlayRouter 10)# ip address 10.1.1.1/24
TOR2(config-if-OverlayRouter 10)# anycast-gateway
TOR2(config-if-OverlayRouter 10)# route-in-vni //Optional. It needs to be used in combination with the arp suppress enable command.
TOR2(config-if-OverlayRouter 10)# exit
TOR2(config)# int overlayrouter 20
TOR2(config-if-OverlayRouter 20)# ip vrf forwarding vrf-10
TOR2(config-if-OverlayRouter 20)# ip address 10.1.2.1/24
TOR2(config-if-OverlayRouter 20)# anycast-gateway
TOR2(config-if-OverlayRouter 20)# route-in-vni //Optional. It needs to be used in combination with the arp suppress enable command.
TOR2(config-if-OverlayRouter 20)# exit
TOR2(config)# int overlayrouter 100
TOR2(config-if-OverlayRouter 100)# ip vrf forwarding vrf-20
TOR2(config-if-OverlayRouter 100)# ip address 10.1.3.1/24
TOR2(config-if-OverlayRouter 100)# anycast-gateway
TOR2(config-if-OverlayRouter 100)# route-in-vni //Optional. It needs to be used in combination with the arp suppress enable command.
TOR2(config-if-OverlayRouter 100)# exit
TOR2(config)# vxlan 10
TOR2(config-vxlan)# extend-vlan 10
TOR2(config-vxlan)# router-interface OverlayRouter 10
TOR2(config-vxlan)# arp suppress enable
TOR2(config-vxlan)# exit
TOR2(config)# vxlan 20
TOR2(config-vxlan)# extend-vlan 20
TOR2(config-vxlan)# router-interface OverlayRouter 20
TOR2(config-vxlan)# arp suppress enable
TOR2(config-vxlan)# exit
TOR2(config)# vxlan 100
TOR2(config-vxlan)# extend-vlan 100
TOR2(config-vxlan)# router-interface OverlayRouter 100
TOR2(config-vxlan)# arp suppress enable

TOR2(config-vxlan)# exit
TOR2(config)# router bgp 64512
TOR2(config-router)# neighbor 2.2.2.2 remote-as 64512
```

	<pre>TOR2(config-router)# neighbor 2.2.2.2 update-source loopback 1 TOR2(config-router)# address-family l2vpn evpn TOR2(config-router-af)# neighbor 2.2.2.2 activate TOR2(config-router-af)# exit TOR2(config-router)# exit TOR2(config)# evpn TOR2(config-evpn)# vni 10 TOR2(config-evpn-vni)# rd auto TOR2(config-evpn-vni)# route-target both auto TOR2(config-evpn-vni)# exit TOR2(config-evpn)# vni 20 TOR2(config-evpn-vni)# rd auto TOR2(config-evpn-vni)# route-target both auto TOR2(config-evpn-vni)# exit TOR2(config-evpn)# vni 100 TOR2(config-evpn-vni)# rd auto TOR2(config-evpn-vni)# route-target both auto TOR2(config-evpn-vni)# exit</pre>
<p>Verification</p>	<ul style="list-style-type: none"> ● Verify that HOST-1, HOST-2, HOST-4, and HOST-5 can ping each other. ● Verify that HOST-3 and HOST-6 can ping each other. ● Verify that HOST-1, HOST-2, HOST-4, and HOST-5 cannot ping HOST-3 and HOST-6. ● Verify that the virtual machines can be migrated between the hosts on the same VXLAN and can access the network normally after migration without modifying the configuration.
	<pre>TOR1#sho vxlan VXLAN Total Count: 3 VXLAN Capacity : 8000 VXLAN 10 Symmetric property : FALSE Router Interface : OverlayRouter 10 (anycast) Extend VLAN : 10 VTEP Adjacency Count: 1 VTEP Adjacency List : Interface Source IP Destination IP Type ----- OverlayTunnel 6145 2.2.2.2 3.3.3.3 dynamic VXLAN 20 Symmetric property : FALSE Router Interface : OverlayRouter 20 (anycast) Extend VLAN : 20 VTEP Adjacency Count: 1 VTEP Adjacency List : Interface Source IP Destination IP Type</pre>

	OverlayTunnel 6145	2.2.2.2	3.3.3.3	dynamic
	VXLAN 100			
	Symmetric property : FALSE			
	Router Interface : OverlayRouter 100 (anycast)			
	Extend VLAN : 100			
	VTEP Adjacency Count: 1			
	VTEP Adjacency List :			
	Interface	Source IP	Destination IP	Type

	OverlayTunnel 6145	2.2.2.2	3.3.3.3	dynamic

Common Errors

When symmetric deployment is disabled, all TOR switches of the same VRF network must have all the VXLAN gateways of the VRF network configured on them. For example, VRF-10 includes VXLAN 10 and VXLAN 20, and therefore all gateways of VXLAN 10 and VXLAN 20 must be configured on TOR-1 and TOR-2. Otherwise, VXLAN 10 and VXLAN 20 cannot communicate with each other. If you expect to deploy only required gateways instead of deploying all gateways on all TOR switches, apply symmetric deployment. For details, see section "Configuring EVPN-based Multi-tenant Distributed Scenario (Symmetric Deployment)."

Make sure that the global anycast MAC address is not the same as that of any device on the VXLAN.

2.4.2.4 Configuring EVPN-based Multi-tenant Distributed Scenario (Symmetric Deployment)

Scenario Figure 2- 26	
---------------------------------	--

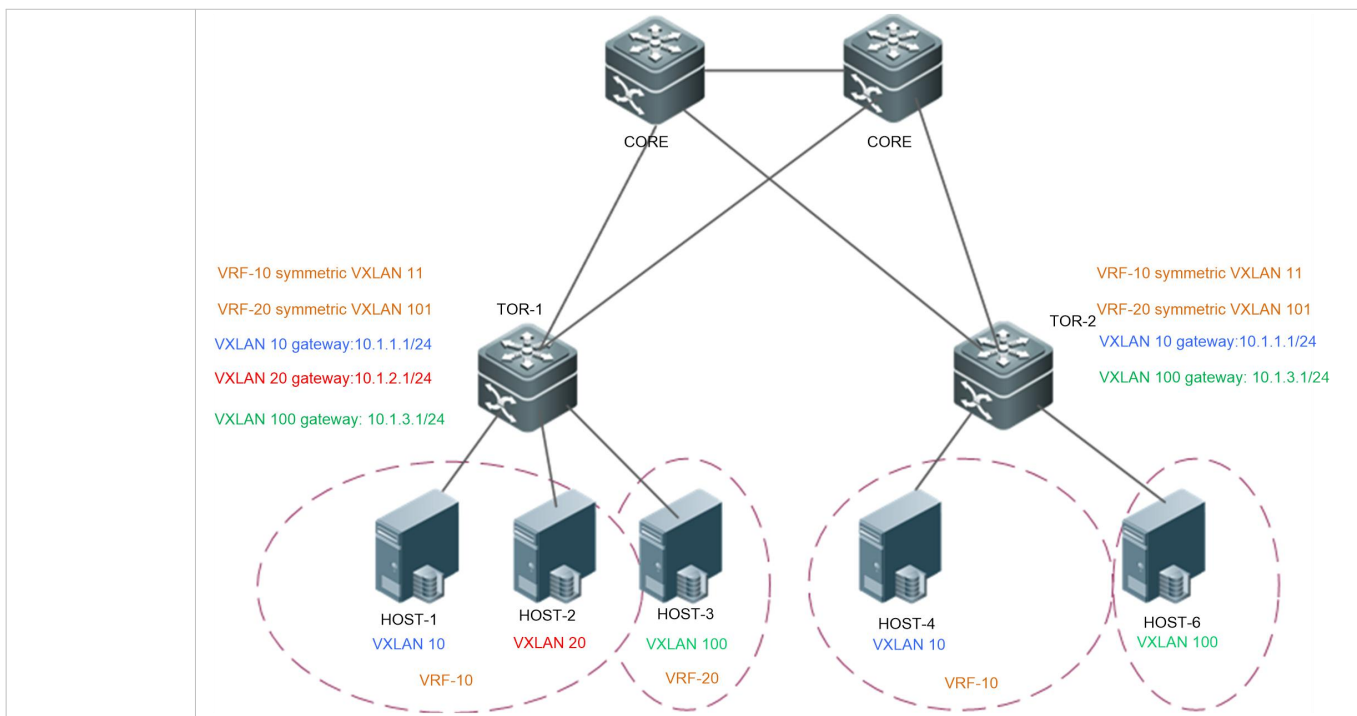

Configuration Steps

- Configure an IPv4 unicast routing protocol such as the OSPF protocol on CORE, TOR-1, and TOR-2 to ensure that unicast routes are reachable.
- Configure the BGP-EVPN routing protocol on CORE, TOR-1, and TOR-2 to establish BGP neighbor relationships between the four devices and to support the EVPN protocol family.
- Configure the EVI for BGP-EVPN on TOR-1 and TOR-2. For details, see *BGP-EVPN Configuration Guide*.
- Configure a VXLAN on the virtual server and designate the gateway address of the virtual machine.
- Associate the VTEP with loopback interface on TOR-1 and TOR-2 to establish tunnels.
- Configure the anycast gateway MAC address on TOR-1 and TOR-2 to ensure that all VXLAN anycast gateways on the network use the same MAC address.
- Create VXLAN 10, VXLAN20, and VXLAN 100 on TOR-1 and associate them with VLANs.
- Create VXLAN 10 and VXLAN 100 on TOR-2 and associate them with VLANs.
- Create overlay router interfaces for VXLAN 10, VXLAN 20, and VXLAN 100 on TOR-1 and TOR-2 (TOR-2 do not have VXLAN 20), and configure the VXLAN gateway IP address for them. Configure different VRF networks for different overlay router interfaces to determine their respective tenants. Configure the anycast gateway to ensure that all VXLAN gateways on the network use the same IP address and MAC address. As the anycast gateway function is enabled, the overlay router interfaces associated with the same VXLAN on TOR-1 and TOR-2 must be configured with the same VXLAN gateway IP address.
- Create VXLAN 11 and VXLAN 101 on TOR-1 and TOR-2 and configure them as symmetric VXLANs to serve as L3 routing VXLAN of the corresponding VRF networks. L3 routes between all VXLANs of the same VRF network are advertised via the symmetric VXLANs. In addition, the symmetric VXLANs are also used for L3 routing and forwarding.
- Create overlay router interfaces for VXLAN 11 and VXLAN 101 on TOR-1 and TOR-2. Configure different VRF networks for the overlay router interfaces. VXLAN 11 and VXLAN 101 serve as the symmetric VXLANs of the corresponding VRF networks.
- Associate VXLAN instances with overlay router interfaces on TOR-1 and TOR-2 to realize VXLAN routing.
- (Optional) Configure ARP suppression on TOR-1 and TOR-2 to reduce the ARP packets entering the VXLAN.

	<ul style="list-style-type: none"> ● (Optional) Configure ARP proxy on the overlay router interfaces belonging to the L2-VNIs (VXLANs 10, 20, and 100) on TOR-1 and TOR-2 so that the traffic of hosts in the same VXLAN is forwarded at L3. This function needs to be enabled together with ARP suppression. The configuration command is route-in-vni. ● (Optional) Configure no synchronization of EVPN entries in ARP proxy deployment scenario: On the L2-VNI VXLAN instances (VXLANs 10, 20, and 100) on TOR-1 and TOR-2, configure not to advertise or receive MAC-only EVPN type-2 routes. <ul style="list-style-type: none"> ■ Configure not to advertise EVPN MAC-only type-2 routes to reduce EVPN route synchronization between devices. The configuration command is evpn mac advertise disable. ■ Configure not to deliver MAC entries synchronized by EVPNs to reduce the occupancy of hardware entry resources. The configuration command is evpn mac inactive. <p>The two commands above can be configured independently and they do not affect each other.</p> <ul style="list-style-type: none"> ● (Optional) Configure no synchronization of EVPN entries in scenarios where ARP proxy is not deployed: On the L2-VNI VXLAN instances (VXLANs 10, 20, and 100) on TOR-1 and TOR-2, configure not to advertise EVPN MAC-only type-2 routes and configure to extract MAC addresses from MAC-IP type-2 routes. <ul style="list-style-type: none"> ■ Configure not to advertise EVPN MAC-only type-2 routes to reduce EVPN route synchronization between devices. The configuration command is evpn mac advertise disable. ■ Configure to extract MAC addresses from MAC-IP type-2 routes so that the device can learn MAC entries even if neighbors do not advertise MAC-only type-2 routes. The configuration command is evpn arp mac-learning enable. ● The two commands above must be used in combination. Otherwise, the device cannot learn MAC entries from neighbors and L2 forwarding cannot be implemented in VXLANs.
HOST	Configuring the IP address and gateway according to Figure 2-26 (the detailed configuration on the server is omitted herein).
CORE	VXLAN may be not configured on the core switches. The configuration of the OSPF and BGP is omitted herein.
TOR1	<pre> TOR1# configure terminal Enter configuration commands, one per line. End with CNTL/Z. TOR1(config)# interface Loopback 1 TOR1(config-if- Loopback 1)# ip address 2.2.2.2/32 TOR1(config-if- Loopback 1)# exit TOR1(config)# vtep TOR1(config-vtep)# source loopback 1 TOR1(config-vtep)# arp suppress enable TOR1(config-vtep)# exit TOR1(config)# fabric anycast-gateway-mac 0011.2233.2016 TOR1(config)# ip vrf vrf-10 TOR1(config-vrf)# rd 10:10 TOR1(config-vrf)# route-target both 1000:1000 TOR1(config-vrf)# exit TOR1(config)# ip vrf vrf-20 TOR1(config-vrf)# rd 20:20 TOR1(config-vrf)# route-target both 2000:2000 TOR1(config-vrf)# exit TOR1(config)# int overlayrouter 10 TOR1(config-if-OverlayRouter 10)# ip vrf forwarding vrf-10 </pre>

```
TOR1(config-if-OverlayRouter 10)# ip address 10.1.1.1/24
TOR1(config-if-OverlayRouter 10)# anycast-gateway
TOR1(config-if-OverlayRouter 10)# route-in-vni //Optional. It is used to enable ARP proxy and needs to be used in
combination with the arp suppress enable command.
TOR1(config-if-OverlayRouter 10)# exit
TOR1(config)# int overlayrouter 20
TOR1(config-if-OverlayRouter 20)# ip vrf forwarding vrf-10
TOR1(config-if-OverlayRouter 20)# ip address 10.1.2.1/24
TOR1(config-if-OverlayRouter 20)# anycast-gateway
TOR1(config-if-OverlayRouter 20)# route-in-vni //Optional. It is used to enable ARP proxy and needs to be used in
combination with the arp suppress enable command.
TOR1(config-if-OverlayRouter 20)# exit
TOR1(config)# int overlayrouter 11
TOR1(config-if-OverlayRouter 11)# ip vrf forwarding vrf-10
TOR1(config-if-OverlayRouter 11)# exit
TOR1(config)# int overlayrouter 100
TOR1(config-if-OverlayRouter 100)# ip vrf forwarding vrf-20
TOR1(config-if-OverlayRouter 100)# ip address 10.1.3.1/24
TOR1(config-if-OverlayRouter 100)# anycast-gateway
TOR1(config-if-OverlayRouter 100)# route-in-vni
TOR1(config-if-OverlayRouter 100)# exit
TOR1(config)# int overlayrouter 101
TOR1(config-if-OverlayRouter 101)# ip vrf forwarding vrf-20
TOR1(config-if-OverlayRouter 101)# exit
TOR1(config)# vxlan 10
TOR1(config-vxlan)# extend-vlan 10
TOR1(config-vxlan)# router-interface OverlayRouter 10
TOR1(config-vxlan)# arp suppress enable
TOR1(config-vxlan)#evpn mac advertise disable
TOR1(config-vxlan)#evpn mac inactive
TOR1(config-vxlan)#evpn arp mac-learning enable
TOR1(config-vxlan)# exit
TOR1(config)# vxlan 20
TOR1(config-vxlan)# extend-vlan 20
TOR1(config-vxlan)# router-interface OverlayRouter 20
TOR1(config-vxlan)# arp suppress enable
TOR1(config-vxlan)#evpn mac advertise disable //Optional.
TOR1(config-vxlan)#evpn mac inactive //Optional. In ARP proxy deployment scenarios, it is used to reduce the
synchronization of EVPN entries.
TOR1(config-vxlan)#evpn arp mac-learning enable //Optional. In scenarios in which ARP proxy is not deployed, it is
used to reduce the synchronization of EVPN entries.
TOR1(config-vxlan)# exit
TOR1(config)# vxlan 11
TOR1(config-vxlan)# symmetric
```

	<pre> TOR1(config-vxlan)# router-interface OverlayRouter 11 TOR1(config-vxlan)# exit TOR1(config)# vxlan 100 TOR1(config-vxlan)# extend-vlan 100 TOR1(config-vxlan)# router-interface OverlayRouter 100 TOR1(config-vxlan)# arp suppress enable TOR1(config-vxlan)# evpn mac advertise disable //Optional. TOR1(config-vxlan)# evpn mac inactive //Optional. In ARP proxy deployment scenarios, it is used to reduce the synchronization of EVPN entries. TOR1(config-vxlan)# evpn arp mac-learning enable //Optional. In scenarios in which ARP proxy is not deployed, it is used to reduce the synchronization of EVPN entries. TOR1(config-vxlan)# exit TOR1(config)# vxlan 101 TOR1(config-vxlan)# symmetric TOR1(config-vxlan)# router-interface OverlayRouter 101 TOR1(config-vxlan)# exit TOR1(config)# router bgp 64512 TOR1(config-router)# neighbor 3.3.3.3 remote-as 64512 TOR1(config-router)# neighbor 3.3.3.3 update-source loopback 1 TOR1(config-router)# address-family l2vpn evpn TOR1(config-router-af)# neighbor 3.3.3.3 activate TOR1(config-router-af)# exit TOR1(config-router)# exit TOR1(config)# evpn TOR1(config-evpn)# vni 10 TOR1(config-evpn-vni)# rd auto TOR1(config-evpn-vni)# route-target both auto TOR1(config-evpn-vni)# exit TOR1(config-evpn)# vni 11 TOR1(config-evpn-vni)# rd auto TOR1(config-evpn-vni)# route-target both auto TOR1(config-evpn-vni)# exit TOR1(config-evpn)# vni 100 TOR1(config-evpn-vni)# rd auto TOR1(config-evpn-vni)# route-target both auto TOR1(config-evpn-vni)# exit TOR1(config-evpn)# vni 101 TOR1(config-evpn-vni)# rd auto TOR1(config-evpn-vni)# route-target both auto TOR1(config-evpn-vni)# exit </pre>
TOR2	<pre> TOR2# configure terminal Enter configuration commands, one per line. End with CNTL/Z. TOR2(config)# interface Loopback 1 TOR2(config-if- Loopback 1)# ip address 3.3.3.3/32 </pre>

```
TOR2(config-if- Loopback 1)# exit
TOR2(config)# vtep
TOR2(config-vtep)# source loopback 1
TOR2(config-vtep)# arp suppress enable
TOR2(config-vtep)# exit
TOR2(config)# fabric anycast-gateway-mac 0011.2233.2016
TOR2(config)# ip vrf vrf-10
TOR2(config-vrf)# rd 10:10
TOR2(config-vrf)# route-target both 1000:1000
TOR2(config-vrf)# exit
TOR2(config)# ip vrf vrf-20
TOR2(config-vrf)# rd 20:20
TOR2(config-vrf)# route-target both 2000:2000
TOR2(config-vrf)# exit
TOR2(config)# int overlayrouter 10
TOR2(config-if-OverlayRouter 10)# ip vrf forwarding vrf-10
TOR2(config-if-OverlayRouter 10)# ip address 10.1.1.1/24
TOR2(config-if-OverlayRouter 10)# anycast-gateway
TOR2(config-if-OverlayRouter 10)# route-in-vni //Optional. It is used to enable ARP proxy and needs to be used in
combination with the arp suppress enable command.
TOR2(config-if-OverlayRouter 10)# exit
TOR2(config)# int overlayrouter 11
TOR2(config-if-OverlayRouter 11)# ip vrf forwarding vrf-10
TOR2(config-if-OverlayRouter 11)# exit
TOR2(config)# int overlayrouter 100
TOR2(config-if-OverlayRouter 100)# ip vrf forwarding vrf-20
TOR2(config-if-OverlayRouter 100)# ip address 10.1.3.1/24
TOR2(config-if-OverlayRouter 100)# anycast-gateway
TOR2(config-if-OverlayRouter 100)# route-in-vni //可选配置， 开启 ARP 代理， 需配合 arp suppress enable
TOR2(config-if-OverlayRouter 100)# exit
TOR2(config)# int overlayrouter 101
TOR2(config-if-OverlayRouter 101)# ip vrf forwarding vrf-20
TOR2(config-if-OverlayRouter 101)# exit
TOR2(config)# vxlan 10
TOR2(config-vxlan)# extend-vlan 10
TOR2(config-vxlan)# router-interface OverlayRouter 10
TOR2(config-vxlan)# arp suppress enable
TOR2(config-vxlan)# evpn mac advertise disable //Optional.
TOR2(config-vxlan)# evpn mac inactive //Optional. In ARP proxy deployment scenarios, it is used to reduce the
synchronization of EVPN entries.
TOR2(config-vxlan)# evpn arp mac-learning enable //Optional. In scenarios in which ARP proxy is not deployed, it is
used to reduce the synchronization of EVPN entries.
TOR2(config-vxlan)# exit
TOR2(config)# vxlan 11
```

<pre> TOR2(config-vxlan)# symmetric TOR2(config-vxlan)# router-interface OverlayRouter 11 TOR2(config-vxlan)# exit TOR2(config)# vxlan 100 TOR2(config-vxlan)# extend-vlan 100 TOR2(config-vxlan)# router-interface OverlayRouter 100 TOR2(config-vxlan)# arp suppress enable TOR2(config-vxlan)# evpn mac advertise disable //Optional. TOR2(config-vxlan)# evpn mac inactive //Optional. In ARP proxy deployment scenarios, it is used to reduce the synchronization of EVPN entries. TOR2(config-vxlan)# evpn arp mac-learning enable //Optional. In scenarios in which ARP proxy is not deployed, it is used to reduce the synchronization of EVPN entries. TOR2(config-vxlan)# exit TOR2(config)# int overlayrouter 101 TOR2(config-vxlan)# symmetric TOR2(config-vxlan)# router-interface OverlayRouter 101 TOR2(config-vxlan)# exit TOR2(config)# router bgp 64512 TOR2(config-router)# neighbor 2.2.2.2 remote-as 64512 TOR2(config-router)# neighbor 2.2.2.2 update-source loopback 1 TOR2(config-router)# address-family l2vpn evpn TOR2(config-router-af)# neighbor 2.2.2.2 activate TOR2(config-router-af)# exit TOR2(config-router)# exit TOR2(config)# evpn TOR2(config-evpn)# vni 10 TOR2(config-evpn-vni)# rd auto TOR2(config-evpn-vni)# route-target both auto TOR2(config-evpn-vni)# exit TOR2(config-evpn)# vni 11 TOR2(config-evpn-vni)# rd auto TOR2(config-evpn-vni)# route-target both auto TOR2(config-evpn-vni)# exit TOR2(config-evpn)# vni 100 TOR2(config-evpn-vni)# rd auto TOR2(config-evpn-vni)# route-target both auto TOR2(config-evpn-vni)# exit TOR2(config-evpn)# vni 101 TOR2(config-evpn-vni)# rd auto TOR2(config-evpn-vni)# route-target both auto TOR2(config-evpn-vni)# exit </pre>	<p>Verification</p> <ul style="list-style-type: none"> ● Verify that HOST-1, HOST-2, and HOST-4 can ping each other. ● Verify that HOST-3 and HOST-6 can ping each other. ● Verify that HOST-1, HOST-2, and HOST-4 cannot ping HOST-3 and HOST-6.
--	---

- Verify that the virtual machines can be migrated between the hosts on the same VXLAN and can access the network normally after migration without modifying the configuration.

```
TOR1#sho vxlan
VXLAN Total Count: 5
VXLAN Capacity   : 8000

VXLAN 10
  Symmetric property : FALSE
  Router Interface   : OverlayRouter 10 (anycast)
  Extend VLAN       : 10
  VTEP Adjacency Count: 1
  VTEP Adjacency List :
  Interface          Source IP      Destination IP  Type
  -----
  OverlayTunnel 6145  2.2.2.2        3.3.3.3        dynamic

VXLAN 11
  Symmetric property : TRUE
  Router Interface   : OverlayRouter 11 (anycast)
  Extend VLAN       : -
  VTEP Adjacency Count: 1
  VTEP Adjacency List :
  Interface          Source IP      Destination IP  Type
  -----
  OverlayTunnel 6145  2.2.2.2        3.3.3.3        dynamic

VXLAN 20
  Symmetric property : FALSE
  Router Interface   : OverlayRouter 20 (anycast)
  Extend VLAN       : 20
  VTEP Adjacency Count: 1
  VTEP Adjacency List :
  Interface          Source IP      Destination IP  Type
  -----
  OverlayTunnel 6145  2.2.2.2        3.3.3.3        dynamic

VXLAN 100
  Symmetric property : FALSE
  Router Interface   : OverlayRouter 100 (anycast)
  Extend VLAN       : 100
  VTEP Adjacency Count: 1
  VTEP Adjacency List :
  Interface          Source IP      Destination IP  Type
  -----
```



OverlayTunnel 6145	2.2.2.2	3.3.3.3	dynamic
VXLAN 101			
Symmetric property : TRUE			
Router Interface : OverlayRouter 101 (anycast)			
Extend VLAN : -			
VTEP Adjacency Count: 1			
VTEP Adjacency List :			
Interface	Source IP	Destination IP	Type

OverlayTunnel 6145	2.2.2.2	3.3.3.3	dynamic

Common Errors

Make sure that the global anycast MAC address is not the same as that of any device on the VXLAN.

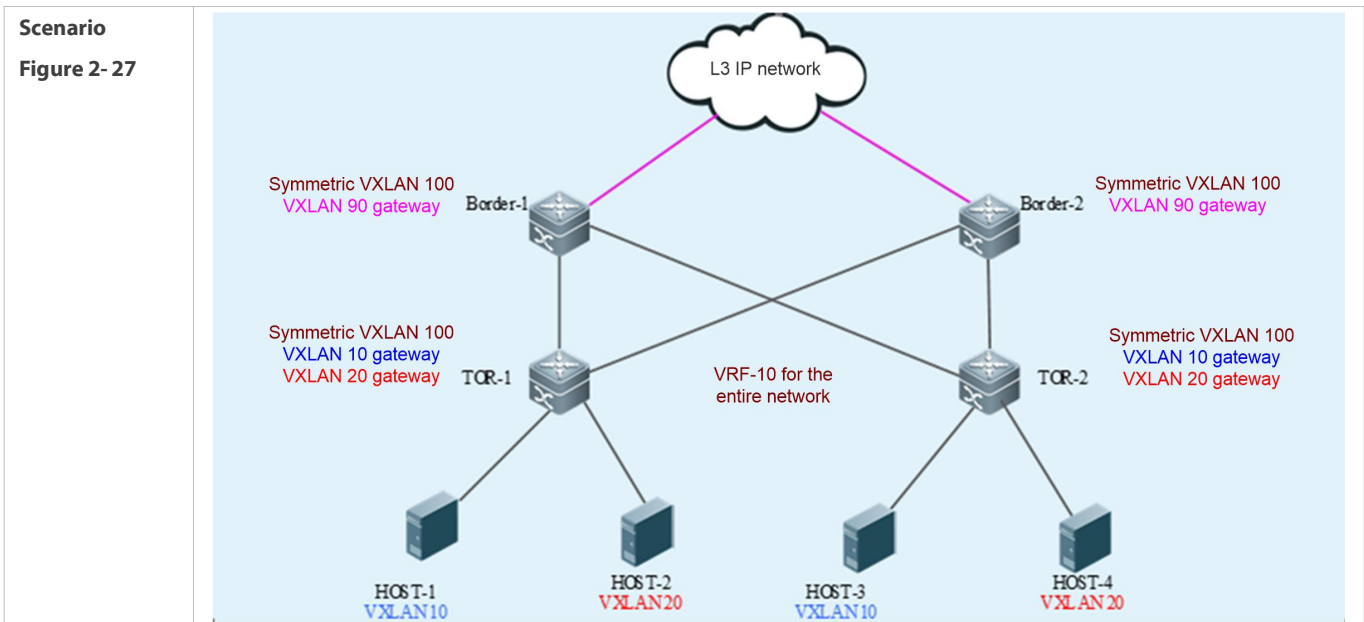
2.4.2.5 Configuring EVPN-based Single-tenant VXLAN Routing Scenario



Configuration Steps	<ul style="list-style-type: none"> ● Configure an IPv4 unicast routing protocol such as the OSPF protocol on Border-1, Border-2, TOR-1, and TOR-2 to ensure that unicast routes are reachable. ● Configure the BGP-EVPN routing protocol on Border-1, Border-2, TOR-1, and TOR-2 to establish BGP neighbor relationships between the devices (except between Border-1 and Border-2) and to support the EVPN protocol family. ● Configure the EVI for BGP-EVPN on TOR-1 and TOR-2. For details, see <i>BGP-EVPN Configuration Guide</i>. ● Configure a VXLAN on the virtual server and designate the gateway address of the virtual machine. ● Associate the VTEP with the loopback interface on TOR-1, TOR-2, Border-1, and Border-2 to establish tunnels.
----------------------------	---

	<ul style="list-style-type: none"> ● Configure the anycast gateway MAC address on TOR-1 and TOR-2 to ensure that all VXLAN anycast gateways on the network use the same MAC address. ● Create VXLAN 10 and VXLAN 20 on TOR-1 and associate them with VLANs. ● Create VXLAN 10 and VXLAN 20 on TOR-2 and associate them with VLANs. ● Create VXLAN 90 on Border-1 and associate VXLAN 90 with a VLAN. ● Create VXLAN 90 on Border-2 and associate VXLAN 90 with a VLAN. ● Create overlay router interfaces for VXLAN 10 and VXLAN 20 on TOR-1 and TOR-2, and configure the VXLAN gateway IP address for them. Configure the same VRF network for the overlay router interfaces to determine their respective tenants. Configure the anycast gateway to ensure that all VXLAN gateways on the network use the same IP address and MAC address. As the anycast gateway function is enabled, the overlay router interfaces associated with the same VXLAN on TOR-1 and TOR-2 must be configured with the same VXLAN gateway IP address. ● Create VXLAN 100 on TOR-1, TOR-2, Border-1, and Border-2. Configure VXLAN 100 as a symmetric VXLAN to serve as the L3 routing VXLAN of the corresponding VRF network. L3 routes between all VXLANs of the same VRF network are advertised via the symmetric VXLAN. In addition, the symmetric VXLAN is also used for L3 routing and forwarding. ● Create overlay router interfaces for VXLAN 100 on TOR-1 and TOR-2 and configure the same VRF network for the overlay router interfaces. VXLAN 100 serves as the symmetric VXLAN of the VRF network. ● Create overlay router interfaces for VXLAN 100 on Border-1 and Border-2, and configure the same VRF network for the overlay router interfaces, so that VXLAN 100 serves as the symmetric VXLAN of the VRF network. Configure VXLAN gateway IP addresses for Border-1 and Border-2 (different IP addresses for different devices). ● Create overlay router interfaces for VXLAN 90 on Border-1 and Border-2. Configure the same VRF network for the overlay router interfaces and configure the VXLAN gateway IP address. ● Associate VXLAN instances with overlay router interfaces on TOR-1, TOR-2, Border-1, and Border-2 to realize VXLAN routing. ● (Optional) Configure ARP suppression on TOR-1 and TOR-2 to reduce the ARP packets entering the VXLAN.
HOST	Configuring the IP address and gateway according to Figure 2-27 (the detailed configuration on the server is omitted herein).
TOR1	<pre> TOR1# configure terminal Enter configuration commands, one per line. End with CNTL/Z. TOR1(config)# interface Loopback 1 TOR1(config-if- Loopback 1)# ip address 1.1.1.1/32 TOR1(config-if- Loopback 1)# exit TOR1(config)# vtep TOR1(config-vtep)# source loopback 1 TOR1(config-vtep)# arp suppress enable TOR1(config-vtep)# exit TOR1(config)# fabric anycast-gateway-mac 0011.2233.2016 TOR1(config)# ip vrf vrf-10 TOR1(config-vrf)# rd 10:10 TOR1(config-vrf)# route-target export 1000:1000 TOR1(config-vrf)# exit TOR1(config)# int overlayrouter 10 TOR1(config-if-OverlayRouter 10)# ip vrf forwarding vrf-10 TOR1(config-if-OverlayRouter 10)# ip address 10.1.1.1/24 </pre>

```
TOR1(config-if-OverlayRouter 10)# anycast-gateway
TOR1(config-if-OverlayRouter 10)# exit
TOR1(config)# int overlayrouter 20
TOR1(config-if-OverlayRouter 20)# ip vrf forwarding vrf-10
TOR1(config-if-OverlayRouter 20)# ip address 20.1.1.1/24
TOR1(config-if-OverlayRouter 20)# anycast-gateway
TOR1(config-if-OverlayRouter 20)# exit
TOR1(config)# int overlayrouter 100
TOR1(config-if-OverlayRouter 100)# ip vrf forwarding vrf-10
TOR1(config-if-OverlayRouter 100)# ip address 100.1.4.1/24
TOR1(config-if-OverlayRouter 100)# exit
TOR1(config)# vxlan 10
TOR1(config-vxlan)# extend-vlan 10
TOR1(config-vxlan)# router-interface OverlayRouter 10
TOR1(config-vxlan)# arp suppress enable
TOR1(config-vxlan)# exit
TOR1(config)# vxlan 20
TOR1(config-vxlan)# extend-vlan 20
TOR1(config-vxlan)# router-interface OverlayRouter 20
TOR1(config-vxlan)# arp suppress enable
TOR1(config-vxlan)# exit
TOR1(config)# vxlan 100
TOR1(config-vxlan)# symmetric
TOR1(config-vxlan)# router-interface OverlayRouter 100
TOR1(config-vxlan)# exit
TOR1(config)# router bgp 64512
TOR1(config-router)# neighbor 2.2.2.2 remote-as 64512
TOR1(config-router)# neighbor 2.2.2.2 update-source loopback 1
TOR1(config-router)# neighbor 3.3.3.3 remote-as 64512
TOR1(config-router)# neighbor 3.3.3.3 update-source loopback 1
TOR1(config-router)# neighbor 4.4.4.4 remote-as 64512
TOR1(config-router)# neighbor 4.4.4.4 update-source loopback 1
TOR1(config-router)# address-family l2vpn evpn
TOR1(config-router-af)# neighbor 2.2.2.2 activate
TOR1(config-router-af)# neighbor 3.3.3.3 activate
TOR1(config-router-af)# neighbor 4.4.4.4 activate
TOR1(config-router-af)# advertise ipv4 unicast
TOR1(config-router-af)# exit
TOR1(config-router)# address-family ipv4 vrf vrf-10
TOR1(config-router-af)# redistribute connected
TOR1(config-router-af)# exit
TOR1(config-router)# exit
TOR1(config)# evpn
TOR1(config-evpn)# vni 10
```

	<pre>TOR1(config-evpn-vni)# rd auto TOR1(config-evpn-vni)# route-target both auto TOR1(config-evpn-vni)# exit TOR1(config-evpn)# vni 20 TOR1(config-evpn-vni)# rd auto TOR1(config-evpn-vni)# route-target both auto TOR1(config-evpn-vni)# exit TOR1(config-evpn)# vni 100 TOR1(config-evpn-vni)# rd auto TOR1(config-evpn-vni)# route-target both auto TOR1(config-evpn-vni)# route-target import 1000:1000 TOR1(config-evpn-vni)# exit</pre>
TOR2	<pre>TOR2# configure terminal Enter configuration commands, one per line. End with CNTL/Z. TOR2(config)# interface Loopback 1 TOR2(config-if- Loopback 1)# ip address 2.2.2.2/32 TOR2(config-if- Loopback 1)# exit TOR2(config)# vtep TOR2(config-vtep)# source loopback 1 TOR2(config-vtep)# arp suppress enable TOR2(config-vtep)# exit TOR2(config)# fabric anycast-gateway-mac 0011.2233.2016 TOR2(config)# ip vrf vrf-10 TOR2(config-vrf)# rd 10:10 TOR2(config-vrf)# route-target export 1000:1000 TOR2(config-vrf)# exit TOR2(config)# int overlayrouter 10 TOR2(config-if-OverlayRouter 10)# ip vrf forwarding vrf-10 TOR2(config-if-OverlayRouter 10)# ip address 10.1.1.1/24 TOR2(config-if-OverlayRouter 10)# anycast-gateway TOR2(config-if-OverlayRouter 10)# exit TOR2(config)# int overlayrouter 20 TOR2(config-if-OverlayRouter 20)# ip vrf forwarding vrf-10 TOR2(config-if-OverlayRouter 20)# ip address 20.1.1.1/24 TOR2(config-if-OverlayRouter 20)# anycast-gateway TOR2(config-if-OverlayRouter 20)# exit TOR2(config)# int overlayrouter 100 TOR2(config-if-OverlayRouter 100)# ip vrf forwarding vrf-10 TOR2(config-if-OverlayRouter 100)# ip address 100.1.3.1/24 TOR2(config-if-OverlayRouter 100)# exit TOR2(config)# vxlan 10 TOR2(config-vxlan)# extend-vlan 10 TOR2(config-vxlan)# router-interface OverlayRouter 10 TOR2(config-vxlan)# arp suppress enable</pre>

	<pre> TOR2(config-vxlan)# exit TOR2(config)# vxlan 20 TOR2(config-vxlan)# extend-vlan 20 TOR2(config-vxlan)# router-interface OverlayRouter 20 TOR2(config-vxlan)# arp suppress enable TOR2(config-vxlan)# exit TOR2(config)# vxlan 100 TOR2(config-vxlan)# symmetric TOR2(config-vxlan)# router-interface OverlayRouter 100 TOR2(config-vxlan)# exit TOR2(config)# router bgp 64512 TOR2(config-router)# neighbor 1.1.1.1 remote-as 64512 TOR2(config-router)# neighbor 1.1.1.1 update-source loopback 1 TOR2(config-router)# neighbor 3.3.3.3 remote-as 64512 TOR2(config-router)# neighbor 3.3.3.3 update-source loopback 1 TOR2(config-router)# neighbor 4.4.4.4 remote-as 64512 TOR2(config-router)# neighbor 4.4.4.4 update-source loopback 1 TOR2(config-router)# address-family l2vpn evpn TOR2(config-router-af)# neighbor 1.1.1.1 activate TOR2(config-router-af)# neighbor 3.3.3.3 activate TOR2(config-router-af)# neighbor 4.4.4.4 activate TOR2(config-router-af)# advertise ipv4 unicast TOR2(config-router-af)# exit TOR2(config-router)# address-family ipv4 vrf vrf-10 TOR2(config-router-af)# redistribute connected TOR2(config-router-af)# exit TOR2(config-router)# exit TOR2(config)# evpn TOR2(config-evpn)# vni 10 TOR2(config-evpn-vni)# rd auto TOR2(config-evpn-vni)# route-target both auto TOR2(config-evpn-vni)# exit TOR2(config-evpn)# vni 20 TOR2(config-evpn-vni)# rd auto TOR2(config-evpn-vni)# route-target both auto TOR2(config-evpn-vni)# exit TOR2(config-evpn)# vni 100 TOR2(config-evpn-vni)# rd auto TOR2(config-evpn-vni)# route-target both auto TOR2(config-evpn-vni)# route-target import 1000:1000 TOR2(config-evpn-vni)# exit </pre>
Border1	<pre> Border1# configure terminal Enter configuration commands, one per line. End with CNTL/Z. Border1(config)# interface Loopback 1 </pre>

```
Border1(config-if- Loopback 1)# ip address 3.3.3.3/32
Border1(config-if- Loopback 1)# exit
Border1(config)# vtep
Border1(config-vtep)# source loopback 1
Border1(config-vtep)# arp suppress enable
Border1(config-vtep)# exit
Border1(config)# fabric anycast-gateway-mac 0011.2233.2016
Border1(config)# ip vrf vrf-10
Border1(config-vrf)# rd 10:10
Border1(config-vrf)# route-target export 1000:1000
Border1(config-vrf)# exit
Border1(config)# int overlayrouter 90
Border1(config-if-OverlayRouter 90)# ip vrf forwarding vrf-10
Border1(config-if-OverlayRouter 90)# ip address 90.1.1.1/24
Border1(config-if-OverlayRouter 90)# anycast-gateway
Border1(config-if-OverlayRouter 90)# exit
Border1(config)# vxlan 90
Border1(config-vxlan)# extend-vlan 90
Border1(config-vxlan)# router-interface OverlayRouter 90
Border1(config-vxlan)# arp suppress enable
Border1(config-vxlan)# exit
Border1(config)# int overlayrouter 100
Border1(config-if-OverlayRouter 100)# ip vrf forwarding vrf-10
Border1(config-if-OverlayRouter 100)# ip address 100.1.1.1/24
Border1(config-if-OverlayRouter 100)# exit
Border1(config)# vxlan 100
Border1(config-vxlan)# symmetric
Border1(config-vxlan)# router-interface OverlayRouter 100
Border1(config-vxlan)# exit
Border1(config)# router bgp 64512
Border1(config-router)# neighbor 1.1.1.1 remote-as 64512
Border1(config-router)# neighbor 1.1.1.1 update-source loopback 1
Border1(config-router)# neighbor 2.2.2.2 remote-as 64512
Border1(config-router)# neighbor 2.2.2.2 update-source loopback 1
Border1(config-router)# neighbor 4.4.4.4 remote-as 64512
Border1(config-router)# neighbor 4.4.4.4 update-source loopback 1
Border1(config-router)# address-family l2vpn evpn
Border1(config-router-af)# neighbor 1.1.1.1 activate
Border1(config-router-af)# neighbor 2.2.2.2 activate
Border1(config-router-af)# neighbor 4.4.4.4 activate
Border1(config-router-af)# advertise ipv4 unicast
Border1(config-router-af)# exit
Border1(config-router)# address-family ipv4 vrf vrf-10
Border1(config-router-af)# redistribute static
```

	<pre> Border1(config-router-af)# exit Border1(config-router)# exit Border1(config)# evpn Border1(config-evpn)# vni 100 Border1(config-evpn-vni)# rd auto Border1(config-evpn-vni)# route-target both auto Border1(config-evpn-vni)# route-target import 1000:1000 Border1(config-evpn-vni)# exit </pre>
Border2	<pre> Border2# configure terminal Enter configuration commands, one per line. End with CNTL/Z. Border2(config)# interface Loopback 1 Border2(config-if- Loopback 1)# ip address 4.4.4.4/32 Border2(config-if- Loopback 1)# exit Border2(config)# vtep Border2(config-vtep)# source loopback 1 Border2(config-vtep)# arp suppress enable Border2(config-vtep)# exit Border2(config)# fabric anycast-gateway-mac 0011.2233.2016 Border2(config)# ip vrf vrf-10 Border2(config-vrf)# rd 10:10 Border2(config-vrf)# route-target export 1000:1000 Border2(config-vrf)# exit Border2(config)# int overlayrouter 90 Border2(config-if-OverlayRouter 90)# ip vrf forwarding vrf-10 Border2(config-if-OverlayRouter 90)# ip address 90.1.2.1/24 Border2(config-if-OverlayRouter 90)# anycast-gateway Border2(config-if-OverlayRouter 90)# exit Border2(config-vxlan)# arp suppress enable Border2(config-vxlan)# exit Border2(config)# int overlayrouter 100 Border2(config-if-OverlayRouter 100)# ip vrf forwarding vrf-10 Border2(config-if-OverlayRouter 100)# ip address 100.1.2.1/24 Border2(config-if-OverlayRouter 100)# exit Border2(config)# vxlan 90 Border2(config-vxlan)# extend-vlan 90 Border2(config-vxlan)# router-interface OverlayRouter 90 Border2(config-vxlan)# arp suppress enable Border2(config-vxlan)# exit Border2(config)# vxlan 100 Border2(config-vxlan)# symmetric Border2(config-vxlan)# router-interface OverlayRouter 100 Border2(config-vxlan)# exit Border2(config)# router bgp 64512 Border2(config-router)# neighbor 1.1.1.1 remote-as 64512 </pre>

	<pre> Border2(config-router)# neighbor 1.1.1.1 update-source loopback 1 Border2(config-router)# neighbor 2.2.2.2 remote-as 64512 Border2(config-router)# neighbor 2.2.2.2 update-source loopback 1 Border2(config-router)# neighbor 3.3.3.3 remote-as 64512 Border2(config-router)# neighbor 3.3.3.3 update-source loopback 1 Border2(config-router)# address-family l2vpn evpn Border2(config-router-af)# neighbor 1.1.1.1 activate Border2(config-router-af)# neighbor 2.2.2.2 activate Border2(config-router-af)# neighbor 3.3.3.3 activate Border2(config-router-af)# advertise ipv4 unicast Border2(config-router-af)# exit Border2(config-router)# address-family ipv4 vrf vrf-10 Border2(config-router-af)# redistribute static Border2(config-router-af)# exit Border2(config-router)# exit Border2(config)# evpn Border2(config-evpn)# vni 100 Border2(config-evpn-vni)# rd auto Border2(config-evpn-vni)# route-target both auto Border2(config-evpn-vni)# route-target import 1000:1000 Border2(config-evpn-vni)# exit </pre>
<p>Verification</p>	<ul style="list-style-type: none"> ● Verify that HOST-1, HOST-2, HOST-3, and HOST-4 can ping each other. ● Verify that the virtual machines can be migrated between the HOSTs on the same VXLAN and can access the network normally after migration without modifying the configuration.
	<pre> Border1# sh vxlan VXLAN Total Count: 3 VXLAN Capacity : 8000 VXLAN 90 Symmetric property : FALSE Router Interface : overlayrouter 90 (anycast) Extend VLAN : 90 VTEP Adjacency Count: 1 Interface Source IP Destination IP Type ----- OverlayTunnel 6146 3.3.3.3 2.2.2.2 dynamic VXLAN 100 Symmetric property : TRUE Router Interface : overlayrouter 100 (non-anycast) Extend VLAN : - VTEP Adjacency Count: 1 Interface Source IP Destination IP Type ----- </pre>

	OverlayTunnel 6146	3.3.3.3	2.2.2.2	dynamic
--	--------------------	---------	---------	---------

2.4.2.6 Configuring EVPN-based Multi-tenant VXLAN Routing Scenario

Scenario
Figure 2- 28

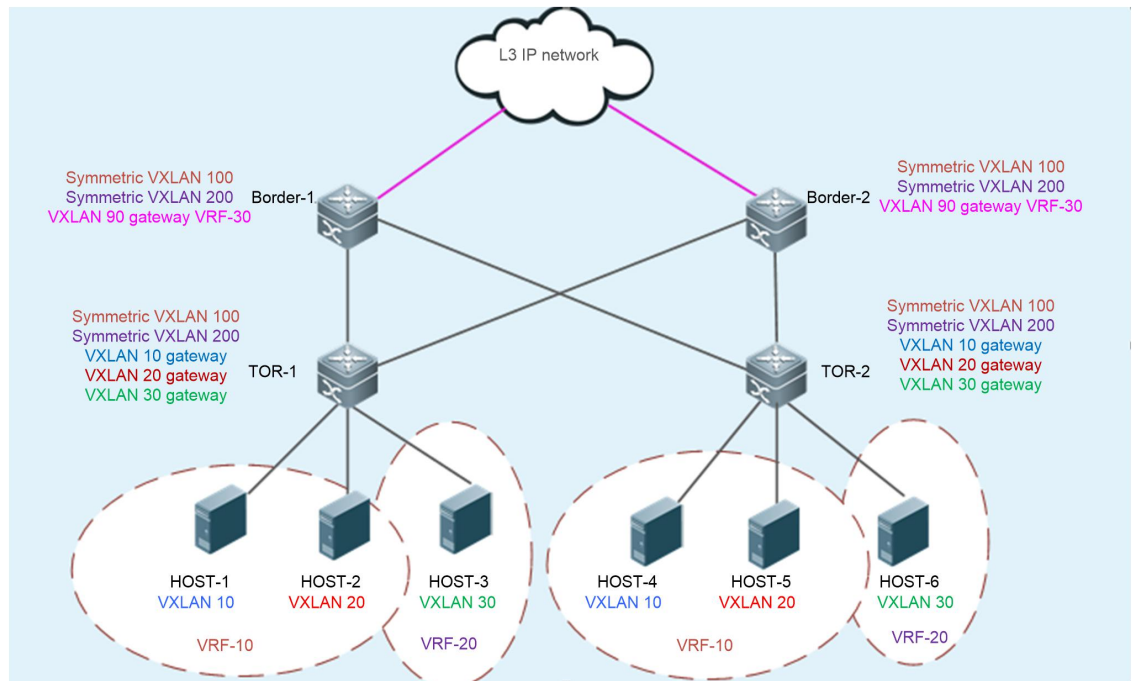

Configuration Steps

- Configure an IPv4 unicast routing protocol such as the OSPF protocol on Border-1, Border-2, TOR-1, and TOR-2 to ensure that unicast routes are reachable.
- Configure the BGP-EVPN routing protocol on Border-1, Border-2, TOR-1, and TOR-2 to establish BGP neighbor relationships between the devices (except between Border-1 and Border-2) and to support the EVPN protocol family.
- Configure the EVI for BGP-EVPN on TOR-1 and TOR-2. For details, see *BGP-EVPN Configuration Guide*.
- Configure a VXLAN on the virtual server and designate the gateway address of the virtual machine.
- Associate the VTEP with the loopback interface on TOR-1, TOR-2, Border-1, and Border-2 to establish tunnels.
- Configure the anycast gateway MAC address on TOR-1 and TOR-2 to ensure that all VXLAN anycast gateways on the network use the same MAC address.
- Create VXLAN 10, VXLAN 20, and VXLAN 30 on TOR-1 and associate them with VLANs.
- Create VXLAN 10, VXLAN 20, and VXLAN 30 on TOR-2 and associate them with VLANs.
- Create VXLAN 90 on Border-1 and associate VXLAN 90 with a VLAN.
- Create VXLAN 90 on Border-2 and associate VXLAN 90 with a VLAN.
- Create overlay router interfaces for VXLAN 10, VXLAN 20, and VXLAN 30 on TOR-1 and TOR-2 and configure the

	<p>VXLAN gateway IP address for them. Configure different VRF networks for different overlay router interfaces to determine their respective tenants. Configure the anycast gateway to ensure that all VXLAN gateways on the network use the same IP address and MAC address. As the anycast gateway function is enabled, the overlay router interfaces associated with the same VXLAN on TOR-1 and TOR-2 must be configured with the same VXLAN gateway IP address.</p> <ul style="list-style-type: none"> ● Create overlay router interfaces for VXLAN 100 and VXLAN 200 on TOR-1 and TOR-2 and configure different VRF networks for the overlay router interfaces. VXLAN 100 and VXLAN 200 serve as the symmetric VXLANs of the corresponding VRF networks. ● Create overlay router interfaces for VXLAN 100 and VXLAN 200 on Border-1 and Border-2. Configure different VRF networks for the overlay router interfaces so that VXLAN 100 and VXLAN 200 serve as the symmetric VXLANs of the corresponding VRF networks. Configure VXLAN gateway IP addresses for Border-1 and Border-2 (different IP addresses for different devices). ● Create overlay router interfaces for VXLAN 90 on Border-1 and Border-2. Configure different VRF networks for the OverlayRouter interfaces and configure the VXLAN gateway IP address. ● Associate VXLAN instances with overlay router interfaces on TOR-1, TOR-2, Border-1, and Border-2 to realize VXLAN routing. ● (Optional) Configure ARP suppression on TOR-1 and TOR-2 to reduce the ARP packets entering the VXLAN.
HOST	<p>Configuring the IP address and gateway according to Figure 2- 28 (the detailed configuration on the server is omitted herein).</p>
TOR1	<pre> TOR1# configure terminal Enter configuration commands, one per line. End with CNTL/Z. TOR1(config)# interface Loopback 1 TOR1(config-if- Loopback 1)# ip address 1.1.1.1/32 TOR1(config-if- Loopback 1)# exit TOR1(config)# vtep TOR1(config-vtep)# source loopback 1 TOR1(config-vtep)# arp suppress enable TOR1(config)# fabric anycast-gateway-mac 001 1.2233.2016 TOR1(config-vtep)# exit TOR1(config)# ip vrf vrf-10 TOR1(config-vrf)# rd 10:10 TOR1(config-vrf)# route-target export 1000:1000 TOR1(config-vrf)# exit TOR1(config)# ip vrf vrf-20 TOR1(config-vrf)# rd 20:20 TOR1(config-vrf)# route-target export 2000:2000 TOR1(config-vrf)# exit TOR1(config)# int overlayrouter 10 TOR1(config-if-OverlayRouter 10)# ip vrf forwarding vrf-10 TOR1(config-if-OverlayRouter 10)# ip address 10.1.1.1/24 TOR1(config-if-OverlayRouter 10)# anycast-gateway TOR1(config-if-OverlayRouter 10)# exit TOR1(config-vxlan)# exit TOR1(config)# int overlayrouter 20 </pre>

```
TOR1(config-if-OverlayRouter 20)# ip vrf forwarding vrf-10
TOR1(config-if-OverlayRouter 20)# ip address 20.1.1.1/24
TOR1(config-if-OverlayRouter 20)# anycast-gateway
TOR1(config-if-OverlayRouter 20)# exit
TOR1(config)# int overlayrouter 30
TOR1(config-if-OverlayRouter 30)# ip vrf forwarding vrf-20
TOR1(config-if-OverlayRouter 30)# ip address 30.1.1.1/24
TOR1(config-if-OverlayRouter 30)# anycast-gateway
TOR1(config-if-OverlayRouter 30)# exit
TOR1(config)# int overlayrouter 100
TOR1(config-if-OverlayRouter 100)# ip vrf forwarding vrf-10
TOR1(config-if-OverlayRouter 100)# ip address 100.1.4.1/24
TOR1(config-if-OverlayRouter 100)# exit
TOR1(config)# int overlayrouter 200
TOR1(config-if-OverlayRouter 200)# ip vrf forwarding vrf-20
TOR1(config-if-OverlayRouter 200)# ip address 200.1.4.1/24
TOR1(config-if-OverlayRouter 200)# exit
TOR1(config)# vxlan 10
TOR1(config-vxlan)# extend-vlan 10
TOR1(config-vxlan)# router-interface OverlayRouter 10
TOR1(config-vxlan)# arp suppress enable
TOR1(config-vxlan)# exit
TOR1(config)# vxlan 20
TOR1(config-vxlan)# extend-vlan 20
TOR1(config-vxlan)# router-interface OverlayRouter 20
TOR1(config-vxlan)# arp suppress enable
TOR1(config-vxlan)# exit
TOR1(config)# vxlan 100
TOR1(config-vxlan)# symmetric
TOR1(config-vxlan)# router-interface OverlayRouter 100
TOR1(config)# vxlan 30
TOR1(config-vxlan)# extend-vlan 30
TOR1(config-vxlan)# router-interface OverlayRouter 30
TOR1(config-vxlan)# arp suppress enable
TOR1(config-vxlan)# exit
TOR1(config)# vxlan 200
TOR1(config-vxlan)# symmetric
TOR1(config-vxlan)# router-interface OverlayRouter 200
TOR1(config-vxlan)# exit
TOR1(config)# router bgp 64512
TOR1(config-router)# neighbor 2.2.2.2 remote-as 64512
TOR1(config-router)# neighbor 2.2.2.2 update-source loopback 1
TOR1(config-router)# neighbor 3.3.3.3 remote-as 64512
TOR1(config-router)# neighbor 3.3.3.3 update-source loopback 1
```

	<pre> TOR1(config-router)# neighbor 4.4.4.4 remote-as 64512 TOR1(config-router)# neighbor 4.4.4.4 update-source loopback 1 TOR1(config-router)# address-family l2vpn evpn TOR1(config-router-af)# neighbor 2.2.2.2 activate TOR1(config-router-af)# neighbor 3.3.3.3 activate TOR1(config-router-af)# neighbor 4.4.4.4 activate TOR1(config-router-af)# advertise ipv4 unicast TOR1(config-router-af)# exit TOR1(config-router)# address-family ipv4 vrf vrf-10 TOR1(config-router-af)# redistribute connected TOR1(config-router-af)# exit TOR1(config-router)# address-family ipv4 vrf vrf-20 TOR1(config-router-af)# redistribute connected TOR1(config-router-af)# exit TOR1(config-router)# exit TOR1(config)# evpn TOR1(config-evpn)# vni 10 TOR1(config-evpn-vni)# rd auto TOR1(config-evpn-vni)# route-target both auto TOR1(config-evpn-vni)# exit TOR1(config-evpn)# vni 20 TOR1(config-evpn-vni)# rd auto TOR1(config-evpn-vni)# route-target both auto TOR1(config-evpn-vni)# exit TOR1(config-evpn)# vni 30 TOR1(config-evpn-vni)# rd auto TOR1(config-evpn-vni)# route-target both auto TOR1(config-evpn-vni)# exit TOR1(config-evpn)# vni 100 TOR1(config-evpn-vni)# rd auto TOR1(config-evpn-vni)# route-target both auto TOR2(config-evpn-vni)# route-target import 1000:1000 TOR1(config-evpn-vni)# exit TOR1(config-evpn)# vni 200 TOR1(config-evpn-vni)# rd auto TOR1(config-evpn-vni)# route-target both auto TOR1(config-evpn-vni)# route-target import 2000:2000 TOR1(config-evpn-vni)# exit </pre>
TOR2	<pre> TOR2# configure terminal Enter configuration commands, one per line. End with CNTL/Z. TOR2(config)# interface Loopback 1 TOR2(config-if- Loopback 1)# ip address 2.2.2.2/32 TOR2(config-if- Loopback 1)# exit </pre>

```
TOR2(config)# vtep
TOR2(config-vtep)# source loopback 1
TOR2(config-vtep)# arp suppress enable
TOR2(config-vtep)# exit
TOR2(config)# fabric anycast-gateway-mac 0011.2233.2016
TOR2(config)# ip vrf vrf-10
TOR2(config-vrf)# rd 10:10
TOR2(config-vrf)# route-target export 1000:1000
TOR2(config-vrf)# exit
TOR2(config)# ip vrf vrf-20
TOR2(config-vrf)# rd 20:20
TOR2(config-vrf)# route-target export 2000:2000
TOR2(config-vrf)# exit
TOR2(config)# int overlayrouter 10
TOR2(config-if-OverlayRouter 10)# ip vrf forwarding vrf-10
TOR2(config-if-OverlayRouter 10)# ip address 10.1.1.1/24
TOR2(config-if-OverlayRouter 10)# anycast-gateway
TOR2(config-if-OverlayRouter 10)# exit
TOR2(config)# int overlayrouter 20
TOR2(config-if-OverlayRouter 20)# ip vrf forwarding vrf-10
TOR2(config-if-OverlayRouter 20)# ip address 20.1.1.1/24
TOR2(config-if-OverlayRouter 20)# anycast-gateway
TOR2(config-if-OverlayRouter 20)# exit
TOR2(config)# int overlayrouter 100
TOR2(config-if-OverlayRouter 100)# ip vrf forwarding vrf-10
TOR2(config-if-OverlayRouter 100)# ip address 100.1.3.1/24
TOR2(config-if-OverlayRouter 100)# exit
TOR2(config)# int overlayrouter 30
TOR2(config-if-OverlayRouter 30)# ip vrf forwarding vrf-20
TOR2(config-if-OverlayRouter 30)# ip address 30.1.1.1/24
TOR2(config-if-OverlayRouter 30)# anycast-gateway
TOR2(config-if-OverlayRouter 30)# exit
TOR2(config)# vxlan 30
TOR2(config-vxlan)# router-interface OverlayRouter 30
TOR2(config)# int overlayrouter 200
TOR2(config-if-OverlayRouter 200)# ip vrf forwarding vrf-20
TOR2(config-if-OverlayRouter 200)# ip address 200.1.3.1/24
TOR2(config-if-OverlayRouter 200)# exit
TOR2(config)# vxlan 10
TOR2(config-vxlan)# extend-vlan 10
TOR2(config-vxlan)# router-interface OverlayRouter 10
TOR2(config-vxlan)# arp suppress enable
TOR2(config-vxlan)# exit
TOR2(config)# vxlan 20
```

```
TOR2(config-vxlan)# extend-vlan 20
TOR2(config-vxlan)# router-interface OverlayRouter 20
TOR2(config-vxlan)# arp suppress enable
TOR2(config-vxlan)# exit
TOR2(config)# vxlan 100
TOR2(config-vxlan)# symmetric
TOR2(config-vxlan)# router-interface OverlayRouter 100
TOR2(config-vxlan)# exit
TOR2(config)# vxlan 30
TOR2(config-vxlan)# extend-vlan 30
TOR2(config-vxlan)# router-interface OverlayRouter 30
TOR2(config-vxlan)# arp suppress enable
TOR2(config-vxlan)# exit
TOR2(config)# vxlan 200
TOR2(config-vxlan)# symmetric
TOR2(config-vxlan)# router-interface OverlayRouter 200
TOR2(config-vxlan)# exit
TOR2(config)# router bgp 64512
TOR2(config-router)# neighbor 1.1.1.1 remote-as 64512
TOR2(config-router)# neighbor 1.1.1.1 update-source loopback 1
TOR2(config-router)# neighbor 3.3.3.3 remote-as 64512
TOR2(config-router)# neighbor 3.3.3.3 update-source loopback 1
TOR2(config-router)# neighbor 4.4.4.4 remote-as 64512
TOR2(config-router)# neighbor 4.4.4.4 update-source loopback 1
TOR2(config-router)# address-family l2vpn evpn
TOR2(config-router-af)# neighbor 1.1.1.1 activate
TOR2(config-router-af)# neighbor 3.3.3.3 activate
TOR2(config-router-af)# neighbor 4.4.4.4 activate
TOR2(config-router-af)# advertise ipv4 unicast
TOR2(config-router-af)# exit
TOR2(config-router)# address-family ipv4 vrf vrf-10
TOR2(config-router-af)# redistribute connected
TOR2(config-router-af)# exit
TOR2(config-router)# address-family ipv4 vrf vrf-20
TOR2(config-router-af)# redistribute connected
TOR2(config-router-af)# exit
TOR2(config-router)# exit
TOR2(config)# evpn
TOR2(config-evpn)# vni 10
TOR2(config-evpn-vni)# rd auto
TOR2(config-evpn-vni)# route-target both auto
TOR2(config-evpn-vni)# exit
TOR2(config-evpn)# vni 20
TOR2(config-evpn-vni)# rd auto
```

	<pre> TOR2(config-evpn-vni)# route-target both auto TOR2(config-evpn-vni)# exit TOR2(config-evpn)# vni 30 TOR2(config-evpn-vni)# rd auto TOR2(config-evpn-vni)# route-target both auto TOR2(config-evpn-vni)# exit TOR2(config-evpn)# vni 100 TOR2(config-evpn-vni)# rd auto TOR2(config-evpn-vni)# route-target both auto TOR2(config-evpn-vni)# route-target import 1000:1000 TOR2(config-evpn-vni)# exit TOR2(config-evpn)# vni 200 TOR2(config-evpn-vni)# rd auto TOR2(config-evpn-vni)# route-target both auto TOR2(config-evpn-vni)# route-target import 2000:2000 TOR2(config-evpn-vni)# exit </pre>
Border1	<pre> Border1# configure terminal Enter configuration commands, one per line. End with CNTL/Z. Border1(config)# interface Loopback 1 Border1(config-if- Loopback 1)# ip address 3.3.3.3/32 Border1(config-if- Loopback 1)# exit Border1(config)# vtep Border1(config-vtep)# source loopback 1 Border1(config-vtep)# arp suppress enable Border1(config-vtep)# exit Border1(config)# fabric anycast-gateway-mac 0011.2233.2016 Border1(config)# ip vrf vrf-10 Border1(config-vrf)# rd 10:10 Border1(config-vrf)# route-target export 1000:1000 Border1(config-vrf)# route-target import 3000:3000 Border1(config-vrf)# exit Border1(config)# ip vrf vrf-20 Border1(config-vrf)# rd 20:20 Border1(config-vrf)# route-target export 2000:2000 Border1(config-vrf)# route-target import 3000:3000 Border1(config-vrf)# exit Border1(config)# ip vrf vrf-30 Border1(config-vrf)# rd 30:30 Border1(config-vrf)# route-target export 3000:3000 Border1(config-vrf)# route-target import 1000:1000 Border1(config-vrf)# route-target import 2000:2000 Border1(config-vrf)# exit Border1(config)# int overlayrouter 90 Border1(config-if-OverlayRouter 90)# ip vrf forwarding vrf-30 </pre>

```
Border1(config-if-OverlayRouter 90)# ip address 90.1.1.1/24
Border1(config-if-OverlayRouter 90)# anycast-gateway
Border1(config-if-OverlayRouter 90)# exit
Border1(config)# int overlayrouter 100
Border1(config-if-OverlayRouter 100)# ip vrf forwarding vrf-10
Border1(config-if-OverlayRouter 100)# ip address 100.1.1.1/24
Border1(config-if-OverlayRouter 100)# exit
Border1(config)# int overlayrouter 200
Border1(config-if-OverlayRouter 200)# ip vrf forwarding vrf-20
Border1(config-if-OverlayRouter 200)# ip address 200.1.1.1/24
Border1(config-if-OverlayRouter 200)# exit
Border1(config)# vxlan 90
Border1(config-vxlan)# extend-vlan 90
Border1(config-vxlan)# router-interface OverlayRouter 90
Border1(config-vxlan)# arp suppress enable
Border1(config-vxlan)# exit
Border1(config)# vxlan 100
Border1(config-vxlan)# symmetric
Border1(config-vxlan)# router-interface OverlayRouter 100
Border1(config-vxlan)# exit
Border1(config)# vxlan 200
Border1(config-vxlan)# symmetric
Border1(config-vxlan)# router-interface OverlayRouter 200
Border1(config-vxlan)# exit
Border1(config)# router bgp 64512
Border1(config-router)# neighbor 1.1.1.1 remote-as 64512
Border1(config-router)# neighbor 1.1.1.1 update-source loopback 1
Border1(config-router)# neighbor 2.2.2.2 remote-as 64512
Border1(config-router)# neighbor 2.2.2.2 update-source loopback 1
Border1(config-router)# neighbor 4.4.4.4 remote-as 64512
Border1(config-router)# neighbor 4.4.4.4 update-source loopback 1
Border1(config-router)# address-family l2vpn evpn
Border1(config-router-af)# neighbor 1.1.1.1 activate
Border1(config-router-af)# neighbor 2.2.2.2 activate
Border1(config-router-af)# neighbor 4.4.4.4 activate
Border1(config-router-af)# advertise ipv4 unicast
Border1(config-router-af)# exit
Border1(config-router)# address-family ipv4 vrf vrf-10
Border1(config-router-af)# exit
Border1(config-router)# address-family ipv4 vrf vrf-20
Border1(config-router-af)# exit
Border1(config-router)# address-family ipv4 vrf vrf-30
Border1(config-router-af)# redistribute static
Border1(config-router-af)# exit
```

	<pre> Border1(config-router)# exit Border1(config)# evpn Border1(config-evpn)# vni 100 Border1(config-evpn-vni)# rd auto Border1(config-evpn-vni)# route-target both auto Border1(config-evpn-vni)# route-target import 3000:3000 Border1(config-evpn-vni)# exit Border1(config-evpn)# vni 200 Border1(config-evpn-vni)# rd auto Border1(config-evpn-vni)# route-target both auto Border1(config-evpn-vni)# route-target import 3000:3000 Border1(config-evpn-vni)# exit </pre>
Border2	<pre> Border2# configure terminal Enter configuration commands, one per line. End with CNTL/Z. Border2(config)# interface Loopback 1 Border2(config-if- Loopback 1)# ip address 4.4.4.4/32 Border2(config-if- Loopback 1)# exit Border2(config)# vtep Border2(config-vtep)# source loopback 1 Border2(config-vtep)# arp suppress enable Border2(config-vtep)# exit Border2(config)# fabric anycast-gateway-mac 0011.2233.2016 Border2(config)# ip vrf vrf-10 Border2(config-vrf)# rd 10:10 Border2(config-vrf)# route-target export 1000:1000 Border2(config-vrf)# route-target import 3000:3000 Border2(config-vrf)# exit Border2(config)# ip vrf vrf-20 Border2(config-vrf)# rd 20:20 Border2(config-vrf)# route-target export 2000:2000 Border2(config-vrf)# route-target import 3000:3000 Border2(config-vrf)# exit Border2(config)# ip vrf vrf-30 Border2(config-vrf)# rd 30:30 Border2(config-vrf)# route-target export 3000:3000 Border2(config-vrf)# route-target import 1000:1000 Border2(config-vrf)# route-target import 2000:2000 Border2(config-vrf)# exit Border2(config)# int overlayrouter 90 Border2(config-if-OverlayRouter 90)# ip vrf forwarding vrf-30 Border2(config-if-OverlayRouter 90)# ip address 90.1.2.1/24 Border2(config-if-OverlayRouter 90)# anycast-gateway Border2(config-if-OverlayRouter 90)# exit Border2(config)# int overlayrouter 100 </pre>

```
Border2(config-if-OverlayRouter 100)# ip vrf forwarding vrf-10
Border2(config-if-OverlayRouter 100)# ip address 100.1.2.1/24
Border2(config-if-OverlayRouter 100)# exit
Border2(config)# int overlayrouter 200
Border2(config-if-OverlayRouter 200)# ip vrf forwarding vrf-20
Border2(config-if-OverlayRouter 200)# ip address 200.1.2.1/24
Border2(config-if-OverlayRouter 200)# exit
Border2(config)# vxlan 90
Border2(config-vxlan)# extend-vlan 90
Border2(config-vxlan)# router-interface OverlayRouter 90
Border2(config-vxlan)# arp suppress enable
Border2(config-vxlan)# exit
Border2(config)# vxlan 100
Border2(config-vxlan)# symmetric
Border2(config-vxlan)# router-interface OverlayRouter 100
Border2(config-vxlan)# exit
Border2(config)# vxlan 200
Border2(config-vxlan)# symmetric
Border2(config-vxlan)# router-interface OverlayRouter 200
Border2(config-vxlan)# exit
Border2(config)# router bgp 64512
Border2(config-router)# neighbor 1.1.1.1 remote-as 64512
Border2(config-router)# neighbor 1.1.1.1 update-source loopback 1
Border2(config-router)# neighbor 2.2.2.2 remote-as 64512
Border2(config-router)# neighbor 2.2.2.2 update-source loopback 1
Border2(config-router)# neighbor 3.3.3.3 remote-as 64512
Border2(config-router)# neighbor 3.3.3.3 update-source loopback 1
Border2(config-router)# address-family l2vpn evpn
Border2(config-router-af)# neighbor 1.1.1.1 activate
Border2(config-router-af)# neighbor 2.2.2.2 activate
Border2(config-router-af)# neighbor 3.3.3.3 activate
Border2(config-router-af)# advertise ipv4 unicast
Border2(config-router-af)# exit
Border2(config-router)# address-family ipv4 vrf vrf-10
Border2(config-router-af)# exit
Border2(config-router)# address-family ipv4 vrf vrf-20
Border2(config-router-af)# exit
Border2(config-router)# address-family ipv4 vrf vrf-30
Border2(config-router-af)# redistribute static
Border2(config-router-af)# exit
Border2(config-router)# exit
Border2(config)# evpn
Border2(config-evpn)# vni 100
Border2(config-evpn-vni)# rd auto
```

	<pre> Border2(config-evpn-vni)# route-target both auto Border2(config-evpn-vni)# route-target import 3000:3000 Border2(config-evpn-vni)# exit Border2(config-evpn)# vni 200 Border2(config-evpn-vni)# rd auto Border2(config-evpn-vni)# route-target both auto Border2(config-evpn-vni)# route-target import 3000:3000 Border2(config-evpn-vni)# exit </pre>
<p>Verification</p>	<ul style="list-style-type: none"> ● Verify that HOST-1, HOST-2, and HOST-4 can ping each other. ● Verify that HOST-3 and HOST-6 can ping each other. ● Verify that HOST-1, HOST-2, and HOST-4 cannot ping HOST-3 and HOST-6. ● Verify that the virtual machines can be migrated between the HOSTs on the same VXLAN and can access the network normally after migration without modifying the configuration.
	<pre> Border1# sh vxlan VXLAN Total Count: 3 VXLAN Capacity : 8000 VXLAN 90 Symmetric property : FALSE Router Interface : overlayrouter 90 (anycast) Extend VLAN : 90 VTEP Adjacency Count: 1 VTEP Adjacency List : Interface Source IP Destination IP Type ----- OverlayTunnel 6146 3.3.3.3 2.2.2.2 dynamic VXLAN 100 Symmetric property : TRUE Router Interface : overlayrouter 100 (non-anycast) Extend VLAN : - VTEP Adjacency Count: 1 Interface Source IP Destination IP Type ----- OverlayTunnel 6146 3.3.3.3 2.2.2.2 dynamic VXLAN 200 Symmetric property : TRUE Router Interface : overlayrouter 200 (non-anycast) Extend VLAN : - VTEP Adjacency Count: 1 VTEP Adjacency List : Interface Source IP Destination IP Type </pre>

	OverlayTunnel 6146 3.3.3.3 2.2.2.2 dynamic

2.4.3 Configuring an EVPN Distributed Network to Be Compatible with Non-EVPN VTEP Devices

Configuration Effect

- Enable the control plane learning function to implement VXLAN tunnel learning, MAC address learning, and route learning via control plane protocols, thereby finally implementing VXLAN bridging, VXLAN routing, and data communication between VXLANs and between a VXLAN and an external network.
- Support functions such as anycast gateways, symmetric VXLAN instances, ARP suppression, and IPv6 ND suppression in EVPN control plane mode.
- Non-EVPN VTEP devices establish tunnels with EVPN-supported VTEP devices to implement the VXLAN bridging and forwarding function.

Notes

- VXLAN instances require the support from existing unicast routes on the network. Therefore, an IPv4 unicast routing protocol such as OSPF must be configured on the network devices.
- VXLAN needs the MP-BGP-EVPN protocol to implement VXLAN tunnel learning, MAC address learning, and route learning. Therefore, BGP must be configured on EVPN-supported network devices.

Configuration Steps

⌵ **Configuring a Loopback Interface Associated with the Local End**

- Mandatory for devices supporting the EVPN address family.
- Configure the IP address of a loopback interface as the IP address of the local VTEP. One device can be associated with only one loopback interface and the IP address of the loopback interface serves as the VXLAN VTEP IP address.
- If the L3 egress is an overlay router interface during static route configuration, the next-hop IP address cannot be set to the VTEP IP address.

⌵ **Configuring a Virtual MAC Address for Anycast Gateways**

- Optional.
- When anycast gateways are required, a unified virtual MAC address must be configured and used as the MAC address of the anycast gateways. The anycast function can be enabled on the VXLAN overlay router interfaces of the local device only after the virtual MAC address is configured.

⌵ **Configuring ARP Suppression**

- Optional.
- After ARP suppression is enabled, the VTEP device responds to ARP requests from hosts as a proxy, to reduce flooded ARP data on the network.

- ARP suppression is generally enabled on distributed gateways in distributed deployment scenarios.

↘ **Configuring ARP Proxy**

- Optional.
- After ARP suppression is enabled on a VTEP device, you can enable the ARP proxy function on an overlay router interface.
- After ARP proxy is enabled, the VTEP device responds to ARP requests from hosts as a proxy and the MAC address used for proxy response is the gateway MAC address configured on the VTEP device. In this way, the MAC address in the ARP request responses are the MAC address of the VTEP device, and the traffic between hosts in the same VNI is forwarded at L3.
- ARP proxy can be enabled only on VXLAN gateways and is generally enabled on distributed gateways in distributed deployment scenarios.

↘ **Configuring IPv6 ND Suppression**

- Optional.
- After IPv6 ND suppression is enabled, the VTEP device responds to NS multicast packets from hosts as a proxy, to reduce flooded NS multicast packets on the network.
- IPv6 ND suppression is generally enabled on distributed gateways in distributed deployment scenarios.

↘ **Configuring the EVPN Protocol Packet Control Function**

- In symmetric EVPN deployment scenarios, the EVPN protocol packet control function can be configured on TOR switches to reduce the traffic of EVPN packets.

Currently, the EVPN protocol packet control function includes the following:

- Extracting MAC entries from EVPN MAC-IP type-2 routes (ARP entries) on a L2-VPN VXLAN instance
- Extracting MAC entries from EVPN MAC-IPv6 type-2 routes (IPv6 ND entries) on a L2-VNI VXLAN instance
- Banning synchronization of the local MAC address to the remote VTEP through EVPN messages on an L2-VNI VXLAN instance
- Banning delivery of the MAC addresses remotely synchronized through EVPN messages to the local MAC address table on an L2-VNI VXLAN instance
- Stopping an L2-VNI VXLAN instance from generating EVPN type-2 routes

↘ **Creating a VXLAN Instance**

- Mandatory.

↘ **Associating the VXLAN Instance with an Overlay Router Interface**

- Mandatory for VXLAN gateways.
- The device supports the VXLAN routing function and can serve as a VXLAN IP gateway only after the VXLAN is associated with an overlay router interface.

↘ **Associating the VXLAN Instance with a VLAN**

- Mandatory for VXLAN devices directly connected to hosts.
- Packets of a VLAN are encapsulated into VXLAN packets for forwarding only after the VLAN is associated with a VXLAN instance.

- After a VLAN is associated with a VXLAN, all packets of the VLAN will be encapsulated into VXLAN packets. Therefore, an SVI on the device cannot be used as the IP gateway of the VLAN.

↘ **Configuring Overlay Tunnels**

- Mandatory for a VTEP not supporting EVPN and devices that directly communicate with the VTEP.
- The type of tunnels mutually established by two VTEP devices must be the same. The tunnels are those delivered by the SDN controller, statically configured on the CLI, or auto-discovered by EVPN.

↘ **Configuring the Source and Destination IP Addresses for Overlay Tunnels**

- Mandatory for a VTEP not supporting EVPN and devices that directly communicate with the VTEP.

↘ **Associating the VXLAN Instance with the Overlay Tunnels**

- Mandatory for a VTEP not supporting EVPN and devices that directly communicate with the VTEP.
- This command is used to statically specify VXLAN tunnels.

↘ **Configuring Storm Control for the VXLAN Instance**

- Optional.
- This function is required only when the storm rate needs to be limited for a VXLAN instance.

↘ **Configuring the VXLAN UDP Destination Port**

- Optional. The VXLAN UDP destination port used by early devices may not be port 4789. You can run this command to achieve compatibility. In addition, you can also run this command to specify the VXLAN UDP destination port.
- The VXLAN UDP destination port 4789 designated by IANA is used by default.

↘ **Configuring Symmetric Instances**

- Optional.
- Symmetric instances need to be configured only in symmetric scenarios. Only one symmetric instance can be configured in each VRF instance. After a symmetric instance is configured in a VRF instance, L3 forwarding in other asymmetric instances is switched to the symmetric instance.

↘ **Configuring VXLAN Static Routes**

- Optional.
- Configure VXLAN static routes for VXLAN instances if required.

↘ **Configuring the Synchronization of MAC Entries Whose Egresses Are Static Tunnels**

- Optional.
- Configure this function when MAC entries with the egress of static tunnels need to be synchronized externally.

↘ **Configuring the Synchronization of ARP Entries Whose Egresses Are Static Tunnels**

- Optional.
- Configure this function when ARP entries with the egress of static tunnels need to be synchronized externally.

Verification

The device can establish VXLAN tunnels and obtain VXLAN MAC entries and VXLAN routing entries via EVPN control plane learning. The tunnels and entries can be those delivered by the SDN controller or statically configured on the CLI. They implement the inter-VTEP communication. Run the following commands for verification.

- Run the **show vxlan vni-number** command to check whether the local and remote VXLAN devices learn the peer VTEP neighbor relationships.
- Run the **show vxlan mac** to check whether the VXLAN MAC addresses are learned.
- Run the **show arp** command to check whether the ARP entry of the VXLAN IP gateway is learned.
- Run the **show ipv6 neighbors** command to check whether all local/remote IPv6 ND entries are learned.
- Run the **show vxlan udp-port** command to display the VXLAN UDP destination port.

Related Commands

↘ Configuring a Loopback Interface Associated with the Local End

Command	source loopback loopback-port-id
Parameter Description	<i>loopback-port-id</i> : Indicates the ID of the loopback interface.
Command Mode	VTEP configuration mode
Usage Guide	The local VETP IP address is the IP address of the configured loopback interface.

↘ Configuring a Virtual MAC Address for Anycast Gateways

Command	fabric anycast-gateway-mac mac-addr
Parameter Description	<i>mac-addr</i> : Indicates the MAC address in the format of <i>xxxx.xxxx.xxxx</i> .
Command Mode	Global configuration mode
Usage Guide	All gateways on which the anycast function is enabled use this MAC address as the gateway MAC address. The virtual MAC address for anycast gateways cannot be set to the local MAC address or the MAC address of any device on the overlay network.

↘ Configuring Remote ARP Packet Learning

Command	remote arp learn enable
Parameter Description	N/A
Command Mode	VTEP configuration mode
Usage Guide	Enable or disable the remote ARP packet learning function globally. After this function is enabled, the VXLAN gateways will learn ARP entries from the VXLAN-encapsulated ARP packets received from VXLAN tunnels.

↘ Configuring Remote IPv6 ND Protocol Packet Learning

Command	remote nd learn enable
----------------	-------------------------------

Parameter Description	N/A
Command Mode	VTEP configuration mode
Usage Guide	Enable or disable the remote IPv6 ND packet learning function globally. After this function is enabled, the device can learn IPv6 ND entries from the VXLAN-encapsulated IPv6 NS packets received from VXLAN tunnels.

↘ Configuring Global ARP Suppression

Command	arp suppress enable
Parameter Description	N/A
Command Mode	VTEP configuration mode
Usage Guide	Enable or disable the global ARP suppression function. After ARP suppression is enabled, the switch responds to ARP requests from hosts as a proxy. The VNI-based ARP suppression may be also supported, depending on the product type. You can configure global ARP suppression or VNI-based ARP suppression based on the actual application scenario.

↘ Configuring VNI-based ARP Suppression

Command	arp suppress enable
Parameter Description	N/A
Command Mode	VXLAN configuration mode
Usage Guide	Enable or disable VNI-based ARP suppression. After ARP suppression is enabled, the switch responds to ARP requests from hosts as a proxy. The global ARP suppression may be also supported, depending on the product type. You can configure global ARP suppression or VNI-based ARP suppression based on the actual application scenario.

↘ Configuring ARP Proxy

Command	route-in-vni
Parameter Description	N/A
Command Mode	Overlay router interface configuration mode
Usage Guide	After the intra-VNI routing function (ARP proxy) is enabled on an overlay router interface, the VTEP device uses its gateway MAC address to respond to all ARP requests from hosts in the VNI, to which the overlay router interface belongs, when serving as an ARP proxy. In this way, the communication traffic between hosts in the same VNI is forwarded through VXLAN routes.

↘ Configuring Global IPv6 ND Suppression

Command	nd suppress enable
Parameter Description	N/A
Command	VTEP configuration mode

Mode	
Usage Guide	Enable or disable the global IPv6 ND suppression function. After IPv6 ND suppression is enabled, the device responds to IPv6 NS multicast packets from hosts as a proxy. The VNI-based IPv6 ND suppression may be also supported, depending on the product type. You can configure global IPv6 ND suppression or VNI-based IPv6 ND suppression based on the actual application scenario.

↘ **Configuring VNI-based IPv6 ND Suppression**

Command	nd suppress enable
Parameter	N/A
Description	
Command Mode	VXLAN configuration mode
Usage Guide	Enable or disable the VNI-based IPv6 ND suppression function. After IPv6 ND suppression is enabled, the device responds to IPv6 NS multicast packets from hosts as a proxy. The global IPv6 ND suppression may be also supported, depending on the product type. You can configure global IPv6 ND suppression or VNI-based IPv6 ND suppression based on the actual application scenario.

↘ **Extracting MAC Entries from EVPN MAC-IP Type-2 Routes (ARP Entries)**

Command	evpn arp mac-learning enable
Parameter	N/A
Description	
Command Mode	VXLAN configuration mode
Usage Guide	<p>After this command is configured, the device parses one ARP entry and one MAC entry from a MAC-IP type-2 route synchronized from the VXLAN-EVPN neighbor.</p> <p>This command is disabled by default and the device parses one ARP entry but no MAC entry from a MAC-IP type-2 route synchronized from the VXLAN-EVPN neighbor.</p> <p>This command is configured on a VXLAN instance and affects only the EVPN entry parsing of the VXLAN instance. Other VXLAN instances, for which this command is not configured, are not affected.</p> <p>This command can be used in combination with the evpn mac advertise disable command. After they are executed, the network-wide VXLAN-EVPN neighbors synchronize only MAC-IP type-2 routes but no MAC-only type-2 routes. All devices parse and extract MAC entries from MAC-IP type-2 routes.</p> <p>In symmetric deployment scenarios, this command is configured on L3-VNI VXLAN instances (that is, symmetric instances).</p>

↘ **Extracting MAC Entries from EVPN MAC-IPv6 Type-2 Routes (IPv6 ND Entries)**

Command	evpn nd mac-learning enable
Parameter	N/A
Description	
Command Mode	VXLAN configuration mode
Usage Guide	After this command is configured, the device parses one IPv6 ND entry and one MAC entry from a MAC-IPv6 type-2 route (IPv6 ND entry) synchronized from the VXLAN-EVPN neighbor.

	<p>This command is disabled by default and the device parses one IPv6 ND entry but no MAC entry from a MAC-IPv6 type-2 route synchronized from the VXLAN-EVPN neighbor.</p> <p>This command is configured on a VXLAN instance and affects only the EVPN entry parsing of the VXLAN instance. Other VXLAN instances, for which this command is not configured, are not affected.</p> <p>This command can be used in combination with the evpn mac advertise disable command. After they are executed, the network-wide VXLAN-EVPN neighbors synchronize only MAC-IPv6 type-2 routes but no MAC-only type-2 routes. All devices parse and extract MAC entries from MAC-IPv6 type-2 routes.</p> <p>This command is configured on L2-VNI VXLAN instances.</p>
--	--

➤ **Configuring an L2-VNI VXLAN Instance Not to Synchronize the Local MAC Address to the Remote VTEP Through EVPN Messages**

Command	evpn mac advertise disable
Parameter Description	N/A
Command Mode	VXLAN configuration mode
Usage Guide	<p>This command is not configured on a device by default. The device generates one MAC-only type-2 route through the VXLAN-EVPN protocol based on a locally learned MAC entry, and synchronizes the type-2 route to the EVPN neighbor (that is, remote VTEP). Then, the remote VTEP can learn the MAC entry from the MAC-only type-2 route.</p> <p>After this command is configured, the device does not generate VXLAN-EVPN MAC-only type-2 routes based on MAC entries, and therefore, it will not advertise MAC-only type-2 routes to the EVPN neighbor.</p> <p>This command is configured on a VXLAN instance and affects only whether the VXLAN instance generates MAC-only type-2 routes. Other VXLAN instances, for which this command is not configured, can still generate MAC-only type-2 routes.</p> <p>This command can be used in combination with the evpn arp mac-learning enable and evpn nd mac-learning enable commands. After they are executed, the network-wide VXLAN-EVPN neighbors synchronize only MAC-IP type-2 routes but no MAC-only type-2 routes. All devices parse and extract MAC entries from MAC-IP or MAC-IPv6 type-2 routes.</p> <p>Note: This command can be configured only on L2-VNI VXLAN instances (that is, VXLAN instances with the symmetric command not configured). It is unavailable on L3-VNI VXLAN instances.</p>

➤ **Configuring an L2-VNI VXLAN Instance Not to Deliver MAC Addresses Remotely Synchronized Through EVPN Messages to the Local MAC Address Table**

Command	evpn mac inactive
Parameter Description	N/A
Command Mode	VXLAN configuration mode
Usage Guide	<p>After this command is configured, the device does not learn MAC entries from VXLAN-EVPN type-2 routes (MAC-IP or MAC-only type-2 routes) synchronized from neighbors.</p> <p>This command is not configured on a device by default. The device learns MAC entries from VXLAN-EVPN type-2 routes synchronized from neighbors.</p> <p>This command is configured on a VXLAN instance and affects only whether the VXLAN instance learns MAC entries from VXLAN-EVPN type-2 routes. Other VXLAN instances, for which this command is not configured, can still learn MAC entries.</p>

	Note: This command can be configured only on L2-VNI VXLAN instances (that is, VXLAN instances with the symmetric command not configured). It is unavailable on L3-VNI VXLAN instances.
--	---

➤ **Configuring an L2-VNI VXLAN Instance Not to Generate EVPN Type-2 Routes**

Command	evpn rt-2 advertise disable
Parameter Description	N/A
Command Mode	VXLAN configuration mode
Usage Guide	<p>This command is not configured on a device by default. The device generates one MAC-only type-2 route through the VXLAN-EVPN protocol based on a locally learned MAC entry, and synchronizes the type-2 route to the EVPN neighbor (that is, remote VTEP). Then, the remote VTEP learns the MAC entry from the MAC-only type-2 route. In addition, the device generates one MAC-IP type-2 route through the VXLAN-EVPN protocol based on a locally learned ARP entry and synchronizes the type-2 route to the EVPN neighbor. Then, the remote VTEP learns the ARP entry and host route from the MAC-IP type-2 route. The device generates one MAC-IPv6 type-2 route through the VXLAN-EVPN protocol based on a locally learned IPv6 ND entry, and synchronizes the type-2 route to the EVPN neighbor. Then, the remote VTEP learns the IPv6 ND entry and host route from the MAC-IPv6 type-2 route. After this command is configured, the MAC entries, ARP entries, and IPv6 ND entries of the device are not used to generate VXLAN-EVPN type-2 routes and therefore, no type-2 route is advertised to the EVPN neighbor.</p> <p>This command is configured on a VXLAN instance and affects only whether the VXLAN instance generates type-2 routes. Other VXLAN instances, for which this command is not configured, can still generate type-2 routes.</p> <p>Note: This command can be configured only on L2-VNI VXLAN instances (that is, VXLAN instances with the symmetric command not configured). It is unavailable on L3-VNI VXLAN instances.</p>

➤ **Creating an Overlay Router Interface**

Command	interface OverlayRouter <i>port-id</i>
Parameter Description	<i>port-id</i> : Indicates the ID of an overlay router interface.
Command Mode	Global configuration mode
Usage Guide	This interface serves as the VXLAN IP gateway in the VXLAN routing environment. It is similar to an SVI interface in a VLAN.

➤ **Configuring an IP Address for the Overlay Router Interface**

Command	ip address <i>ip-address mask</i>
Parameter Description	<i>ip-address</i> : Indicates the IP address of the overlay router interface. <i>mask</i> : Indicates the subnet mask.
Command Mode	Interface configuration mode
Usage Guide	This IP address serves as the VXLAN IP gateway address in the VXLAN routing environment. It is similar to the IP address of an SVI in a VLAN.

➤ **Configuring an IPv6 Address for the Overlay Router Interface**

Command	ipv6 address <i>ip-address mask</i>
Parameter Description	<i>ip-address</i> : Indicates the IPv6 address of the overlay router interface. <i>mask</i> : Indicates the subnet mask.
Command Mode	Overlay router interface configuration mode
Usage Guide	This IPv6 address serves as the VXLAN IPv6 gateway address in the VXLAN routing environment. It is similar to the IP address of an SVI in a VLAN.

↘ Associating the Overlay Router Interface with a VRF Instance

Command	vrf forwarding <i>table name</i>
Parameter Description	<i>table name</i> : Indicates the VRF instance, with which the overlay router interface is associated.
Command Mode	Interface configuration mode
Usage Guide	This command is used to associate with a VRF instance in the VXLAN routing environment and is used for VXLAN L3 routing isolation.

↘ Creating a VXLAN Instance or Entering the VXLAN Configuration Mode

Command	vxlan <i>vni-number</i>
Parameter Description	<i>vni-number</i> : Indicates the VNI. The value ranges from 1 to 16,777,215.
Command Mode	Global configuration mode
Usage Guide	N/A

↘ Configuring a Symmetric Instance

Command	symmetric
Parameter Description	N/A
Command Mode	VXLAN configuration mode
Usage Guide	No symmetric instance is configured by default. A symmetric instance is used to manage L3 forwarding entries of all asymmetric instances in the VRF instance associated with the symmetric instance.

↘ Associating the VXLAN Instance with the Overlay Router Interface

Command	router-interface <i>interface-name</i>
Parameter Description	<i>interface-name</i> : Indicates the name of the overlay router interface.
Command Mode	VXLAN configuration mode
Usage Guide	The overlay router interfaces between VXLANs cannot conflict with each other and different VXLANs cannot associate with the same overlay router interface.

↘ Creating an Overlay Tunnel Interface

Command	interface OverlayTunnel <i>port-id</i>
Parameter Description	<i>port-id</i> : Indicates the ID of an overlay tunnel interface.
Command Mode	Global configuration mode
Usage Guide	This interface is used to statically create an overlay tunnel. You can run the tunnel-interface command to associate it with a VXLAN.

↘ Configuring a Tunnel Source IP Address for the Overlay Tunnel Interface

Command	tunnel source <i>ip-address</i>
Parameter Description	<i>ip-address</i> : Indicates the tunnel source IP address.
Command Mode	Overlay tunnel interface configuration mode
Usage Guide	This command is used to specify the source IP address of an overlay tunnel. When packets are encapsulated and forwarded, the outer source IP address of the packets is the source IP address of an overlay tunnel.

↘ Configuring a Tunnel Destination IP Address for the Overlay Tunnel Interface

Command	tunnel destination <i>ip-address</i>
Parameter Description	<i>ip-address</i> : Indicates the tunnel destination IP address.
Command Mode	Overlay tunnel interface configuration mode
Usage Guide	This command is used to specify the destination IP address of an overlay tunnel. When packets are encapsulated and forwarded, the outer destination IP address of the packets is the destination IP address of an overlay tunnel. The tunnel destination IP address is unique globally. Different overlay tunnels cannot share the same destination IP address. Otherwise, a configuration conflict will occur.

↘ Associating the VXLAN Instance with the Overlay Tunnel Interface

Command	tunnel-interface <i>interface-name</i>
Parameter Description	<i>interface-name</i> : Indicates the name of an overlay tunnel interface.
Command Mode	VXLAN configuration mode
Usage Guide	This command is used to statically specify a VXLAN VTEP.

↘ Configuring the VXLAN UDP Destination Port

Command	vxlan udp-port <i>port-number</i>
Parameter Description	<i>port-number</i> : Indicates the UDP destination port ID. The value ranges from 0 to 65535 and the default value is 4789.
Command	Global configuration mode

Mode	
Usage Guide	The VXLAN UDP destination port cannot be set to a commonly used UDP port.

↘ **Configuring Storm Control for the VXLAN Instance**

Command	storm-control {broadcast multicast unicast} [kpbs-value pps pps-value]
Parameter	<i>kpbs-value</i> : Indicates the rate limit value, in kbit/s.
Description	<i>pps-value</i> : Indicates the rate limit value, in packets/second.
Command Mode	VXLAN configuration mode
Usage Guide	Configure this function when the storm rate needs to be limited based on the VNI.

↘ **Configuring the Synchronization of MAC Entries Whose Egresses Are Static Tunnels**

Command	evpn mac advertise enable
Parameter	N/A
Description	
Command Mode	Overlay tunnel interface configuration mode
Usage Guide	Configure this function when MAC entries with the egress of static tunnels need to be synchronized externally.

↘ **Configuring the Synchronization of ARP Entries Whose Egresses Are Static Tunnels**

Command	evpn macip advertise enable
Parameter	N/A
Description	
Command Mode	Overlay tunnel interface configuration mode
Usage Guide	Configure this function when ARP entries with the egress of static tunnels need to be synchronized externally.

↘ **Configuration Example**

- i Only configuration related to the VXLAN is described below.
- i Only IPv4 configuration is used as an example below and the IPv6 scenario configuration is largely the same as the IPv4 scenario configuration.

Detailed configuration of a full mesh network:

Scenario
Figure 2- 29

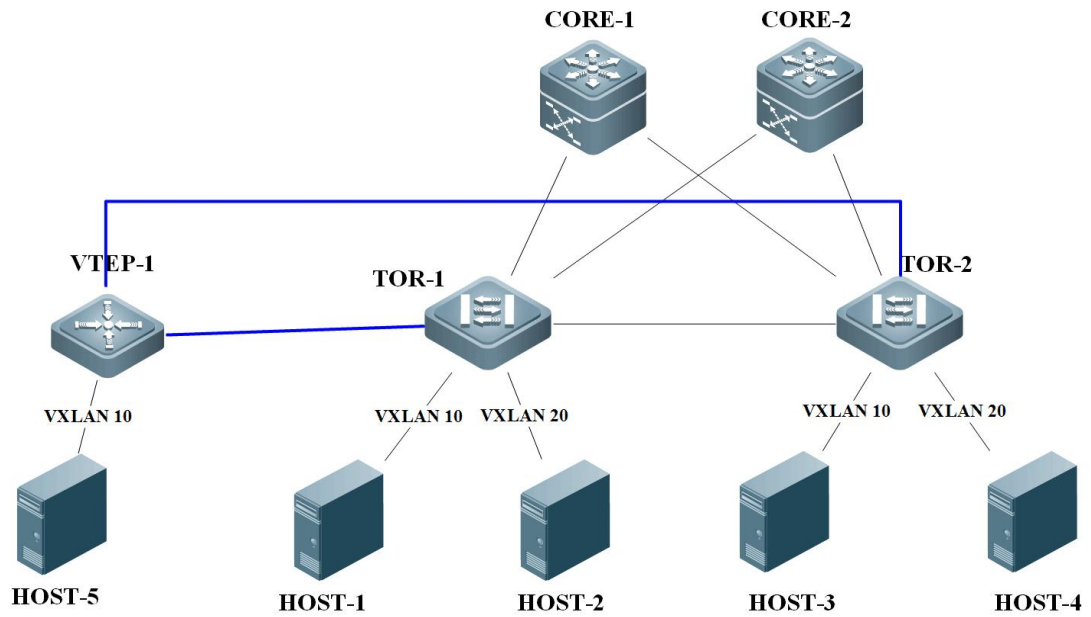

Note: Blue lines in the figure indicate the VXLAN tunnels that the manually configured VTEP-1 establishes with other VTEPs.

Configuration Steps

- Configure an IPv4 unicast routing protocol (such as OSPF) on core switches, TOR switches, and VTEP to ensure that unicast routes are reachable.
- Configure the BGP-EVPN routing protocol on the CORE and TOR switches to ensure that the four switches establish BGP neighbor relationships and support the EVPN protocol family.
- Configure EVI for BGP-EVPN on the core and TOR switches. For details, see the *BGP-EVPN Configuration Guide*.
- Configure VXLANs on the virtual servers and specify the gateway address for the virtual machines. (Omitted)
- Associate the VTEP with the loopback interface on TOR-1 and TOR-2 for the establishment of tunnels.
- Create VXLAN instances on TOR-1, TOR-2, and VTEP-1 and associate the VXLAN instances with VLANs.
- Configure the same anycast gateway MAC address on TOR-1 and TOR-2 so that the VXLAN anycast gateways on the TOR switches use the same virtual MAC address.
- Create overlay router interfaces on TOR-1 and TOR-2 and configure the VXLAN gateway IP address. Configure different VRF instances for the overlay router interfaces and determine their respective tenants.
Note that the overlay router interface configuration on TOR-1 and TOR-2 must be the same. That is, on all devices, the IP address and mask configured for the overlay router interfaces associated with the same VXLAN instance must be the same and such overlay router interfaces belong to the same tenant (VRF instance).
In addition, all overlay router interfaces must be configured as anycast gateways.
- Associate VXLAN instances with overlay router interfaces on TOR-1 and TOR-2 to implement VXLAN routing.
- Create VXLAN overlay tunnels on TOR-1, TOR-2, and VTEP-1 and configure the SIP and DIP.
- (Optional) Configure ARP suppression on TOR-1 and TOR-2 to reduce ARP packets flowing into the VXLAN.

HOST

The detailed configuration of the servers is omitted here. Configure the IP address and gateway according to the figure above.

CORE

VXLAN does not need to be configured on the core switches. The OSPF and BGP network configurations are omitted here.

TOR-1

```
TOR1# configure terminal
Enter configuration commands, one per line. End with CNTL/Z.
TOR1(config)# route-map dc
```

```
TOR1(config-route-map)# match route-type evpn-type-2
TOR1(config-route-map)# set next-hop 1.1.1.1
TOR1(config-route-map)# exit
TOR1(config)# interface Loopback 1
TOR1(config-if- Loopback 1)# ip address 1.1.1.1/32
TOR1(config-if- Loopback 1)# exit
TOR1(config)# vtep
TOR1(config-vtep)# source loopback 1
TOR1(config-vtep)# arp suppress enable
TOR1(config-vtep)# vxlan outside center vtep-ip 3.3.3.3
TOR1(config-vtep)# exit
TOR1(config)# fabric anycast-gateway-mac 0000.1234.5678
TOR1(config)# int overlayrouter 10
TOR1(config-if-OverlayRouter 10)# ip address 10.1.1.1/24
TOR1(config-if-OverlayRouter 10)# anycast-gateway
TOR1(config-if-OverlayRouter 10)# route-in-vni //Optional. It needs to be used in combination with the arp suppress enable command.
TOR1(config-if-OverlayRouter 10)# exit
TOR1(config)# int overlayrouter 20
TOR1(config-if-OverlayRouter 20)# ip address 10.1.2.1/24
TOR1(config-if-OverlayRouter 20)# anycast-gateway
TOR1(config-if-OverlayRouter 20)# route-in-vni
TOR1(config-if-OverlayRouter 20)# exit
TOR1(config)# int overlaytunnel 1
TOR1(config-if-OverlayTunnel 1)# tunnel source 1.1.1.1
TOR1(config-if-OverlayTunnel 1)# tunnel destination 3.3.3.3
TOR1(config-if-OverlayTunnel 1)# evpn mac advertise enable
TOR1(config-if-OverlayTunnel 1)# evpn macip advertise enable
TOR1(config-if-OverlayTunnel 1)# exit
TOR1(config)# vxlan 10
TOR1(config-vxlan)# extend-vlan 10
TOR1(config-vxlan)# router-interface OverlayRouter 10
TOR1(config-vxlan)# tunnel-interface overlaytunnel 1
TOR1(config-vxlan)# arp suppress enable
TOR1(config-vxlan)# exit
TOR1(config)# vxlan 20
TOR1(config-vxlan)# extend-vlan 20
TOR1(config-vxlan)# router-interface OverlayRouter 20
TOR1(config-vxlan)# arp suppress enable
TOR1(config-vxlan)# exit
TOR1(config)# router bgp 100
TOR1(config-router)# neighbor 2.2.2.2 remote-as 100
TOR1(config-router)# neighbor 2.2.2.2 update-source loopback 1
TOR1(config-router)# address-family l2vpn evpn
```

	<pre>TOR1(config-router-af)# neighbor 2.2.2.2 activate TOR1(config-router-af)# neighbor 2.2.2.2 route-map dc out TOR1(config-router-af)# exit TOR1(config-router)# exit TOR1(config)# evpn TOR1(config-evpn)# vni 10 TOR1(config-evpn-vni)# rd auto TOR1(config-evpn-vni)# route-target both auto TOR1(config-evpn-vni)# exit TOR1(config-evpn)# vni 20 TOR1(config-evpn-vni)# rd auto TOR1(config-evpn-vni)# route-target both auto TOR1(config-evpn-vni)# exit</pre>
<p>TOR-2</p>	<pre>TOR2# configure terminal Enter configuration commands, one per line. End with CNTL/Z. TOR2(config)# interface Loopback 1 TOR2(config-if- Loopback 1)# ip address 2.2.2.2/32 TOR2(config-if- Loopback 1)# exit TOR2(config)# vtep TOR2(config-vtep)# source loopback 1 TOR2(config-vtep)# arp suppress enable TOR2(config-vtep)# exit TOR2(config)# fabric anycast-gateway-mac 0000.1234.5678 TOR2(config)# int overlayrouter 10 TOR2(config-if-OverlayRouter 10)# ip address 10.1.1.1/24 TOR2(config-if-OverlayRouter 10)# anycast-gateway TOR2(config-if-OverlayRouter 10)# route-in-vni //Optional. It needs to be used in combination with the arp suppress enable command. TOR2(config-if-OverlayRouter 10)# exit TOR2(config)# int overlayrouter 20 TOR2(config-if-OverlayRouter 20)# ip address 10.1.2.1/24 TOR2(config-if-OverlayRouter 20)# anycast-gateway TOR2(config-if-OverlayRouter 20)# route-in-vni //Optional. It needs to be used in combination with the arp suppress enable command. TOR2(config-if-OverlayRouter 20)# exit TOR2(config)# vxlan 10 TOR2(config-vxlan)# extend-vlan 10 TOR2(config-vxlan)# router-interface OverlayRouter 10 TOR2(config-vxlan)# arp suppress enable TOR2(config-vxlan)# exit TOR2(config)# vxlan 20 TOR2(config-vxlan)# extend-vlan 20 TOR2(config-vxlan)# router-interface OverlayRouter 20 TOR2(config-vxlan)# arp suppress enable</pre>

	<pre>TOR2(config-vxlan)# exit TOR2(config)# router bgp 100 TOR2(config-router)# neighbor 1.1.1.1 remote-as 100 TOR2(config-router)# neighbor 1.1.1.1 update-source loopback 1 TOR2(config-router)# address-family l2vpn evpn TOR2(config-router-af)# neighbor 1.1.1.1 activate TOR2(config-router-af)# exit TOR2(config-router)# exit TOR2(config)# evpn TOR2(config-evpn)# vni 10 TOR2(config-evpn-vni)# rd auto TOR2(config-evpn-vni)# route-target both auto TOR2(config-evpn-vni)# exit TOR2(config-evpn)# vni 20 TOR2(config-evpn-vni)# rd auto TOR2(config-evpn-vni)# route-target both auto TOR2(config-evpn-vni)# exit</pre>
VTEP-1	<pre>VTEP1# configure terminal Enter configuration commands, one per line. End with CNTL/Z. VTEP1(config)# interface Loopback 1 VTEP1(config-if- Loopback 1)# ip address 3.3.3.3/32 VTEP1(config-if- Loopback 1)# exit VTEP1(config)# int overlaytunnel 1 VTEP1(config-if-OverlayTunnel 1)# tunnel source 3.3.3.3 VTEP1(config-if-OverlayTunnel 1)# tunnel destination 1.1.1.1 VTEP1(config-if-OverlayTunnel 1)# exit VTEP1(config)# vxlan 10 VTEP1(config-vxlan)# extend-vlan 10 VTEP1(config-vxlan)# tunnel-interface overlaytunnel 1</pre>
Verification	<ul style="list-style-type: none"> ● Verify that HOST-1, HOST-2, HOST-3, HOST-4, and HOST-5 can ping each other. ● Verify that virtual machines can be migrated between hosts in the same VXLAN and can access the network normally after migration, with no need to modify the configuration.
	<pre>TOR1# sho vxlan VXLAN Total Count: 2 VXLAN Capacity : 8000 VXLAN 10 Symmetric property : FALSE Router Interface : overlayrouter 10 (anycast) Extend VLAN : 10 VTEP Adjacency Count: 2 VTEP Adjacency List : Interface Source IP Destination IP Type -----</pre>

```

OverlayTunnel 1      1.1.1.1      3.3.3.3      static
OverlayTunnel 6145  1.1.1.1      2.2.2.2      dynamic

VXLAN 20
Symmetric property  : FALSE
Router Interface   : overlayrouter 20 (anycast)
Extend VLAN       : 20
VTEP Adjacency Count: 1
VTEP Adjacency List :
Interface          Source IP      Destination IP Type
-----
OverlayTunnel 6145  1.1.1.1      2.2.2.2      dynamic

TOR2# sho vxlan
VXLAN Total Count: 2
VXLAN Capacity   : 8000

VXLAN 10
Symmetric property  : FALSE
Router Interface   : overlayrouter 10 (anycast)
Extend VLAN       : 10
VTEP Adjacency Count: 2
VTEP Adjacency List :
Interface          Source IP      Destination IP Type
-----
OverlayTunnel 1      2.2.2.2      3.3.3.3      static
OverlayTunnel 6145  2.2.2.2      1.1.1.1      dynamic

VXLAN 20
Symmetric property  : FALSE
Router Interface   : overlayrouter 20 (anycast)
Extend VLAN       : 20
VTEP Adjacency Count: 1
VTEP Adjacency List :
Interface          Source IP      Destination IP Type
-----
OverlayTunnel 6145  2.2.2.2      1.1.1.1      dynamic

VTEP1# sho vxlan
VXLAN Total Count: 1
VXLAN Capacity   : 8000
    
```

VXLAN 10			
Symmetric property : FALSE			
Router Interface :-			
Extend VLAN : 10			
VTEP Adjacency Count: 2			
VTEP Adjacency List :			
Interface	Source IP	Destination IP	Type

OverlayTunnel 1	3.3.3.3	1.1.1.1	static
OverlayTunnel 2	3.3.3.3	2.2.2.2	static

2.4.4 Configuring L2 Subinterfaces to Access a VXLAN

Configuration Effect

- Configure hosts to access a VXLAN through L2 subinterfaces.
- L2 subinterfaces can access a VXLAN in VLAN encapsulation or untagged encapsulation mode.

Notes

- If the main interface is a trunk interface, the subinterfaces are not recommended to access a VXLAN in untagged encapsulation mode due to chip limitations. If the untagged encapsulation mode is configured for the subinterfaces, tagged packets are transferred to the logic of subinterfaces using the untagged packaging mode.
- The extend-VLAN configured for a VXLAN instance is like the VLAN or untagged encapsulation rule configured for a subinterface. When a subinterface is available, the encapsulation rule of the subinterface has a higher priority than the extend-VLAN configured for a VXLAN instance.

Configuration Steps

➤ Configuring the VXLAN Encapsulation Rule for a Subinterface

- Mandatory.
- Configure the VXLAN encapsulation rule for a specified subinterface.

➤ Configuring the VLAN and Untagged Encapsulation Rules for a Subinterface

- Mandatory.
- L2 subinterfaces can access a VXLAN in VLAN encapsulation or untagged encapsulation mode.

➤ Creating a VXLAN Instance

- Mandatory.

➤ Associating the VXLAN Instance with an Overlay Router Interface

- Mandatory for VXLAN gateways.
- The device supports the VXLAN routing function and can serve as a VXLAN IP gateway only after the VXLAN is associated with an overlay router interface.

Verification

L2 subinterfaces can access the VXLAN. Run the following commands for verification.

- Run the **show vxlan vni-number** command to check the local configuration of the VXLAN.
- Run the **show vxlan mac** to check whether the VXLAN MAC addresses are learned.
- Run the **show arp** command to check whether the ARP entry of the VXLAN IP gateway is learned.
- Run the **show ipv6 neighbors** command to check whether all local/remote IPv6 ND entries are learned.
- Run the **show running** command to display the subinterface configuration.

Related Commands

▾ **Configuring the VXLAN Encapsulation Rule for a Subinterface**

Command	encapsulation vxlan vni-number
Parameter Description	<i>vni-number</i> : Indicates the VNI. The value ranges from 1 to 16,777,215.
Command Mode	L2 subinterface configuration mode
Usage Guide	1. Only one VXLAN encapsulation rule can be configured for one subinterface. 2. You can preconfigure VXLAN encapsulation rules when no VXLAN instance exists.

▾ **Configuring the VLAN and Untagged Encapsulation Rules for a Subinterface**

Command	encapsulation dot1q {untag s-vid vlan-id}
Parameter Description	{ untag s-vid vlan-id }: Specifies VLAN encapsulation or untagged encapsulation for a port. The VLAN ID ranges from 1 to 4094 when VLAN encapsulation is adopted.
Command Mode	L2 subinterface configuration mode
Usage Guide	If the main interface is a trunk interface, the subinterfaces are not recommended to access a VXLAN in untagged encapsulation mode due to chip limitations. If the untagged encapsulation mode is configured for the subinterfaces, tagged packets are transferred to the logic of subinterfaces using the untagged packaging mode.

▾ **Creating an Overlay Router Interface**

Command	interface OverlayRouter port-id
Parameter Description	<i>port-id</i> : Indicates the ID of an overlay router interface.
Command Mode	Global configuration mode
Usage Guide	This interface serves as the VXLAN IP gateway in the VXLAN routing environment. It is similar to an SVI interface in a VLAN.

▾ **Configuring an IP Address for the Overlay Router Interface**

Command	ip address ip-address mask
Parameter Description	<i>ip-address</i> : Indicates the IP address of the overlay router interface. <i>mask</i> : Indicates the subnet mask.
Command Mode	Interface configuration mode

Usage Guide	This IP address serves as the VXLAN IP gateway address in the VXLAN routing environment. It is similar to the IP address of an SVI in a VLAN.
--------------------	---

↘ Configuring an IPv6 Address for the Overlay Router Interface

Command	ipv6 address <i>ip-address mask</i>
Parameter Description	<i>ip-address</i> : Indicates the IPv6 address of the overlay router interface. <i>mask</i> : Indicates the subnet mask.
Command Mode	Overlay router interface configuration mode
Usage Guide	This IPv6 address serves as the VXLAN IPv6 gateway address in the VXLAN routing environment. It is similar to the IP address of an SVI in a VLAN.

↘ Associating the Overlay Router Interface with a VRF Instance

Command	vrf forwarding <i>table name</i>
Parameter Description	<i>table name</i> : Indicates the VRF instance, with which the overlay router interface is associated.
Command Mode	Interface configuration mode
Usage Guide	This command is used to associate with a VRF instance in the VXLAN routing environment and is used for VXLAN L3 routing isolation.



↘ Creating a VXLAN Instance or Entering the VXLAN Configuration Mode

Command	vxlan <i>vni-number</i>
Parameter Description	<i>vni-number</i> : Indicates the VNI. The value ranges from 1 to 16,777,215.
Command Mode	Global configuration mode
Usage Guide	N/A

↘ Associating the VXLAN Instance with the Overlay Router Interface

Command	router-interface <i>interface-name</i>
Parameter Description	<i>interface-name</i> : Indicates the name of the overlay router interface.
Command Mode	VXLAN configuration mode
Usage Guide	The overlay router interfaces between VXLANs cannot conflict with each other and different VXLANs cannot associate with the same overlay router interface.

Configuration Example

-  Only configuration related to the VXLAN is described below.
-  Only IPv4 configuration is used as an example below and the IPv6 scenario configuration is largely the same as the IPv4 scenario configuration.

The recommended configuration is as follows:

<p>Scenario Figure 2-30</p>	<p style="text-align: center;">TOR</p> <p>SERVER VM1: vlan 10 vxlan 10 VM2: vlan 20 vxlan 20</p> <p>HOST Physical machine: untag vxlan 10</p>
<p>Configuration Steps</p>	<ul style="list-style-type: none"> ● Configure a virtual server, virtual machine, and physical server (omitted). ● Create an L2 subinterface on the TOR switch, configure VXLAN encapsulation and VLAN or untagged encapsulation rule for the subinterface. ● Create an overlay router interface on the TOR switch and configure the VXLAN gateway IP address. ● Configure the VXLAN instance to associate with the overlay router interface on the TOR switch to implement VXLAN routing.
<p>TOR</p>	<pre>TOR# configure terminal TOR(config)#vlan 10 TOR(config-vlan)#exit TOR(config)#vlan 20 TOR(config-vlan)#exit TOR(config)#interface TFGigabitEthernet 0/1 TOR(config-if-TFGigabitEthernet 0/1)#switchport mode trunk TOR(config-if-TFGigabitEthernet 0/1)#exit TOR(config)#interface TFGigabitEthernet 0/1.1 TOR(config-subif-TFGigabitEthernet 0/1.1)#encapsulation dot1q s-vid 10 TOR(config-subif-TFGigabitEthernet 0/1.1)#encapsulation vxlan 10 TOR(config-subif-TFGigabitEthernet 0/1.1)#exit TOR(config)#interface TFGigabitEthernet 0/1.2 TOR(config-subif-TFGigabitEthernet 0/1.2)#encapsulation dot1q s-vid 20 TOR(config-subif-TFGigabitEthernet 0/1.2)#encapsulation vxlan 20 TOR(config-subif-TFGigabitEthernet 0/1.2)#exit TOR(config)#interface TFGigabitEthernet 0/2 TOR(config-if-TFGigabitEthernet 0/2)#switchport mode access vlan 10 TOR(config-if-TFGigabitEthernet 0/2)#exit TOR(config)#interface TFGigabitEthernet 0/2.1 TOR(config-subif-TFGigabitEthernet 0/2.1)#encapsulation dot1q untag</pre>

	<pre>TOR(config-subif-TFGigabitEthernet 0/2.1)#encapsulation vxlan 10 TOR(config-subif-TFGigabitEthernet 0/2.1)#exit TOR(config)# interface overlayrouter 10 TOR(config-if-OverlayRouter 10)# ip address 10.1.1.1/24 TOR(config-if-OverlayRouter 10)# exit TOR(config)# vxlan 10 TOR(config-vxlan)# router-interface OverlayRouter 10 TOR(config-vxlan)# exit TOR(config)# interface overlayrouter 20 TOR(config-if-OverlayRouter 20)# ip address 20.1.1.1/24 TOR(config-if-OverlayRouter 20)# exit TOR(config)# vxlan 20 TOR(config-vxlan)# extend-vlan 20 TOR(config-vxlan)# router-interface OverlayRouter 20 TOR1(config-vxlan)# exit</pre>
Verification	<ul style="list-style-type: none"> ● Verify that the virtual machine and physical machine can ping each other.
	<pre>TOR# sho vxlan VXLAN Total Count: 2 VXLAN Capacity : 8000 VXLAN 10 Symmetric property : FALSE Router Interface : overlayrouter 10 (non-anycast) Extend VLAN : - VTEP Adjacency Count: 0 VXLAN 20 Symmetric property : FALSE Router Interface : overlayrouter 20 (non-anycast) Extend VLAN : - VTEP Adjacency Count: 0 TOR#sh running-config ! vlan range 1,10,20 ! interface TFGigabitEthernet 0/1 switchport mode trunk ! interface TFGigabitEthernet 0/1.1 encapsulation dot1q s-vid 10 encapsulation vxlan 10 ! interface TFGigabitEthernet 0/1.2</pre>

```

encapsulation dot1q s-vid 20
encapsulation vxlan 20
!
interface TFGigabitEthernet 0/2
switchport trunk native vlan 10
!
interface TFGigabitEthernet 0/2.1
encapsulation dot1q untag
encapsulation vxlan 10
    
```

- Banning synchronization of the local MAC address to the remote VTEP through EVPN messages on an L2-VNI VXLAN instance
- Banning delivery of the MAC addresses remotely synchronized through EVPN messages to the local MAC address table on an L2-VNI VXLAN instance
- Stopping an L2-VNI VXLAN instance from generating EVPN type-2 routes

➤ **Configuring an L2-VNI VXLAN Instance Not to Synchronize the Local MAC Address to the Remote VTEP Through EVPN Messages**

Command	evpn mac advertise disable
Parameter	N/A
Description	
Command Mode	VXLAN configuration mode
Usage Guide	<p>This command is not configured on a device by default. The device generates one MAC-only type-2 route through the VXLAN-EVPN protocol based on a locally learned MAC entry, and synchronizes the type-2 route to the EVPN neighbor (that is, remote VTEP). Then, the remote VTEP can learn the MAC entry from the MAC-only type-2 route.</p> <p>After this command is configured, the device does not generate VXLAN-EVPN MAC-only type-2 routes based on MAC entries, and therefore, it will not advertise MAC-only type-2 routes to the EVPN neighbor.</p> <p>This command is configured on a VXLAN instance and affects only whether the VXLAN instance generates MAC-only type-2 routes. Other VXLAN instances, for which this command is not configured, can still generate MAC-only type-2 routes.</p> <p>This command can be used in combination with the evpn arp mac-learning enable and evpn nd mac-learning enable commands. After they are executed, the network-wide VXLAN-EVPN neighbors synchronize only MAC-IP type-2 routes but no MAC-only type-2 routes. All devices parse and extract MAC entries from MAC-IP or MAC-IPv6 type-2 routes.</p> <p>Note: This command can be configured only on L2-VNI VXLAN instances (that is, VXLAN instances with the symmetric command not configured). It is unavailable on L3-VNI VXLAN instances.</p>

➤ **Configuring an L2-VNI VXLAN Instance Not to Deliver MAC Addresses Remotely Synchronized Through EVPN Messages to the Local MAC Address Table**

Command	evpn mac inactive
Parameter	N/A
Description	
Command Mode	VXLAN configuration mode

Usage Guide	<p>After this command is configured, the device does not learn MAC entries from VXLAN-EVPN type-2 routes (MAC-IP or MAC-only type-2 routes) synchronized from neighbors.</p> <p>This command is not configured on a device by default. The device learns MAC entries from VXLAN-EVPN type-2 routes synchronized from neighbors.</p> <p>This command is configured on a VXLAN instance and affects only whether the VXLAN instance learns MAC entries from VXLAN-EVPN type-2 routes. Other VXLAN instances, for which this command is not configured, can still learn MAC entries.</p> <p>Note: This command can be configured only on L2-VNI VXLAN instances (that is, VXLAN instances with the symmetric command not configured). It is unavailable on L3-VNI VXLAN instances.</p>
--------------------	--

📌 **Configuring an L2-VNI VXLAN Instance Not to Generate EVPN Type-2 Routes**

Command	evpn rt-2 advertise disable
Parameter Description	N/A
Command Mode	VXLAN configuration mode
Usage Guide	<p>This command is not configured on a device by default. The device generates one MAC-only type-2 route through the VXLAN-EVPN protocol based on a locally learned MAC entry, and synchronizes the type-2 route to the EVPN neighbor (that is, remote VTEP). Then, the remote VTEP learns the MAC entry from the MAC-only type-2 route. In addition, the device generates one MAC-IP type-2 route through the VXLAN-EVPN protocol based on a locally learned ARP entry and synchronizes the type-2 route to the EVPN neighbor. Then, the remote VTEP learns the ARP entry and host route from the MAC-IP type-2 route. The device generates one MAC-IPv6 type-2 route through the VXLAN-EVPN protocol based on a locally learned IPv6 ND entry, and synchronizes the type-2 route to the EVPN neighbor. Then, the remote VTEP learns the IPv6 ND entry and host route from the MAC-IPv6 type-2 route. After this command is configured, the MAC entries, ARP entries, and IPv6 ND entries of the device are not used to generate VXLAN-EVPN type-2 routes and therefore, no type-2 route is advertised to the EVPN neighbor.</p> <p>This command is configured on a VXLAN instance and affects only whether the VXLAN instance generates type-2 routes. Other VXLAN instances, for which this command is not configured, can still generate type-2 routes.</p> <p>Note: This command can be configured only on L2-VNI VXLAN instances (that is, VXLAN instances with the symmetric command not configured). It is unavailable on L3-VNI VXLAN instances.</p>

2.5 Monitoring

Displaying

Description	Command
Displays the VXLAN configuration and status of the device.	show vxlan vni-number
Displays the MAC addresses learned by the device.	show vxlan mac [vni vni-number] [address mac-address]
Displays the VXLAN ARP entries learned by the device.	show arp
Displays the VXLAN IPv6 ND entries learned by the device.	show ipv6 neighbors
Displays the global configurations of the device, such as the VTEP IP address and anycast MAC address.	show vxlan global
Displays the ARP suppression status of the device.	show vxlan arp suppress
Displays the VXLAN UDP destination port of the device.	show vxlan udp-port



 <https://www.fs.com>



The information in this document is subject to change without notice. FS has made all efforts to ensure the accuracy of the information, but all information in this document does not constitute any kind of warranty.