

GF2-Series-45U

## 45U OPEN FRAME RACK

Quick Start Guide **V1.0**

# 1

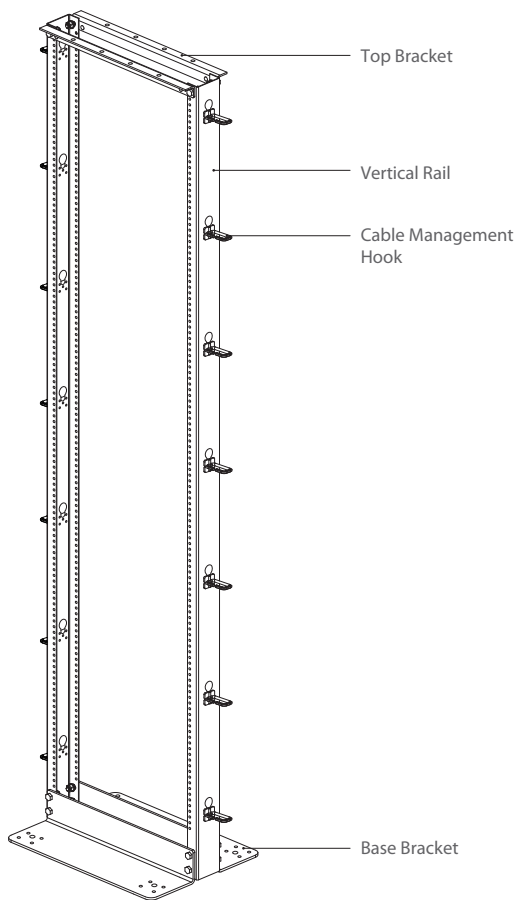

# 2

## Rack Components

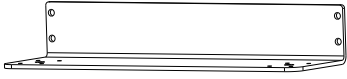

2X

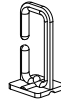

14X



2X



2X

## Accessories

## Optional (Not Included)



F5001

12X



F5002

28X



F5003

28X



F5004

14X

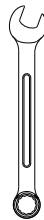

2X

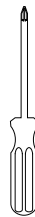

1X

# 3

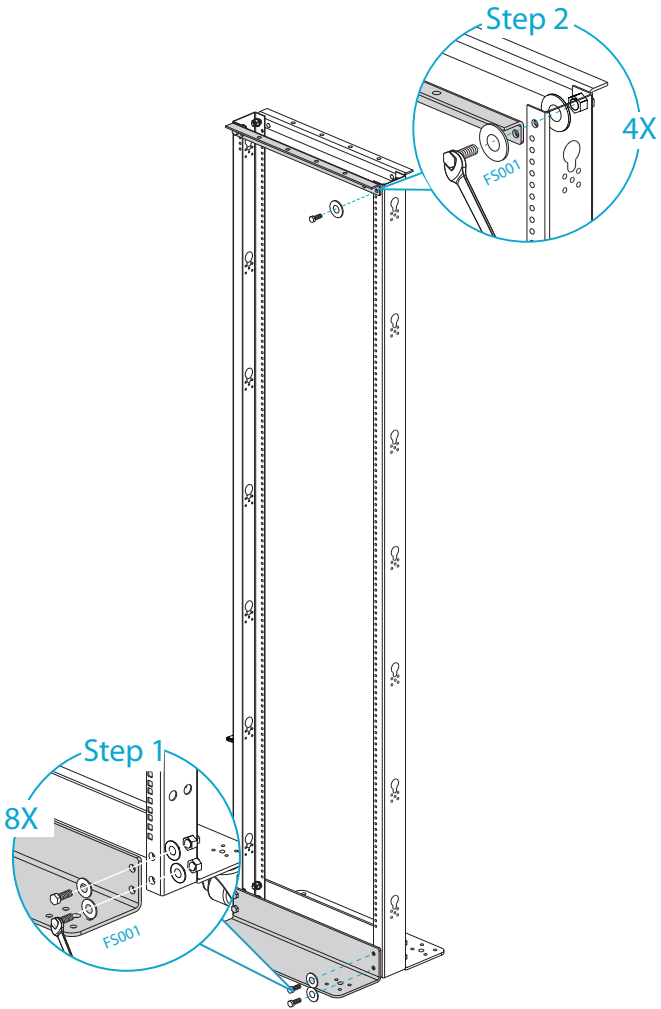

4

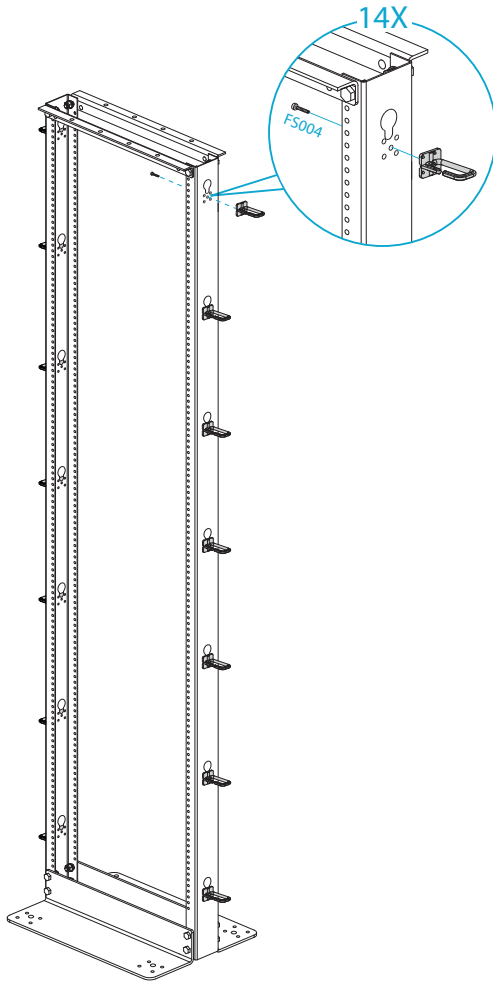

# 5

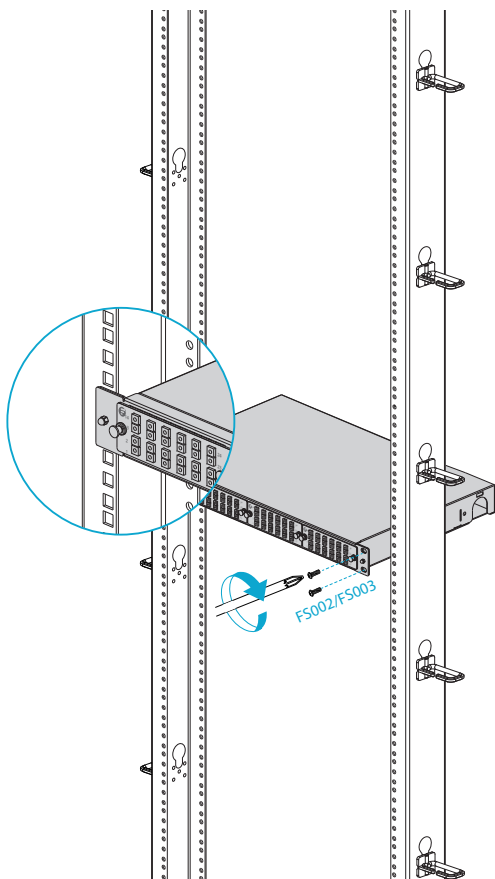

Q.C. PASSED