

# Horizontal Cable Managers with Finger Duct

Horizontal cable managers are typically used in applications that require a large number of Moves, Adds and Changes (MAC).



## Horizontal Cable Managers with Finger Duct

Horizontal cable managers ensure optimal cable radius to prevent deterioration or breakage. Flexible fingers maximize the care and protection of the equipment and cables, keeping the structured cabling system unhurt and totally functional. Removable cover makes it easy to add or remove bundled cables quickly.

High capacity horizontal cable managers provide an efficient way to manage high performance copper, fiber and etc. on any 19" rack.

### Standards Compliance

- RoHS Compliant
- ISO9001 Certificate

## Features

- **Integral bend radius control** — Maintains bend radius as cables transition to and from horizontal and vertical pathways.
- **Convenient hinged cover** — Allows access to the cable pathway without having to completely remove the cover.
- **Flexible finger dusts** — Provides for easy installation and organizes cables simplifying moves, adds, and changes.
- **Cable pass through holes** — Provides ease of installation and cable maintenance.
- **Available in 2U version (CMH-SFD2U)** — Increases more space for Ethernet cable runs.
- **Available in dual sided version (CMH-DFD1U)** — Manages more cables in 1U space, saving rack space and money.

Product Specifications

Part Number	CMH-SFD1U	CMH-SFD2U	CMH-DFD1U
<b>Pic.</b>			
<b>Style</b>	Finger Duct with Cover	Finger Duct with Cover	Finger Duct with Cover
<b>No. of Rack Spaces</b>	1U	2U	1U
<b>Type</b>	Single Sided		Dual Sided
<b>Material</b>	ABS	ABS	ABS
<b>Color</b>	Black	Black	Black
<b>Orientation</b>	Horizontal	Horizontal	Horizontal
<b>Length of Finger Duct</b>	2.87"	2.87"	2.87"
<b>Pass-through Holes</b>	2	2	2
<b>Detachable cover</b>	Yes	Yes	Yes
<b>Application</b>	Copper, Fiber and etc.	Copper, Fiber and etc.	Copper, Fiber and etc.
<b>Included Accessories</b>	M6*15mm Screw x4 and M6 Nut x4	M6*15mm Screw x4 and M6 Nut x4	M6*15mm Screw x4 and M6 Nut x4
<b>Dimensions (HxWxD)</b>	1.73"x19"x3.43" (44x482.6x87mm)	3.48"x19"x3.43" (88.5x482.6x87mm)	1.73"x19"x6.85" (44x482.6x174mm)

## Description

CMH-SFD1U

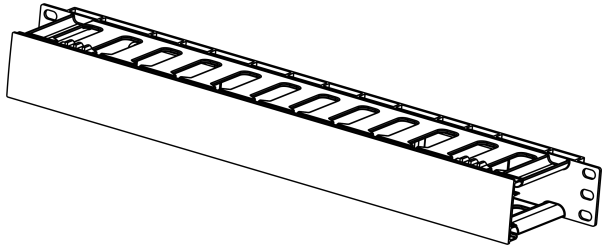

CMH-SFD2U

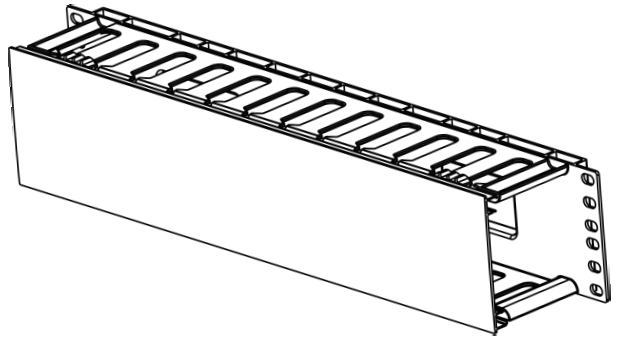

CMH-DFD1U

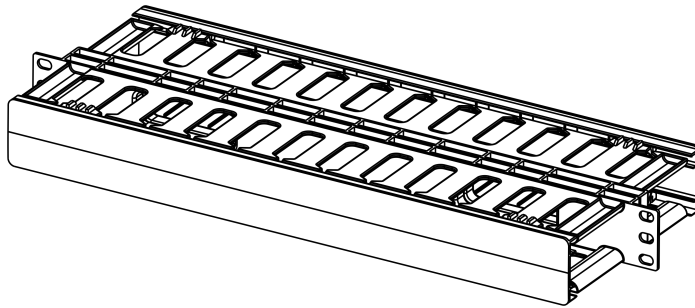

## Cable Capacity Reference Guide

PART NUMBER	CABLE CAPACITY									
	CAT5E 24AWG-5.5mm		CAT6 24AWG-6.1mm		CAT6 SLIM 28AWG-3.8mm		CAT6A/CAT7 26AWG-6.2mm		CAT8 28AWG-6.2mm	
	30%	100%	30%	100%	30%	100%	30%	100%	30%	100%
CMH-SFD1U	16	53	14	48	38	127	14	45	14	45
CMH-SFD2U	47	158	37	124	101	336	35	117	35	117
CMH-DFD1U	32	106	29	96	76	254	27	90	27	90

**Note:**

- The managers can be used with copper, fiber, and etc. And the above cable capacities of coppers are theoretical values for reference only.
- 30% is recommended cable fill, and 100% is maximum cable fill.

**Product Specifications**

**CMH-SFD1U (Front View)**

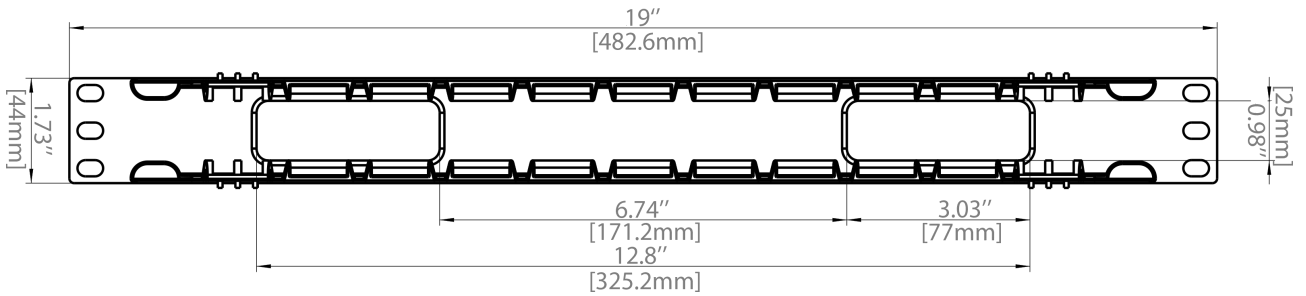

**CMH-SFD2U (Front View)**

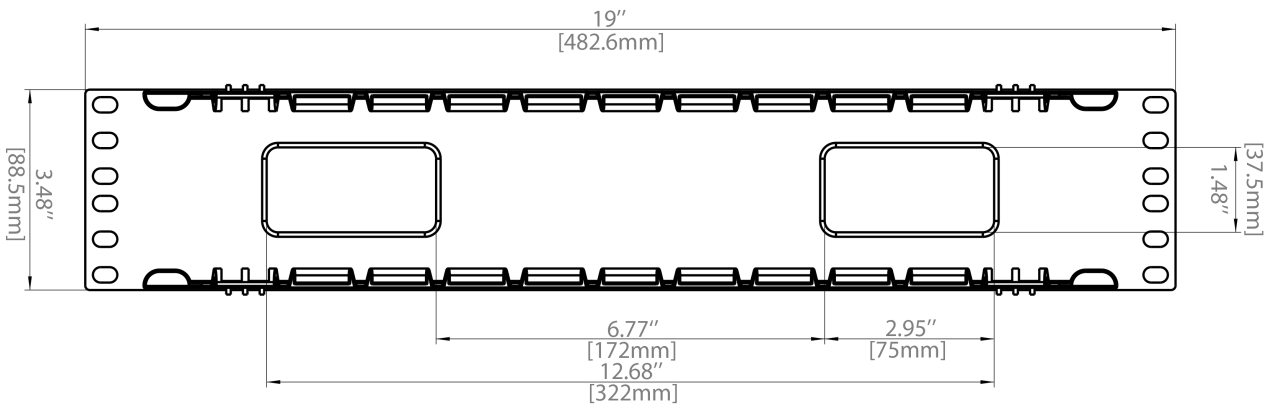

**CMH-DFD1U (Front View)**

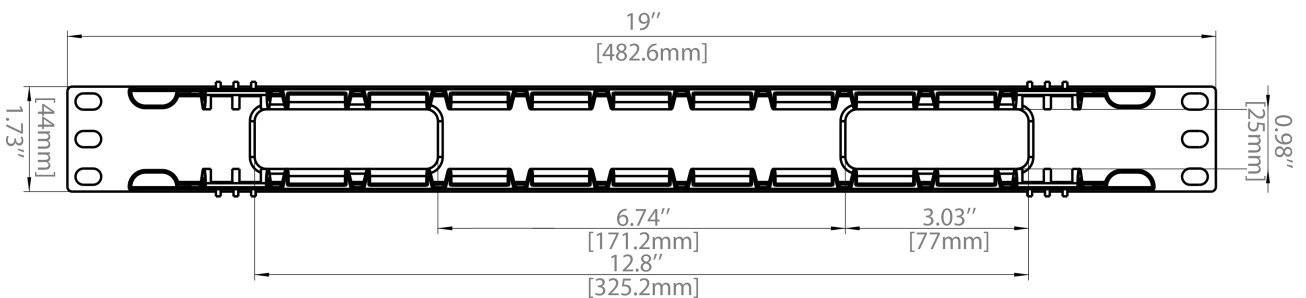

Dimensions are in inches. (Dimensions in parentheses are in millimeters).

**Product Specifications**

**CMH-SFD1U (Top and Side View)**

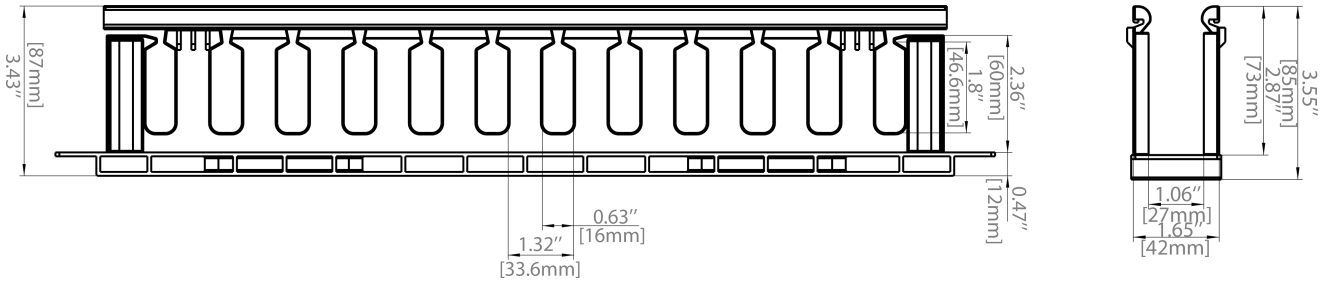

**CMH-SFD2U (Top and Side View)**

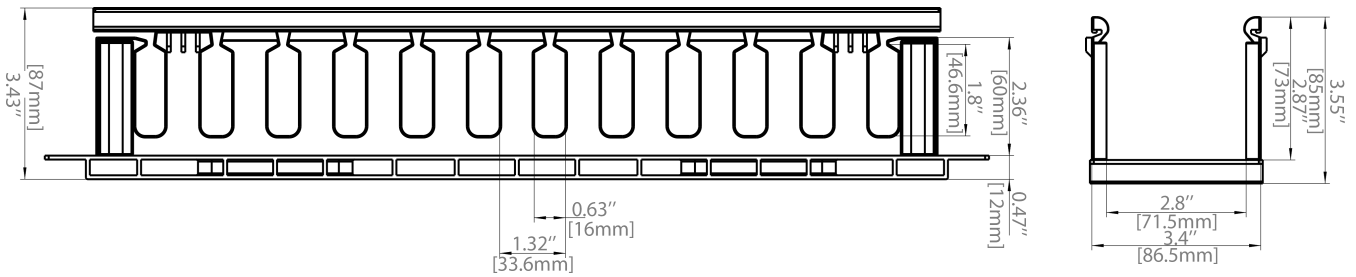

**CMH-DFD1U (Top and Side View)**

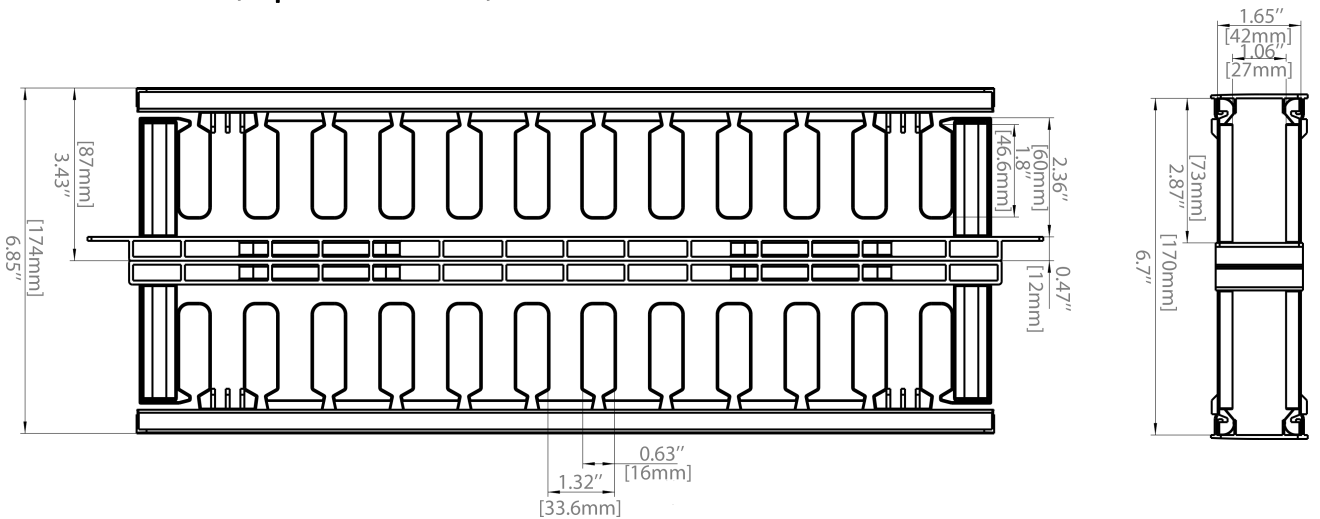

Dimensions are in inches. (Dimensions in parentheses are in millimeters).

## Product List

### I. Horizontal Cable Manager List

Item No.	#ID	Description
1	#29038	1U Plastic Single Sided Horizontal Cable Manager with Finger Duct
2	#29039	2U Plastic Single Sided Horizontal Cable Manager with Finger Duct
3	#29040	1U Plastic Dual Sided Horizontal Cable Manager with Finger Duct
4	#29034	1U Metal Horizontal Cable Manager with 5 D-rings
5	#72911	1U Metal Horizontal Lacer Panel with 5 Rotating and Detachable Plastic D-rings
6	#68690	1U Metal Recessed Horizontal Cable Manager with 4 D-rings & Brush Strip
7	#64184	1U Metal Horizontal Cable Manager with End Rings Manager
8	#29033	1U Metal Horizontal Cable Manager with Brush Strip
9	#59566	1U L-Shaped Horizontal Cable Lacer Bar with Angled 4" Offset, 5pcs/pack
10	#72910	1U 19" Cable Management Panel with 5 Detachable Plastic D-rings and Lacing Bar

### II. Matching Product List

Item No.	#ID	Description
1	#29123	S5850-48S6Q 48-Port 10Gb SFP+ L2/L3 Data Center ToR/Leaf Switch
2	#29122	S5850-32S2Q 32-Port 10Gb SFP+ L2/L3 Data Center Leaf Switch
3	#70595	3ft (0.9m) Cat6 Snagless Unshielded (UTP) PVC CM Ethernet Network Patch Cable
4	#70664	2ft (0.6m) Cat6a Snagless Shielded (SFTP) PVC CMX Ethernet Network Patch Cable
5	#40191	1m (3ft) LC UPC to LC UPC Duplex OS2 PVC (OFNR) 2.0mm Fiber Optic Patch Cable
6	#68017	1m (3ft) MTP® Female Type B Plenum (OFNP) OM4 (OM3) 50/125 Elite Trunk Cable
7	#29015	25pcs/Bag 10in.L x 0.5in.W T type Reusable Cable Ties-Colorful
8	#61882	25m/Roll 1000in.L x0.48in.W Back to Back Reusable Cable Ties-Black



 <https://www.fs.com>



The information in this document is subject to change without notice. FS has made all efforts to ensure the accuracy of the information, but all information in this document does not constitute any kind of warranty.