

FHD Optic Wall Mount Enclosure

Designed to provide a convenient convergence point for interconnecting and splicing in wall mount applications.



Wall Mount Enclosure

FHD Fiber Optic Wall Mount Enclosures can be used as an interconnect or cross-connect in any telecommunications room and can use FHD series fiber adapter panels and cassettes (exclude 36F). Enclosures are designed to manage and organize fiber distribution in areas where space is limited.

Standards Compliance

- TIA/EIA-568-C.3
- RoHS Compliant
- ISO9001 Certificate

Features

- Dual doors with slam latch for ease of access.
- Optional key/lock kit secures service-side door or customer-side doors.
- Accepts FHD series adapter panels, MTP cassettes (exclude 36F), and splice trays for multiple solution capabilities.
- Removable cable entry/exit grommets allow for pre-terminated fiber trunk install, cable protection, and minimizes dust build-up.
- Ensure signal integrity, proper cable routing, bend radius control and cable protection.



Product Specifications

Capacity

2 Ports

Fiber Count

Max. 48 Fibers

Enclosure Type

Wall-mountable

Material

SPCC (Black Coating)

Dimensions (HxWxD)

10.2"x13.0"x2.3" (259.6x330.6x59.1mm)

Installation

FHD Series FAPs and Cassettes (Exclude 36F)

Environmental Characteristics

Operating Temperature

-25°C to 50°C

Storage Temperature

-40°C to 65 °C

Installation temperature

0°C to 50°C

Assembly Structure Illustration

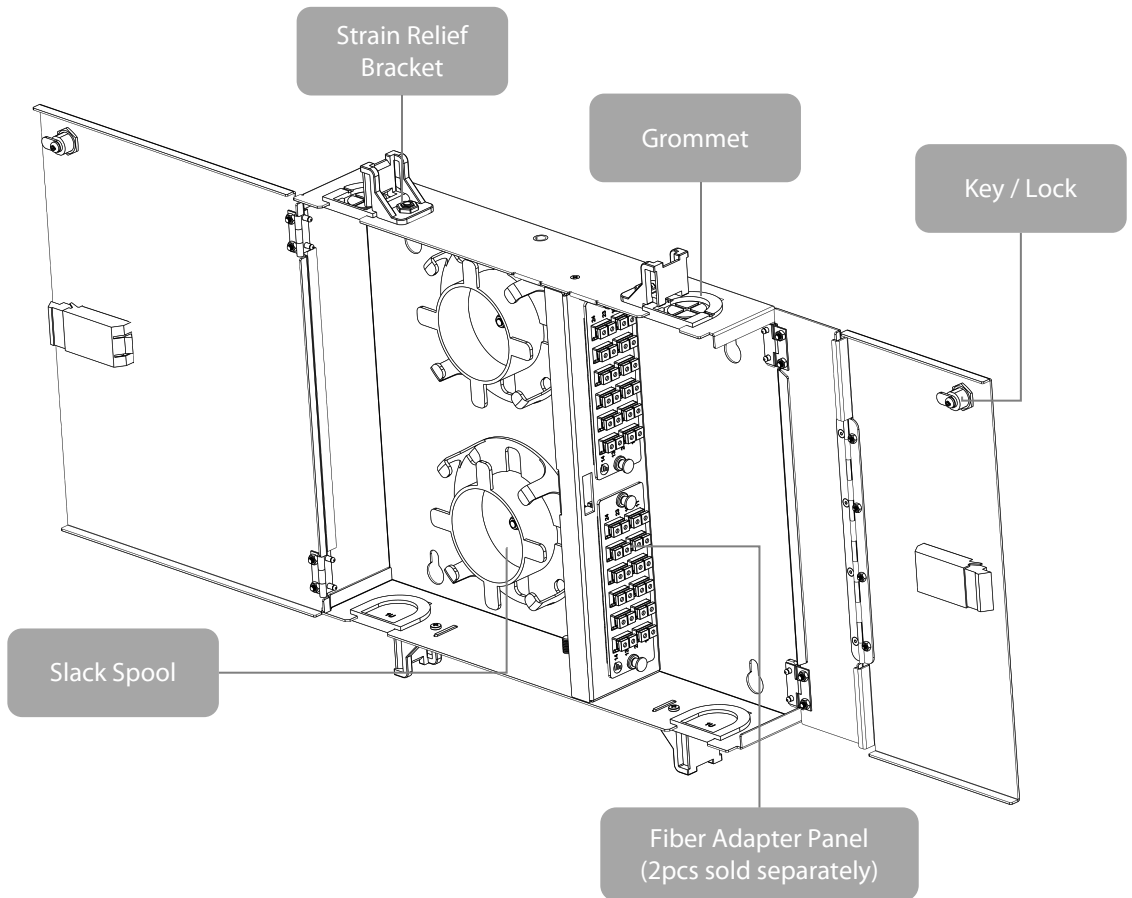

Accessories List

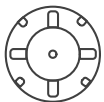

Slack Spool x2



Grommet x4



Strain Relief Bracket x4

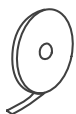

Cable Tie x2



M4*8 Screw x6 and M4 Nut x10



Location Label x1



Key x2



Screwdriver x1

Fiber Enclosure Loading List

I. Fiber Adapter Panel

Description	#ID (OS2)	#ID (OM4)
24F, 12x LC Duplex Fiber Adapter Panel	#35488	#51284
12F, 6x SC Duplex Fiber Adapter Panel	#35484	#41998
12x MTP Key Up to Key Down Fiber Adapter Panel	#35510	#35510
8x MTP Key Up to Key Up Fiber Adapter Panel	#52022	#52022
6-Port FHD Multimedia Modular Panel with 6x Plastic Clips	#66602	#66602

II. Splice Tray

Description	Fiber Count	#ID
24F, Fusion Splice Tray, Plastic, 6.26"x4.13"x0.72"	24F	#28774
12F, Fusion Splice Tray, Plastic, 6.42"x3.96"x0.69"	12F	#28773
Splice Tray Holder for FHD Wall Mount Enclosure	N/A	#73717

III. MTP/MPO Cassette

Description	#ID (OS2)	#ID (OM4)
8F, MTP-8 to 4x LC Duplex Cassette	#68401	#68402
12F, MTP-12 to 6x LC Duplex Cassette, Type A	#57016	#57017
12F, MTP-12 to 6x LC Duplex Cassette, Type AF	#57037	#57038
24F, 2x MTP-12 to 12x LC Duplex Cassette, Type A	#57341	#57342
24F, 2x MTP-12 to 12x LC Duplex Cassette, Type AF	#68540	#68541
24F, MTP-24 to 12x LC Duplex Cassette, Type A	#57023	#57024
24F, MTP-24 to 12x LC Duplex Cassette, Type AF	#68549	#68550

* MTP is a registered trademark of US Conec Ltd.

* The US Conec MTP connectors are fully compliant with the MPO standards.

Product Application

I. Patch Cord Connections



①

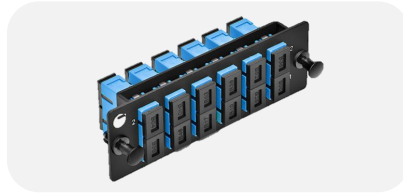

②



③

Item No.	#ID	Description
1	#40234	1m (3ft) SC UPC to SC UPC Duplex Single Mode Fiber Patch Cable
2	#35484	6x SC Duplex, 12 Fibers OS2 Single Mode FHD Fiber Adapter Panel
3	#50550	FHD Fiber Optic Wall Mount Enclosure, 2-Door 2-Adapter Panel

II. Fiber Optic Splicing



①



②



③



④

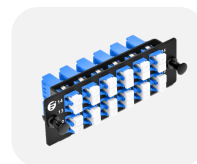

⑤



⑥

Item No.	#ID	Description
1	#42529	1m (3ft) 12 Fibers LC/UPC 9/125 Single Mode Color-Coded Fiber Optic Pigtail
2	#28774	24 Fibers Fusion Splice Tray, Plastic, 6.26"x4.13"x0.72"
3	#73717	Splice Tray Holder for FHD Wall Mount Enclosure
4	#50550	FHD Fiber Optic Wall Mount Enclosure, 2-Door 2-Adapter Panel
5	#35488	12x LC Duplex, 24 Fibers OS2 Single Mode FHD Fiber Adapter Panel
6	#68294	1m (3ft) Grade B LC UPC to LC UPC Duplex OS2 Fiber Patch Cable

III. MTP Cabling Management



①



②



③



④



⑤

Item No.	#ID	Description
1	#68294	1m (3ft) Grade B LC UPC to LC UPC Duplex OS2 Fiber Patch Cable
2	#57341	2x MTP-12 to 12x LC Duplex, Type A, 24 Fibers OS2 FHD MTP/MPO Cassette
3	#68102	5m (16ft) MTP Female 12 Fibers OS2 9/125 Single Mode Trunk Cable, Type A
4	#68540	2x MTP-12 to 12x LC Duplex, Type AF, 24 Fibers OS2 FHD MTP/MPO Cassette
5	#50550	FHD Fiber Optic Wall Mount Enclosure, 2-Door 2-Adapter Panel

Note:

The basic application and matching products for wall mount enclosures are shown for reference.

Product Specifications

Front View

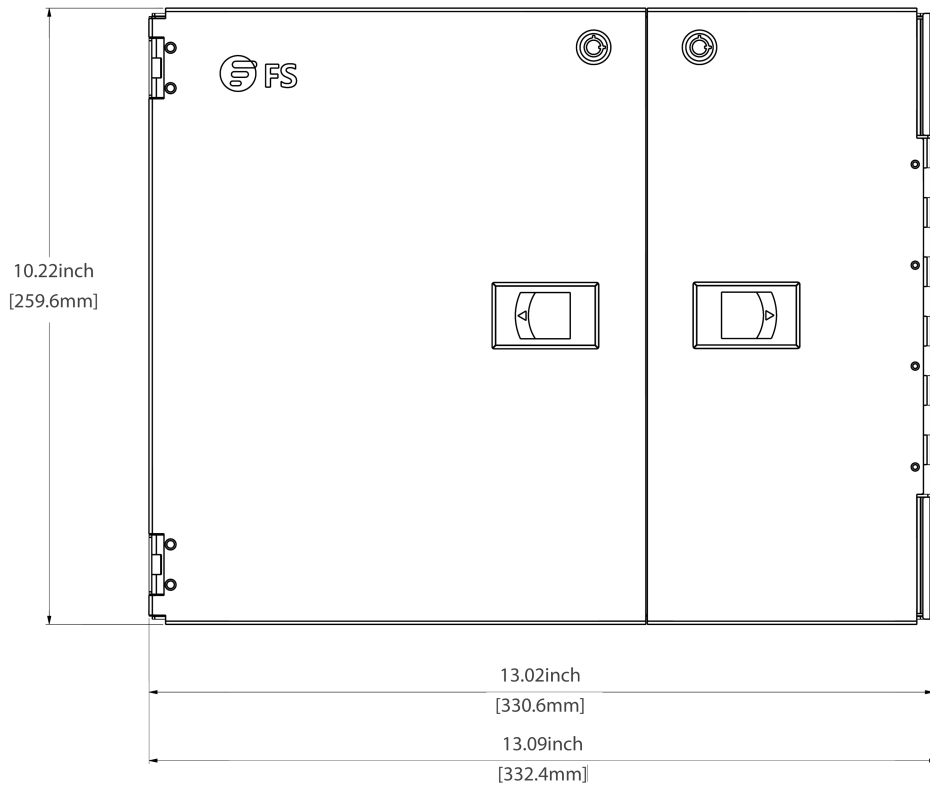

Top View

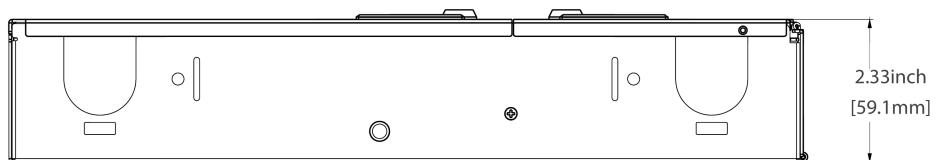

Dimensions are in inches. (Dimensions in parentheses are in millimeters).



 <https://www.fs.com>



The information in this document is subject to change without notice. FS has made all efforts to ensure the accuracy of the information, but all information in this document does not constitute any kind of warranty.