

# FHD 1U Rack Mount Fiber Enclosure

Designed for the data center environment, serves as a protection function for fiber management.



## FHD 1U Slide-out Rack Mount Enclosure

FHD Slide-out Fiber Rack Mount Enclosures are available in 1U, 2U and 4U sizes (FHD-1UFCE, FHD-2UFCE, FHD-4UFCE) and mount into 19" racks or cabinets. The enclosures provide a system for managing fiber terminations, connections, and patching in all types of applications.

## Standards Compliance

- TIA/EIA-568-C.3
- RoHS Compliant
- ISO9001 Certificate

## Features

- Up to 144 fibers in 1U space.
- Sliding drawer is ideal for panel access management.
- Offers total front access to all patch cords and rear cables for in-cabinet mounting locations.
- Mounts to standard EIA 19" rack rails, holds up to 4x FAPs or MTP® Cassettes.
- Ensures signal integrity, proper cable routing, bend radius control and cable protection.
- Provides flexibility solution for rapid deploy installation and patching application.



### Product Specifications

<b>No. of Rack Spaces</b>	1U
<b>Capacity</b>	4 Ports
<b>Fiber Count</b>	Max. 144 Fibers
<b>Enclosure Type</b>	Rack-mountable
<b>Material</b>	SPCC (Black Coating)
<b>Dimensions (HxWxD)</b>	1.73"x17.64"x17.04" (44x448x432.8mm)
<b>Installation</b>	FHD Series FAPs and Cassettes







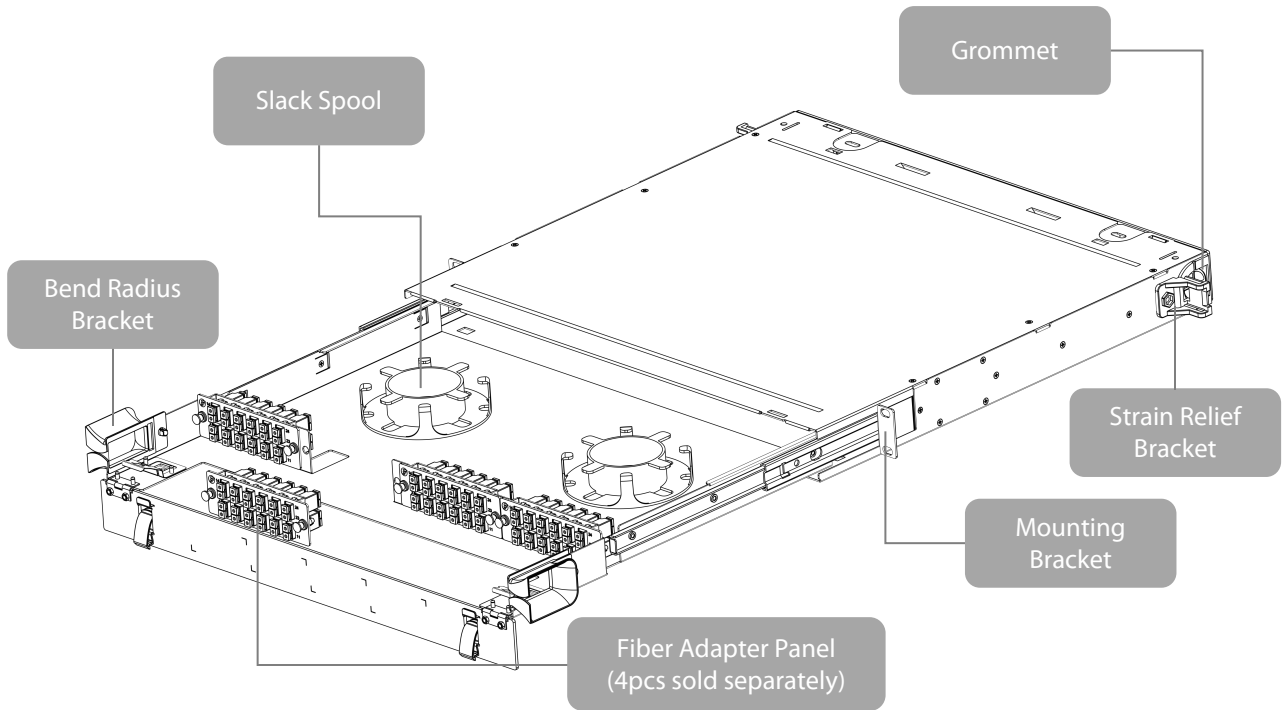





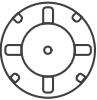

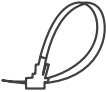
### Environmental Characteristics

<b>Operating Temperature</b>	-25°C to 50°C
<b>Storage Temperature</b>	-40°C to 65 °C
<b>Installation temperature</b>	0°C to 50°C

## Assembly Structure Illustration



## Accessories List

- |   |                  |   |                              |  |                              |
|---|------------------|---|------------------------------|--|------------------------------|
|  | Door Latch x4    |  | Bend Radius Bracket x2       |  | Grommet x4                   |
|   | Slack Spool x2   |  | Loop Cable Tie Mount x2      |  | Nylon Cable Tie x4           |
|   | Plastic Rivet x4 |  | Adhesive Bevel Entry Clip x2 |  | Strain Relief Bracket x2     |
|   | Screw Package x1 |  | M4*8 Screw x4 and M4 Nut x8  |  | M6*15 Screw x4 and M6 Nut x4 |
|  | Cable Tie x2     |  | Location Label x1            |  | Screwdriver x1               |

## Fiber Enclosure Capacity

Description	#ID	Part Number	Capacity	Fiber Count
FHD 1U slide-out rack mount enclosure	#70361	FHD-1UFCE	4 ports	144F
FHD 2U slide-out rack mount enclosure	#73205	FHD-2UFCE	8 ports	288F
FHD 4U slide-out rack mount enclosure	#73206	FHD-4UFCE	12 ports	432F
FHD 1U fixed rack mount enclosure	#34684	FHD-1UFMT-N	4 ports	144F
FHD 1U modular enclosure panel	#70419	FHD-1U-CMP400	4 ports	144F

## Fiber Enclosure Loading List

### I. Fiber Adapter Panel

Description	#ID (OS2)	#ID (OM4)
24F, 12x LC Duplex Fiber Adapter Panel	#35488	#51284
12F, 6x SC Duplex Fiber Adapter Panel	#35484	#41998
12x MTP® Key Up to Key Down Fiber Adapter Panel	#35510	#35510
8x MTP® Key Up to Key Up Fiber Adapter Panel	#52022	#52022
6-Port FHD Multimedia Modular Panel with 6x Plastic Clips	#66602	#66602

### II. MTP®/MPO Cassette

Description	#ID (OS2)	#ID (OM4)
8F, MTP®-8 to 4x LC Duplex Cassette	#68401	#68402
12F, MTP®-12 to 6x LC Duplex Cassette, Type A	#57016	#57017
12F, MTP®-12 to 6x LC Duplex Cassette, Type AF	#57037	#57038
24F, 2x MTP®-12 to 12x LC Duplex Cassette, Type A	#57341	#57342
24F, 2x MTP®-12 to 12x LC Duplex Cassette, Type AF	#68540	#68541
36F, 3x MTP®-12 to 12x LC Duplex Cassette, Type A	#105333	#105335
36F, 3x MTP®-12 to 12x LC Duplex Cassette, Type AF	#105334	#105336
24F, MTP®-24 to 12x LC Duplex Cassette, Type A	#57023	#57024
24F, MTP®-24 to 12x LC Duplex Cassette, Type AF	#68549	#68550

\*MTP® is a registered trademark of US Conec Ltd.

\*The US Conec MTP® connectors are fully compliant with the MPO standards.

## Product Application

### I. Patch Cord Connections



①

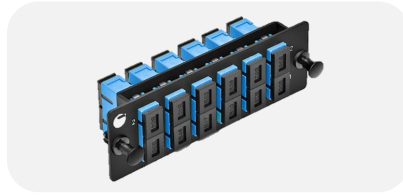

②



③

Item No.	#ID	Description
1	#40234	1m (3ft) SC UPC to SC UPC Duplex Single Mode Fiber Patch Cable
2	#35484	6x SC Duplex, 12 Fibers OS2 Single Mode FHD Fiber Adapter Panel
3	#70361	1U Rack Mount FHD High Density Slide-out Fiber Enclosure

### II. Fiber Optic Splicing

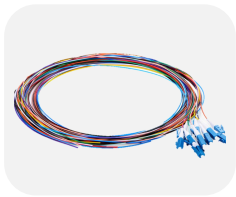

①



②



③



④

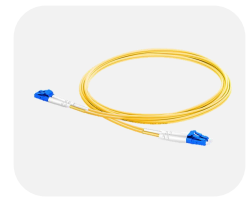

⑤

Item No.	#ID	Description
1	#42529	1m (3ft) 12 Fibers LC/UPC 9/125 Single Mode Color-Coded Fiber Optic Pigtail
2	#64246	24 Fibers Optical Splice Tray for FHD Fiber Enclosure
3	#70361	1U Rack Mount FHD High Density Slide-out Fiber Enclosure
4	#35488	12x LC Duplex, 24 Fibers OS2 Single Mode FHD Fiber Adapter Panel
5	#68294	1m (3ft) Grade B LC UPC to LC UPC Duplex OS2 Fiber Patch Cable

### III. MTP® Cabling Management



①



②



③



④



⑤

Item No.	#ID	Description
1	#68294	1m (3ft) Grade B LC UPC to LC UPC Duplex OS2 Fiber Patch Cable
2	#57341	2x MTP®-12 to 12x LC Duplex, Type A, 24 Fibers OS2 FHD MTP®/MPO Cassette
3	#68102	5m (16ft) MTP® Female 12 Fibers OS2 9/125 Single Mode Trunk Cable, Type A
4	#68540	2x MTP®-12 to 12x LC Duplex, Type AF, 24 Fibers OS2 FHD MTP®/MPO Cassette
5	#70361	1U Rack Mount FHD High Density Slide-out Fiber Enclosure

**Note:**

The basic application and matching products for the enclosure are shown for reference.

## Product Specifications

### Front View

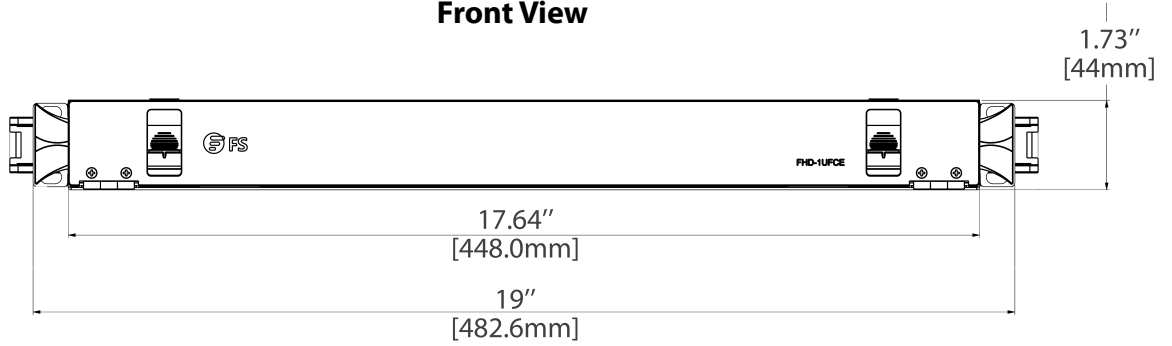

### Top View

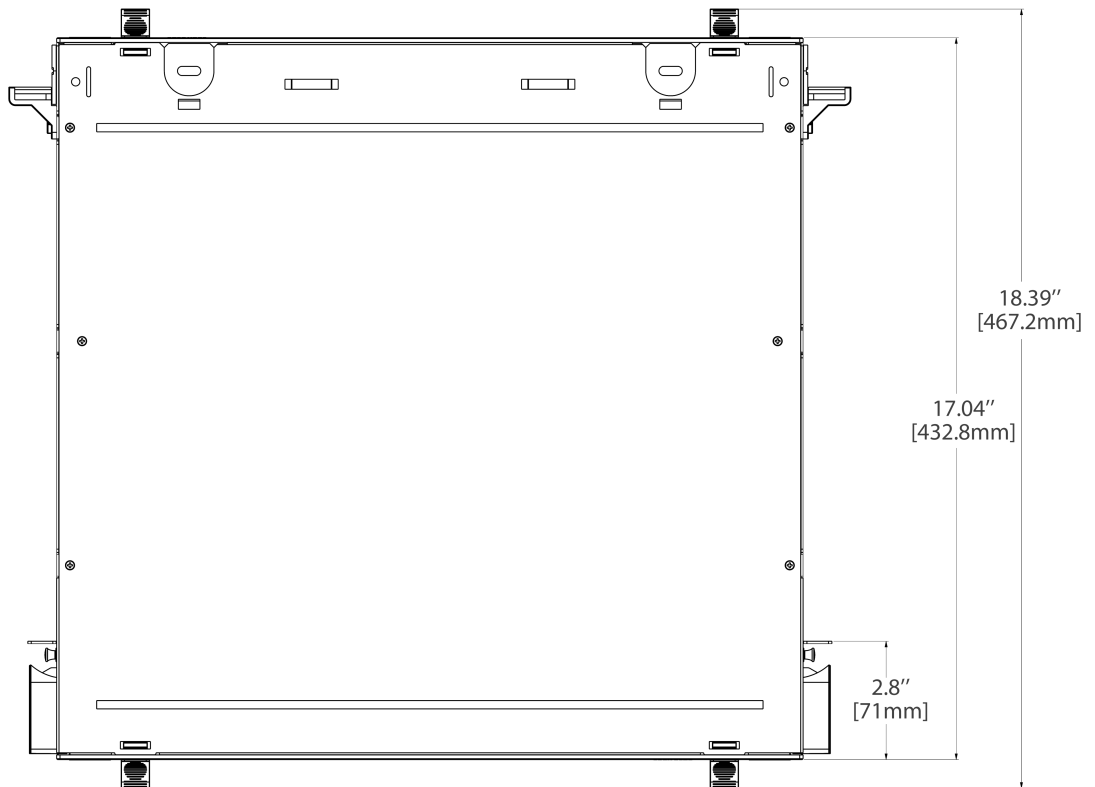

Dimensions are in inches. (Dimensions in parentheses are in millimeters).



 <https://www.fs.com>



The information in this document is subject to change without notice. FS has made all efforts to ensure the accuracy of the information, but all information in this document does not constitute any kind of warranty.