

# 1000BASE-CWDM SFP 1270nm~1610nm 100km DOM Transceiver

CWDM-SFP1G-EZX



## Application

- Gigabit Ethernet
- 1X Fiber Channel
- CWDM Networks

## Features

- Up to 1.25Gb/s Data Links
- Hot-Pluggable
- Duplex LC connector
- Up to 100km on 9/125 $\mu$ m SMF
- 18-Wavelength CWDM 1270nm~1610nm Available
- CWDM DFB laser transmitter
- Single +3.3V Power Supply
- Monitoring Interface Compliant with SFF-8472
- Low power dissipation <1W typically
- Operating temperature range: 0° C to 70° C
- RoHS compliant and Lead Free

## Description

FS's CWDM-SFP1G-EZX Transceiver products provide optical networking equipment manufacturers with a timely and cost effective tool in supporting the unceasing demand for higher bandwidth equipment build-outs in the enterprise access and metropolitan area networks. There are 18 center wavelengths available from 1270nm to 1610nm. The 20nm channel spacing allows for un-cooled laser operation, a high yield manufacturing process, and lower cost Mux/Demux technology, thus providing a complete cost effective solution for various data and telecom applications.

## Product Specifications

### I. Absolute Maximum Ratings

Parameter	Symbol	Min	Typ.	Max	Unit
<b>Storage Temperature</b>	$T_S$	-40		+85	° C
<b>Supply Voltage</b>	$V_{CC}$	-0.5		4	V
<b>Relative Humidity</b>	RH	0		85	%

### II. Recommended Operating Environment

Parameter	Symbol	Min	Typ.	Max	Unit
<b>Case operating Temperature</b>	$T_C$	0		+70	° C
<b>Supply Voltage</b>	$V_{CC}$	3.135		3.465	V
<b>Supply Current</b>	$I_{CC}$			300	mA
<b>Inrush Current</b>	$I_{surge}$			$I_{CC}+30$	mA
<b>Maximum Power</b>	$P_{max}$			1	W

### III. Electrical Characteristics

Parameter	Symbol	Min	Typ.	Max	Unit	NOTE
<b>Transmitter</b>						
<b>Input differential impedance</b>	$R_{in}$	90	100	110		
<b>Single ended data input swing</b>	$V_{in PP}$	250		1200	mVp-p	

<b>Transmit Disable Voltage</b>	$V_D$	$V_{CC} - 1.3$		$V_{CC}$	V	2
<b>Transmit Enable Voltage</b>	$V_{EN}$	Vee		$V_{EE} + 0.8$	V	
<b>Transmit Disable Assert Time</b>	$T_{dessert}$			10	us	
<b>Receiver</b>						
<b>Single ended data output swing</b>	$V_{out,pp}$	300		800	mv	3
<b>Data output rise time</b>	$t_r$			260	ps	4
<b>Data output fall time</b>	$t_f$			260	ps	4
<b>LOS Fault</b>	$V_{losfault}$	$V_{CC} - 0.5$		$V_{CC\_host}$	V	5
<b>LOS Normal</b>	$V_{losnorm}$	Vee		$V_{EE} + 0.5$	V	5
<b>Power Supply Rejection</b>	PSR	100			mVpp	6

**Notes:**

1. AC coupled.
2. Or open circuit.
3. Into 100 ohm differential termination.
4. 20 – 80 %
5. LOS is LVTTTL. Logic 0 indicates normal operation; logic 1 indicates no signal detected.
6. All transceiver specifications are compliant with a power supply sinusoidal modulation of 20 Hz to 1.5MHz up to specified value applied through the power supply filtering network shown on page 23 of the Small Form-factor Pluggable (SFP) Transceiver Multi-Source Agreement (MSA), September 14, 2000.

**IV. Optical Characteristics**

Parameter	Symbol	Min	Typ.	Max	Unit
<b>Transmitter</b>					
<b>Center Wavelength</b>	$\lambda_c$	$\lambda - 6.5$	$\lambda$	$\lambda + 6.5$	nm
<b>Spectral Width</b>	$\sigma$			1	nm
<b>Side Mode Suppression Ratio</b>	SMSR	30			dB
<b>Optical Output Power</b>	$P_{out}$	0		+4	dBm

<b>Optical Rise/Fall Time</b>	$t_r / t_f$			260	ps
<b>Extinction Ratio</b>	ER	9			dB
<b>Generated Jitter (peak to peak)</b>	$J_{TXp-p}$			0.07	UI
<b>Generated Jitter (rms)</b>	$J_{TXrms}$			0.007	UI
<b>Eye Mask for Optical Output</b>	Compliant with IEEE802.3z(class 1 laser safety)				
<b>Receiver</b>					
<b>Optical Input Wavelength</b>	$\lambda_c$	1260		1620	nm
<b>Receiver Overload</b>	$P_{ol}$	-8			dBm
<b>RX Sensitivity</b>	Sen			-32	dBm
<b>RX_LOS Assert</b>	$LOS_A$	-45			dBm
<b>RX_LOS De-assert</b>	$LOS_D$			-33	dBm
<b>RX_LOS Hysteresis</b>	$LOS_H$	0.5			dB
<b>General Specifications</b>					
<b>Data Rate</b>	BR		1.25		Gb/s
<b>Bit Error Rate</b>	BER			$10^{-12}$	
<b>Max. Supported Link Length on 9/125<math>\mu</math>m SMF@1.25Gb/s</b>	$L_{MAX}$		100		km
<b>Total System Budget</b>	LB	32			dB

**Notes:**

1. The optical power is launched into SMF.
2. 20-80%.
3. Jitter measurements taken using Agilent OMNIBERT 718 in accordance with GR-253.
4. Measured with PRBS 2<sup>7</sup>-1 at 10<sup>-12</sup> BER

### V. Pin Description

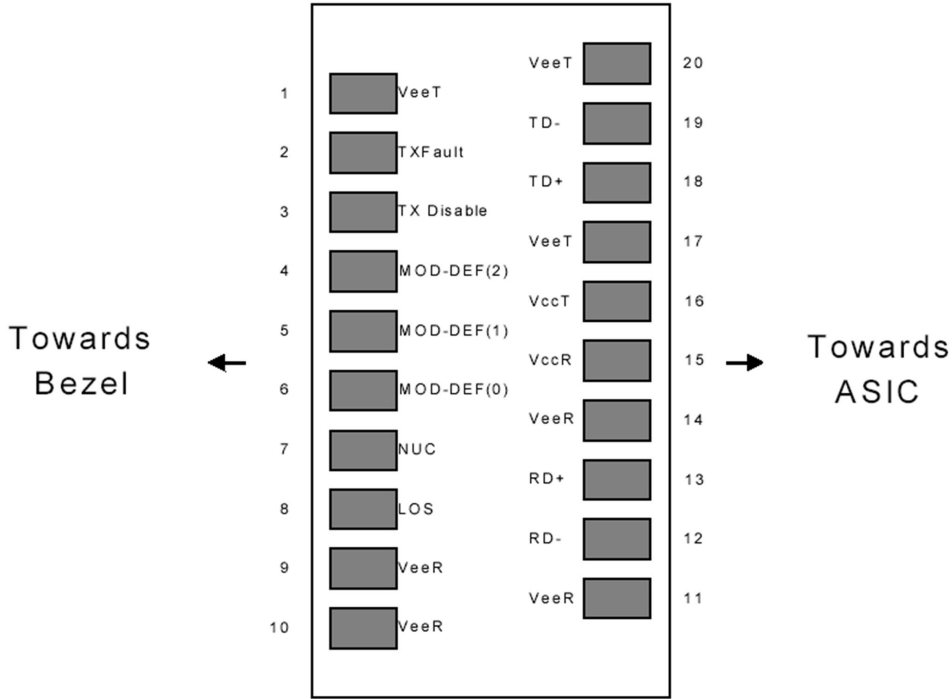

**Diagram of Host Board Connector Block Pin Numbers and Names**

Pin Num.	Name	Function	Plug Seq.	Notes
1	VeeT	Transmitter Ground	1	1
2	TX Fault	Transmitter Fault Indication	3	
3	TX Disable	Transmitter Disable	3	2
4	MOD-DEF2	Module Definition	2	3
5	MOD-DEF1	Module Definition 1	3	3
6	MOD-DEF0	Module Definition 0	3	3
7	Rate Select	Not Connected	3	4
8	LOS	Loss of Signal	3	5
9	VeeR	Receiver Ground	1	1
10	VeeR	Receiver Ground	1	1

11	VeeR	Receiver Ground		1
12	RD-	Inv. Received Data Out	3	6
13	RD+	Received Data Out	3	6
14	VeeR	Receiver Ground	3	1
15	VccR	Receiver Power	2	1
16	VccT	Transmitter Power	2	
17	VeeT	Transmitter Ground	1	
18	TD+	Transmit Data In	3	6
19	TD-	Inv. Transmit In	3	6
20	VeeT	Transmitter Ground	1	

**Notes:**

1. Circuit ground is internally isolated from chassis ground.
2. Laser output disabled on TDIS >2.0V or open, enabled on TDIS <0.8V.
3. Should be pulled up with 4.7k - 10 kohms on host board to a voltage between 2.0V and 3.6V. MOD\_DEF(0) pulls line low to indicate module is plugged in.
4. Rate select is not used
5. LOS is open collector output. Should be pulled up with 4.7k – 10 kohms on host board to a voltage between 2.0V and 3.6V. Logic 0 indicates normal operation; logic 1 indicates loss of signal.
6. AC Coupled

## VI. SFP Module EEPROM Information and Management

The SFP modules implement the 2-wire serial communication protocol as defined in the SFP -8472. The serial ID information of the SFP modules and Digital Diagnostic Monitor parameters can be accessed through the I2C interface at address A0h and A2h.

The memory is mapped in Table 1.

Detailed ID information (A0h) is listed in Table 2.

And the DDM specification at address A2h.

For more details of the memory map and byte definitions, please refer to the SFF-8472, "Digital Diagnostic Monitoring Interface for Optical Transceivers". The DDM parameters have been internally calibrated.

**Table 1.** Digital Diagnostic Memory Map (Specific Data Field Descriptions)

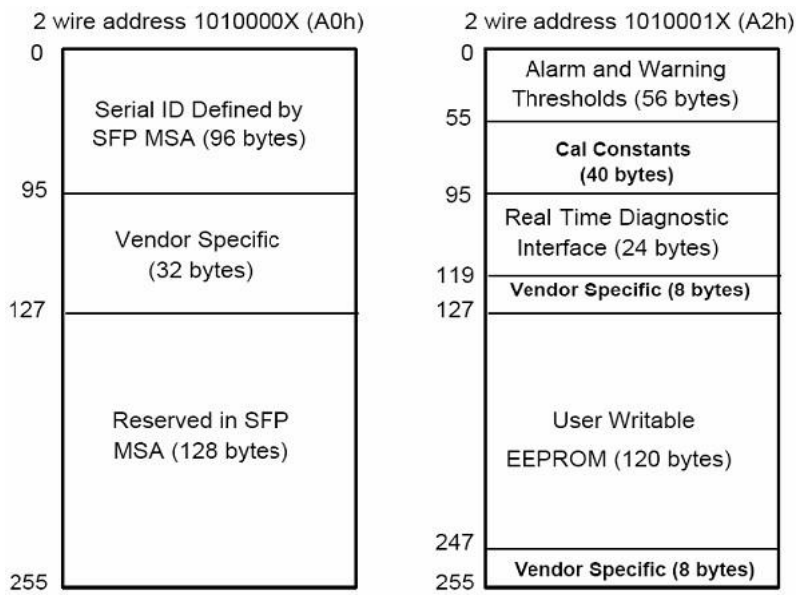

**Table 2.** EEPROM Serial ID Memory Contents (A0h)

Data Address	Length(Byte)	Name ofLength	Description and Contents
Base ID Fields			
0	1	Identifier	Type of Serial transceiver (03h=SFP)
1	1	Reserved	Extended identifier of type serial transceiver (04h)
2	1	Connector	Code of optical connector type (07=LC)
3-10	8	Transceiver	

11	1	Encoding	NRZ(03h)
12	1	BR, Nominal	Nominal baud rate, unit of 100Mbps
13-14	2	Reserved	(0000h)
15	1	Length(9um)	Link length supported for 9/125um fiber, units of 100m
16	1	Length(50um)	Link length supported for 50/125um fiber, units of 10m
17	1	Length(62.5um)	Link length supported for 62.5/125um fiber, units of 10m
18	1	Length(Copper)	Link length supported for copper, units of meters
19	1	Reserved	
20-35	16	Vendor Name	SFP vendor name: FS
36	1	Reserved	
37-39	3	Vendor OUI	SFP transceiver vendor OUI ID
40-55	16	Vendor PN	Part Number: "CWDM-SFP1G-EZX" (ASCII)
56-59	4	Vendor rev	Revision level for part number
60-62	3	Reserved	
63	1	CCID	Least significant byte of sum of data in address 0-62

## Extended ID Fields

64-65	2	Option	Indicates which optical SFP signals are implemented(001Ah = LOS, TX_FAULT, TX_DISABLE all supported)
66	1	BR, max	Upper bit rate margin, units of %
67	1	BR, min	Lower bit rate margin, units of %
68-83	16	Vendor SN	Serial number (ASCII)
84-91	8	Date code	FS's Manufacturing date code
92-94	3	Reserved	
95	1	CCEX	Check code for the extended ID Fields (addresses 64 to 94)

## Vendor Specific ID Fields

96-127	32	Readable	FS specific date, read only
128-255	128	Reserved	Reserved for SFF-8079



## VII. Digital Diagnostic Monitor Characteristics

Data Address	Parameter	Accuracy	Unit
96-97	Transceiver Internal Temperature	± 3.0	° C
98-99	VCC3 Internal Supply Voltage	± 5.0	%
100-101	Laser Bias Current	± 10	%
102-103	Tx Output Power	± 3.0	dBm
104-105	Rx Input Power	± 3.0	dBm

## VIII. Digital Diagnostic Monitor Characteristics

The CWDM-SFP1G-EZX complies with international Electromagnetic Compatibility (EMC) and international safety requirements and standards (see details in Table following).

Electrostatic Discharge(ESD) to the Electrical Pins	MIL-STD-883E Method 3015.7	Class 1(>1000 V)
Electrostatic Discharge (ESD) to the Duplex LC Receptacle	IEC 61000-4-2GR-1089-CORE	Compatible with standards
Electromagnetic Interference (EMI)	FCC Part 15 Class B EN55022 Class B (CISPR 22B) VCCI Class B	Compatible with standards
Laser Eye Safety	FDA 21CFR 1040.10 and 1040.11 EN60950, EN (IEC) 60825-1,2	Compatible with Class 1 laser product.

### IX. Recommended Circuit

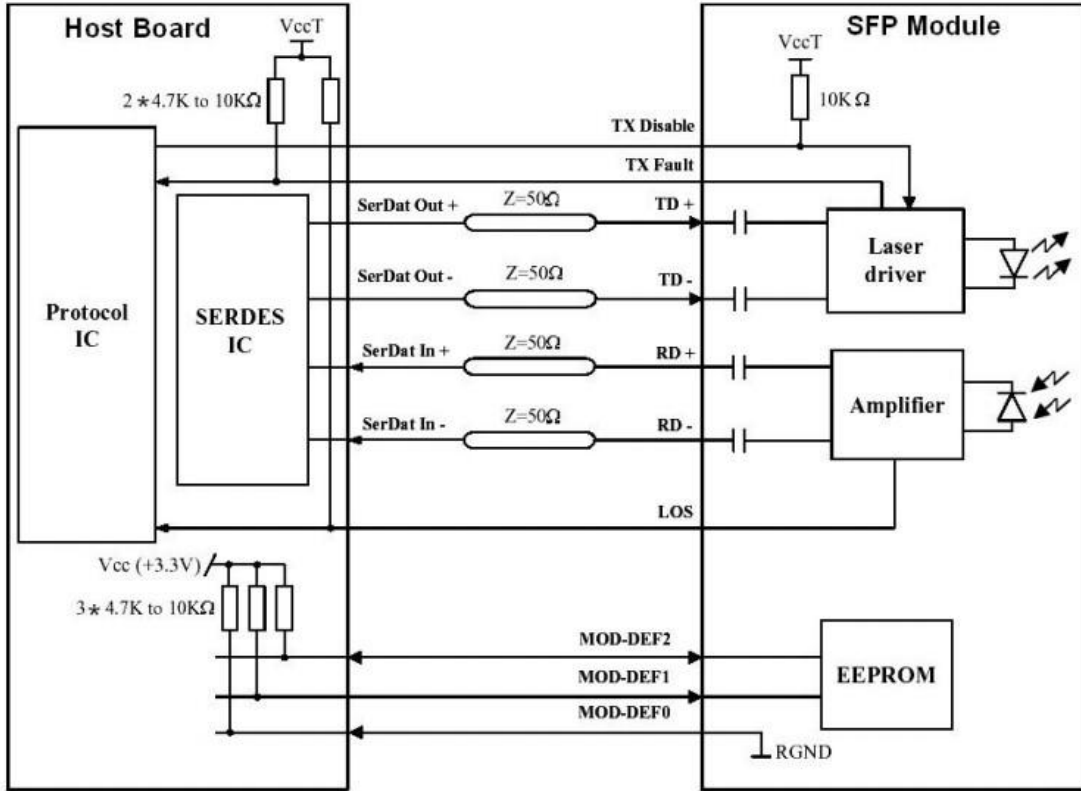

SFP Host Recommended Circuit

## X. Mechanical Specifications

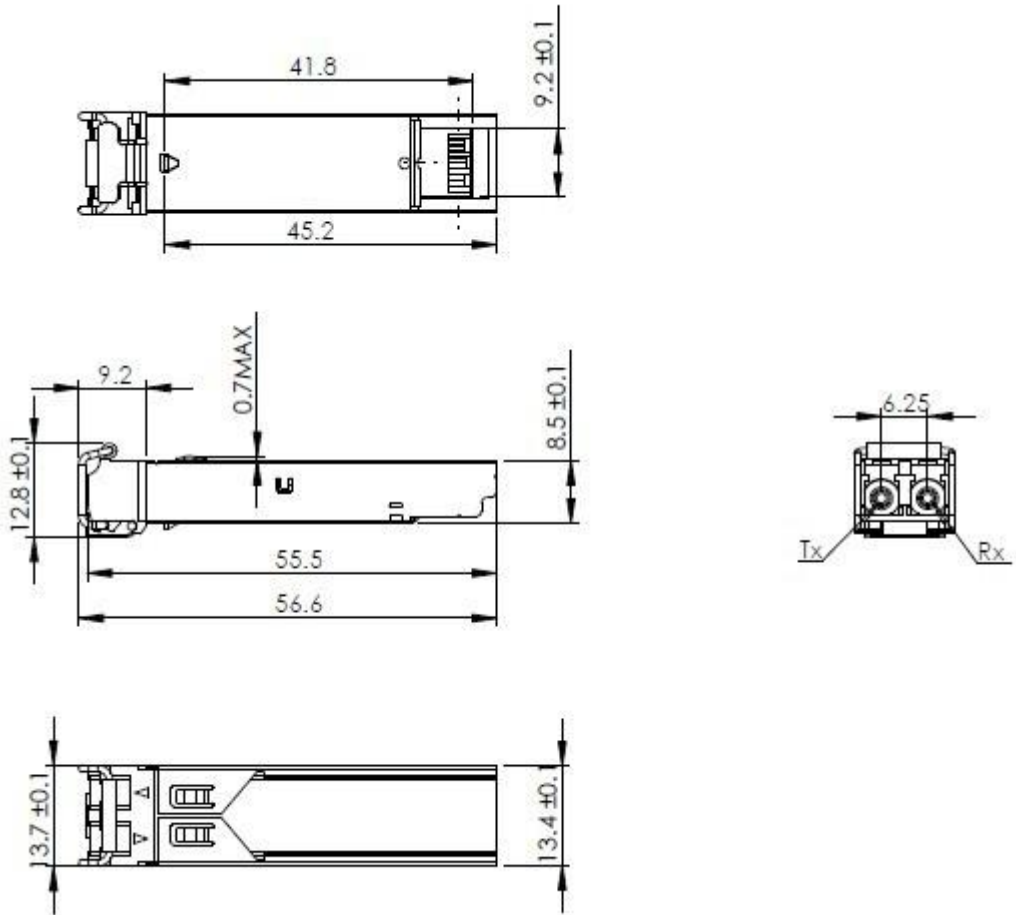

## Test Center

### I. Compatibility Testing

Each fiber optical transceiver has been tested in host device on site in FS Assured Program to ensure full compatibility with over 200 vendors.



Cisco Catalyst C9500-24Y4C

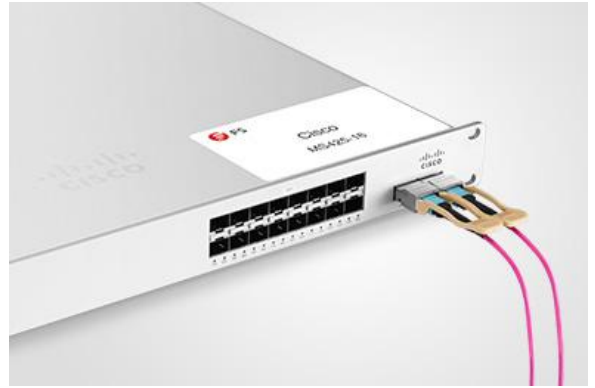

Cisco MS425-16

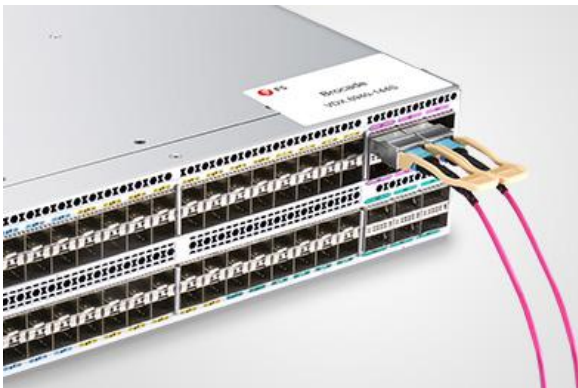

Brocade VDX 6940-144S



Dell EMC Networking Z9100-ON



Force<sup>10</sup> S60-44T



HUAWEI S6720-30L-HI-24S

Above is part of our test bed network equipment. For more information, please click the [Test Bed PDF](#). It will be updated in real time as we expand our portfolio.

## II. Performance Testing

Each fiber optical transceiver has been fully tested in FS Assured Program equipped with world's most advanced analytical equipment to ensure that our transceivers work perfectly on your device.

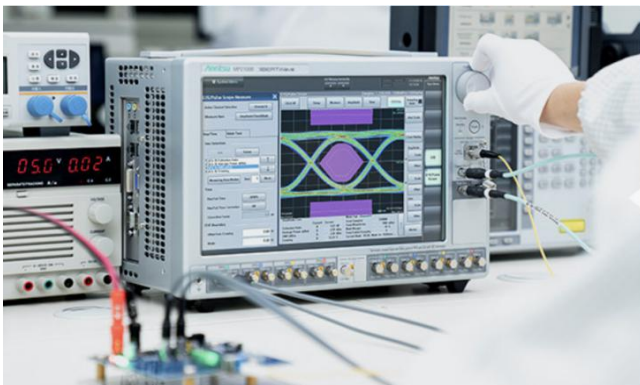

### 1. TX/RX Single Quality Testing

Equipped with the all-in-one tester integrated 4ch BERT & sampling oscilloscope, and variable optical attenuator the input and output signal quality.

- Eye Pattern Measurements: Jitter, Mask Margin, etc
- Average Output Power
- OMA
- Extinction Ratio
- Receiver Sensitivity
- BER Curve

### 2. Reliability and Stability Testing

Subject the transceivers to dramatic in temperature on the thermal shock chamber to ensure reliability and stability of the transceivers.

- Commercial: 0°C to 70°C
- Extended: -5°C to 85°C
- Industrial: -40°C to 85°C



### 3. Transfer Rate and Protocol Testing

Test the actual transfer data rate and the transmission ability under different protocols with Networks Master Pro.

- Ethernet
- Fiber Channel
- SDH/SONET
- CPRI

### 4. Optical Spectrum Evaluation

Evaluate various important parameters with the Optical Spectrum Analyzer to meet the industry standards.

- Center Wavelength, Level
- OSNR
- SMSR
- Spectrum Width



## Order Information

Part Number	Description
CWDM-SFP1G-ZX	SFP,1000BASE-CWDM, 1270nm~1610nm, SMF, 80km, LC, DOM
CWDM-SFP1G-ZX	SFP,1000BASE-CWDM, 1270nm~1610nm, SMF, 40km, LC, DOM
CWDM-SFP1G-ZX	SFP,1000BASE-CWDM, 1270nm~1610nm, SMF, 20km, LC, DOM
CWDM-SFP1G-EZX	SFP,1000BASE-CWDM, 1270nm~1610nm, SMF, 100km, LC, DOM
CWDM-SFP1G-EZX	SFP,1000BASE-CWDM, 1270nm~1610nm, SMF, 120km, LC, DOM

**Note:**

1000BASE-CWDM SFP transceiver module is individually tested on corresponding equipment such as Cisco, Arista, Juniper, Dell, Brocade and other brands, and passes the monitoring of FS.COM intelligent quality control system.



 <https://www.fs.com>



The information in this document is subject to change without notice. FS has made all efforts to ensure the accuracy of the information, but all information in this document does not constitute any kind of warranty.