

1000BASE-BX SFP

1490nmTX/1550nmRX

80km DOM Transceiver

SFP-GE-BX80



Application

- Switch to Switch Interface
- Fast Ethernet
- Switched Backplane Applications
- Router/Server Interface
- Other Optical Links

Features

- Operating data rate Up to 1.25Gb/s
- Two types:
 - A:1490nm DFB transmitter /1550nm receiver
 - B:1550nm DFB transmitter/1490nm receiver
- Up to 80km on 9/125µm SMF
- Hot-pluggable SFP footprint
- BIDI LC/UPC type pluggable optical interface
- Low power dissipation
- Metal enclosure, for lower EMI
- RoHS compliant and lead-free
- Support Digital Diagnostic Monitor interface
- Single +3.3V power supply
- Case operating temperature:
 - Commercial: 0° C ~ 70° C
 - Extended: -20° C ~ 85° C
 - Industrial: -40° C ~ 85° C
- Compliant with MSA SFP Specification
- Compliant with SFF-8472
- Compliant with IEEE 802.3z

Description

FS.COM SFP-GE-BX80 SFP transceiver is compatible with the Small Form Factor Pluggable Multi-Sourcing Agreement (MSA). The transceiver consists of five sections: the LD driver, the limiting amplifier, the digital diagnostic monitor, the 1490nm FP laser (the 1550nm DFB laser) and the PIN/TIA. The module data link up to 80km in 9/125um Single-mode fiber.

This transceiver meets the Small Form Pluggable (SFP) industry standard package utilizing an integral LC-Bi-directional optical interface connector. An enhanced Digital Diagnostic Monitoring Interface compliant with SFF-8472 has been incorporated into the transceiver. It allows real time access to the transceiver operating parameters such as transceiver temperature, laser bias current, transmitted optical power, received optical power and transceiver supply voltage by reading a built-in memory with I²C interface.

The optical output can be disabled by a LVTTTL logic high-level input of Tx Disable, and the system also can disable the module via I²C. Tx Fault is provided to indicate that degradation of the laser. Loss of signal (LOS) output is provided to indicate the loss of an input optical signal of receiver or the link status with partner. The system can also get the LOS (or Link)/Disable/Fault information via I²C register access.

Product Specifications

I.General Specifications

Parameter	Symbol	Min	Typ.	Max	Unit
Bit Rate	BR			1.25	Gb/sec
Max.Supported Link Length	Lmax			80	km

II. Absolute Maximum Ratings

Parameter	Symbol	Min	Typ.	Max	Unit	Ref.
Storage Temperature	T_S	-40		85	°C	
Storage Ambient Humidity	H_A	5		95	%	
Power Supply Voltage	V_{CC}	-0.5		4	V	
Signal Input Voltage		-0.3		$V_{CC}+0.3$	V	
Receiver Damage Threshold		+3			dBm	
Lead Soldering Temperature/Time	T_{sold}			260/10	°C/sec	Note 1
Lead Soldering Temperature/Time	T_{sold}			360/10	°C/sec	Note 2

Notes:

1. Suitable for wave soldering.
2. Only for soldering by iron.

III. Electrical Characteristics

Parameter	Symbol	Min	Typ.	Max	Unit	Ref.
		0		70		SFP-GE-BX80-C
Case Operating Temperature	T_{case}	-20		85	°C	SFP-GE-BX80-E
		-40		85		SFP-GE-BX80-I

Parameter	Symbol	Min	Typ.	Max	Unit	Ref.
Ambient Humidity	H_A	5		70	%	Non-condensing
Power Supply Voltage	V_{CC}	3.13	3.3	3.47	V	
Power Supply Current	I_{CC}			280	mA	
Data Rate			1250/1250		Mbps	TX Rate/RX Rate
Transmission Distance				80	km	
Coupled Fiber		Single mode fiber				9/125 μ m G.652

Transmitter

Total Supply Current	I_{CC}			A	mA	
Transmitter Disable Input-High	V_{DISH}	2		$V_{CC}+0.3$	V	Note 1
Transmitter Disable Input-Low	V_{DISL}	0		0.8	V	LVTTTL
Fault Input-High	V_{TxFH}	Transmitter 2		$V_{CC}+0.3$	V	LVTTTL
Transmitter Fault Input-Low	V_{TxFL}	0		0.8	V	LVTTTL

Receiver

Total Supply Current	I_{CC}			B	mA	Note 1
LOS Output Voltage-High	V_{LOSH}	2		$V_{CC}+0.3$	V	LVTTTL
LOS Output Voltage-Low	V_{LOSL}	0		0.8	V	LVTTTL

Note:

1. A (TX) + B (RX) = 280mA (Not include termination circuit)

IV. Optical Characteristics

Parameter	Symbol	Min	Typ.	Max	Unit	Ref.
-----------	--------	-----	------	-----	------	------

Transmitter

Average Output Power	P_{OUT}	-2		+3	dBm	
		-5		0		
Extinction Ratio	ER	9			dB	
Center Wavelength	λ_c	1470	1490	1510	nm	MQEL-K80B45
		1530	1550	1570		MQEL-K80B54
Spectrum Width (RMS)	σ			1	nm	FP Laser(TX:1490nm)
Side Mode Suppression Ratio	SMSR	30			dB	DFB Laser(TX:1550nm)
Spectrum Bandwidth(-20dB)	σ			1	nm	
Transmitter OFF Output Power	P_{OFF}			-45	dBm	
Jitter p-p	t_j			0.1	UI	Note 1
Output Eye Mask	Compliant with IEEE802.3 z (class 1 laser safety)					Note 2

Receiver

Input Optical Wavelength	λ_{IN}	1530	1550	1570	nm	MQEL-K80B45
		1470	1490	1510		MQEL-K80B54

Receiver Sensitivity	P_{IN}			-24	dBm	Note 3
Input Saturation Power (Overload)	P_{SAT}	-3			dBm	
Loss of Signal Assert	P_A	-45			dBm	
Loss of Signal De-assert	P_D			-23.5	dBm	Note 4
LOS Hysteresis	$P_D - P_A$	0.5		6	dB	

Notes:

1. Measure at 2⁷-1 NRZ PRBS pattern.
2. Transmitter eye mask definition.

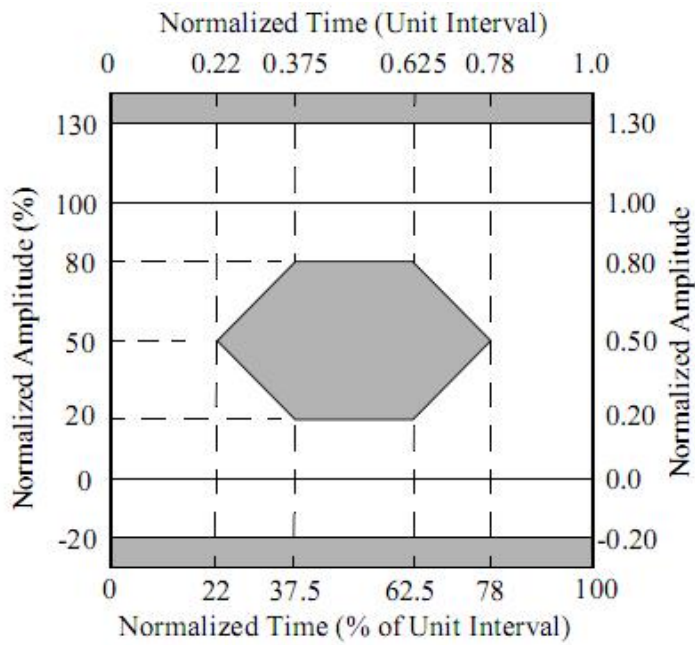

3. Measured with light source 1490nm(1310nm), ER=9dB; BER = 10^{-12} @ PRBS=2⁷-1 NRZ
4. When LOS De-asserted, the RX data+/- output is signal output.

V. Digital Diagnostic Memory Map

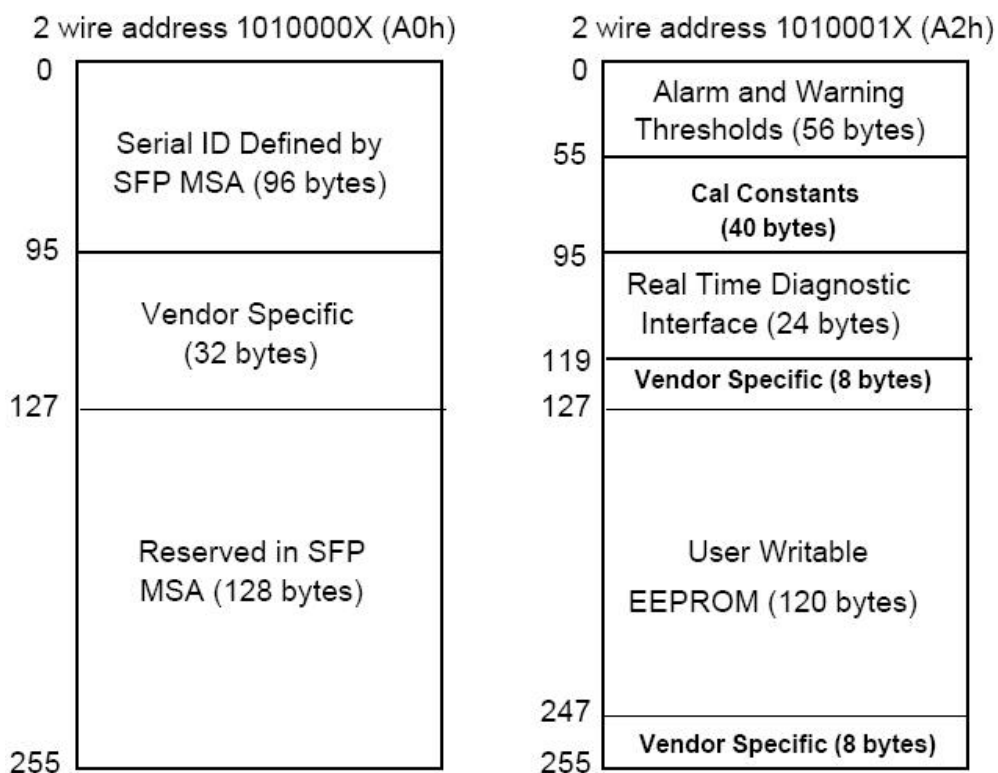

VI. Digital Diagnostic Monitoring Information

Parameter	Unit	Accuracy
Case Temperature	°C	±3
Supply Voltage	V	±3%
TX Bias Current	mA	±10%
TX Optical Power	dB	±3
RX Optical Power	dB	±3

VII. Pin Description

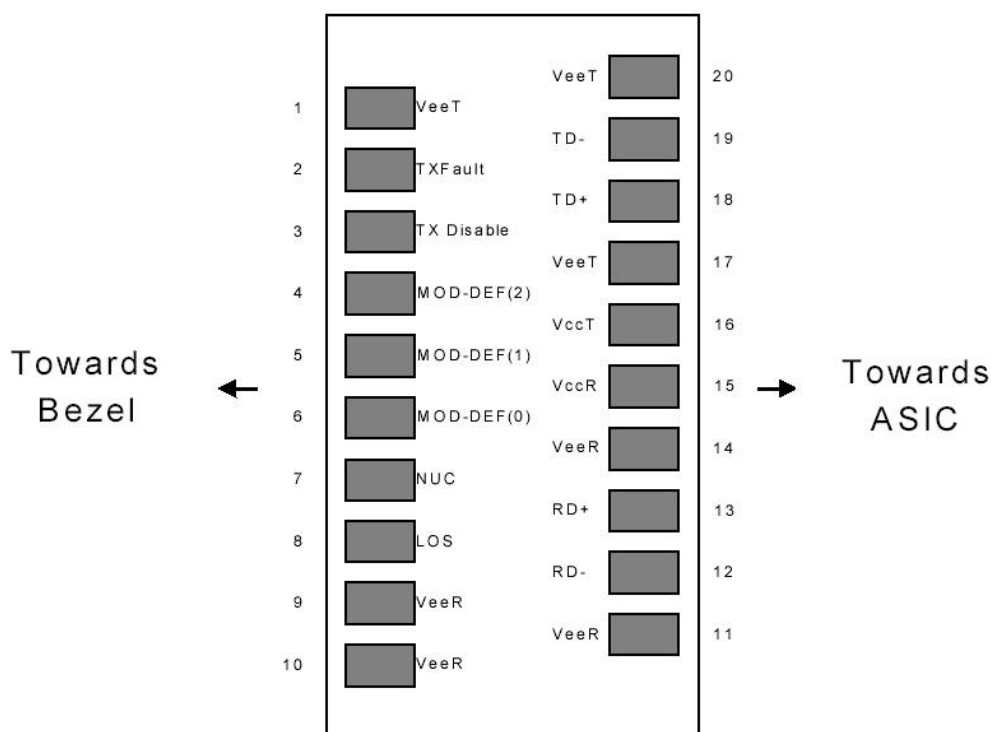

Figure 1. Pin out of Connector Block on Host Board

Pin	Symbol	Name/Description	Ref.
1	V_{EET}	Transmitter Ground (Common with Receiver Ground)	1
2	T_{FAULT}	Transmitter Fault. Open Drain. Logic "0" indicates normal operation.	2
3	T_{DIS}	Transmitter Disable. Laser output disabled on high or open.	3
4	MOD_DEF(2)	Module Definition 2. Data line for Serial ID.	4
5	MOD_DEF(1)	Module Definition 1. Clock line for Serial ID.	4
6	MOD_DEF(0)	Module Definition 0. Grounded within the module.	4
7	Rate Select	No connection required.	

8	LOS	Loss of Signal indication. Open Drain. Logic "0" indicates normal operation.	5
9	V _{EER}	Receiver Ground (Common with Transmitter Ground)	1
10	V _{EER}	Receiver Ground (Common with Transmitter Ground)	1
11	V _{EER}	Receiver Ground (Common with Transmitter Ground)	1
12	RD-	Receiver Inverted DATA out(CML). AC Coupled	
13	RD+	Receiver Non-inverted DATA out(CML). AC Coupled	
14	V _{EER}	Receiver Ground (Common with Transmitter Ground)	1
15	V _{CCR}	Receiver Power Supply	
16	V _{CCT}	Transmitter Power Supply	
17	V _{EET}	Transmitter Ground (Common with Receiver Ground)	1
18	TD+	Transmitter Non-Inverted DATA in. AC Coupled.	
19	TD-	Transmitter Inverted DATA in. AC Coupled.	
20	V _{EET}	Transmitter Ground (Common with Receiver Ground)	1

Notes:

1. Circuit ground is internally isolated from chassis ground.

2. TX Fault is an open drain output, which should be pulled up with 4.7K – 10KΩ resistor on the host board. Pull up voltage between 2.0V to V_{CCT}/R+0.3V. When high, output indicates < 0.8V. When sensing an improper power level in the laser driver, the SFP sets this signal high and turns off the laser. TX-FAULT can be reset with the TX-DISABLE line. The signal is in LVTTTL level.

3. TX disable is an input that is used to shut down the transmitter optical output. It is pulled up within the module with 4.7K – 10K Ω resistor. Its states are: Low (0 – 0.8V): Transmitter on; (>0.8, < 2.0V): Undefined; High (2.0V to $V_{ccT}/R+0.3V$): Transmitter Disabled; Open: Transmitter Disabled. The TX-DISABLE signal is high (LVTTTL logic “1”) to turn off the laser output. The laser will turn on when TX-DISABLE is low (LVTTTL logic “0”).
4. Should be pulled up with 4.7K - 10K Ω on host board to a voltage between 2.0V to $V_{ccT}/R+0.3V$. MOD_DEF (0) pulls line low to indicate module is plugged in.
5. LOS (Loss of Signal) is an open collector/drain output, which should be pulled up with 4.7K – 10K Ω resistor. Pull up voltage between 2.0V to $V_{ccT}/R+0.3V$. When high, this output indicates the received optical power is below the worst-case receiver sensitivity (as defined by the standard in use). Low indicates normal operation. In the low state, the output will be pulled to < 0.8V. The RX-LOS is high (LVTTTL logic “1”) when there is no incoming light from the companion transceiver. This signal is normally used by the system for the diagnostic purpose. The signal is operated in LVTTTL level.

VIII. Recommend Circuit Schematic

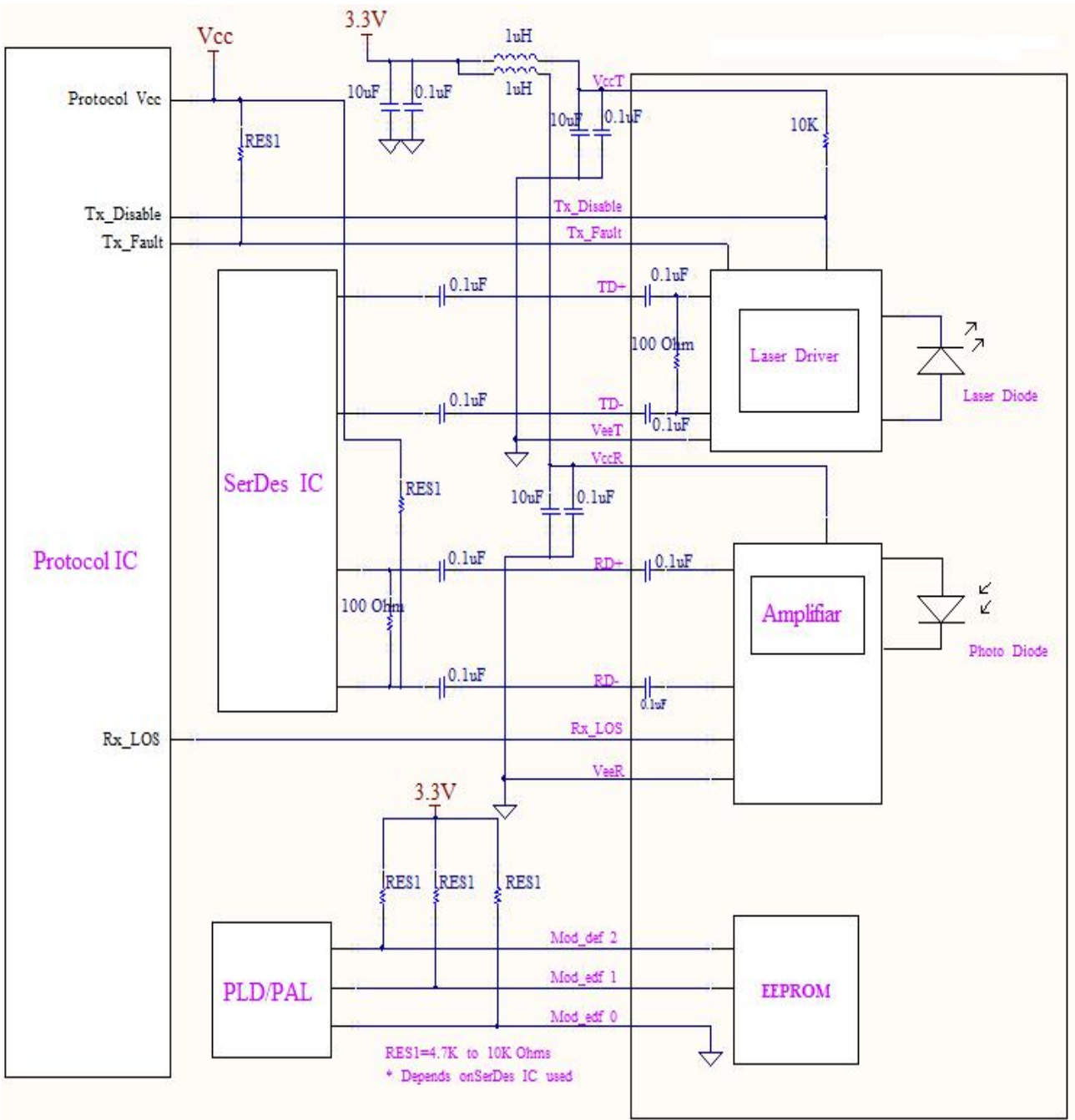

IX. Mechanical Specifications

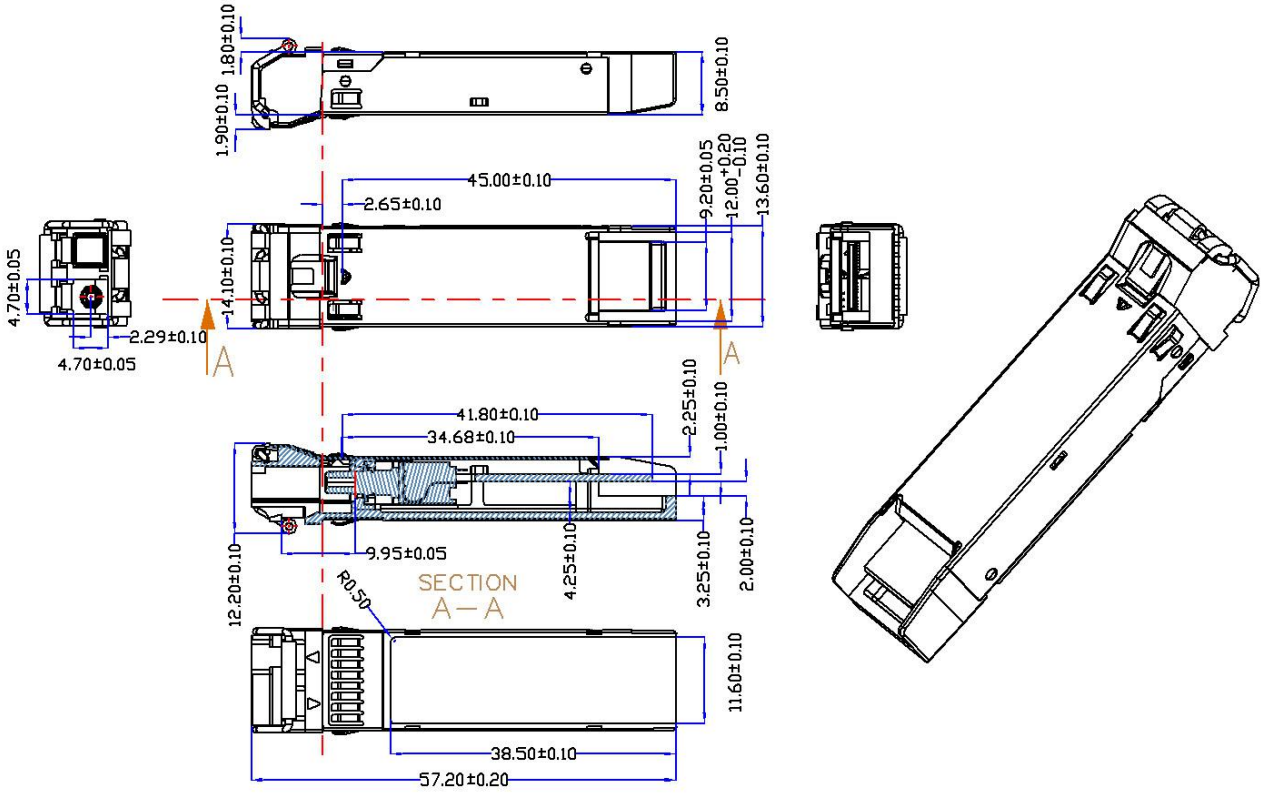

Test Center

FS.COM transceivers are tested to ensure connectivity and compatibility in our test center before shipped out. FS.COM test center is supported by a variety of mainstream original brand switches and groups of professional staff, helping our customers make the most efficient use of our products in their systems, network designs and deployments.

The original switches could be found nowhere but at FS.COM test center, eg: Juniper MX960 & EX 4300 series, Cisco Nexus 9396PX & Cisco ASR 9000 Series, HP 5900 Series & HP 5406R ZL2 V3(J9996A), Arista 7050S-64, Brocade ICX7750-26Q & ICX6610-48, Avaya VSP 7000 MDA 2, etc.



Cisco ASR 9000 Series(A9K-MPA-1X40GE)



ARISTA 7050S-64(DCS-7050S-64)

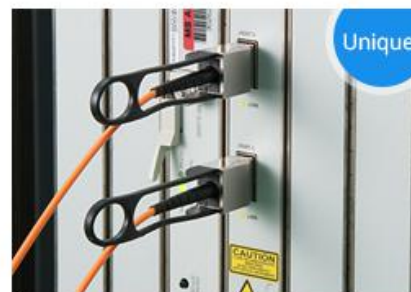

Juniper MX960



Brocade ICX 7750-26Q



Extreme Networks X670V VIM-40G4X



Mellanox M3601Q



Dell N4032F



HP 5406R ZL2 V3(J9996A)



AVAYA 7024XLS(7002QQ-MDA)

Test Assured Program

FS.COM truly understands the value of compatibility and interoperability to each optics. Every module FS.COM provides must run through programming and an extensive series of platform diagnostic tests to prove its performance and compatibility. In our test center, we care of every detail from staff to facilities—professionally trained staff, advanced test facilities and comprehensive original-brand switches, to ensure our customers to receive the optics with superior quality.

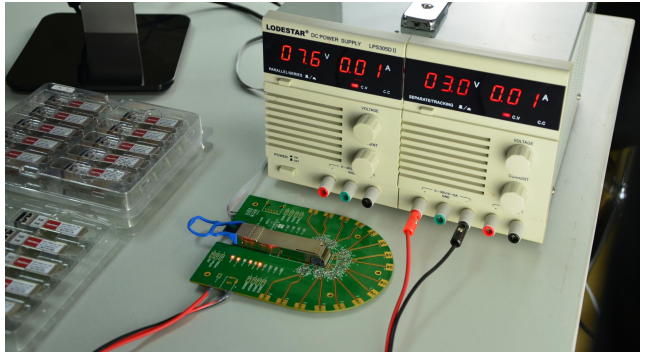

Our smart data system allows effective product management and quality control according to the unique serial number, properly tracking the order, shipment and every part.

Our in-house coding facility programs all of our parts to standard OEM specs for compatibility on all major vendors and systems such as Cisco, Juniper, Brocade, HP, Dell, Arista and so on.



With a comprehensive line of original-brand switches, we can recreate an environment and test each optics in practical application to ensure quality and distance.

The last test assured step to ensure our products to be shipped with perfect package.

Order Information

Part Number	Description
SFP-GE-BX	SFP, BIDI, 1000Base, 1310TX/1490nmRX, SMF, 10km, LC simplex, DOM
SFP-GE-BX	SFP, BIDI, 1000Base, 1490TX/1310nmRX, SMF, 10km, LC simplex, DOM
SFP-GE-BX	SFP, BIDI, 1000Base, 1310TX/1550nmRX, SMF, 10km, LC simplex, DOM
SFP-GE-BX	SFP, BIDI, 1000Base, 1550TX/1310nmRX, SMF, 10km, LC simplex, DOM
SFP-GE-BX	SFP, BIDI, 1000Base, 1310TX/1490nmRX, SMF, 20km, LC simplex, DOM
SFP-GE-BX	SFP, BIDI, 1000Base, 1490TX/1310nmRX, SMF, 20km, LC simplex, DOM
SFP-GE-BX	SFP, BIDI, 1000Base, 1310TX/1550nmRX, SMF, 20km, LC simplex, DOM
SFP-GE-BX	SFP, BIDI, 1000Base, 1550TX/1310nmRX, SMF, 20km, LC simplex, DOM
SFP-GE-BX40	SFP, BIDI, 1000Base, 1310TX/1490nmRX, SMF, 40km, LC simplex, DOM
SFP-GE-BX40	SFP, BIDI, 1000Base, 1490TX/1310nmRX, SMF, 40km, LC simplex, DOM
SFP-GE-BX40	SFP, BIDI, 1000Base, 1310TX/1550nmRX, SMF, 40km, LC simplex, DOM
SFP-GE-BX40	SFP, BIDI, 1000Base, 1550TX/1310nmRX, SMF, 40km, LC simplex, DOM
SFP-GE-BX80	SFP, BIDI, 1000Base, 1490TX/1550nmRX, SMF, 80km, LC simplex, DOM
SFP-GE-BX80	SFP, BIDI, 1000Base, 1550TX/1490nmRX, SMF, 80km, LC simplex, DOM
SFP-GE-BX80	SFP, BIDI, 1000Base, 1490TX/1570nmRX, SMF, 80km, LC simplex, DOM
SFP-GE-BX80	SFP, BIDI, 1000Base, 1570TX/1490nmRX, SMF, 80km, LC simplex, DOM
SFP-GE-BX120	SFP, BIDI, 1000Base, 1490TX/1550nmRX, SMF, 120km, LC simplex, DOM
SFP-GE-BX120	SFP, BIDI, 1000Base, 1550TX/1490nmRX, SMF, 120km, LC simplex, DOM
SFP-GE-BX120	SFP, BIDI, 1000Base, 1510TX/1590nmRX, SMF, 120km, LC simplex, DOM
SFP-GE-BX120	SFP, BIDI, 1000Base, 1590TX/1510nmRX, SMF, 120km, LC simplex, DOM
SFP-GE-2BX	SFP, BIDI, 2-channel, 1000Base, 1550TX/1310nmRX, SMF, 20km, Dual LC, DOM
SFP-GE-2BX	SFP, BIDI, 2-channel, 1000Base, 1310TX/1550nmRX, SMF, 20km, Dual LC, DOM

Note:

BIDI SFP transceiver module is individually tested on corresponding equipment such as Cisco, Arista, Juniper, Dell, Brocade and other brands, and passes the monitoring of FS.COM intelligent quality control system.



 <https://www.fs.com>



The information in this document is subject to change without notice. FS has made all efforts to ensure the accuracy of the information, but all information in this document does not constitute any kind of warranty.