

100GBASE-DR QSFP28 Single Lambda 1310nm 500m DOM Transceiver

QSFP28-DR-100G

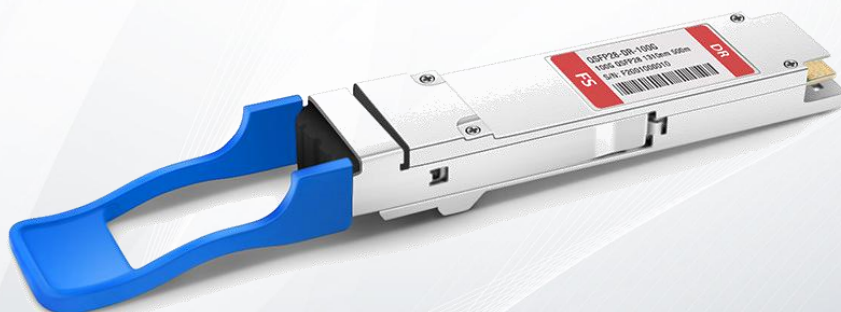

Application

- Data Center Interconnect
- 100G Ethernet
- Enterprise networking

Features

- QSFP28 MSA compliant
- Supports 53.125Gbaud
- Up to 500m transmission on single mode fiber (SMF) with FEC
- Operating case temperature: 0 to 70°C
- Maximum power consumption 4.5W
- 4x25G electrical interface (OIF CEI-28G-VSR)
- IEEE 802.3cd 100GBASE-DR Specification compliant
- LC duplex connector
- RoHS compliant

Description

I. General Description

This product is a transceiver module designed for 500m optical communication applications. The module incorporates one channel optical signal, on 1310nm center wavelength, operating at 50Gbaud data rate. The transmitter path incorporates an EML Driver and a cooled EML together. On the receiver path, the input optical signal is coupled to a Pin photodiode detector. A DSP based gearbox is used to convert 4x25Gbps NRZ signals to 1x50Gbaud PAM4 signal. Also a 4-channel retimer and FEC block are integrated in this DSP. The electrical interface is compliant with IEEE 802.3cd and QSFP28 MSA in the transmitting and receiving directions, and optical interface is compliant to IEEE 802.3cd and 100G Lambda MSA with Duplex LC connector. The module has a maximum power consumption of 4.5W. The product is designed with form factor, optical/electrical connection and digital diagnostic interface according to the QSFP28 Multi-Source Agreement (MSA). It has been designed to meet the harshest external operating conditions including temperature, humidity and EMI interference.

II. Functional Description

This product converts the 4-channel of 100Gbps aggregated NRZ electrical input data into one channel of 50Gbaud PAM4 optical signal (light) on 1310nm center wavelength through a DSP based gearbox, by a driven cooled Electro-absorption Modulated DFB Laser (EML). The light propagates out of the transmitter into an SMF fiber. The receiver module accepts the 50Gbaud PAM4 optical signal input, and converts it into a 50Gbaud PAM4 electrical signal via a linear amplifier. And then convert the 50Gbaud PAM4 signal into 4 channels of 25Gbps NRZ signals. Figure 1 shows the functional block diagram of this product.

A single +3.3V power supply is required to power up this product. Both power supply pins VccTx and VccRx are internally connected and should be applied concurrently. As per MSA specifications the module offers seven low speed hardware control pins (including the 2-wire serial interface): ModSelL, SCL, SDA, ResetL, LPMode, ModPrsL and IntL.

Module Select (ModSelL) is an input pin. When held low by the host, this product responds to 2-wire serial communication commands. The ModSelL allows the use of this product on a single 2-wire interface bus – individual ModSelL lines must be used.

Serial Clock (SCL) and Serial Data (SDA) are required for the 2-wire serial bus communication interface and enable the host to access the memory map.

The ResetL pin enables a complete reset, returning the settings to their default state, when a low level on the ResetL pin is held for longer than the minimum pulse length. During the execution of a reset the host shall disregard all status bits until it indicates a completion of the reset interrupt. The product indicates this by posting an IntL (Interrupt) signal with the Data_Not_Ready bit negated in the memory map. Note that on power up (including hot insertion) the module should post this completion of reset interrupt without requiring a reset.

Low Power Mode (LPMode) pin is used to set the maximum power consumption for the product in order to protect hosts that are not capable of cooling higher power modules, should such modules be accidentally inserted.

Module Present (ModPrsL) is a signal local to the host board which, in the absence of a product, is normally pulled up to the host Vcc. When the product is inserted into the connector, it completes the path to ground through a resistor on the host board and asserts the signal. ModPrsL then indicates its present by setting ModPrsL to a “Low” state.

Interrupt (IntL) is an output pin. “Low” indicates a possible operational fault or a status critical to the host system. The host identifies the source of the interrupt using the 2-wire serial interface. The IntL pin is an open collector output and must be pulled to the Host Vcc voltage on the Host board.

Product Specifications

I. Absolute Maximum Ratings

It has to be noted that the operation in excess of any individual absolute maximum ratings might cause permanent damage to this module.

Parameter	Symbol	Min	Typ.	Max	Unit	Ref.
Storage Temperature	T_s	-40		85	°C	
Operating Case Temperature	T_{OP}	0		70	°C	
Power Supply Voltage	V_{CC}	-0.5		3.6	V	
Relative Humidity (non-condensation)	RH	0		85	%	
Damage Threshold	TH_d	5			dBm	

II. Recommended Operating Conditions and Power Supply Requirements

Parameter	Symbol	Min	Typ.	Max	Unit	Ref.
Operating Case Temperature	T_{OP}	0		70	°C	
Power Supply Voltage	V_{CC}	3.135	3.3	3.465	V	
Electrical Data Rate, each Lane (NRZ)			25.78125		Gb/s	
Optical Data Rate (PAM4)			53.125		GBd	
Data Rate Accuracy		-100		100	ppm	
Pre-FEC Bit Error Ratio				2.4×10^{-4}		
Post-FEC Bit Error Ratio				1×10^{-12}		1
Control Input Voltage High		2		V_{CC}	V	
Control Input Voltage Low		0		0.8	V	

Link Distance with G.652	D	2		500	m	2
---------------------------------	---	---	--	-----	---	---

Notes:

- 1.FEC feature is embedded in the module.
- 2.FEC required to be turned on to support maximum transmission distance.

III. Optical Characteristics

Parameter	Symbol	Min	Typ.	Max	Unit	Ref.
Transmitter						
Center Wavelength	λ_t	1304.5		1317.5	nm	
Side Mode Suppression Ratio	SMSR	30			dB	
Average Launch Power	P_{AVG}	-2.9		4	dBm	1
Outer Optical Modulation Amplitude (OMA_{outer})	P_{OMA}	-0.8		4.2	dBm	2
Launch Power in OMA_{outer} minus TDECQ for $ER \geq 5dB$		-2.2			dBm	
Launch Power in OMA_{outer} minus TDECQ for $ER < 5dB$		-1.9			dBm	
Transmitter and Dispersion Eye Closure for PAM4 (TDECQ)	TDECQ			3.4	dB	
TDECQ – $10 \cdot \log_{10}(C_{eq})$				3.4	dB	3
Extinction Ratio	ER	3.5			dB	
$RIN_{15.5OMA}$	RIN			-136	dB/Hz	
Optical Return Loss Tolerance	TOL			15.5	dB	
Transmitter Reflectance	R_T			-26	dB	
Transmitter Transition Time				17	ps	
Average Launch Power of OFF Transmitter	P_{off}			-15	dBm	

Receiver

Center Wavelength	λ_r	1304.5		1317.5	nm	
Damage Threshold	TH_d	5			dBm	4
Average Receive Power		-5.9		4	dBm	5
Receive Power (OMA_{outer})				4.2	dBm	
Receiver Sensitivity (OMA_{outer})	SEN			Equation (1)	dBm	6
Stressed Receiver Sensitivity (OMA_{outer})	SRS			-1.9	dBm	7
Receiver Reflectance	R_R			-26	dB	
LOS Assert	LOSA	-15			dBm	
LOS Deassert	LOSD			-8.9	dBm	
LOS Hysteresis	LOSH	0.5			dB	
Conditions of Stress Receiver Sensitivity Test (Note 8)						
Stressed Eye Closure for PAM4 (SECQ)				3.4	dB	
SECQ – $10 \cdot \log_{10}(C_{eq})$				3.4	dB	

Notes:

1. Average launch power (min) is informative and not the principal indicator of signal strength. A transmitter with launch power below this value cannot be compliant; however, a value above this does not ensure compliance.
2. Even if the TDECQ < 1.4dB for an extinction ratio of ≥ 5 dB or TDECQ < 1.1dB for an extinction ratio of < 5dB, the OMA_{outer} (min) must exceed the minimum value specified here.
3. C_{eq} is a coefficient defined in IEEE Std 802.3-2018 clause 121.8.5.3 which accounts for reference equalizer noise enhancement.
4. Average receive power (min) is informative and not the principal indicator of signal strength. A received power below this value cannot be compliant; however, a value above this does not ensure compliance.
5. The receiver shall be able to tolerate, without damage, continuous exposure to a modulated optical input signal having this power level on one lane. The receiver does not have to operate correctly at this input power.
6. Receiver sensitivity (OMA_{outer}) (max) is informative and is defined for a transmitter with a value of SECQ up to 3.4 dB. It should meet Equation (1), which is illustrated in Figure 4.

$$R S = \max(-3.9, S E Q - 5.3) \text{ dB} \quad (1)$$

Where:

RS is the receiver sensitivity, and

SECQ is the SECQ of the transmitter used to measure the receiver sensitivity.

7. Measured with conformance test signal at TP3 for the BER equal to 2.4×10^{-4} .

8. These test conditions are for measuring stressed receiver sensitivity. They are not characteristics of the receiver.

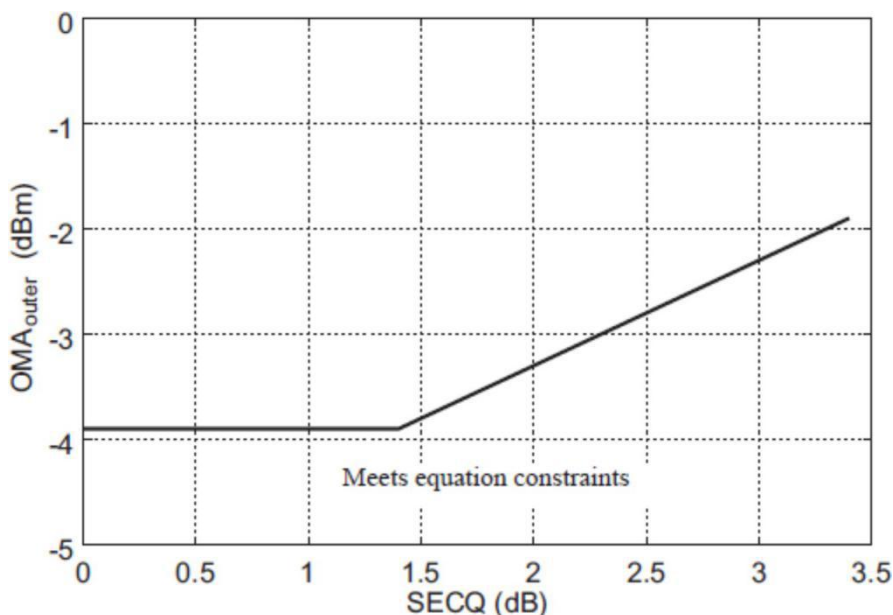

Figure 1 – Illustration of Receiver Sensitivity Mask for 100G-DR

IV. Electrical Characteristics

The following electrical characteristics are defined over the Recommended Operating Environment unless otherwise specified.

Parameter	Symbol	Min	Typ.	Max	Unit	Ref.
Power Consumption				4.5	W	
Supply Current	I _{cc}			1.36	A	
Transmitter (each Lane)						
Overload Differential Voltage pk-pk	TP1a	900			mV	
Common Mode Voltage (V_{cm})	TP1	-350		2850	mV	1

Differential Termination Resistance Mismatch	TP1			10	%	At 1MHz
Differential Return Loss (SDD11)	TP1			See CEI- 28G-VSR Equation 13-19	dB	
Common Mode to Differential Conversion and Differential to Common Mode Conversion (SDC11,SCD11)	TP1			See CEI- 28G-VSR Equation 13-20	dB	
Stressed Input Test	TP1a	See CEI- 28G-VSR Section 13.3.11.2.1				

Receiver (each Lane)

Differential Voltage, pk-pk	TP4			900	mV	
Common Mode Voltage (Vcm)	TP4	-350		2850	mV	1
Common Mode Noise, RMS	TP4			17.5	mV	
Differential Termination Resistance Mismatch	TP4			10	%	At 1MHz
Differential Return Loss (SDD22)	TP4			See CEI- 28G-VSR Equation 13-19	dB	
Common Mode to Differential Conversion and Differential to Common Mode Conversion (SDC22,SCD22)	TP4			See CEI- 28G-VSR Equation 13-21	dB	
Common Mode Return Loss (SCC22)	TP4			-2	dB	2
Transition Time, 20 to 80%	TP4	9.5			ps	
Vertical Eye Closure (VEC)	TP4			5.5	dB	
Eye Width at 10⁻¹⁵ probability (EW15)	TP4	0.57			UI	
Eye Height at 10⁻¹⁵ probability (EH15)	TP4	228			mV	

Notes:

- 1.Vcm is generated by the host. Specification includes effects of ground offset voltage
- 2.From 250MHz to 30GHz.

V. Digital Diagnostic Functions

The following digital diagnostic characteristics are defined over the normal operating conditions unless otherwise specified.

Parameter	Symbol	Min	Max	Unit	Ref.
Temperature Monitor Absolute Error	DMI_Temp	-3	3	°C	Over operating temperature range
Supply Voltage Monitor Absolute Error	DMI_VCC	-0.1	0.1	V	Over full operating range
RX Power Monitor Absolute Error	DMI_RX	-2	2	dB	1
Bias Current Monitor	DMI_Ibias	-10%	10%	mA	
TX Power Monitor Absolute Error	DMI_TX	-2	2	dB	1

Notes:

1. Due to measurement accuracy of different single mode fibers, there could be an additional +/- dB fluctuation, or a +/- 3 dB total accuracy.

VI. Transceiver Block Diagram

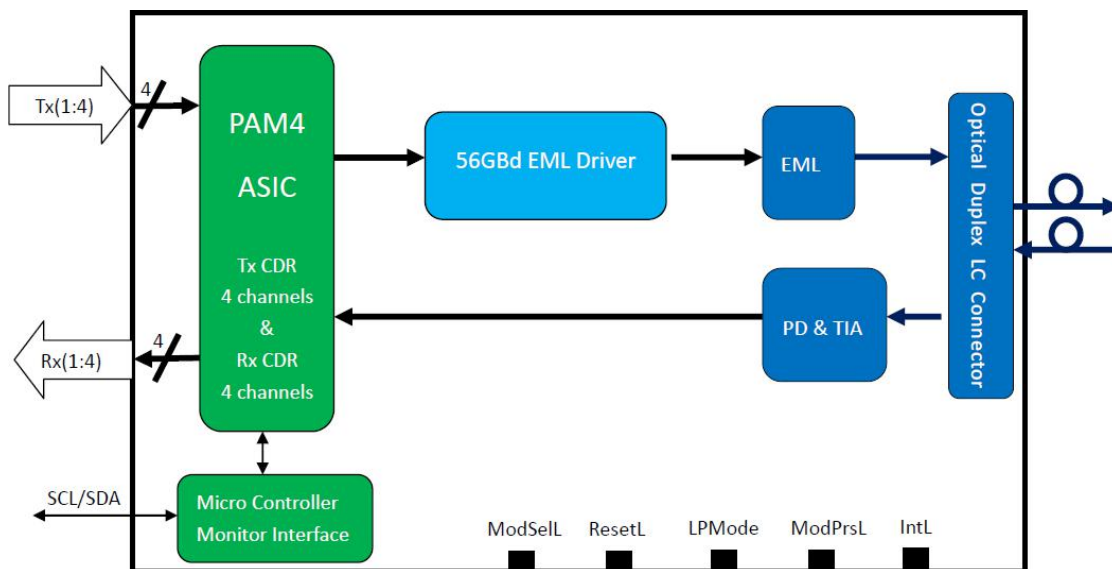

Figure 2 – Transceiver Block Diagram

VII. PIN Assignment and Description

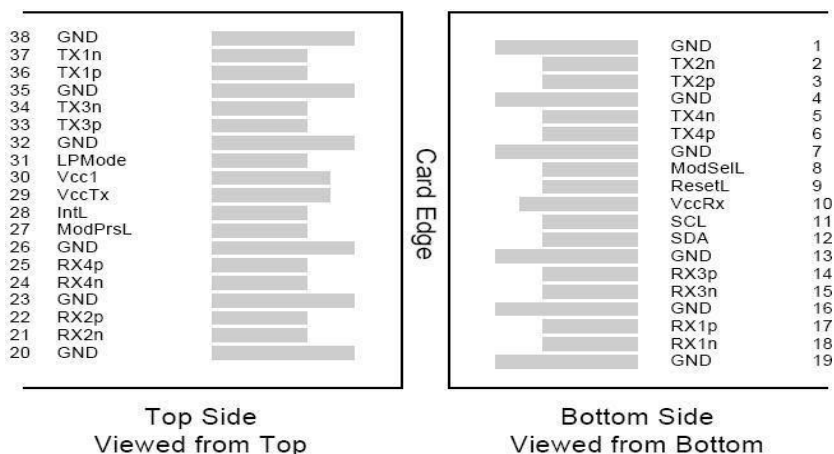

Figure 3 – MSA Compliant Connector

Pin	Logic	Symbol	Description	Notes
1		GND	Ground	1
2	CML-I	Tx2n	Transmitter Inverted Data Input	
3	CML-I	Tx2p	Transmitter Non-Inverted Data output	
4		GND	Ground	1
5	CML-I	Tx4n	Transmitter Inverted Data Input	
6	CML-I	Tx4p	Transmitter Non-Inverted Data output	
7		GND	Ground	1
8	LVTLL-I	ModSelL	Module Select	
9	LVTLL-I	ResetL	Module Reset	
10		VccRx	+3.3 V Power Supply Receiver	2
11	LVCNOS-I/O	SCL	2-Wire Serial Interface Clock	
12	LVCNOS-I/O	SDA	2-Wire Serial Interface Data	
13		GND	Ground	
14	CML-O	Rx3p	Receiver Non-Inverted Data Output	
15	CML-O	Rx3n	Receiver Inverted Data Output	
16		GND	Ground	1

17	CML-O	Rx1p	Receiver Non-Inverted Data Output	
18	CML-O	Rx1n	Receiver Inverted Data Output	
19		GND	Ground	1
20		GND	Ground	1
21	CML-O	Rx2n	Receiver Inverted Data Output	
22	CML-O	Rx2p	Receiver Non-Inverted Data Output	
23		GND	Ground	1
24	CML-O	Rx4n	Receiver Inverted Data Output	1
25	CML-O	Rx4p	Receiver Non-Inverted Data Output	
26		GND	Ground	1
27	LVTTTL-O	ModPrsL	Module Present	
28	LVTTTL-O	IntL	Interrupt	
29		VccTx	+3.3V Power supply transmitter	2
30		Vcc1	+3.3V Power supply	2
31	LVTTTL-I	LPMODE	Low Power Mode	
32		GND	Ground	1
33	CML-I	Tx3p	Transmitter Non-Inverted Data Input	
34	CML-I	Tx3n	Transmitter Inverted Data Output	
35		GND	Ground	1
36	CML-I	Tx1p	Transmitter Non-Inverted Data Input	
37	CML-I	Tx1n	Transmitter Inverted Data Output	
38		GND	Ground	1

Notes:

1. GND is the symbol for signal and supply (power) common for QSFP28 modules. All are common within the QSFP28 module and all module voltages are referenced to this potential unless otherwise noted. Connect these directly to the host board signal common ground plane.
2. VccRx, Vcc1 and VccTx are the receiving and transmission power suppliers and shall be applied concurrently. Recommended host board power supply filtering is shown in Figure 3 below. Vcc Rx, Vcc1 and Vcc Tx may be internally connected within the QSFP28 transceiver module in any combination. The connector pins are each rated for a maximum current of 1000mA.

VIII. Recommended Power Supply Filter

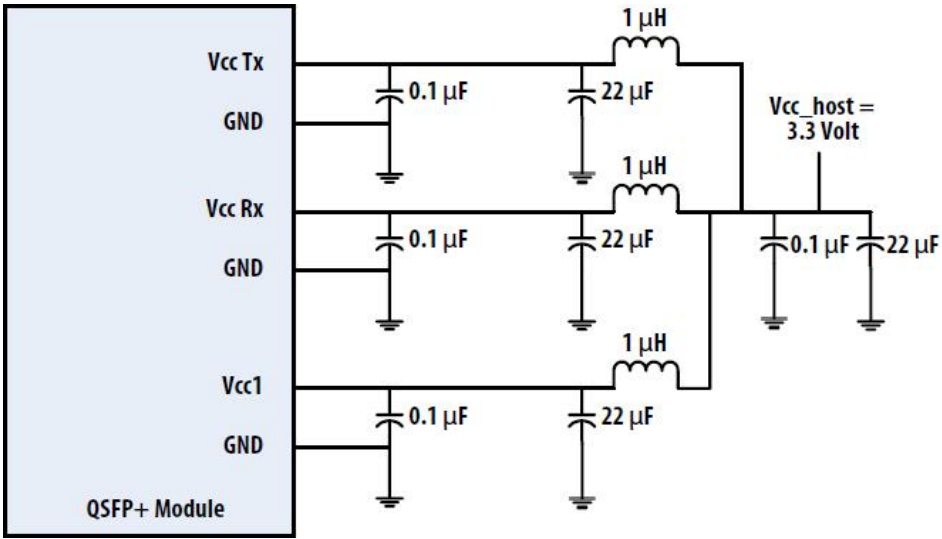

Figure 4 – Recommended Power Supply Filter

IX. Mechanical Dimensions

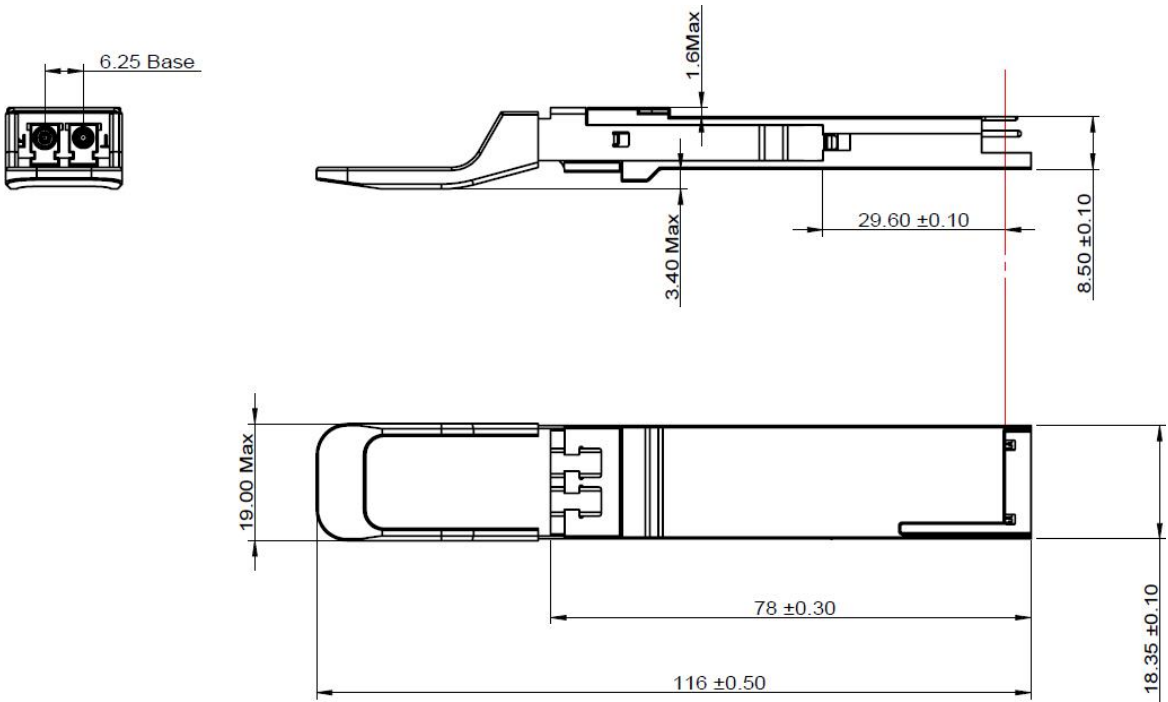

Figure 5 – Mechanical Outline

X. ESD

This transceiver is specified as ESD threshold 1kV for high speed data pins and 2kV for all other electrical input pins, tested per MIL-STD-883, Method 3015.4 /JESD22-A114-A (HBM). However, normal ESD precautions are still required during the handling of this module. This transceiver is shipped in ESD protective packaging. It should be removed from the packaging and handled only in an ESD protected environment.

XI. Laser Safety

This is a Class 1 Laser Product according to EN 60825-1:2014. This product complies with 21 CFR 1040.10 and 1040.11 except for deviations pursuant to Laser Notice No. 50, dated (June 24, 2007).

Caution: Use of controls or adjustments or performance of procedures other than those specified herein may result in hazardous radiation exposure.

Test Center

FS.COM transceivers are tested to ensure connectivity and compatibility in our test center before shipped out. FS.COM test center is supported by a variety of mainstream original brand switches and groups of professional staff, helping our customers make the most efficient use of our products in their systems, network designs and deployments.

The original switches could be found nowhere but at FS.COM test center, eg: Juniper MX960 & EX 4300 series, Cisco Nexus 9396PX & Cisco ASR 9000 Series, HP 5900 Series & HP 5406R ZL2 V3(J9996A), Arista 7050S-64, Brocade ICX7750-26Q & ICX6610-48, Avaya VSP 7000 MDA 2, etc.



Cisco ASR 9000 Series(A9K-MPA-1X40GE)



ARISTA 7050S-64(DCS-7050S-64)

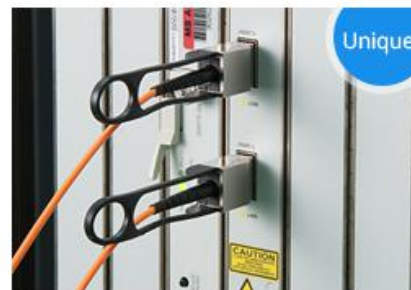

Juniper MX960



Brocade ICX 7750-26Q



Extreme Networks X670V VIM-40G4X



Mellanox M3601Q



Dell N4032F



HP 5406R ZL2 V3(J9996A)



AVAYA 7024XLS(7002QQ-MDA)

Test Assured Program

FS.COM truly understands the value of compatibility and interoperability to each optics. Every module FS.COM provides must run through programming and an extensive series of platform diagnostic tests to prove its performance and compatibility. In our test center, we care of every detail from staff to facilities—professionally trained staff, advanced test facilities and comprehensive original-brand switches, to ensure our customers to receive the optics with superior quality.



Our smart data system allows effective product management and quality control according to the unique serial number, properly tracing the order, shipment and every part.

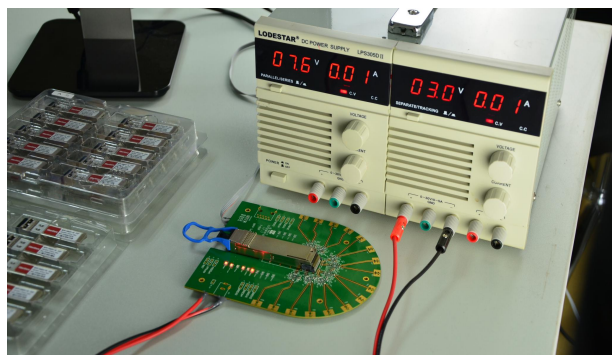

Our in-house coding facility programs all of our parts to standard OEM specs for compatibility on all major vendors and systems such as Cisco, Juniper, Brocade, HP, Dell, Arista and so on.



With a comprehensive line of original-brand switches, we can recreate an environment and test each optics in practical application to ensure quality and distance.



The last test assured step to ensure our products to be shipped with perfect package.

Order Information

Part Number	Description
QSFP28-SR4-100G	QSFP28 100GBASE-SR4 850nm 100m Transceiver
QSFP28-LR4-100G	QSFP28 100GBASE-LR4 1310nm 10km Transceiver
QSFP28-PIR4-100G	QSFP28 100GBASE-PSM4 1310nm 500m Transceiver
QSFP28-IR4-100G	QSFP28 100GBASE-CWDM4 1310nm 2km Transceiver
QSFP28-EIR4-100G	QSFP28 100GBASE-eCWDM4 1310nm 10km Transceiver
QSFP28-ER4-100G	QSFP28 100GBASE-ER4 1310nm 40km Transceiver
QSFP28-LR4-100G-I	QSFP28 100GBASE-LR4 1310nm 10km Industrial Transceiver
QSFP28-LR4-100G	QSFP28 100GBASE-LR4 and 112GBASE-OTU4 Dual Rate 1310nm 10km Transceiver
QSFP28-LR4-100G	QSFP28 100GBASE-LR4 and 112GBASE-OTU4 Dual Rate 1310nm 20km Transceiver
QSFP28-LR4-100G	QSFP28 100GBASE-LR4 and 112GBASE-OTU4 Dual Rate 1310nm 25km Transceiver
QSFP28-ER4-100G	QSFP28 100GBASE-ER4 and 112GBASE-OTU4 Dual Rate 1310nm 30km Transceiver
QSFP28-ER4-100G	QSFP28 100GBASE-ER4 and 112GBASE-OTU4 Dual Rate 1310nm 40km Transceiver
QSFP28-DR-100G	QSFP28 100GBASE-DR Single Lambda 1310nm 500m Transceiver
QSFP28-FR-100G	QSFP28 100GBASE-FR Single Lambda 1310nm 2km Transceiver
QSFP28-LR-100G	QSFP28 100GBASE-LR Single Lambda 1310nm 10km Transceiver



 <https://www.fs.com>



The information in this document is subject to change without notice. FS has made all efforts to ensure the accuracy of the information, but all information in this document does not constitute any kind of warranty.