

100BASE-BX BiDi SFP 1310nm-TX/1550nm-RX 20km DOM LC SMF Transceiver

SFP-FE-BX



Applications

- Fast Ethernet
- SDH STM-1/ SONET OC-03
- WDM Application

Features

- Single Mode bi-directional Transmission
- SFP Multi-source Package with LC Receptacle
- Up to 155Mb/s Data Links
- Hot-Pluggable Capability
- Up to 20 km on 9/125 μ m SMF
- Single +3.3V Power Supply
- Built-in WDM
- Isolation > 30dB, Cross Talk < -45dB
- Metal Enclosure, Excellent EMI & ESD Protection
- Monitoring Interface Compliant with SFF-8472
- Compliant with Specifications for IEEE802.3
- Compliant with Bellcore TA-NWT-000983
- Eye Safety Designed to Meet Laser Class1, Compliant with IEC60825-1
- RoHS Compliant

Description

Bi-Directional transceiver is a high performance, cost effective module, which is compliant with LC Optics interface with built in WDM for Bi-Directional serial optical data communication applications. This module is designed for Single-Mode single fiber, operates at the normal wavelength of 1310/1550nm.

Product Specifications

I. Absolute Maximum Ratings

Parameter	Symbol	Min.	Typical	Max.	Unit	
Storage Temperature	T_s	-40		+85	°C	
Supply Voltage	$V_{CC,T,R}$	-0.5		4	V	
Relative Humidity	RH	0		85	%	
Case Operating Temperature	Industrial	Top	-40		85	°C
	Extended		-5		85	
	Commercial		0		70	

II. Recommended Operating Environment

Parameter	Symbol	Min.	Typical	Max.	Unit	
Case Operating Temperature	Industrial	TC	-40		85	°C
	Extended		-5		85	
	Commercial		0		+70	
Supply Voltage	$V_{CC,T,R}$	3.0		3.6	V	

III. Electrical Characteristics (TOP = 0 to 70 ° C, $V_{CC} = 3.0$ to 3.60 Volts)

Parameter	Symbol	Min.	Typical	Max.	Unit	Note
Supply Voltage	V_{CC}	3.0	3.30	3.60	V	
Supply Current	I_{CC}			300	mA	
Inrush Current	I_{surge}			$I_{CC}+30$	mA	
Maximum Power	P_{max}			1.0	W	
Transmitter Section						
Input Differential Impedance	R_{in}	90	100	110	W	1
Single Ended Data Input Swing	$V_{in,PP}$	200		1200	mVp-p	
Transmit Disable Voltage	V_D	$V_{CC}-1.3$		V_{CC}	V	2
Transmit Enable Voltage	V_{EN}	V_{ee}		$V_{ee}+0.8$	V	
Transmit Disable Assert Time	$T_{dessert}$			10	us	
Receiver Section						
Single Ended Data Output Swing	$V_{out, pp}$	300		1000	mv	3
Data Output Rise Time	t_r			1300	ps	4
Data Output Fall Time	t_f			1300	ps	4
LOS Fault	$V_{losfault}$	$V_{CC}-0.5$		V_{CC_host}	V	5
LOS Normal	$V_{los norm}$	V_{ee}		$V_{ee}+0.5$	V	5
Power Supply Rejection	PSR	100			mVpp	6

Note:

1. AC coupled.
2. Or open circuit.
3. Into 100 ohm differential termination.
4. 20 – 80 %
5. LOS is LVTTTL. Logic 0 indicates normal operation; logic 1 indicates no signal detected.
6. All transceiver specifications are compliant with a power supply sinusoidal modulation of 20 Hz to 1.5MHz up to specified value applied through the power supply filtering network shown on page 23 of the Small Form-factor Pluggable (SFP) Transceiver Multi-Source Agreement (MSA), September 14, 2000.

IV. Optical Parameters (TOP = 0 to 70 ° C, V_{CC} = 3.0 to 3.60 Volts)

Parameter	Symbol	Min.	Typical	Max.	Unit	Note
Transmitter Section						
Center Wavelength	λ_c	1270	1310	1360	nm	1
Spectral Width	σ			3	nm	
Optical Output Power	P_{out}	-15		-8	dBm	2
Optical Rise/Fall Time	t_r/t_f			1300	ps	3
Extinction Ratio	ER	9.2			dB	
Eye Mask for Optical Output	Compliant with Eye Mask Defined in IEEE 802.3 standard					
Relative Intensity Noise	RIN			-120	dB/Hz	
Receiver Section						
Optical Input Wavelength	λ	1480	1550	1580	nm	
Optical Input Power	P_{in}	-34		-3	dBm	4.5
Receiver Reflectance		12			dB	

Parameter	Symbol	Min.	Typical	Max.	Unit	Note
Receiver Overload	Pol			-3	dBm	4.5
RX Sensitivity	Sen			-34	dBm	4.5
RX_LOS Assert	LOSA	-45			dBm	
RX_LOS Deassert	LOSD			-35	dBm	
RX_LOS Hysteresis	LOSH		2	2.5	dB	
General Specifications						
Data Rate	BR		155		Mb/s	
Bit Error Rate	BER			10 ⁻¹²		
Max.Supported Link Length on 9/125 μm SMF @ 1.25G	LMAX		20		km	6
Total System Budget	LB	19			dB	6

Notes:

1. Also specified to meet curves in FC-PI 13.0 Figures 18 and 19, which allow trade-off between wavelength spectral width.
2. Class 1 Laser Safety per FDA/CDRH and EN (IEC) 60825 regulations.
3. Unfiltered, 20-80%. Complies with IEEE 802.3 (Gig. E), FC 1x and 2x eye masks when filtered.
4. Measured with conformance signals defined in FC-PI 13.0 specifications.
5. Measured with PRBS 231 -1at 10-12 BER
6. Dispersion limited per FC-PI Rev. 13
7. Attenuation of 0.45 dB/km is used for the link length calculations. Distances are indicative only. Please refer to the Optical Specifications in Table IV to calculate a more accurate link budget based on specific conditions in your application.

V. Digital Diagnostic Monitor Characteristics

The following digital diagnostic characteristics are defined over the Recommended Operating Environment unless otherwise specified. It is compliant to SFF8472 Rev10.2 with internal calibration mode. For external calibration mode please contact our sales staff.

Parameter	Symbol	Min.	Max.	Unit
Temperature Monitor Absolute Error	DMI_Temp	-3	3	degC
Laser Power Monitor Absolute Error	DMI_TX	-3	3	dB
RX Power Monitor Absolute Error	DMI_RX	-3	3	dB
Supply Voltage Monitor Absolute Error	DMI_Vcc	-0.1	0.1	V
Bias Current Monitor Absolute Error	DMI_Ibias	-10%	10%	mA

VI. Digital Diagnostic Monitor Characteristics

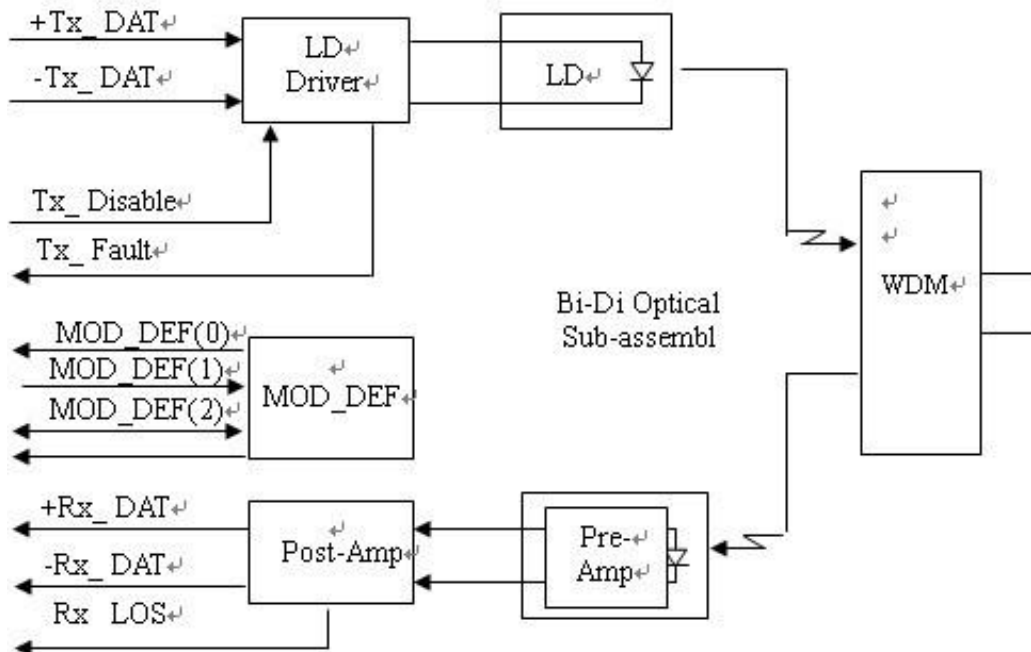

Figure1: Block Diagram

VII. Pin Description

Pin No	Name	Function	Plug Seq	Notes
1	V_{eeT}	Transmitter Ground	1	1
2	TX Fault	Transmitter Fault Indication	3	
3	TX Disable	Transmitter Disable	3	2
4	MOD-DEF2	Module Definition	2	3
5	MOD-DEF1	Module Definition 1	3	3
6	MOD-DEF0	Module Definition 0	3	3
7	Rate Select	Not Connected	3	4
8	LOS	Loss of Signal	3	5
9	V_{eeR}	Receiver Ground	1	1
10	V_{eeR}	Receiver Ground	1	1
11	V_{eeR}	Receiver Ground		1
12	RD-	Inv.Received Data Out	3	6
13	RD+	Received Data Out	3	6
14	V_{eeR}	Receiver Ground	3	1
15	V_{ccR}	Receiver Power	2	1
16	V_{ccT}	Transmitter Power	2	

Pin No	Name	Function	Plug Seq	Notes
17	V _{ee} T	Transmitter Ground	1	
18	TD+	Transmit Data In	3	6
19	TD-	Inv.TransmitIn	3	6
20	V _{ee} T	Transmitter Ground	1	

Notes:

1. Circuit ground is internally isolated from chassis ground.
2. Laser output disabled on TDIS >2.0V or open, enabled on TDIS <0.8V.
3. Should be pulled up with 4.7k - 10 kohms on host board to a voltage between 2.0V and 3.6V.MOD_DEF(0) pulls line low to indicate module is plugged in.
4. Rate select is not used.
5. LOS is open collector output. Should be pulled up with 4.7k – 10 kohms on host board to a voltage between 2.0V and 3.6V. Logic 0 indicates normal operation; logic 1 indicates loss of signal.
6. AC Coupled.

VII. Recommended Circuit

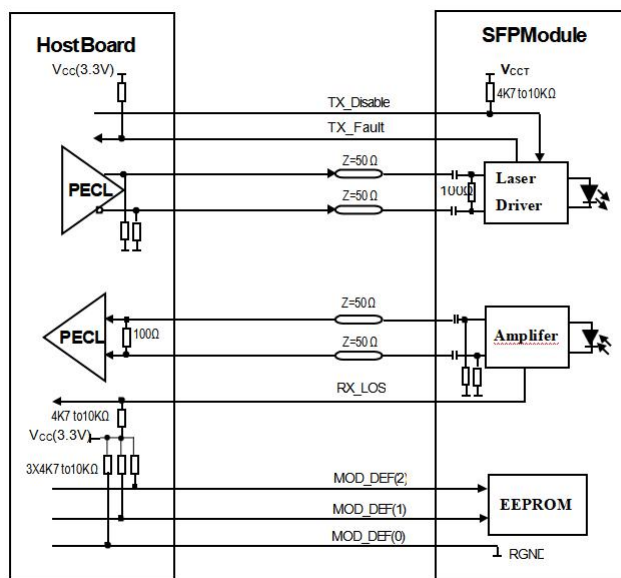

Figure 2 . SFP Host Recommended Circuit

Data Address	Length(Byte)	Name of Length	Description and Contents
Base ID Fields			
0	1	Identifier	Type of Serial transceiver (03h=SFP)
1	1	Reserved	Extended identifier of type serial transceiver(04h)
2	1	Connector	Code of optical connector type (07=LC)
3-10	8	Transceiver	Fast Ethernet 100Base-BX
11	1	Encoding	4B 5B(02h)
12	1	BR, Nominal	Nominal baud rate, unit of 100Mbps
13	1	Reserved	(0000h)
14	1	Length (9um,km)	Link length supported for 9/125um fiber, units of km
15	1	Length (9um)	Link length supported for 9/125um fiber, units of 100m
16	1	Length (50um)	Link length supported for 50/125um fiber, units of 10m
17	1	Length (62.5um)	Link length supported for 62.5/125um fiber, units of 10m
18	1	Length (Copper)	Link length supported for copper, units of meters
19	1	Reserved	
20-35	16	Vendor Name	SFP vendor name:
36	1	Reserved	
37-39	3	Vendor OUI	SFP transceiver vendor OUI ID

Data Address	Length(Byte)	Name of Length	Description and Contents
40-55	16	Vendor PN	PartNumber: "FSXXXXXX" (ASCII)
56-59	4	Vendor rev	Revision level for part number
60-61	2	Wavelength	Laser wavelength
62	1	Reserved	
63	1	CCID	Least significant byte of sum of data in address 0-62
Extended ID Fields			
64-65	2	Option	Indicates which optical SFP signals are implemented (001Ah=LOS, TX_FAULT, TX_DISABLE all supported)
66	1	BR, max	Upper bit rate margin, units of %
67	1	BR, min	Lower bit rate margin, units of %
68-83	16	Vendor SN	Serial number (ASCII)
84-91	8	Date code	Manufacturing date code
92	1	Diagnostic Type	Diagnostics
93	1	Enhanced Options	Diagnostics
94	1	SFF-8472	Diagnostics
95	1	CCEX	Check code for the extended ID Fields (addresses 64 to 94)
Vendor Specific ID Fields			
96-127	32	Readable	Vendor specific data, readonly

VIII. Diagnostics Memory Contents(A2h)

Data Address	Length (Byte)	Name of Length	Description and Contents
Diagnostic and control/status fields			
0-39	40	A/W Thresholds	Diagnostic Flag Alarm and Warning Thresholds
40-55	16	Unallocated	
56-91	16	Ext Cal Constants	Diagnostic calibration constants for optional External Calibration
92-94	3	Unallocated	
95	1	CC_DMI	Check code for Base Diagnostic Fields (addresses 0 to 94)
96-105	10	Diagnostics	Diagnostic Monitor Data (internally orexternally calibrated)
106-109	4	Unallocated	
110	1	Status/Control	Optional Status and Control Bits
111	1	Reserved	Reserved for SFF-8079
112-113	2	Alarm Flags	Diagnostic Alarm Flag Status Bits
114-115	2	Unallocated	
116-117	2	Warning Flags	Diagnostic Warning Flag Status Bits
118-119	2	ExtStatus/Control	Extended module control and status bytes
General Use Fields			
120-127	8	Vendor Specific	Vendor specific memory addresses

Data Address	Length (Byte)	Name of Length	Description and Contents
128-247	120	User EEPROM	User writable non-volatile memory
248-255	8	Vendor Control	Vendor specific control addresses

IX. Mechanical Dimensions

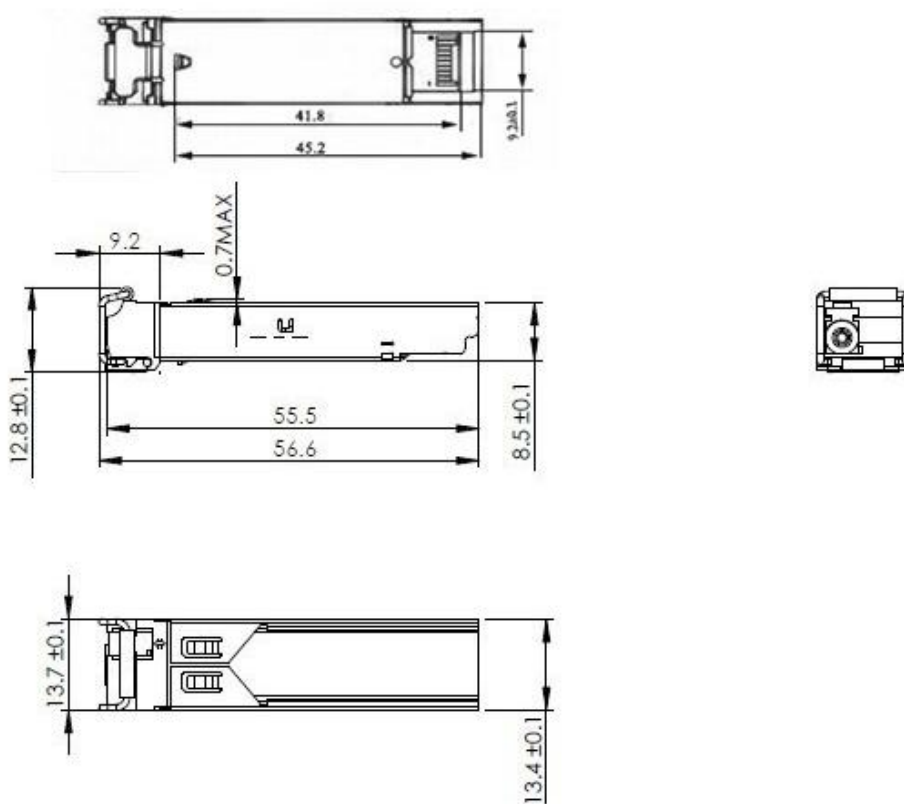

Figure 3. Mechanical Drawing

Test Center

I. Compatibility Testing

Each fiber optical transceiver has been tested in host device on site in FS Assured Program to ensure full compatibility with over 200 vendors.



Cisco Catalyst C9500-24Y4C



Cisco MS425-16



Brocade VDX 6940-144S



Dell EMC Networking Z9100-ON



Force¹⁰ S60-44T



HUAWEI S6720-30L-HI-24S

Above is part of our test bed network equipment. For more information, please click the [Test Bed PDF](#). It will be updated in real time as we expand our portfolio.

II. Performance Testing

Each fiber optical transceiver has been fully tested in FS Assured Program equipped with world's most advanced analytical equipment to ensure that our transceivers work perfectly on your device.

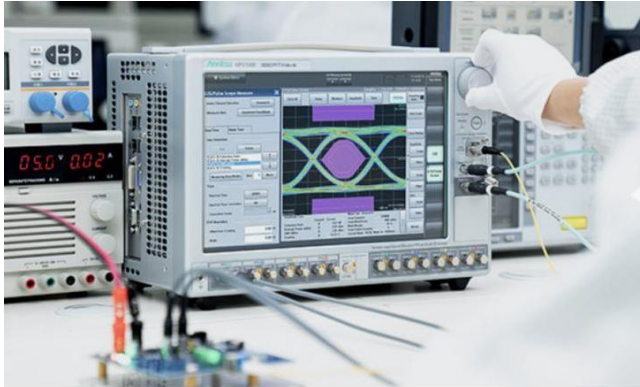

1. TX/RX Signal Quality Testing

Equipped with the all-in-one tester integrated 4ch BERT & sampling oscilloscope, and variable optical attenuator to ensure the input and output signal quality.

- Eye Pattern Measurements: jitter, Mask Margin, etc
- Average Output Power
- OMA
- Extinction Ratio
- Receiver Sensitivity
- BER Curve

2. Reliability and Stability Testing

Subject the transceivers to dramatic changes in temperature on the thermal shock chamber to ensure reliability and stability of the transceivers.

- Commercial: 0 °C to 70 °C
- Extended: -5 °C to 85 °C
- Industrial: -40 °C to 85 °C



3. Transfer Rate and Protocol Testing

Test the actual transfer data rate and the transmission ability under different protocols with Network Master Pro.

- Ethernet
- Fibre Channel
- SDH/SONET
- CPRI



4. Optical Spectrum Evaluation

Evaluate various important parameters with the Optical Spectrum Analyzer to meet the industry standards.

- Center Wavelength, Level
- OSNR
- SMSR
- Spectrum Width

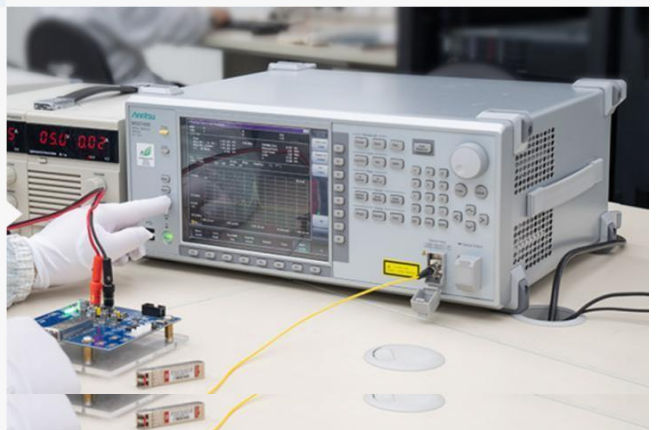

Ordering Information

Part Number	Description
SFP-FB-GE-T	100BASE-T SFP SGMII Copper RJ-45 100m DOM Transceiver Module
SFP-GE-100FX	100BASE-FX SFP SGMII 1310nm 2km DOM LC MMF Transceiver Module
SFP-100LX-31	100BASE-LX SFP 1310nm 15km DOM LC SMF Transceiver Module
SFP-100EX-31	100BASE-EX SFP 1310nm 40km DOM LC SMF Transceiver Module
SFP-100ZX-55	100BASE-ZX SFP 1550nm 80km DOM LC SMF Transceiver Module
SFP-100FX-31	100BASE-FX SFP 1310nm 2km Industrial DOM LC MMF Transceiver Module
SFP-100LX-31	100BASE-LX SFP 1310nm 10km Industrial DOM LC SMF Transceiver Module
SFP-FE-BX	100BASE-BX BiDi SFP 1310nm-TX/1550nm-RX 10km DOM LC SMF Transceiver Module
SFP-FE-BX	100BASE-BX BiDi SFP 1550nm-TX/1310nm-RX 10km DOM LC SMF Transceiver Module
SFP-FE-BX	100BASE-BX BiDi SFP 1310nm-TX/1550nm-RX 20km DOM LC SMF Transceiver Module
SFP-FE-BX	100BASE-BX BiDi SFP 1550nm-TX/1310nm-RX 20km DOM LC SMF Transceiver Module



 <https://www.fs.com>



The information in this document is subject to change without notice. FS has made all efforts to ensure the accuracy of the information, but all information in this document does not constitute any kind of warranty.